

FCC Part 15B TEST REPORT

Report No: 1706273E01

Issued for

General Procurement, INC.

800 E Dyer Road Santa Ana, Ca 92705 Santa Ana California
United States

Product Name:	5inch LTE Smartphone
Brand Name:	HYUNDAI, VULCAN
Model Name:	A25024L
Series Model:	VR5014, T36
FCC ID:	S94A25024L
Test Standard:	FCC Part 15B

Any reproduction of this document must be done in full. No single part of this document may be reproduced without permission from BZT, All Test Data Presented in this report is only applicable to presented Test sample.

BZT Testing Technology Co., Ltd

Add. : Buliding 17, Xinghua Road Xingwei industrial Park Fuyong,
Baoan District, Shenzhen, Guangdong, China

TEL: +86-755 3307 1680 FAX: +86-755 27341758 E-mail:bruce@bzt.Cn

TEST RESULT CERTIFICATION

Applicant's name..... : General Procurement, INC.
Address..... : 800 E Dyer Road Santa Ana, Ca 92705 Santa Ana California United States
Manufacture's Name..... : Sintave
Address..... : 6th F, 3rd building, Sangtai Technology Park, Xili Nanshan Shenzhen China

Product description

Product name..... : 5inch LTE Smartphone
Brand name..... : HYUNDAI, VULCAN
Model and/or type reference.. : A25024L

Standards..... : FCC Part 15B

Test procedure..... ANSI C63.4-2014

This device described above has been tested by BZT, and the test results show that the equipment under test (EUT) is in compliance with the FCC requirements. And it is applicable only to the tested sample identified in the report.

This report shall not be reproduced except in full, without the written approval of BZT, this document may be altered or revised by BZT, personal only, and shall be noted in the revision of the document.

Date of Test

Date of performance of tests 27 June 2017~03 July. 2017

Date of Issue 04 July. 2017

Test Result **Pass**

Testing Engineer :



(Kyle Rao)

Technical Manager :



(Chopin Xiao)

Authorized Signatory :



(Vita Li)

TABLE OF CONTENTS

1. SUMMARY OF TEST RESULTS	5
1.1 TEST FACTORY	5
1.2 MEASUREMENT UNCERTAINTY	5
2. GENERAL INFORMATION	6
2.1 GENERAL DESCRIPTION OF EUT	6
2.2 DESCRIPTION OF TEST MODES	7
2.3 BLOCK DIGRAM SHOWING THE CONFIGURATION OF SYSTEM TESTED	7
2.4 DESCRIPTION OF SUPPORT UNITS	8
2.5 EQUIPMENTS LIST FOR ALL TEST ITEMS	9
3. EMC EMISSION TEST	10
3.1 CONDUCTED EMISSION MEASUREMENT	10
3.2 RADIATED EMISSION MEASUREMENT	14
4. PHOTOS OF TEST SETUP	20

Revision History

Rev.	Issue Date	Report NO.	Effect Page	Contents
00	04 July. 2017	1706273E01	ALL	Initial Issue

1. SUMMARY OF TEST RESULTS

Test procedures according to the technical standards:

EMISSION			
Standard	Item	Result	Remarks
FCC 47 CFR Part 15 Subpart B (10-1-05 Edition)	Conducted Emission	PASS	Meet Class B limit
	Radiated Emission	PASS	Meet Class B limit

NOTE:

(1) "N/A" denotes test is not applicable in this Test Report

1.1 TEST FACTORY

BZT Testing Technology Co., Ltd.

Add. : Buliding 17, Xinghua Road Xingwei industrial Park Fuyong,
Baoan District, Shenzhen, Guangdong, China

FCC Registration No.: 701733

1.2 MEASUREMENT UNCERTAINTY

The reported uncertainty of measurement $y \pm U$, where expended uncertainty U is based on a standard uncertainty multiplied by a coverage factor of $k=2$, providing a level of confidence of approximately 95 %.

No.	Item	Uncertainty
1	Conducted Emission (9KHz-150KHz)	$\pm 2.88\text{dB}$
2	Conducted Emission (150KHz-30MHz)	$\pm 2.67\text{dB}$
3	All emissions,radiated(<1G) 30MHz-200MHz	$\pm 3.80\text{dB}$
4	All emissions,radiated(<1G) 200MHz-1000MHz	$\pm 3.97\text{dB}$
5	All emissions,radiated(>1G)	$\pm 3.03\text{dB}$

2. GENERAL INFORMATION

2.1 GENERAL DESCRIPTION OF EUT

Equipment	5inch LTE Smartphone
Trade Name	HYUNDAI, VULCAN
Model Name	A25024L
Series Model	VR5014, T36
Model Difference	Only different in model name and brand name.
Adapter	Input: 100-240V 50/60Hz 0.4A Output: DC 5V, 1A
Battery	Rated Voltage: 3.8V Capacity: 2100mAh Charge Limit: 4.2V
Hardware version number	T856-FE-V1.1
Software version number	HYUNDAI_ A25024L_ V01

Note: For a more detailed features description, please refer to the manufacturer's specifications or the User's Manual.

2.2 DESCRIPTION OF TEST MODES

To investigate the maximum EMI emission characteristics generates from EUT, the test system was pre-scanning tested base on the consideration of following EUT operation mode or test configuration mode which possible have effect on EMI emission level. Each of these EUT operation mode(s) or test configuration mode(s) mentioned above was evaluated respectively.

Pretest Mode	Description
Mode 1	USB port communication with PC

For Conducted Test	
Final Test Mode	Description
Mode 1	USB port communication with PC

For Radiated Test	
Final Test Mode	Description
Mode 1	USB port communication with PC

NOTE:

1. Due to the different configuration and test, in this list only some worse mode. The worst test data of the worse modeis reported by this report.
2. We have be tested for all avaiable U.S. voltage and frequencies(For 120V, 50/60Hz) for which the device is capable of operation.

2.3 BLOCK DIGRAM SHOWING THE CONFIGURATION OF SYSTEM TESTED

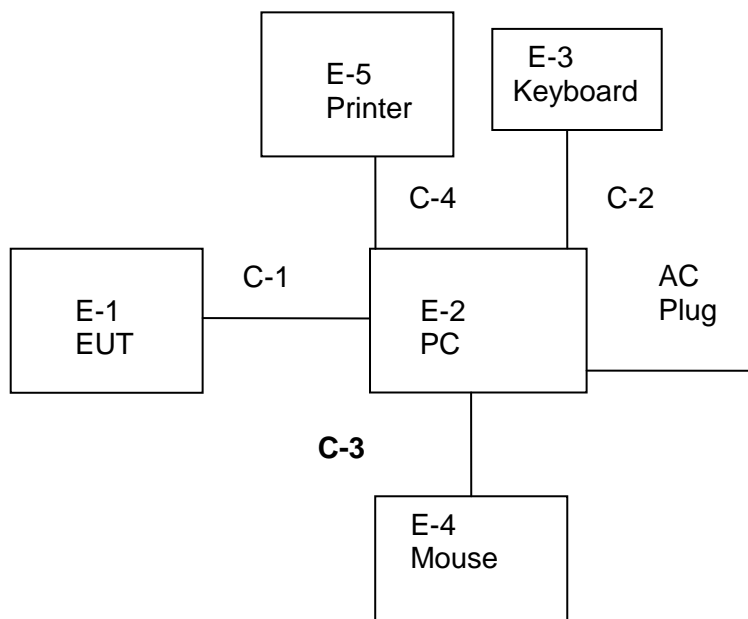

2.4 DESCRIPTION OF SUPPORT UNITS

The EUT has been tested as an independent unit together with other necessary accessories or support units. The following support units or accessories were used to form a representative test configuration during the tests.

Item	Equipment	Mfr/Brand	Model/Type No.	Note
E-1	5inch LTE Smartphone	HYUNDAI, VULCAN	A25024L	EUT
E-2	PC	HP	500-320cx	N/A
E-3	Keyboard	Acer	SK-9624	N/A
E-4	Mouse	HP	MODGUO	N/A
E-5	Printer	LENOVO	LJ2400L	N/A

Item	Shielded Type	Ferrite Core	Length	Note
C-1	USB Cable (FTP)	NO	90cm	N/A
C-2	Shielded	NO	100cm	N/A
C-3	Shielded	NO	105cm	N/A
C-4	Shielded	NO	110cm	N/A

Note:

- (1) The support equipment was authorized by Declaration of Confirmation.
- (2) For detachable type I/O cable should be specified the length in cm in 『Length』 column.
- (3) “YES” is means “shielded” “with core”; “NO” is means “unshielded” “without core”.
- (4) PC is the FCC DOC is approved.

2.5 EQUIPMENTS LIST FOR ALL TEST ITEMS

The EUT has been tested as an independent unit together with other necessary accessories or support units. The following support units or accessories were used to form a representative test configuration during the tests.

Radiation Test equipment

Kind of Equipment	Manufacturer	Type No.	Serial No.	Last Calibration	Calibrated Until
EMI Test Receiver	R&S	ESCI	101427	2016.10.23	2017.10.22
Bilog Antenna	TESEQ	CBL6111D	34678	2017.03.24	2018.03.23
Horn Antenna	SCHWARZBECK	BBHA 9120D(1201)	9120D-1343	2017.03.06	2018.03.05
Power Amplifier	Agilent	8449B	60538	2016.10.23	2017.10.22
Spectrum Analyzer	Agilent	E4407B	MY50140340	2016.10.25	2017.10.24
Pre-mpplier(0.1M-3GHz)	EM	EM330	60538	2017.03.12	2018.03.11
Spectrum Analyzer	Agilent	N9020A	MY49100060	2017.03.11	2018.03.10
EMI Test Receiver	ESW	R&S	101535	2017.06.01	2018.05.31

Conduction Test equipment

Kind of Equipment	Manufacturer	Type No.	Serial No.	Last Calibration	Calibrated Until
EMI Test Receiver	R&S	ESPI	102086	2016.10.23	2017.10.22
LISN	R&S	ENV216	101242	2016.10.26	2017.10.25
LISN	EMCO	3810/2NM	000-23625	2016.10.26	2017.10.25
Absorbing clamp	R&S	MDS-21	100668	2016.10.23	2017.10.22

3. EMC EMISSION TEST

3.1 CONDUCTED EMISSION MEASUREMENT

3.1.1 POWER LINE CONDUCTED EMISSION Limits

FREQUENCY (MHz)	Conducted Emission Limits (dBuV)			
	Class A		Class B	
	Quasi-peak	Average	Quasi-peak	Average
0.15 -0.5	79.00	66.00	66 - 56 *	56 - 46 *
0.50 -5.0	73.00	60.00	56.00	46.00
5.0 -30.0	73.00	60.00	60.00	50.00

Note:

- (1) The tighter limit applies at the band edges.
- (2) The limit of " * " marked band means the limitation decreases linearly with the logarithm of the frequency in the range.

The following table is the setting of the receiver

Receiver Parameters	Setting
Attenuation	10 dB
Start Frequency	0.15 MHz
Stop Frequency	30 MHz
IF Bandwidth	9 kHz

3.1.2 TEST PROCEDURE

- The EUT was 0.8 meters from the horizontal ground plane and 0.4 meters from the vertical ground plane with EUT being connected to the power mains through a line impedance stabilization network (LISN). All other support equipments powered from additional LISN(s). The LISN provide 50 Ohm/ 50uH of coupling impedance for the measuring instrument.
- Interconnecting cables that hang closer than 40 cm to the ground plane shall be folded back and forth in the center forming a bundle 30 to 40 cm long.
 - I/O cables that are not connected to a peripheral shall be bundled in the center. The end of the cable may be terminated, if required, using the correct terminating impedance. The overall length shall not exceed 1 m.
 - LISN at least 80 cm from nearest part of EUT chassis.
 - For the actual test configuration, please refer to the related Item –EUT Test Photos.

3.1.3 DEVIATION FROM TEST STANDARD

No deviation

3.1.4 TEST SETUP

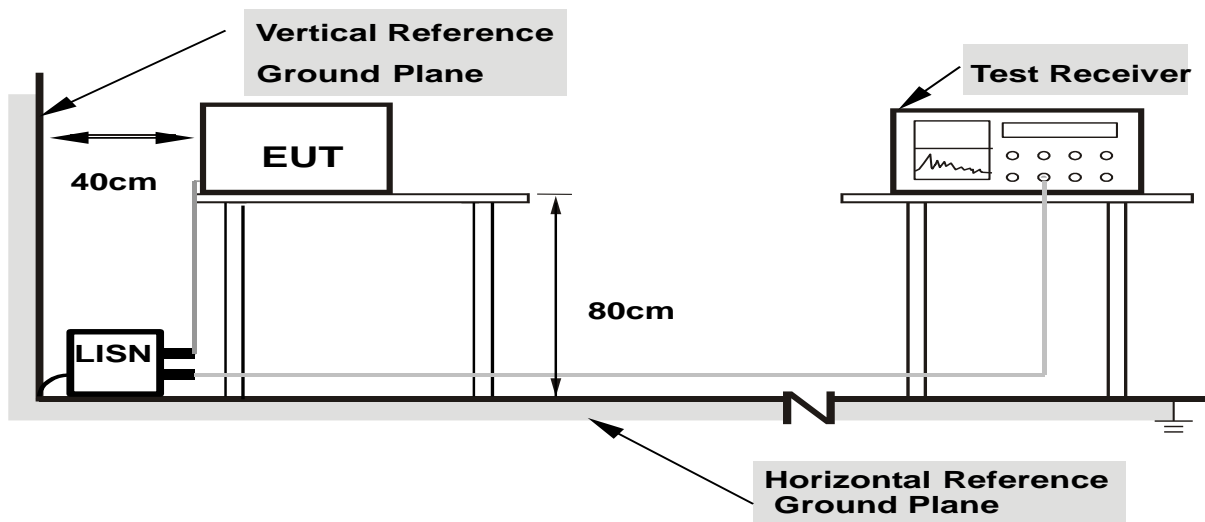

- Note: 1. Support units were connected to second LISN.**
2. Both of LISNs (AMN) are 80 cm from EUT and at least 80 cm from other units and other metal planes

3.1.5 EUT OPERATING CONDITIONS

The EUT was configured for testing in a typical fashion (as a customer would normally use it). The EUT has been programmed to continuously transmit during test. This operating condition was tested and used to collect the included data.

3.1.6 TEST RESULTS

Temperature:	25.4°C	Relative Humidity:	61%
Pressure:	1010hPa	Phase:	L
Test Voltage:	AC 120V/60Hz	Test Mode:	Mode 1

No.	Frequency (MHz)	Reading (dBuV)	Factor (dB)	Result (dBuV)	Limit (dBuV)	Margin (dB)	Detector
1	0.1500	46.14	9.79	55.93	66.00	-10.07	QP
2	0.1500	29.49	9.79	39.28	56.00	-16.72	AVG
3	0.5100	24.12	10.02	34.14	56.00	-21.86	QP
4	0.5100	11.19	10.02	21.21	46.00	-24.79	AVG
5	1.8660	33.34	9.78	43.12	56.00	-12.88	QP
6	1.8660	11.21	9.78	20.99	46.00	-25.01	AVG
7	3.5420	28.99	9.82	38.81	56.00	-17.19	QP
8	3.5420	13.25	9.82	23.07	46.00	-22.93	AVG
9	6.3300	27.37	9.87	37.24	60.00	-22.76	QP
10	6.3300	11.66	9.87	21.53	50.00	-28.47	AVG
11	9.4820	29.70	10.16	39.86	60.00	-20.14	QP
12	9.4820	19.34	10.16	29.50	50.00	-20.50	AVG

Remark:

- All readings are Quasi-Peak and Average values.
- Margin = Result (Result = Reading + Factor) – Limit

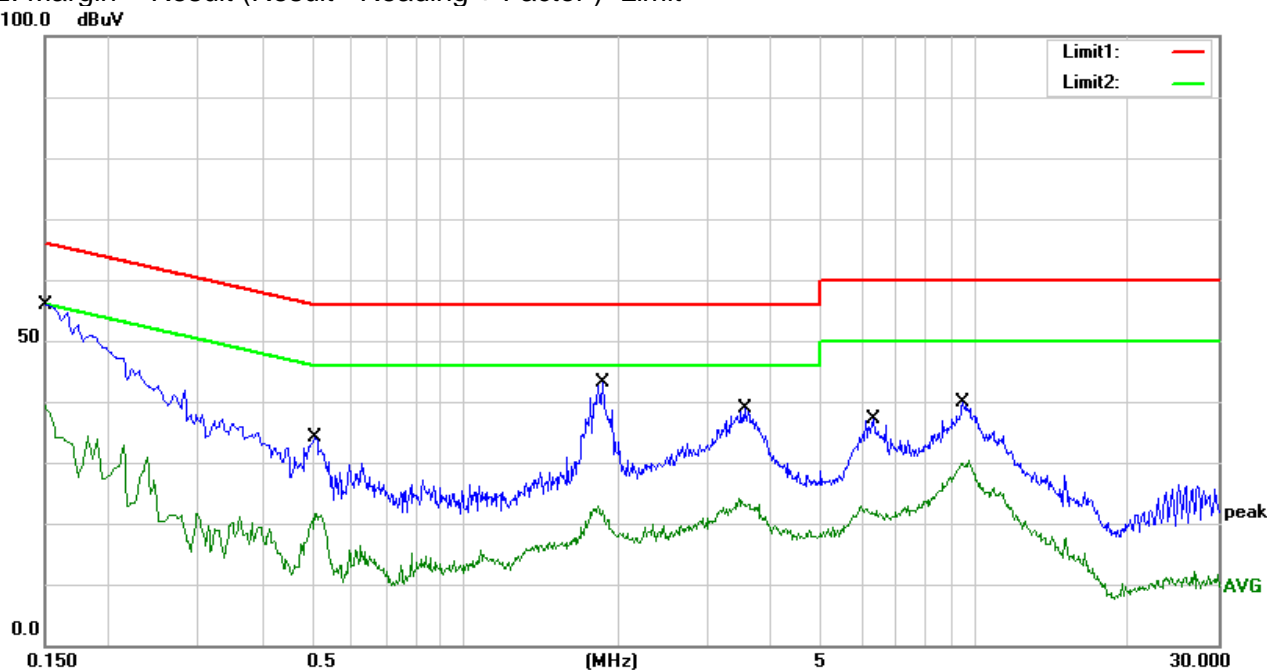

Temperature:	25.4°C	Relative Humidity:	61%
Pressure:	1010hPa	Phase:	N
Test Voltage:	AC 120V/60Hz	Test Mode:	Mode 1

No.	Frequency (MHz)	Reading (dBuV)	Factor (dB)	Result (dBuV)	Limit (dBuV)	Margin (dB)	Detector
1	0.1500	46.32	9.79	56.11	66.00	-9.89	QP
2	0.1500	28.27	9.79	38.06	56.00	-17.94	AVG
3	0.1820	41.50	9.78	51.28	64.39	-13.11	QP
4	0.1820	23.78	9.78	33.56	54.39	-20.83	AVG
5	0.5180	23.87	10.01	33.88	56.00	-22.12	QP
6	0.5180	12.50	10.01	22.51	46.00	-23.49	AVG
7	1.8420	30.72	9.78	40.50	56.00	-15.50	QP
8	1.8420	11.21	9.78	20.99	46.00	-25.01	AVG
9	3.5500	28.88	9.82	38.70	56.00	-17.30	QP
10	3.5500	13.00	9.82	22.82	46.00	-23.18	AVG
11	9.6380	28.78	10.17	38.95	60.00	-21.05	QP
12	9.6380	18.89	10.17	29.06	50.00	-20.94	AVG

Remark:

1. All readings are Quasi-Peak and Average values.
2. Margin = Result (Result = Reading + Factor) - Limit

100.0 dBuV

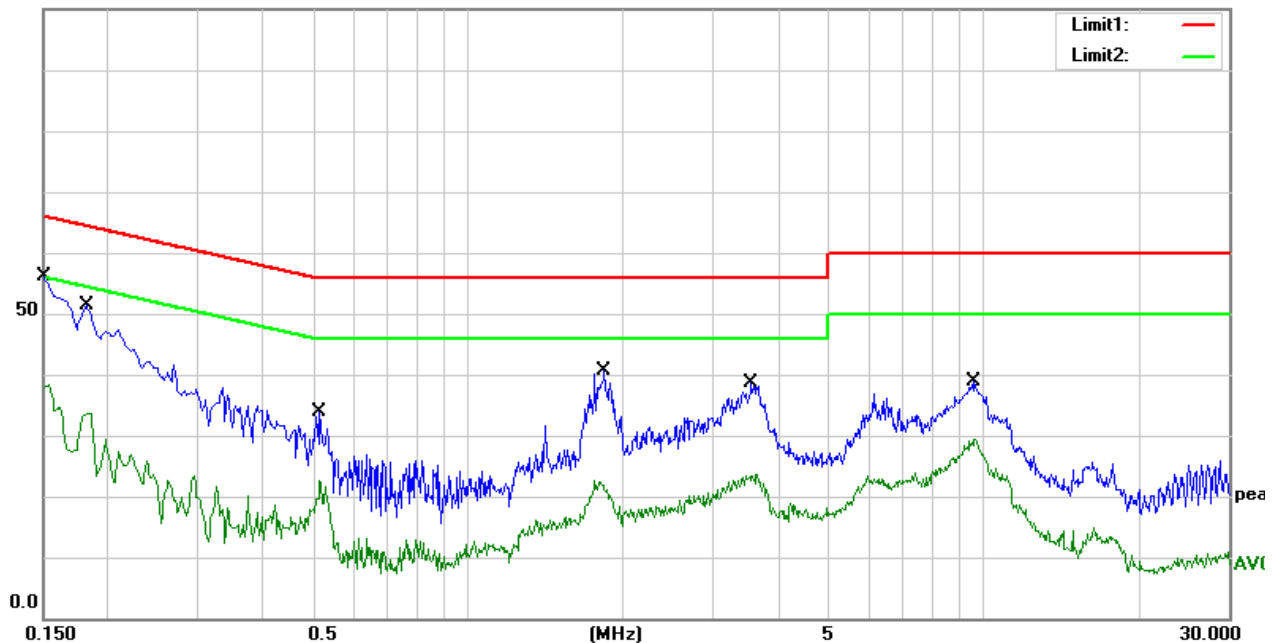

3.2 RADIATED EMISSION MEASUREMENT

3.2.1 Radiated Emission Limits

In case the emission fall within the restricted band specified on 15.105(a)&109(a) limit in the table below has to be followed.

Frequencies (MHz)	Field Strength (micorvolts/meter)	Measurement Distance (meters)
30~88	100	3
88~216	150	3
216~960	200	3
Above 960	500	3

LIMITS OF RADIATED EMISSION MEASUREMENT

FREQUENCY (MHz)	Class A (dBuV/m) (at 3M)		Class B (dBuV/m) (at 3M)	
	PEAK	AVERAGE	PEAK	AVERAGE
Above 1000	80	60	74	54

Note:

- (1) The limit for radiated test was performed according to FCC PART 15B.
- (2) The tighter limit applies at the band edges.
- (3) Emission level (dBuV/m)=20log Emission level (uV/m).

FREQUENCY RANGE OF RADIATED MEASUREMENT (For unintentional radiators)

Highest frequency generated or Upper frequency of measurement used in the device or on which the device operates or tunes (MHz)	Range (MHz)
Below 1.705	30
1.705 – 108	1000
108 – 500	2000
500 – 1000	5000
Above 1000	5th harmonic of the highest frequency or 40 GHz, whichever is lower

Spectrum Parameter	Setting
Attenuation	Auto
Detector	Peak
Start Frequency	1000 MHz(Peak/AV)
Stop Frequency	5th harmonic (Peak/AV)
RB / VB (emission in restricted band)	30MHz to 1000MHz: 100 KHz / 300 KHz Above 1000MHz: 1 MHz / 3 MHz

Receiver Parameter	Setting
Attenuation	Auto
Start ~ Stop Frequency	30MHz to 1000MHz: 100 KHz / 300 KHz Above 1000MHz: 1 MHz / 3 MHz

3.2.2 TEST PROCEDURE

- a. The measuring distance of at 3 m shall be used for measurements at frequency up to 1GHz and above 1GHz.

The EUT was placed on the top of a rotating table 0.8 meters above the ground at a 3 meter anechoic chamber. The table was rotated 360 degrees to determine the position of the highest radiation.

- c. the height of the antenna shall vary between 1m to 4 m. Both horizontal and vertical polarizations of the antenna are set to make the measurement.

The initial step in collecting conducted emission data is a spectrum analyzer peak detector mode pre-scanning the measurement frequency range. Significant peaks are then marked and then Quasi Peak detector mode re-measured.

If the Peak Mode measured value compliance with and lower than Quasi Peak Mode Limit, the EUT shall be deemed to meet QP Limits and then no additional QP Mode measurement performed.

- f. For the actual test configuration, please refer to the related Item –EUT Test Photos.

Note: Both horizontal and vertical antenna polarities were tested and performed pretest to three orthogonal axis. The worst case emissions were reported

3.2.3 DEVIATION FROM TEST STANDARD

No deviation

3.2.4 TEST SETUP

(A) Radiated Emission Test-Up Frequency 30MHz~1GHz

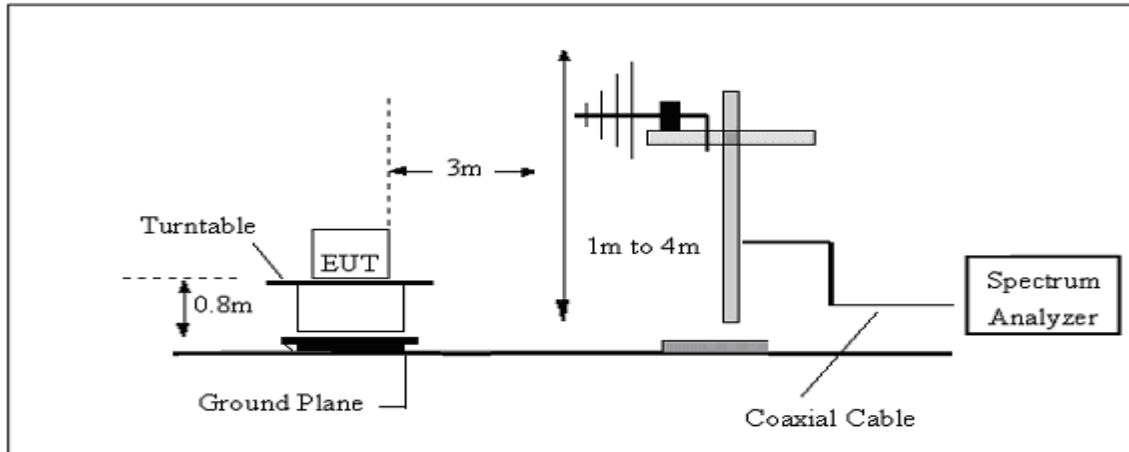

(B) Radiated Emission Test-Up Frequency Above 1GHz

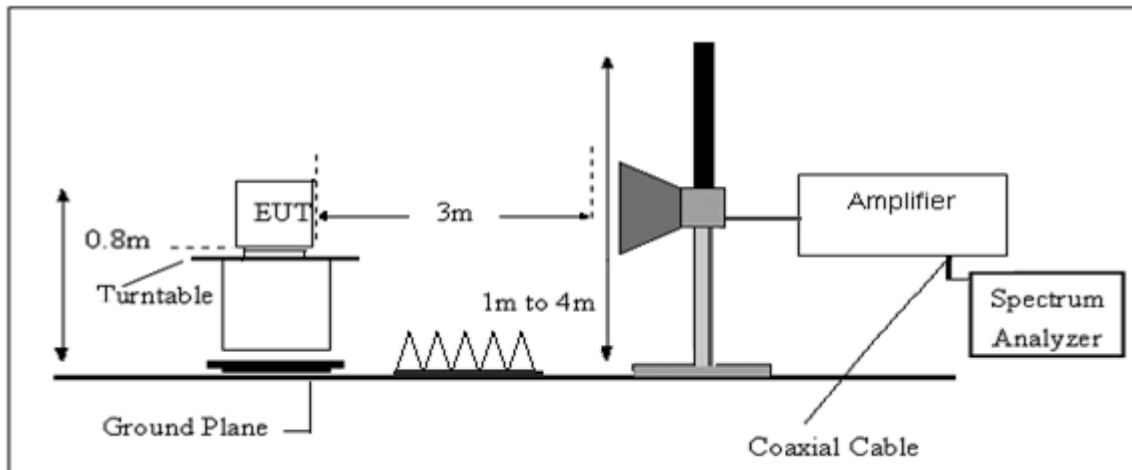

3.2.5 EUT OPERATING CONDITIONS

The EUT tested system was configured as the statements of 2.4 Unless otherwise a special operating condition is specified in the follows during the testing.

3.2.6 TEST RESULTS

30MHz -1000MHz

Temperature:	26 °C	Relative Humidity:	60%
Pressure:	1010hPa	Phase:	Horizontal
Test Voltage:	AC 120V/60Hz	Test Mode:	Mode 1

No.	Frequency (MHz)	Reading (dBuV)	Factor (dB)	Results (dBuV/m)	Limit (dBuV/m)	Margin (dB)	Detector
1	73.3593	59.62	-23.62	36.00	40.00	-4.00	QP
2	182.1792	55.06	-19.62	35.44	43.50	-8.06	QP
3	234.1684	54.41	-18.18	36.23	46.00	-9.77	QP
4	399.0302	53.53	-11.28	42.25	46.00	-3.75	QP
5	446.4141	48.98	-10.64	38.34	46.00	-7.66	QP
6	597.2234	46.26	-7.10	39.16	46.00	-6.84	QP

Remark:

1. Margin = Result (Result =Reading + Factor)–Limit

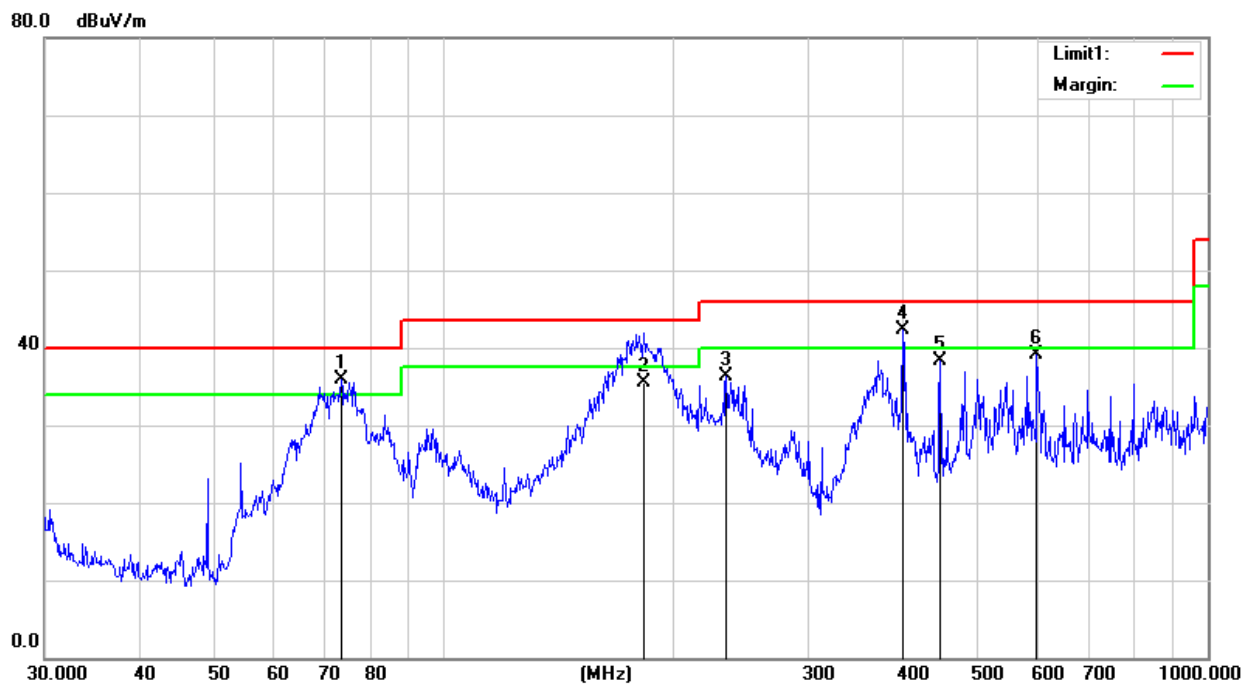

Temperature:	26 °C	Relative Humidity:	60%
Pressure:	1010hPa	Phase:	Vertical
Test Voltage:	AC 120V/60Hz	Test Mode:	Mode 1

No.	Frequency (MHz)	Reading (dBuV)	Factor (dB)	Results (dBuV/m)	Limit (dBuV/m)	Margin (dB)	Detector
1	47.3255	43.21	-20.10	23.11	40.00	-16.89	QP
2	71.8320	46.13	-23.84	22.29	40.00	-17.71	QP
3	199.9856	49.14	-20.17	28.97	43.50	-14.53	QP
4	216.0240	48.25	-19.37	28.88	46.00	-17.12	QP
5	399.0302	43.69	-11.28	32.41	46.00	-13.59	QP
6	552.8832	47.65	-6.71	40.94	46.00	-5.06	QP

Remark:

1. Margin = Result (Result =Reading + Factor)–Limit

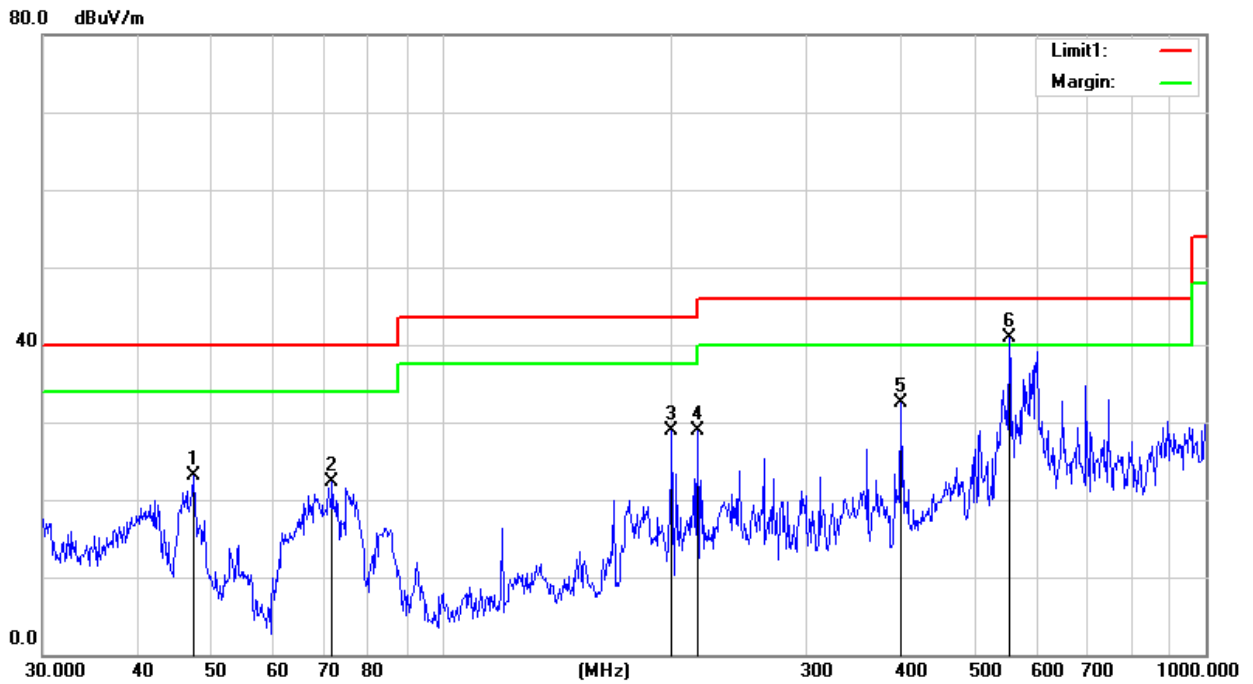

(1 GHz to 25GHz.)

Temperature:	26 °C	Relative Humidity:	54%
Pressure:	1010hPa	Phase:	Vertical/Horizontal
Test Voltage:	AC 120V/60Hz	Test Mode:	Mode 1

PK

Freq.	Ant. Pol	Peak	Amplifier	Loss	Antenna Factor	Orrected Factor	Actual Fs	Peak	Peak
(MHz)	H/V	Reading (dBuV)	(dB)	(dB)	(dB/m)	(dB)	Peak (dBuV/m)	Limit (dBuV/m)	margin (dB)
1403.35	H	65.78	45.1	4.0	25.1	-16.0	51.78	74.00	-22.22
3000.76	H	54.54	44.7	6.7	28.2	-9.8	46.74	74.00	-27.26
4002.47	H	63.34	44.2	7.9	29.7	-6.6	55.74	74.00	-18.26
5506.84	H	50.13	44.2	9.7	32.0	-2.5	49.63	74.00	-24.37
N/A									
1403.35	V	52.96	45.1	4.0	25.1	-16.0	37.96	74.00	-36.04
3000.76	V	53.15	44.7	6.7	28.2	-9.8	44.35	74.00	-29.65
4002.47	V	64.83	44.2	7.9	29.7	-6.6	57.23	74.00	-16.77
5506.84	V	58.67	44.2	9.7	32.0	-2.5	55.17	74.00	-18.83
N/A									

AV

Freq.	Ant. Pol	AV	Amplifier	Loss	Antenna Factor	Orrected Factor	AV	AV	AV
(MHz)	H/V	Reading (dBuV)	(dB)	(dB)	(dB/m)	(dB)	AV (dBuV/m)	Limit (dBuV/m)	margin (dB)
1403.35	H	47.61	45.1	4.0	25.1	-16.0	33.61	54.00	-20.39
3000.76	H	45.18	44.7	6.7	28.2	-9.8	36.38	54.00	-17.62
4002.47	H	51.03	44.2	7.9	29.7	-6.6	45.43	54.00	-8.57
5506.84	H	52.11	44.2	9.7	32.0	-2.5	47.61	54.00	-6.39
N/A									
1403.35	V	38.69	45.1	4.0	25.1	-16.0	21.69	54.00	-32.31
3000.76	V	42.59	44.7	6.7	28.2	-9.8	31.79	54.00	-22.21
4002.47	V	34.57	44.2	7.9	29.7	-6.6	26.97	54.00	-27.03
5506.84	V	31.26	44.2	9.7	32.0	-2.5	27.76	54.00	-26.24
N/A									

Notes:

1. Measuring frequencies from 1 GHz to 25GHz.
2. Radiated emissions measured in frequency above 1000MHz were made with an instrument using Peak detector mode of the emission shown in Actual FS column.
3. The frequency that above 5.5GHz is mainly from the environment noise.

4. PHOTOS OF TEST SETUP

Radiated Measurement Photos

30MHz- 1GHz



Above 1GHz



Conducted Measurement Photos



*****END OF THE REPORT*****