

RADIO TEST REPORT

Report No:1706273W01

Issued for

General Procurement, INC.

800 E Dyer Road Santa Ana, Ca 92705 Santa Ana California
United States

Product Name:	5inch LTE Smartphone
Brand Name:	HYUNDAI,VULCAN
Model Name:	A25024L
Series Model:	VR5014, T36
FCC ID:	S94A25024L
Test Standard:	FCC Part 22H and 24E

Any reproduction of this document must be done in full. No single part of this document may be reproduced without permission from BZT, All Test Data Presented in this report is only applicable to presented Test sample.

BZT Testing Technology Co., Ltd

Add. : Buliding 17, Xinghua Road Xingwei industrial Park Fuyong,
Baoan District, Shenzhen, Guangdong, China

TEL: +86-755 3307 1680 FAX: +86-755 27341758 E-mail:bruce@bzt.Cn

TEST RESULT CERTIFICATION

Applicant's name: General Procurement, INC.
Address: 800 E Dyer Road Santa Ana, Ca 92705 Santa Ana California United States
Manufacture's Name: Sintave
Address: 6th F, 3rd building, Sangtai Technology Park, Xili Nanshan Shenzhen China
Product name: 5inch LTE Smartphone
Brand name: HYUNDAI,VULCAN
Model and/or type reference ..: A25024L
Standards: FCC Part 22H and 24E
Test procedure ANSI/TIA 603-D (2010)

This device described above has been tested by BZT and the test results show that the equipment under test (EUT) is in compliance with the FCC requirements. And it is applicable only to the tested sample identified in the report.

This report shall not be reproduced except in full, without the written approval of BZT, this document may be altered or revised by BZT, personal only, and shall be noted in the revision of the document

Date of Test

Date of performance of tests 01 July. 2017~04 July. 2017

Date of Issue 06 July. 2017

Test Result..... **Pass**

Testing Engineer :



(Sean she)

Technical Manager :



(Hakim.hou)

Authorized Signatory :



(Vita Li)

TABLE OF CONTENTS	Page
1 INTRODUCTION	6
1.1 TEST FACTORY	6
1.2 MEASUREMENT UNCERTAINTY	6
2 PRODUCT INFORMATION	7
3 TEST CONFIGURATION OF EQUIPMENT UNDER TEST	8
4 MEASUREMENT INSTRUMENTS	9
5 TEST ITEMS	10
5.1 CONDUCTED OUTPUT POWER	10
5.2 PEAK TO AVERAGE RATIO	11
5.3 TRANSMITTER RADIATED POWER (EIRP/ERP)	12
5.4 OCCUPIED BANDWIDTH	13
5.5 FREQUENCY STABILITY	14
5.6 SPURIOUS EMISSIONS AT ANTENNA TERMINALS	15
5.7 BAND EDGE	16
5.8 FIELD STRENGTH OF SPURIOUS RADIATION MEASUREMENT	17
APPENDIX A TEST RESULT	19
A1 CONDUCTED OUTPUT POWER	19
A2 PEAK-TO-AVERAGE RATIO	23
A3 TRANSMITTER RADIATED POWER (EIRP/ERP)	25
A4 OCCUPIED BANDWIDTH(99% OCCUPIED BANDWIDTH/26DB BANDWIDTH)	27
A5 FREQUENCY STABILITY	35
A6 SPURIOUS EMISSIONS AT ANTENNA TERMINALS	38
A7 BAND EDGE	44
A8 FIELD STRENGTH OF SPURIOUS RADIATION MEASUREMENT	50
APPENDIX B PHOTOS OF TEST SETUP	56

Revision History

Rev.	Issue Date	Report NO.	Effect Page	Contents
00	06 July. 2017	1706273W01	ALL	Initial Issue

SUMMARY OF TEST RESULTS

Test procedures according to the technical standards:

The radiated emission testing was performed according to the procedures of ANSI/TIA-603-D: 2010, KDB 971168 D01 v02r02 and KDB 648474 D03 v01r04

FCC Rules	Test Description	Test Limit	Test Result	Reference
2.1049	Conducted OutputPower	Reporting Only	PASS	
2.0146 24.232	Peak-to-AverageRatio	< 13 dB	PASS	
2.1046 22.913 24.232	Effective Radiated Power/Equivalent Isotropic Radiated Power	< 7 Watts max. ERP(Part 22) < 2 Watts max. EIRP(Part 24)	PASS	
2.1049 22.917 24.238	Occupied Bandwidth	Reporting Only	PASS	
2.1055 22.355 24.235	Frequency Stability	< 2.5 ppm (Part 22) Emission must remain in band (Part 24)	PASS	
2.1051 22.917 24.238	Spurious Emission at Antenna Terminals	< 43+10log ₁₀ (P[Watts])	PASS	
2.1053 22.917 24.238	Field Strength of Spurious Radiation	< 43+10log ₁₀ (P[Watts])	PASS	
2.1051 22.917 24.238	Band Edge	< 43+10log ₁₀ (P[Watts])	PASS	

1 INTRODUCTION

1.1 TEST FACTORY

BZT Testing Technology Co., Ltd.

Add. : Buliding 17, Xinghua Road Xingwei industrial Park Fuyong,
Baoan District, Shenzhen, Guangdong, China

FCC Registration No.: 701733

1.2 MEASUREMENT UNCERTAINTY

The measurement uncertainties shown below were calculated in accordance with the requirements of ANSI C63.4-2014. All measurement uncertainty values are shown with a coverage factor of $k = 2$ to indicate a 95% level of confidence. The measurement data shown herein meets or exceeds the CISPR measurement uncertainty values specified in CISPR 16-4-2 and, thus, can be compared directly to specified limits to determine compliance. °

No.	Item	Uncertainty
1	RF power,conducted	±0.71dB
2	Spurious emissions,conducted	±0.63dB
5	All emissions,radiated(<1G) 30MHz-200MHz	±3.80dB
6	All emissions,radiated(<1G) 200MHz-1000MHz	±3.97dB
7	All emissions,radiated(>1G)	±3.03dB

2 PRODUCT INFORMATION

Product Designation:	5inch LTE Smartphone
Hardware version number:	T856-FE-V1.1
Software version number:	HYUNDAI_A25024L_V01
FCC ID:	S94A25024L
Tx Frequency:	GSM/GPRS: 850: 824.2 MHz ~ 848.8 MHz 1900: 1850.2 MHz ~ 1909.8MHz WCDMA: Band V: 826.4 MHz ~ 846.6 MHz Band II: 1852.4 MHz ~ 1907.6 MHz
Rx Frequency:	GSM/GPRS: 850: 869.2 MHz ~ 893.8 MHz 1900: 1930.2 MHz ~ 1989.8 MHz WCDMA: Band V: 871.4 MHz ~ 891.6 MHz Band II: 1932.4 MHz ~ 1987.6 MHz
Max RF Output Power:	GSM850:31.22dBm, PCS1900:30.92dBm GPRS850(1-Slot):31.19dBm, GPRS1900(1-Slot):30.90dBm GPRS850(2-Slot):30.71 dBm, GPRS1900(2-Slot):30.46dBm GPRS850(3-Slot):29.30dBm, GPRS1900(3-Slot):29.03dBm GPRS850(4-Slot):28.87dBm, GPRS1900(4-Slot):28.56dBm WCDMABand V:23.09dBm, WCDMA Band II:22.54dBm
Type of Emission:	GSM(850): 324KGXW; GSM(1900): 317KGXW GPRS(850): 326KG7W; GPRS(1900): 316KG7W WCDMA850: 5M16F9W WCDMA1900: 6M00F9W
SIM Card:	SIM 1 and SIM 2 is a chipset unit and tested as single chipset,SIM 1 is used to tested
Antenna:	PIFA Antenna
Antenna gain:	GSM 850:-0.3dBi ,PCS 1900:-0.1dBi WCDMA 850:-0.3dBi, WCDMA1900:-0.1dBi
Power Supply:	DC 3.8V by battery
Battery parameter:	Capacity: 2100mAh, Rated Voltage: 3.8V
Adapter:	Input: AC 100-240V, 50/60Hz, 0.4A Output: DC 5V, 1A
GPRS Class:	Multi-Class12
Extreme Vol. Limits:	DC3.4 V to 4.2V (Nominal DC3.8V)
Extreme Temp. Tolerance:	-10°C to +40°C
** Note: The High Voltage 4.2V and Low Voltage 3.4 V was declared by manufacturer, The EUT couldn't be operate normally with higher or lower voltage.	

3 TEST CONFIGURATION OF EQUIPMENT UNDER TEST

Antenna port conducted and radiated test items were performed according to KDB 971168 D01 Power Meas. License Digital Systems with maximum output power.

Radiated measurements were performed with rotating EUT in different three orthogonal test planes to find the maximum emission.

Radiated emissions were investigated as following frequency range:

1. 30 MHz to 10th harmonic for GSM850 and WCDMA Band V.
2. 30 MHz to 10th harmonic for GSM1900 and WCDMA Band II.

All modes and data rates and positions were investigated.

Test modes are chosen to be reported as the worst case configuration below:

	TEST MODES	
BAND	RADIATED TCS	CONDUCTED TCS
GSM 850	GSM LINK GPRS CLASS 12 LINK	GSM LINK GPRS CLASS 12 LINK
GSM 1900	GSM LINK GPRS CLASS 12 LINK	GSM LINK GPRS CLASS 12 LINK
WCDMA BAND V	RMC 12.2KBPS LINK	RMC 12.2KBPS LINK
WCDMA BAND II	RMC 12.2KBPS LINK	RMC 12.2KBPS LINK

4 MEASUREMENT INSTRUMENTS

Kind of Equipment	Manufacturer	Type No.	Serial No.	Last Calibration	Calibrated Until
EMI Test Receiver	R&S	ESW	101535	2017.06.01	2018.05.31
Signal Analyzer	Agilent	N9020A	MY49100060	2017.03.11	2018.03.10
Test Receiver	R&S	ESCI	101427	2016.10.23	2017.10.22
Universal Radio Communication Tester	R&S	CMW500	117239	2016.10.23	2017.10.22
Bilog Antenna	TESEQ	CBL6111D	34678	2017.03.24	2018.03.23
Horn Antenna	Schwarzbeck	BBHA 9120D	9120D-1343	2017.03.06	2018.03.05
SHF-EHF Horn Antenna (15G-40GHz)	BBHA 9170	SCHWARZBECK	BBHA9170367	2017.05.02	2018.05.01
Low frequency cable	EM	R01	N/A	2017.03.12	2018.03.11
Low frequency cable	EM	R06	N/A	2017.03.12	2018.03.11
High frequency cable	SCHWARZBECK	R04	N/A	2017.03.12	2018.03.11
High frequency cable	SCHWARZBECK	R02	N/A	2017.03.12	2018.03.11
Vector signal generator	Agilent	E8257D-521	MY45141029	2016.10.23	2017.10.22
Pre-mpifier (0.1M-3GHz)	EM	EM330	60538	2017.03.12	2018.03.11
PreAmplifier (1G-26.5GHz)	Agilent	8449B	60538	2016.10.23	2017.10.22
Pre-mpifier (18G-40G)	MINI-CIRCUITS	AP-040G	1382501	2017.05.15	2018.05.14
Band Reject filter(1920-1980MHz)	COM-MW	ZBSF-1920-1980	0092	2016.10.23	2017.10.22
Band Reject filter(880-915MHz)	COM-MW	ZBSF-C897.5-35	707	2016.10.23	2017.10.22
Band Reject filter(1710-1785MHz)	COM-MW	ZBSF-C1747.5-75	708	2016.10.23	2017.10.22
Band Reject filter(1850-1910MHz)	COM-MW	ZBSF-C1880-60	709	2016.10.23	2017.10.22
Band Reject filter(2500-2570MHz)	COM-MW	ZBSF-C2535-70	710	2016.10.23	2017.10.22
Highpass Filter	WHKX7.0/18G-8SS	Wainwright	18	2016.10.23	2017.10.22
trun table	EM	SC100_1	60531	N/A	N/A
Antnna mast	EM	SC100	N/A	N/A	N/A

Equipment with a calibration date of "NCR" shown in this list was not used to make direct calibrated measurements.

5 TEST ITEMS

5.1 CONDUCTED OUTPUT POWER

Test overview

A system simulator was used to establish communication with the EUT. Its parameters were set to enforce EUT transmitting at the maximum power. The measured power in the radio frequency on the transmitter output terminals shall be reported.

Test procedures

1. The transmitter output port was connected to the system simulator.
2. Set eut at maximum power through the system simulator.
3. Select lowest, middle, and highest channels for each band and different modulation.
4. Measure and record the power level from the system simulator.

Test setup

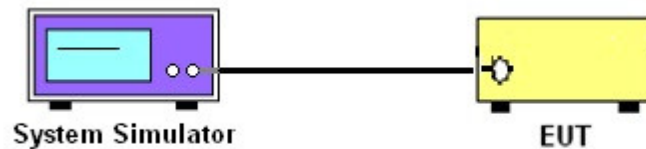

5.2 PEAK TO AVERAGE RATIO

TEST OVERVIEW

According to §24.232(d), power measurements for transmissions by stations authorized under this section may be made either in accordance with a commission-approved average power technique or in compliance with paragraph (e) of this section. In both instances, equipment employed must be authorized in accordance with the provisions of §24.51. In measuring transmissions in this band using an average power technique, the peak-to-average ratio (PAR) of the transmission may not exceed 13 db.

TEST PROCEDURES

1. The testing follows fcckdb 971168 v02r02 section
2. The eut was connected to the and peak and av system simulator& spectrum analysis reads
3. Select lowest, middle, and highest channels for each band and different modulation.
4. Set the test probe and measure average power of the spectrum analysis

TEST SETUP

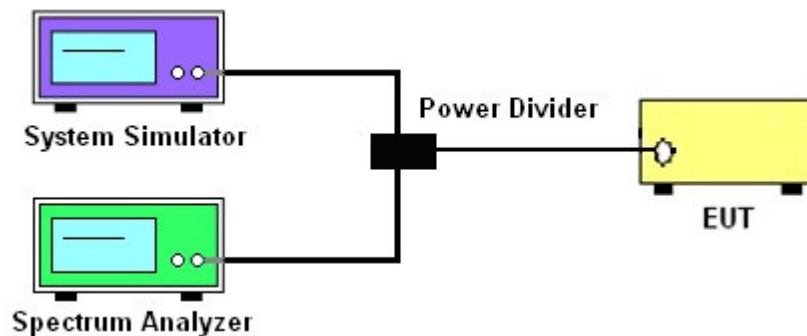

5.3 TRANSMITTER RADIATED POWER (EIRP/ERP)

TEST OVERVIEW

Effective Radiated Power (ERP) and Equivalent Isotropic Radiated Power (EIRP) measurements are performed using the substitution method described in ANSI/TIA-603-D-2010 with the EUT transmitting into an integral antenna. Measurements on signals operating below 1GHz are performed using vertically polarized tuned dipole antennas. Measurements on signals operating above 1GHz are performed using vertically polarized broadband horn antennas. All measurements are performed as RMS average measurements while the EUT is operating at maximum power, and at the appropriate frequencies.

TEST PROCEDURE

1. The testing follows FCC KDB 971168 D01 Section 5.2.1. (for CDMA/WCDMA), Section 5.2.2 (for GSM/GPRS) and ANSI / TIA-603-D-2010 Section 2.2.17.
2. The transmitter was placed on a wooden turntable, and it was transmitting into a non-radiating load which was also placed on the turntable.
3. The measurement antenna was placed at a distance of 3 meters from the EUT. During the tests, the antenna height and polarization as well as EUT azimuth were varied in order to identify the maximum level of emissions from the EUT. The test was performed by placing the EUT on 3-orthogonal axis.
4. The frequency range up to tenth harmonic of the fundamental frequency was investigated.
5. Remove the EUT and replace it with substitution antenna. A signal generator was connected to the substitution antenna by a nonradiating cable. The absolute levels of the spurious emissions were measured by the substitution.
6. Effective Isotropic Radiated Power (EIRP) was measured by substitution method according to TIA/EIA-603-D. The EUT was replaced by the substitution antenna at same location, and then a known power from S.G. was applied into the dipole antenna through a Tx cable, and then recorded the maximum Analyzer reading through raised and lowered the test antenna. The correction factor (in dB) = S.G. - Tx Cable loss + Substitution antenna gain - Analyzer reading. Then the EUT's EIRP/ERP was calculated with the correction factor,
$$\text{ERP/EIRP} = \text{P.SG} + \text{GT} - \text{LC}$$

ERP/EIRP = effective or equivalent radiated power, respectively (expressed in the same units as P_{Meas} as, typically dBW or dBm);
P_{Meas}(PK) = measured transmitter output power or PSD, in dBm or dBW;
GT = gain of the transmitting antenna, in dBd (ERP) or dBi (EIRP);
LC = signal attenuation in the connecting cable between the transmitter and antenna, in dB.

5.4 OCCUPIED BANDWIDTH

TEST OVERVIEW

The occupied bandwidth, that is the frequency bandwidth such that, below its lower and above its upper frequency limits, the mean powers radiated are each equal to 0.5 percent of the total mean power radiated by a given emission shall be measured.

The 26 dB emission bandwidth is defined as the frequency range between two points, one above and one below the carrier frequency, at which the spectral density of the emission is attenuated 26 dB below the maximum in-band spectral density of the modulated signal. Spectral density (power per unit bandwidth) is to be measured with a detector of resolution bandwidth equal to approximately 1.0% of the emission bandwidth.

All modes of operation were investigated and the worst case configuration results are reported in this section.

TEST PROCEDURE

1. The signal analyzer's automatic bandwidth measurement capability was used to perform the 99% occupied bandwidth and the 26dB bandwidth. The bandwidth measurement was not influenced by any intermediate power nulls in the fundamental emission.
2. $RBW = 1 - 5\%$ of the expected OBW
3. $VBW \geq 3 \times RBW$
4. Detector = Peak
5. Trace mode = max hold
6. Sweep = auto couple
7. The trace was allowed to stabilize
8. If necessary, steps 2 – 7 were repeated after changing the RBW such that it would be within 1 – 5% of the 99% occupied bandwidth observed in Step 7

TEST SETUP

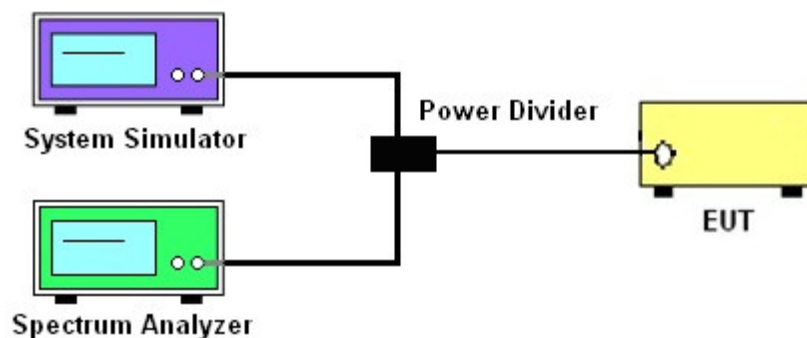

5.5 FREQUENCY STABILITY

Test Overview

Frequency stability testing is performed in accordance with the guidelines of ANSI/TIA-603-D-2010. The frequency stability of the transmitter is measured by:

- a.) Temperature: The temperature is varied from -30°C to +50°C in 10°C increments using an environmental chamber.
- b.) Primary Supply Voltage: The primary supply voltage is varied from 85% to 115% of the nominal value for non hand-carried battery and AC powered equipment. For hand-carried, battery-powered equipment, primary supply voltage is reduced to the battery operating end point which shall be specified by the manufacturer.

For Part 22, the frequency stability of the transmitter shall be maintained within $\pm 0.00025\%$ (± 2.5 ppm) of the center frequency. For Part 24 the frequency stability shall be sufficient to ensure that the fundamental emission stays within the authorized frequency block.

Test Procedure

Temperature Variation

1. The testing follows fccdb 971168 D01 section 9.0
2. The EUT was set up in the thermal chamber and connected with the system simulator.
3. With power OFF, the temperature was decreased to -30°C and the EUT was stabilized before testing. Power was applied and the maximum change in frequency was recorded within one minute.
4. With power OFF, the temperature was raised in 10°C steps up to 50°C. The EUT was stabilized at each step for at least half an hour. Power was applied and the maximum frequency change was recorded within one minute.

Voltage Variation

1. The testing follows FCC KDB 971168 D01 Section 9.0.
2. The EUT was placed in a temperature chamber at $25\pm 5^\circ\text{C}$ and connected with the system simulator.
3. The power supply voltage to the EUT was varied from 85% to 115% of the nominal value measured at the input to the EUT.
4. The variation in frequency was measured for the worst case.

TEST SETUP

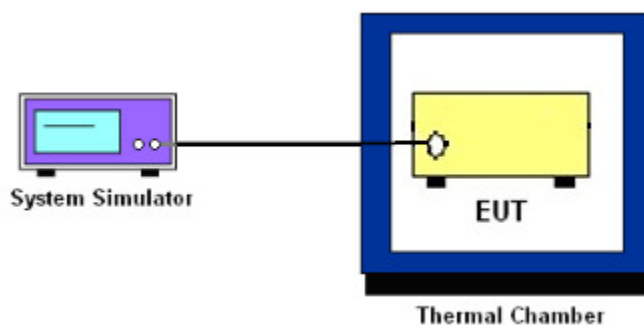

5.6 SPURIOUS EMISSIONS AT ANTENNA TERMINALS

Test Overview

The power of any emission outside of the authorized operating frequency ranges must be lower than the transmitter power (P) by a factor of at least $43 + 10 \log (P)$ dB.

It is measured by means of a calibrated spectrum analyzer and scanned from 30 MHz up to a frequency including its 10th harmonic.

Test procedure

1. The testing FCC KDB 971168 D01 v02r02 Section 6.0. and ANSI/TIA-603-D-2010-Section 2.2.13.2(d)
2. The EUT was connected to the spectrum analyzer and system simulator via a power divider.
3. The RF output of EUT was connected to the spectrum analyzer by an RF cable and attenuator. The path loss was compensated to the results for each measurement.
4. The middle channel for the highest RF power within the transmitting frequency was measured.
5. The conducted spurious emission for the whole frequency range was taken.
6. The RF fundamental frequency should be excluded against the limit line in the operating frequency band.

7. The limit line is derived from $43 + 10\log(P)$ dB below the transmitter power P(Watts)

$$= P(W) - [43 + 10\log(P)] \text{ (dB)}$$

$$= [30 + 10\log(P)] \text{ (dBm)} - [43 + 10\log(P)] \text{ (dB)}$$

$$= -13\text{dBm.}$$

Test Setup

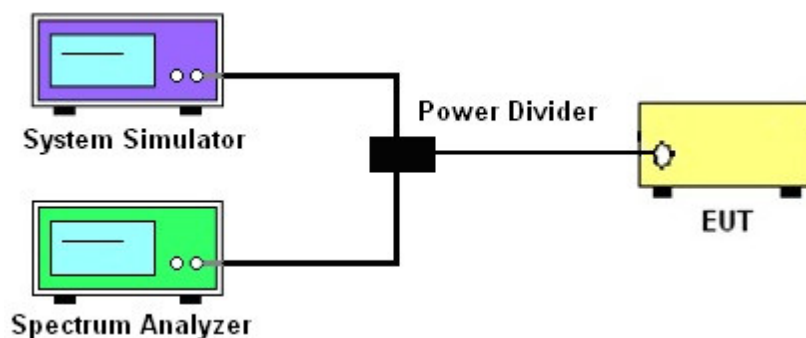

5.7 BAND EDGE

OVERVIEW

All out of band emissions are measured with a spectrum analyzer connected to the antenna terminal of the EUT while the EUT is operating at maximum power, and at the appropriate frequencies. All data rates were investigated to determine the worst case configuration. All modes of operation were investigated and the worst case configuration results are reported in this section.

The minimum permissible attenuation level of any spurious emission is $43 + \log_{10}(P[\text{Watts}])$, where P is the transmitter power in Watts.

TEST PROCEDURE

1. The testing FCC KDB 971168 D01 v02r02 Section 6.0. and ANSI/TIA-603-D-2010-Section 2.2.13.2(d)
2. Start and stop frequency were set such that the band edge would be placed in the center of the Plot.
3. The EUT was connected to the spectrum analyzer and system simulator via a power divider.
4. The RF output of EUT was connected to the spectrum analyzer by an RF cable and attenuator.

The path loss was compensated to the results for each measurement.

5. The band edges of low and high channels for the highest RF powers were measured.

6. The RF fundamental frequency should be excluded against the limit line in the operating frequency band.

7. The limit line is derived from $43 + 10\log(P)$ dB below the transmitter power P(Watts)

$$= P(\text{W}) - [43 + 10\log(P)] (\text{dB})$$

$$= [30 + 10\log(P)] (\text{dBm}) - [43 + 10\log(P)] (\text{dB})$$

$$= -13\text{dBm}.$$

TEST SETUP

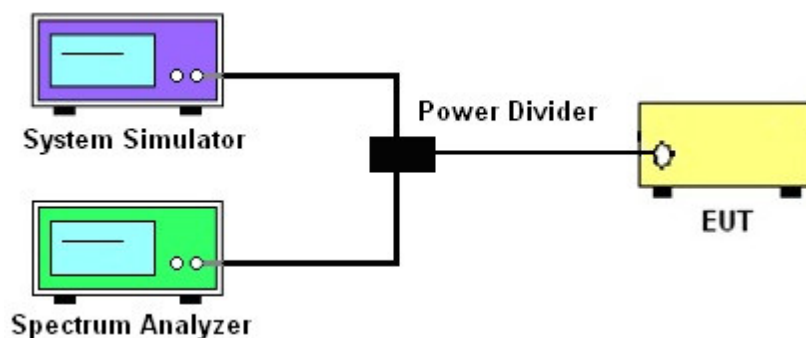

5.8 FIELD STRENGTH OF SPURIOUS RADIATION MEASUREMENT

Test overview

Radiated spurious emissions measurements are performed using the substitution method described in ANSI/TIA-603-D-2010 with the EUT transmitting into an integral antenna. Measurements on signals operating below 1GHz are performed using horizontally and vertically polarized tuned dipole antennas. Measurements on signals operating above 1GHz are performed using vertically and horizontally polarized horn antennas. All measurements are performed as peak measurements while the EUT is operating at maximum power and at the appropriate frequencies.

It is measured by means of a calibrated spectrum analyzer and scanned from 30 MHz up to a frequency including its 10th harmonic.

Test procedure

1. The testing FCC KDB 971168 D01 Section 5.8 and ANSI/TIA-603-D-2010-Section 2.2.12.2(b)
2. RBW = 100kHz for emissions below 1GHz and 1MHz for emissions above 1GHz
3. VBW $\geq 3 \times$ RBW
4. Span = 1.5 times the OBW
5. No. of sweep points $> 2 \times$ span/RBW
6. Detector = Peak
7. Trace mode = max hold
8. The trace was allowed to stabilize
9. Effective Isotropic Spurious Radiation was measured by substitution method according to TIA/EIA-603-D. The EUT was replaced by the substitution antenna at same location, and then a known power from S.G. was applied into the dipole antenna through a Tx cable, and then recorded the maximum Analyzer reading through raised and lowered the test antenna. The correction factor (in dB) = S.G. - Tx Cable loss + Substitution antenna gain - Analyzer reading. Then the EUT's EIRP/ERP was calculated with the correction factor,
$$\text{ERP/EIRP} = \text{P.SG} + \text{GT} - \text{LC}$$

ERP/EIRP = effective or equivalent radiated power, respectively (expressed in the same units as P_{Meas}, typically dBW or dBm);
P.SG = measured transmitter output power or PSD, in dBm or dBW;
GT = gain of the transmitting antenna, in dBd (ERP) or dBi (EIRP);
LC = signal attenuation in the connecting cable between the transmitter and antenna, in dB.

TEST SETUP

For radiated test from 30MHz to 1GHz

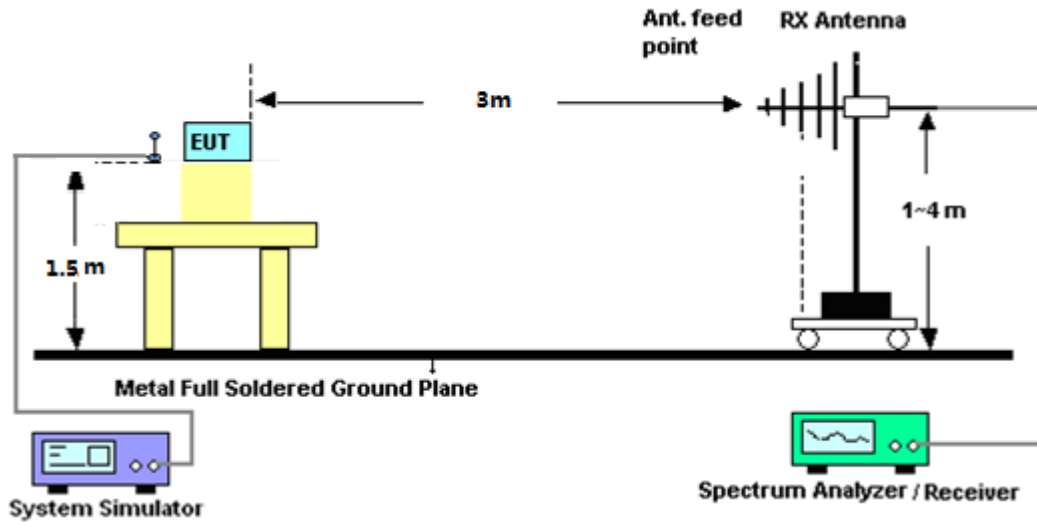

For radiated test from above 1GHz

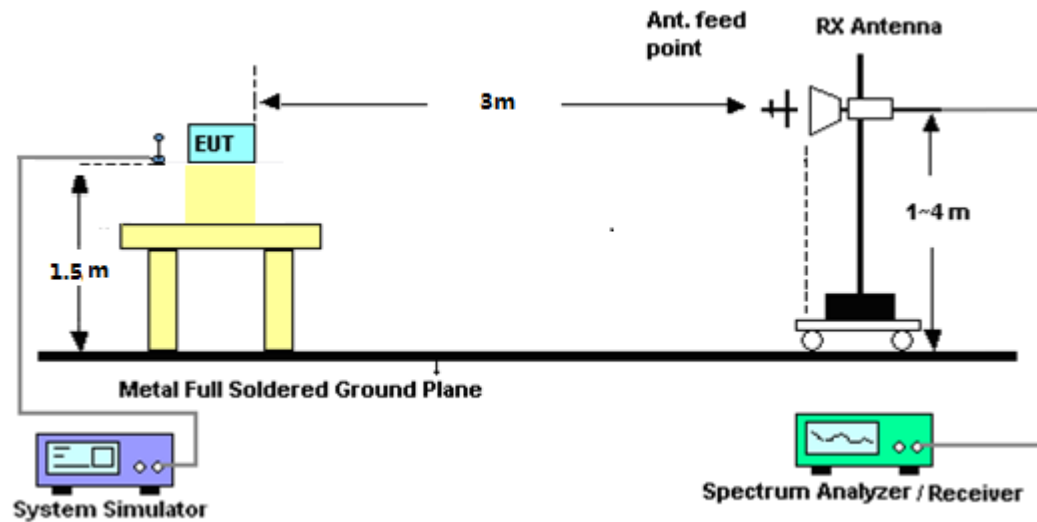

APPENDIX A TEST RESULT
A1 CONDUCTED OUTPUT POWER

GSM 850:

Mode	Frequency (MHz)	AVG Power(dBm)
GSM	824.2	31.03
	836.6	31.22
	848.8	31.15
GPRS(GMSK,1-Slot)	824.2	31.01
	836.6	31.19
	848.8	31.12
GPRS(GMSK,2-Slot)	824.2	30.55
	836.6	30.71
	848.8	30.68
GPRS(GMSK,3-Slot)	824.2	29.14
	836.6	29.30
	848.8	29.24
GPRS(GMSK,4-Slot)	824.2	28.68
	836.6	28.87
	848.8	28.83

PCS 1900:

Mode	Frequency (MHz)	AVG Power(dBm)
GSM	1850.2	30.89
	1880.0	30.92
	1909.8	30.91
GPRS(GMSK,1-Slot)	1850.2	30.86
	1880.0	30.90
	1909.8	30.89
GPRS(GMSK,2-Slot)	1850.2	30.38
	1880.0	30.46
	1909.8	30.40
GPRS(GMSK,3-Slot)	1850.2	28.88
	1880.0	29.03
	1909.8	28.92
GPRS(GMSK,4-Slot)	1850.2	28.41
	1880.0	28.56
	1909.8	28.43

UMTS BAND V

Mode	Frequency(MHz)	AVG Power
WCDMA 850 RMC	826.4	23.04
	836.6	23.09
	846.6	23.08
HSDPA Subtest 1	826.4	23.02
	836.6	23.06
	846.6	23.05
HSDPA Subtest 2	826.4	22.62
	836.6	22.64
	846.6	22.62
HSDPA Subtest 3	826.4	22.17
	836.6	22.24
	846.6	22.17
HSDPA Subtest 4	826.4	21.75
	836.6	21.91
	846.6	21.78
HSUPA Subtest 1	826.4	22.98
	836.6	23.06
	846.6	22.57
HSUPA Subtest 2	826.4	22.04
	836.6	22.11
	846.6	21.62
HSUPA Subtest 3	826.4	22.02
	836.6	21.64
	846.6	21.24
HSUPA Subtest 4	826.4	21.59
	836.6	21.24
	846.6	20.94
HSUPA Subtest 5	826.4	20.13
	836.6	19.82
	846.6	19.49

UMTS BAND II

Mode	Frequency(MHz)	AVG Power
WCDMA 1900 RMC	1852.4	22.54
	1880	22.48
	1907.6	22.39
HSDPA Subtest 1	1852.4	22.51
	1880	22.45
	1907.6	22.37
HSDPA Subtest 2	1852.4	22.09
	1880	22.02
	1907.6	21.97
HSDPA Subtest 3	1852.4	21.71
	1880	21.56
	1907.6	21.48
HSDPA Subtest 4	1852.4	21.31
	1880	21.16
	1907.6	21.10
HSUPA Subtest 1	1852.4	22.42
	1880	22.37
	1907.6	21.88
HSUPA Subtest 2	1852.4	21.46
	1880	21.43
	1907.6	20.91
HSUPA Subtest 3	1852.4	21.41
	1880	21.03
	1907.6	20.45
HSUPA Subtest 4	1852.4	20.92
	1880	20.58
	1907.6	19.99
HSUPA Subtest 5	1852.4	19.49
	1880	19.15
	1907.6	18.57

A2 PEAK-TO-AVERAGE RADIO

Mode	Frequency (MHz)	PEAK Power (dBm)	AVG Power (dBm)	PAR (dB)
GSM850	824.2	31.14	31.03	0.11
	836.6	31.33	31.22	0.11
	848.8	31.26	31.15	0.11
GPRS850	824.2	31.12	31.01	0.11
	836.6	31.31	31.19	0.12
	848.8	31.23	31.12	0.11
PCS1900	1850.2	31.00	30.89	0.11
	1880	31.03	30.92	0.11
	1909.8	31.01	30.91	0.10
GPRS1900	1850.2	30.97	30.86	0.11
	1880	31.01	30.9	0.11
	1909.8	31.01	30.89	0.12

Mode	Frequency (MHz)	PEAK Power (dBm)	AVG Power (dBm)	PAR (dB)
WCDMA 850 RMC	826.4	25.60	23.04	2.56
	836.6	25.69	23.09	2.60
	846.6	25.92	23.08	2.84
HSDPA 850	826.4	25.88	23.02	2.86
	836.6	25.59	23.06	2.53
	846.6	26.03	23.05	2.98
HSUPA 850	826.4	25.69	22.98	2.71
	836.6	25.75	23.06	2.69
	846.6	25.22	22.57	2.65
WCDMA 1900 RMC	1852.4	25.15	22.54	2.61
	1880	25.44	22.48	2.96
	1907.6	24.90	22.39	2.51
HSDPA 1900	1852.4	25.08	22.51	2.57
	1880	25.31	22.45	2.86
	1907.6	25.35	22.37	2.98
HSUPA 1900	1852.4	25.28	22.42	2.86
	1880	25.21	22.37	2.84
	1907.6	24.43	21.88	2.55

A3 TRANSMITTER RADIATED POWER (EIRP/ERP)

Radiated Power (ERP) for GSM 850 MHZ							
Mode	Frequency	Result					Conclusion
		S G.Level (dBm)	Cable loss	Gain (dBi)	PMeas E.R.P.(dBm)	Polarization Of Max. ERP	
GSM850	824.2	22.51	0.44	6.5	28.57	Horizontal	Pass
	824.2	24.43	0.44	6.5	30.49	Vertical	Pass
	836.6	22.59	0.45	6.5	28.64	Horizontal	Pass
	836.6	24.51	0.45	6.5	30.56	Vertical	Pass
	848.8	22.66	0.46	6.5	28.70	Horizontal	Pass
	848.8	24.49	0.46	6.5	30.53	Vertical	Pass
GPRS850	824.2	22.72	0.44	6.5	28.78	Horizontal	Pass
	824.2	24.20	0.44	6.5	30.26	Vertical	Pass
	836.6	22.77	0.45	6.5	28.82	Horizontal	Pass
	836.6	24.40	0.45	6.5	30.45	Vertical	Pass
	848.8	22.62	0.46	6.5	28.66	Horizontal	Pass
	848.8	24.41	0.46	6.5	30.45	Vertical	Pass

Radiated Power (EIRP) for PCS 1900 MHZ							
Mode	Frequency	Result					Conclusion
		S G.Level (dBm)	Cable loss	Gain (dBi)	PMeas E.I.R.P.(dBm)	Polarization Of Max.EIRP.	
PCS1900	1850.2	20.38	2.41	10.35	28.32	Horizontal	Pass
	1850.2	22.35	2.41	10.35	30.29	Vertical	Pass
	1880	20.4	2.42	10.35	28.33	Horizontal	Pass
	1880	22.39	2.42	10.35	30.32	Vertical	Pass
	1909.8	20.43	2.43	10.35	28.35	Horizontal	Pass
	1909.8	22.39	2.43	10.35	30.31	Vertical	Pass
GPRS1900	1850.2	20.51	2.41	10.35	28.45	Horizontal	Pass
	1850.2	22.12	2.41	10.35	30.06	Vertical	Pass
	1880	20.52	2.42	10.35	28.45	Horizontal	Pass
	1880	22.29	2.42	10.35	30.22	Vertical	Pass
	1909.8	20.41	2.43	10.35	28.33	Horizontal	Pass
	1909.8	22.34	2.43	10.35	30.26	Vertical	Pass

Radiated Power (ERP) for WCDMA Band V							
Mode	Frequency	Result					Conclusion
		S G.Level (dBm)	Cable loss	Gain (dBi)	PMeas E.R.P (dBm)	Polarization Of Max.ERP	
Band V	826.4	14.51	0.44	6.5	20.57	Horizontal	Pass
	826.4	16.43	0.44	6.5	22.49	Vertical	Pass
	835	14.50	0.45	6.5	20.55	Horizontal	Pass
	835	16.41	0.45	6.5	22.46	Vertical	Pass
	846.4	14.52	0.46	6.5	20.56	Horizontal	Pass
	846.4	16.44	0.46	6.5	22.48	Vertical	Pass

Radiated Power (EIRP) for WCDMA Band II							
Mode	Frequency	Result					Conclusion
		S G.Level (dBm)	Cable loss	Gain (dBi)	PMeas E.I.R.P.(dBm)	Polarization Of Max.EIRP	
Band II	1852.4	12.18	2.41	10.35	20.12	Horizontal	Pass
	1852.4	14.09	2.41	10.35	22.03	Vertical	Pass
	1880	12.27	2.42	10.35	20.2	Horizontal	Pass
	1880	14.08	2.42	10.35	22.01	Vertical	Pass
	1907.4	12.23	2.43	10.35	20.15	Horizontal	Pass
	1907.4	14.06	2.43	10.35	21.98	Vertical	Pass

A4 OCCUPIED BANDWIDTH(99% OCCUPIED BANDWIDTH/26DB BANDWIDTH)

Occupied Bandwidth for GSM 850 band			
Mode	Frequency(MHz)	Occupied Bandwidth (99%)(kHz)	Emission Bandwidth (-26dBc)(kHz)
Low Channel	824.2	244.16	315.5
Middle Channel	836.6	242.50	319.3
High Channel	848.8	247.99	323.6
Occupied Bandwidth for GPRS 850 band			
Mode	Frequency(MHz)	Occupied Bandwidth (99%)(kHz)	Emission Bandwidth (-26dBc)(kHz)
Low Channel	824.2	250.21	318.5
Middle Channel	836.6	246.56	321.4
High Channel	848.8	244.28	325.5

Occupied Bandwidth for GSM1900 band			
Mode	Frequency(MHz)	Occupied Bandwidth (99%)(kHz)	Emission Bandwidth (-26dBc)(kHz)
Low Channel	1850.2	245.24	316.5
Middle Channel	1880.0	246.11	313.3
High Channel	1909.8	246.68	314.9
Occupied Bandwidth for GPRS 1900 band			
Mode	Frequency(MHz)	Occupied Bandwidth (99%)(kHz)	Emission Bandwidth (-26dBc)(kHz)
Low Channel	1850.2	244.47	310.0
Middle Channel	1880.0	243.47	316.3
High Channel	1909.8	247.55	315.1

Occupied Bandwidth for UMTS band V			
Mode	Frequency(MHz)	Occupied Bandwidth (99%)(MHz)	Emission Bandwidth (-26dBc)(MHz)
Low Channel	826.4	4.4143	6.000
Middle Channel	836.6	4.3546	6.000
High Channel	846.6	4.3838	6.000
Occupied Bandwidth for UMTS band II			
Mode	Frequency(MHz)	Occupied Bandwidth (99%)(MHz)	Emission Bandwidth (-26dBc)(MHz)
Low Channel	1852.4	4.2475	4.971
Middle Channel	1880	4.2806	5.163
High Channel	1907.6	4.2512	4.964

GSM 850 CH 128

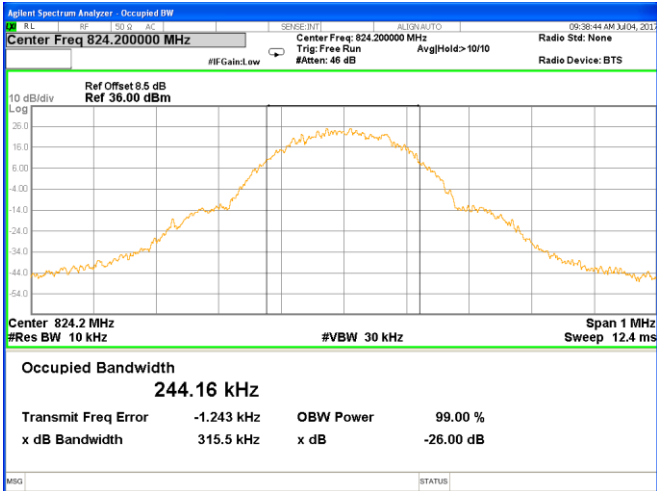

GSM 850 CH 190

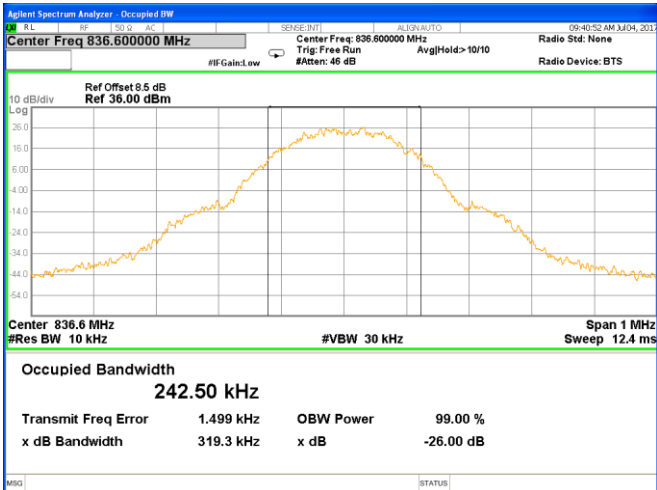

GSM 850 CH 251

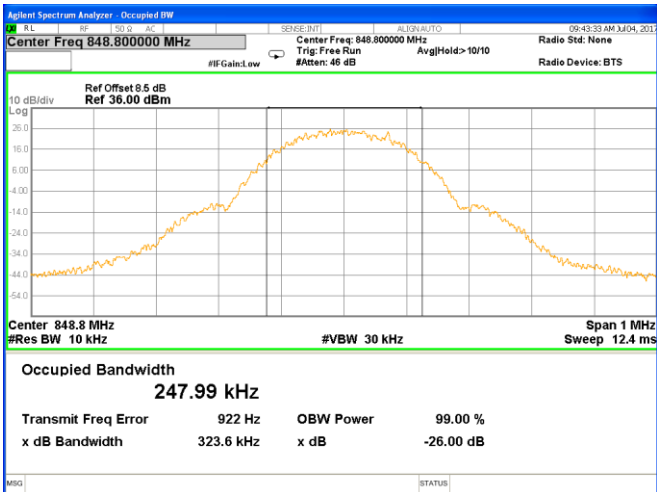

GPRS 850 CH 128

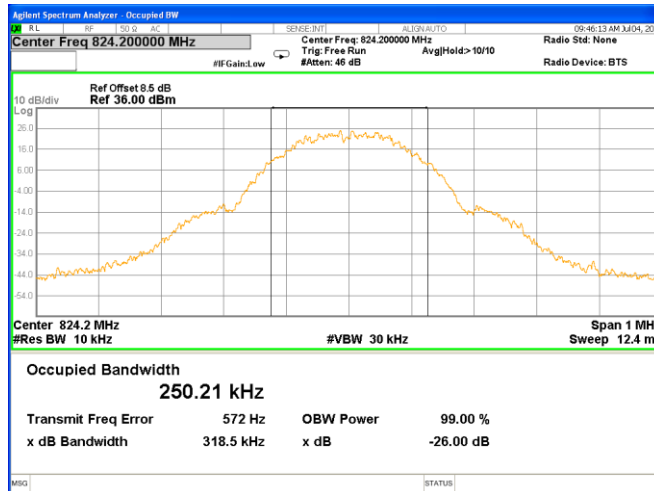

GPRS 850 CH 190

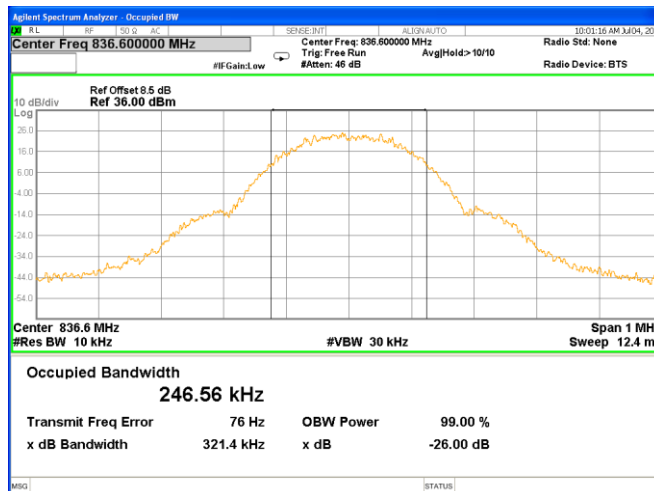

GPRS 850 CH 251

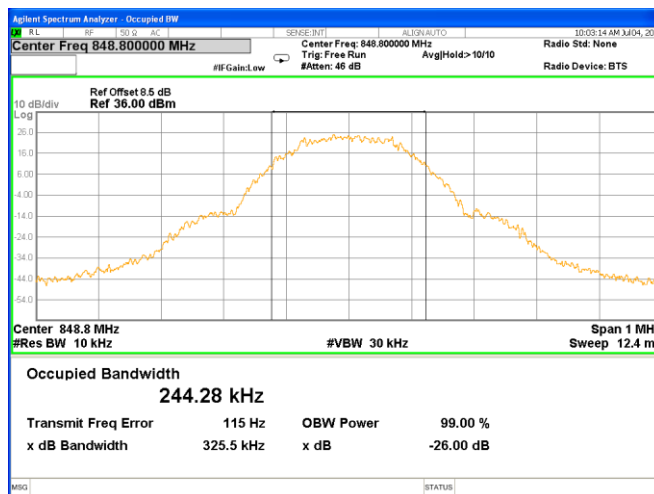

PCS 1900 CH 512

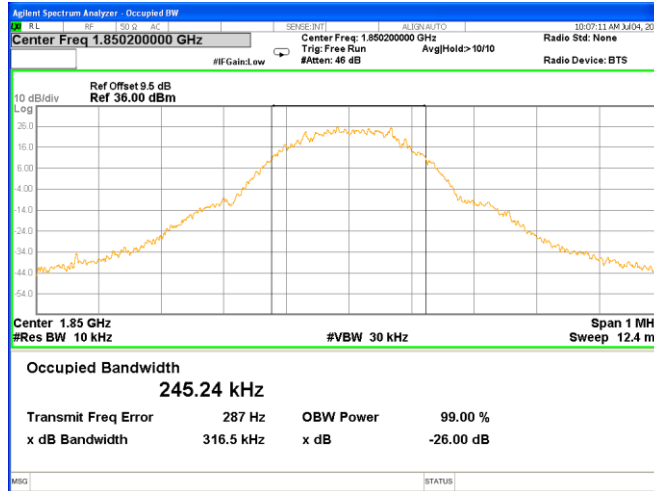

PCS 1900 CH 661

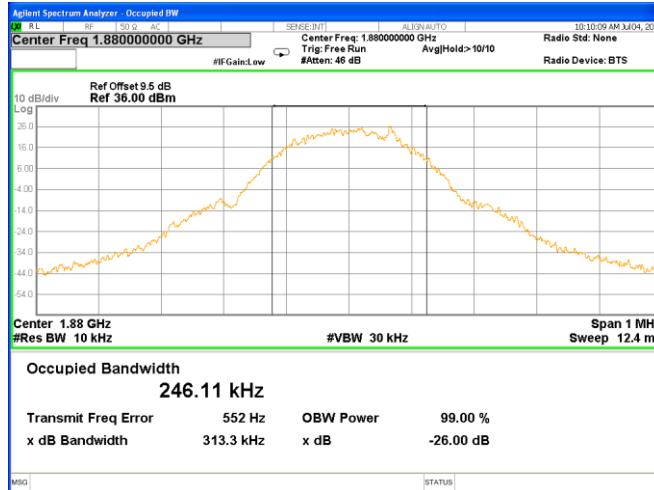

PCS 1900 CH 810

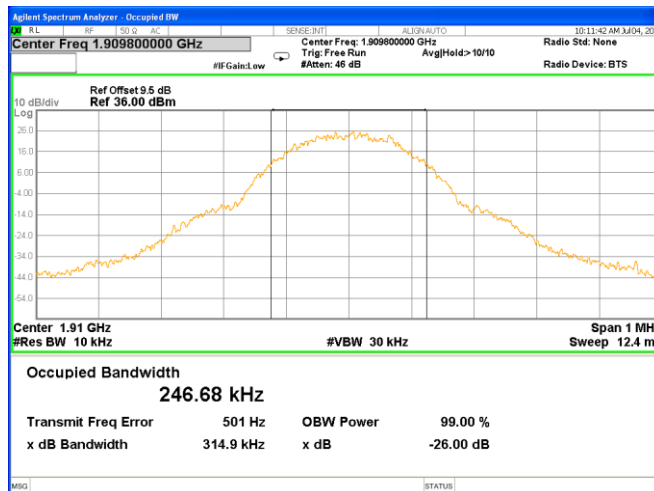

GPRS 1900 CH 512

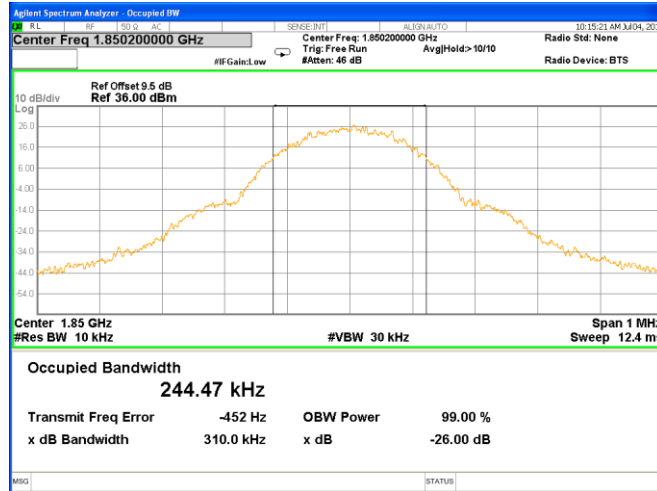

GPRS 1900 CH 661

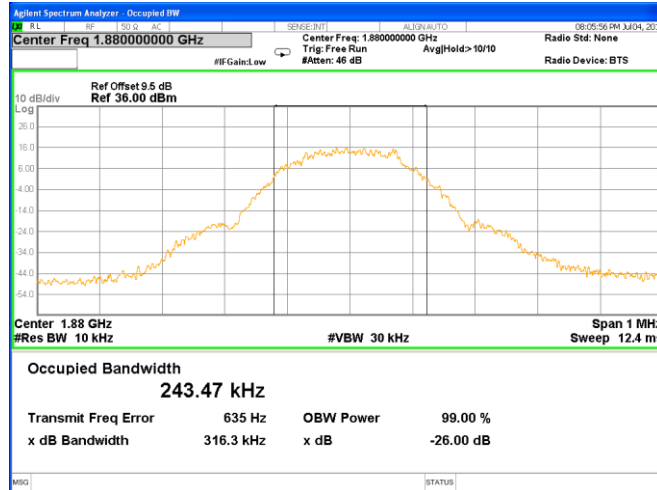

GPRS 1900 CH 810

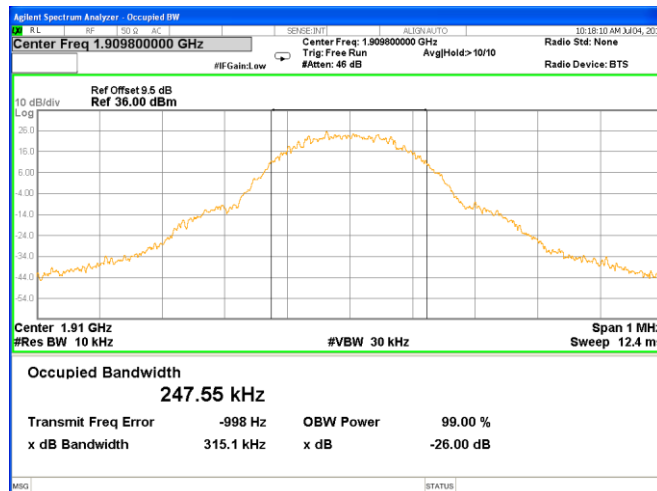

UMTS BAND V CH 4132

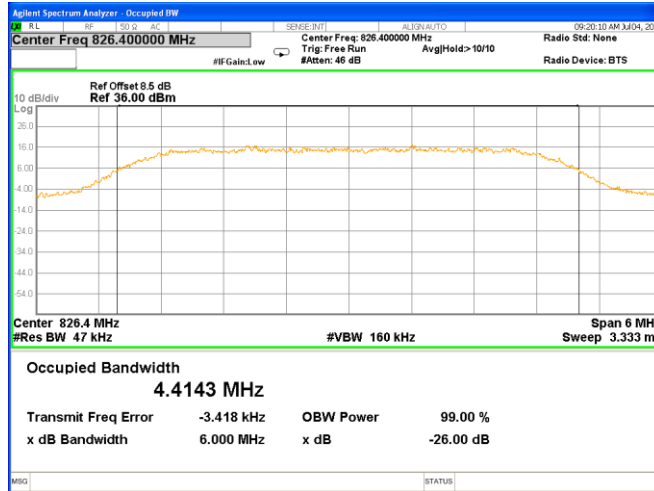

UMTS BAND V CH 4183

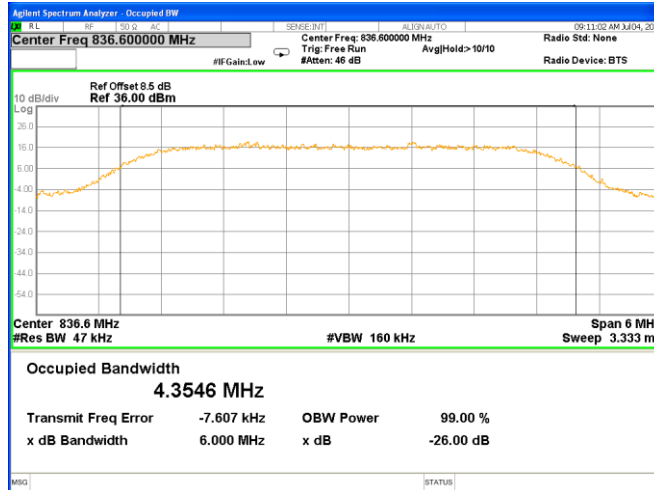

UMTS BAND V CH 4233

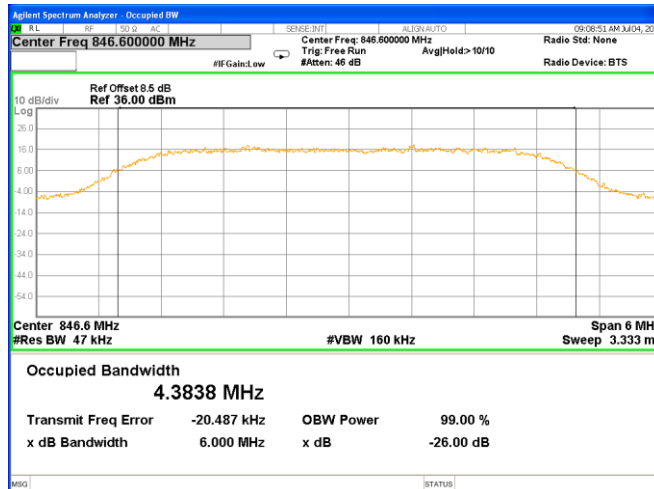

UMTS BAND II CH 9262

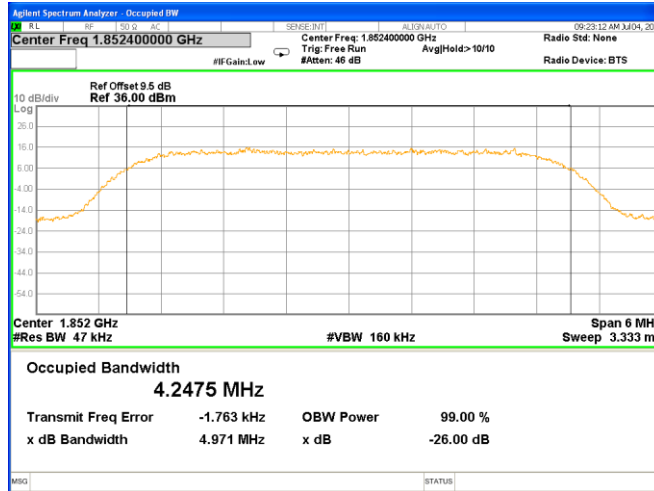

UMTS BAND II CH 9400

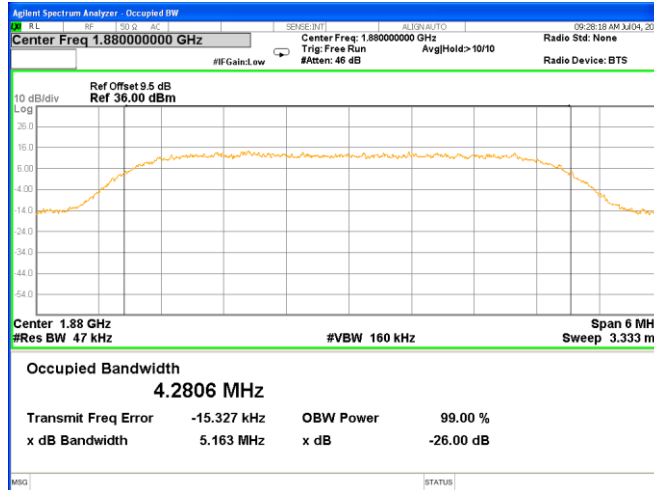

UMTS BAND II CH 9538

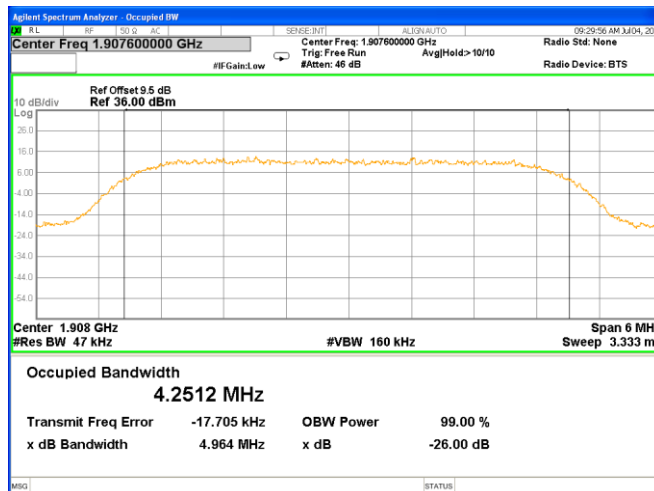

A5 FREQUENCY STABILITY

Normal Voltage = 3.8V. ; Battery End Point (BEP) = 3.4 V.; Maximum Voltage =4.25 V

GSM 850 Middle Channel/836.6MHz					
Temperature (°C)	Voltage (Volt)	Freq. Dev. (Hz)	Freq. Dev. (ppm)	Limit	Result
50	Normal Voltage	21.81	0.026	2.5ppm	PASS
40		34.85	0.042		
30		33.69	0.040		
20		33.38	0.040		
10		12.40	0.015		
0		19.61	0.023		
-10		24.37	0.029		
-20		33.85	0.040		
-30		29.23	0.035		
25		Maximum Voltage	21.96		
25	BEP	31.71	0.038		

GPRS 850 Middle Channel/836.6MHz					
Temperature (°C)	Voltage (Volt)	Freq. Dev. (Hz)	Freq. Dev. (ppm)	Limit	Result
50	Normal Voltage	35.57	0.043	2.5ppm	PASS
40		29.30	0.035		
30		21.35	0.026		
20		15.10	0.018		
10		29.72	0.036		
0		17.37	0.021		
-10		18.20	0.022		
-20		23.07	0.028		
-30		24.48	0.029		
25		Maximum Voltage	16.83		
25	BEP	29.57	0.035		

GSM 1900 Middle Channel/1880MHz					
Temperature (°C)	Voltage (Volt)	Freq. Dev. (Hz)	Freq. Dev. (ppm)	Limit	Result
50	Normal Voltage	24.78	0.013	Within Authorized Band	PASS
40		14.94	0.008		
30		23.73	0.013		
20		15.98	0.009		
10		29.26	0.016		
0		18.89	0.010		
-10		27.90	0.015		
-20		20.99	0.011		
-30		28.37	0.015		
25		Maximum Voltage	21.60		
25	BEP	16.48	0.009		

GPRS 1900 Middle Channel/1880MHz					
Temperature (°C)	Voltage (Volt)	Freq. Dev. (Hz)	Freq. Dev. (ppm)	Limit	Result
50	Normal Voltage	36.09	0.019	Within Authorized Band	PASS
40		22.70	0.012		
30		21.96	0.012		
20		24.09	0.013		
10		29.59	0.016		
0		13.29	0.007		
-10		16.86	0.009		
-20		20.76	0.011		
-30		12.23	0.007		
25		Maximum Voltage	20.97		
25	BEP	19.32	0.010		

WCDMA V Middle Channel/836.6MHz					
Temperature (°C)	Voltage (Volt)	Freq. Dev. (Hz)	Freq. Dev. (ppm)	Limit	Result
50	Normal Voltage	18.83	0.023	2.5ppm	PASS
40		24.78	0.030		
30		27.86	0.033		
20		23.76	0.028		
10		21.01	0.025		
0		31.27	0.037		
-10		13.23	0.016		
-20		22.76	0.027		
-30		19.88	0.024		
25		Maximum Voltage	18.00		
25	BEP	12.77	0.015		

1. The frequency fundamental emissions stay within the authorized frequency block based on the frequency deviation measured is small.

WCDMA II Middle Channel/1880MHz					
Temperature (°C)	Voltage (Volt)	Freq. Dev. (Hz)	Freq. Dev. (ppm)	Limit	Result
50	Normal Voltage	18.00	0.010	Within Authorized Band	PASS
40		15.09	0.008		
30		28.64	0.015		
20		31.78	0.017		
10		14.77	0.008		
0		14.51	0.008		
-10		32.61	0.017		
-20		19.94	0.011		
-30		19.95	0.011		
25		Maximum Voltage	12.86		
25	BEP	18.07	0.010		

1. The frequency fundamental emissions stay within the authorized frequency block based on the frequency deviation measured is small.

A6 SPURIOUS EMISSIONS AT ANTENNA TERMINALS

GSM 850 BAND

Lowest Channel

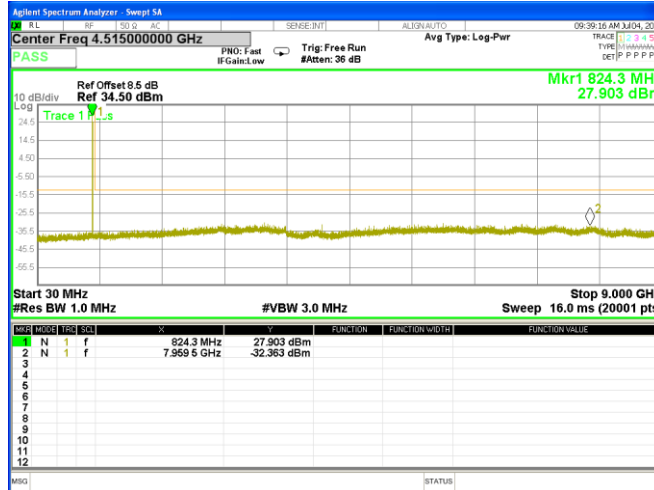

Middle Channel

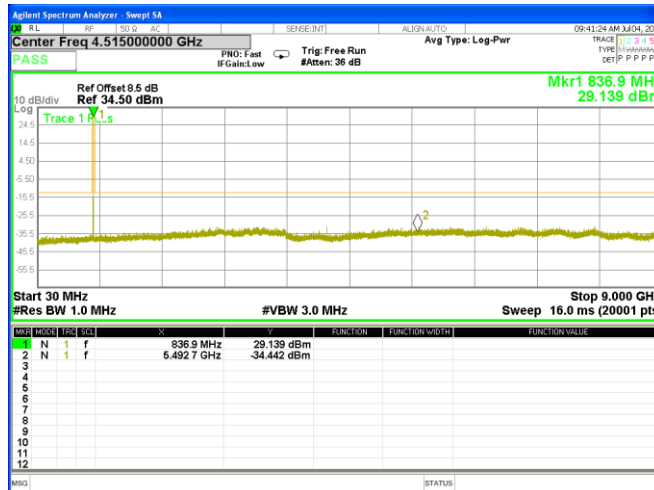

Highest Channel

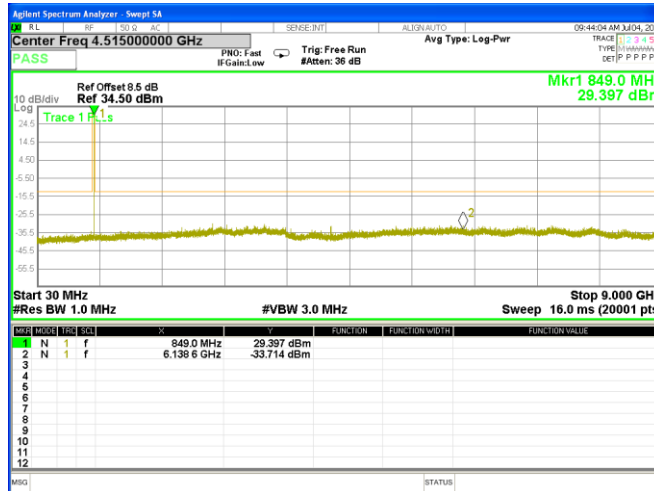

GSM1900 BAND(30M-20G)

Lowest Channel

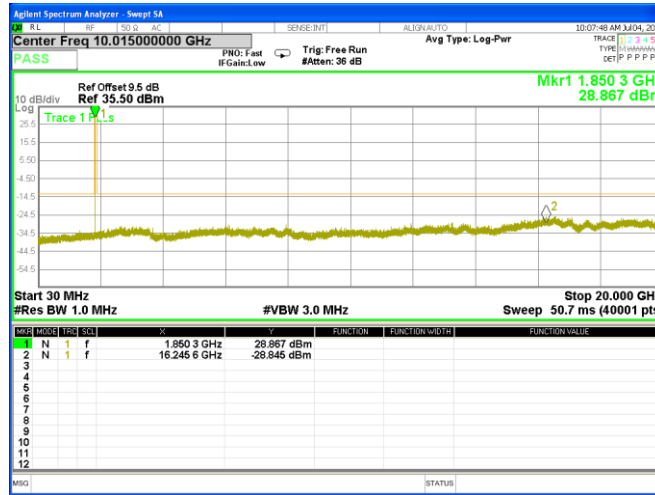

Middle Channel

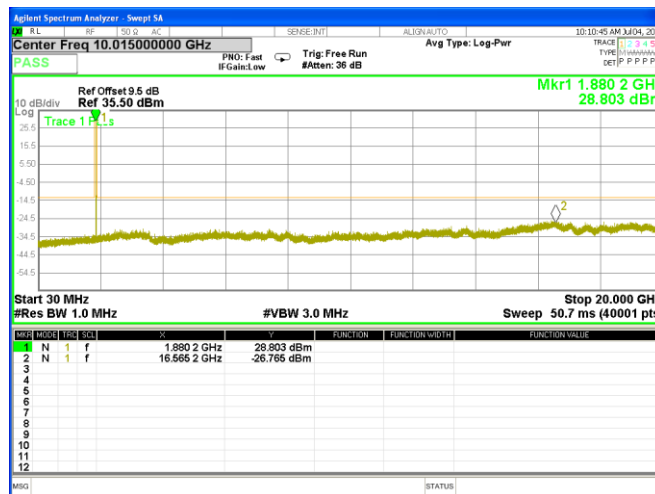

Highest Channel

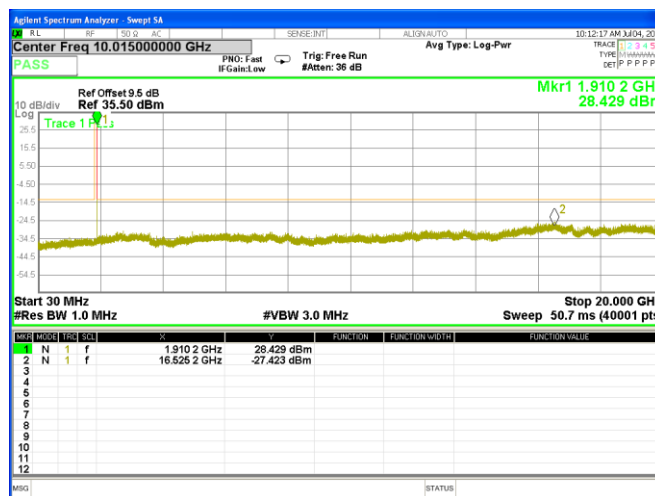

GPRS1900 BAND(30M-20G)

Lowest Channel

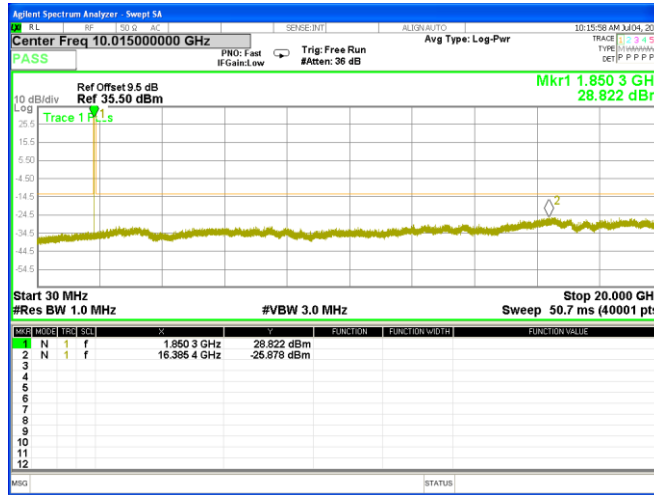

Middle Channel

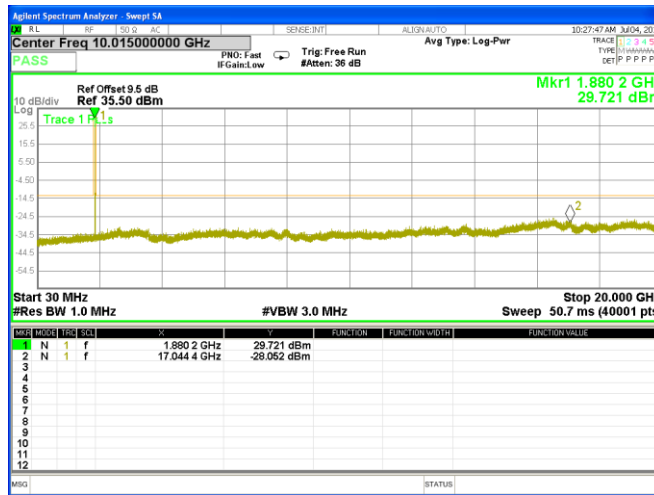

Highest Channel

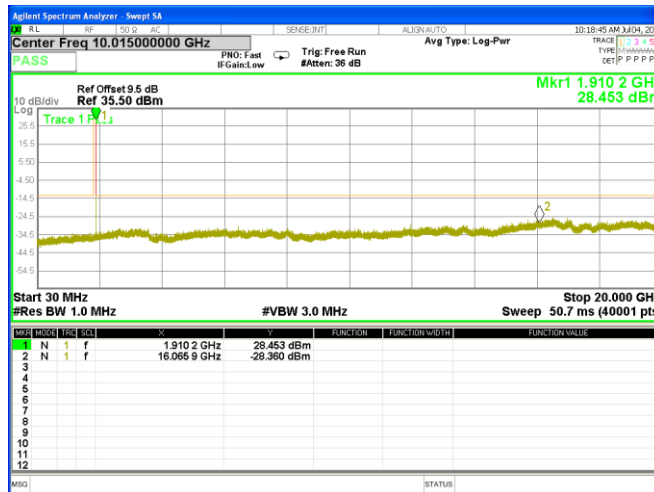

WCDMA Band V (RMC 12.2Kbps)

Lowest Channel



Middle Channel

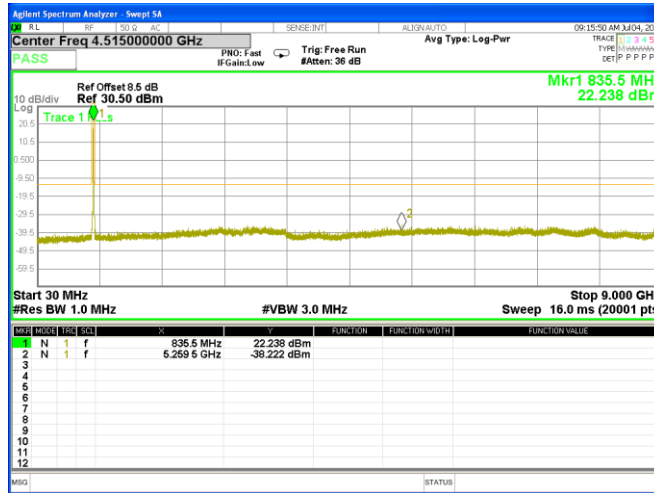

Highest Channel

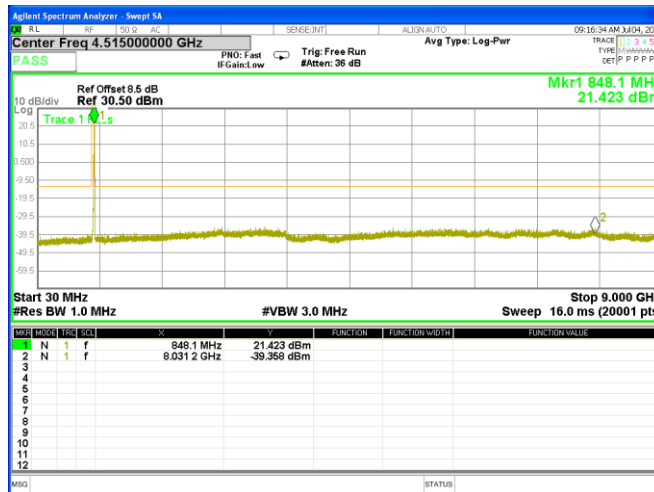

A7 BAND EDGE

GSM 850

Lowest Band Edge

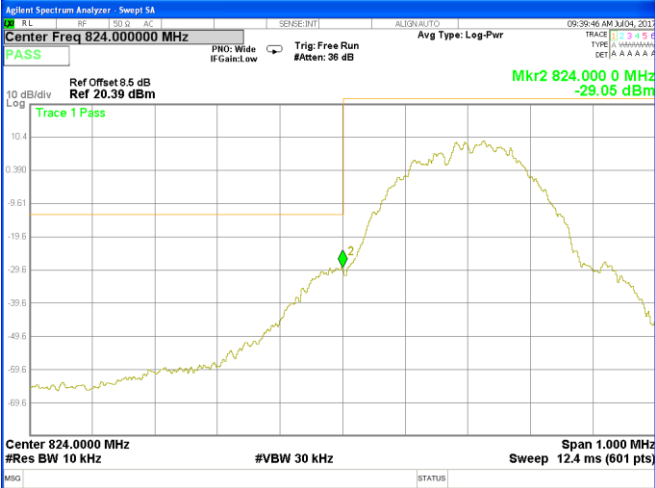

Highest Band Edge



GPRS 850

Lowest Band Edge

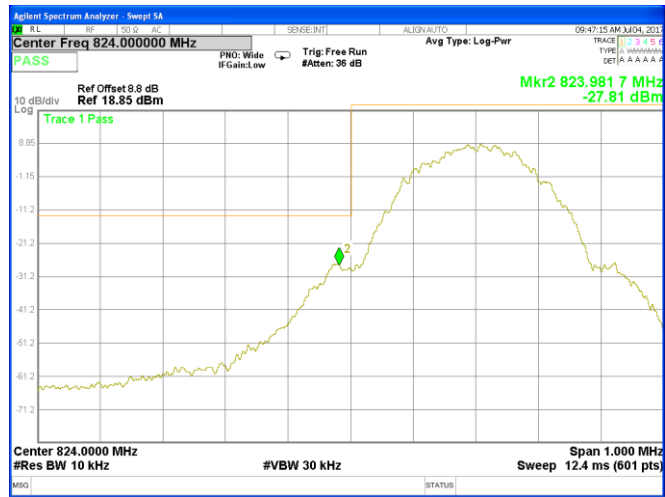

Highest Band Edge



GSM 1900

Lowest Band Edge

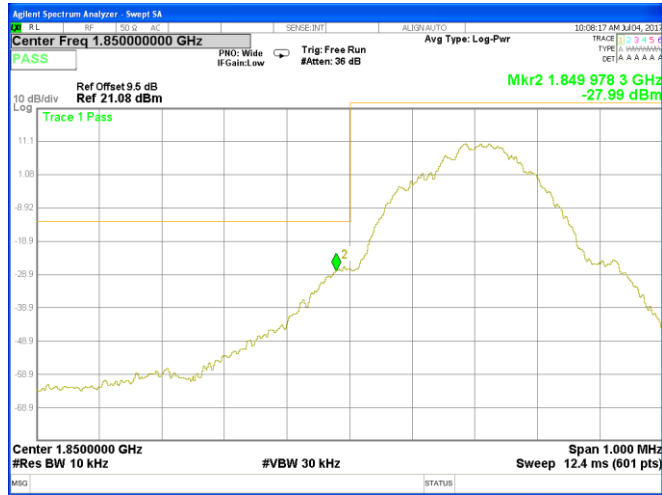

Highest Band Edge



GPRS 1900

Lowest Band Edge

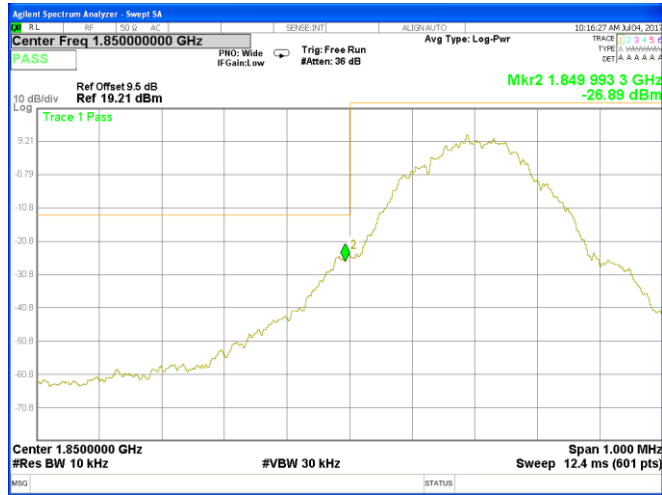

Highest Band Edge



WCDMA Band VRMC 12.2Kbps

Lowest Band Edge

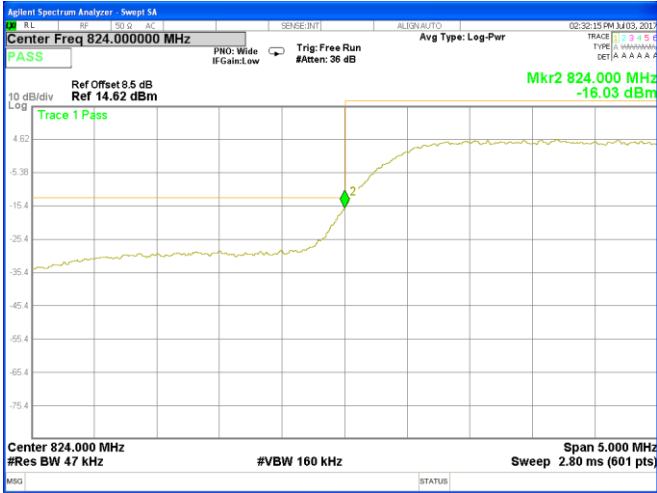

Highest Band Edge

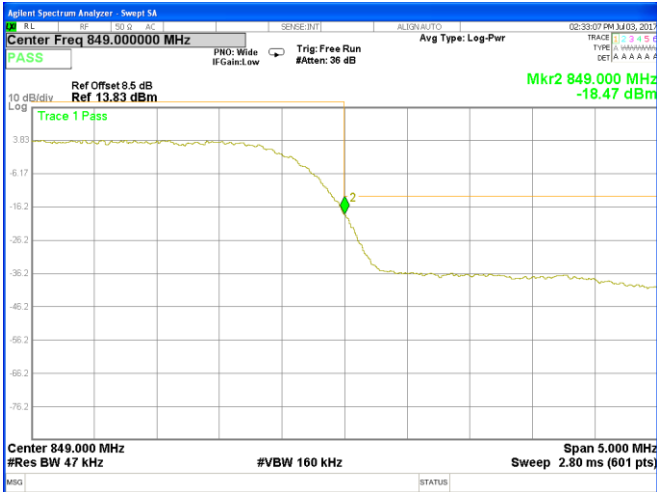

WCDMA Band IIRMC 12.2Kbps

Lowest Band Edge

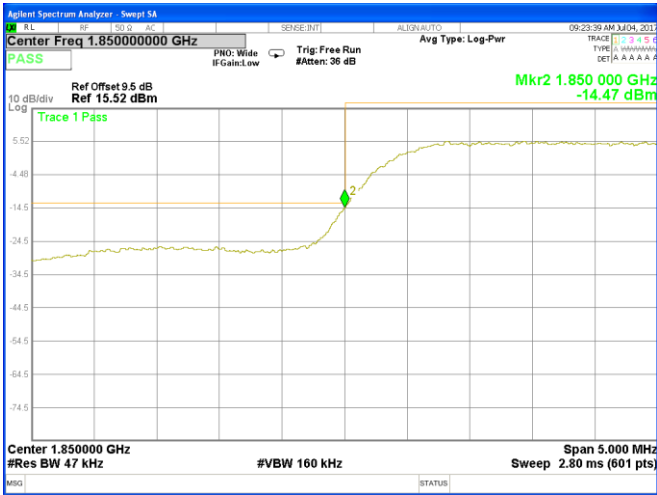

Highest Band Edge

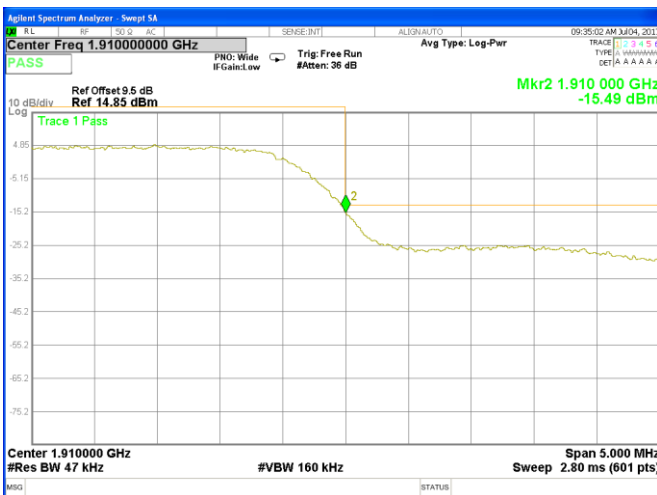

A8 FIELD STRENGTH OF SPURIOUS RADIATION MEASUREMENT

GSM 850: (30-9000)MHz

GSM 850: (30-9000)MHz							
The Worst Test Results Channel 128/824.2 MHz							
Frequency(MHz)	S G.Lev (dBm)	Ant(dBi)	Loss	PMea	Limit	Margin	Polarity
				(dBm)	(dBm)	(dB)	
1648.27	-40.92	9.40	4.75	-36.27	-13.00	-23.27	H
2472.58	-39.75	10.60	8.39	-37.54	-13.00	-24.54	H
3296.73	-31.47	12.00	11.79	-31.26	-13.00	-18.26	H
1648.17	-43.76	9.40	4.75	-39.11	-13.00	-26.11	V
2472.58	-44.39	10.60	8.39	-42.18	-13.00	-29.18	V
3296.74	-42.98	12.00	11.79	-42.77	-13.00	-29.77	V
The Worst Test Results Channel 190/836.6 MHz							
Frequency(MHz)	S G.Lev (dBm)	Ant(dBi)	Loss	PMea	Limit	Margin	Polarity
				(dBm)	(dBm)	(dB)	
1673.14	-40.58	9.50	4.76	-35.84	-13.00	-22.84	H
2509.67	-40.48	10.70	8.40	-38.18	-13.00	-25.18	H
3346.20	-31.97	12.20	11.80	-31.57	-13.00	-18.57	H
1672.79	-43.40	9.40	4.75	-38.75	-13.00	-25.75	V
2509.66	-44.47	10.60	8.39	-42.26	-13.00	-29.26	V
3346.40	-42.92	12.20	11.82	-42.54	-13.00	-29.54	V
The Worst Test Results Channel 251/848.8 MHz							
Frequency(MHz)	S G.Lev (dBm)	Ant(dBi)	Loss	PMea	Limit	Margin	Polarity
				(dBm)	(dBm)	(dB)	
1697.37	-40.31	9.60	4.77	-35.48	-13.00	-22.48	H
2546.07	-39.88	10.80	8.50	-37.58	-13.00	-24.58	H
3394.94	-32.09	12.50	11.90	-31.49	-13.00	-18.49	H
1697.62	-44.46	9.60	4.77	-39.63	-13.00	-26.63	V
2546.55	-44.59	10.80	8.50	-42.29	-13.00	-29.29	V
3395.17	-43.57	12.50	11.90	-42.97	-13.00	-29.97	V

Note: (1)Below 30MHz no Spurious found is the worst condition.

(2)Above 3.5GHz amplitude of spurious emissions which are attenuated by more than 20dB below the permissible value has.

GPRS 850: (30-9000)MHz

GPRS 850: (30-9000)MHz							
The Worst Test Results Channel 128/824.2 MHz							
Frequency(MHz)	S G.Lev (dBm)	Ant(dBi)	Loss	PMea	Limit	Margin	Polarity
				(dBm)	(dBm)	(dB)	
1648.29	-41.15	9.40	4.75	-36.50	-13.00	-23.50	H
2472.67	-40.19	10.60	8.39	-37.98	-13.00	-24.98	H
3296.71	-31.26	12.00	11.79	-31.05	-13.00	-18.05	H
1648.09	-44.35	9.40	4.75	-39.70	-13.00	-26.70	V
2472.47	-44.48	10.60	8.39	-42.27	-13.00	-29.27	V
3296.72	-43.37	12.00	11.79	-43.16	-13.00	-30.16	V
The Worst Test Results Channel 190/836.6 MHz							
Frequency(MHz)	S G.Lev (dBm)	Ant(dBi)	Loss	PMea	Limit	Margin	Polarity
				(dBm)	(dBm)	(dB)	
1672.99	-40.53	9.50	4.76	-35.79	-13.00	-22.79	H
2509.81	-39.58	10.70	8.40	-37.28	-13.00	-24.28	H
3346.14	-30.96	12.20	11.80	-30.56	-13.00	-17.56	H
1673.16	-43.88	9.40	4.75	-39.23	-13.00	-26.23	V
2509.87	-44.53	10.60	8.39	-42.32	-13.00	-29.32	V
3345.97	-42.80	12.20	11.82	-42.42	-13.00	-29.42	V
The Worst Test Results Channel 251/848.8 MHz							
Frequency(MHz)	S G.Lev (dBm)	Ant(dBi)	Loss	PMea	Limit	Margin	Polarity
				(dBm)	(dBm)	(dB)	
1697.52	-40.61	9.60	4.77	-35.78	-13.00	-22.78	H
2546.42	-40.60	10.80	8.50	-38.30	-13.00	-25.30	H
3394.91	-32.28	12.50	11.90	-31.68	-13.00	-18.68	H
1697.53	-44.37	9.60	4.77	-39.54	-13.00	-26.54	V
2546.48	-44.37	10.80	8.50	-42.07	-13.00	-29.07	V
3395.02	-43.80	12.50	11.90	-43.20	-13.00	-30.20	V

Note: (1)Below 30MHz no Spurious found is the worst condition.

(2)Above 3.5GHz amplitude of spurious emissions which are attenuated by more than 20dB below the permissible value has.

PCS 1900: (30-20000)MHz

DCS 1900: (30-20000)MHz							
The Worst Test Results for Channel 512/1850.2MHz							
Frequency(MHz)	S G.Lev (dBm)	Ant(dBi)	Loss	PMea	Limit	Margin	Polarity
				(dBm)	(dBm)	(dB)	
3700.43	-33.92	12.60	12.93	-34.25	-13.00	-21.25	H
5550.38	-34.02	13.10	17.11	-38.03	-13.00	-25.03	H
7400.75	-33.45	11.50	22.20	-44.15	-13.00	-31.15	H
3700.51	-35.13	12.60	12.93	-35.46	-13.00	-22.46	V
5550.25	-34.57	13.10	17.11	-38.58	-13.00	-25.58	V
7400.64	-32.51	11.50	22.20	-43.21	-13.00	-30.21	V
The Worst Test Results for Channel 661/1880.0MHz							
Frequency(MHz)	S G.Lev (dBm)	Ant(dBi)	Loss	PMea	Limit	Margin	Polarity
				(dBm)	(dBm)	(dB)	
3759.95	-34.80	12.60	12.93	-35.13	-13.00	-22.13	H
5639.90	-34.44	13.10	17.11	-38.45	-13.00	-25.45	H
7520.03	-33.20	11.50	22.20	-43.90	-13.00	-30.90	H
3759.99	-35.59	12.60	12.93	-35.92	-13.00	-22.92	V
5640.23	-34.18	13.10	17.11	-38.19	-13.00	-25.19	V
7520.21	-32.11	11.50	22.20	-42.81	-13.00	-29.81	V
The Worst Test Results for Channel 810/1909.8MHz							
Frequency(MHz)	S G.Lev (dBm)	Ant(dBi)	Loss	PMea	Limit	Margin	Polarity
				(dBm)	(dBm)	(dB)	
3819.48	-34.67	12.60	12.93	-35.00	-13.00	-22.00	H
5729.40	-34.21	13.10	17.11	-38.22	-13.00	-25.22	H
7639.00	-32.85	11.50	22.20	-43.55	-13.00	-30.55	H
3819.54	-35.37	12.60	12.93	-35.70	-13.00	-22.70	V
5729.45	-34.77	13.10	17.11	-38.78	-13.00	-25.78	V
7639.10	-31.85	11.50	22.20	-42.55	-13.00	-29.55	V

Note: (1)Below 30MHz no Spurious found is the worst condition.

(2)Above 8GHz amplitude of spurious emissions which are attenuated by more than 20dB below the permissible value has.

GPRS 1900: (30-20000)MHz

GPRS1900: (30-20000)MHz							
The Worst Test Results for Channel 512/1850.2MHz							
Frequency(MHz)	S G.Lev (dBm)	Ant(dBi)	Loss	PMea	Limit	Margin	Polarity
				(dBm)	(dBm)	(dB)	
3700.23	-33.59	12.60	12.93	-33.92	-13.00	-20.92	H
5550.41	-34.62	13.10	17.11	-38.63	-13.00	-25.63	H
7400.61	-32.55	11.50	22.20	-43.25	-13.00	-30.25	H
3700.51	-35.54	12.60	12.93	-35.87	-13.00	-22.87	V
5550.47	-33.84	13.10	17.11	-37.85	-13.00	-24.85	V
7400.52	-33.02	11.50	22.20	-43.72	-13.00	-30.72	V
The Worst Test Results for Channel 661/1880.0MHz							
Frequency(MHz)	S G.Lev (dBm)	Ant(dBi)	Loss	PMea	Limit	Margin	Polarity
				(dBm)	(dBm)	(dB)	
3760.09	-33.73	12.60	12.93	-34.06	-13.00	-21.06	H
5640.08	-34.98	13.10	17.11	-38.99	-13.00	-25.99	H
7519.89	-32.67	11.50	22.20	-43.37	-13.00	-30.37	H
3759.90	-35.27	12.60	12.93	-35.60	-13.00	-22.60	V
5639.97	-33.92	13.10	17.11	-37.93	-13.00	-24.93	V
7520.13	-32.03	11.50	22.20	-42.73	-13.00	-29.73	V
The Worst Test Results for Channel 810/1909.8MHz							
Frequency(MHz)	S G.Lev (dBm)	Ant(dBi)	Loss	PMea	Limit	Margin	Polarity
				(dBm)	(dBm)	(dB)	
3819.39	-33.69	12.60	12.93	-34.02	-13.00	-21.02	H
5729.06	-33.99	13.10	17.11	-38.00	-13.00	-25.00	H
7639.16	-33.48	11.50	22.20	-44.18	-13.00	-31.18	H
3819.75	-35.29	12.60	12.93	-35.62	-13.00	-22.62	V
5729.31	-34.96	13.10	17.11	-38.97	-13.00	-25.97	V
7638.93	-33.12	11.50	22.20	-43.82	-13.00	-30.82	V

Note: (1)Below 30MHz no Spurious found is the worst condition.

(2)Above 8GHz amplitude of spurious emissions which are attenuated by more than 20dB below the permissible value has.

UMTS band V(30-9000)MHz

WCDMA Band V: (30-9000)MHz							
The most testresults channel 4132/826.4MHz							
Frequency(MHz)	S G.Lev (dBm)	Ant(dBi)	Loss	PMea	Limit	Margin	Polarity
				(dBm)	(dBm)	(dB)	
1652.16	-41.20	9.40	4.75	-36.55	-13.00	-23.55	H
2479.45	-39.99	10.60	8.39	-37.78	-13.00	-24.78	H
3305.47	-32.18	12.00	11.79	-31.97	-13.00	-18.97	H
1652.21	-43.86	9.40	4.75	-39.21	-13.00	-26.21	V
2479.28	-44.47	10.60	8.39	-42.26	-13.00	-29.26	V
3305.61	-43.44	12.00	11.79	-43.23	-13.00	-30.23	V
The Worst Test Results Channel 4183/836.6MHz							
Frequency(MHz)	S G.Lev (dBm)	Ant(dBi)	Loss	PMea	Limit	Margin	Polarity
				(dBm)	(dBm)	(dB)	
1673.23	-40.83	9.50	4.76	-36.09	-13.00	-23.09	H
2509.52	-40.00	10.70	8.40	-37.70	-13.00	-24.70	H
3346.18	-31.21	12.20	11.80	-30.81	-13.00	-17.81	H
1673.23	-44.56	9.40	4.75	-39.91	-13.00	-26.91	V
2509.68	-44.96	10.60	8.39	-42.75	-13.00	-29.75	V
3346.11	-43.44	12.20	11.82	-43.06	-13.00	-30.06	V
The Worst Test Results Channel 4233/846.6MHz							
Frequency(MHz)	S G.Lev (dBm)	Ant(dBi)	Loss	PMea	Limit	Margin	Polarity
				(dBm)	(dBm)	(dB)	
1693.27	-40.25	9.60	4.77	-35.42	-13.00	-22.42	H
2539.38	-40.34	10.80	8.50	-38.04	-13.00	-25.04	H
3386.00	-31.49	12.50	11.90	-30.89	-13.00	-17.89	H
1693.40	-44.64	9.60	4.77	-39.81	-13.00	-26.81	V
2539.55	-44.92	10.80	8.50	-42.62	-13.00	-29.62	V
3386.09	-43.53	12.50	11.90	-42.93	-13.00	-29.93	V

Note: (1)Below 30MHz no Spurious found is the worst condition.

(2)Above 3GHz amplitude of spurious emissions which are attenuated by more than 20dB below the permissible value has.

UMTS band II(30-20000)MHz

WCDMA Band II: (30-20000)MHz							
The Worst Test Results for Channel 9262/1852.4MHz							
Frequency(MHz)	S G.Lev (dBm)	Ant(dBi)	Loss	PMea	Limit	Margin	Polarity
				(dBm)	(dBm)	(dB)	
3704.49	-34.51	12.60	12.93	-34.84	-13.00	-21.84	H
5557.31	-34.12	13.10	17.11	-38.13	-13.00	-25.13	H
7409.95	-32.57	11.50	22.20	-43.27	-13.00	-30.27	H
3704.37	-35.72	12.60	12.93	-36.05	-13.00	-23.05	V
5557.45	-35.20	13.10	17.11	-39.21	-13.00	-26.21	V
7409.66	-33.07	11.50	22.20	-43.77	-13.00	-30.77	V
The Worst Test Results for Channel 9400/1880MHz							
Frequency(MHz)	S G.Lev (dBm)	Ant(dBi)	Loss	PMea	Limit	Margin	Polarity
				(dBm)	(dBm)	(dB)	
3760.04	-33.62	12.60	12.93	-33.95	-13.00	-20.95	H
5640.02	-34.35	13.10	17.11	-38.36	-13.00	-25.36	H
7520.26	-32.45	11.50	22.20	-43.15	-13.00	-30.15	H
3759.99	-34.69	12.60	12.93	-35.02	-13.00	-22.02	V
5640.05	-34.45	13.10	17.11	-38.46	-13.00	-25.46	V
7520.14	-33.12	11.50	22.20	-43.82	-13.00	-30.82	V
The Worst Test Results for Channel 9538/1907.6MHz							
Frequency(MHz)	S G.Lev (dBm)	Ant(dBi)	Loss	PMea	Limit	Margin	Polarity
				(dBm)	(dBm)	(dB)	
3815.48	-34.42	12.60	12.93	-34.75	-13.00	-21.75	H
5722.33	-34.33	13.10	17.11	-38.34	-13.00	-25.34	H
7629.88	-33.60	11.50	22.20	-44.30	-13.00	-31.30	H
3815.55	-35.25	12.60	12.93	-35.58	-13.00	-22.58	V
5722.40	-34.00	13.10	17.11	-38.01	-13.00	-25.01	V
7629.97	-32.03	11.50	22.20	-42.73	-13.00	-29.73	V

Note: (1)Below 30MHz no Spurious found is the worst condition.

(2)Above 6GHz amplitude of spurious emissions which are attenuated by more than 20dB below the permissible value has.

APPENDIX B PHOTOS OF TEST SETUP
RADIATED SPURIOUS EMISSION



*****END OF THE REPORT*****