

TEST REPORT
No.: 6-0608-14-1-4a

According to:
FCC Regulations
Part 22, Part 24, Part 15.209

IC-Regulations
RSS-132, RSS-133, RSS-Gen

for

Telit Communications S.p.A.

UE866-N3G
3G module

FCC-ID: RI7UE866N3

IC: 5131A-UE866N3
PMN: UE866-N3G
HVIN: OH0







Laboratory Accreditation and Listings			
 Deutsche Akkreditierungsstelle D-PL-12047-01-01	 MRA US-EU 0003	 Industry Canada Reg. No.: 3462D-1 Reg. No.: 3462D-2 Reg. No.: 3462D-3	 Voluntary Controls for Electromagnetic Emissions Reg. No.: R-2666 C-2914, T-1967, G-301
 AUTHORIZED RF LABORATORY	 LAB CODE 20011130-00		
accredited according to DIN EN ISO/IEC 17025			
<p>CETECOM GmbH Laboratory Radio Communications & Electromagnetic Compatibility Im Teelbruch 116 • 45219 Essen • Germany Registered in Essen, Germany, Reg. No.: HRB Essen 8984 Tel.: + 49 (0) 20 54 / 95 19-954 • Fax: + 49 (0) 20 54 / 95 19-964 E-mail: info@cetecom.com • Internet: www.cetecom.com</p>			

Table of contents

1. SUMMARY OF TEST RESULTS	3
1.1. Tests overview of US CFR Title 47 Part 22/24 and Canada IC (RSS) Standards	3
2. ADMINISTRATIVE DATA	5
2.1. Identification of the testing laboratory	5
2.2. Test location	5
2.3. Organizational items	5
2.4. Applicant’s details	5
2.5. Manufacturer’s details	5
3. EQUIPMENT UNDER TEST (EUT)	6
3.1. TECHNICAL DATA OF MAIN EUT DECLARED BY APPLICANT	6
3.2. EUT: Type, S/N etc. and short descriptions used in this test report	7
3.3. Auxiliary Equipment (AE): Type, S/N etc. and short descriptions	7
3.4. EUT set-ups	7
3.5. EUT operating modes	8
3.6. Test system set-up for conducted measurements on antenna port	9
3.7. Test system set-up for radiated magnetic field measurements below 30 MHz	10
3.8. Test system set-up for radiated spurious emission measurements	11
4. MEASUREMENTS	12
4.1. RF-Parameter - RF Peak power output radiated	12
4.2. RF-Parameter - Radiated out of Band RF emissions and Band Edge	14
4.3. RF-Parameter - RF Peak power output conducted.....	17
4.4. RF-Parameter - Occupied bandwidth and emission bandwidth	19
4.5. RF-Parameter - Conducted out of Band RF emissions and Band Edge	21
4.6. RF-Parameter - Frequency stability on temperature and voltage variations	23
4.7. General Limit - Radiated field strength emissions below 30 MHz	28
5. ACCREDITATION DETAILS OF CETECOM’S LABORATORIES AND TEST SITES	30
6. INSTRUMENTS AND ANCILLARY	31
6.1. Used equipment “CTC”	31
7. VERSIONS OF TEST REPORTS (CHANGE HISTORY)	34

Table of annex

Total pages

Annex 1: Photographs of EUT - separate document TR6-0608-14-1-4a-A1	5
Annex 2: Test set-up photographs - separate document TR6-0608-14-1-4a -A2	4
Annex 3: Measurement diagrams - separate document TR6-0608-14-1-4a -A3	46
Annex 4: Internal EUT photographs - to be supplied by applicant	--

The listed attachments are an integral part of this report.

1. Summary of test results

The test results apply exclusively to the test samples as presented in this Report. The CETECOM GmbH does not assume responsibility for any conclusions and generalizations taken in conjunction with other specimens or samples of the type of the item presented to tests. Also we refer on special conditions which the applicant should fulfill according §2.927 to §2.948, special focus regarding modification of the equipment and availability of sample equipment for market surveillance tests.

The Equipment Under Test (in this report, hereinafter referred as EUT) supports radiofrequency technologies.

Following tests have been performed to show compliance with applicable FCC Part 2, Part 22, Subpart H, Part 24, Subpart E (Broadband PCS) and Part 27, Subpart C of the FCC CFR Title 47 Rules, Edition 4th November 2014 and Canadian RSS-132 Issue 3, RSS-133 Issue 6 and RSS-Gen Issue 4 standards.

1.1. Tests overview of US CFR Title 47 Part 22/24 and Canada IC (RSS) Standards

No. of Diagram group	Test case	Port	References & Limits			EUT set-up	EUT op-mode	Result
			FCC Standard	RSS Section	Test limit			
1	AC-Power Lines Emissions Conducted (0,15 - 30 MHz)	AC-Power lines (conducted)	§15.207	RSS-Gen, Issue 4: Chapter 8.8	§15.207 limits IC: Table 3	--	--	Remark 1.)
2	General field strength emissions (9 kHz - 30 MHz)	Cabinet + inter-connecting cables (radiated)	§15.209(a)	RSS-Gen, Issue 4: Chapter 8.9, Table 5	2400/F(kHz) μ V/m 24000/F(kHz) μ V/m 30 μ V/m	1	1+2	passed
7	RF-Power (ERP/EIRP)		§2.1046 §22.913(a)(2)	RSS-132: 5.4 SRSP-503: 5.1.3	< 11.5 Watt (EIRP)	1	1+2	passed
8	Spurious emissions		§24.232(c)	RSS-133:4.1/6.4 SRSP-510: 5.1.2	< 2 Watt (EIRP)	1	1+2	passed
9	Band-Edge compliance		§2.1053(a) §2.1057 §22.917(a)(b) §24.238(a)(b)	RSS-132: 5.5(i)(ii) RSS-133: 6.5.1(i)(ii)	Required attenuation below P(dBW): 43+10log(P) dBc	1	1+2	passed

No. of Diagram group	Test case		Port	References & Limits			EUT set-up	EUT op-mode	Result
				FCC Standard	RSS Section	Test limit			
30	RF Power		Antenna terminal <small>(conducted)</small>	§2.1046	RSS-132: 5.4 SRSP-503: 5.1.3 RSS-133:4.1/6.4 SRSP-510: 5.1.2	< 11.5 Watt (EIRP) < 2 Watt (EIRP)	2	1+2	passed
34	26dB Emission bandwidth			§2.202 §2.1049 §22.917(a) §24.238(a)	RSS-Gen: 4.6.1	99% Power	2	1+2	passed
35	99% Occupied bandwidth						2	1+2	
36	Spurious emissions			§2.1051 §2.1057	RSS-132: 5.5(i)(ii)	Required attenuation below P(dBW): 43+10log(P) dBc	2	1+2	passed
37	Band-Edge compliance			§22.917(a)(b) §24.238(a)(b)	RSS-133: 6.5.1(i)(ii)		2	1+2	
38	Frequency stability	Temperature variations		§22.355, table C-1	RSS-132: 5.3	< ±2.5ppm	2	1+2	passed
		Voltage variations		§24.235 §2.1055(a)(2)	RSS-133: 6.3	<±2.5 ppm	3	1+2	passed

Remarks:

- 1.) EUT is DC powered only, test to be performed on OEM - AC/DC Power implementation, if applicable

Attestation:

I declare that all measurements were performed by me or under my supervision and that all measurements have been performed and are correct to my best knowledge and belief to Industry Canada standards. All requirements as shown in above table are met in accordance with enumerated standards.

Dipl.-Ing. Rachid Acharkaoui
Responsible for test section

GmbH
Im Tealbruch 116
45219 Essen
Tel.: + 49 (0) 20 54 / 95 19 - 0
Fax: + 49 (0) 20 54 / 95 19 - 397

Dipl.Ing. C. Lorenz
Responsible for test report

2. Administrative Data

2.1. Identification of the testing laboratory

Company name:	CETECOM GmbH
Address:	Im Teelbruch 116 45219 Essen - Kettwig Germany
Responsible for testing laboratory:	Dipl.-Ing. Niels Jeß
Deputy:	Dipl.-Ing. Rachid Acharkaoui

2.2. Test location

2.2.1. Test laboratory “CTC”

Company name:	see chapter 2.1. Identification of the testing laboratory
---------------	---

2.3. Organizational items

Project leader	Dipl.-Ing N. Perez
Responsible for test report	Dipl.Ing. C. Lorenz
Receipt of EUT:	2015-02-09
Date(s) of test:	2015-02-09, 2015-03-31
Date of report:	2015-04-09

Version of template:	13.02

2.4. Applicant’s details

Applicant’s name:	Telit Communications S.p.A.
Address:	Via Stazione di Prosecco, 5/B 34010 SGONICO Italy
Contact person:	Farbrizio Druscovich

2.5. Manufacturer’s details

Manufacturer’s name:	please see Applicant's details
Address:	please see Applicant's details

3. Equipment under test (EUT)

3.1. TECHNICAL DATA OF MAIN EUT DECLARED BY APPLICANT

W-CDMA

TX-frequency range		FDD Band 2: 1852.4–1907.6 MHz (Uplink), 1930-1990 MHz (Downlink) FDD Band 5: 826.4-846.6 MHz (Uplink), 869-894 MHz (Downlink)	
Type of modulation		FDD-Mode Release99: QPSK FDD Mode Release 5+6: 16QAM additional	
Number of channels		FDD Band 2: UARFCN range 9262 – 9400 – 9538 FDD Band 5: UARFCN range 4132 – 4183 – 4233	
UMTS-HSPA connectivity		<input checked="" type="checkbox"/> Uplink speed: 5.76 Mb/s (category 6) <input type="checkbox"/> Uplink speed:	
Test Channels	Band II	Channel 9262/ 9400/ 9538	
	Band V	Channel 4132/ 4183/ 4233	
Emission designator(s)		Band II: 4M17F9W Band V: 4M17F9W	
Antenna Gain Tx (main)		<input checked="" type="checkbox"/> Value: 2.14 dBi according data sheet <input type="checkbox"/> No information from customer	
MAX PEAK Output Power: Radiated		FDD-Mode 2	27.47 dBm (PK)
		FDD-Mode 5	20.59 dBm (PK)
MAX PEAK Output Power: Conducted		FDD-Mode 2	22.54 dBm (PK)
		FDD-Mode 5	22.37 dBm (PK)
Power supply		<input checked="" type="checkbox"/> 3.8 V DC	
Special EMI components		--	
EUT sample type		<input type="checkbox"/> Production	<input checked="" type="checkbox"/> Pre-Production
		<input type="checkbox"/> Engineering	

3.2. EUT: Type, S/N etc. and short descriptions used in this test report

Short description*)	EUT	Type	S/N serial number	HW hardware status	SW software status
EUT A	UE866-N3G	3G module	IMEI 359335059003 548	0	12.00.806
EUT B	UE866-N3G	3G module	IMEI 359335059002 615	0	12.00.806

*) EUT short description is used to simplify the identification of the EUT in this test report.

3.3. Auxiliary Equipment (AE): Type, S/N etc. and short descriptions

AE short description *)	Auxiliary Equipment	Type	S/N serial number	HW hardware status	SW software status
AE 1	Bearer Board #1	-	1634900047	-	-
AE 2	Bearer Board #2	-	113920140091	-	-
AE 3	Ktec AC/DC charger	KSAS0151200125D5	--	--	--
AE 4	USB cable	Highspeed USB 2.0	--	--	--
AE 5	Antenna	T-AT314-BU	--	900-1800- UMTS Cable RG 174mm. 2500	--

*) AE short description is used to simplify the identification of the auxiliary equipment in this test report.

3.4. EUT set-ups

EUT set-up no. *)	Combination of EUT and AE	Remarks
set. 1	EUT A + AE 1 + AE 2 + AE 3 + AE 4 + AE 5 + AE 5	Used for radiated tests
set. 2	EUT A + AE 1 + AE 2	Used for conducted tests
set. 3	EUT B + AE 1 + AE 2	Used for conducted tests: frequency error under voltage variations

*) EUT set-up no. is used to simplify the identification of the EUT set-up in this test report.

3.5. EUT operating modes

3.5.1. EUT operating modes W-CDMA

EUT operating mode no. *)	Description of operating modes:	Additional information:
op. 1	FDD-Band 2 12.2 kbps RMC	A communication link is established between the mobile station (UE) and the test simulator. The transmitter is operated on its maximum rated output power class: 24dBm nominal. The input signal to the receiver is modulated with normal test modulation. The wanted RF input signal level to the receiver of the mobile station is set to a level to provide a stable communication link according Table E5.1/Table E5.1A as described in 3GPP TS34.121, Annex E.
op. 2	FDD-Band 5 12.2 kbps RMC	A communication link is established between the mobile station (UE) and the test simulator. The transmitter is operated on its maximum rated output power class: 24dBm nominal. The input signal to the receiver is modulated with normal test modulation. The wanted RF input signal level to the receiver of the mobile station is set to a level to provide a stable communication link according Table E5.1/Table E5.1A as described in 3GPP TS34.121, Annex E.

*) EUT operating mode no. is used to simplify the test report.

3.6. Test system set-up for conducted measurements on antenna port

Specification: ANSI C63.10 - 2013

General Description: The EUT's RF-signal is coupled out by a suitable antenna coupling connector (1). The signal is first attenuated (2) before it is 0° divided by a power divider (3). One of the signal path is connected to the radio communication tester (4), other branch is connected to the spectrum – analyzer (5). The specific attenuation losses for both signal paths/branches are determined prior to the measurement within a set-up calibration. These are then taken into account by correcting the measurement readings on the spectrum-analyzer.

Schematic:

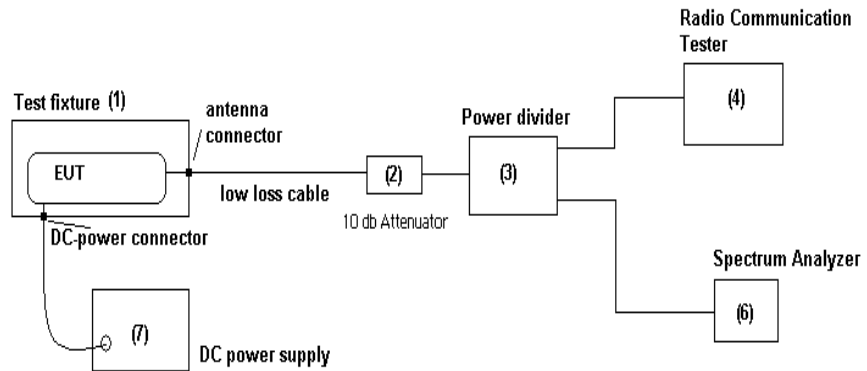

Schematic:

Following modified test set-up schematic apply for tests performed inside the climatic chamber: (Frequency stability)

In case **an external connector is available (test fixture)**, following set-up is used for measurements.

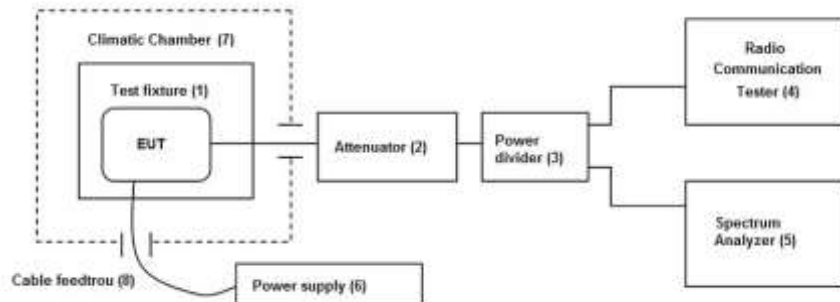

Testing method: ANSI C63.10 - 2013

3.7. Test system set-up for radiated magnetic field measurements below 30 MHz

Specification: ANSI C63.10-2013 chapter 6.4.4 (§6.4.4.2)

General Description: Evaluating the radiated field emissions are done first by an exploratory emission measurement and a final measurement for most critical frequencies determined.

The loop antenna was placed at 1 m height above ground plane and 3 m measurement distance from set-up for investigations. Because of reduced measurement distance, correction data were applied, as stated in chapter “General Limit - Radiated field strength emissions below 30 MHz“. The tests are performed in the semi anechoic room recognized by the regulatory commission.

Schematic:

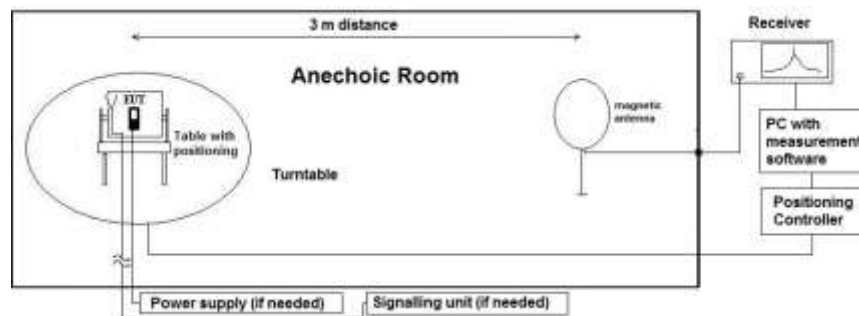

Testing method:

Exploratory, preliminary measurement

The EUT and its associated accessories are placed on a non-conductive position manipulator (tipping device) of 0.8 m height which is placed on the turntable. By rotating the turntable (step 90°, range 0°to 360°) and the EUT itself either on 3-orthogonal axis (portable equipment) or 2-orthogonal axis (defined operational position of EUT), the emission spectrum was recorded. The loop antenna was moved at least to 2-perpendicular axes (antenna vector in direction of EUT and parallel to EUT) in order to maximize the emissions. The results are documented in a diagram. Critical frequencies (low margin to limit) are saved within a data reduction table for further investigations. If various operating modes are supported, further investigations are made to find the worst-case. Also the interconnection cables and equipment position were varied in order to maximize the emissions.

Final measurement on critical frequencies

Based on the exploratory measurements, the most critical frequencies are re-measured by maintaining the EUT’s worst-case operation mode, cable position, etc.

First a frequency zoom around the critical frequency is done to locate the frequency more precisely. After this step, for all identified critical frequencies, the maximum peak was determined.

Following parameters were varied: the turntable angle continuously in the range 0 to 360 degree, the EUT itself either over 3-orthogonal axis (not defined usage position) or 2-orthogonal axis (defined usage position).

On the determined worst-case position, a final measurement with necessary bandwidth and detector according standard has been carried out.

Formula:

$$E_C = E_R + AF + C_L + D_F - G_A$$

$$M = L_T - E_C$$

- AF = Antenna factor
- C_L = Cable loss
- D_F = Distance correction factor
- E_C = Electrical field – corrected value
- E_R = Receiver reading
- G_A = Gain of pre-amplifier (if used)
- L_T = Limit
- M = Margin

All units are dB-units, positive margin means value is below limit.

Distance correction:

Reference for applied correction (extrapolating) factors due to reduced measurement distance: ANSI C63.10:2013, §6.4.4.2 - Equations (2) + (3) + (4)

3.8. Test system set-up for radiated spurious emission measurements

Specification: ANSI C63.10-2013 chapter 6.6.3.3 & 6.6.4

General Description: Evaluating the emissions have to be done first by an exploratory emissions measurement and a final measurement for most critical frequencies. The tests are performed in a CISPR 16-1-4:2010 compliant fully anechoic room (FAR) recognized by the regulatory commission. The measurement distance was set to 3 meter for frequencies up to 18 GHz and 2 meter above 18 GHz. A logarithmic periodic antenna is used for the frequency range 30 MHz to 1 GHz. Horn antennas are used for frequency range 1 GHz to 40 GHz. The EUT is aligned within 3 dB beam width of the measurement antenna with three orthogonal axis measurements on the EUT.

Schematic:

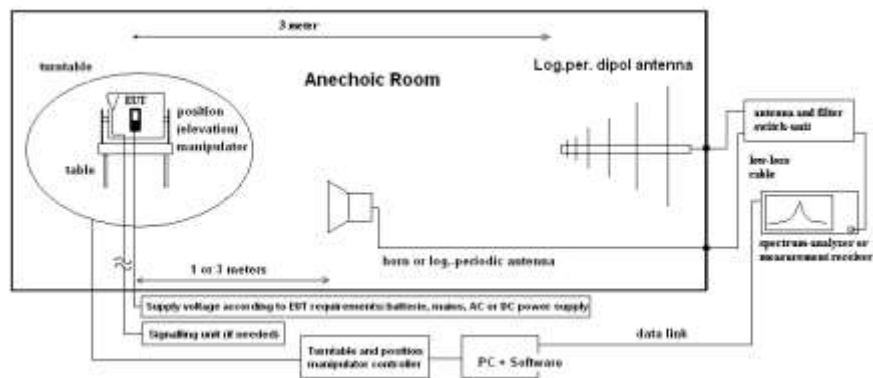

Testing method:

Exploratory, preliminary measurements

The EUT and its associated accessories are placed on a non-conductive position manipulator (tipping device) of 1.50 m height which is placed on the turntable. By rotating the turntable (range 0° to 360°, step 45°) and the EUT itself on 3-orthogonal axis (the emission spectrum and it's characteristics was recorded with an EMI-receiver, broadband antenna and software.

The measurements are performed in horizontal and vertical polarization of the measurement antennas. The results are documented in a diagram. Critical frequencies (low margin to limit) are saved within a table for further investigations. If various operating modes are supported, further investigations are made to find the worst-case of them. Also the interconnection cables and equipment position were varied in order to maximize the emissions.

Final measurement on critical frequencies

Based on the exploratory measurements, the most critical frequencies are re-measured by maintaining the EUT's worst-case operation mode, cable position, etc.

First a frequency zoom around the critical frequency is done to locate the frequency more precisely. After this step, for all identified critical frequencies, the maximum peak was determined.

Following parameters were varied: the turntable angle continuously in the range 0 to 360 degree, the EUT itself over 3-orthogonal axis and the height for EUT with large dimensions.

On the determined worst-case position, a final measurement with necessary bandwidth and detector according standard has been carried out.

The readings on the spectrum analyzer are corrected with conversion value between field strength and E(I)RP, so the readings shown are equivalent to ERP/EIRP values. Critical measurements near the limit are re-measured with a substitution method accord. ANSI/TIA/EIA 603 C/D

Formula:

$$E_C = E_R + AF + C_L + D_F - G_A \quad (1)$$

$$E_{C_{E(I)RP}} = E_C - 95.2 \text{ dB}$$

$$M = L_T - E_{C_{E(I)RP}}$$

E_C = Electrical field – corrected value

E_R = Receiver reading

M = Margin

L_T = Limit

AF = Antenna factor

C_L = Cable loss

D_F = Distance correction factor (if used)

G_A = Gain of pre-amplifier (if used)

$E_{C_{E(I)RP}}$ = Electrical field corrected for E(I)RP

All units are dB-units, positive margin means value is below limit.

4. Measurements

4.1. RF-Parameter - RF Peak power output radiated

4.1.1. Test location and equipment (for reference numbers please see chapter 'List of test equipment')

test location	<input checked="" type="checkbox"/> CETECOM Essen (Chapter. 2.2.1)	<input type="checkbox"/> Please see Chapter. 2.2.2	<input type="checkbox"/> Please see Chapter. 2.2.3
test site	<input type="checkbox"/> 441 EMI SAR	<input type="checkbox"/> 487 SAR NSA	<input checked="" type="checkbox"/> 443 FAR
receiver	<input type="checkbox"/> 377 ESCS30	<input type="checkbox"/> 001 ESS	<input type="checkbox"/> 489 ESU 40
spectr. analys.	<input type="checkbox"/> 584 FSU	<input type="checkbox"/> 120 FSEM	<input checked="" type="checkbox"/> 264 FSEK
antenna	<input type="checkbox"/> 574 BTA-L	<input type="checkbox"/> 133 EMCO3115	<input type="checkbox"/> 302 BBHA9170
signalling	<input type="checkbox"/> 392 MT8820A	<input type="checkbox"/> 436 CMU	<input checked="" type="checkbox"/> 546 CMU
otherwise	<input type="checkbox"/> 400 FTC40x15E	<input type="checkbox"/> 401 FTC40x15E	<input type="checkbox"/> 110 USB LWL
DC power	<input type="checkbox"/> 611 E3636A	<input type="checkbox"/> 463 HP3245A	<input type="checkbox"/> 459 EA 2032-50
line voltage	<input type="checkbox"/> 230 V 50 Hz via public mains	<input checked="" type="checkbox"/> 060 120 V/ 60 Hz via PAS 5000	<input type="checkbox"/> 620 ESU 26
			<input type="checkbox"/> 482 Filter Matrix
			<input type="checkbox"/> 378 RadiSense
			<input type="checkbox"/> 494 AG6632A
			<input type="checkbox"/> 498 NGPE 40

4.1.2. Requirements and limits

FCC	§2.1046(a), §22.913(a)(2), § 24.232(c)
IC	RSS-132:5.4 + SRSP 503:5.1.3 for FDD Band 5 RSS-133:4.1/6.4 + SRSP-510:5.1.2 for FDD Band 2 PAR PK-AV ≤ 13 dB
Limits	Maximum Power Output of the wireless device should be determined while measured radiated E(DRP). Limit FDD Band 5: 7 Watt ERP (38.4 dBm) Limit FDD Band 2: 2 Watt EIRP (33.0 dBm)

4.1.3. Test condition and test set-up

link to test system (if used):	<input checked="" type="checkbox"/> air link	<input type="checkbox"/> cable connection	<input type="checkbox"/>
EUT-grounding	<input checked="" type="checkbox"/> none	<input type="checkbox"/> with power supply	<input type="checkbox"/> additional connection
Equipment set up	<input checked="" type="checkbox"/> table top	<input type="checkbox"/> floor standing	
Climatic conditions	Temperature: (22±3°C)	Rel. humidity: (40±20)%	
Test system set-up	Please see chapter "Test system set-up for radiated spurious emission measurements up to 20 GHz"		
Spectrum Analyzer Settings	Parameter: Scan Mode Span RBW VBW Sweep time Sweep mode Detector	Spectrum analyser mode 100 MHz 10 MHz 10 MHz Coupled repetitive Peak	
Measurement method	<p>The measurements were performed by using the substitution method (ANSI/TIA/EIA 603C/D) with a spectrum-analyzer. This method can be described like follows:</p> <ol style="list-style-type: none"> choosing of suitable spectrum-analyzer settings for performing the measurements. This settings of the spectrum analyzer must be maintained for both stages of the measurements: EUT emission measurements and also for measurements of the substituted level. The maximum level of the peak power was recorded, while the emissions were maximized by rotating the EUT in three orthogonal axes, which was situated on a non-conductive turntable of 1.55 m height ($P_{MEAS,1}$). This was performed for both measuring antenna polarisations (vertical/horizontal), the maximum of both values is used for further measurements and final substitution ($P_{MEAS,1,MAX}$). As the maximum emission is recorded, the EUT is replaced by a frequency dependant suitable antenna, which is connected to a RF-signal generator, which is transmitting on the determined worst-case frequency as determined in step 2. The RF-signal level of the signal generator is adjusted as long the same worst-case level determined first step is measured at the spectrum analyzer ($P_{SMHU}=P_{MEAS,1,MAX}$) Then the RF-signal cable is disconnected from the antenna and connected to a power-level meter. The level is determined ($P_{MEAS,2}$). The final result is calculated by adding the ERP/EIRP gain of the antenna which substitutes the EUT. $P_{EUT,SUBST} = P_{MEAS,2} + G_{ANTENNA}$ 		
EUT settings	A call was established on highest power transmit conditions in RMC99 mode. The measurements were made at the low, middle and high carrier frequencies of each of the supported operating band. Choosing three TX-carrier frequencies of the wireless device, should be sufficient to demonstrate compliance.		

4.1.4. Results

EUT				Set-up 2, Op.Mode 1				
Operating Mode	Channel			Peak Output Power [dBm]			Antenna Polarisation for maximum Power	Result
	Range	No.	Nominal frequency [MHz]	PK	AV			
FDD Band 2	Low	9262	1852.4	25.72	1.)	EIRP-Value	H	passed
	Middle	9400	1880.0	26.48				
	High	9538	1907.6	27.47				

Remark: 1.) see conducted measurements for PAR factor

EUT				Set-up 2, Op.Mode 2				
Operating Mode	Channel			Peak Output Power [dBm]			Antenna Polarisation for maximum Power	Result
	Range	No.	Nominal frequency [MHz]	PK	AV			
FDD Band 5	Low	4132	826.4	17.27	1.)	ERP-Value	H	passed
	Middle	4183	836.6	14.97				
	High	4233	846.6	20.59				

Remark: : 1.) see conducted measurements for PAR factor

4.2. RF-Parameter - Radiated out of Band RF emissions and Band Edge

4.2.1. Test location and equipments (for reference numbers please see chapter 'List of test equipment')

test location	<input checked="" type="checkbox"/> CETECOM Essen (Chapter. 2.2.1)	<input type="checkbox"/> Please see Chapter. 2.2.2	<input type="checkbox"/> Please see Chapter. 2.2.3
test site	<input type="checkbox"/> 441 EMI SAR	<input type="checkbox"/> 487 SAR NSA	<input checked="" type="checkbox"/> 443 FAR
receiver	<input type="checkbox"/> 377 ESCS30	<input type="checkbox"/> 001 ESS	<input type="checkbox"/> 489 ESU 40
spectr. analys.	<input type="checkbox"/> 584 FSU	<input type="checkbox"/> 120 FSEM	<input checked="" type="checkbox"/> 264 FSEK
antenna	<input checked="" type="checkbox"/> 439 HL 562	<input checked="" type="checkbox"/> 549 HL 025	<input checked="" type="checkbox"/> 302 BBHA9170
signaling	<input type="checkbox"/> 017 CMD 65	<input type="checkbox"/> 323 CMD 55	<input type="checkbox"/> 340 CMD 55
signaling	<input type="checkbox"/> 392 MT8820A	<input checked="" type="checkbox"/> 546 CMU	<input type="checkbox"/> 547 CMU
power supply	<input type="checkbox"/> 611 E3636A	<input type="checkbox"/> 457 EA 3013A	<input type="checkbox"/> 459 EA 2032-50
otherwise	<input type="checkbox"/> 529 6dB divider	<input type="checkbox"/> 530 6dB Att.	<input type="checkbox"/> 110 USB LWL
line voltage	<input type="checkbox"/> 230 V 50 Hz via public mains		<input checked="" type="checkbox"/> 060 110 V/ 60 Hz via PAS 5000

4.2.2. Requirements and limits

FCC	General: §2.1053(a) , §2.1057(a) <input checked="" type="checkbox"/> FDD Band 5: Part 22: §22.917(a)(b) <input checked="" type="checkbox"/> FDD Band 2: Part 24: §24.238(a)(b)
IC	<input checked="" type="checkbox"/> FDD Band 5: RSS-132, Issue 3: 5.5(i)(ii) <input checked="" type="checkbox"/> FDD Band 2: RSS-133, Issue 6: 6.5.1(i)(ii)
Limit	„the power of emissions shall be attenuated below the transmitter output power (p) by at least 43+10Log(P) dB“ -> Resulting limits for all power levels of the Mobile Phone: -13dBm

4.2.3. Test condition and test set-up

link to test system (if used):	<input checked="" type="checkbox"/> air link	<input type="checkbox"/> cable connection	<input type="checkbox"/>
EUT-grounding	<input checked="" type="checkbox"/> none	<input type="checkbox"/> with power supply	<input type="checkbox"/> additional connection
Equipment set up	<input checked="" type="checkbox"/> table top		<input type="checkbox"/> floor standing
Climatic conditions	Temperature: (22±3°C)		Rel. humidity: (40±20)%
Test system set-up	Please see chapter “Test system set-up for radiated spurious emission measurements up to 20 GHz”		
Measurement method	The spectrum was scanned from 9 kHz to the 10th harmonic of the highest frequency generated within the equipment. A PEAK detector was used except measurements near the block-edge where a AVERAGE detector applied for critical measurements. According chapter 4.2		
EUT settings	A call was established on highest power transmit conditions in RMC99 mode. The measurements were made at the low, middle and high carrier frequencies of each of the supported operating band. Choosing three TX-carrier frequencies of the wireless device, should be sufficient to demonstrate compliance.		

Spectrum-Analyzer settings for FDD band 2

	Start freq. MHz	Stop freq. MHz	R-BW MHz	V-BW MHz	Sweep time sec.	Att. [dB]	Detector
Sweep 1 (subrange 1)	30	1000	1	1	10	10	MaxH-PK
Sweep 1 (subrange 2)	1000	2800	1	1	15	0	MaxH-PK
Sweep 1 (subrange 3)	2800	20000	1	1	60	10	MaxH-PK
Sweep 2a (Band-Edge)	1849	1850	0.05	0.5	30	35	MaxH-PK
Sweep 2b (Band-Edge)	1849	1850	0.05	0.5	30	35	MaxH-AV
Sweep 3a (Band-Edge)	1910	1911	0.05	0.5	30	35	MaxH-PK
Sweep 3b (Band-Edge)	1910	1911	0.05	0.5	30	35	MaxH-AV

Spectrum-analyzer settings for FDD Band 5

	Start freq. MHz	Stop freq. MHz	R-BW MHz	V-BW MHz	Sweep time sec.	Att.	Detector
Sweep 1 (subrange 1)	30	1000	1	1	10	10	MaxH-PK
Sweep 1 (subrange 2)	1000	2800	1	1	15	0	MaxH-PK
Sweep 1 (subrange 3)	2800	12000	1	1	160	10	MaxH-PK
Sweep 2a (Band-Edge)	823	824	0.05	0.5	30	35	MaxH-PK
Sweep 2b (Band-Edge)	823	824	0.05	0.5	30	35	MaxH-AV
Sweep 3a (Band-Edge)	850	851	0.05	0.5	30	35	MaxH-PK
Sweep 3b (Band-Edge)	850	851	0.05	0.5	30	35	MaxH-AV

4.2.4. Results

The results are presented below in summary form only. For more information please see each diagram enclosed in annex 4.

4.2.4.1. FDD Band 2: Op. Mode 1, Set-up 1

Diagram no.	Carrier Channel		Frequency range	OP-mode no.	Remark	Used detector			Result
	Range	No.				PK	AV	QP	
8.04	Low	9262	30 MHz to 20 GHz	1	Carrier visible on diagram. Not relevant for results	<input checked="" type="checkbox"/>	<input type="checkbox"/>	<input type="checkbox"/>	passed
9.03	Low		1849 – 1850 MHz		Band Edge Compliance	<input checked="" type="checkbox"/>	<input type="checkbox"/>	<input type="checkbox"/>	passed
8.05	Middle	9400	30 MHz to 20 GHz		Carrier visible on diagram. Not relevant for results	<input checked="" type="checkbox"/>	<input type="checkbox"/>	<input type="checkbox"/>	passed
8.06	High	9538	30 MHz to 20 GHz		Carrier visible on diagram. Not relevant for results	<input checked="" type="checkbox"/>	<input type="checkbox"/>	<input type="checkbox"/>	passed
9.04	High		1910 – 1911 MHz		Band-Edge compliance:	<input checked="" type="checkbox"/>	<input checked="" type="checkbox"/>	<input type="checkbox"/>	passed

Remark: --

4.2.4.2. FDD Band 5: Op. Mode 2, Set-up 1

Diagram no.	Carrier Channel		Frequency range	OP-mode no.	Remark	Used detector			Result
	Range	No.				PK	AV	QP	
8.01	Low	4132	30 MHz to 12 GHz	2	Carrier visible on diagram. Not relevant for results	<input checked="" type="checkbox"/>	<input type="checkbox"/>	<input type="checkbox"/>	passed
9.01	Low		823 – 824 MHz		Band Edge Compliance	<input checked="" type="checkbox"/>	<input type="checkbox"/>	<input type="checkbox"/>	passed
8.02	Middle	4183	30 MHz to 12 GHz		Carrier visible on diagram. Not relevant for results	<input checked="" type="checkbox"/>	<input type="checkbox"/>	<input type="checkbox"/>	passed
8.03	High	4233	30 MHz to 12 GHz		Carrier visible on diagram. Not relevant for results	<input checked="" type="checkbox"/>	<input type="checkbox"/>	<input type="checkbox"/>	passed
9.02	High		849 – 850 MHz		Band-Edge compliance	<input checked="" type="checkbox"/>	<input type="checkbox"/>	<input type="checkbox"/>	passed

Remark: --

4.3. RF-Parameter - RF Peak power output conducted

4.3.1. Test location and equipments (for reference numbers please see chapter 'List of test equipment')

test location	<input checked="" type="checkbox"/> CETECOM Essen (Chapter. 2.2.1)	<input type="checkbox"/> Please see Chapter. 2.2.2				
test site	<input type="checkbox"/> 347 Radio.lab. 1	<input type="checkbox"/> Radio.lab. 2	<input checked="" type="checkbox"/> 420 OTA 1			
spectr. analys.	<input checked="" type="checkbox"/> 584 FSU	<input type="checkbox"/> 489 ESU 40	<input type="checkbox"/> 264 FSEK	<input type="checkbox"/> 620 ESU 26		
signaling	<input type="checkbox"/> 392 MT8820A	<input checked="" type="checkbox"/> 436 CMU	<input type="checkbox"/> 547 CMU	<input type="checkbox"/> 460 CMU		
otherwise	<input type="checkbox"/> 400 FTC40x15E	<input type="checkbox"/> 401 FTC40x15E	<input type="checkbox"/> 110 USB LWL	<input type="checkbox"/> 482 Filter Matrix	<input type="checkbox"/> 378 RadiSense	
DC power	<input checked="" type="checkbox"/> 611 E3636A	<input type="checkbox"/> 463 HP3245A	<input type="checkbox"/> 459 EA 2032-50	<input type="checkbox"/> 268 EA- 3050	<input type="checkbox"/> 494 AG6632A	<input type="checkbox"/> 498 NGPE 40
otherwise	<input type="checkbox"/> 331 HC 4055	<input type="checkbox"/> 248 6 dB Att.	<input type="checkbox"/> 529 Power div.	<input checked="" type="checkbox"/> - cable OTA20		
line voltage	<input type="checkbox"/> 230 V 50 Hz via public mains		<input type="checkbox"/> 060 110 V/ 60 Hz via PAS 5000			

4.3.2. Requirements and limits

FCC	<input checked="" type="checkbox"/> §2.1046 <input checked="" type="checkbox"/> §22.913(a)(2) <input checked="" type="checkbox"/> § 24.232(c)
IC	<input checked="" type="checkbox"/> RSS-132: 5.4 + SRSP 503:5.1.3 <input checked="" type="checkbox"/> RSS-133: 4.1/6.4 + SRSP-510:5.1.2
Limits	Maximum Power Output of the wireless device should be determined while measured radiated E(IRP) <input checked="" type="checkbox"/> Limit FDD Band 5: 7 Watt ERP (38.4 dBm) <input checked="" type="checkbox"/> Limit FDD Band 2: 2 Watt EIRP (33.0 dBm)

4.3.3. Test condition and test set-up

Climatic conditions	Temperature: (22±3°C)	Rel. humidity: (40±20)%
Test system set-up	Please see chapter "Test system set-up for conducted measurements on antenna port" ANRITSU	
Measurement method	<p>The measurements were performed with the integrated power measurement function of the „radio communication tester CMU200 from Rohde&Schwarz company. In this way spectrum-analyzers instrument limitations can be avoided or minimized. Instead, CMU manufacturers declared measurement error can be considered for this measurement.</p> <p>The attenuation (insertion loss) at the RF Inputs/Outputs of CMU were set according the path loss of the test set-up, determined in a step before starting the measurements. A suitable artificial antenna or RF-connector is provided by the applicant in order to perform the conducted measurements. Any data provided with the artificial antenna or connector, have been taken in account in order to correct the measurement data. (typical 0.3dB for attenuation of antenna connector)</p> <p>Peak and Average Values have been recorded for each channel and band.</p>	
EUT settings	<p>A call was established on highest power transmit conditions in GMSK and RMC99 mode.</p> <p>UE is set TX mode, highest transmit power conditions, DTX, MPR or other power saving techniques have been disabled</p> <p>The measurements were made at the low, middle and high carrier frequencies of each of the supported operating band. Choosing three TX-carrier frequencies of the wireless device, should be sufficient to demonstrate compliance.</p>	

4.3.4. Measurement Results

FDD Band 2								
EUT	Set-up 2, Op. Mode 1							
Test case	Power value [dBm]						Limit	Result
	UARFCN no. 9262		UARFCN no. 9400		UARFCN no. 9538			
	PK	AV	PK	AV	PK	AV	[dBm]	
Release 99 12.2kbps RMC	26.21	22.54	25.94	22.46	25.63	22.12	33	Passed

Remark: -

FDD Band 5								
EUT	Set-up 2, Op. Mode 2							
Test case	Power value [dBm]						Limit	Result
	UARFCN no. 4132		UARFCN no. 4183		UARFCN no. 4233			
	PK	AV	PK	AV	PK	AV	[dBm]	
Release 99 12.2kbps RMC	25.65	22.37	25.34	21.96	25.41	22.13	38.4	Passed

Remark: -

4.4. RF-Parameter - Occupied bandwidth and emission bandwidth

4.4.1. Test location and equipments (for reference numbers please see chapter 'List of test equipment')

test site	<input type="checkbox"/> 347 Radio.lab. 1	<input checked="" type="checkbox"/> Radio.lab. 2			
spectr. analys.	<input type="checkbox"/> 584 FSU	<input type="checkbox"/> 489 ESU	<input type="checkbox"/> 264 FSEK	<input checked="" type="checkbox"/> 620 ESU26	
attenuator	<input checked="" type="checkbox"/> 530 10 dB	<input type="checkbox"/>	<input type="checkbox"/>		
signaling	<input type="checkbox"/> 392 MT8820A	<input type="checkbox"/> 436 CMU	<input checked="" type="checkbox"/> 547 CMU		
DC Power	<input checked="" type="checkbox"/> 611 E3636A	<input type="checkbox"/> 087 EA3013	<input checked="" type="checkbox"/> 354 NGPE 40	<input type="checkbox"/> 086 LNG50-10	
otherwise	<input checked="" type="checkbox"/> 529 6dB divider	<input checked="" type="checkbox"/> 530 10dB			
line voltage	<input type="checkbox"/> 230 V 50 Hz via public mains		<input type="checkbox"/> 060 110 V/ 60 Hz via PAS 5000		

4.4.2. Requirements and Limits

FCC	CFR47, §2.202(a), §2.1049 <input type="checkbox"/> FDD-Band 5: §22.917(b) <input type="checkbox"/> FDD-Band 2: §24.238(b)	„the occupied bandwidth is the frequency bandwidth, such that, below it lower and above it upper frequency limits, the mean powers radiated are each equal to 0.5 percent of the total mean power radiated”
IC	<input checked="" type="checkbox"/> RSS-Gen, Issue 4: §4.6.1	
ANSI	C63.10-2013	

4.4.3. Test condition and test set-up

Climatic conditions		Temperature: (22±3°C)	Rel. humidity: (40±20)%
Test system set-up		Please see chapter “Test system set-up for conducted measurements at antenna port”	
Spectrum Analyzer Settings	Parameter	Occupied bandwidth:	Emission bandwidth
	Scan Mode Span RBW VBW Sweep time Sweep mode Detector	Spectrum analyser mode 6 MHz 50 kHz 300 kHz 60 Sec Single max-hold RMS	Spectrum analyser mode 6 MHz 50 kHz 300 kHz Coupled Repetitive, max-hold PK
Measurement method		The used spectrum analyzer FSE or ESU from Rohde & Schwarz contains an integrated function to calculate the occupied bandwidth automatically. From left and right display margin, the upper and lower frequency points where the accumulated power becomes 0.5% of the total power, are calculated. Subtracting the previous determined two frequency points, yields the occupied bandwidth.	Bandwidth defined between 2 markers with are 26dBc compared to highest In-Band Peak Emission.
EUT settings		A call was established on highest power transmit conditions in RMC99 mode. The measurements were made at the low, middle and high carrier frequencies of each of the supported operating band. Choosing three TX-carrier frequencies of the wireless device, should be sufficient to demonstrate compliance.	

4.4.4. Results

Operating band	Channel no.		Occupied 99% bandwidth [MHz]	26 dBc Emission bandwidth [MHz]
	Range	No.		
Set-up 2, Op-Mode 1				
FDD Band 2	Channel Low (1852.4 MHz)	9262	4.067	4.615
	Channel Middle (1880.0 MHz)	9400	4.077	4.635
	Channel High (1907.6 MHz)	9538	4.077	4.615
Set-up 2, Op-Mode 2				
FDD Band 5	Channel Low (826.4 MHz)	4132	4.077	4.635
	Channel Middle (836.6 MHz)	4183	4.077	4.635
	Channel High (846.6 MHz)	4233	4.077	4.625

Remarks: see diagrams in separate annex 4

4.5. RF-Parameter - Conducted out of Band RF emissions and Band Edge

4.5.1. Test location and equipments (for reference numbers please see chapter 'List of test equipment')

test location	<input checked="" type="checkbox"/> CETECOM Essen (Chapter. 2.2.1)	<input type="checkbox"/> Please see Chapter. 2.2.2	<input type="checkbox"/> Please see Chapter. 2.2.3
test site	<input type="checkbox"/> 347 Radio.lab. 1	<input checked="" type="checkbox"/> Radio.lab. 2	
spectr. analys.	<input type="checkbox"/> 584 FSU	<input type="checkbox"/> 120 FSEM	<input type="checkbox"/> 264 FSEK <input checked="" type="checkbox"/> 489 ESU
signaling	<input type="checkbox"/> 017 CMD 65	<input type="checkbox"/> 323 CMD 55	<input type="checkbox"/> 340 CMD 55
signaling	<input type="checkbox"/> 392 MT8820A	<input type="checkbox"/> 436 CMU	<input checked="" type="checkbox"/> 670 CMU
power supply	<input checked="" type="checkbox"/> 611 E3636A	<input type="checkbox"/> 457 EA 3013A	<input type="checkbox"/> 459 EA 2032-50 <input type="checkbox"/> 268 EA- 3050 <input type="checkbox"/> 494 AG6632A <input type="checkbox"/> 498 NGPE 40
otherwise	<input checked="" type="checkbox"/> 529 6dB divider	<input checked="" type="checkbox"/> 530 10dB Att.	<input type="checkbox"/> 431 Near field
line voltage	<input type="checkbox"/> 230 V 50 Hz via public mains <input type="checkbox"/> 060 110 V/ 60 Hz via PAS 5000		

4.5.2. Requirements and limits

FCC	§2.1051 §2.1057 §22.917(a)(b) §24.238(a)(b)
IC	RSS-132, Issue 3: 5.5(i)(ii) RSS-133, Issue 6: 6.5.1(i)(ii)
Limit	„the power of emissions shall be attenuated below the transmitter output power (p) by at least 43+10Log(P) dB“

4.5.3. Test condition and test set-up

Climatic conditions	Temperature: (22±3°C)	Rel. humidity: (40±20)%
Test system set-up	Please see chapter “Test system set-up for conducted measurements on antenna port”	
Measurement method	The spectrum was scanned from 9 kHz to the 10th harmonic of the highest frequency generated within the equipment. A PEAK detector was used except measurements near the block-edge where a AVERAGE detector applied. A suitable artificial antenna or RF-connector is provided by the applicant in order to perform the conducted measurements. Any data provided with the artificial antenna or connector, have been taken in account in order to correct the measurement data. (typical 0.3dB for attenuation of antenna connector)	
Spectrum-Analyzer settings	See below tables	
Mobile phone settings	A call was established on highest power transmit conditions in RMC99 mode. The measurements were made at the low, middle and high carrier frequencies of each of the supported operating band. Choosing three TX-carrier frequencies of the mobile phone, should be sufficient to demonstrate compliance.	

Spectrum-Analyzer settings for FDD Band 2

	Start freq. MHz	Stop freq. MHz	R-BW MHz	V-BW MHz	Sweep time sec.	Att. [dB]	Detector
Sweep 1 (subrange 1)	0.009	0.150	0.0001	-- ^{1.)}	10	25	MaxH-PK
Sweep 1 (subrange 2)	0.150	1	0.009	-- ^{1.)}	10	25	MaxH-PK
Sweep 1 (subrange 3)	1	30	0.1	-- ^{1.)}	5	25	MaxH-PK
Sweep 2 (subrange 1)	30	19500	1	-- ^{1.)}	>60	35	MaxH-PK
Sweep 3a (Block-Edge)	1849	1850	0.05	-- ^{1.)}	30	35	MaxH-PK
Sweep 3b (Block-Edge)	1849	1850	0.05	-- ^{1.)}	30	35	MaxH-AV
Sweep 4a (Block-Edge)	1910	1911	0.05	-- ^{1.)}	30	35	MaxH-PK
Sweep 4b (Block-Edge)	1910	1911	0.05	-- ^{1.)}	30	35	MaxH-AV

Remark: 1.) EMI 6dB receiver mode used

Spectrum-Analyzer Settings FDD Band 5

	Start freq. MHz	Stop freq. MHz	R-BW MHz	V-BW MHz	Sweep time sec.	Att.	Detector
Sweep 1 (subrange 1)	0.009	0.150	0.0001	-- ^{1.)}	10	25	MaxH-PK
Sweep 1 (subrange 2)	0.150	1	0.009	-- ^{1.)}	10	25	MaxH-PK
Sweep 1 (subrange 3)	1	30	0.1	-- ^{1.)}	5	25	MaxH-PK
Sweep 2 (subrange 1)	30	9000	1	-- ^{1.)}	>60	35	MaxH-PK
Sweep 3a (Block-Edge)	823	824	0.05	-- ^{1.)}	30	35	MaxH-PK
Sweep 3b (Block-Edge)	823	824	0.05	-- ^{1.)}	30	35	MaxH-AV
Sweep 4a (Block-Edge)	850	851	0.05	-- ^{1.)}	30	35	MaxH-PK
Sweep 4b (Block-Edge)	850	851	0.05	-- ^{1.)}	30	35	MaxH-AV

Remark: 1.) EMI 6dB receiver mode used

4.5.4. Results

The results are presented below in summary form only. For more information please see each diagram enclosed in annex 4.

4.5.4.1. FDD Band 2: Op. Mode 1, Set-up 2

Diagram no.	Carrier Channel		Frequency range	OP-mode no.	Remark	Used detector			Result
	Range	No.				PK	AV	QP	
36.60	Low	9262	9kHz to 30MHz	1	--	<input checked="" type="checkbox"/>	<input type="checkbox"/>	<input type="checkbox"/>	passed
36.61	Low		30 MHz to 19.5MHz		Carrier visible on diagram, not relevant for results	<input checked="" type="checkbox"/>	<input type="checkbox"/>	<input type="checkbox"/>	passed
37.60	Low		1849 – 1850 MHz		Band Edge Compliance	<input checked="" type="checkbox"/>	<input type="checkbox"/>	<input type="checkbox"/>	passed
36.62	Middle	9400	9kHz to 30MHz		--	<input checked="" type="checkbox"/>	<input type="checkbox"/>	<input type="checkbox"/>	passed
36.63	Middle		30 MHz to 19.5MHz		Carrier visible on diagram, not relevant for results	<input checked="" type="checkbox"/>	<input type="checkbox"/>	<input type="checkbox"/>	passed
36.64	High		9kHz to 30MHz		--	<input checked="" type="checkbox"/>	<input type="checkbox"/>	<input type="checkbox"/>	passed
36.65	High	9538	30 MHz to 19.5MHz		Carrier visible on diagram, not relevant for results	<input checked="" type="checkbox"/>	<input type="checkbox"/>	<input type="checkbox"/>	passed
37.61	High		1910 – 1911 MHz		Band-Edge compliance	<input checked="" type="checkbox"/>	<input type="checkbox"/>	<input type="checkbox"/>	passed

Remark: --

4.5.4.2. FDD Band 5: Op. Mode 2, Set-up 2

Diagram no.	Carrier Channel		Frequency range	OP-mode no.	Remark	Used detector			Result
	Range	No.				PK	AV	QP	
36.40	Low	4132	9kHz to 30MHz	1	--	<input checked="" type="checkbox"/>	<input type="checkbox"/>	<input type="checkbox"/>	passed
36.41	Low		30 MHz to 9GHz		Carrier visible on diagram, not relevant for results	<input checked="" type="checkbox"/>	<input type="checkbox"/>	<input type="checkbox"/>	passed
37.40	Low		823 – 824 MHz		Band Edge Compliance	<input checked="" type="checkbox"/>	<input type="checkbox"/>	<input type="checkbox"/>	passed
36.42	Middle	4183	9kHz to 30MHz		--	<input checked="" type="checkbox"/>	<input type="checkbox"/>	<input type="checkbox"/>	passed
36.43	Middle		30 MHz to 9GHz		Carrier visible on diagram,	<input checked="" type="checkbox"/>	<input type="checkbox"/>	<input type="checkbox"/>	passed
36.44	High		9kHz to 30MHz		--	<input checked="" type="checkbox"/>	<input type="checkbox"/>	<input type="checkbox"/>	passed
36.45	High	4233	30 MHz to 9GHz		Carrier visible on diagram,	<input checked="" type="checkbox"/>	<input type="checkbox"/>	<input type="checkbox"/>	passed
37.41	High		849 – 850 MHz		Band-Edge compliance	<input checked="" type="checkbox"/>	<input type="checkbox"/>	<input type="checkbox"/>	passed

Remark: --

4.6. RF-Parameter - Frequency stability on temperature and voltage variations

4.6.1. Test location and equipments (for reference numbers please see chapter 'List of test equipment')

test location	<input checked="" type="checkbox"/> CETECOM Essen (Chapter. 2.2.1)	<input type="checkbox"/> Please see Chapter. 2.2.2	<input type="checkbox"/> Please see Chapter. 2.2.3
test site	<input type="checkbox"/> 347 Radio.lab.1	<input checked="" type="checkbox"/> Radio.lab.2	<input type="checkbox"/>
spectr. analys.	<input type="checkbox"/> 584 FSU	<input type="checkbox"/> 489 ESU 40	<input type="checkbox"/> 264 FSEK
signaling	<input type="checkbox"/> 392 MT8820A	<input type="checkbox"/> 436 CMU	<input checked="" type="checkbox"/> 670 CMU
DC power	<input type="checkbox"/> 456 EA 3013A	<input checked="" type="checkbox"/> 457 EA 3013A	<input type="checkbox"/> 459 EA 2032-50
otherwise	<input type="checkbox"/> 529 6dB divider	<input type="checkbox"/> 530 10dB Att.	<input type="checkbox"/> 431 Near field
Climatic test chamber	<input type="checkbox"/> 331 HC 4055	<input checked="" type="checkbox"/> 331 VT 4002	<input checked="" type="checkbox"/> 627 OPUS 1
line voltage	<input type="checkbox"/> 230 V 50 Hz via public mains		<input checked="" type="checkbox"/> 00727 12 V/ 60 Hz Keithley 2303 (pre-m)

4.6.2. Requirements and limits

FCC	§2.1055(a)(1) <input checked="" type="checkbox"/> FDD Band 5: §22.355, Table C-1 <input checked="" type="checkbox"/> FDD Band 2: §24.235
IC	<input checked="" type="checkbox"/> FDD Band 5: RSS-132, Issue 3: 5.3 <input checked="" type="checkbox"/> FDD Band 2: RSS-133, Issue 6: 6.3
Limit	<i>"The frequency stability shall be sufficient to ensure that the fundamental emission stays within the authorized frequency block"</i>

4.6.3. Test condition and test set-up

Test system set-up	Please see chapter "Test system set-up for conducted measurements on antenna port" In order to maintain the voltage constant over the time period of the tests, a dummy battery was connected to a laboratory power supply. The power supply voltage was controlled on the input of the power supply terminals of the EUT.
Measurement method	The RF Channel spacing is 200 kHz according W-CDMA-Spec, with a guard band. The aim of the EUT is to function under all extreme conditions within authorized sub-bands in regard to temperature and voltage variations. The frequency deviation was recorded with base station's build in capability. (CMU) As the standard requires that the fundamental emissions stays within the authorized band, a limit of +/-2.5ppm is considered low enough to ensure this.
Mobile phone settings	A call was established on highest power transmit conditions in RMC99 mode. The measurements were made at the low, middle and high carrier frequencies of each of the supported operating band. Choosing three TX-carrier frequencies of the mobile phone, should be sufficient to demonstrate compliance. Tests have been done in Rel99, 12.2 kbps RMC operating mode.

4.6.3.1. Frequency shift of carrier against a voltage range at constant nominal temperature of 20° Celsius

- 1.) determine the carrier frequency for the lowest and highest channel at room temperature and nominal voltage [20°C]
- 2.) The voltage was reduced to the lower declared voltage. (this shall be specified by the manufacturer) Record the carrier frequency shift within 2 minutes after powering on the mobile phone, to prevent for self heating effects.
- 3.) The voltage was increased upper declared voltage range as declared by the manufacturer. Record the carrier frequency shift within 2 minutes after powering on the mobile phone, to prevent for self heating effects.

4.6.4. Measurement Results FDD 2:

FDD Band 2 - Channel 9400				
Voltage [V]	Nominal Frequency [MHz]	Maximum frequency error		Verdict Limit= +/- 2.5ppm
		[Hz]	[ppm]	
3,40	1,880E+09	-883	-0,470	passed
3,80		-874	-0,465	
4,20		-1079	-0,574	
FDD Band 2 - Channel 9262				
Voltage [V]	Nominal Frequency [MHz]	Maximum frequency error		Verdict Limit= +/- 2.5ppm
		[Hz]	[ppm]	
3,40	1,852E+09	-88	-0,048	passed
3,80		-91	-0,049	
4,20		-102	-0,055	
FDD Band 2 - Channel 9538				
Voltage [V]	Nominal Frequency [MHz]	Maximum frequency error		Verdict Limit= +/- 2.5ppm
		[Hz]	[ppm]	
3,40	1,9076E+09	-2247	-1,178	passed
3,80		-2304	-1,208	
4,20		-2282	-1,196	

4.6.5. Measurement Results FDD 5:

FDD Band V - Channel 4183				
Voltage [V]	Nominal Frequency [MHz]	Maximum frequency error		Verdict Limit= +/- 2.5ppm
		[Hz]	[ppm]	
3,40	8,466E+08	2072	2,447	passed
3,80		2078	2,455	
4,20		2086	2,464	
FDD Band V - Channel 4132				
Voltage [V]	Nominal Frequency [MHz]	Maximum frequency error		Verdict Limit= +/- 2.5ppm
		[Hz]	[ppm]	
3,40	8,264E+08	2058	2,490	passed
3,80		2063	2,496	
4,20		2049	2,479	
FDD Band V - Channel 4233				
Voltage [V]	Nominal Frequency [MHz]	Maximum frequency error		Verdict Limit= +/- 2.5ppm
		[Hz]	[ppm]	
3,40	8,466E+08	-1009	-1,192	passed
3,80		51	0,060	
4,20		-45	-0,053	

4.6.5.1. Frequency shift of carrier against temperature at constant power supply voltage

- 1.) determine the carrier frequency for the lowest, middle and highest channel at room temperature and nominal voltage [20°C]
- 2.) expose the mobile station to -30°C, wait sufficient time to have constant temperature.
- 3.) Perform the carrier frequencies measurements in 10°C increments from -30°C to +50°C. For about half hour at the specified temperature the mobile was powered-off. After powering-on, the measurements were made within 2 minute for the channel lower channel, in order to prevent self-warming of the mobile.

4.6.5.2. FDD Band 2

Temperature	Maximum frequency error						Verdict Limit=±1ppm
	Channel 9262	Channel 9400	Channel 9538	Channel 9262	Channel 9400	Channel 9538	
	[Hz]			[ppm]			
-30	265,35	218,01	229,24	0,143	0,116	0,120	Passed
-20	152,42	63,14	66,68	0,082	0,034	0,035	
-10	76,82	54,50	68,42	0,041	0,029	0,036	
0	93,10	81,34	74,12	0,050	0,043	0,039	
10	132,64	73,36	99,79	0,072	0,039	0,052	
20	167,32	54,00	85,51	0,090	0,029	0,045	
30	166,58	60,47	54,71	0,090	0,032	0,029	
40	145,52	51,20	58,67	0,079	0,027	0,031	
50	68,03	62,6	67,03	0,037	0,033	0,035	

Remark: absolute maximum deviation: 265.35Hz. Margin to band-edge from left T1 point of 99% OBW is 371.154kHz. The maximum deviation is very low considering the margin to the band edge at 1850MHz.

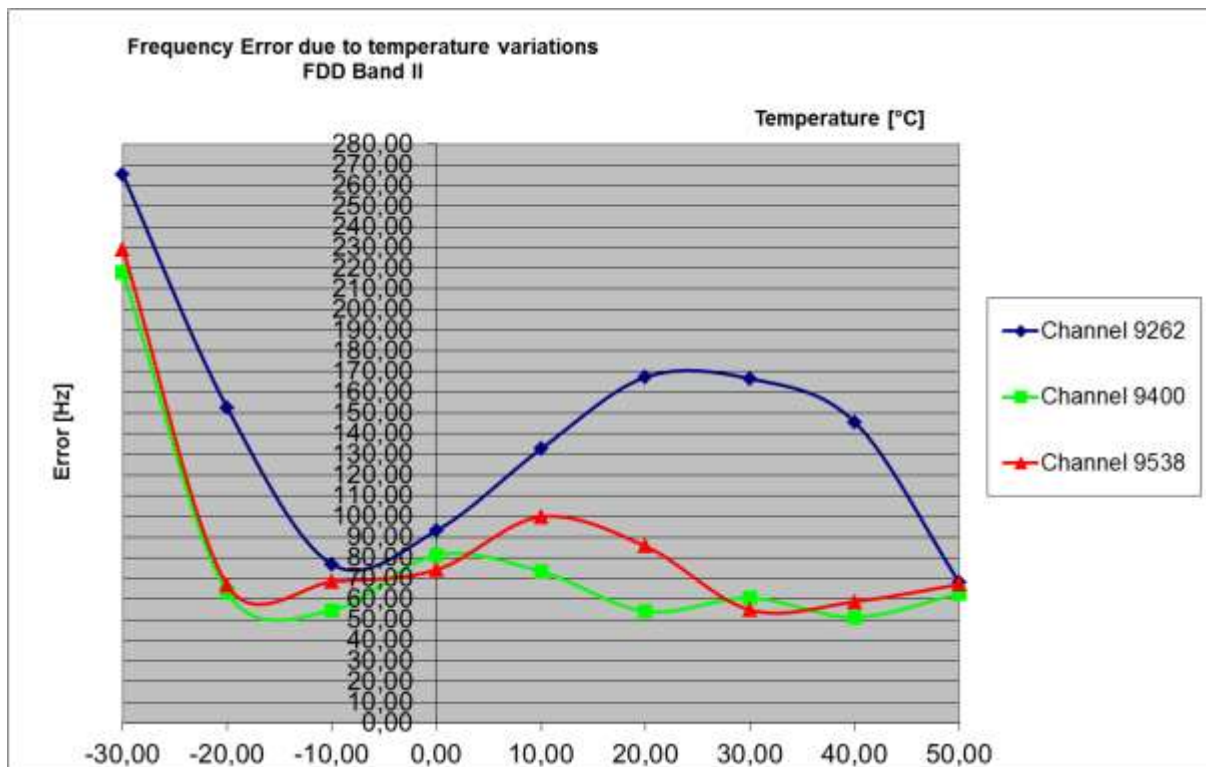

4.6.5.3. FDD Band 5

Temperature	Maximum frequency error						Verdict Limit=±0.1 ppm
	Channel 4132	Channel 4183	Channel 4233	Channel 4132	Channel 4183	Channel 4233	
	[Hz]			[ppm]			
-30	81,48	62,88	73,57	0,099	0,075	0,087	Passed
-20	53,14	30,48	33,34	0,064	0,036	0,039	
-10	30,60	26,96	32,45	0,037	0,032	0,038	
0	43,96	31,64	36,71	0,053	0,038	0,043	
10	57,32	32,04	30,02	0,069	0,038	0,035	
20	55,26	31,49	34,48	0,067	0,038	0,041	
30	63,20	31,98	32,02	0,076	0,038	0,038	
40	32,92	27,40	28,51	0,040	0,033	0,034	
50	32,63	31,34	37,04	0,039	0,037	0,044	

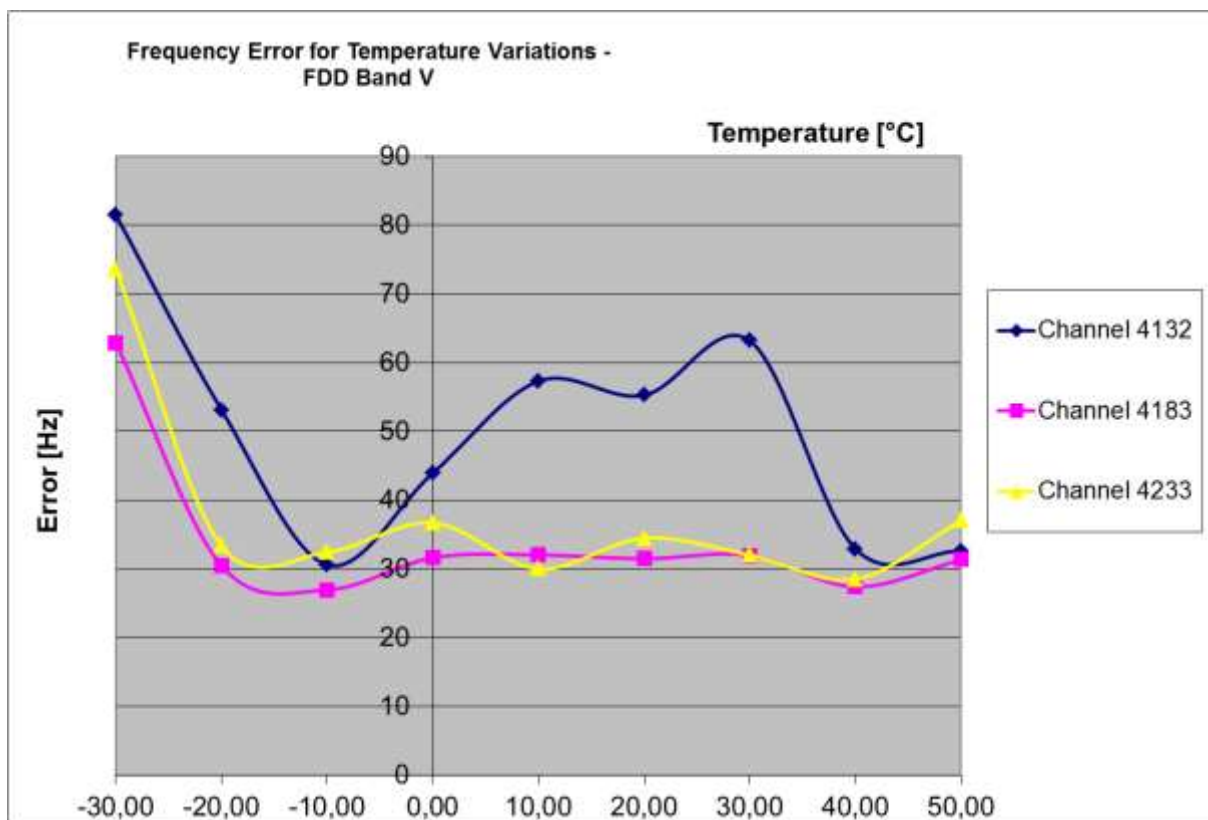

4.7. General Limit - Radiated field strength emissions below 30 MHz

4.7.1. Test location and equipment

test location	<input checked="" type="checkbox"/> CETECOM Essen (Chapter. 2.2.1)	<input type="checkbox"/> Please see Chapter. 2.2.2	<input type="checkbox"/> Please see Chapter. 2.2.3
test site	<input checked="" type="checkbox"/> 441 EMI SAR	<input type="checkbox"/> 487 SAR NSA	<input type="checkbox"/> 347 Radio.lab.
receiver	<input type="checkbox"/> 377 ESCS30	<input checked="" type="checkbox"/> 001 ESS	<input type="checkbox"/>
spectr. analys.	<input type="checkbox"/> 584 FSU	<input type="checkbox"/> 120 FSEM	<input type="checkbox"/> 264 FSEK
antenna	<input type="checkbox"/> 574 BTA-L	<input type="checkbox"/> 133 EMCO3115	<input type="checkbox"/> 302 BBHA9170
signaling	<input type="checkbox"/> 392 MT8820A	<input type="checkbox"/> 371 CBT32	<input type="checkbox"/> 547 CMU
otherwise	<input type="checkbox"/> 400 FTC40x15E	<input type="checkbox"/> 401 FTC40x15E	<input type="checkbox"/> 110 USB LWL
DC power	<input checked="" type="checkbox"/> 456 EA 3013A	<input type="checkbox"/> 457 EA 3013A	<input type="checkbox"/> 459 EA 2032-50
line voltage	<input type="checkbox"/> 230 V 50 Hz via public mains		
	<input type="checkbox"/> 060 120 V 60 Hz via PAS 5000		

4.7.2. Requirements

FCC	Part 15, Subpart C, §15.205 & §15.209			
IC	RSS-Gen: Issue 4: §8.9 Table 5			
ANSI	C63.10-2013			
Frequency [MHz]	Field strength limit [dBµV/m]		Distance [m]	Remarks
0.009 – 0.490	2400/f (kHz)	67.6 – 20Log(f) (kHz)	300	Correction factor used due to measurement distance of 3 m
0.490 – 1.705	24000/f (kHz)	87.6 – 20Log(f) (kHz)	30	Correction factor used due to measurement distance of 3 m
1.705 – 30	30	29.5	30	Correction factor used due to measurement distance of 3 m

4.7.3. Test condition and test set-up

Signal link to test system (if used):	<input checked="" type="checkbox"/> air link	<input type="checkbox"/> cable connection	<input type="checkbox"/> none
EUT-grounding	<input checked="" type="checkbox"/> none	<input type="checkbox"/> with power supply	<input type="checkbox"/> additional connection
Equipment set up	<input checked="" type="checkbox"/> table top		<input type="checkbox"/> floor standing
Climatic conditions	Temperature: (22±3°C)		Rel. humidity: (40±20)%
EMI-Receiver or Analyzer Settings	Scan data	<input checked="" type="checkbox"/> 9 – 150 kHz RBW/VBW = 200 Hz	Scan step = 80 Hz
	Scan-Mode	<input checked="" type="checkbox"/> 150 kHz – 30 MHz RBW/VBW = 9 kHz	Scan step = 4 kHz
Detector Mode:	<input checked="" type="checkbox"/> 6 dB EMI-Receiver Mode <input type="checkbox"/> 3dB Spectrum analyser Mode		
Sweep-Time	Peak (pre-measurement) and Quasi-PK/Average (final if applicable)		
General measurement procedures	Please see chapter “Test system set-up radiated magnetic field measurements below 30 MHz”		

4.7.4. Measurement Results

The results are presented below in summary form only. For more information please see the diagrams.

Table of measurement results:

Diagram No.	Carrier Channel		Frequency range	Set-up no.	OP-mode no.	Remark	Used detector			Result
	Range	No.					PK	AV	QP	
2.01	Low	9262	9 kHz-30 MHz	1	1		<input checked="" type="checkbox"/>	<input type="checkbox"/>	<input type="checkbox"/>	passed
2.04	Low	4132	9 kHz-30 MHz	1	2		<input checked="" type="checkbox"/>	<input type="checkbox"/>	<input type="checkbox"/>	passed
2.02	Middle	9400	9 kHz-30 MHz	1	1		<input checked="" type="checkbox"/>	<input type="checkbox"/>	<input type="checkbox"/>	passed
2.05	Middle	4183	9 kHz-30 MHz	1	2		<input checked="" type="checkbox"/>	<input type="checkbox"/>	<input type="checkbox"/>	passed
2.03	High	9538	9 kHz-30 MHz	1	1		<input checked="" type="checkbox"/>	<input type="checkbox"/>	<input type="checkbox"/>	passed
2.06	High	4233	9 kHz-30 MHz	1	2		<input checked="" type="checkbox"/>	<input type="checkbox"/>	<input checked="" type="checkbox"/>	passed

4.7.5. Correction factors due to reduced meas. distance (f< 30 MHz)

The used correction factors when the measurement distance is reduced compared to regulatory measurement distance, are calculated according Extrapolation formulas valid for EUT's with maximum dimension of 0.625xLambda. Formula 2+3+4 as presented in ANSI C63.10, Chapter 6.4.4 are used for the calculations of proper extrapolation factors.

Frequency -Range	f [kHz/MHz]	Lambda [m]	Far-Field Point [m]	Distance Limit accord. 15.209 [m]	1st Condition (dmeas < D _{near-field})	2'te Condition (Limit distance bigger d _{near-field})	Distance Correction accord. Formula
kHz	9,00E+03	33333,33	5305,17	300	fulfilled	not fulfilled	-80,00
	1,00E+04	30000,00	4774,65		not fulfilled	-80,00	
	2,00E+04	15000,00	2387,33		not fulfilled	-80,00	
	3,00E+04	10000,00	1591,55		not fulfilled	-80,00	
	4,00E+04	7500,00	1193,66		not fulfilled	-80,00	
	5,00E+04	6000,00	954,93		not fulfilled	-80,00	
	6,00E+04	5000,00	795,78		not fulfilled	-80,00	
	7,00E+04	4285,71	682,09		not fulfilled	-80,00	
	8,00E+04	3750,00	596,83		not fulfilled	-80,00	
	9,00E+04	3333,33	530,52		not fulfilled	-80,00	
	1,00E+05	3000,00	477,47		not fulfilled	-80,00	
	1,25E+05	2400,00	381,97		not fulfilled	-80,00	
	2,00E+05	1500,00	238,73		fulfilled	-78,02	
	3,00E+05	1000,00	159,16		fulfilled	-74,49	
	4,00E+05	750,00	119,37		fulfilled	-72,00	
	4,90E+05	612,24	97,44		fulfilled	-70,23	
	5,00E+05	600,00	95,49		fulfilled	-40,00	
	6,00E+05	500,00	79,58		fulfilled	-40,00	
7,00E+05	428,57	68,21	fulfilled	-40,00			
8,00E+05	375,00	59,68	fulfilled	-40,00			
9,00E+05	333,33	53,05	fulfilled	-40,00			
MHz	1,00	300,00	47,75	30	fulfilled	not fulfilled	-40,00
	1,59	188,50	30,00		fulfilled	-40,00	
	2,00	150,00	23,87		fulfilled	-38,02	
	3,00	100,00	15,92		fulfilled	-34,49	
	4,00	75,00	11,94		fulfilled	-32,00	
	5,00	60,00	9,55		fulfilled	-30,06	
	6,00	50,00	7,96		fulfilled	-28,47	
	7,00	42,86	6,82		fulfilled	-27,13	
	8,00	37,50	5,97		fulfilled	-25,97	
	9,00	33,33	5,31		fulfilled	-24,95	
	10,00	30,00	4,77		fulfilled	-24,04	
	10,60	28,30	4,50		fulfilled	-23,53	
	11,00	27,27	4,34		fulfilled	-23,21	
	12,00	25,00	3,98		fulfilled	-22,45	
	13,56	22,12	3,52		fulfilled	-21,39	
	15,00	20,00	3,18		fulfilled	-20,51	
	15,92	18,85	3,00		fulfilled	-20,00	
	17,00	17,65	2,81		not fulfilled	-20,00	
	18,00	16,67	2,65		not fulfilled	-20,00	
	20,00	15,00	2,39		not fulfilled	-20,00	
	21,00	14,29	2,27		not fulfilled	-20,00	
23,00	13,04	2,08	not fulfilled	-20,00			
25,00	12,00	1,91	not fulfilled	-20,00			
27,00	11,11	1,77	not fulfilled	-20,00			
29,00	10,34	1,65	not fulfilled	-20,00			
30,00	10,00	1,59	not fulfilled	-20,00			

5. Accreditation details of CETECOM's laboratories and test sites

Ref.-No.	Accreditation Certificate	Valid for laboratory area or test site	Accreditation Body
-	D-PL-12047-01-01	All laboratories and test sites of CETECOM GmbH, Essen	DAkkS, Deutsche Akkreditierungsstelle GmbH
337 487 558 348 348	(MRA US-EU 0003)	Radiated Measurements 30 MHz to 1 GHz, 3 m / 10 m (OATS) Radiated Measurements 30 MHz to 1 GHz, 3 m (SAR) Radiated Measurements above 1 GHz, 3 m (FAR) Mains Ports Conducted Interference Measurements Telecommunication Ports Conducted Interference Measur.	FCC, Federal Communications Commission Laboratory Division, USA
337 487 550 558	3462D-1 3462D-2 3462D-2 3462D-3	Radiated Measurements 30 MHz to 1 GHz, 3 m / 10 m (OATS) Radiated Measurements 30 MHz to 1 GHz, 3 m (SAR) Radiated Measurements 1 GHz to 6 GHz, 3 m (SAR) Radiated Measurements above 1 GHz, 3 m (FAR)	IC, Industry Canada Certification and Engineering Bureau
487 550 348 348	R-2666 G-301 C-2914 T-1967	Radiated Measurements 30 MHz to 1 GHz, 3 m (SAR) Radiated Measurements 1 GHz to 6 GHz, 3 m (SAR) Mains Ports Conducted Interference Measurements Telecommunication Ports Conducted Interference Measur.	VCCI, Voluntary Control Council for Interference by Information Technology Equipment, Japan
OATS = Open Area Test Site, SAR = Semi Anechoic Room, FAR = Fully Anechoic Room			

6. Instruments and Ancillary

6.1. Used equipment “CTC”

The “Ref.-No” in the left column of the following tables allows the clear identification of the laboratory equipment.

6.1.1. Test software and firmware of equipment

Ref.-No.	Equipment	Type	Serial-No.	Version of Firmware or Software during the test
001	EMI Test Receiver	ESS	825132/017	Firm.= 1.21 , OTP=2.0, GRA=2.0
012	Signal Generator (EMS-cond.)	SMY 01	839069/027	Firm.= V 2.02
013	Power Meter (EMS cond.)	NRVD	839111/003	Firm.= V 1.51
017	Digital Radiocommunication Tester	CMD 60 M	844365/014	Firmware = V 3.52 .22.01.99, DECT = D2.87 13.01.99
053	Audio Analyzer	UPA3	860612/022	Firm. V 4.3
119	RT Harmonics Analyzer dig. Flickermeter	B10	G60547	Firm.= V 3.1DHG
140	Signal Generator	SMHU	831314/006	Firm.= 3.21
261	Thermal Power Sensor	NRV-Z55	825083/0008	EPROM-Datum 02.12.04, SE EE 1 B
262	Power Meter	NRV-S	825770/0010	Firm.= 2.6
263	Signal Generator	SMP 04	826190/0007	Firm.=3.21
264	Spectrum Analyzer	FSEK 30	826939/005	Bios=2.1, Analyzer= 3.20
295	Racal Digital Radio Test Set	6103	1572	UNIT Firmware= 4.04, SW-Main=4.04, SW-BBP=1.04, SW-DSP=1.02, Hardboot=1.02, Softboot=2.02
298	Univ. Radio Communication Tester	CMU 200	832221/091	R&S Test Firmware =3.53 /3.54 (current Testsoftw. f. all band used
323	Digital Radiocommunication Tester	CMD 55	825878/0034	Firm.= 3.52 .22.01.99
331	Climatic Test Chamber -40/+80 Grad	HC 4055	43146	TSI 1.53
335	CTC-EMS-Conducted	System EMS Conducted	-	EMC 32 V 8.52
340	Digital Radiocommunication Tester	CMD 55	849709/037	Firm.= 3.52 .22.01.99
355	Power Meter	URV 5	891310/027	Firm.= 1.31
365	10V Insertion Unit 50 Ohm	URV5-Z2	100880	Eprom Data = 31.03.08
366	Ultra Compact Simulator	UCS 500 M4	V0531100594	Firm. UCS 500=001925/3.06a02, rc=ISMIEC 4.10
371	Bluetooth Tester	CBT32	100153	CBT V5.30+ SW-Option K55, K57
377	EMI Test Receiver	ESCS 30	100160	Firm.= 2.30, OTP= 02.01, GRA= 02.36
378	Broadband RF Field Monitor	RadiSense III	03D00013SNO-08	Firm.= V.03D13
389	Digital Multimeter	Keithley 2000	0583926	Firm. = A13 (Mainboard) A02 (Display)
392	Radio Communication Tester	MT8820A	6K00000788	Firm.= 4.50 #005, IPL=4.01#001,OS=4.02#001, GSM=4.41#013, W-CDMA= 4.54#004, scenario= 4.52#002
436	Univ. Radio Communication Tester	CMU 200	103083	R&S Test Firmware Base=5.14, Mess-Software= GSM:5.14 WCDMA:5.14 (current Testsoftw. F. all band
441	CTC-SAR-EMI Cable Loss	System EMI field (SAR)	-	EMC 32 Version 8.52
442	CTC-SAR-EMS	System EMS field (SAR)	-	EMC 32 Version 8.40
443	CTC-FAR-EMI-RSE	System CTC-FAR-EMI-RSE	-	Spuri 7.2.5 or EMC 32 Ver. 9.15.00
444	CTC-FAR-EMS field	System-EMS-Field (FAR)	-	EMC 32 Version 9.15.00
460	Univ. Radio Communication Tester	CMU 200	108901	R&S Test Firmware Base=5.14, GSM=5.14 WCDMA=5.14 (current Testsoftw.,f. all band to be used,
489	EMI Test Receiver	ESU40	1000-30	Firmware=4.43 SP3, Bios=V5.1-16-3, Spec. =01.00
491	ESD Simulator dito	ESD dito	dito307022	V 2.30
524	Voltage Drop Simulator	VDS 200	0196-16	Software Nr: 000037 Version V4.20a01
526	Burst Generator	EFT 200 A	0496-06	Software Nr. 000034 Version V2.32
527	Micro Pulse Generator	MPG 200 B	0496-05	Software-Nr. 000030 Version V2.43
528	Load Dump Simulator	LD 200B	0496-06	Software-Nr. 000031 Version V2.35a01
546	Univ. Radio Communication Tester	CMU 200	106436	R&S Test Firmware Base=5.14, GSM=5.14 WCDMA=5.14 (current Testsoftw.,f. all band to be used
547	Univ. Radio Communication Tester	CMU 200	835390/014	R&S Test Firmware Base=V5.1403 (current Testsoftw., f. all band used, GSM = 5.14 WCDMA: = 5.14
584	Spectrum Analyzer	FSU 8	100248	2.82_SP3
597	Univ. Radio Communication Tester	CMU 200	100347	R&S Test Firmware Base=5.01, GSM=5.02 WCDMA= not installed, Mainboard= µP1=V.850
598	Spectrum Analyzer	FSEM 30 (Reserve)	831259/013	Firmware Bios 3.40 , Analyzer 3.40 Sp 2
620	EMI Test Receiver	ESU 26	100362	4.43_SP3
642	Wideband Radio Communication Tester	CMW 500	126089	Setup V03.26, Test programm component V03.02.20
692	Bluetooth Tester	CBT 32	100236	CBT V 5.40, FW: V.2.41 (FPGA Digital, V. 3.09 FPGA RF)

6.1.2. Single instruments and test systems

Ref.-No.	Equipment	Type	Serial-No.	Manufacturer	Interval of calibration	Remark	Cal due
001	EMI Test Receiver	ESS	825132/017	Rohde & Schwarz	12 M	-	31.03.2015
005	AC - LISN (50 Ohm/50µH, test site 1)	ESH2-Z5	861741/005	Rohde & Schwarz	12 M	-	31.03.2015
007	Single-Line V-Network (50 Ohm/5µH)	ESH3-Z6	892563/002	Rohde & Schwarz	12 M	-	31.03.2015
009	Power Meter (EMS-radiated)	NRV	863056/017	Rohde & Schwarz	24 M	-	31.03.2015
016	Line Impedance Simulating Network	Op. 24-D	B6366	Spitzenberger+Spies	36 M	-	31.03.2016
020	Horn Antenna 18 GHz (Subst 1)	3115	9107-3699	EMCO	36/12 M	-	31.03.2017
021	Loop Antenna (H-Field)	6502	9206-2770	EMCO	36 M	-	31.03.2015
030	Loop Antenna (H-field)	HFH-Z2	879604/026	Rohde & Schwarz	36 M	-	31.03.2015
033	RF-current probe (100kHz-30MHz)	ESH2-Z1	879581/18	Rohde & Schwarz	24 M	-	31.03.2015
057	relay-switch-unit (EMS system)	RSU	494440/002	Rohde & Schwarz	pre-m	1a	
060	power amplifier (DC-2kHz)	PAS 5000	B6363	Spitzenberger+Spies	-	3	
066	notch filter (WCDMA; FDD1)	WRCT 1900/2200-5/40-10EEK	5	Wainwright GmbH	12 M	1g	31.07.2015
086	DC - power supply, 0 -10 A	LNG 50-10	-	Heinzinger Electronic	pre-m	2	
087	DC - power supply, 0 -5 A	EA-3013 S	-	Elektro Automatik	pre-m	2	
090	Helmholtz coil: 2x10 coils in series	Helmholtz coil: 2x10 coils in	-	RWTÜV	12 M	4	31.03.2015
091	USB-LWL-Converter	OLS-1	007/2006	Ing. Büro Scheiba	-	4	
099	passive voltage probe	ESH2-Z3	299.7810.52	Rohde & Schwarz	36 M	-	31.03.2015
100	passive voltage probe	Probe TK 9416	without	Schwarzbeck	36 M	-	31.03.2015
110	USB-LWL-Converter	OLS-1	-	Ing. Büro Scheiba	-	4	
119	RT Harmonics Analyzer dig. Flickermeter	B10	G60547	BOCONSULT	36 M	-	31.03.2016
136	adjustable dipole antenna (Dipole 1)	3121C-DB4	9105-0697	EMCO	36 M	-	31.03.2015
140	Signal Generator	SMHU	831314/006	Rohde & Schwarz	24 M	-	31.03.2016
248	attenuator	SMA 6dB 2W	-	Radiall	pre-m	2	
249	attenuator	SMA 10dB 10W	-	Radiall	pre-m	2	
252	attenuator	N 6dB 12W	-	Radiall	pre-m	2	
256	attenuator	SMA 3dB 2W	-	Radiall	pre-m	2	
257	hybrid	4031C	04491	Narda	pre-m	2	
260	hybrid coupler	4032C	11342	Narda	pre-m	2	
261	Thermal Power Sensor	NRV-Z55	825083/0008	Rohde & Schwarz	24 M	-	31.03.2016
262	Power Meter	NRV-S	825770/0010	Rohde & Schwarz	24 M	-	31.03.2016
263	Signal Generator	SMP 04	826190/0007	Rohde & Schwarz	36 M	-	31.03.2016
264	Spectrum Analyzer	FSEK 30	826939/005	Rohde & Schwarz	12 M	-	31.03.2015
265	peak power sensor	NRV-Z33, Model 04	840414/009	Rohde & Schwarz	24 M	-	31.03.2016
266	Peak Power Sensor	NRV-Z31, Model 04	843383/016	Rohde & Schwarz	24 M	-	31.03.2016
267	notch filter GSM 850	WRCA 800/960-6EEK	9	Wainwright GmbH	pre-m	2	
270	termination	1418 N	BB6935	Weinschel	pre-m	2	
271	termination	1418 N	BE6384	Weinschel	pre-m	2	
272	attenuator (20 dB) 50 W	Model 47	BF6239	Weinschel	pre-m	2	
273	attenuator (10 dB) 100 W	Model 48	BF9229	Weinschel	pre-m	2	
274	attenuator (10 dB) 50 W	Model 47 (10 dB) 50 W	BG0321	Weinschel	pre-m	2	
275	DC-Block	Model 7003 (N)	C5129	Weinschel	pre-m	2	
276	DC-Block	Model 7006 (SMA)	C7061	Weinschel	pre-m	2	
279	power divider	1515 (SMA)	LH855	Weinschel	pre-m	2	
287	pre-amplifier 25MHz - 4GHz	AMF-2D-100M4G-35-10P	379418	Miteq	12 M	1c	31.07.2015
291	high pass filter GSM 850/900	WHJ 2200-4EE	14	Wainwright GmbH	12 M	1c	31.07.2015
298	Univ. Radio Communication Tester	CMU 200	832221/091	Rohde & Schwarz	pre-m	3	
300	AC LISN (50 Ohm/50µH, 1-phase)	ESH3-Z5	892 239/020	Rohde & Schwarz	12 M	-	31.03.2015
301	attenuator (20 dB) 50W, 18GHz	47-20-33	AW0272	Lucas Weinschel	pre-m	2	
302	horn antenna 40 GHz (Meas 1)	BBHA9170	155	Schwarzbeck	36 M	-	31.03.2017
303	horn antenna 40 GHz (Subst 1)	BBHA9170	156	Schwarzbeck	36 M	-	31.03.2017
331	Climatic Test Chamber -40/+80 Grad	HC 4055	43146	Heraeus Vötsch	24 M	-	30.11.2014
341	Digital Multimeter	Fluke 112	81650455	Fluke	24 M	-	31.03.2016
342	Digital Multimeter	Voltcraft M-4660A	IB 255466	Voltcraft	24 M	-	31.03.2015
347	laboratory site	radio lab.	-	-	-	5	
348	laboratory site	EMI conducted	-	-	-	5	
354	DC - Power Supply 40A	NGPE 40/40	448	Rohde & Schwarz	pre-m	2	
355	Power Meter	URV 5	891310/027	Rohde & Schwarz	24 M	-	31.03.2016
356	power sensor	NRV-Z1	882322/014	Rohde & Schwarz	24 M	-	31.03.2015
357	power sensor	NRV-Z1	861761/002	Rohde & Schwarz	24 M	-	31.03.2015
371	Bluetooth Tester	CBT32	100153	R&S	24 M	-	31.03.2016
373	Single-Line V-Network (50 Ohm/5µH)	ESH3-Z6	100535	Rohde & Schwarz	24 M	-	31.03.2016
376	Horn Antenna 6 GHz	BBHA9120 E	BBHA 9120 E 179	Schwarzbeck	12 M	-	31.03.2015
377	EMI Test Receiver	ESCS 30	100160	Rohde & Schwarz	12 M	-	31.03.2015
389	Digital Multimeter	Keithley 2000	0583926	Keithley	24 M	-	31.03.2015
392	Radio Communication Tester	MT8820A	6K00000788	Anritsu	12 M	-	31.03.2015
431	Model 7405	Near-Field Probe Set	9305-2457	EMCO	-	4	
436	Univ. Radio Communication Tester	CMU 200	103083	Rohde & Schwarz	12 M	-	31.03.2015
439	UltraLog-Antenna	HL 562	100248	Rohde & Schwarz	36 M	-	31.03.2017
441	CTC-SAR-EMI Cable Loss	System EMI field (SAR) Cable	-	CETECOM	12 M	5	30.01.2016
443	CTC-FAR-EMI-RSE	System CTC-FAR-EMI-RSE	-	ETS-Lindgren / CETECOM	12 M	5	31.07.2015
448	notch filter WCDMA_FDD II	WRCT 1850.0/2170.0-	5	Wainwright Instruments	12 M	1c	31.07.2015

Ref.-No.	Equipment	Type	Serial-No.	Manufacturer	Interval of calibration	Remark	Cal due
		5/40-		GmbH			
449	notch filter WCDMA FDD V	WRCT 824.0/894.0-5/40-8SSK	1	Wainwright	12 M	1c	31.07.2015
454	Oscilloscope	HM 205-3	9210 P 29661	Hameg	-	4	
456	DC-Power supply 0-5 A	EA 3013 S	207810	Elektro Automatik	pre-m	2	
459	DC -Power supply 0-5 A , 0-32 V	EA-PS 2032-50	910722	Elektro Automatik	pre-m	2	
460	Univ. Radio Communication Tester	CMU 200	108901	Rohde & Schwarz	12 M	-	31.03.2015
463	Universal source	HP3245A	2831A03472	Agilent	-	4	
466	Digital Multimeter	Fluke 112	89210157	Fluke USA	24 M	-	31.03.2016
467	Digital Multimeter	Fluke 112	89680306	Fluke USA	36 M	-	31.03.2015
468	Digital Multimeter	Fluke 112	90090455	Fluke USA	36 M	-	31.03.2015
477	ReRadiating GPS-System	AS-47	-	Automotive Cons. Fink	-	3	
480	power meter (Fula)	NRVS	838392/031	Rohde & Schwarz	24 M	-	31.03.2015
482	filter matrix	Filter matrix SAR 1	-	CETECOM (Brl)	-	1d	
484	pre-amplifier 2,5 - 18 GHz	AMF-5D-02501800-25-10P	1244554	Miteq	12 M	-	31.07.2015
487	System CTC NSA-Verification SAR-EMI	System EMI field (SAR) NSA	-	ETS Lindgren / CETECOM	24 M	-	30.06.2015
489	EMI Test Receiver	ESU40	1000-30	Rohde & Schwarz	12 M	-	31.03.2015
502	band reject filter	WRCG 1709/1786-1699/1796-	SN 9	Wainwright	pre-m	2	
503	band reject filter	WRCG 824/849-814/859-	SN 5	Wainwright	pre-m	2	
512	notch filter GSM 850	WRCA 800/960-02/40-6EEK	SN 24	Wainwright	12 M	1c	31.07.2015
517	relais switch matrix	HF Relais Box Keithley	SE 04	Keithley	pre-m	2	
523	Digital Multimeter	L4411A	MY46000154	Agilent	24 M	-	31.03.2015
529	6 dB Broadband resistive power divider	Model 1515	LH 855	Weinschel	pre-m	2	
530	10 dB Broadband resistive power divider	R 416110000	LOT 9828	-	pre-m	2	
546	Univ. Radio Communication Tester	CMU 200	106436	R&S	12 M	-	12.02.2015
547	Univ. Radio Communication Tester	CMU 200	835390/014	Rohde & Schwarz	12 M	-	31.03.2015
548	Digital-Barometer	GBP 2300	without	Greisinger GmbH	36 M	-	30.06.2015
549	Log.Per-Antenna	HL025	1000060	Rohde & Schwarz	36/12 M	-	31.03.2015
552	high pass filter 2.8-18GHz	WHKX 2.8/18G-10SS	4	Wainwright	12 M	1c	31.07.2015
557	System CTC-OTA-2	R&S TS8991	-	Rohde & Schwarz	12 M	5	30.09.2015
558	System CTC FAR S-VSWR	System CTC FAR S-VSWR	-	CTC	24 M	-	31.07.2015
574	Biconilog Hybrid Antenna	BTA-L	980026L	Frankonia	36/12 M	-	31.03.2016
584	Spectrum Analyzer	FSU 8	100248	Rohde & Schwarz	pre-m	-	
594	Wideband Radio Communication Tester	CMW 500	101757	Rohde & Schwarz	12 M	-	31.03.2015
597	Univ. Radio Communication Tester	CMU 200	100347	Rohde & Schwarz	36 M	-	31.03.2016
598	Spectrum Analyzer	FSEM 30 (Reserve)	831259/013	Rohde & Schwarz	24 M	-	13.01.2015
600	power meter	NRVD (Reserve)	834501/018	Rohde & Schwarz	24 M	-	31.03.2015
601	medium-sensitivity diode sensor	NRV-Z5 (Reserve)	8435323/003	Rohde & Schwarz	24 M	-	31.03.2015
602	peak power sensor	NRV-Z32 (Reserve)	835080	Rohde & Schwarz	24 M	-	31.03.2015
611	DC power supply	E3632A	KR 75305854	Agilent	pre-m	2	
612	DC power supply	E3632A	MY 40001321	Agilent	pre-m	2	
613	Attenuator	R416120000 20dB 10W	Lot. 9828	Radiall	pre-m	2	
616	Digitalmultimeter	Fluke 177	88900339	Fluke	24 M	-	31.03.2016
617	Power Splitter/Combiner	ZFSC-2-2-S+	S F987001108	Mini Circuits	-	2	
618	Power Splitter/Combiner	50PD-634	600994	JFW Industries USA	-	2	
619	Power Splitter/Combiner	50PD-634	600995	JFW Industries, USA	-	3	
620	EMI Test Receiver	ESU 26	100362	Rohde-Schwarz	12 M	-	01.12.2015
621	Step Attenuator 0-139 dB	RSP	100017	Rohde & Schwarz	pre-m	2	
625	Generic Test Load USB	Generic Test Load USB	-	CETECOM	-	2	
627	data logger	OPUS 1	201.0999.9302.6.4.1.4 3	G. Luft GmbH	36 M	-	30.05.2015
634	Spectrum Analyzer	FSM (HF-Unit)	826188/010	Rohde & Schwarz	pre-m	2	
636	Thermal Imaging camera	Ti32	Ti32-12060213	Fluke Corporation	36 M	-	31.07.2015
637	High Speed HDMI with Ethernet 1m	HDMI cable with Ethernet 1m	-	KogiLink	-	2	
638	HDMI Kabel with Ethernet 1,5 m flach	HDMI cable with Ethernet	-	Reichelt	-	2	
640	HDMI cable 2m rund	HDMI cable 2m rund	-	Reichelt	-	2	
641	HDMI cable with Ethernet	Certified HDMI cable with	-	PureLink	-	2	
642	Wideband Radio Communication Tester	CMW 500	126089	Rohde&Schwarz	12 M	-	31.03.2015
644	Amplifier	ZX60-2534M+	SN865701299	Mini-Circuits	-	-	
670	Univ. Radio Communication Tester	CMU 200	106833	Rohde & Schwarz	12 M	-	31.03.2015
671	DC-power supply 0-5 A	EA-3013S	-	Elektro Automatik	pre-m	2	
678	Power Meter	NRP	101638	Rohde&Schwarz	pre-m	-	
683	Spectrum Analyzer	FSU 26	200571	Rohde & Schwarz	12 M	-	01.04.2015
686	Field Analyzer	EHP-200A	160WX30702	Narda Safety Test Solutions	24 M	-	18.07.2015
687	Signal Generator	SMF 100A	102073	Rohde&Schwarz	12 M	-	01.04.2015
688	Pre Amp	JS-18004000-40-8P	1750117	Miteq	pre-m	-	
692	Bluetooth Tester	CBT 32	100236	Rohde & Schwarz	12 M	-	31.03.2015
693	TS8997	CTC-Radio Lab 1_TS8997	-	Rohde&Schwarz	12 M	5	31.05.2015

Ref.-No.	Equipment	Type	Serial-No.	Manufacturer	Interval of calibration	Remark	Cal due
697	Power Splitter	ZN4PD-642W-S+	165001445	Mini-Circuits	-	2	

Note / remarks		Calibrated during system calibration:
	1a	System CTC-SAR-EMS (Ref.-No. 442)
	1b	System-CTC-EMS-Conducted (Ref.-No. 335)
	1c	System CTC-FAR-EMI-RSE (Ref.-No . 443)
	1d	System CTC-SAR-EMI (Ref.-No . 441)
	1e	System CTC-OATS (EMI radiated) (Ref.-No. 337)
	1 f	System CTC-CTIA-OTA (Ref.-No . 420)
	1 g	System CTC-FAR-EMS (Ref.-No . 444)
	2	Calibration or equipment check immediately before measurement
	3	Regulatory maintained equipment for functional check or support purpose
	4	Ancillary equipment without calibration e.g. mechanical equipment or monitoring equipment
	5	Test System

Interval of calibration	12 M	12 month
	24 M	24 month
	36 M	36 month
	24/12 M	Calibration every 24 months, between this every 12 months internal validation
	36/12 M	Calibration every 36 months, between this every 12 months internal validation
	Pre-m	Check before starting the measurement
	-	Without calibration

7. Versions of test reports (change history)

Version	Applied changes	Date of release
--	Initial release	2015-04-09
--	--	--