

**ELECTROMAGNETIC EMISSIONS COMPLIANCE REPORT  
INTENTIONAL RADIATOR CERTIFICATION TO  
FCC PART 15 SUBPART C REQUIREMENT**

*OF*

**300Mbps Wireless N USB Adapter**

**Model No.: BL-WN2210**

**FCC ID: S8J-WN2210**

**Trademark: LB-LINK**

**Report No.: KAD141222062E**

**Issue Date: January 21, 2015**

*Prepared for*

**Shenzhen Bilian Electronic Co., Ltd.  
Building B1, Zhongxing Industrial Zone, Juling Jutang Community,  
Guanlan street, Bao'an, Shenzhen China**

*Prepared by*

**DONGGUAN EMTEK CO., LTD.  
No.281, Guantai Road, Nancheng District,  
Dongguan, Guangdong, China  
TEL: 86-769-22807078  
FAX: 86-769-22807079**

**This report shall not be reproduced, except in full, without the written approval of  
DONGGUAN EMTEK CO., LTD.**

## VERIFICATION OF COMPLIANCE

Applicant:	Shenzhen Bilian Electronic Co., Ltd. Building B1, Zhongxing Industrial Zone, Juling Jutang Community, Guanlan street, Bao'an, Shenzhen China
Manufacturer:	Shenzhen Bilian Electronic Co., Ltd. Building B1, Zhongxing Industrial Zone, Juling Jutang Community, Guanlan street, Bao'an, Shenzhen China
Product Description:	300Mbps Wireless N USB Adapter
Model Number:	BL-WN2210
Trade Mark:	LB-LINK
Date of Test:	December 22, 2014 to January 15, 2015

### We hereby certify that:

The above equipment was tested by DONGGUAN EMTEK CO., LTD. The test data, data evaluation, test procedures, and equipment configurations shown in this report were made in accordance with the procedures given in ANSI C63.4 (2014) and the energy emitted by the sample EUT tested as described in this report is in compliance with conducted and radiated emission limits of FCC Rules Part 15.247(2014).

*Approved By*



---

**Sam Lv / Q.A. Manager  
DONGGUAN EMTEK CO., LTD.**

## Modified Information

Version	Summary	Revision Date	Report No.
Ver.1.0	Original Report	/	KAD141222062E

## Table of Contents

<b>1. GENERAL INFORMATION .....</b>	<b>6</b>
1.1 PRODUCT DESCRIPTION .....	6
<b>2. SYSTEM TEST CONFIGURATION .....</b>	<b>7</b>
2.1 EUT CONFIGURATION.....	7
2.2 EUT EXERCISE .....	7
2.3 TEST PROCEDURE.....	7
2.4 CONFIGURATION OF TESTED SYSTEM .....	7
<b>3. DESCRIPTION OF TEST MODES.....</b>	<b>8</b>
<b>4. SUMMARY OF TEST RESULTS.....</b>	<b>9</b>
<b>5. TEST METHODOLOGY .....</b>	<b>9</b>
<b>6. TEST FACILITY.....</b>	<b>9</b>
<b>7. TEST SYSTEM UNCERTAINTY .....</b>	<b>10</b>
<b>8. CONDUCTED EMISSIONS TEST .....</b>	<b>11</b>
8.1 MEASUREMENT PROCEDURE .....	11
8.2 TEST SET-UP (BLOCK DIAGRAM OF CONFIGURATION) .....	11
8.3 MEASUREMENT EQUIPMENT USED .....	11
8.4 CONDUCTED EMISSION LIMIT .....	11
8.5 MEASUREMENT RESULT.....	11
<b>9. RADIATED EMISSION TEST.....</b>	<b>14</b>
9.1 MEASUREMENT PROCEDURE .....	14
9.2 TEST SET-UP (BLOCK DIAGRAM OF CONFIGURATION) .....	15
9.3 MEASUREMENT EQUIPMENT USED .....	16
9.4 RADIATED EMISSION LIMIT .....	16
9.5 MEASUREMENT RESULT.....	18
<b>10. 6DB BANDWIDTH TEST .....</b>	<b>27</b>
10.1 MEASUREMENT PROCEDURE .....	27
10.2 TEST SET-UP (BLOCK DIAGRAM OF CONFIGURATION) .....	27
10.3 MEASUREMENT EQUIPMENT USED .....	27
10.4 MEASUREMENT RESULTS.....	27
<b>11. MAXIMUM PEAK OUTPUT POWER TEST.....</b>	<b>43</b>
11.1 MEASUREMENT PROCEDURE .....	43
11.2 TEST SET-UP (BLOCK DIAGRAM OF CONFIGURATION) .....	43
11.3 MEASUREMENT EQUIPMENT USED .....	43
11.4 PEAK POWER OUTPUT LIMIT .....	43
11.5 MEASUREMENT RESULTS.....	44
<b>12. BAND EDGE TEST .....</b>	<b>45</b>
12.1 MEASUREMENT PROCEDURE .....	45
12.2 TEST SET-UP (BLOCK DIAGRAM OF CONFIGURATION) .....	46
12.3 MEASUREMENT EQUIPMENT USED .....	46
12.4 MEASUREMENT RESULTS.....	46
<b>13. MAXIMUM POWER SPECTRAL DENSITY .....</b>	<b>66</b>
13.1 TEST EQUIPMENT .....	66
13.2 MEASURING INSTRUMENTS AND SETTING.....	66
13.3 TEST PROCEDURES.....	66

13.4	BLOCK DIAGRAM OF TEST SETUP .....	66
13.5	LIMIT.....	66
13.6	TEST RESULT .....	67
<b>14.</b>	<b>ANTENNA PORT EMISSION.....</b>	<b>82</b>
14.1	TEST EQUIPMENT .....	82
14.2	MEASURING INSTRUMENTS AND SETTING.....	82
14.3	TEST PROCEDURES.....	82
14.4	BLOCK DIAGRAM OF TEST SETUP .....	82
14.5	TEST RESULT .....	82
<b>15.</b>	<b>ANTENNA APPLICATION .....</b>	<b>92</b>
15.1	ANTENNA REQUIREMENT .....	92
15.2	RESULT.....	92

APPENDIX I (PHOTOS OF EUT)(3PAGES)

## 1. General Information

### 1.1 Product Description

Characteristics	Description
<b>IEEE 802.11 WLAN Mode Supported</b>	<input checked="" type="checkbox"/> 802.11b(20MHz channel bandwidth) <input checked="" type="checkbox"/> 802.11g(20MHz channel bandwidth) <input checked="" type="checkbox"/> 802.11n(20MHz channel bandwidth) <input checked="" type="checkbox"/> 802.11n(40MHz channel bandwidth)
<b>Data Rate</b>	802.11 b:1,2,5.5,11Mbps; 802.11 g:6,9,12,18,24,36,48,54Mbps; 802.11n(HT20):MCS0-MCS7; 802.11n(HT40):MCS0-MCS7; 802.11n(HT40):MCS8-MCS15;
<b>MIMO Mode</b>	802.11n(H20), 802.11n(H40)
<b>Modulation</b>	DSSS with DBPSK/DQPSK/CCK for 802.11b; OFDM with BPSK/QPSK/16QAM/64QAM for 802.11g/n;
<b>Operating Frequency Range</b>	2412-2462MHz for 802.11b/g; 2412-2462MHz for 802.11n(H20); 2422-2452MHz for 802.11n(H40);
<b>Number of Channels</b>	11 channels for 802.11b/g; 11 channels for 802.11n(H20); 7 channels for 802.11n(H40);
<b>Transmit Power Max</b>	17.24dBm for 802.11b; 15.04dBm for 802.11g; 14.32dBm for 802.11n(H20); 12.10dBm for 802.11n(H40);
<b>Antenna Type</b>	2TX2RX
<b>Antenna Port</b>	<input checked="" type="checkbox"/> Ant1; <input checked="" type="checkbox"/> Ant2;
<b>Smart system</b>	<input checked="" type="checkbox"/> SISO for 802.11b/g <input checked="" type="checkbox"/> MIMO for 802.11n
<b>Antenna Gain</b>	1.8dBi ( for per antenna port Max) 4.8dBi for MIMO(Ant1+Ant2 Directional Gain)

**Note:** for more details, please refer to the User's manual of the EUT.

## 2. System Test Configuration

### 2.1 EUT Configuration

The EUT configuration for testing is installed on RF field strength measurement to meet the Commissions requirement and operating in a manner which intends to maximize its emission characteristics in a continuous normal application.

### 2.2 EUT Exercise

The Transmitter was operated in the normal operating mode. The TX frequency was fixed which was for the purpose of the measurements.

### 2.3 Test Procedure

#### 2.3.1 Conducted Emissions

The EUT is a placed on as turn table which is 0.8 m above ground plane. According to the requirements in Section 13.1.4.1 of ANSI C63.4-2014 Conducted emissions from the EUT measured in the frequency range between 0.15 MHz and 30 MHz using CISPR Quasi-Peak and average detector mode.

#### 2.3.2 Radiated Emissions

The EUT is a placed on as turn table which is 0.8 m above ground plane. The turn table shall rotate 360 degrees to determine the position of maximum emission level. EUT is set 3m away from the receiving antenna which varied from 1m to 4m to find out the highest emission. And also, each emission was to be maximized by changing the polarization of receiving antenna both horizontal and vertical. In order to find out the max. Emission, the relative positions of this hand-held transmitter (EUT) was rotated through three orthogonal axes according to the requirements in Section 13.1.4.1 of ANSI C63.4-2014.

### 2.4 Configuration of Tested System

**Fig. 2-1 Configuration of Tested System**



**Table 2-1 Equipment Used in Tested System**

Item	Equipment	Trademark	Model No.	FCC ID	Note
1.	300Mbps Wireless N USB Adapter	LB-LINK	BL-WN2210	S8J-WN2210	EUT

**Note:**

- (1) Unless otherwise denoted as EUT in 『Remark』 column, device(s) used in tested system is a support equipment.

### 3. Description of Test Modes

The EUT has been tested under its typical operating condition.

The EUT configuration for testing is installed on RF field strength measurement to meet the Commissions requirement and operating in a manner which intends to maximize its emission characteristics in a continuous normal application.

The Transmitter was operated in the normal operating mode. The TX frequency was fixed which was for the purpose of the measurements.

Test of channel included the lowest and middle and highest frequency to perform the test, then record on this report.

Those data rates (802.11b: 1 Mbps; 802.11g: 6 Mbps; 802.11n (HT20 ): MCS0; 802.11n (HT40 ): MCS8) were used for all test.

Pre-defined engineering program for regulatory testing used to control the EUT for staying in continuous transmitting and receiving mode is programmed.

Frequency and Channel list for 802.11 b/g/n (HT20):

Channel	Frequency (MHz)	Channel	Frequency (MHz)	Channel	Frequency (MHz)
1	2412	5	2432	9	2452
2	2417	6	2437	10	2457
3	2422	7	2442	11	2462
4	2427	8	2447		

Frequency and Channel list for 802.11 n (HT40):

Channel	Frequency (MHz)	Channel	Frequency (MHz)	Channel	Frequency (MHz)
3	2422	5	2432	8	2447
4	2427	6	2437	9	2452
		7	2442		

Test Frequency and Channel for 802.11 b/g/n (HT20):

Lowest Frequency		Middle Frequency		Highest Frequency	
Channel	Frequency (MHz)	Channel	Frequency (MHz)	Channel	Frequency (MHz)
1	2412	6	2437	11	2462

Test Frequency and channel for 802.11 n (HT40):

Lowest Frequency		Middle Frequency		Highest Frequency	
Channel	Frequency (MHz)	Channel	Frequency (MHz)	Channel	Frequency (MHz)
3	2422	6	2437	9	2452



## 4. Summary of Test Results

FCC Rules	Description Of Test	Result
§15.247(a)(2)	6dB bandwidth	Pass
§15.247(b)(3)	Max Peak output Power test	Pass
§15.247(e)	Power density	Pass
§15.247(d)	Band edge test	Pass
§15.207	AC Power Conducted Emission	Pass
§15.247(d), §15.209	Radiated Emission	Pass
§15.247(d)	Antenna Port Emission	Pass
§15.247(b)&§15.203	Antenna Application	Pass

### RELATED SUBMITTAL(S) / GRANT(S):

This submittal(s) (test report) is intended for FCC ID: S8J-WN2210 filing to comply with Section 15.247 of the FCC Part 15, Subpart C Rules.

The system is compliance with Subpart B is authorized under a DOC procedure

## 5. Test Methodology

According to its specifications, the EUT must comply with the requirements of the following standards:

FCC 47 CFR Part 2, Subpart J

FCC 47 CFR Part 15, Subpart C

FCC KDB 558074 D01 DTS Meas Guidance v03r02

FCC KDB 662911 D01 Multiple Transmitter Output v01

FCC KDB 662911 D02 MIMO With Cross Polarized Antenna V01

## 6. Test Facility

### Site Description

EMC Lab : Accredited by FCC, June 18, 2014  
The Certificate Number is 247565

Accredited by Industry Canada, February 19, 2014  
The Certificate Number is 9444A

Name of Firm : DONGGUAN EMTEK CO., LTD.  
Site Location : No.281, Guantai Road, Nancheng District,  
Dongguan, Guangdong, China

## 7. TEST SYSTEM UNCERTAINTY

The following measurement uncertainty levels have been estimated for tests performed on the apparatus:

Parameter	Uncertainty
Radio Frequency	$\pm 1 \times 10^{-5}$
Maximum Peak Output Power Test	$\pm 1.0\text{dB}$
Conducted Emissions Test	$\pm 2.0\text{dB}$
Radiated Emission Test	$\pm 2.0\text{dB}$
Power Density	$\pm 2.0\text{dB}$
Occupied Bandwidth Test	$\pm 1.0\text{dB}$
Band Edge Test	$\pm 3\text{dB}$
All emission, radiated	$\pm 3\text{dB}$
Antenna Port Emission	$\pm 3\text{dB}$
Temperature	$\pm 0.5^\circ\text{C}$
Humidity	$\pm 3\%$

Measurement Uncertainty for a level of Confidence of 95%

## 8. Conducted Emissions Test

### 8.1 Measurement Procedure

1. The EUT was placed on a table which is 0.8m above ground plane.
2. Maximum procedure was performed on the six highest emissions to ensure EUT compliance.
3. Repeat above procedures until all frequency measured were complete.

### 8.2 Test SET-UP (Block Diagram of Configuration)

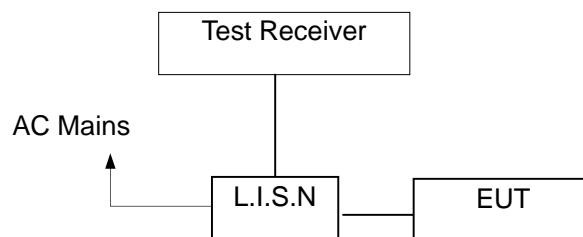

### 8.3 Measurement Equipment Used

Item	Equipment	Manufacturer	Model No.	Serial No.	Last Cal.	Cal. Interval
1.	Test Receiver	Rohde&Schwarz	ESCS30	100018	May 16, 2014	1 Year
2.	L.I.S.N.	Rohde&Schwarz	ENV216	100017	May 16, 2014	1Year
3.	RF Switching Unit	CDS	RSU-M2	38401	May 16, 2014	1Year

### 8.4 Conducted Emission Limit

Conducted Emission Frequency(MHz)	Quasi-peak	Average
0.15-0.5	66-56	56-46
0.5-5.0	56	46
5.0-30.0	60	50

- Note:** 1. The lower limit shall apply at the transition frequencies  
 2. The limit decreases in line with the logarithm of the frequency in the range of 0.15 to 0.50MHz.

### 8.5 Measurement Result

Please refer to following pages.

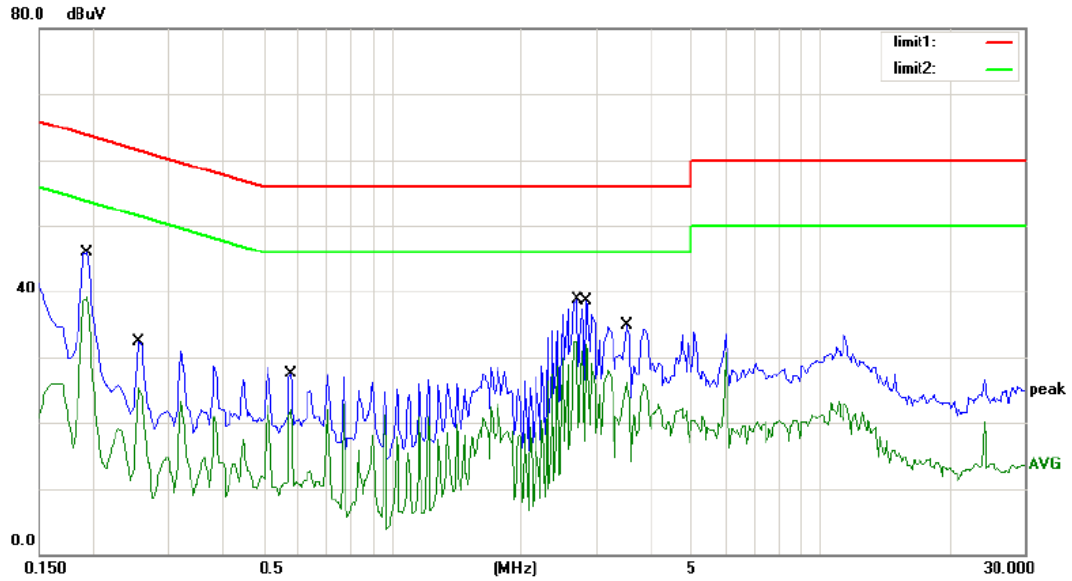

Site site #1 Phase: **L1** Temperature: 24  
 Limit: (CE)FCC PART 15 class B\_QP Power: Connect to PC Humidity: 55 %  
 Mode: TX  
 Note:

No.	Mk.	Freq.	Reading Level	Correct Factor	Measurement	Limit	Over	Detector	Comment
		MHz	dBuV	dB	dBuV	dBuV	dB		
1		0.1950	45.93	0.00	45.93	63.82	-17.89	QP	
2		0.1950	39.08	0.00	39.08	53.82	-14.74	AVG	
3		0.2550	32.21	0.00	32.21	61.59	-29.38	QP	
4		0.2550	25.36	0.00	25.36	51.59	-26.23	AVG	
5		0.5800	27.42	0.00	27.42	56.00	-28.58	QP	
6		0.5800	22.11	0.00	22.11	46.00	-23.89	AVG	
7		2.7200	38.66	0.00	38.66	56.00	-17.34	QP	
8	*	2.7200	32.39	0.00	32.39	46.00	-13.61	AVG	
9		2.8500	38.43	0.00	38.43	56.00	-17.57	QP	
10		2.8500	31.82	0.00	31.82	46.00	-14.18	AVG	
11		3.5300	34.82	0.00	34.82	56.00	-21.18	QP	
12		3.5300	26.17	0.00	26.17	46.00	-19.83	AVG	

\*:Maximum data x:Over limit l:over margin Comment: Factor build in receiver.

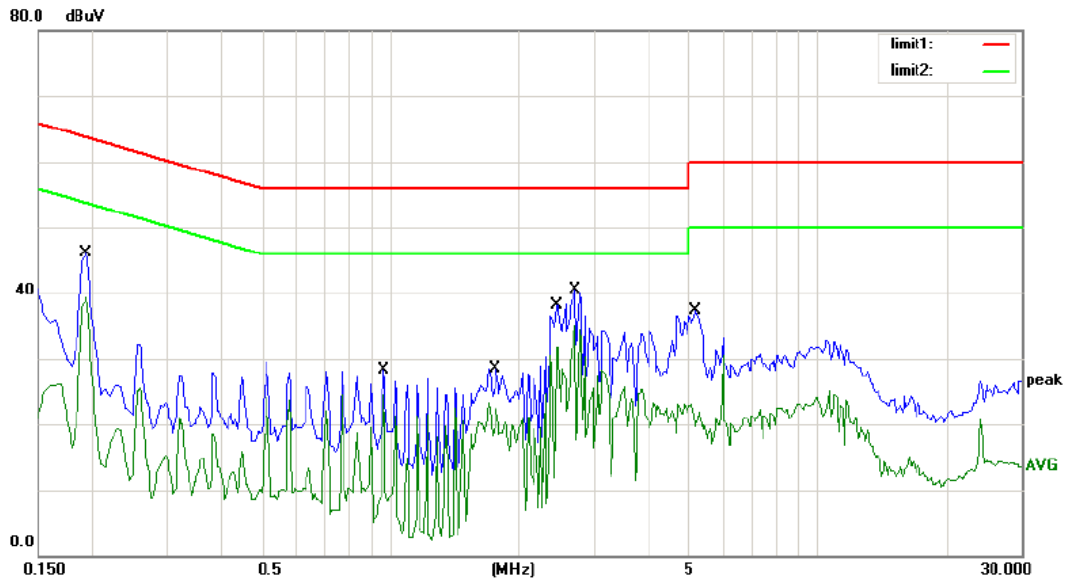

Site site #1 Phase: **N** Temperature: 24  
 Limit: (CE)FCC PART 15 class B\_QP Power: Connect to PC Humidity: 55 %  
 Mode: TX  
 Note:

No.	Mk.	Freq.	Reading Level	Correct Factor	Measure-ment	Limit	Over	Detector	Comment
		MHz	dBuV	dB	dBuV	dBuV	dB		
1		0.1950	46.05	0.00	46.05	63.82	-17.77	QP	
2		0.1950	39.26	0.00	39.26	53.82	-14.56	AVG	
3		0.9650	28.35	0.00	28.35	56.00	-27.65	QP	
4		0.9650	24.42	0.00	24.42	46.00	-21.58	AVG	
5		1.7700	28.44	0.00	28.44	56.00	-27.56	QP	
6		1.7700	22.44	0.00	22.44	46.00	-23.56	AVG	
7		2.4600	38.17	0.00	38.17	56.00	-17.83	QP	
8		2.4600	31.70	0.00	31.70	46.00	-14.30	AVG	
9		2.7200	40.41	0.00	40.41	56.00	-15.59	QP	
10	*	2.7200	35.16	0.00	35.16	46.00	-10.84	AVG	
11		5.1900	37.24	0.00	37.24	60.00	-22.76	QP	
12		5.1900	22.31	0.00	22.31	50.00	-27.69	AVG	

\*:Maximum data x:Over limit !:over margin Comment: Factor build in receiver.

## 9. Radiated Emission Test

### 9.1 Measurement Procedure

1. The EUT was placed on a turn table which is 0.8m above ground plane.
2. Maximum procedure was performed on the six highest emissions to ensure EUT compliance.
3. And also, each emission was to be maximized by changing the polarization of receiving antenna both horizontal and vertical.
4. Repeat above procedures until all frequency measured was complete.

When spectrum scanned from 30MHz to 1GHz setting resolution bandwidth 120KHz and video bandwidth 300KHz:

EMI Test Receiver	Setting
Attenuation	Auto
RB	120KHz
VB	300KHz
Detector	QP
Trace	Max hold

When spectrum scanned above 1GHz setting resolution bandwidth 1MHz, video bandwidth 3MHz:

EMI Test Receiver	Setting
Attenuation	Auto
RB	1MHz
VB	3MHz
Detector	Peak
Trace	Max hold

When spectrum scanned above 1GHz setting resolution bandwidth 1MHz, video bandwidth 10Hz:

EMI Test Receiver	Setting
Attenuation	Auto
RB	1MHz
VB	10Hz
Detector	Peak
Trace	Max hold

## 9.2 Test SET-UP (Block Diagram of Configuration)

### (A) Radiated Emission Test Set-Up, Frequency Below 30MHz

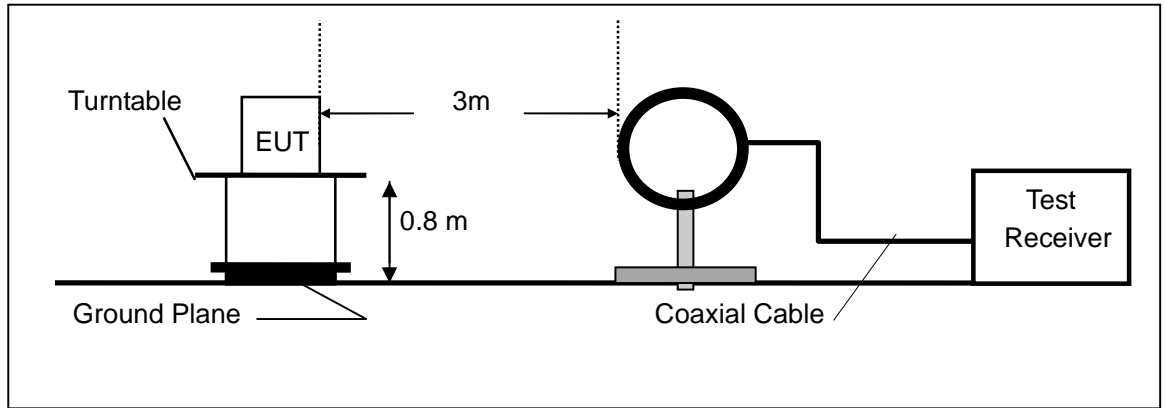

### (B) Radiated Emission Test Set-Up, Frequency Below 1000MHz

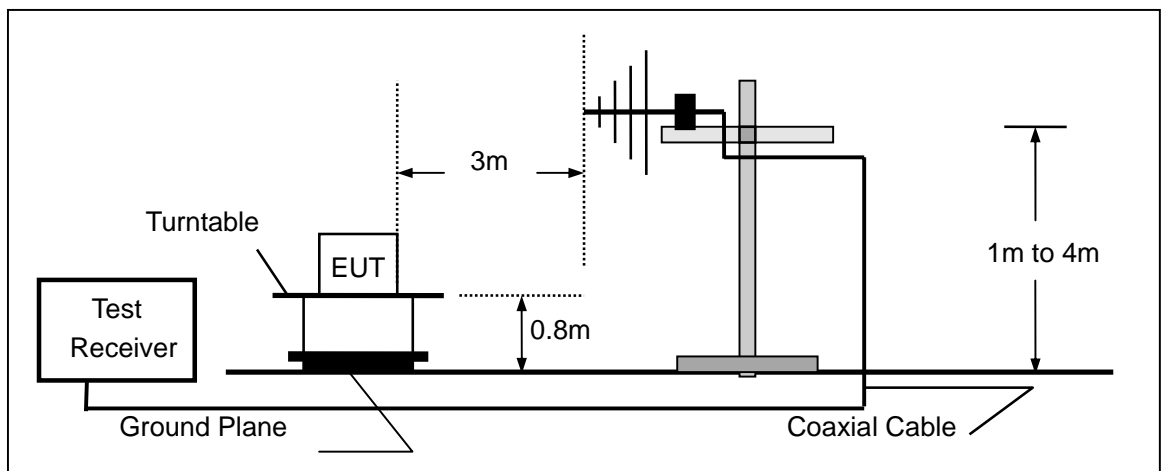

(C) Radiated Emission Test Set-Up, Frequency above 1000MHz

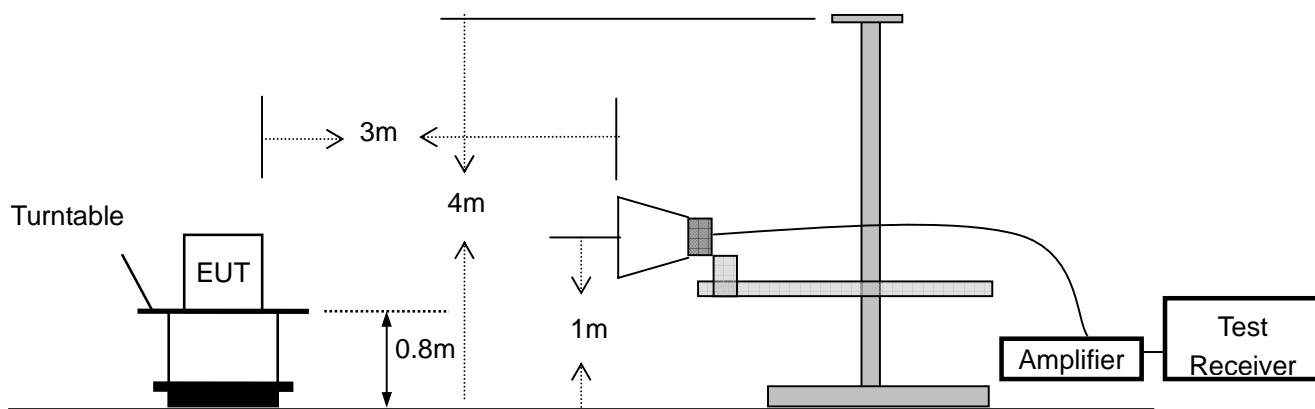

9.3 Measurement Equipment Used

EQUIPMENT TYPE	MFR	MODEL NUMBER	SERIAL NUMBER	LAST CAL.	CAL DUE.
Spectrum Analyzer	Rohde & Schwarz	FSV30	1321.3008K	05/16/2014	05/15/2015
Spectrum Analyzer	HP	E4407B	839840481	05/16/2014	05/15/2015
EMI Test Receiver	Rohde & Schwarz	ESU	1302.6005.26	05/16/2014	05/15/2015
Pre-Amplifier	HP	8447D	2944A07999	05/16/2014	05/15/2015
Bilog Antenna	Schwarzbeck	VULB9163	142	05/19/2014	05/18/2015
Loop Antenna	Schwarzbeck	FMZB 1519	012	05/19/2014	05/18/2015
Horn Antenna	Schwarzbeck	BBHA 9170	BBHA9170399	05/19/2014	05/18/2015
Horn Antenna	Schwarzbeck	BBHA 9120	D143	05/19/2014	05/18/2015
Spectrum Analyzer	Agilent	E4446A	US44300399	05/16/2014	05/15/2015

9.4 Radiated Emission Limit

The emissions from an intentional radiator shall not exceed the field strength levels specified in the following table 15.209(a):

Frequencies (MHz)	Field Strength (micorvolts/meter)	Measurement Distance (meters)
0.009~0.490	2400/F(KHz)	300
0.490~1.705	24000/F(KHz)	30
1.705~30.0	30	30
30~88	100	3
88~216	150	3
216~960	200	3
Above 960	500	3



Restricted bands of operation

MHz	MHz	MHz	GHz
0.090 - 0.110	16.42 - 16.423	399.9 - 410	4.5 - 5.15
<sup>1</sup> 0.495 - 0.505	16.69475 - 16.69525	608 - 614	5.35 - 5.46
2.1735 - 2.1905	16.80425 - 16.80475	960 - 1240	7.25 - 7.75
4.125 - 4.128	25.5 - 25.67	1300 - 1427	8.025 - 8.5
4.17725 - 4.17775	37.5 - 38.25	1435 - 1626.5	9.0 - 9.2
4.20725 - 4.20775	73 - 74.6	1645.5 - 1646.5	9.3 - 9.5
6.215 - 6.218	74.8 - 75.2	1660 - 1710	10.6 - 12.7
6.26775 - 6.26825	108 - 121.94	1718.8 - 1722.2	13.25 - 13.4
6.31175 - 6.31225	123 - 138	2200 - 2300	14.47 - 14.5
8.291 - 8.294	149.9 - 150.05	2310 - 2390	15.35 - 16.2
8.362 - 8.366	156.52475 - 156.52525	2483.5 - 2500	17.7 - 21.4
8.37625 - 8.38675	156.7 - 156.9	2690 - 2900	22.01 - 23.12
8.41425 - 8.41475	162.0125 - 167.17	3260 - 3267	23.6 - 24.0
12.29 - 12.293	167.72 - 173.2	3332 - 3339	31.2 - 31.8
12.51975 - 12.52025	240 - 285	3345.8 - 3358	36.43 - 36.5
12.57675 - 12.57725	322 - 335.4	3600 - 4400	( <sup>2</sup> )

Remark 1. Emission level in dBuV/m=20 log (uV/m)

- :
2. Measurement was performed at an antenna to the closed point of EUT distance of meters.
  3. Only spurious frequency is permitted to locate within the Restricted Bands specified in provision of § 15.205, and the emissions located in restricted bands also comply with 15.209 limit.

## 9.5 Measurement Result

### Below 30MHz:

All the modulation modes were tested the data of the test mode are recorded in the following pages.

Operation Mode:	TX Mode	Test Date :	December 26, 2014
Frequency Range:	9KHz~30MHz	Temperature :	28°C
Test Result:	PASS	Humidity :	60 %
Measured Distance:	3m	Test By:	Andy

Freq. (MHz)	Ant.Pol. H/V	Emission Level (dBuV/m)	Limit 3m (dBuV/m)	Over (dB)
--	--	--	--	--

Note: the amplitude of spurious emission that is attenuated by more than 20dB below the permissible limit has no need to be reported.

Distance extrapolation factor =  $40 \log(\text{Specific distance} / \text{test distance})$  (dB);

Limit line = Specific limits(dBuV) + distance extrapolation factor.

### Below 1000MHz:

All the modulation modes were tested the data of the worst mode (ANT 1: TX 802.11b) are recorded in the following pages and the others modulation methods do not exceed the limits.

Please refer to the following test plots:

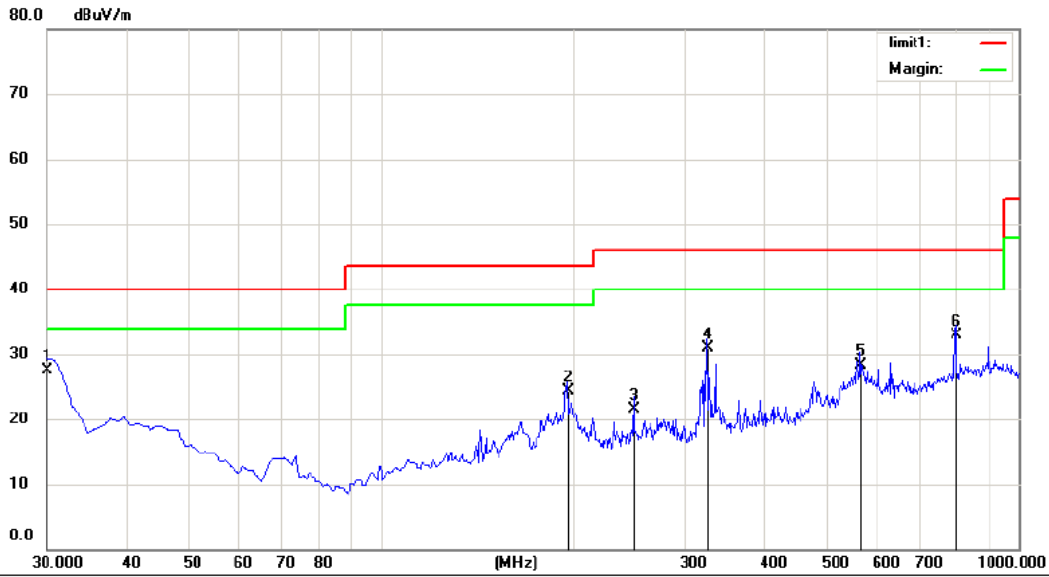

Site Chamber #1 Polarization: **Horizontal** Temperature: 26  
 Limit: (RE)FCC PART 15 class B 3m Power: Connect to PC Humidity: 55 %  
 Mode: TX2412  
 Note:

No.	Mk.	Freq.	Reading Level	Correct Factor	Measurement	Limit	Over	Antenna Height	Table Degree	
		MHz	dBuV	dB	dBuV/m	dBuV/m	dB	cm	degree	Comment
1	*	30.0000	42.58	-15.15	27.43	40.00	-12.57	QP		
2		195.8700	42.09	-17.85	24.24	43.50	-19.26	QP		
3		250.1900	37.03	-15.48	21.55	46.00	-24.45	QP		
4		324.8800	43.91	-13.08	30.83	46.00	-15.17	QP		
5		565.4400	37.13	-8.82	28.31	46.00	-17.69	QP		
6		800.1800	38.12	-5.13	32.99	46.00	-13.01	QP		

\*:Maximum data x:Over limit !:over margin

Operator: Snake

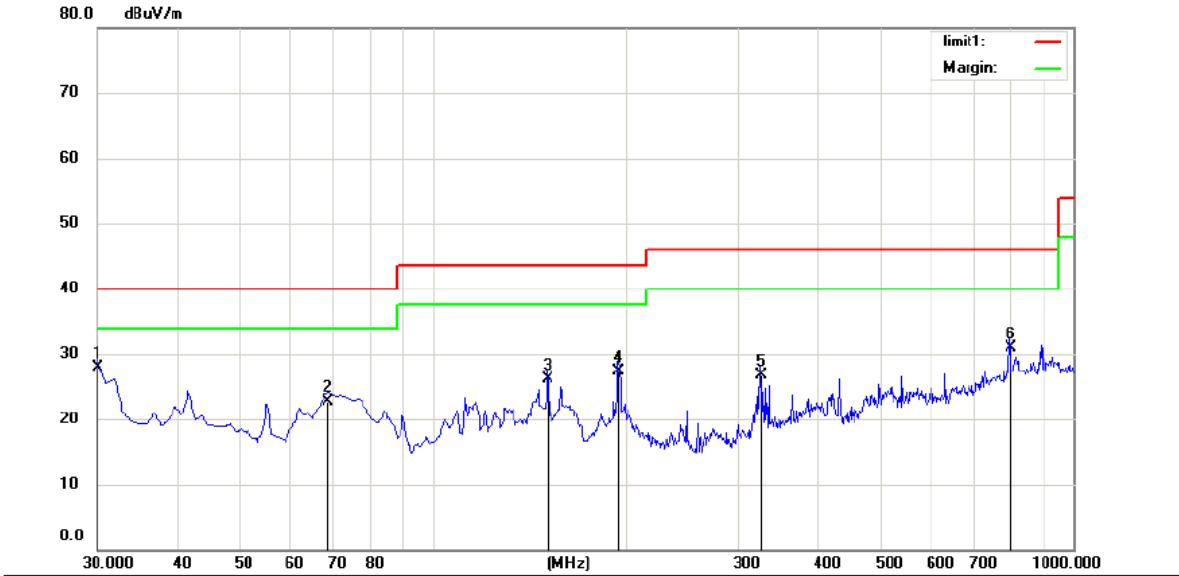

Site Chamber #1 Polarization: **Vertical** Temperature: 26  
 Limit: (RE)FCC PART 15 class B 3m Power: Connect to PC Humidity: 55 %  
 Mode: TX2412  
 Note:

No.	Mk.	Freq. MHz	Reading Level dBuV	Correct Factor dB	Measure- ment dBuV/m	Limit dBuV/m	Over dB	Antenna Height cm	Table Degree degree	Comment
1	*	30.0000	42.96	-15.15	27.81	40.00	-12.19	QP		
2		68.8000	44.41	-21.80	22.61	40.00	-17.39	QP		
3		151.2500	43.99	-17.85	26.14	43.50	-17.36	QP		
4		194.9000	45.24	-17.88	27.36	43.50	-16.14	QP		
5		324.8800	39.88	-13.24	26.64	46.00	-19.36	QP		
6		797.2700	36.08	-5.21	30.87	46.00	-15.13	QP		

\*:Maximum data x:Over limit !:over margin

Operator: Snake

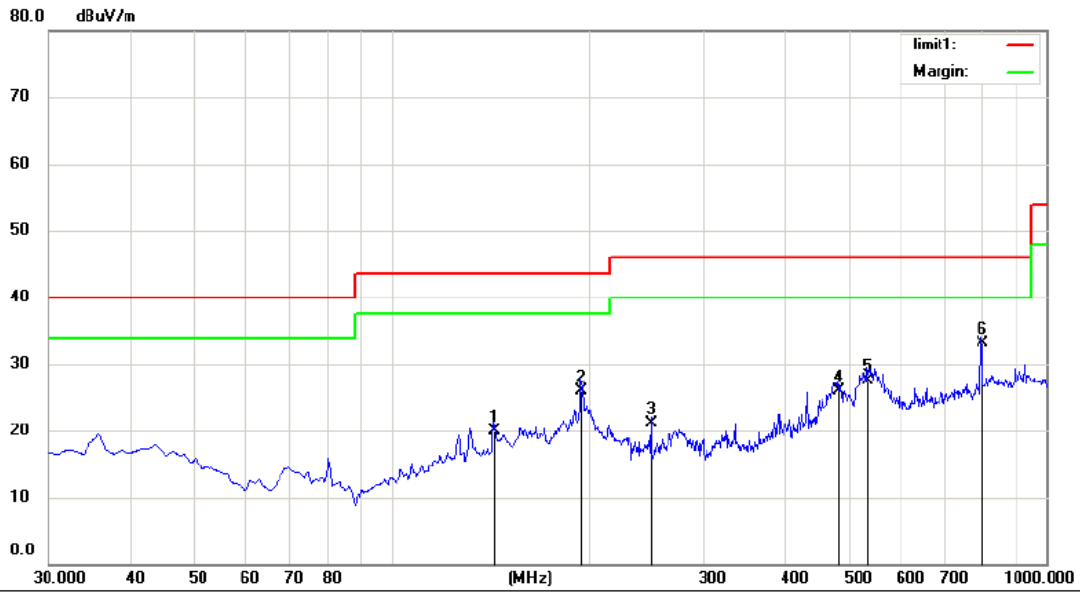

Site Chamber #1 Polarization: **Horizontal** Temperature: 26  
 Limit: (RE)FCC PART 15 class B 3m Power: Connect to PC Humidity: 55 %  
 Mode: TX2437  
 Note:

No.	Mk.	Freq. MHz	Reading Level dBuV	Correct Factor dB	Measure- ment dBuV/m	Limit dBuV/m	Over dB	Antenna Height cm	Table Degree	Comment
1		143.4900	37.20	-17.29	19.91	43.50	-23.59	QP		
2		194.9000	43.70	-17.88	25.82	43.50	-17.68	QP		
3		250.1900	36.62	-15.48	21.14	46.00	-24.86	QP		
4		482.0200	36.35	-10.52	25.83	46.00	-20.17	QP		
5		534.4000	37.10	-9.51	27.59	46.00	-18.41	QP		
6	*	797.2700	38.24	-5.21	33.03	46.00	-12.97	QP		

\*:Maximum data x:Over limit !:over margin

Operator: Snake

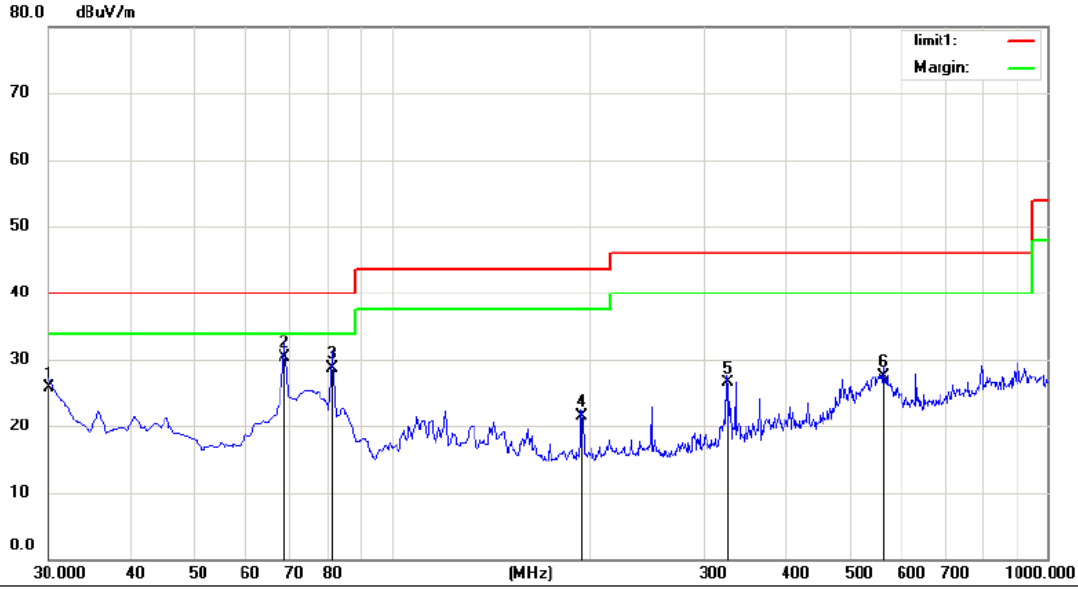

Site Chamber #1 Polarization: **Vertical** Temperature: 26  
 Limit: (RE)FCC PART 15 class B 3m Power: Connect to PC Humidity: 55 %  
 Mode: TX2437  
 Note:

No.	Mk.	Freq.	Reading	Correct	Measurement	Limit	Over	Antenna	Table	
		MHz	dBuV	Factor	dBuV/m	dBuV/m	dB	Height	Degree	Comment
1		30.0000	40.84	-15.15	25.69	40.00	-14.31	QP		
2	*	68.8000	52.06	-21.80	30.26	40.00	-9.74	QP		
3		81.4100	51.05	-22.29	28.76	40.00	-11.24	QP		
4		194.9000	39.47	-17.88	21.59	43.50	-21.91	QP		
5		324.8800	39.84	-13.24	26.60	46.00	-19.40	QP		
6		563.5000	36.58	-9.06	27.52	46.00	-18.48	QP		

\*:Maximum data x:Over limit !:over margin

Operator: Snake

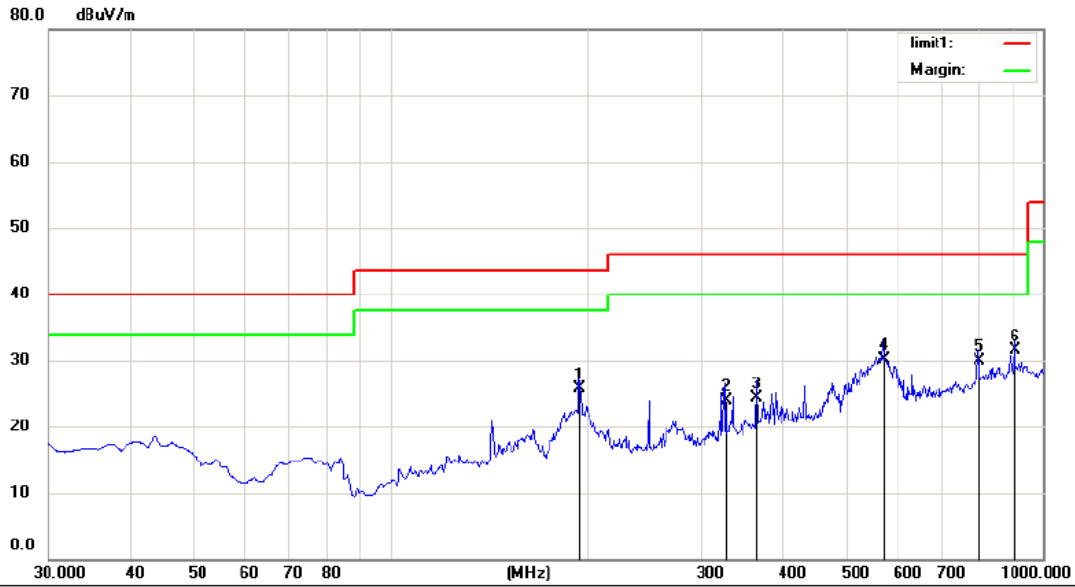

Site Chamber #1 Polarization: **Horizontal** Temperature: 26  
 Limit: (RE)FCC PART 15 class B 3m Power: Connect to PC Humidity: 55 %  
 Mode: TX2462  
 Note:

No.	Mk.	Freq. MHz	Reading Level dBuV	Correct Factor dB	Measure- ment dBuV/m	Limit dBuV/m	Over dB	Antenna Height cm	Table Degree degree	Comment
1		194.9000	43.65	-17.88	25.77	43.50	-17.73	QP		
2		326.8200	37.07	-13.09	23.98	46.00	-22.02	QP		
3		364.6500	36.95	-12.58	24.37	46.00	-21.63	QP		
4		570.2900	38.89	-8.77	30.12	46.00	-15.88	QP		
5		797.2700	35.17	-5.21	29.96	46.00	-16.04	QP		
6	*	907.8500	34.72	-3.30	31.42	46.00	-14.58	QP		

\*:Maximum data x:Over limit !:over margin

Operator: Snake

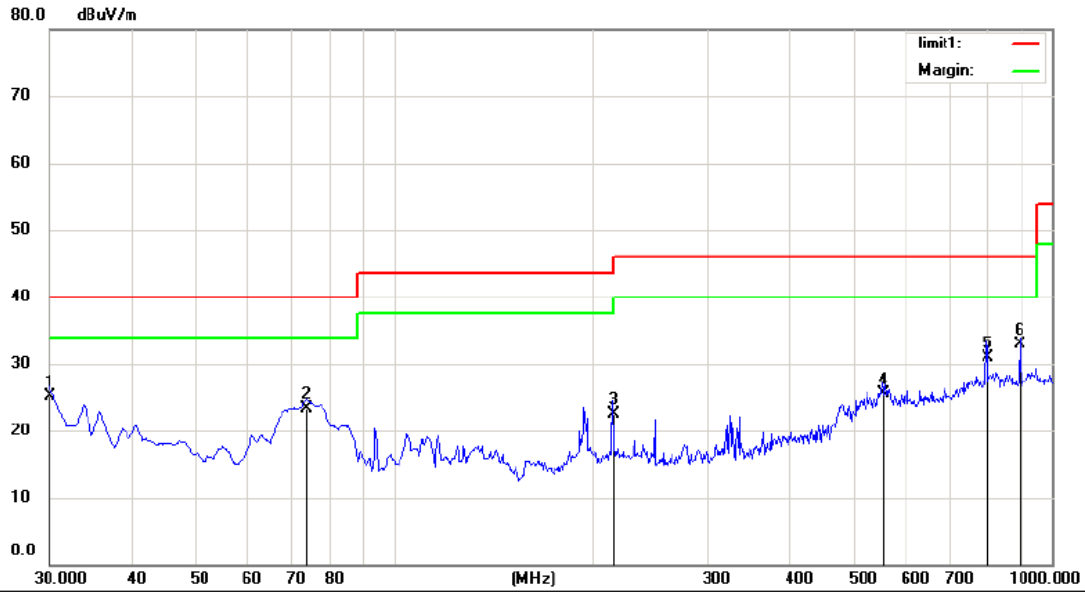

Site Chamber #1 Polarization: **Vertical** Temperature: 26  
 Limit: (RE)FCC PART 15 class B 3m Power: Connect to PC Humidity: 55 %  
 Mode: TX2462  
 Note:

No.	Mk.	Freq.	Reading Level	Correct Factor	Measurement	Limit	Over	Antenna Height	Table Degree	
		MHz	dBuV	dB	dBuV/m	dBuV/m	dB	cm	degree	Comment
1		30.0000	40.29	-15.15	25.14	40.00	-14.86	QP		
2		73.6500	45.82	-22.57	23.25	40.00	-16.75	QP		
3		215.2700	39.01	-16.46	22.55	43.50	-20.95	QP		
4		553.8000	34.84	-9.29	25.55	46.00	-20.45	QP		
5		797.2700	36.09	-5.21	30.88	46.00	-15.12	QP		
6	*	895.2400	36.58	-3.75	32.83	46.00	-13.17	QP		

\*:Maximum data x:Over limit !:over margin

Operator: Snake



**Above 1000MHz:**

Operation Mode: 802.11b Lowest Test Date : December 26, 2014

Freq. (MHz)	Ant. Pol. H/V	Emission Level(dBuV/m)		Limit 3m(dBuV/m)		Over(dB)	
		PK	AV	PK	AV	PK	AV
4824	V	63.28	44.28	74	54	-10.72	-9.72
7236	V	62.74	43.15	74	54	-11.26	-10.85
9648	V	61.03	42.19	74	54	-12.97	-11.81
12060	V	60.79	41.28	74	54	-13.21	-12.72
14472	V	59.37	40.35	74	54	-14.63	-13.65
16884	V	58.02	38.59	74	54	-15.98	-15.41
4824	H	66.28	45.72	74	54	-7.72	-8.28
7236	H	64.72	44.28	74	54	-9.28	-9.72
9648	H	63.92	43.69	74	54	-10.08	-10.31
12060	H	62.15	42.15	74	54	-11.85	-11.85
14472	H	60.82	40.82	74	54	-13.18	-13.18
16884	H	59.38	38.76	74	54	-14.62	-15.24

Operation Mode: 802.11b Middle Test Date : December 26, 2014

Freq. (MHz)	Ant. Pol. H/V	Emission Level(dBuV/m)		Limit 3m(dBuV/m)		Over(dB)	
		PK	AV	PK	AV	PK	AV
4874	V	66.35	44.78	74	54	-7.65	-9.22
7311	V	65.37	43.15	74	54	-8.63	-10.85
9688	V	64.18	42.92	74	54	-9.82	-11.08
12185	V	63.08	41.08	74	54	-10.92	-12.92
14622	V	62.12	40.33	74	54	-11.88	-13.67
17059	V	60.37	38.95	74	54	-13.63	-15.05
4874	H	65.38	45.02	74	54	-8.62	-8.98
7311	H	64.82	44.72	74	54	-9.18	-9.28
9688	H	63.04	43.69	74	54	-10.96	-10.31
12185	H	62.85	42.01	74	54	-11.15	-11.99
14622	H	61.75	41.82	74	54	-12.25	-12.18
17059	H	60.95	40.37	74	54	-13.05	-13.63

Operation Mode: 802.11b Highest

Test Date : December 26, 2014

Freq. (MHz)	Ant. Pol.	Emission Level(dBuV/m)		Limit 3m(dBuV/m)		Over(dB)	
		PK	AV	PK	AV	PK	AV
4924	V	66.32	45.33	74	54	-7.68	-8.67
7386	V	65.72	44.18	74	54	-8.28	-9.82
9848	V	64.01	43.08	74	54	-9.99	-10.92
12310	V	63.82	42.94	74	54	-10.18	-11.06
14772	V	62.95	41.08	74	54	-11.05	-12.92
17234	V	60.72	40.33	74	54	-13.28	-13.67
4924	H	65.72	46.38	74	54	-8.28	-7.62
7386	H	63.59	45.38	74	54	-10.41	-8.62
9848	H	62.25	44.15	74	54	-11.75	-9.85
12310	H	61.03	43.95	74	54	-12.97	-10.05
14772	H	60.85	42.17	74	54	-13.15	-11.83
17234	H	59.48	40.37	74	54	-14.52	-13.63

**All emissions not reported were more than 20dB below the specified limit or in the noise floor.**

- Note:**
- (1) All Readings are Peak Value and AV.
  - (2) Emission Level= Reading Level+Probe Factor +Cable Loss.
  - (3) Data of measurement within this frequency range shown “ – ” in the table above means the reading of emissions are attenuated more than 20dB below the permissible limits or the field strength is too small to be measured.

## 10. 6dB Bandwidth Test

### 10.1 Measurement Procedure

The EUT was operating in IEEE 802.11b, 802.11g, 802.11n(H20), 802.11n(H40) mode or could be controlled its channel. Printed out the test result from the spectrum by hard copy function.

1. Set resolution bandwidth (RBW) = 100 kHz.
2. Set the video bandwidth (VBW)  $\geq 3 \times$  RBW.
3. Detector = Peak.
4. Trace mode = max hold.
5. Sweep = auto couple.
6. Allow the trace to stabilize.
7. Measure the maximum width of the emission that is constrained by the frequencies associated with the two outermost amplitude points (upper and lower frequency) that are attenuated by 6 dB relative to the maximum level measured in the fundamental emission.

### 10.2 Test SET-UP (Block Diagram of Configuration)

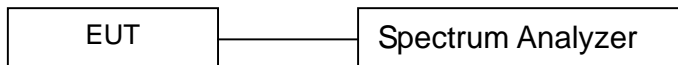

### 10.3 Measurement Equipment Used

EQUIPMENT TYPE	MFR	MODEL NUMBER	SERIAL NUMBER	LAST CAL.	CAL DUE.
Spectrum Analyzer	Agilent	FSV30	1321.3008K	05/16/2014	05/15/2015

### 10.4 Measurement Results

6 Bandwidth Test Data Chart:

Refer to attached data chart.

Spectrum Detector: PK  
 Test By: Andy  
 Humidity : 60%

Test Date : December 26, 2014  
 Temperature : 28°C

IEEE 802.11b SISO Ant1			
Channel frequency (MHz)	Measurement level (KHz)	Required Limit (KHz)	Result
2412	10050	>500	Pass
2437	10050	>500	
2462	10050	>500	

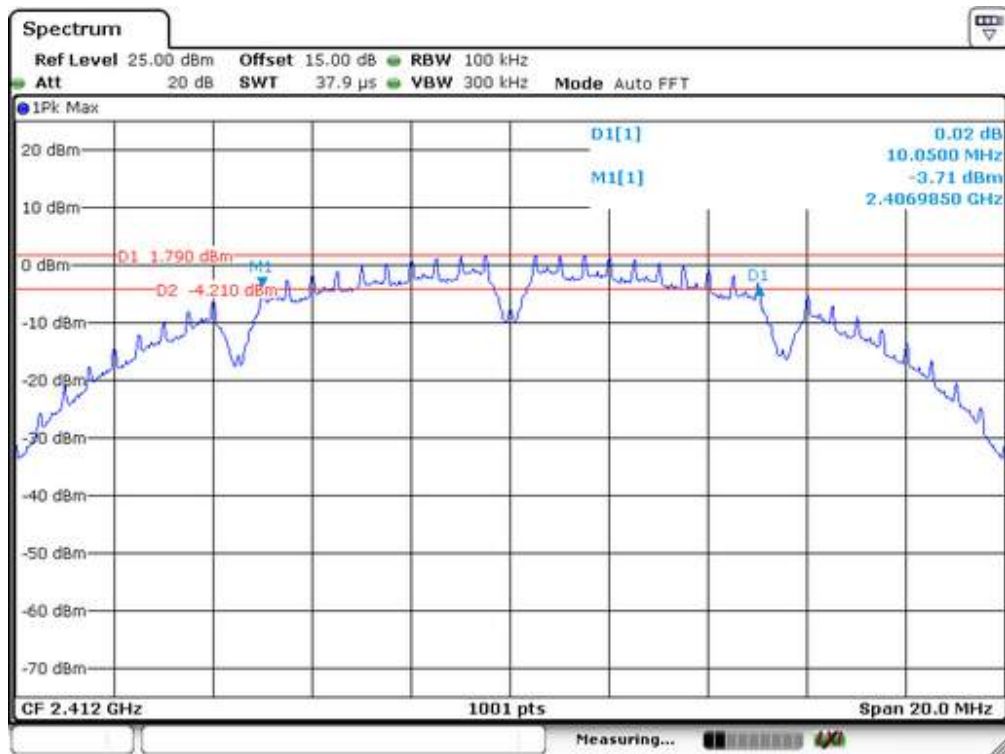

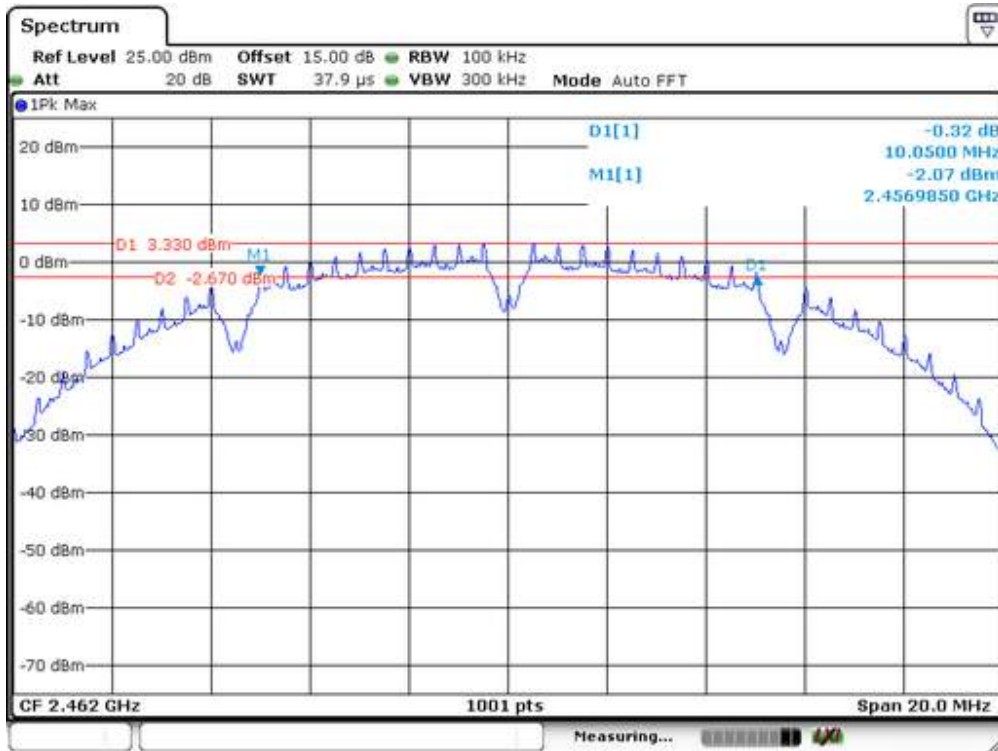
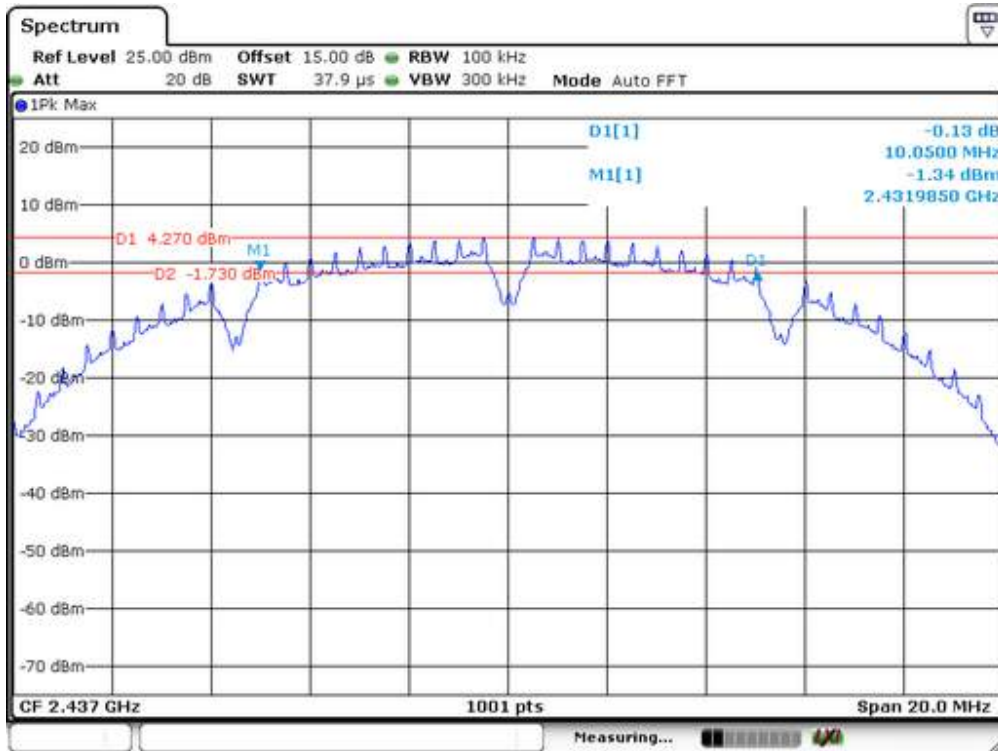

IEEE 802.11b SISO Ant2			
Channel frequency (MHz)	Measurement level (KHz)	Required Limit (KHz)	Result
2412	10050	>500	Pass
2437	10050	>500	
2462	10050	>500	

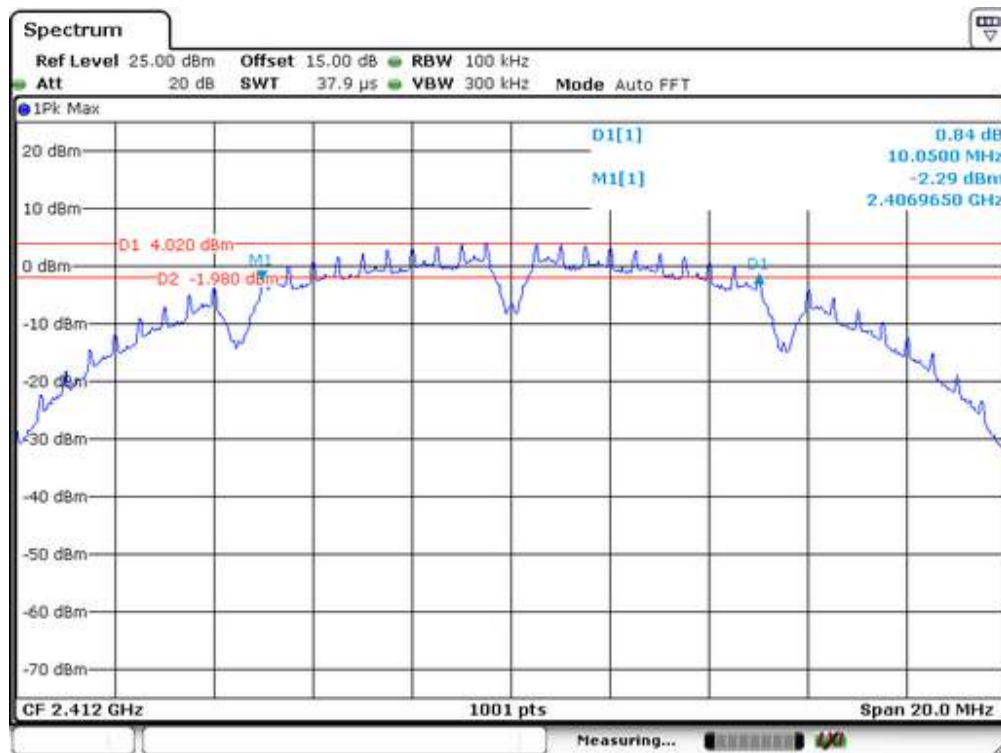

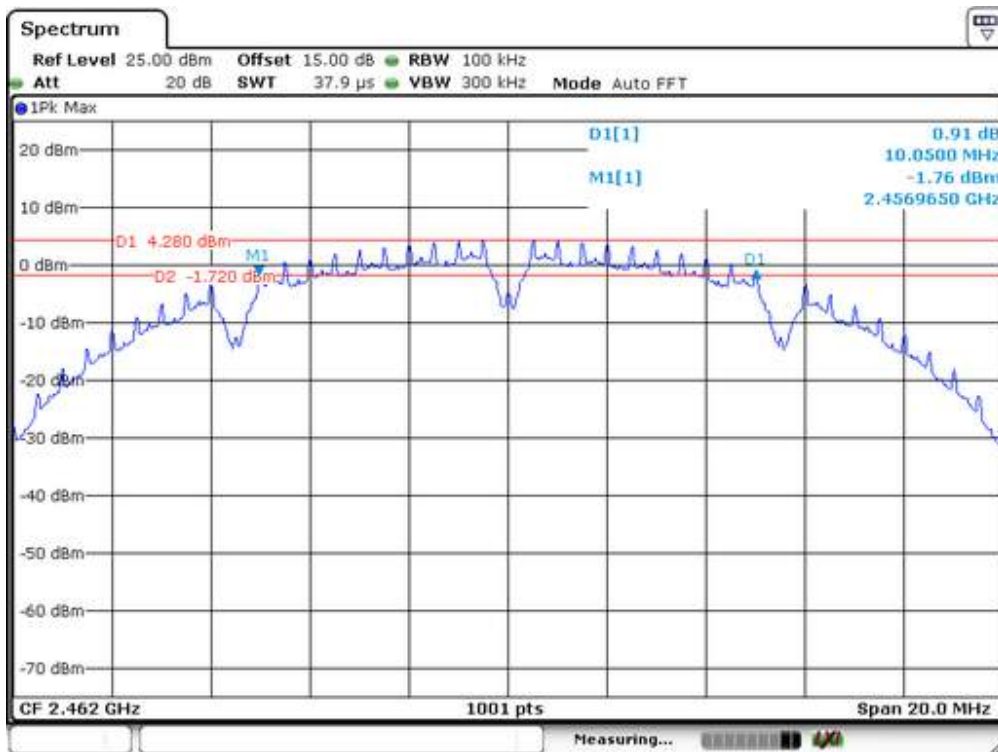
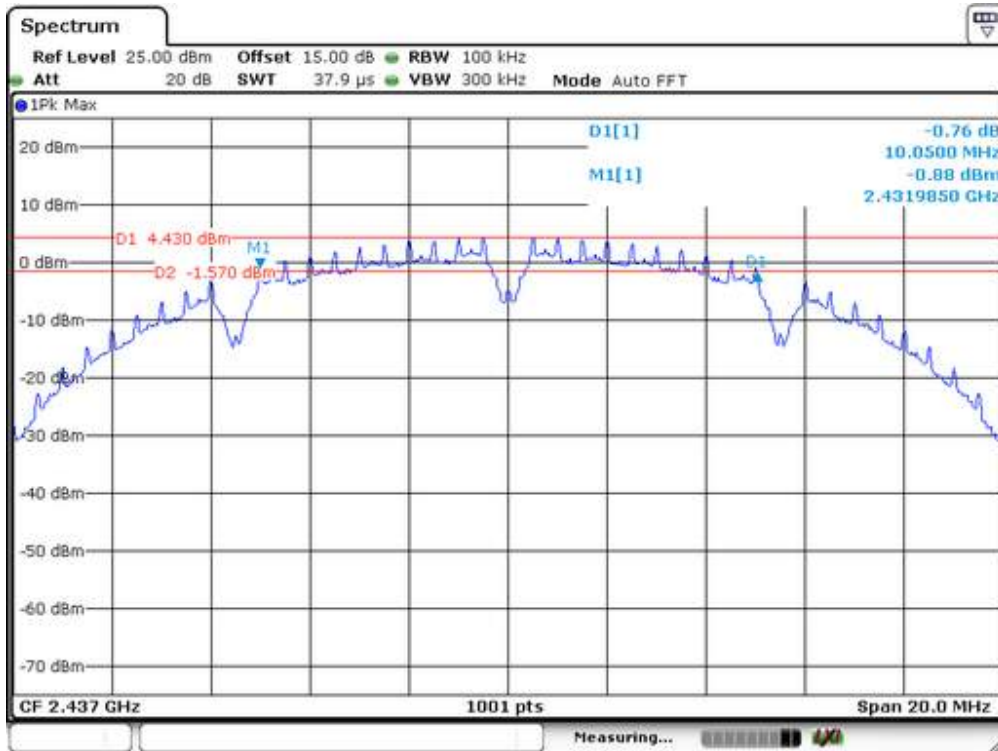

IEEE 802.11g SISO Ant1			
Channel frequency (MHz)	Measurement level (KHz)	Required Limit (KHz)	Result
2412	16324	>500	Pass
2437	16324	>500	
2462	16324	>500	

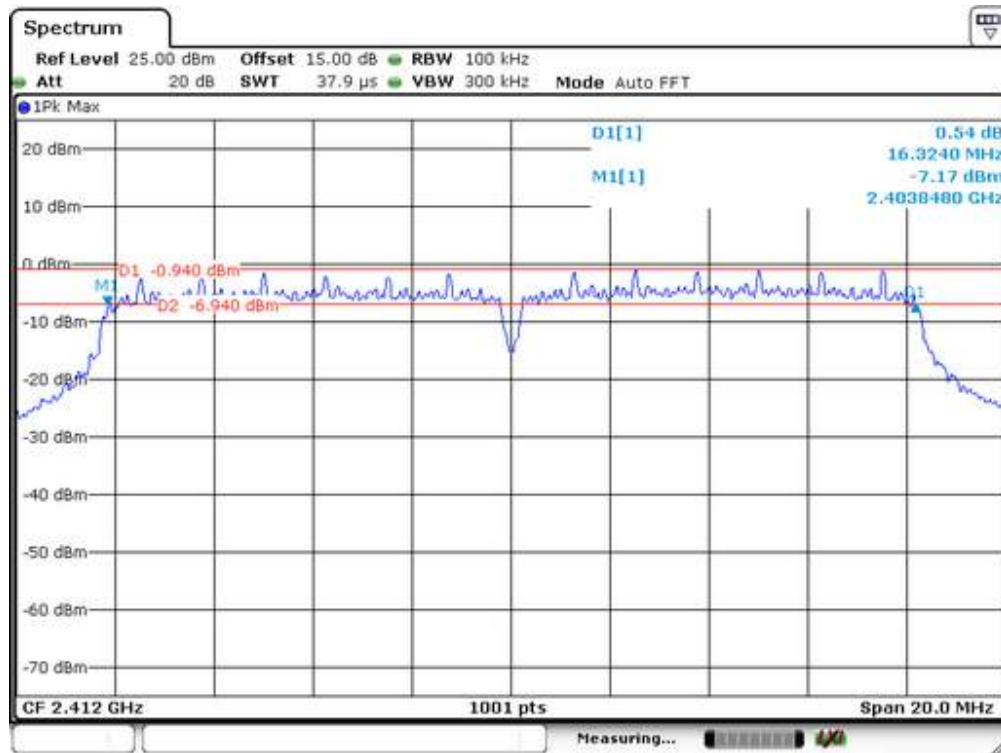



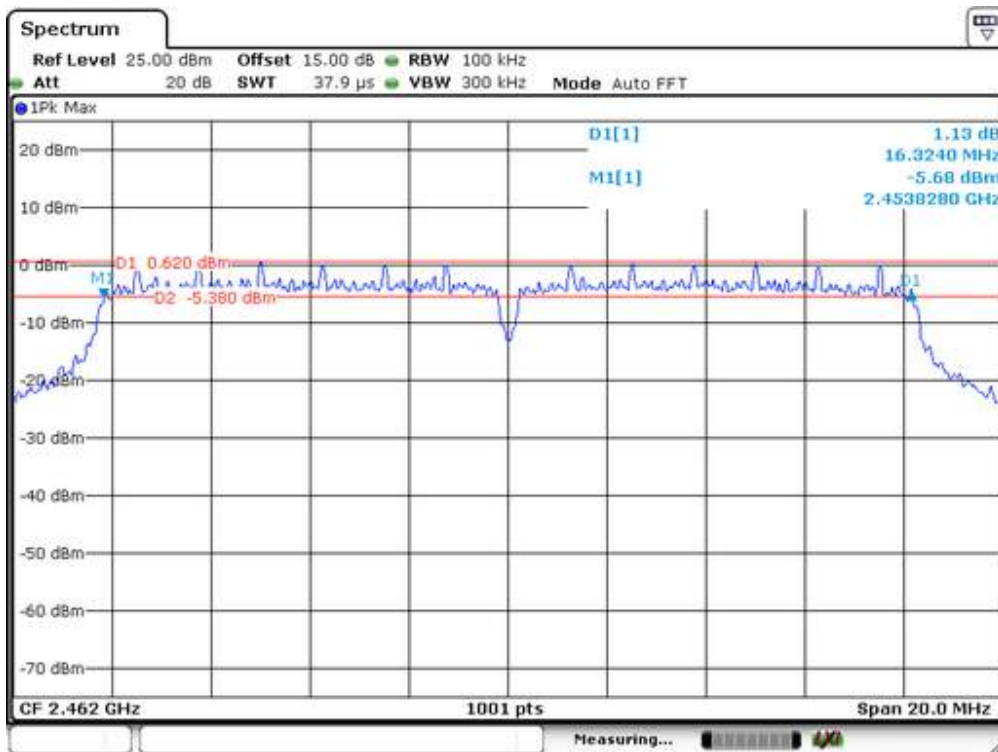
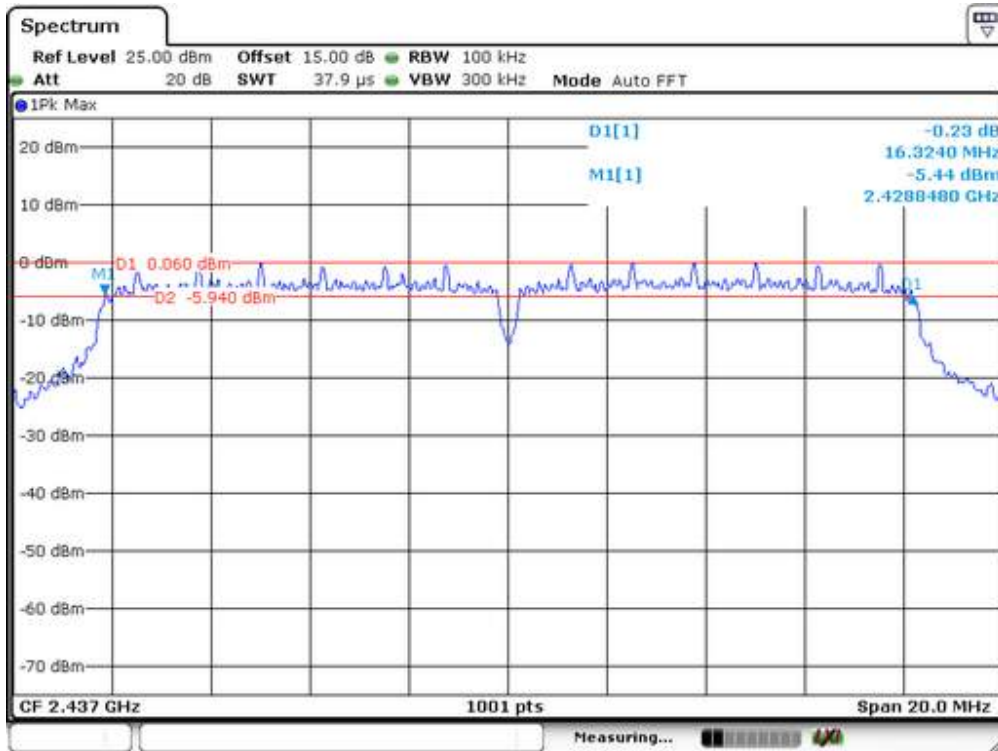

IEEE 802.11g SISO Ant2			
Channel frequency (MHz)	Measurement level (KHz)	Required Limit (KHz)	Result
2412	16324	>500	Pass
2437	16324	>500	
2462	16324	>500	

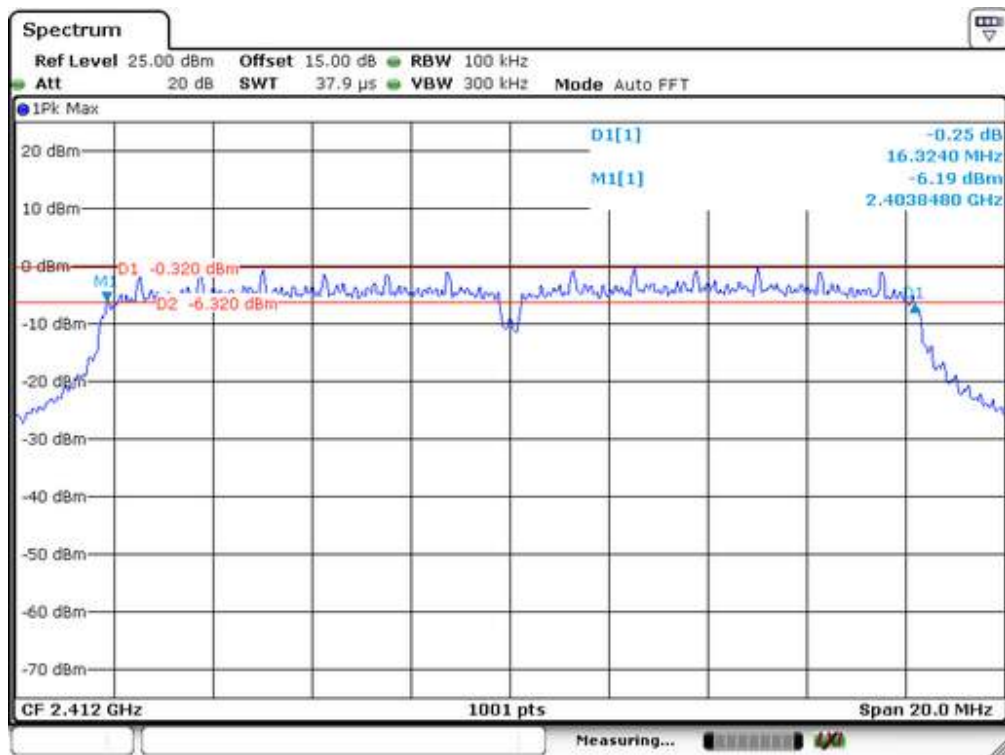

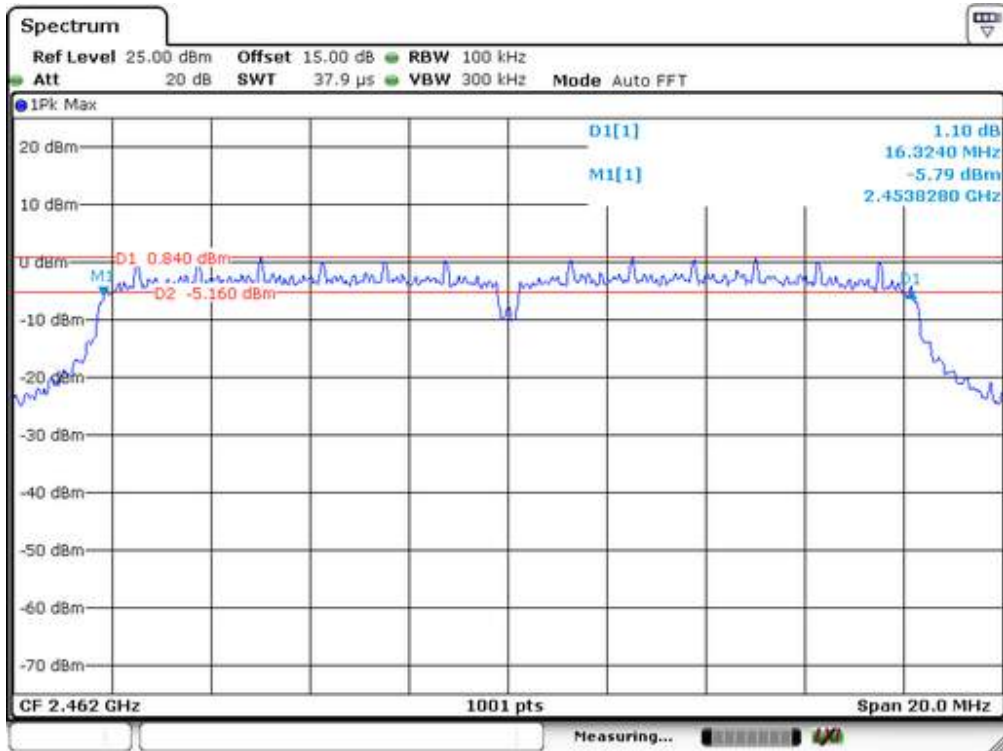
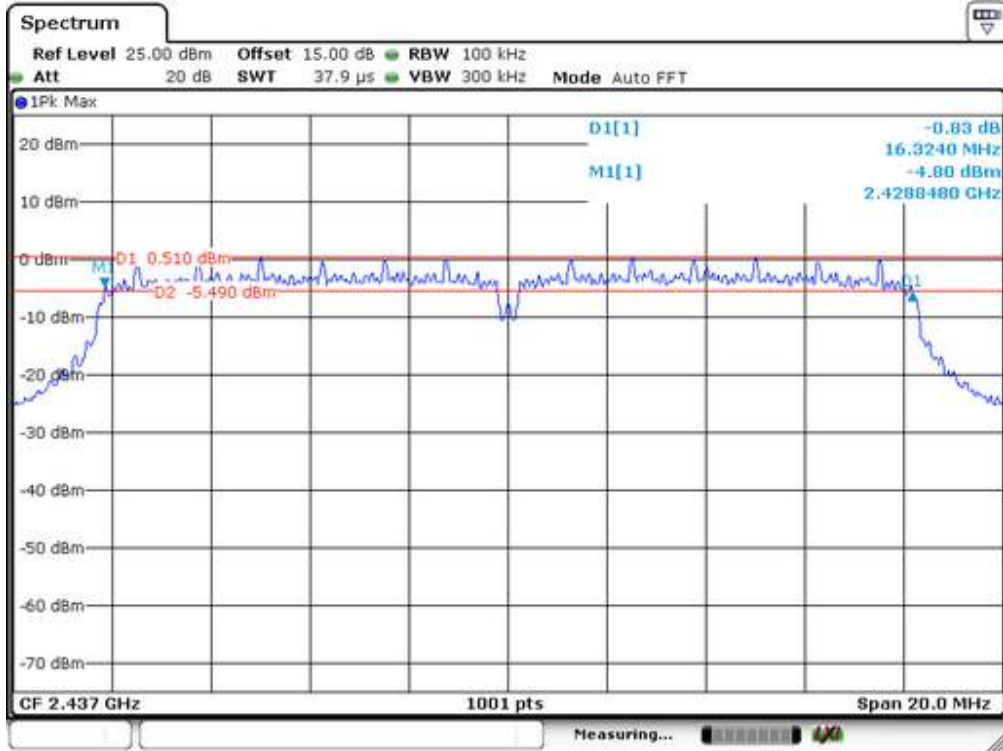

IEEE 802.11n(H20) MIMO				
Channel frequency (MHz)	Measurement level (KHz)		Required Limit (KHz)	Result
	Ant1	Ant2		
2412	17502	17283	>500	Pass
2437	17502	17383	>500	
2462	17502	17483	>500	

Ant1

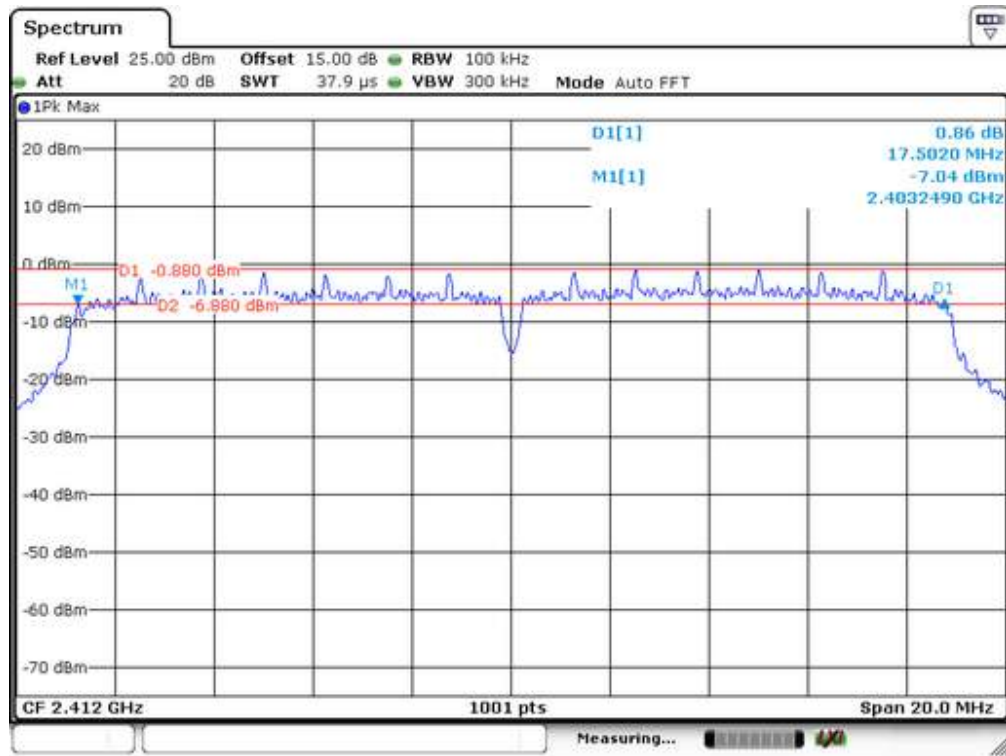

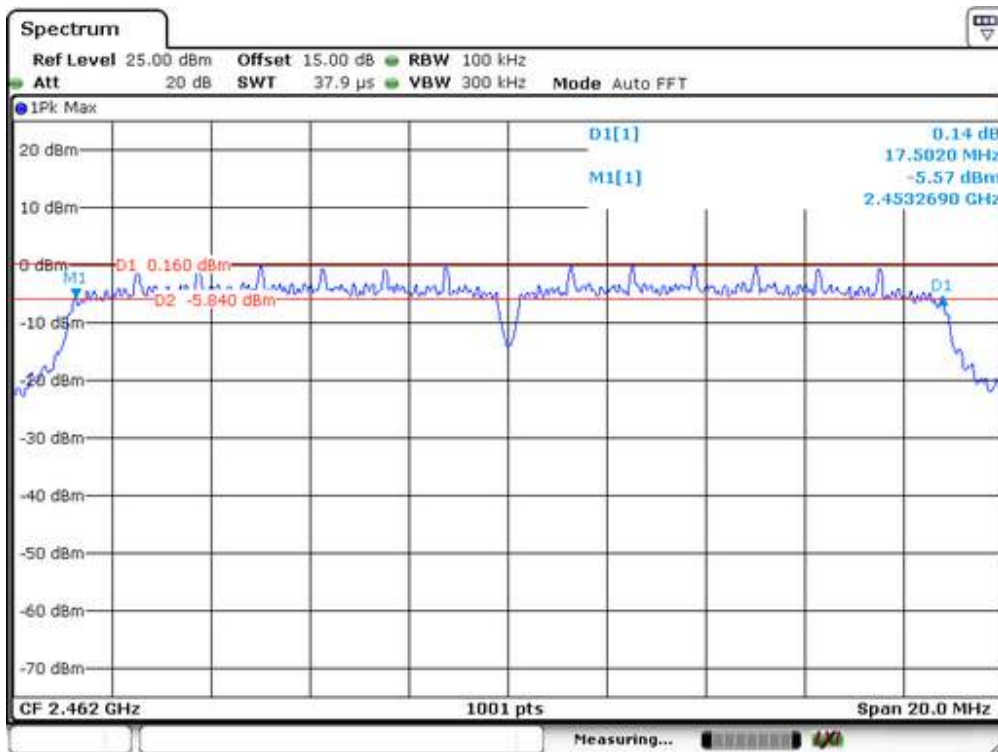
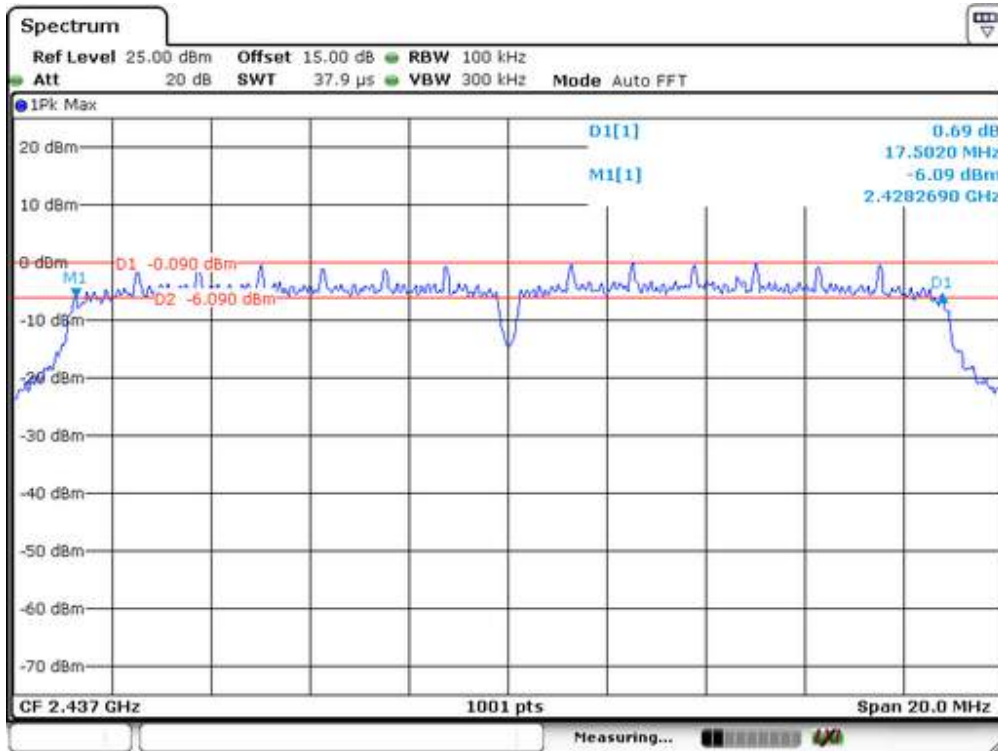

Ant2

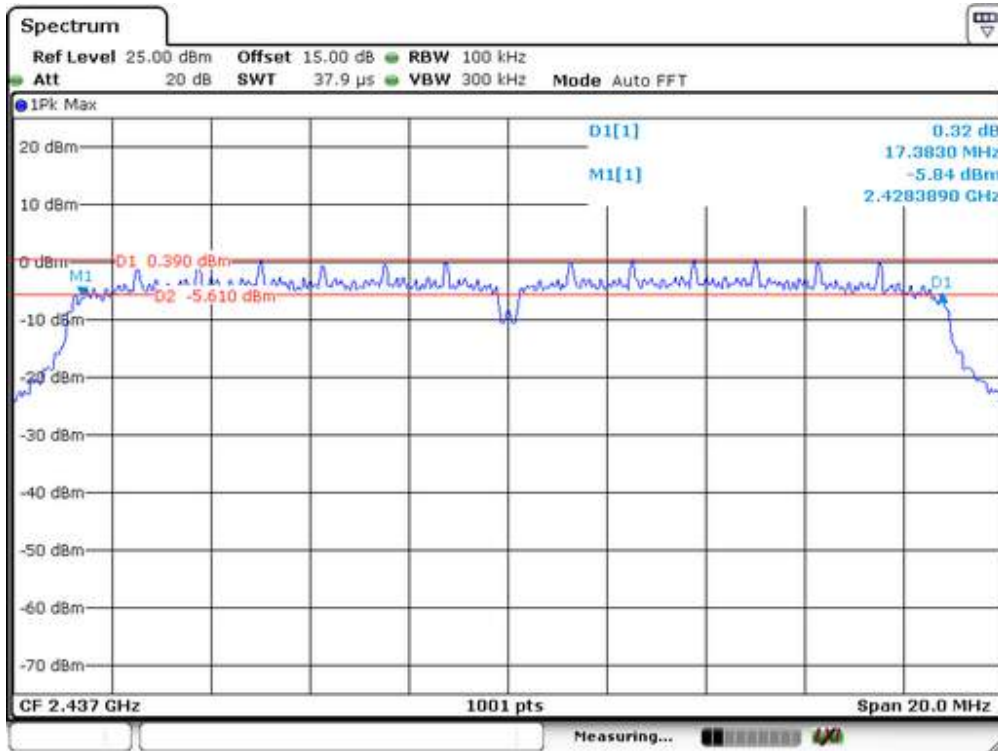
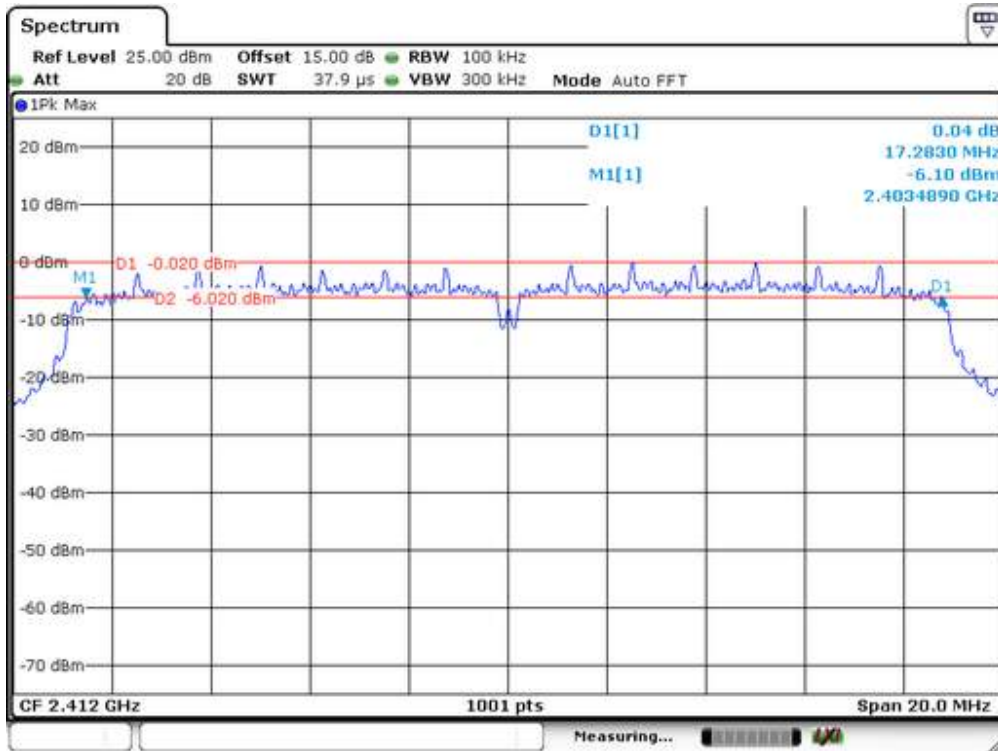

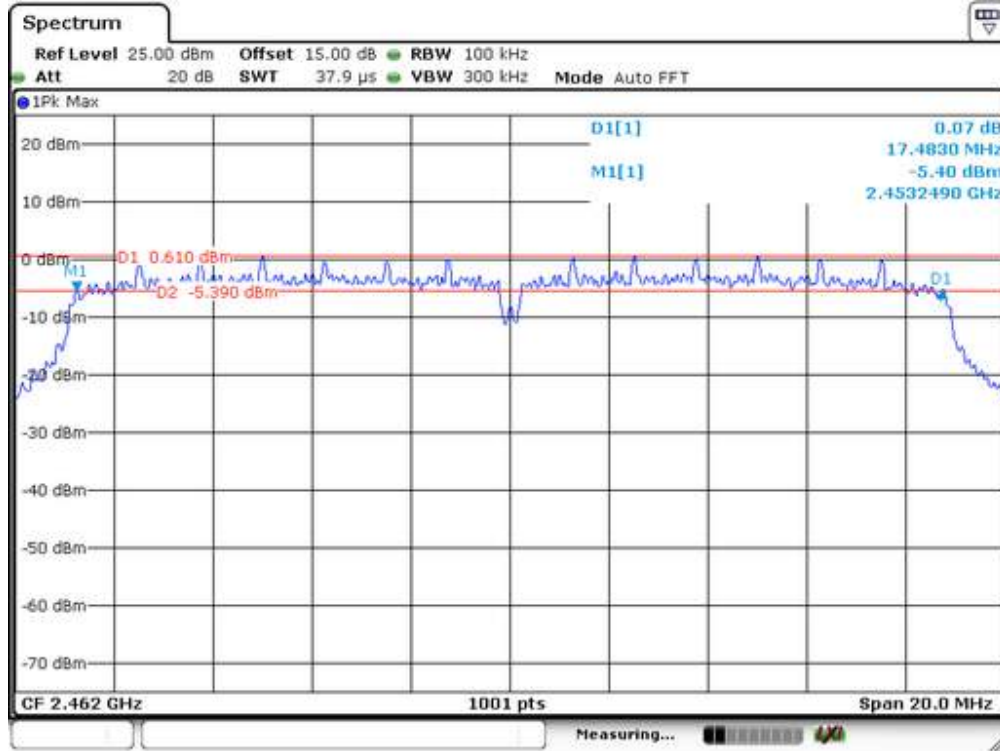

IEEE 802.11n (H40) MIMO				
Channel frequency (MHz)	Measurement level (KHz)		Required Limit (KHz)	Result
	Ant1	Ant2		
2422	35445	35445	>500	Pass
2437	35365	35365	>500	
2452	35445	35485	>500	

### Ant1

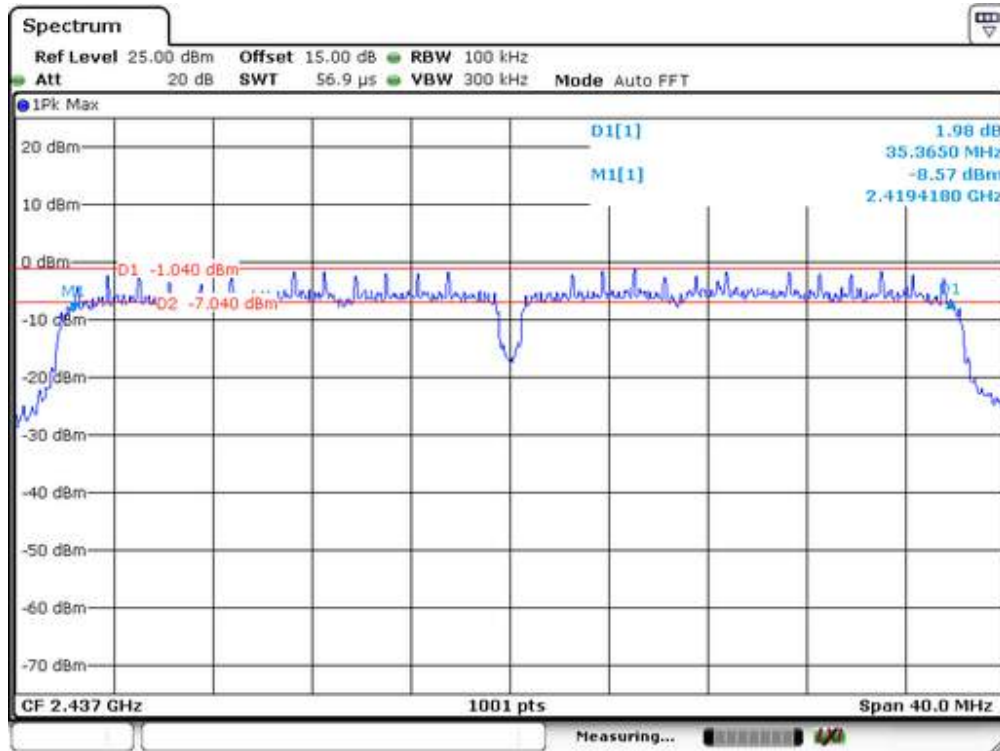
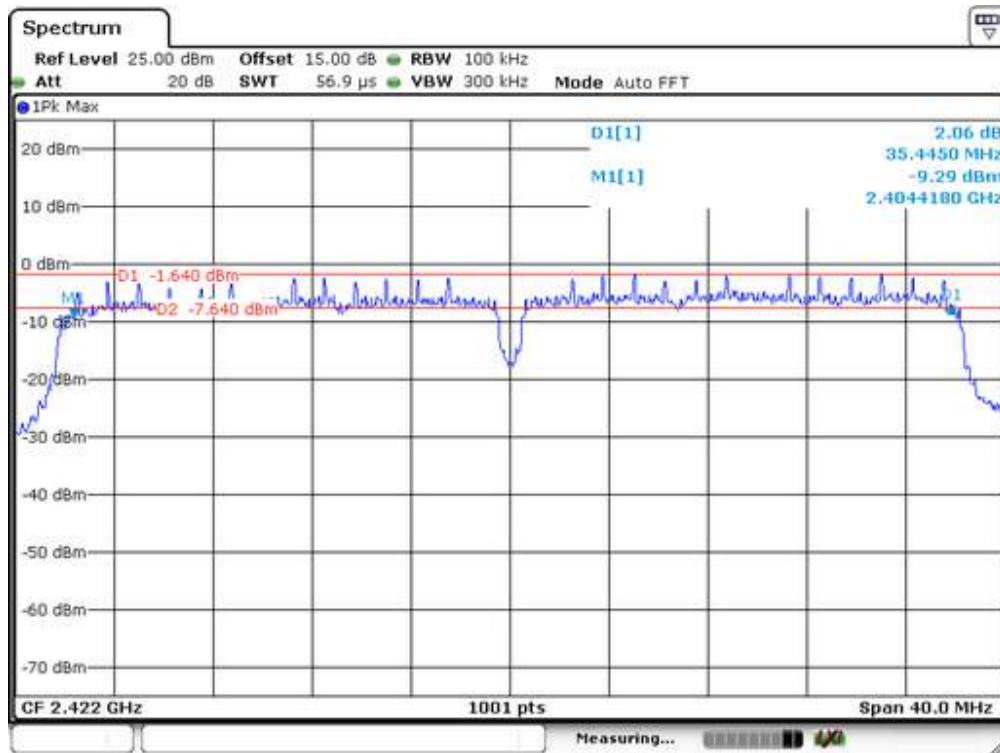



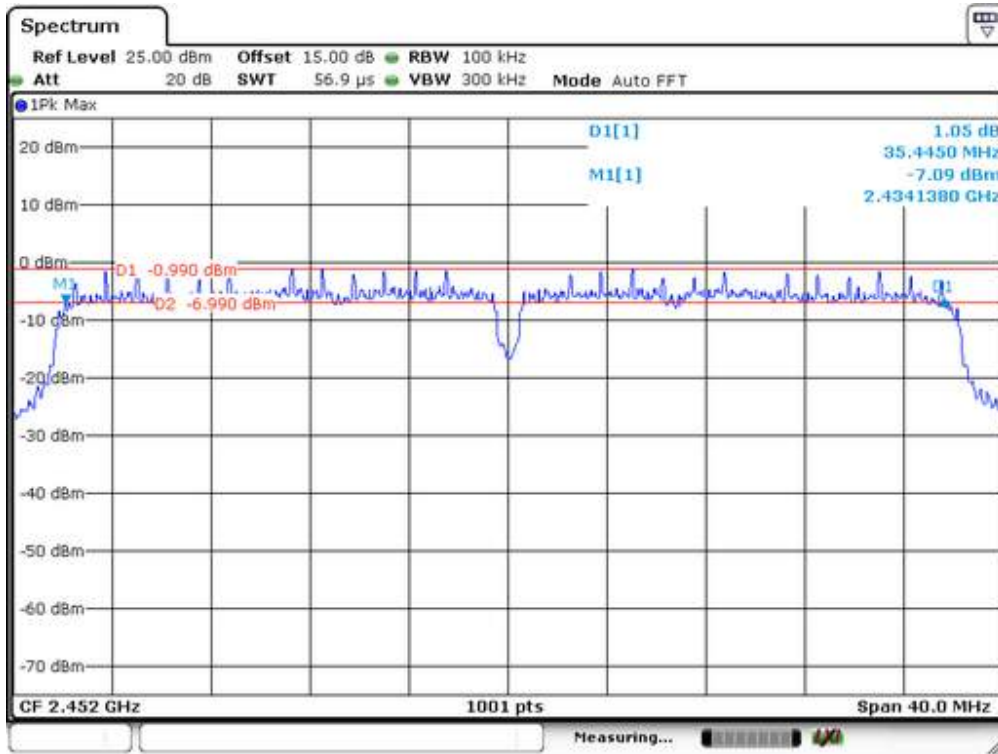

Ant2

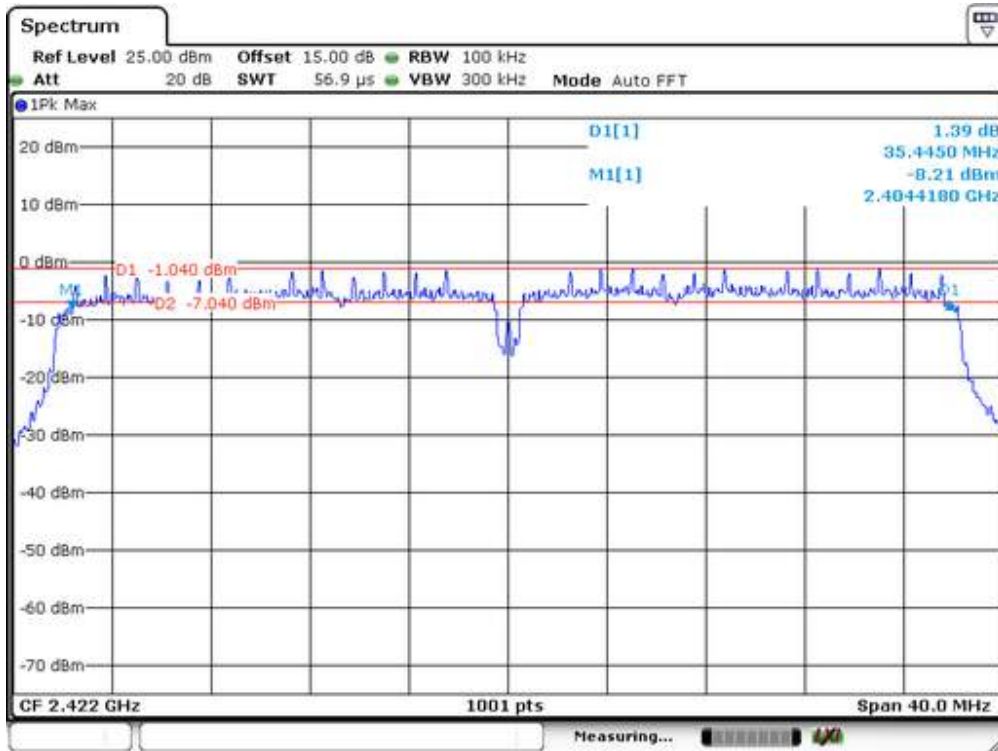

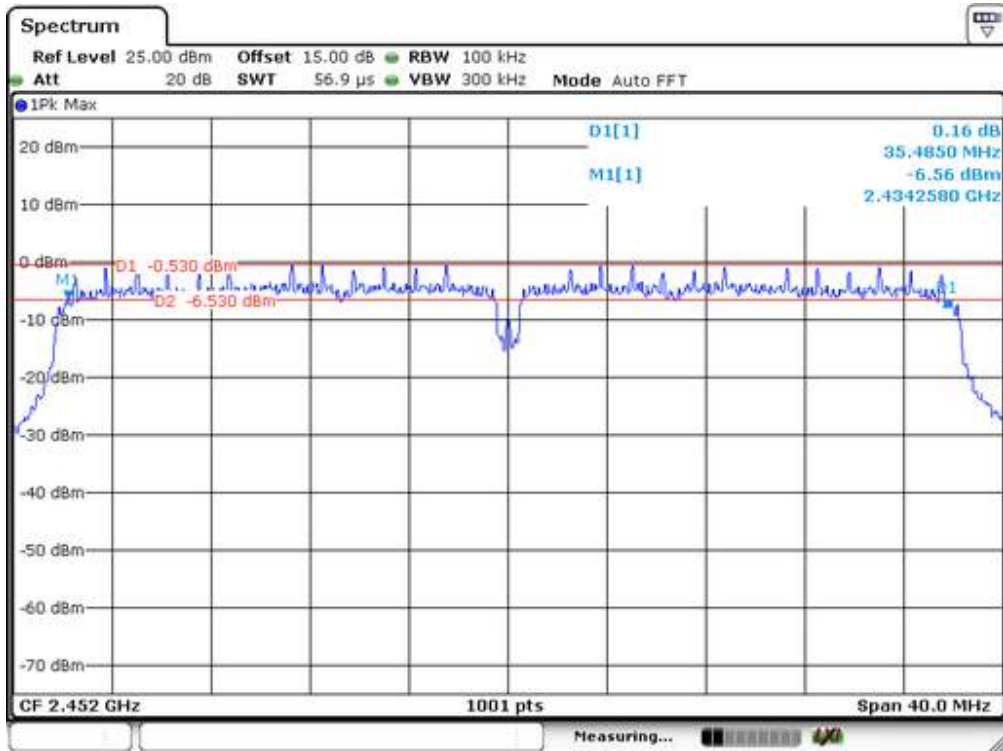
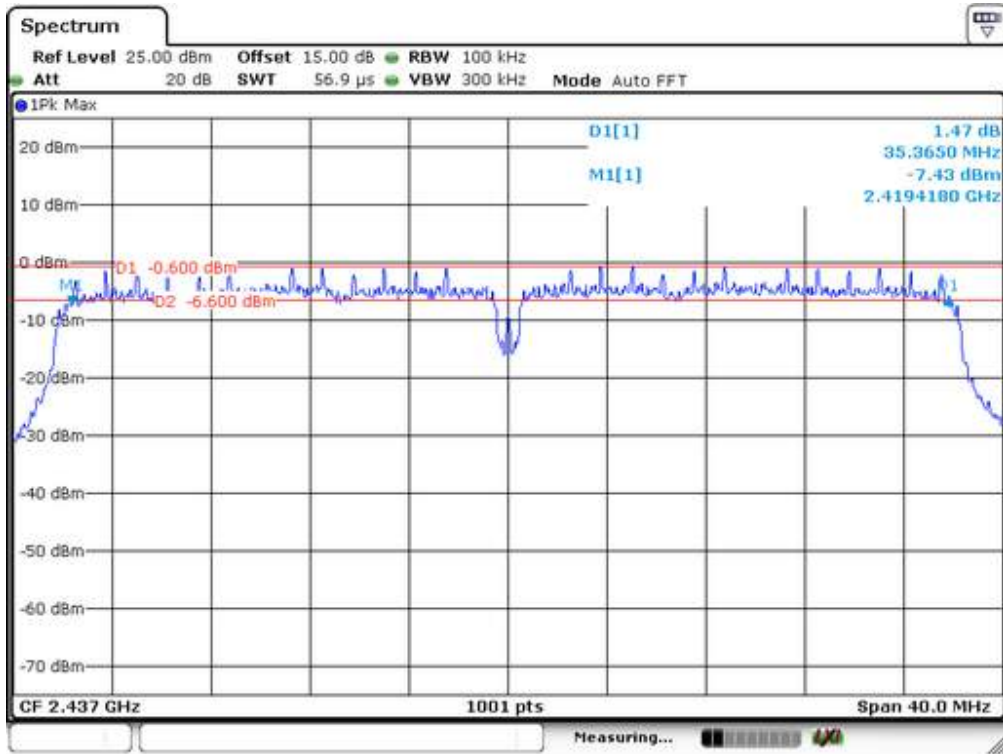

## 11. Maximum Peak Output Power Test

### 11.1 Measurement Procedure

(1) According to FCC Part 15.247(b)(3)

The maximum peak conducted output power may be measured using a broadband peak RF power meter. The power meter shall have a video bandwidth that is greater than or equal to the DTS bandwidth and shall utilize a fast-responding diode detector.

The testing follows FCC public Notice DA 00-705 Measurement Guidelines.

The RF output of EUT was connected to the power meter by RF cable and attenuator. The path loss was compensated to the results for each measurement.

Set to the maximum output power setting and enable the EUT transmit continuously.

Measure the conducted output power with cable loss and record the results in the test report.

Measure and record the results in the report.

(2) According to FCC Part 15.247(b)(4):

Conducted output power limit specified in paragraph (b) of this section is based on the use of antennas with directional gains that do not exceed 6 dBi. If transmitting antennas of directional gain greater than 6 dBi are used, the conducted output power from the intentional radiator shall be reduced below the stated values in paragraphs (b)(3) of this section, as appropriate, by the amount in dB that the directional gain of the antenna exceeds 6 dBi.

Note: If antenna Gain exceeds 6 dBi, then Output power Limit = 30 - (Gain - 6)

### 11.2 Test SET-UP (Block Diagram of Configuration)



### 11.3 Measurement Equipment Used

EQUIPMENT TYPE	MODEL NUMBER	SERIAL NUMBER	LAST CAL.	CAL DUE.
Power meter	ML2495A	0824006	05/16/2014	05/15/2015
Power sensor	MA2411B	0738172	05/16/2014	05/15/2015

### 11.4 Peak Power output limit

The maximum peak conducted output power of the intentional radiator for systems using digital modulation in the 2400 - 2483.5 MHz bands shall not exceed: 1 Watt (30dBm).

## 11.5 Measurement Results

Spectrum Detector: PK                      Test Date :                      December 26, 2014  
 Test By: Andy                                  Temperature :                      28°C  
 Test Result: PASS                              Humidity :                              60%

Operation Mode	Channel Number	Channel Frequency (MHz)	Measurement Level (dBm)			Limit (dBm)	Verdict
			Ant1	Ant2	Sum		
802.11b	1	2412	15.30	17.24	--	30	PASS
	6	2437	16.41	16.38	--	30	PASS
	11	2462	16.52	18.42	--	30	PASS
802.11g	1	2412	14.05	15.04	--	30	PASS
	6	2437	13.95	13.42	--	30	PASS
	11	2462	12.85	12.04	--	30	PASS
802.11n (HT20)	1	2412	11.13	10.65	14.32	30	PASS
	6	2437	10.92	9.46	13.42	30	PASS
	11	2462	9.42	8.04	11.34	30	PASS
802.11n (HT40)	3	2422	9.38	9.34	12.10	30	PASS
	6	2437	8.67	8.16	10.81	30	PASS
	9	2452	7.49	7.07	9.30	30	PASS

**Note:**

1. For MIMO System of 802.11n(HT20) and 802.11n(HT40), total power is calculated by combining the output power of each antenna according to KDB662911.
2. Antenna 1 Gain: 1.8dBi, Antenna 2 Gain: 1.8dBi. For antennas with gains of 6dBi or less, maximum allowed Transmitter output watt(+30dBm)
3. In MIMO, Ant1+Ant2 Directional Gain= $G_{ANT}+10\text{Log}(N)\text{dBi}=1.8+10\text{log}(2)=4.8\text{dBi}$ . For antennas with gains of 6dBi or less, maximum allowed Transmitter output watt(+30dBm).

## 12. Band Edge Test

### 12.1 Measurement Procedure

#### For Conducted Test

1. The testing follows FCC KDB Publication No. 558074 D01 DTS Meas. Guidance v03r02.
2. The RF output of EUT was connected to the spectrum analyzer by RF cable and attenuator. The path loss was compensated to the results for each measurement.
3. Set to the maximum power setting and enable the EUT transmit continuously.
4. Set RBW = 100 kHz, VBW=300 kHz, Peak Detector. Unwanted Emissions measured in any 100 kHz bandwidth outside of the authorized frequency band shall be attenuated by at least 20 dB relative to the maximum in-band peak PSD level in 100 kHz when maximum peak conducted output power procedure is used. Measure and record the results in the test report.
5. The RF fundamental frequency should be excluded against the limit line in the operating frequency band.

#### For Radiated emission Test

1. The testing follows FCC KDB Publication No. 558074 D01 DTS Meas. Guidance v03r02.
2. The EUT was arranged to its worst case and then tune the antenna tower (from 1 m to 4 m) and turntable (from 0 degree to 360 degrees) to find the maximum reading. A pre-amp and a high pass filter are used for the test in order to get better signal level.
3. The EUT was placed on a turntable with 0.8 meter above ground.
4. The EUT was set 3 meters from the interference receiving antenna, which was mounted on the top of a variable height antenna tower.
5. Corrected Reading: Antenna Factor + Cable Loss + Read Level - Preamp Factor = Level.
6. For measurement below 1GHz, If the emission level of the EUT measured by the peak detector is 3 dB lower than the applicable limit, the peak emission level will be reported. Otherwise, the emission measurement will be repeated using the quasi-peak detector and reported.
7. Repeat above procedures until all frequency measured were complete.

When spectrum scanned above 1GHz setting resolution bandwidth 1MHz, video bandwidth 3MHz.

EMI Test Receiver	Setting
Attenuation	Auto
RB	1MHz
VB	3MHz
Detector	Peak
Trace	Max hold

When spectrum scanned above 1GHz setting resolution bandwidth 1MHz, video bandwidth 10Hz.

EMI Test Receiver	Setting
Attenuation	Auto
RB	1MHz
VB	10Hz
Detector	Peak
Trace	Max hold

## 12.2 Test SET-UP (Block Diagram of Configuration)

As 6.2 Test set up (B) and (C)

## 12.3 Measurement Equipment Used

Same as 6.3 Radiated Emission Measurement.

## 12.4 Measurement Results

### 1. Conducted Test

Test Mode: IEEE 802.11b SISO Ant1

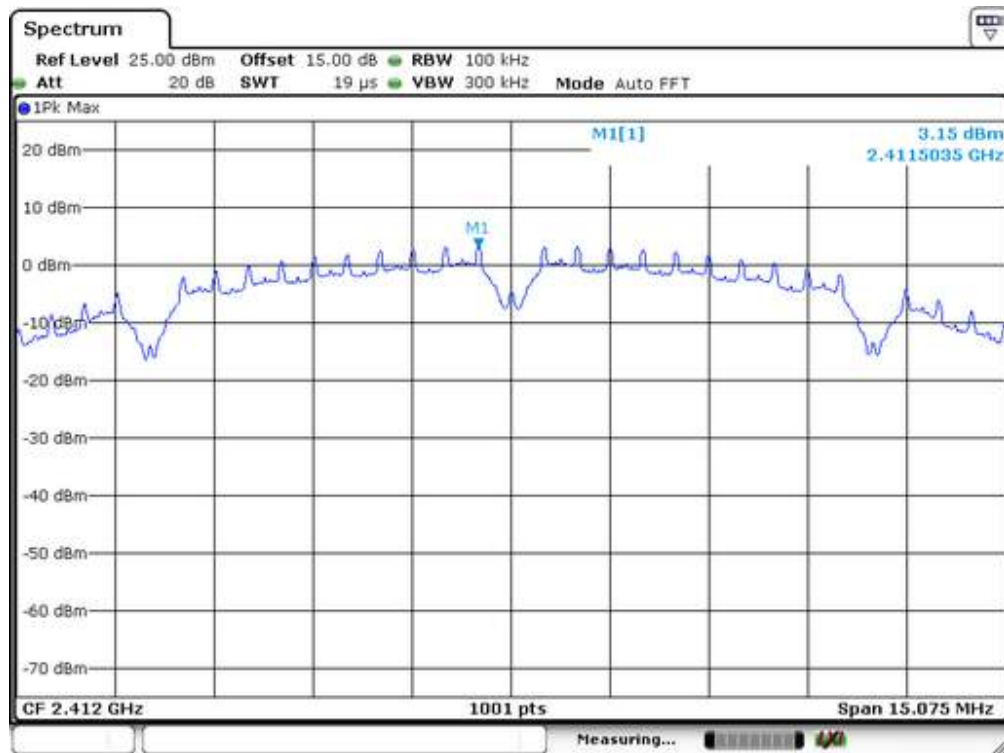

Lowest Channel

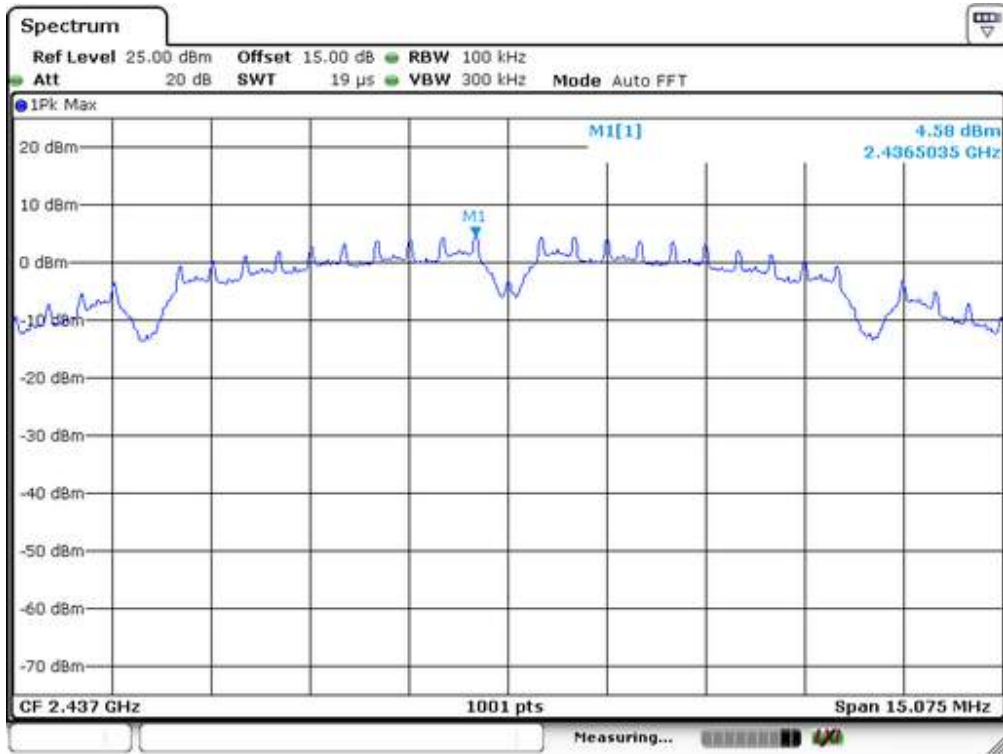

Middle Channel

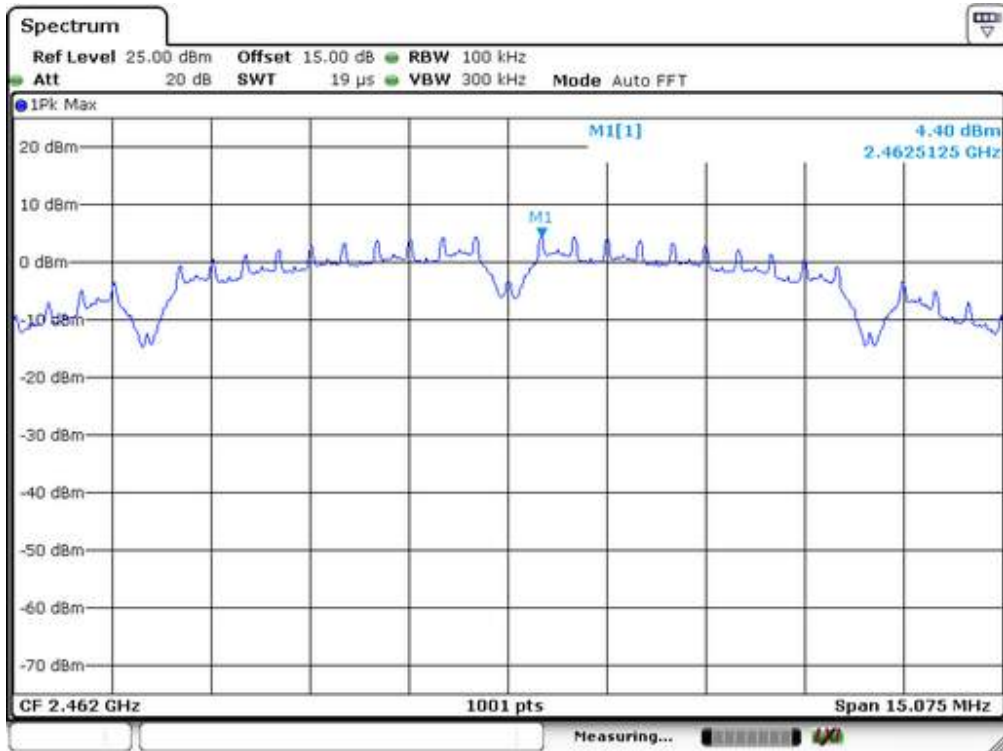

Highest Channel

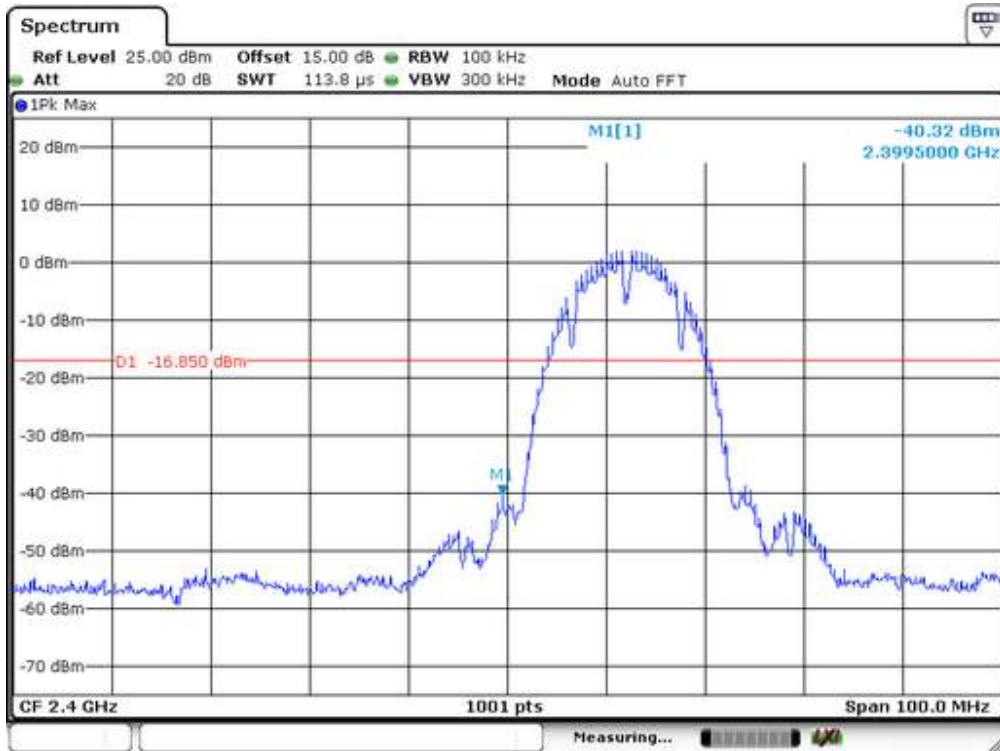

Lowest Channel

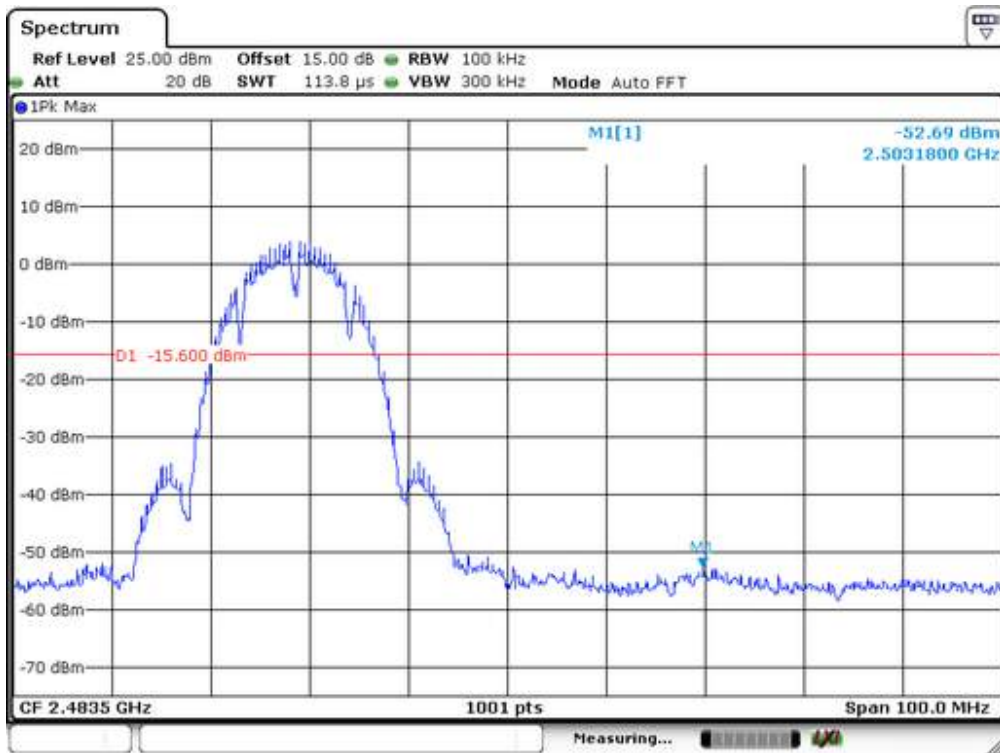

Highest Channel



Test Mode: IEEE 802.11b SISO Ant2

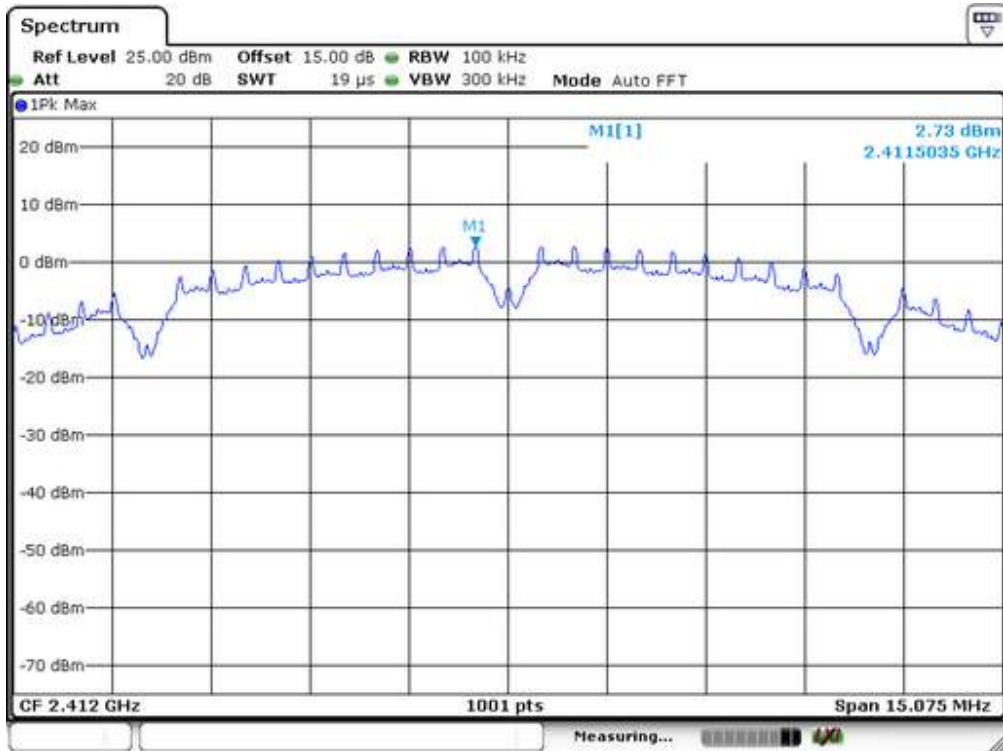

Lowest Channel

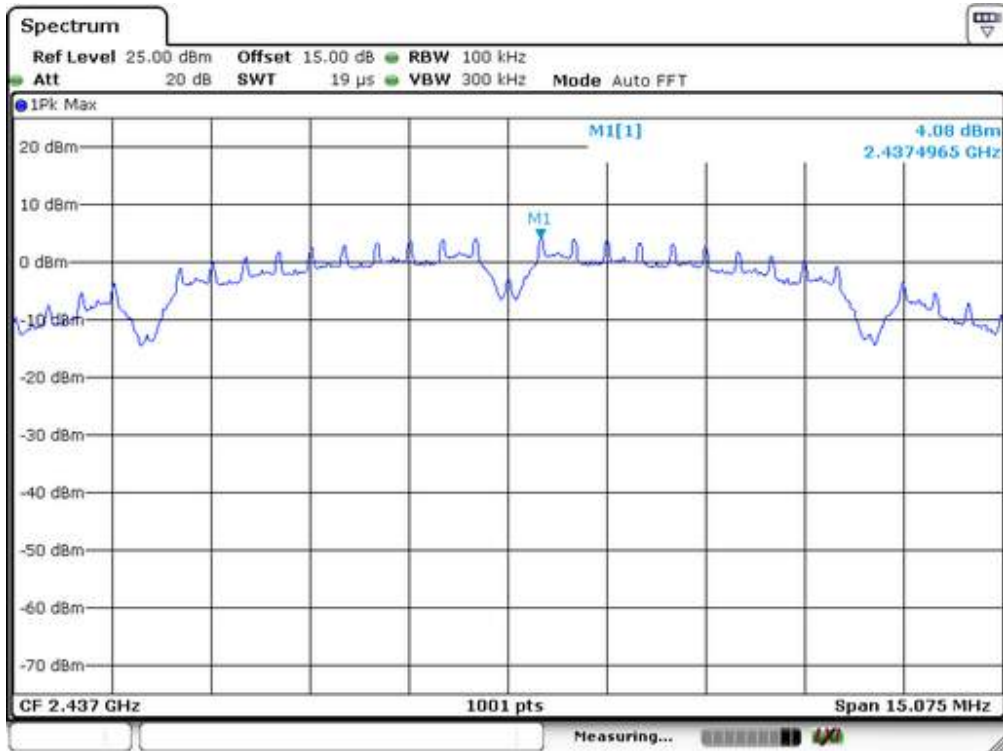

Middle Channel

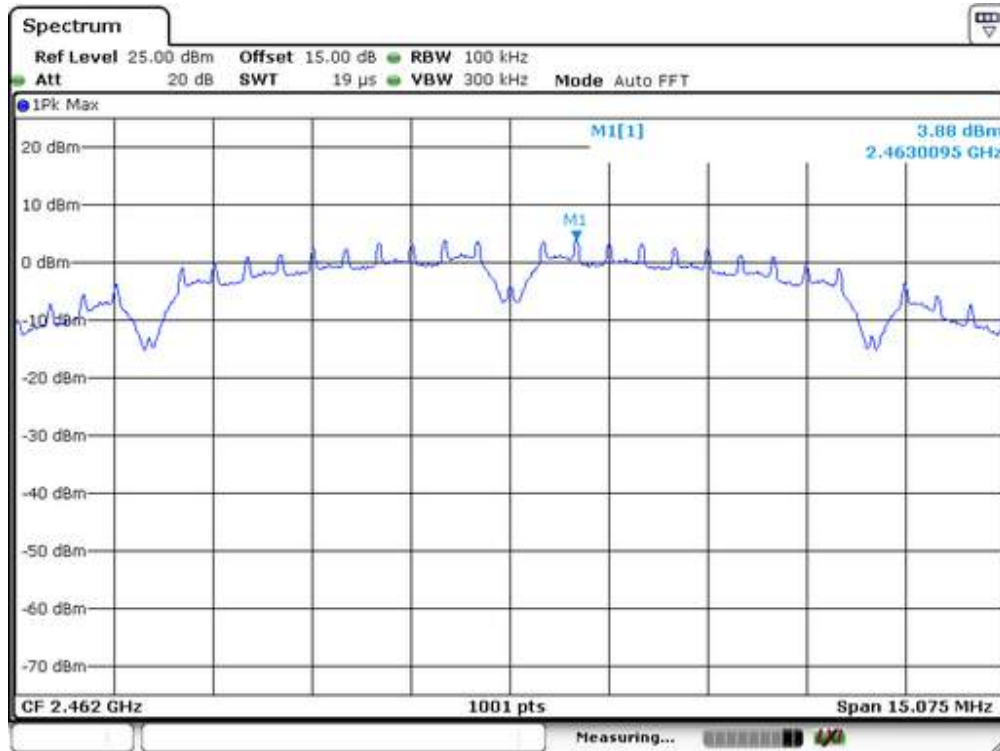

Highest Channel

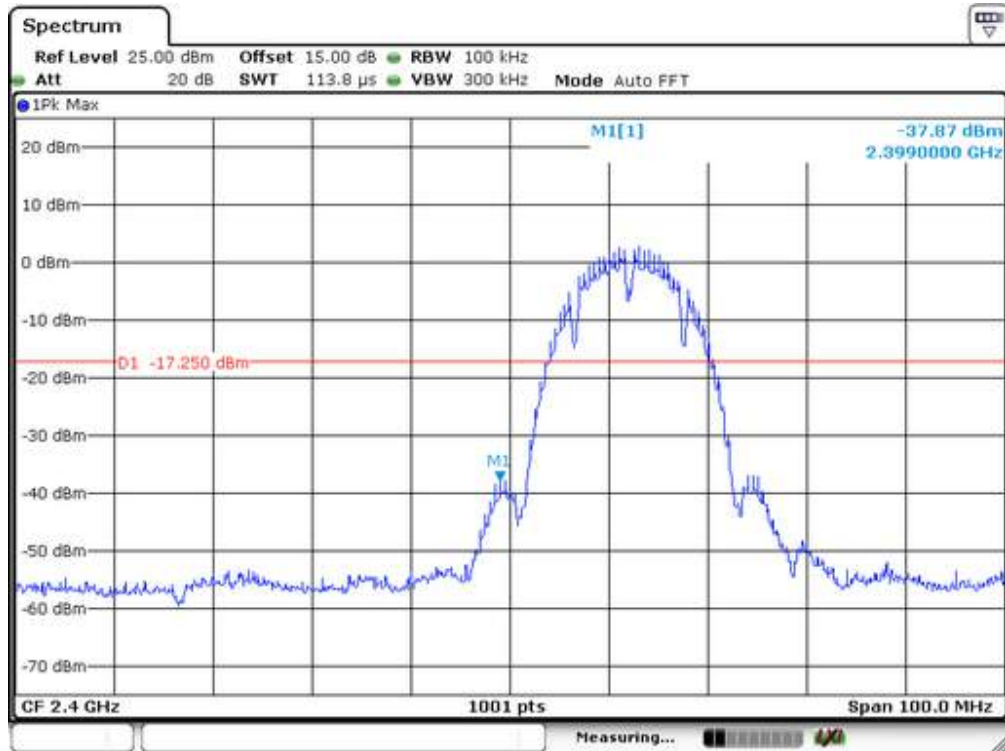

Lowest Channel

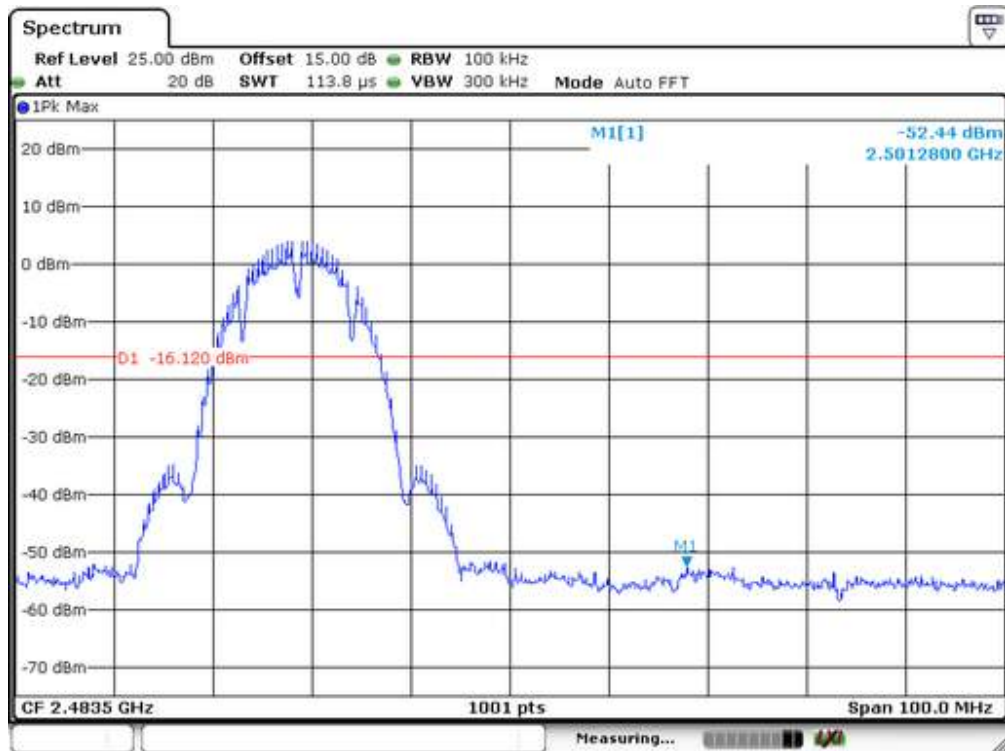

Highest Channel

Test Mode: IEEE 802.11g SISO Ant1

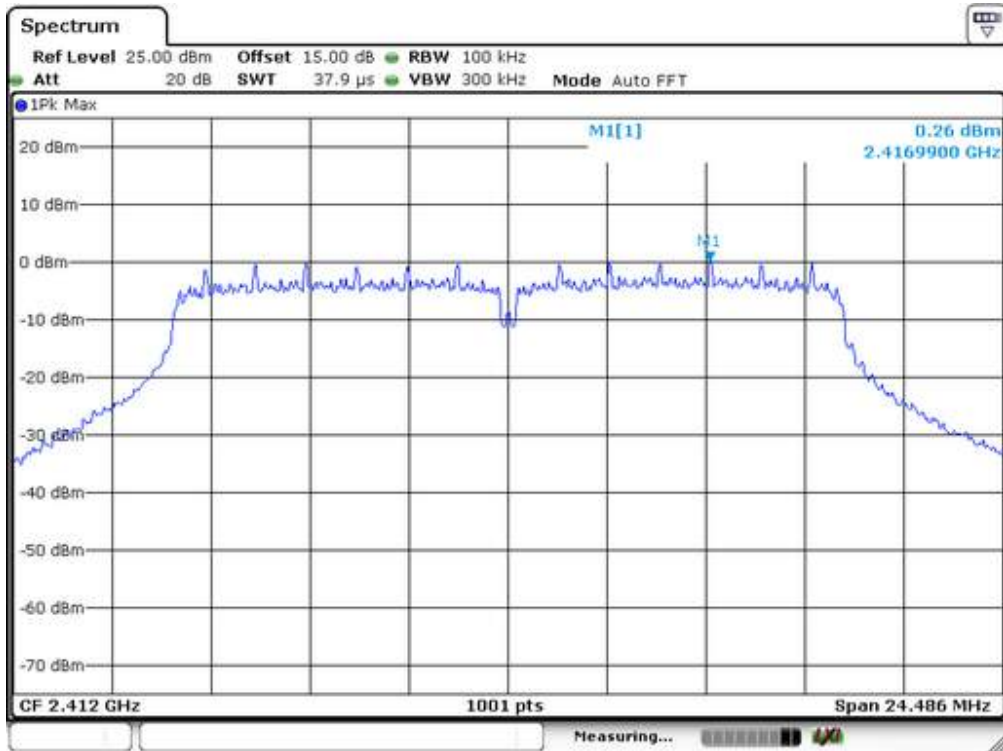

Lowest Channel

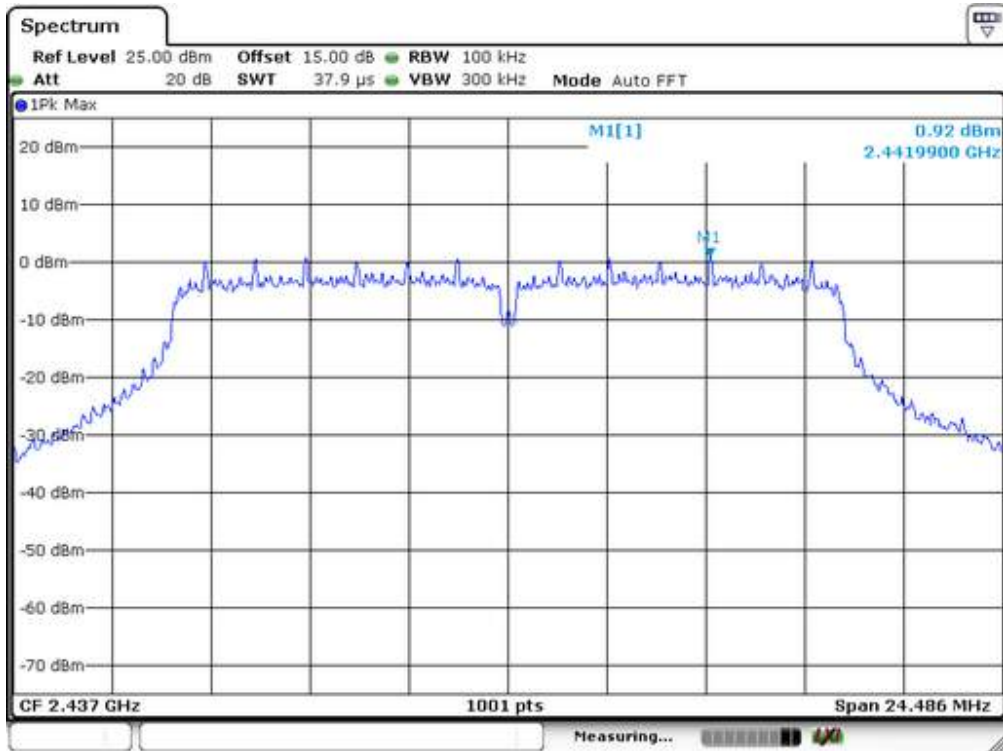

Middle Channel

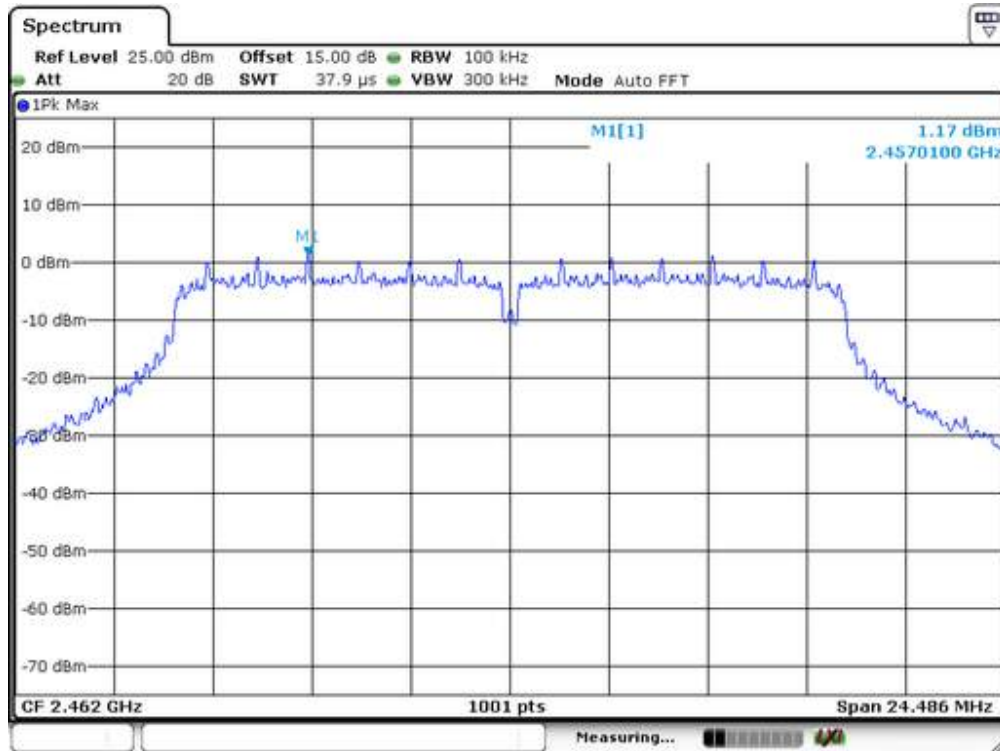

Highest Channel

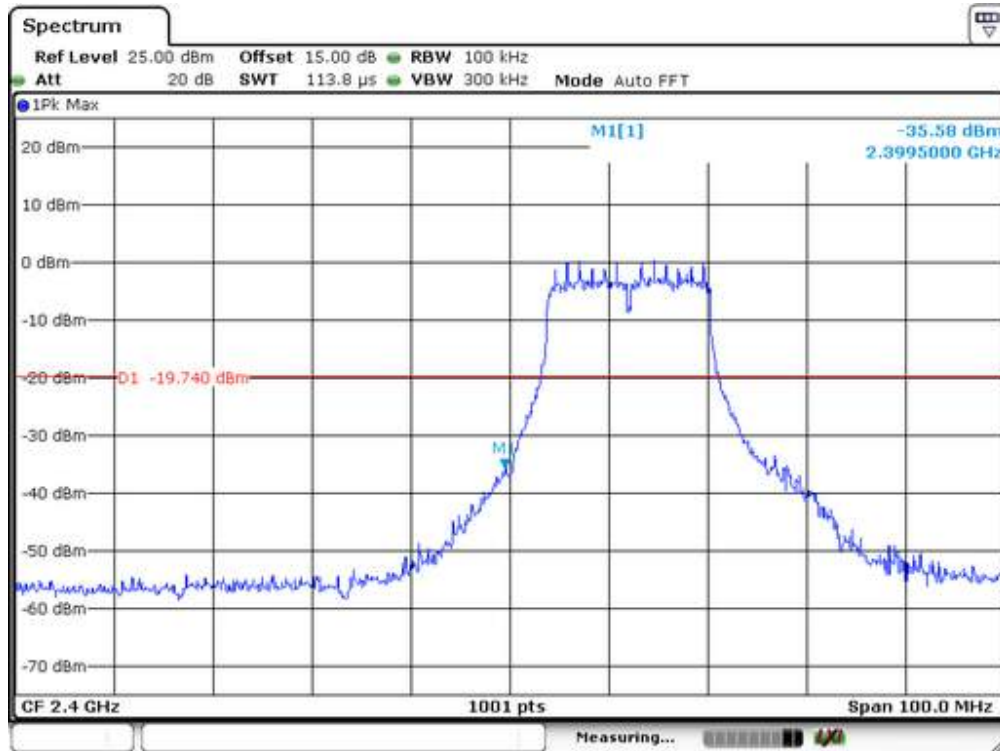

Lowest Channel

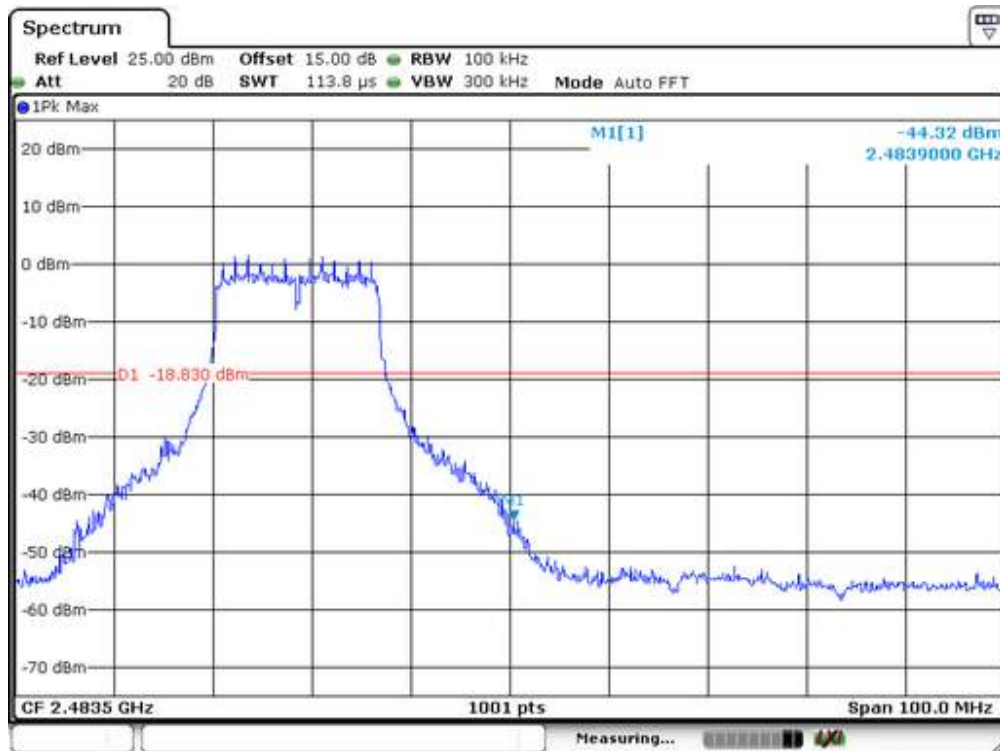

Highest Channel

Test Mode: IEEE 802.11g SISO Ant2

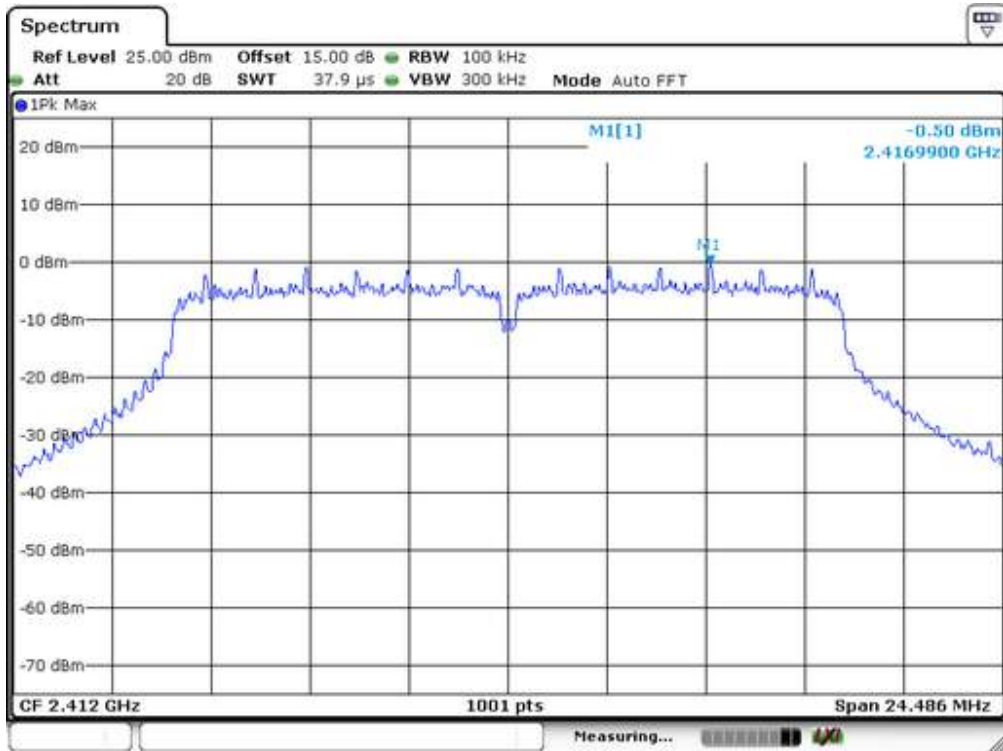

Lowest Channel

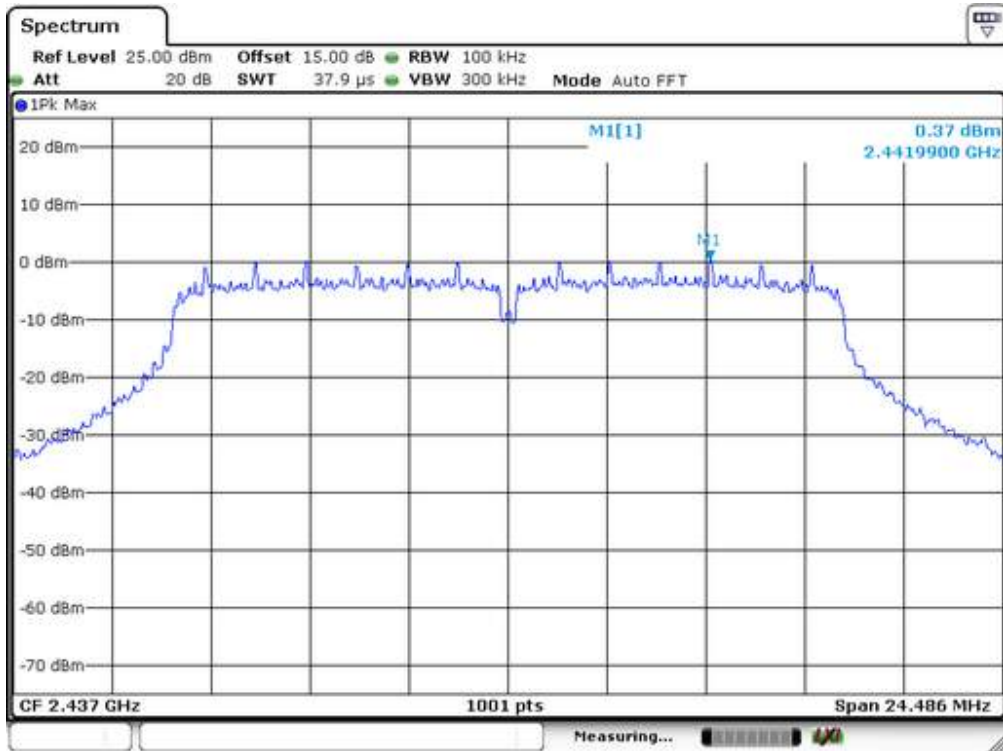

Middle Channel

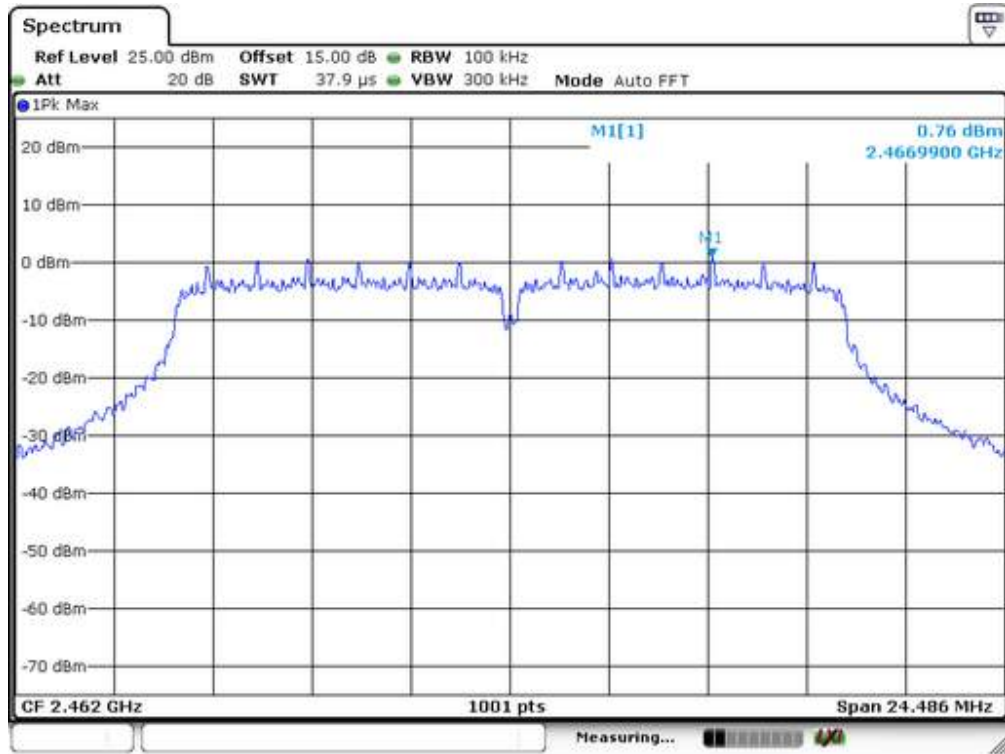

Highest Channel



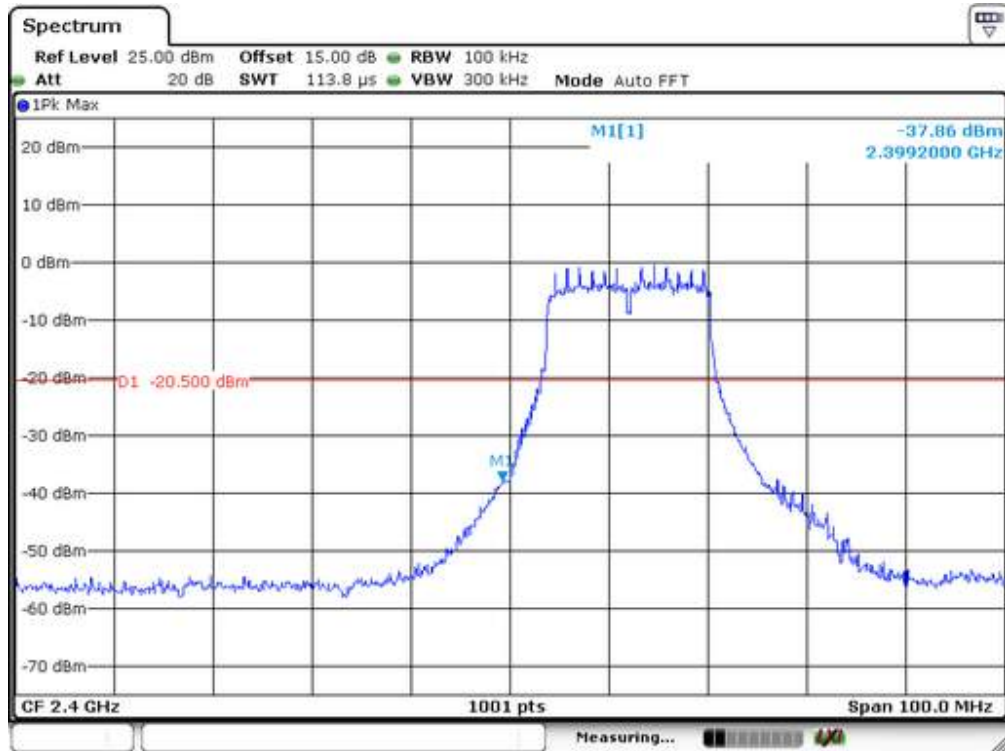

Lowest Channel

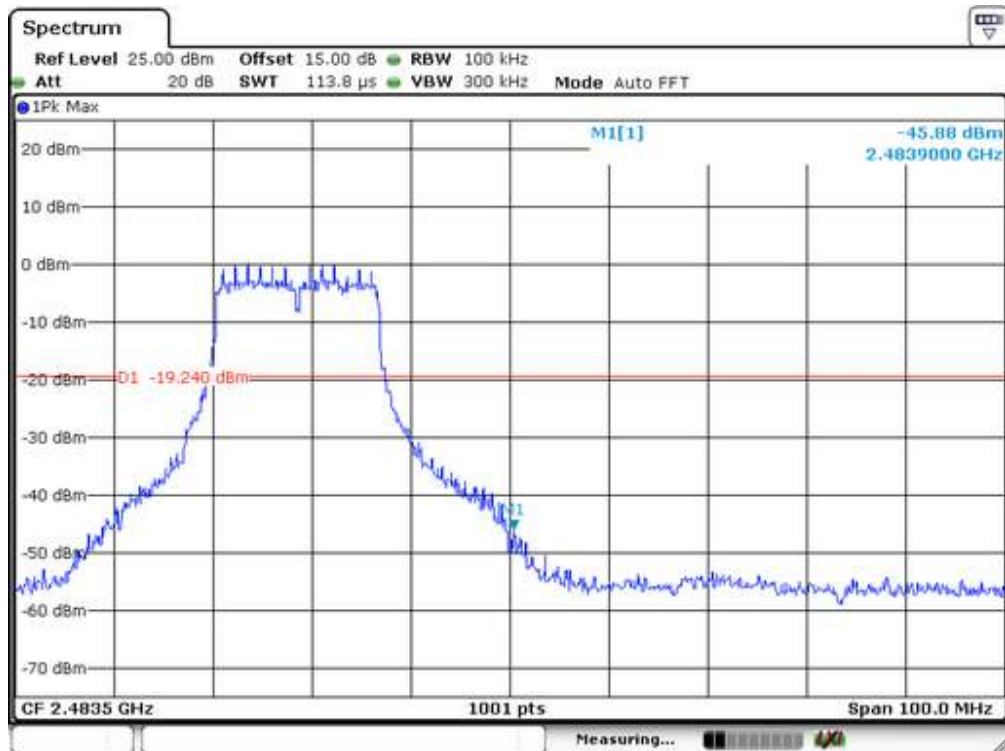

Highest Channel

Test Mode: IEEE 802.11n(H20) MIMO

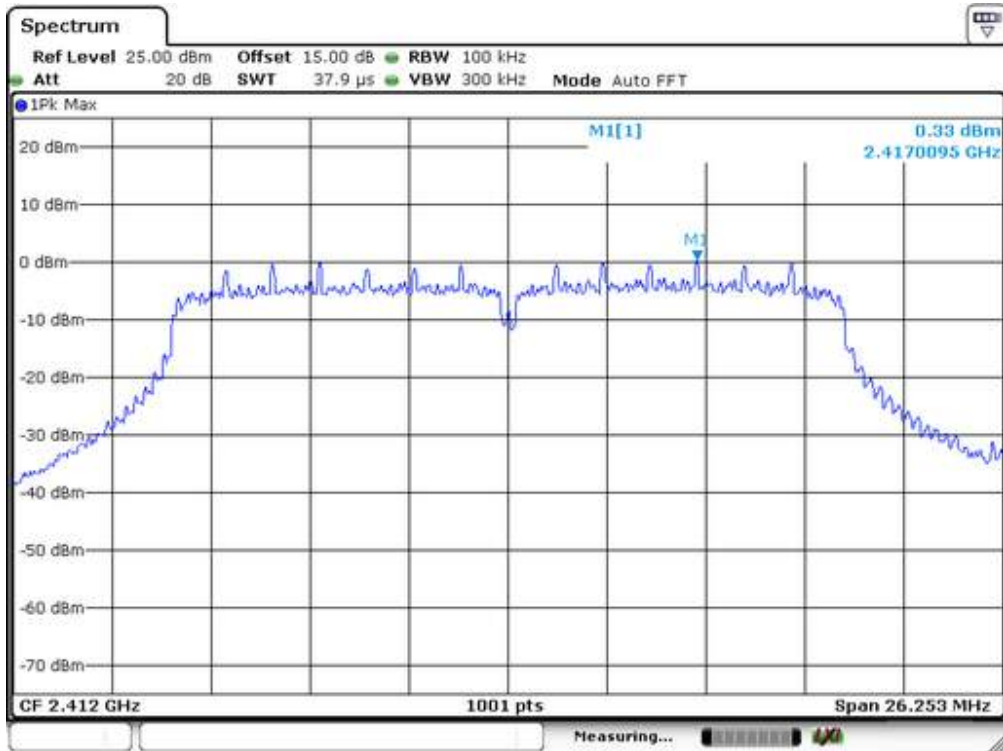

Lowest Channel

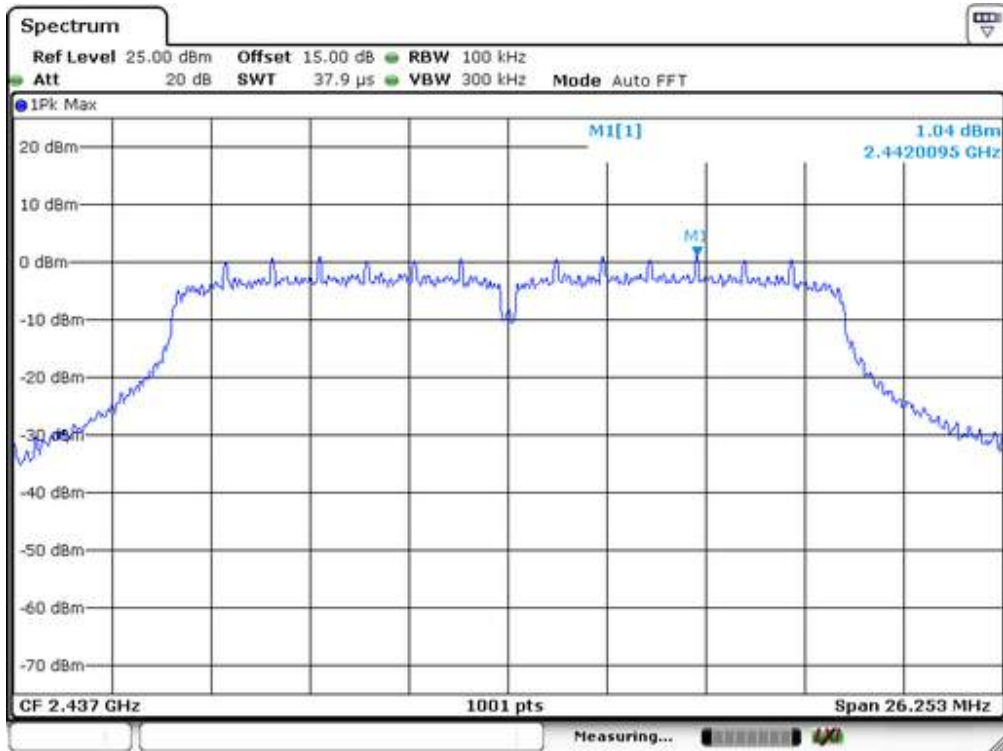

Middle Channel

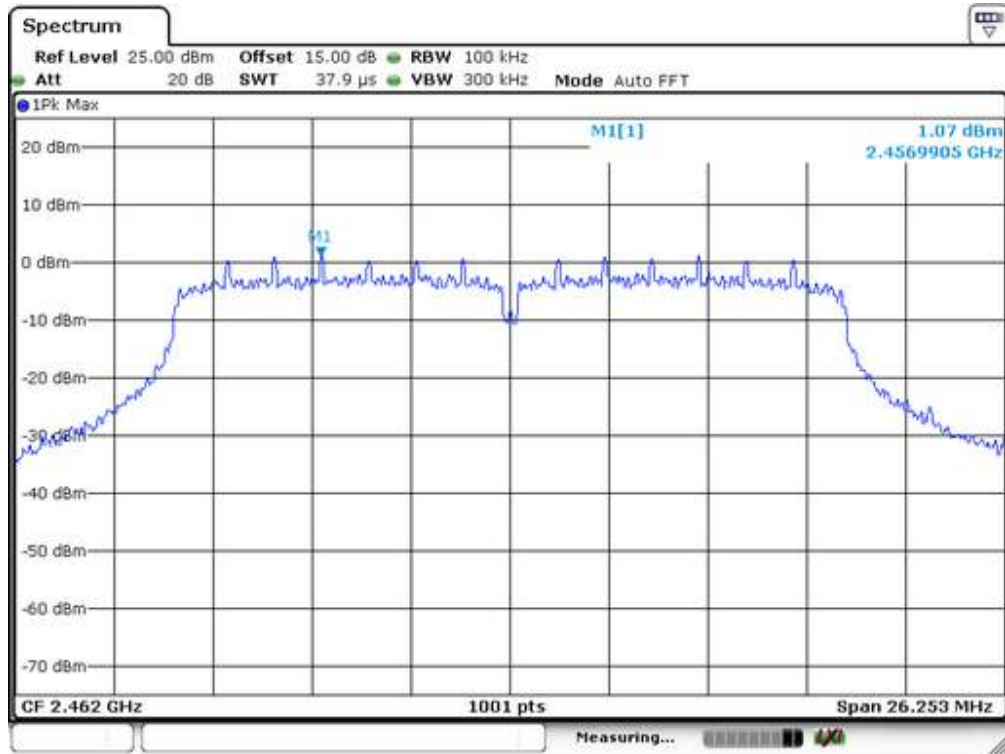

Highest Channel

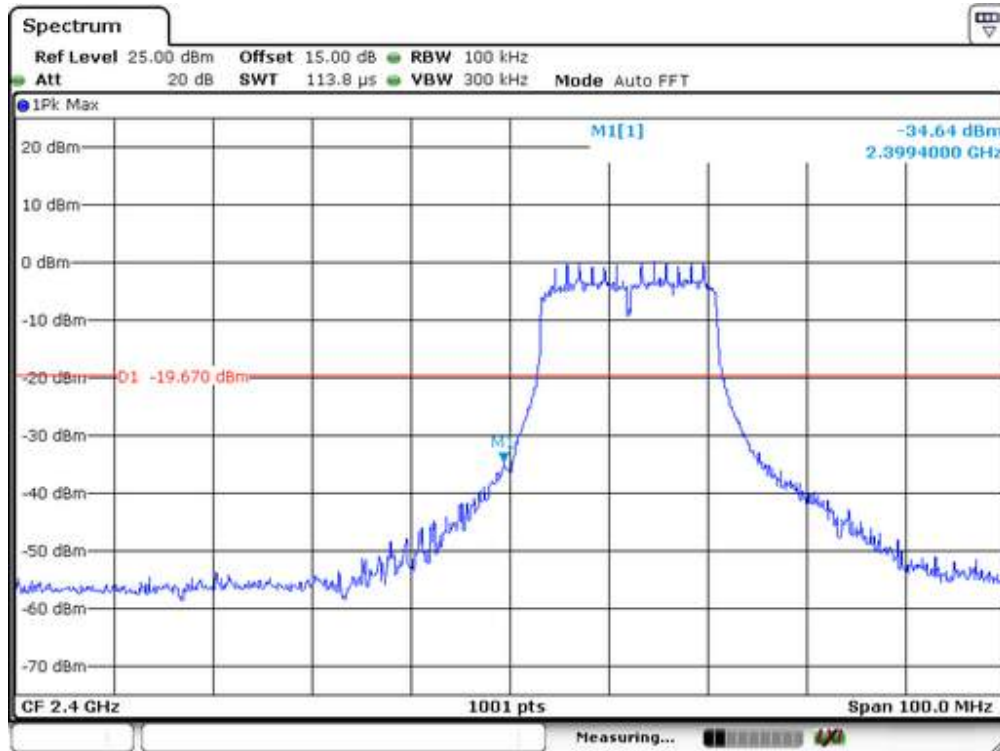

Lowest Channel

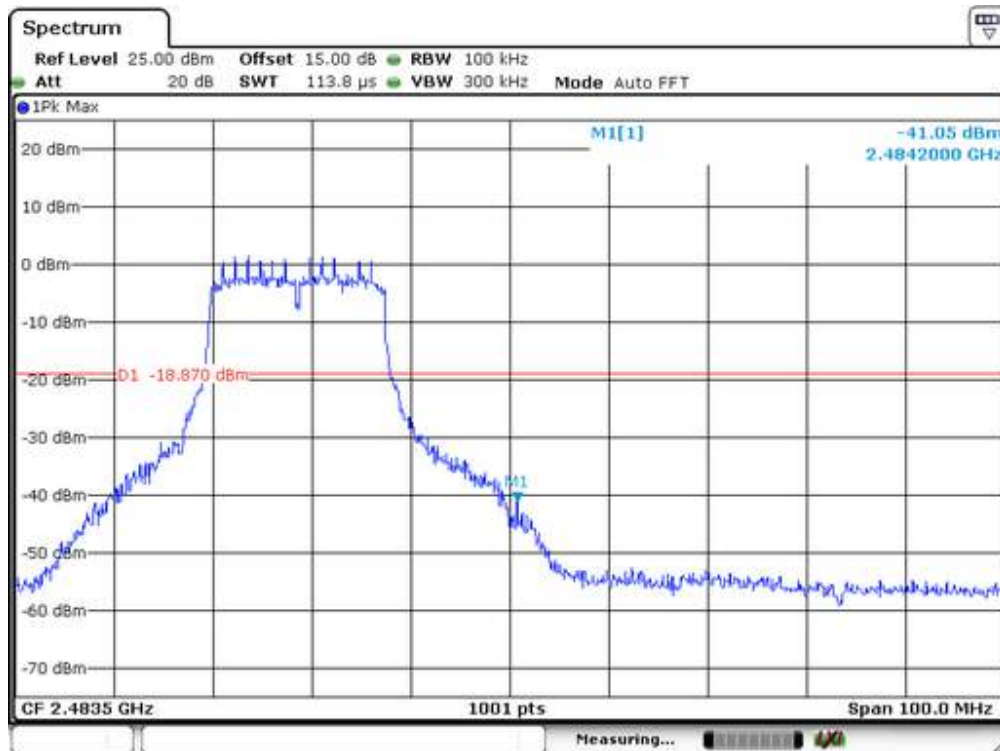

Highest Channel

Test Mode: IEEE 802.11n(H40) MIMO

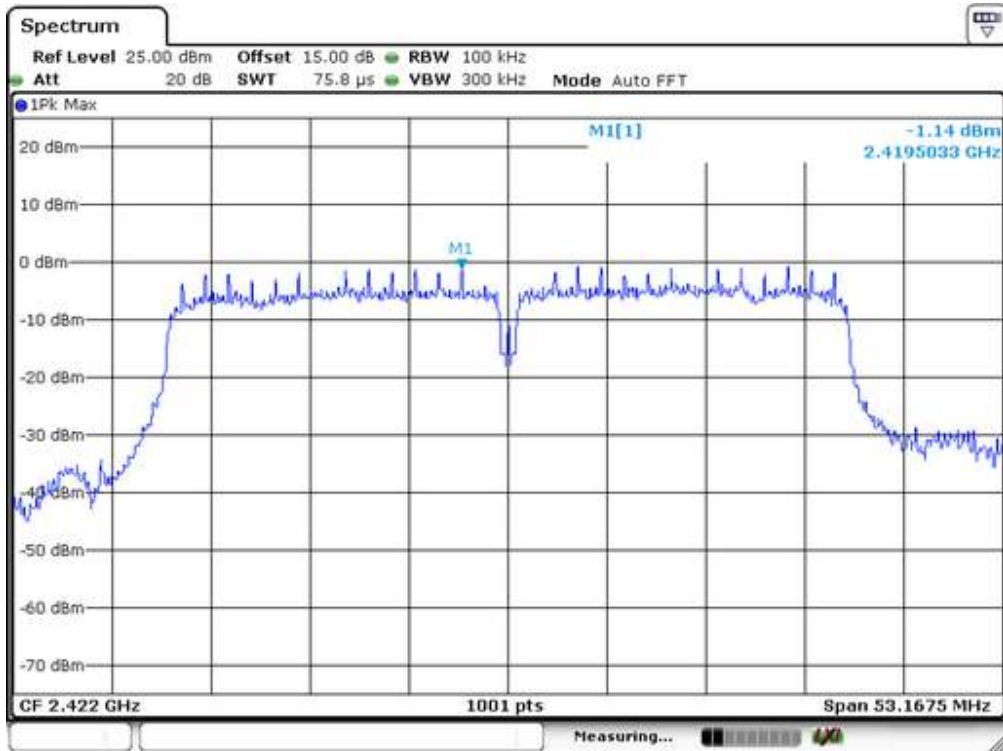

Lowest Channel

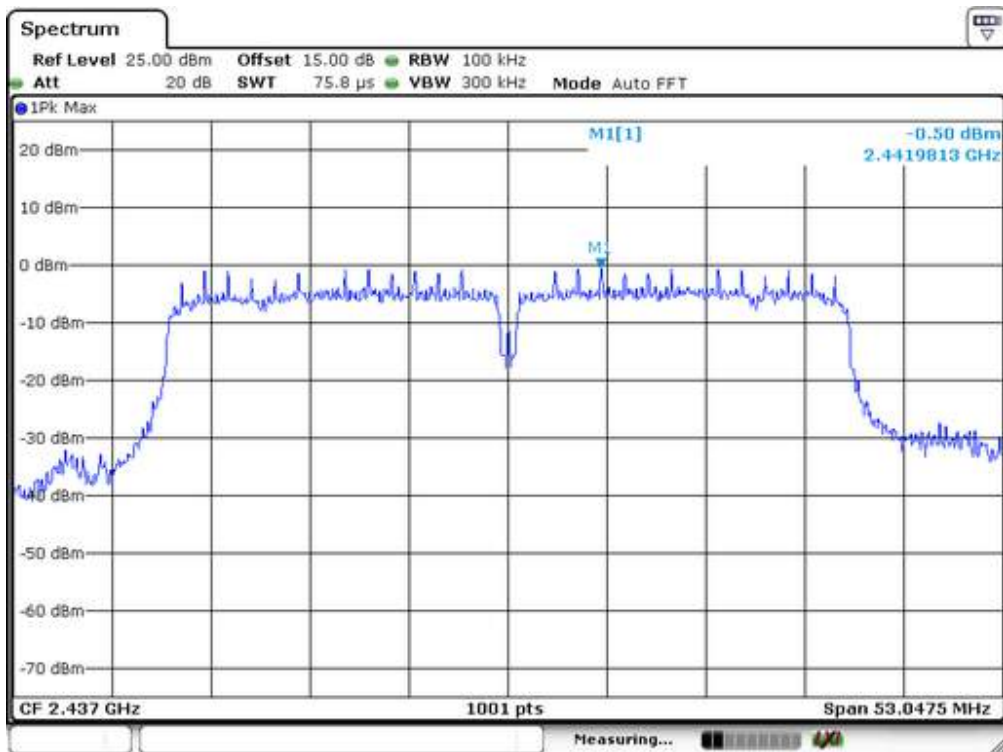

Middle Channel

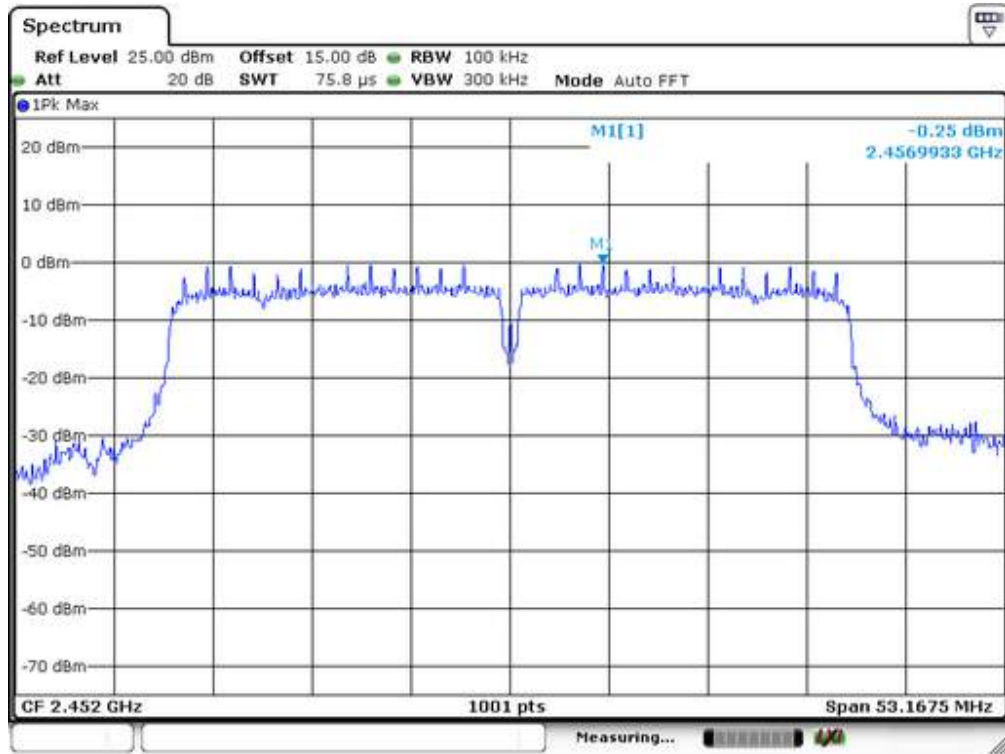

Highest Channel

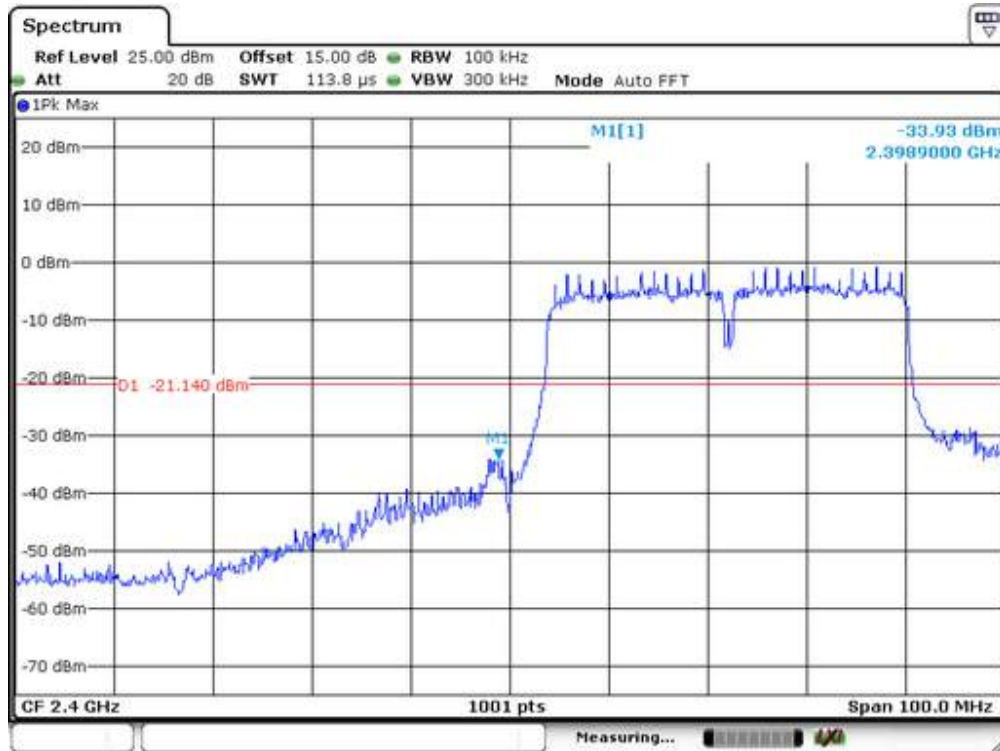

Lowest Channel

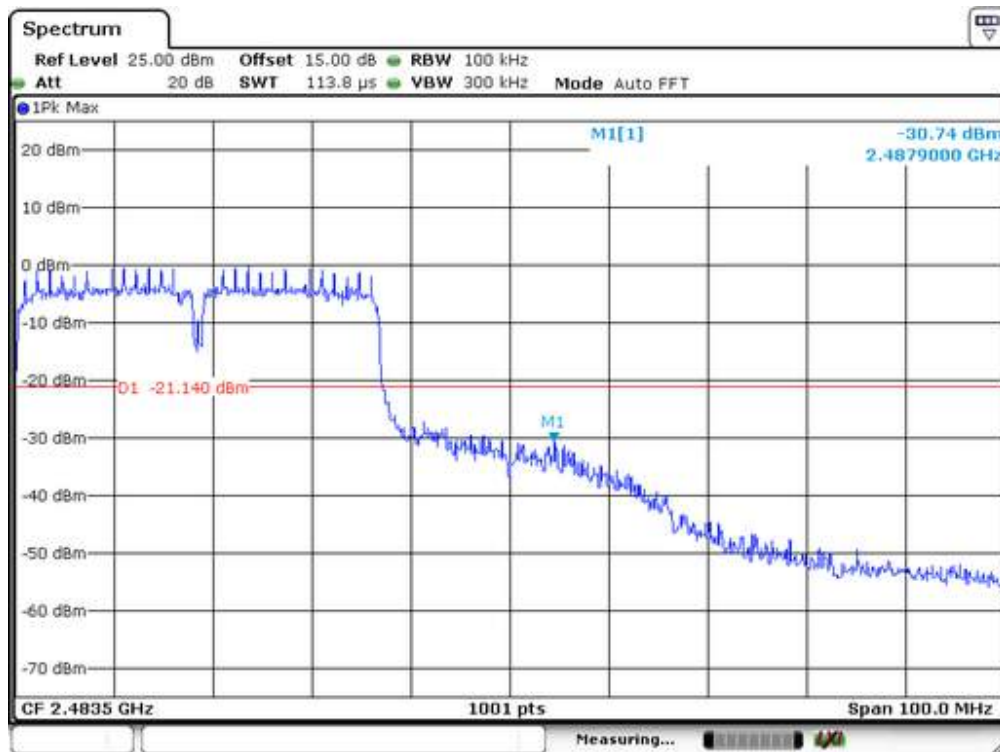

Highest Channel

## 2. Radiated emission Test

Spectrum Detector: PK/AV      Test Date : December 26, 2014  
 Test By: Andy      Temperature : 28 °C  
 Humidity : 65 %

IEEE 802.11b SISO Ant1							
Frequency (MHz)	Antenna polarization (H/V)	Emission (dBuV/m)		Band edge Limit (dBuV/m)		Margin (dB)	
		PK	AV	PK	AV	PK	AV
<2400	H	65.35	45.13	74	54	-8.65	-8.87
<2400	V	60.71	40.38	74	54	-13.29	-13.62
>2483.5	H	66.35	44.85	74	54	-7.65	-9.15
>2483.5	V	61.07	39.27	74	54	-12.93	-14.73

IEEE 802.11b SISO Ant2							
Frequency (MHz)	Antenna polarization (H/V)	Emission (dBuV/m)		Band edge Limit (dBuV/m)		Margin (dB)	
		PK	AV	PK	AV	PK	AV
<2400	H	63.59	45.18	74	54	-10.41	-8.82
<2400	V	57.04	40.32	74	54	-16.96	-13.68
>2483.5	H	64.82	46.38	74	54	-9.18	-7.62
>2483.5	V	59.38	39.04	74	54	-14.62	-14.96

IEEE 802.11g SISO Ant1							
Frequency (MHz)	Antenna polarization (H/V)	Emission (dBuV/m)		Band edge Limit (dBuV/m)		Margin (dB)	
		PK	AV	PK	AV	PK	AV
<2400	H	64.03	44.25	74	54	-9.97	-9.75
<2400	V	60.18	39.01	74	54	-13.82	-14.99
>2483.5	H	65.37	43.85	74	54	-8.63	-10.15
>2483.5	V	59.25	37.45	74	54	-14.75	-16.55



IEEE 802.11g SISO Ant2							
Frequency (MHz)	Antenna polarization (H/V)	Emission (dBuV/m)		Band edge Limit (dBuV/m)		Margin (dB)	
		PK	AV	PK	AV	PK	AV
<2400	H	65.38	45.03	74	54	-8.62	-8.97
<2400	V	60.82	39.72	74	54	-13.18	-14.28
>2483.5	H	64.19	44.03	74	54	-9.81	-9.97
>2483.5	V	58.72	37.49	74	54	-15.28	-16.51

IEEE 802.11n(H20) MIMO							
Frequency (MHz)	Antenna polarization (H/V)	Emission (dBuV/m)		Band edge Limit (dBuV/m)		Margin (dB)	
		PK	AV	PK	AV	PK	AV
<2400	H	64.13	44.18	74	54	-9.87	-9.82
<2400	V	58.05	40.38	74	54	-15.95	-13.62
>2483.5	H	63.18	43.53	74	54	-10.82	-10.47
>2483.5	V	57.43	38.72	74	54	-16.57	-15.28

IEEE 802.11n(H40) MIMO							
Frequency (MHz)	Antenna polarization (H/V)	Emission (dBuV/m)		Band edge Limit (dBuV/m)		Margin (dB)	
		PK	AV	PK	AV	PK	AV
<2400	H	63.02	44.72	74	54	-10.98	-9.28
<2400	V	57.12	40.35	74	54	-16.88	-13.65
>2483.5	H	64.35	43.01	74	54	-9.65	-10.99
>2483.5	V	60.95	37.56	74	54	-13.05	-16.44

## 13. Maximum Power Spectral Density

### 13.1 Test Equipment

EQUIPMENT TYPE	MFR	MODEL NUMBER	SERIAL NUMBER	LAST CAL.	CAL DUE.
Spectrum Analyzer	Agilent	FSV30	1321.3008K	05/16/2014	05/15/2015

### 13.2 Measuring Instruments and Setting

The following table is the setting of spectrum analyzer.

Spectrum analyzer	Setting
Attenuation	Auto
Span Frequency	Set the span to 1.5 times the DTS bandwidth.
RB	3KHz
VB	10KHz
Detector	Peak
Trace	Max hold
Sweep Time	Automatic

### 13.3 Test Procedures

- The transmitter output (antenna port) was connected to the spectrum analyzer.
- Set analyzer center frequency to DTS channel center frequency.
- Set the analyzer span to a minimum of 1.5 times the DTS bandwidth.
- Set the RBW=3KHz. Set the VBW=10KHz
- Detector = peak.
- Sweep time = auto couple.
- Trace mode = max hold.
- Allow trace to fully stabilize.
- Use the peak marker function to determine the maximum amplitude level.

### 13.4 Block Diagram of Test Setup

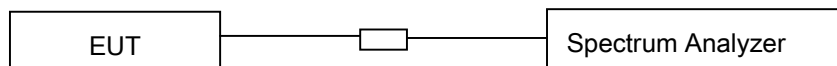

### 13.5 Limit

The transmitted power density averaged over any 1 second interval shall not be greater +8dBm in any 3 kHz bandwidth.

### 13.6 Test Result

Spectrum Detector: PK                      Test Date : December 26, 2014  
 Test By: Andy                              Temperature : 28°C  
 Humidity : 60%

IEEE 802.11b SISO Ant1			
Channel frequency (MHz)	Power Density (dBm/3kHz)	Power Density Limit (dBm/3kHz)	Result
2412	-10.10	8	Pass
2437	-8.78		
2462	-8.40		

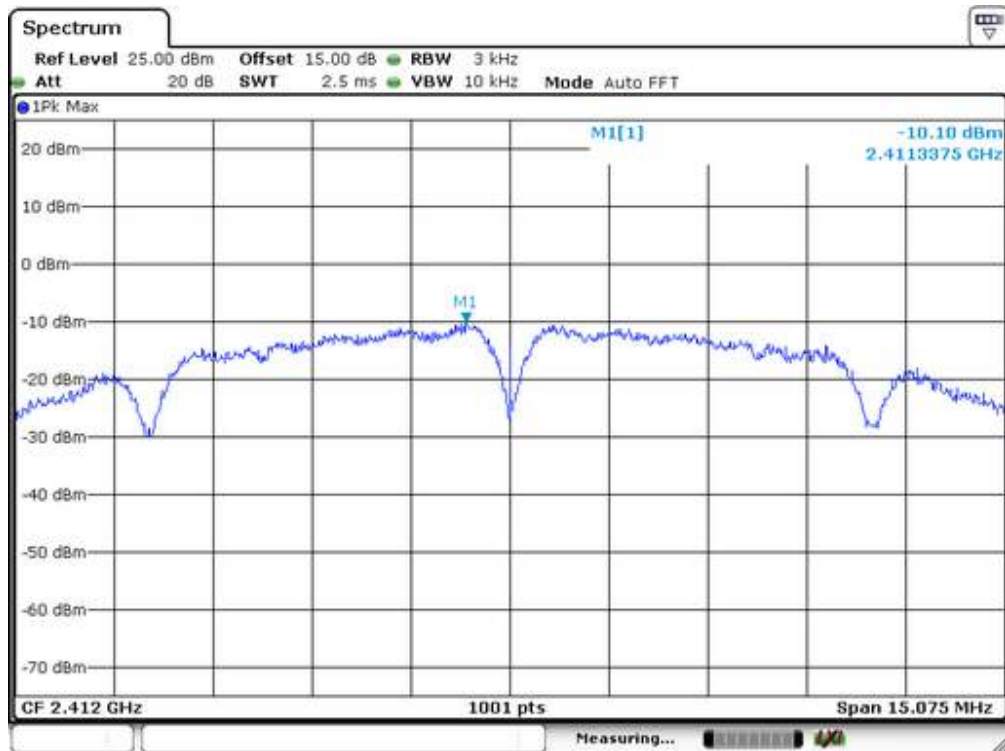

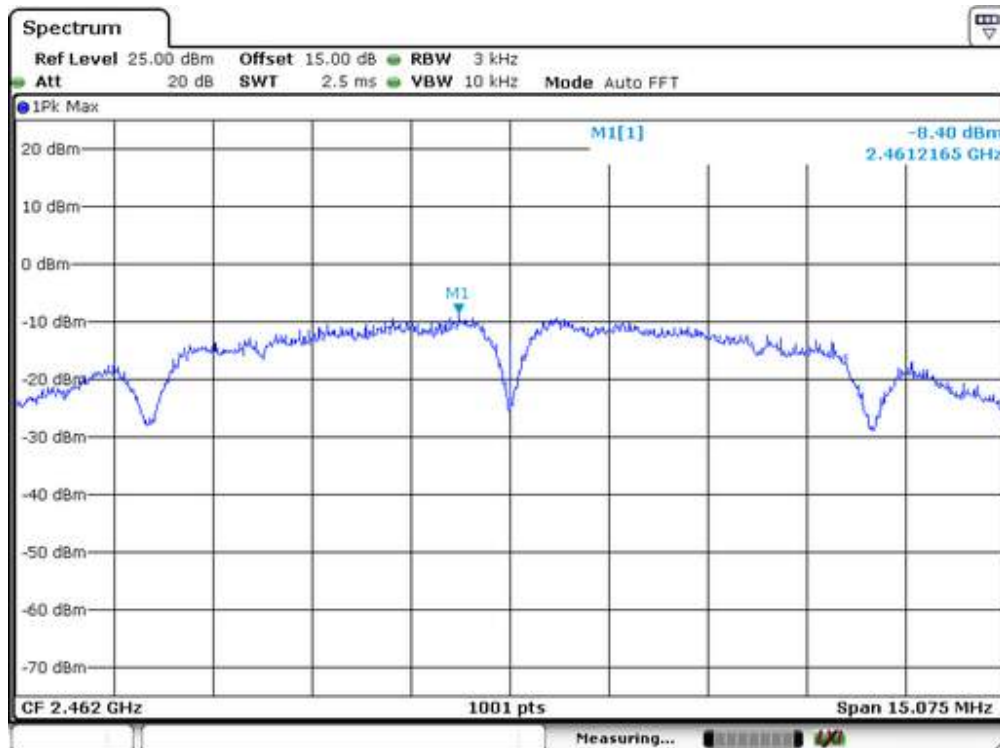
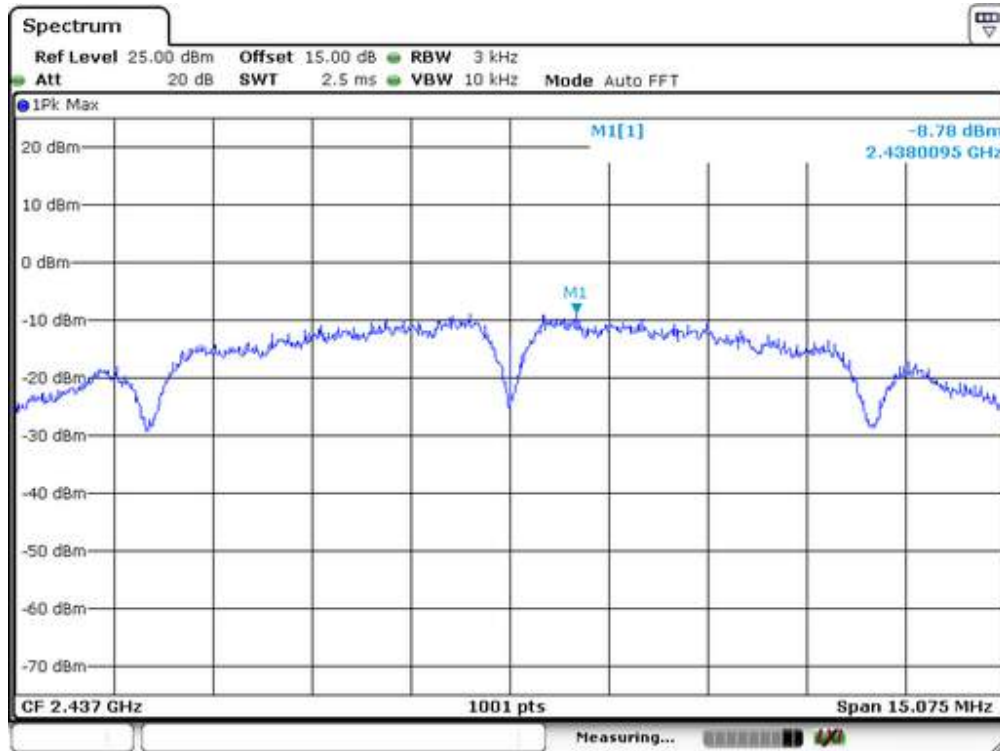

IEEE 802.11b SISO Ant2			
Channel frequency (MHz)	Power Density (dBm/3kHz)	Power Density Limit (dBm/3kHz)	Result
2412	-9.36	8	Pass
2437	-10.15		
2462	-8.98		

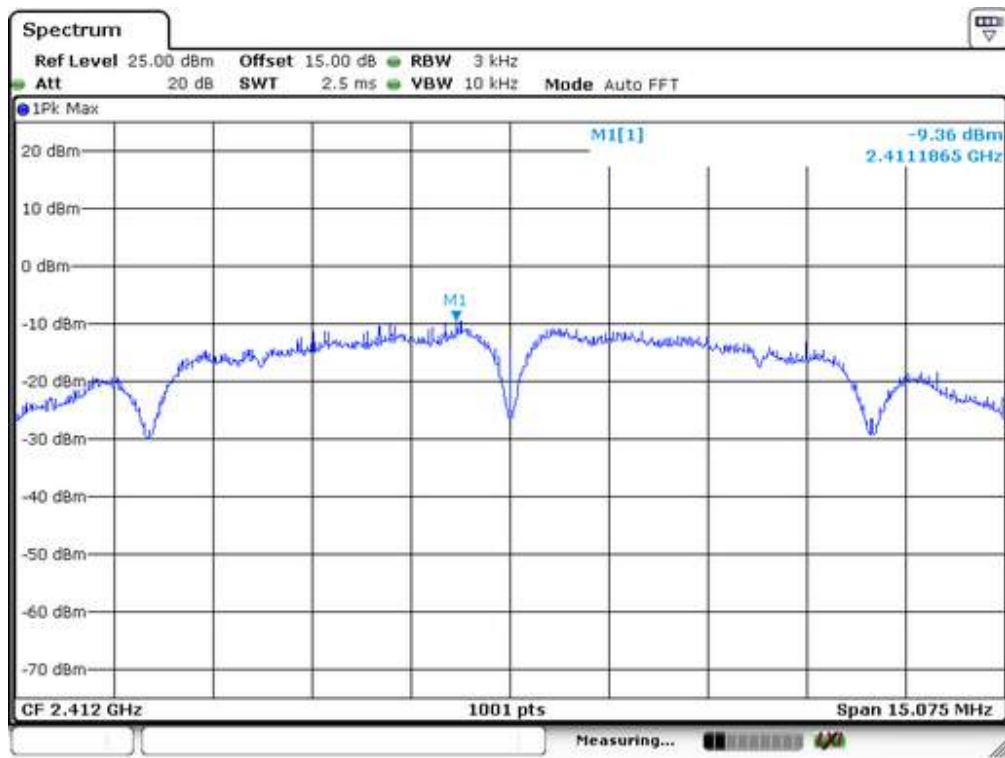

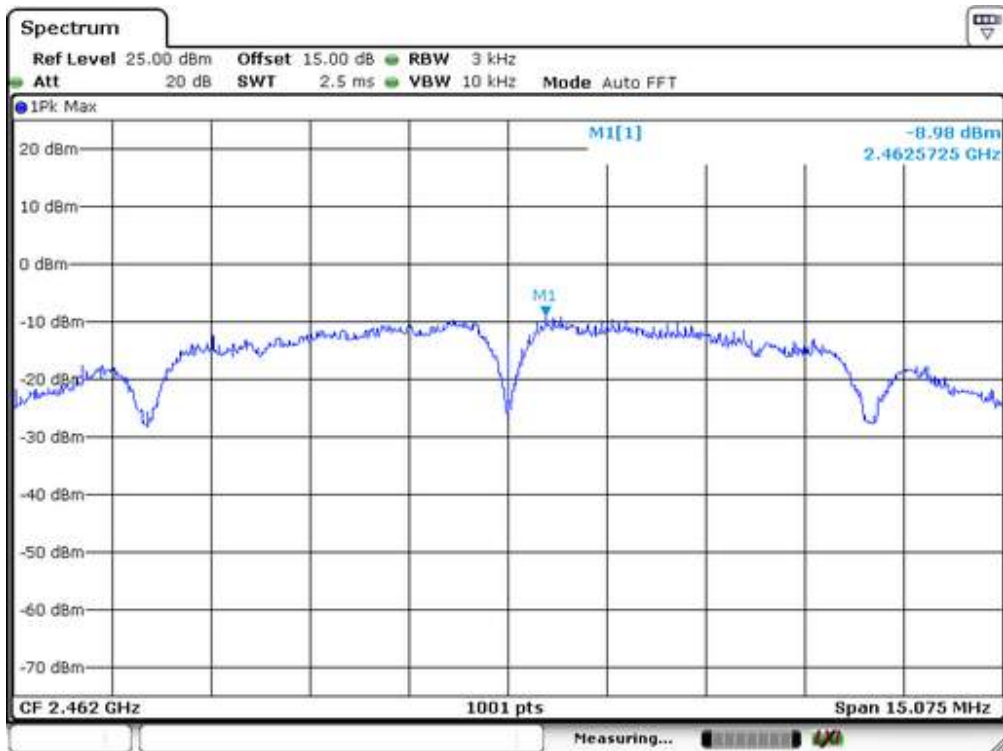
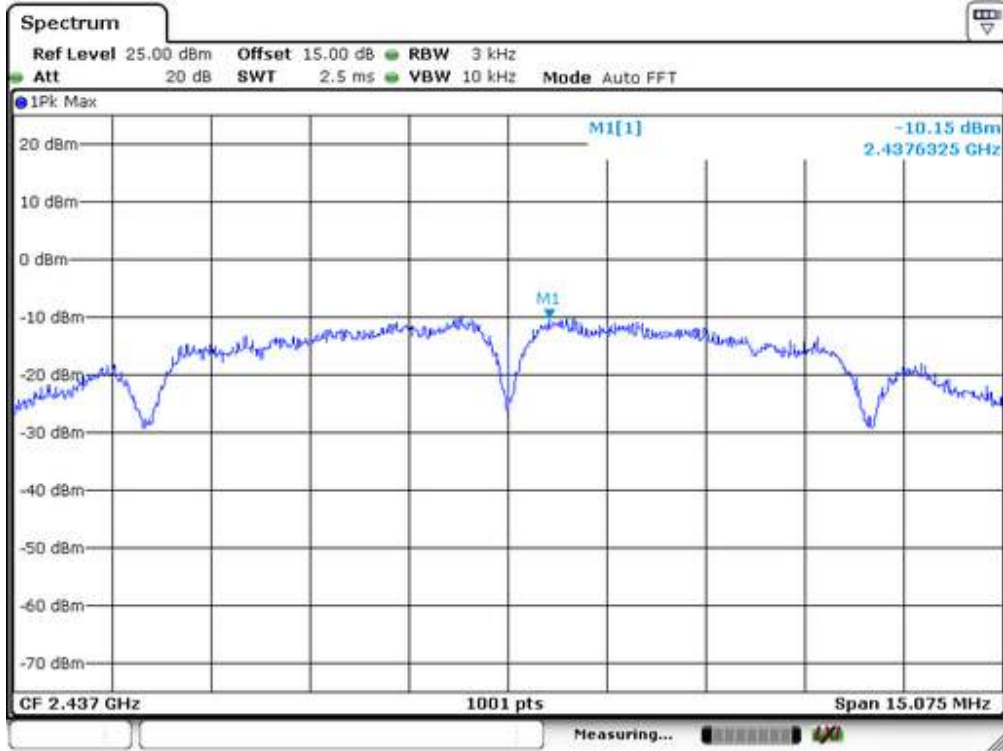

IEEE 802.11g(SISO) Ant 1			
Channel frequency (MHz)	Power Density (dBm/3kHz)	Power Density Limit (dBm/3kHz)	Result
2412	-13.33	8	Pass
2437	-10.89		
2462	-11.02		

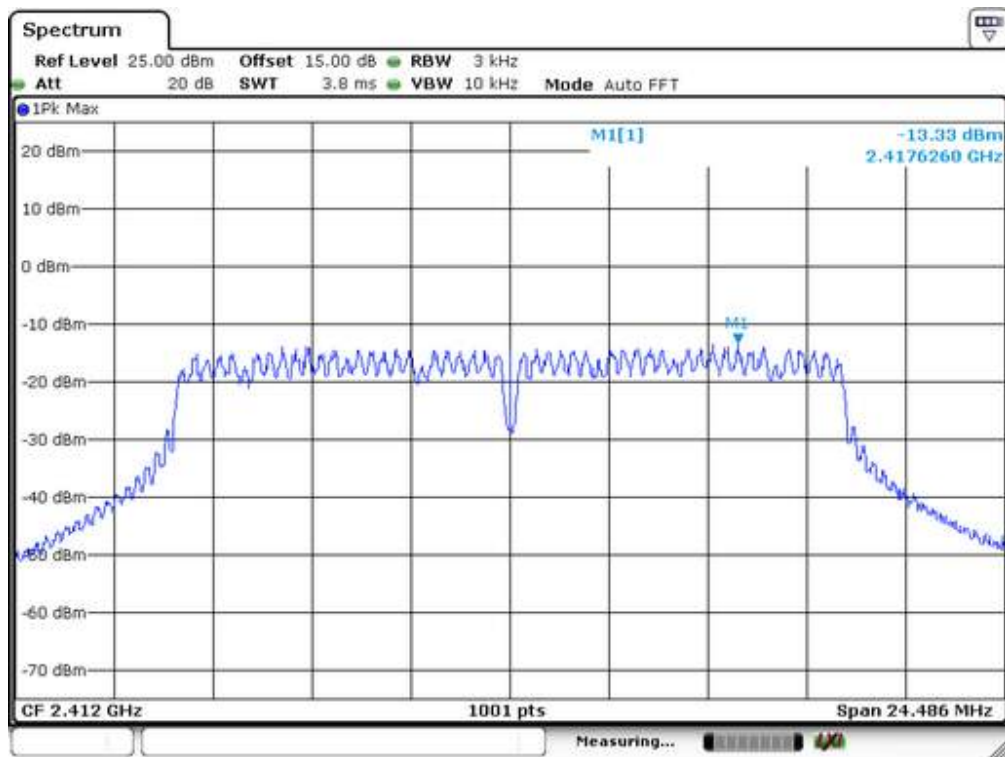

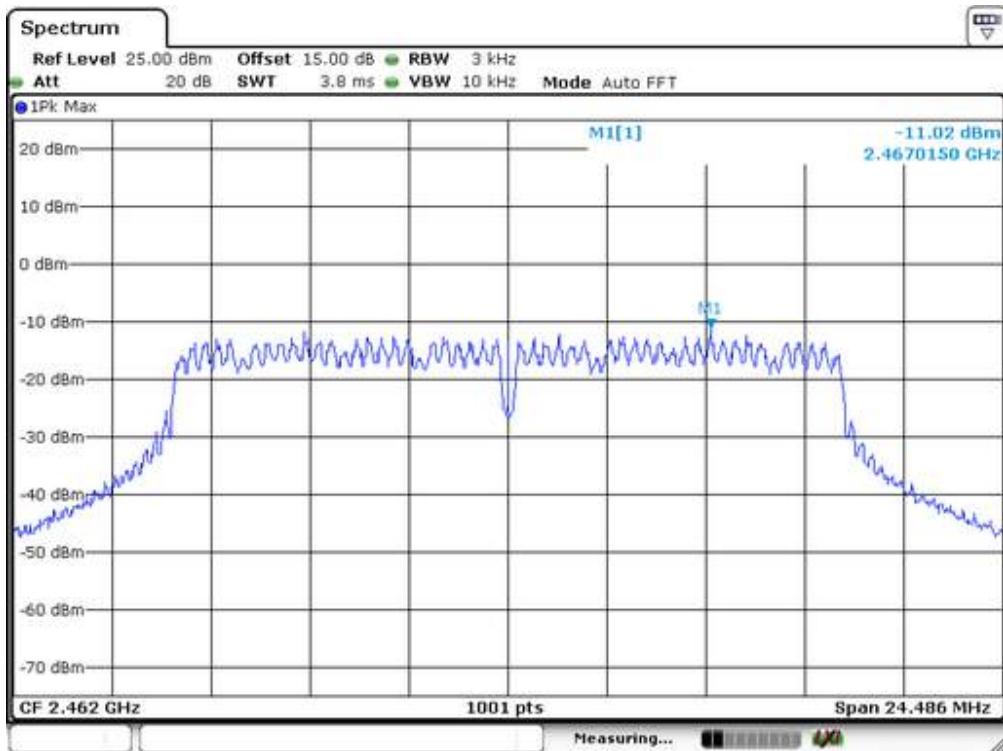
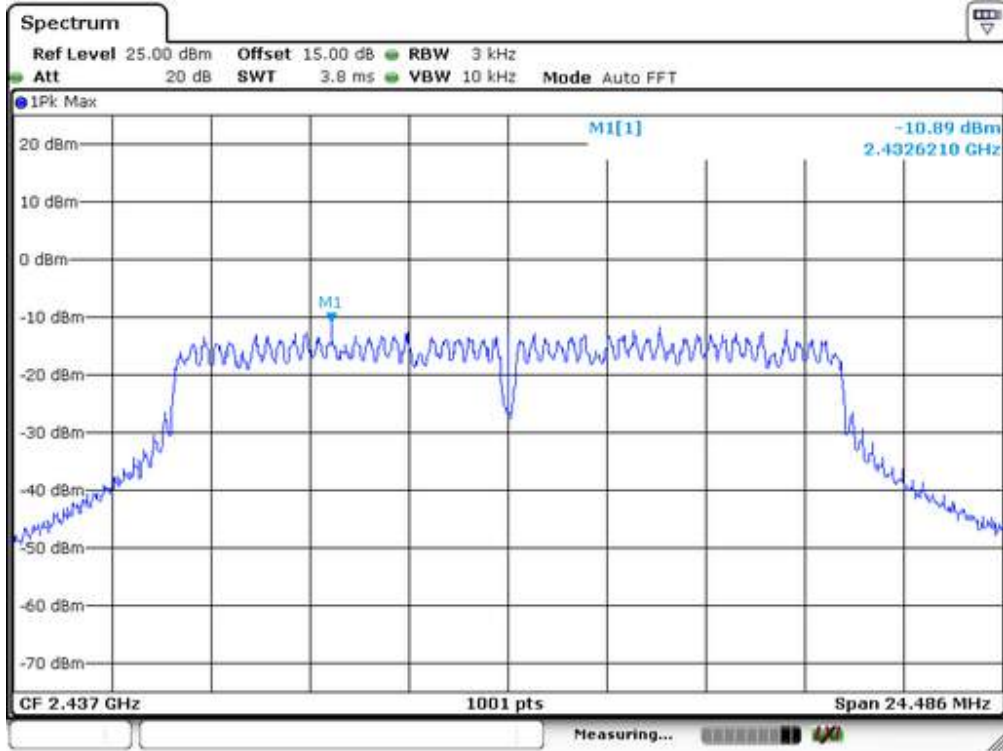



IEEE 802.11g(SISO) Ant2			
Channel frequency (MHz)	Power Density (dBm/3kHz)	Power Density Limit (dBm/3kHz)	Result
2412	-13.13	8	Pass
2437	-12.41		
2462	-12.47		

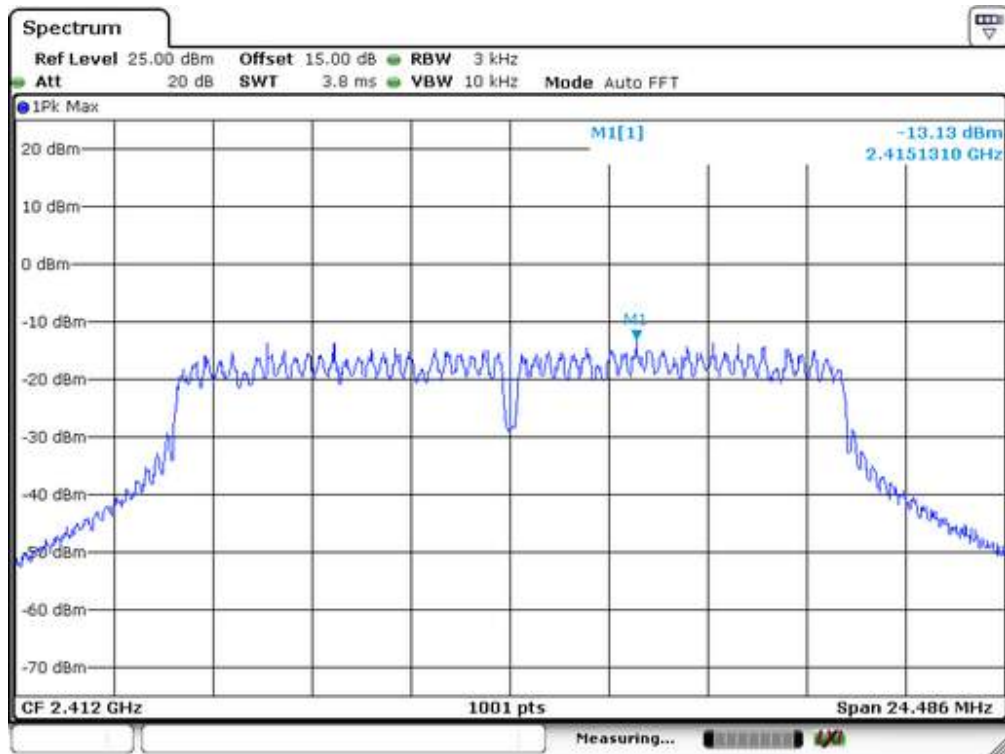

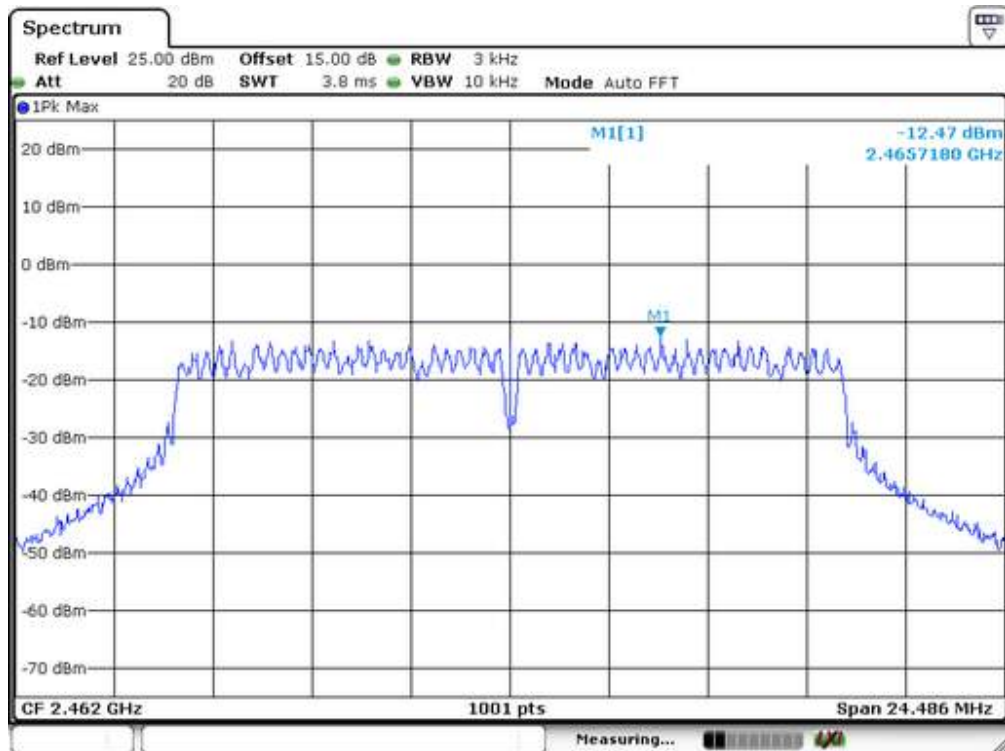
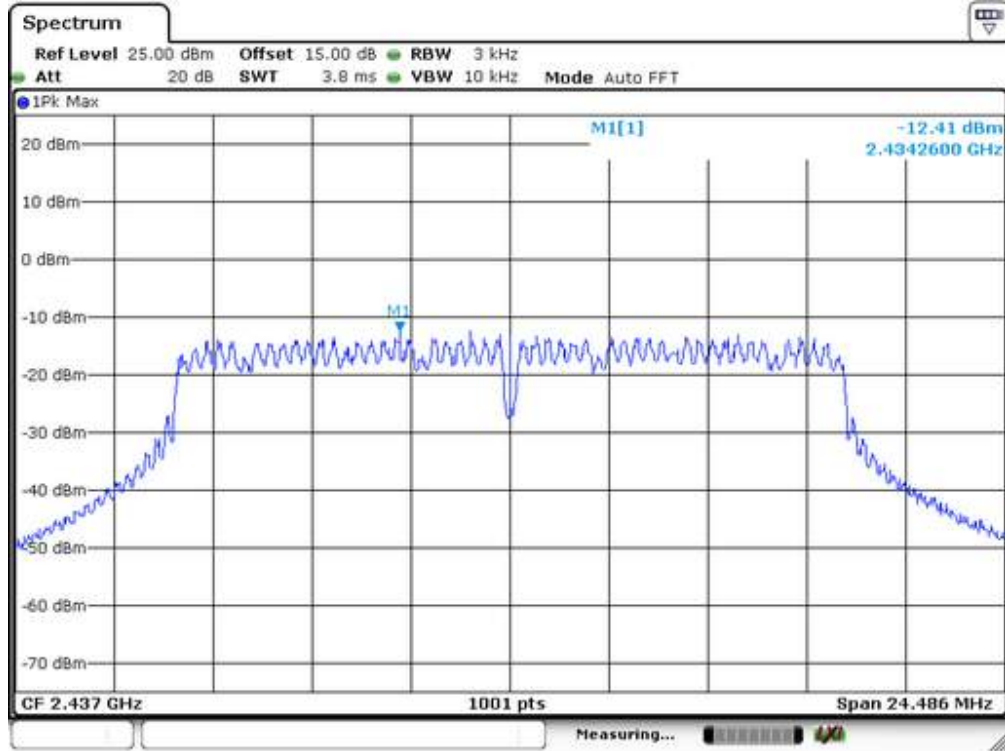

IEEE 802.11n(H20) MIMO(Antenna Gain=4.8dBi)					
Channel frequency (MHz)	Power Density (dBm/3kHz)			Power Density Limit (dBm/3kHz)	Result
	Ant1	Ant2	Total		
2412	-13.37	-13.09	-10.22	8	Pass
2437	-11.71	-13.38	-9.45		
2462	-12.75	-12.34	-9.53		
Remark: In MIMO, Ant1+Ant2 Directional Gain= $G_{ant}+10\log(N)$ dBi= $1.8+10\log(2)$ =4.8dBi. Directional Gain was according to KDB662911.					

Ant1

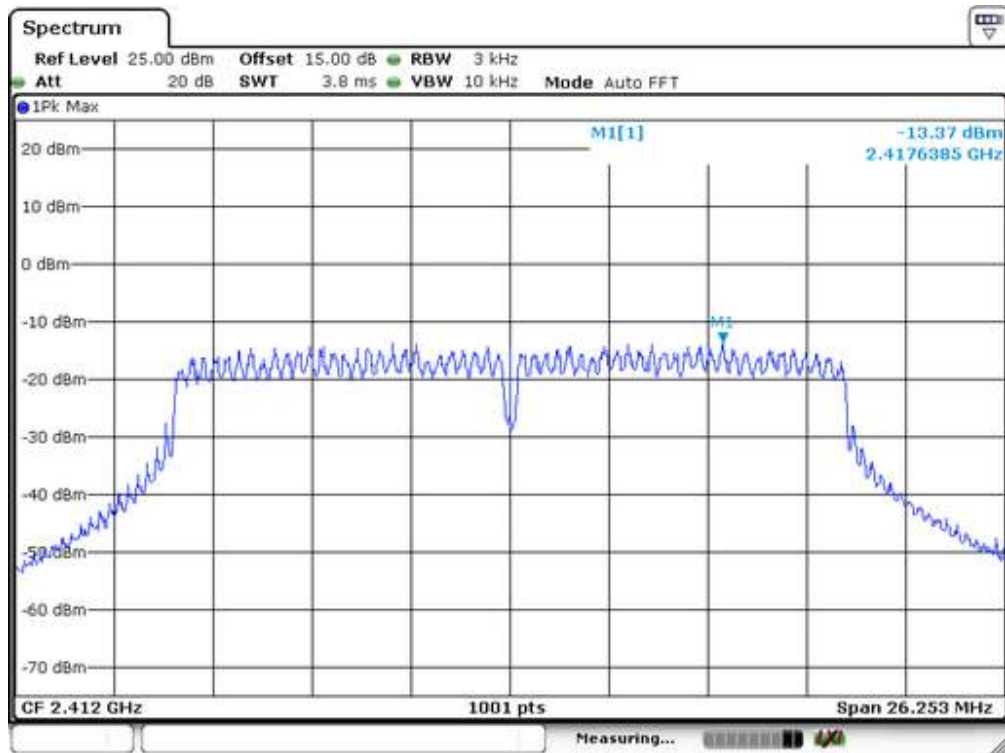

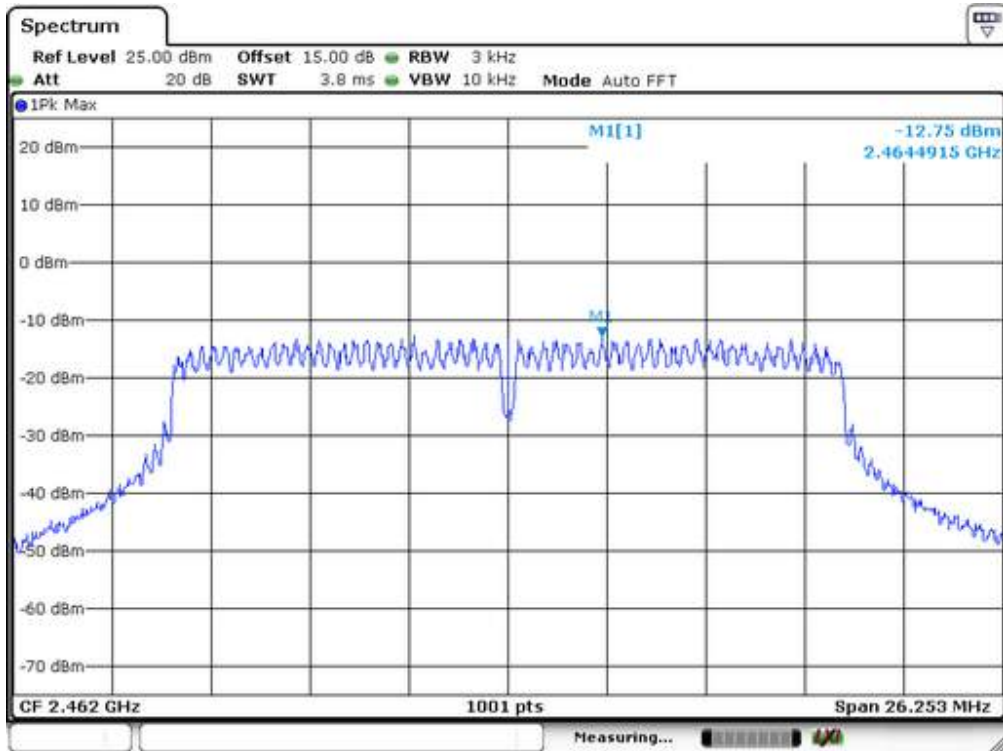
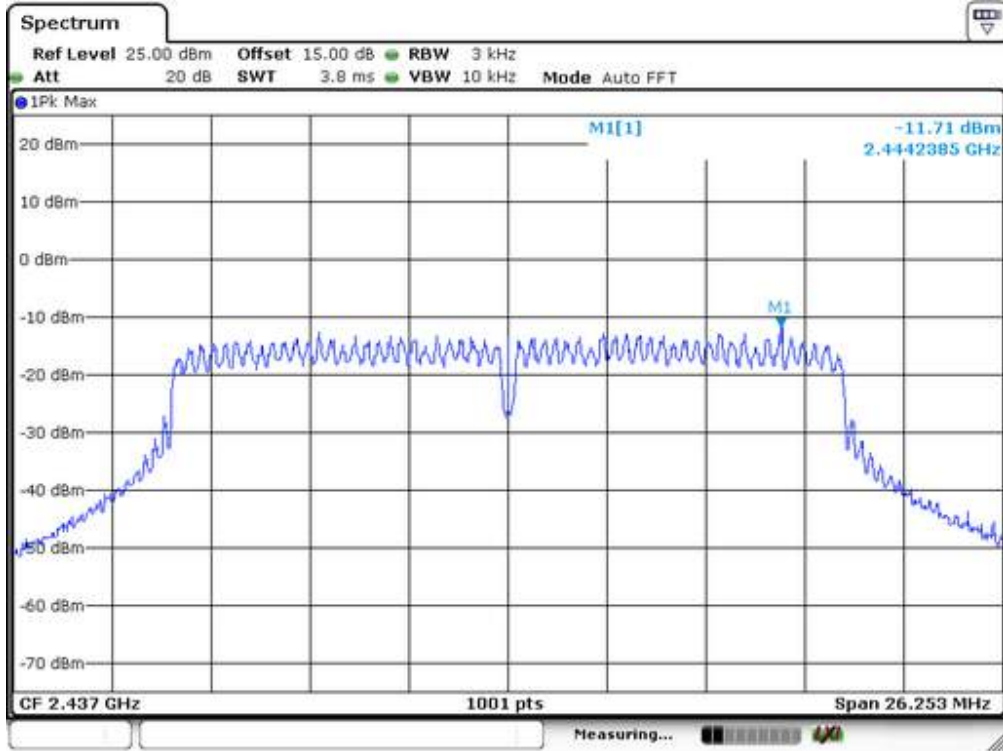

Ant2

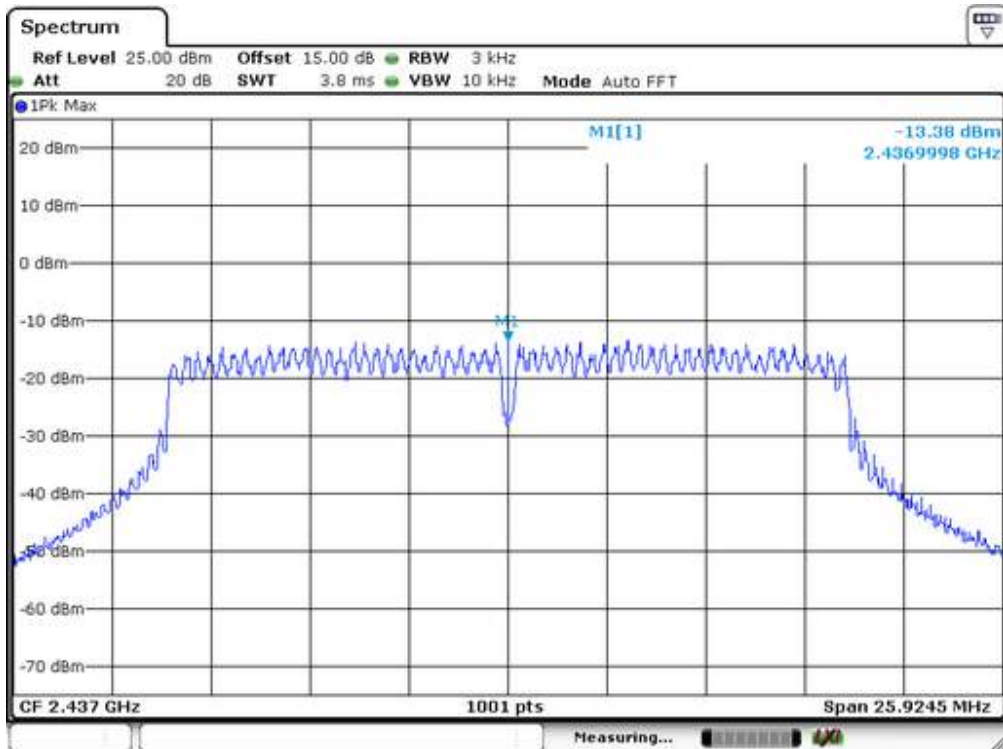
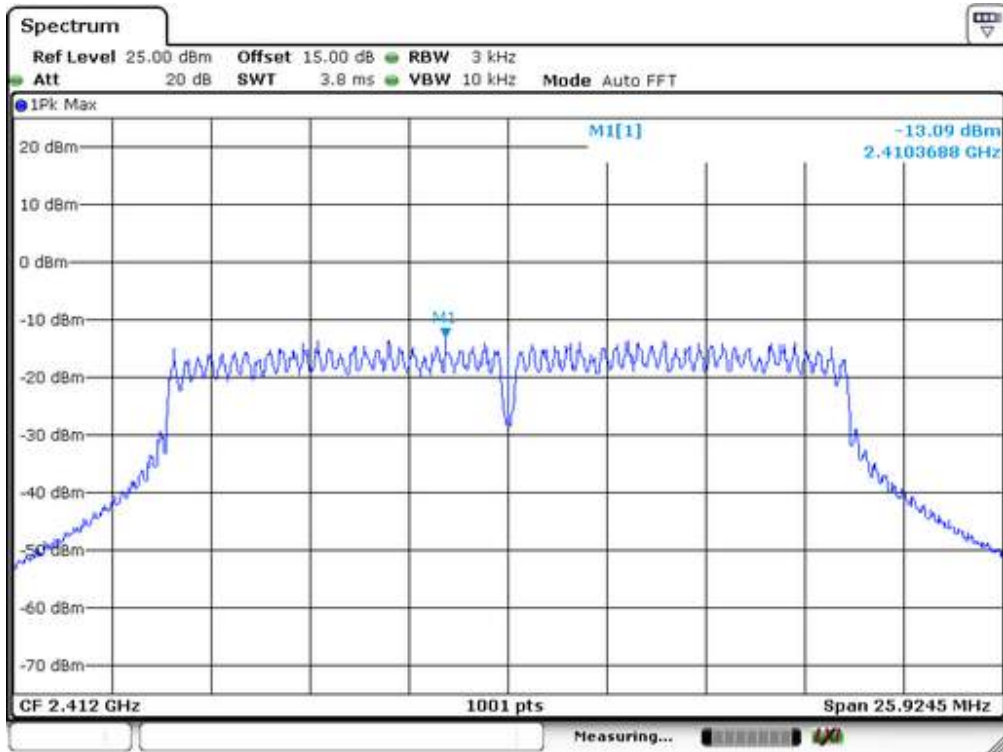

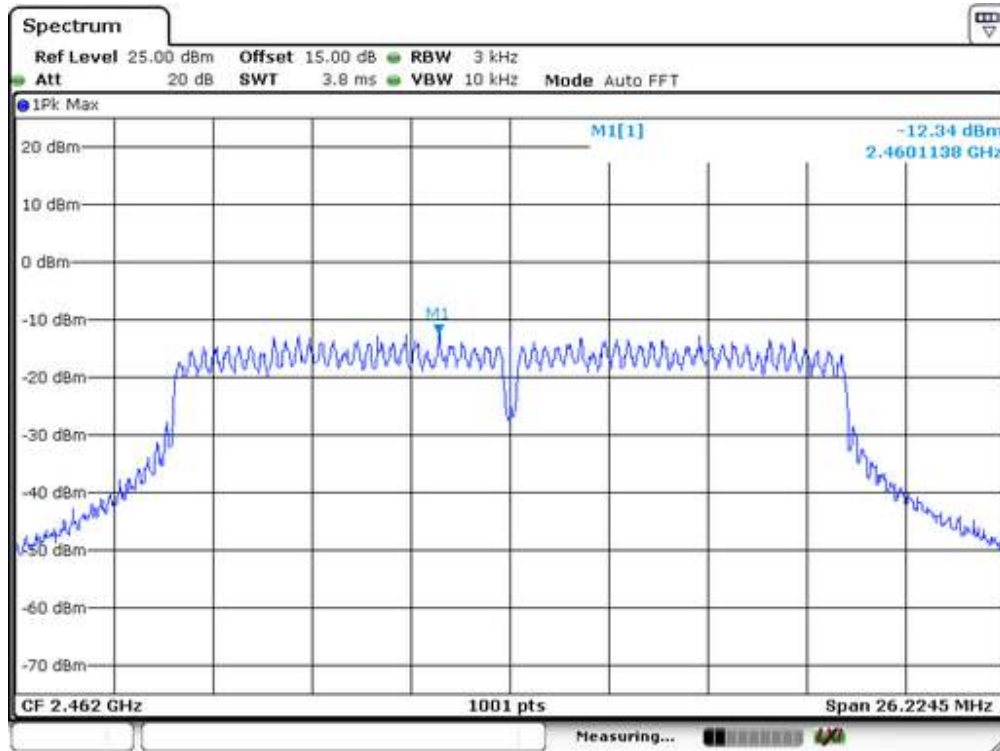

IEEE 802.11n(H40) MIMO(Antenna Gain=4.8dBi)					
Channel frequency (MHz)	Power Density (dBm/3kHz)			Power Density Limit (dBm/3kHz)	Result
	Ant 1	Ant 2	Total		
2422	-14.11	-14.05	-11.07	8	Pass
2437	-13.63	-13.37	-10.49		
2452	-13.51	-13.42	-10.45		
Remark: In MIMO, Ant1+Ant2 Directional Gain= $G_{ant}+10\log(N)$ dBi= $1.8+10\log(2)$ =1.8dBi. Directional Gain was according to KDB662911.					

Ant1

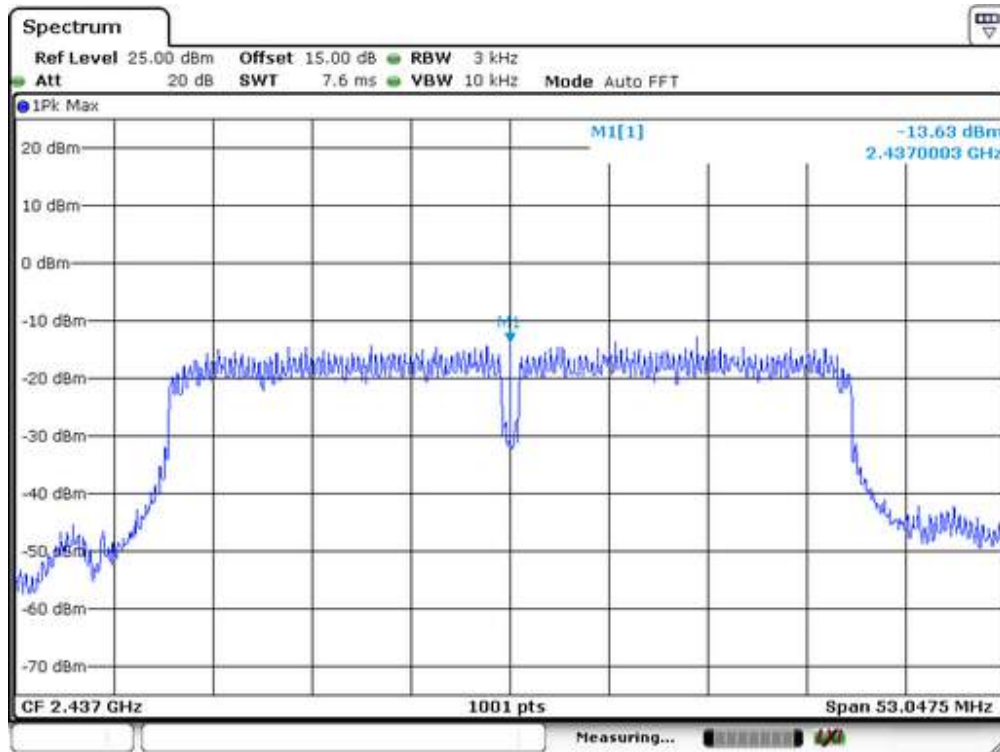
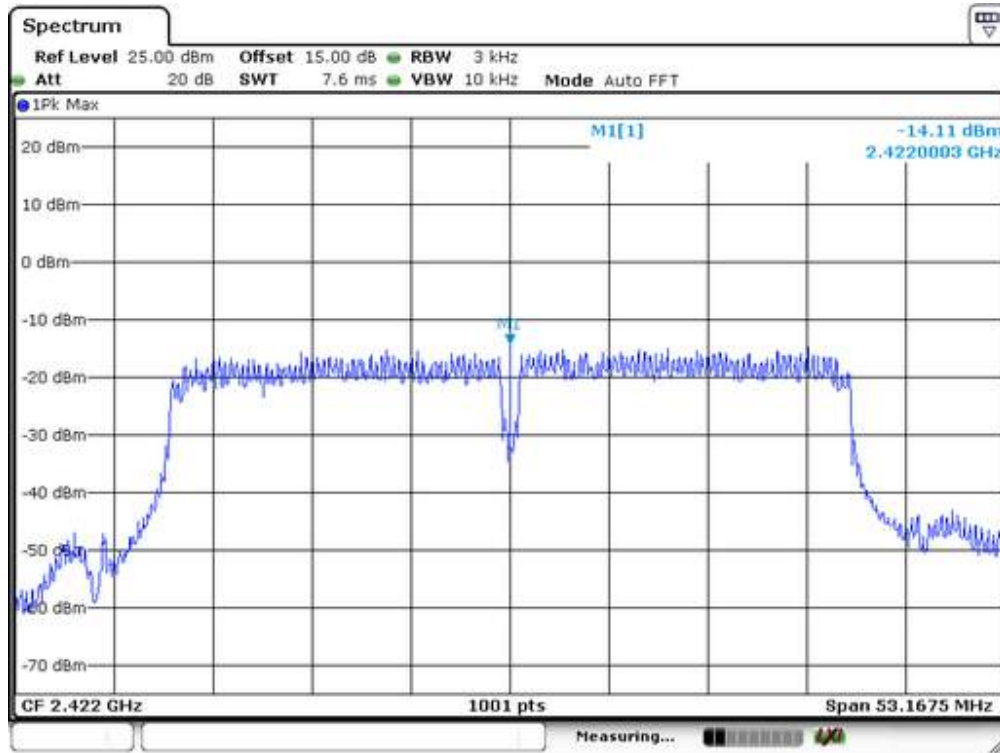

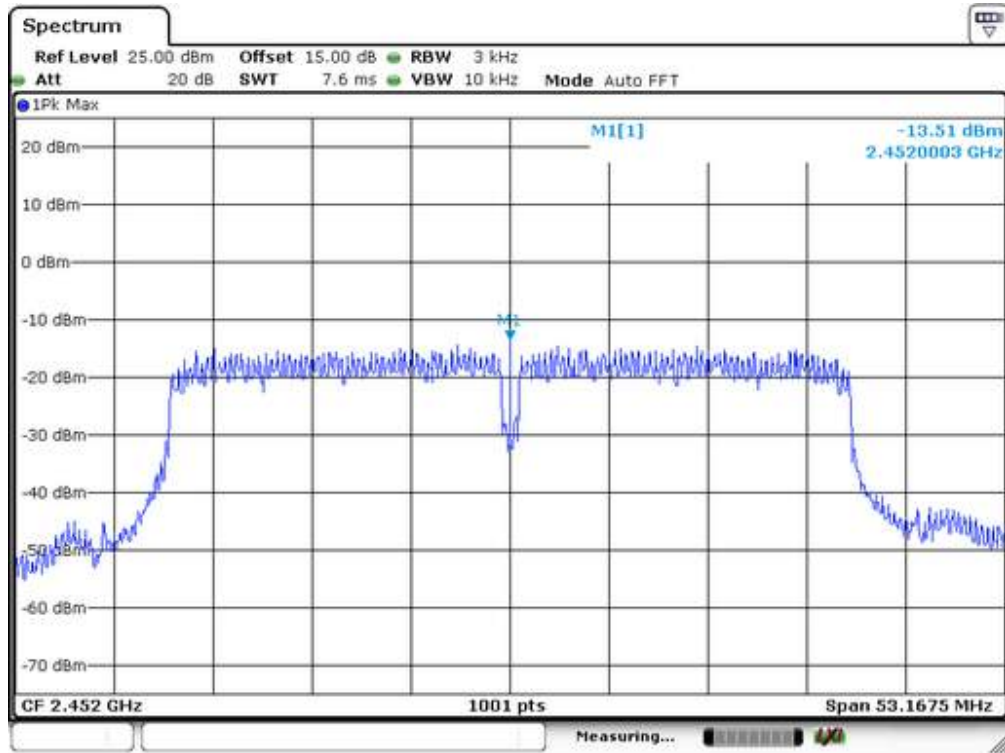

Ant2

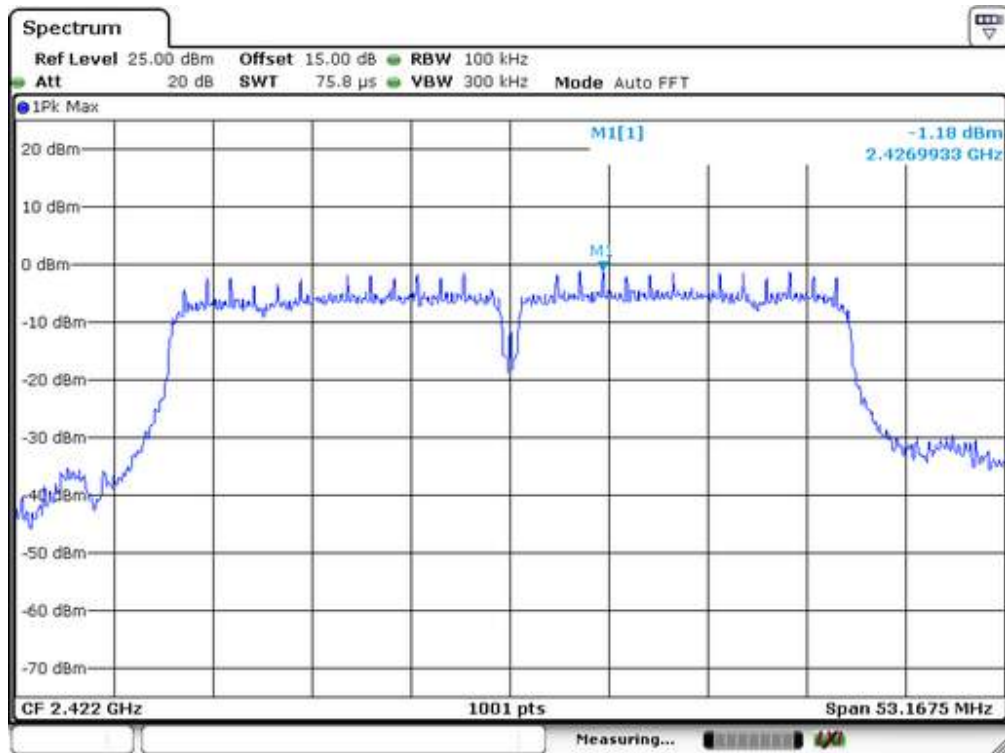



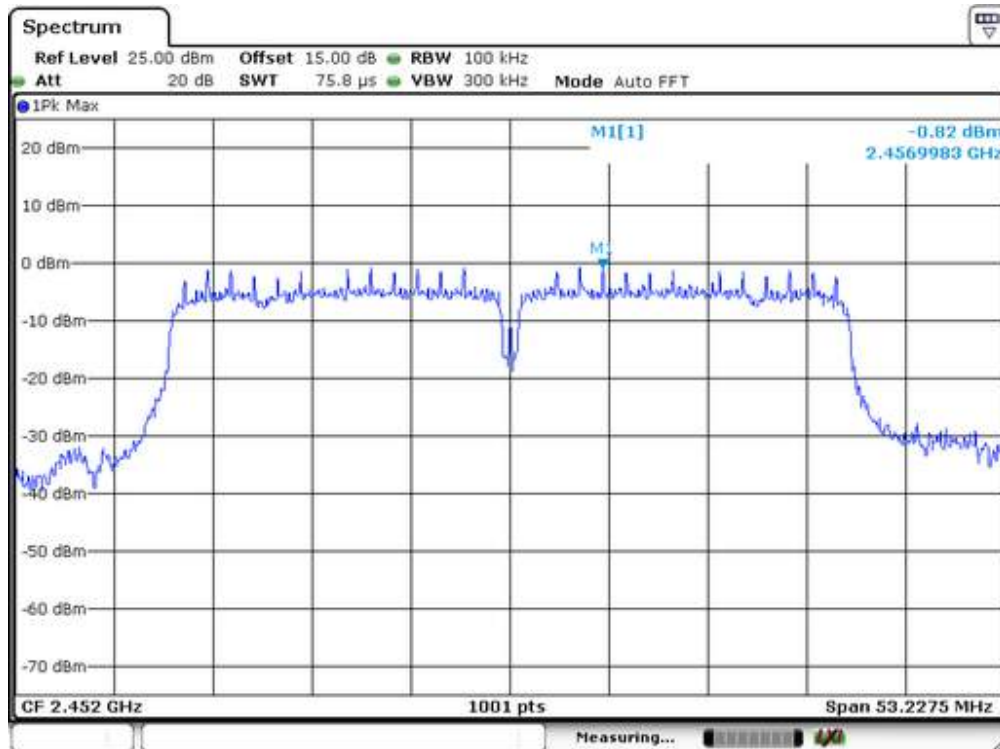
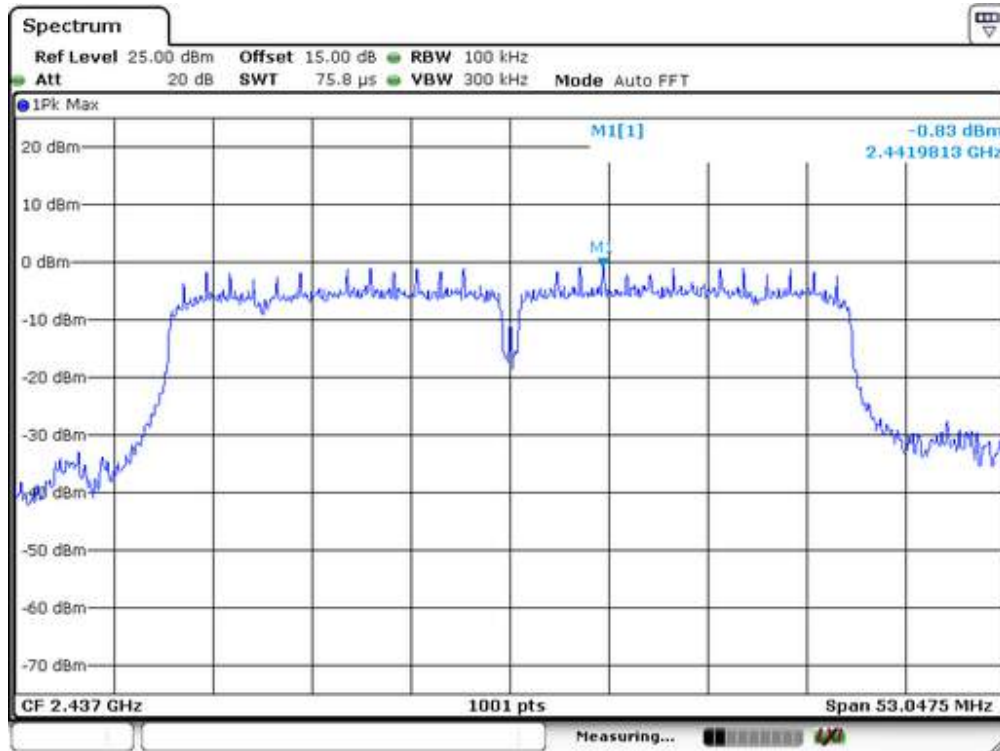

## 14. Antenna Port Emission

### 14.1 Test Equipment

EQUIPMENT TYPE	MFR	MODEL NUMBER	SERIAL NUMBER	LAST CAL.	CAL DUE.
Spectrum Analyzer	Agilent	FSV30	1321.3008K	05/16/2014	05/15/2015

### 14.2 Measuring Instruments and Setting

The following table is the setting of spectrum analyzer.

Spectrum analyzer	Setting
Attenuation	Auto
RB	100kHz
VB	300kHz
Detector	Peak
Trace	Max hold

### 14.3 Test Procedures

The conducted spurious emissions were measured conducted using a spectrum analyzer at low, Middle, and high channels, the limit was determined by attenuation 20dB of the RF peak power output.

### 14.4 Block Diagram of Test setup

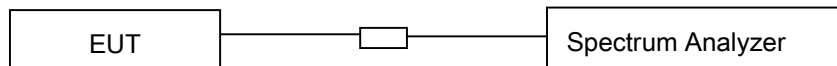

### 14.5 Test Result

**PASS.**

Please refer to the following pages.

Test Mode: IEEE 802.11b SISO Ant1

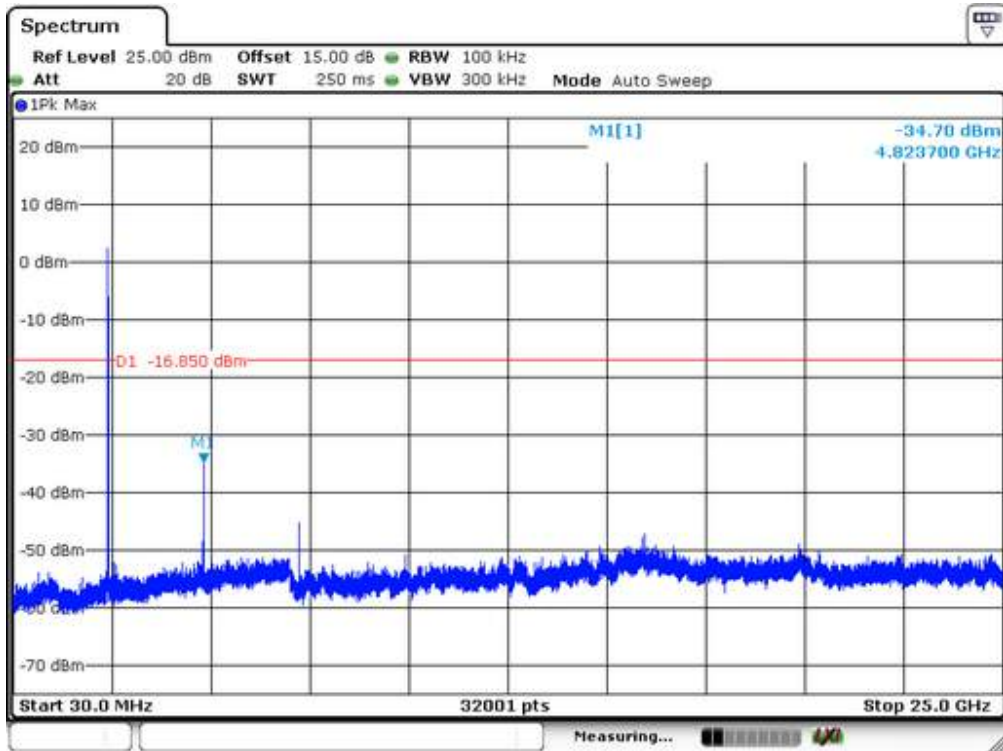

Lowest Channel

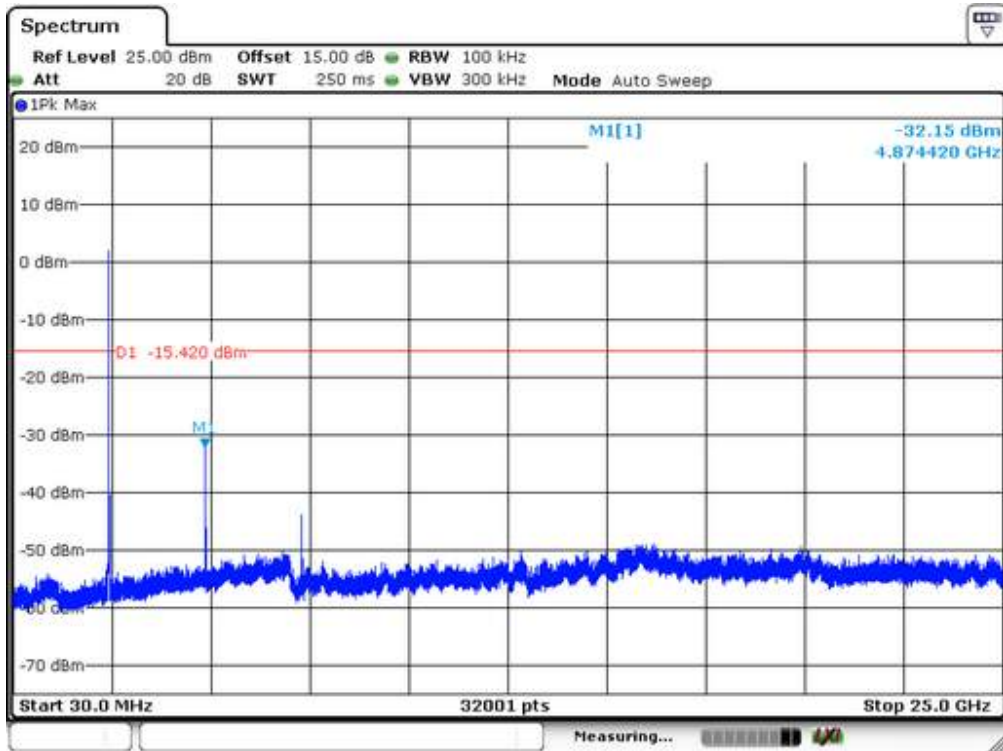

Middel Channel

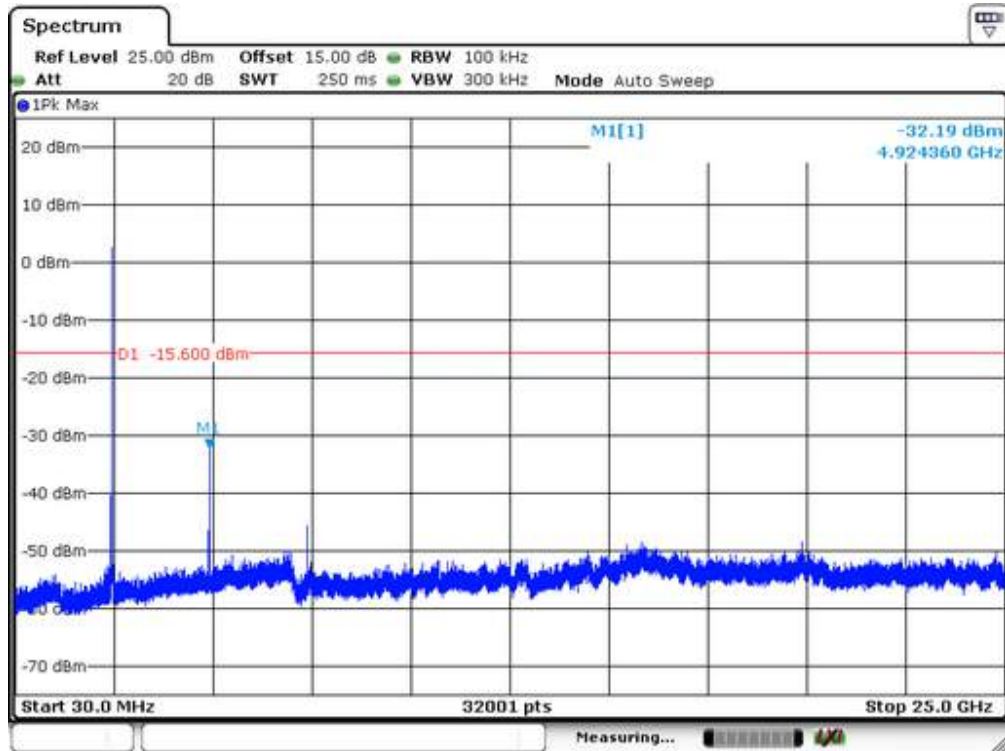

Highest Channel

Test Mode: IEEE 802.11b SISO Ant2

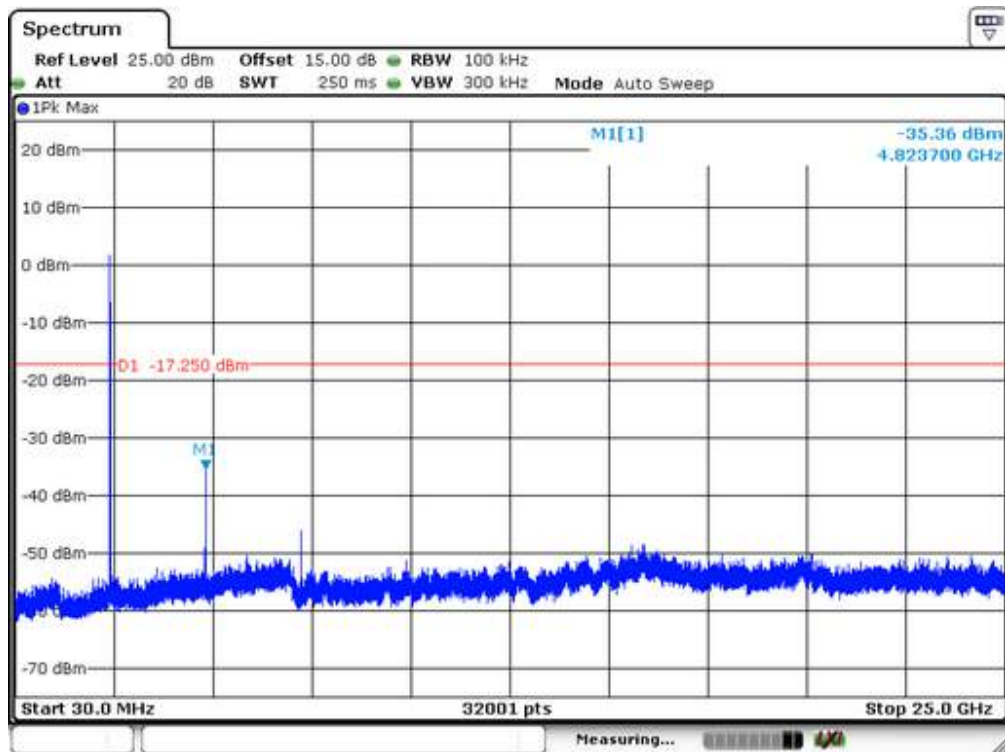

Lowest Channel

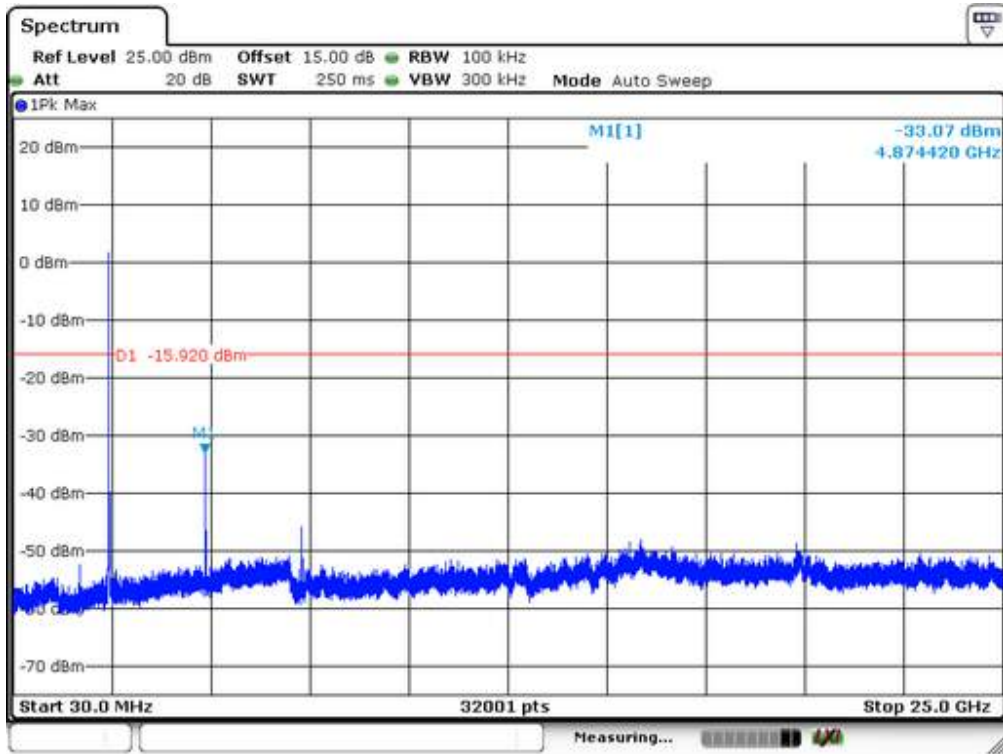

Middel Channel

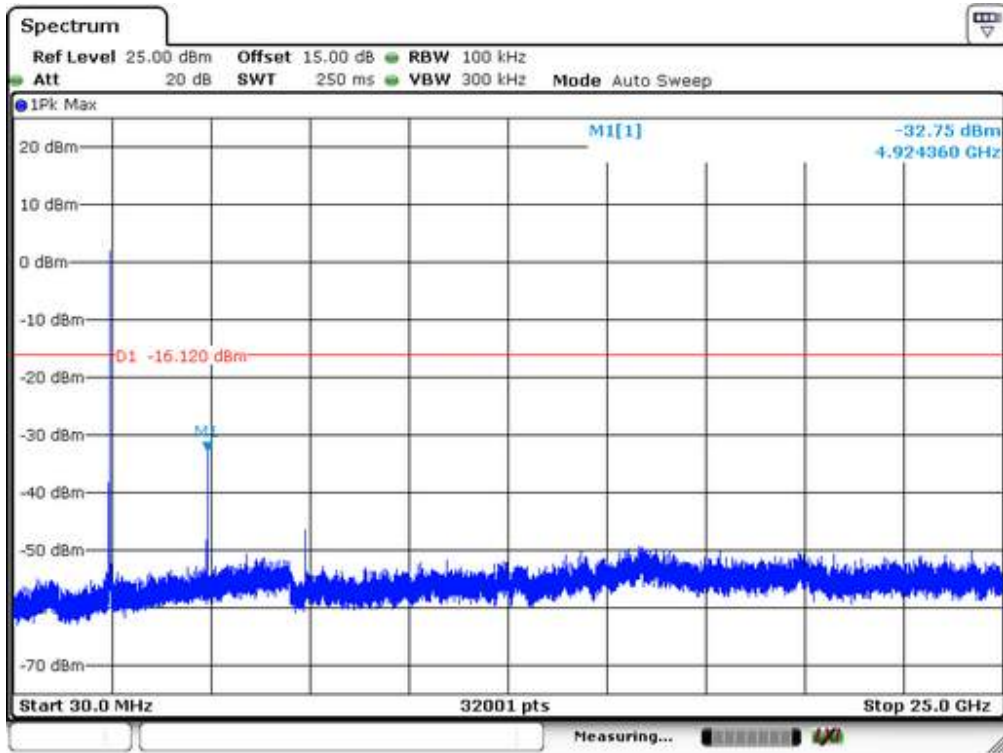

Highest Channel

Test Mode: IEEE 802.11g SISO Ant1

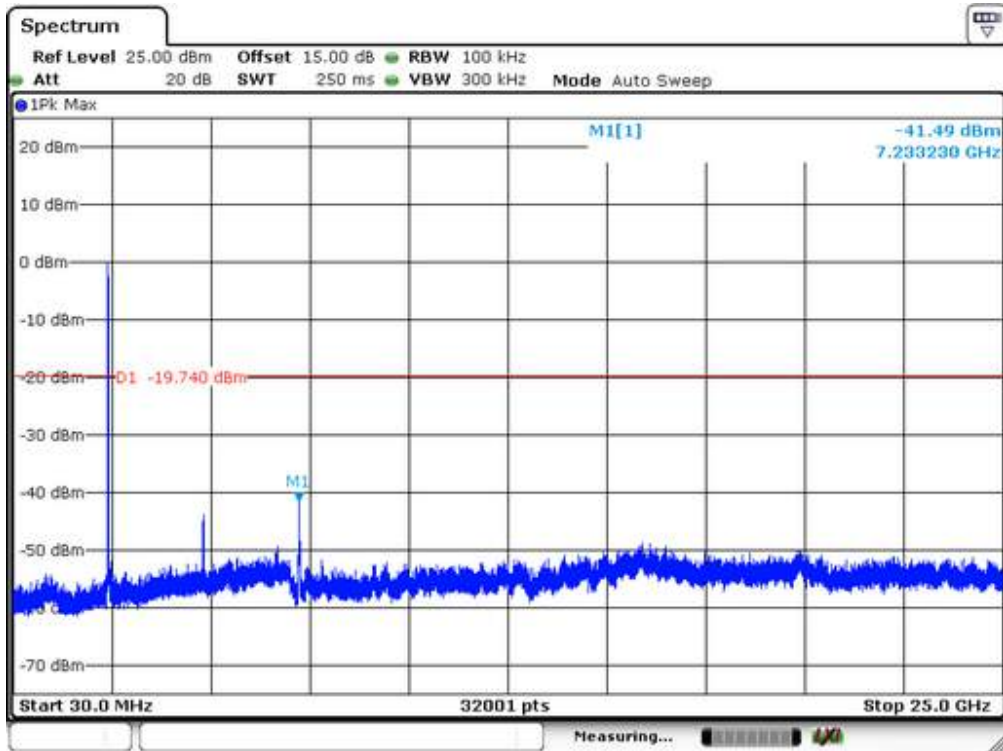

Lowest Channel

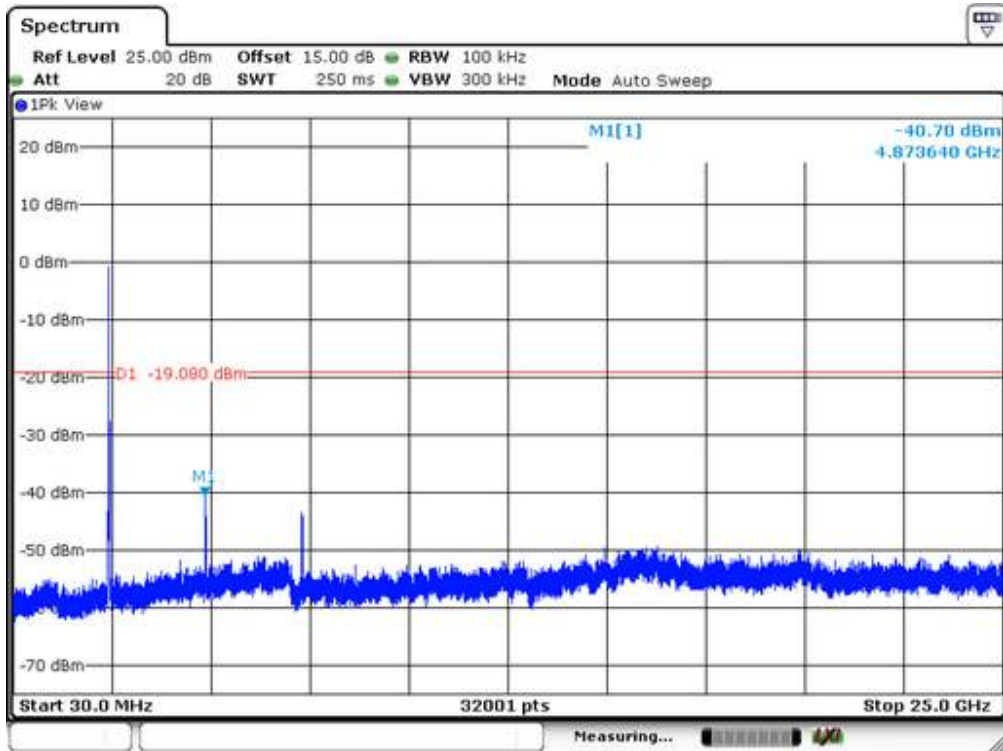

Middle Channel

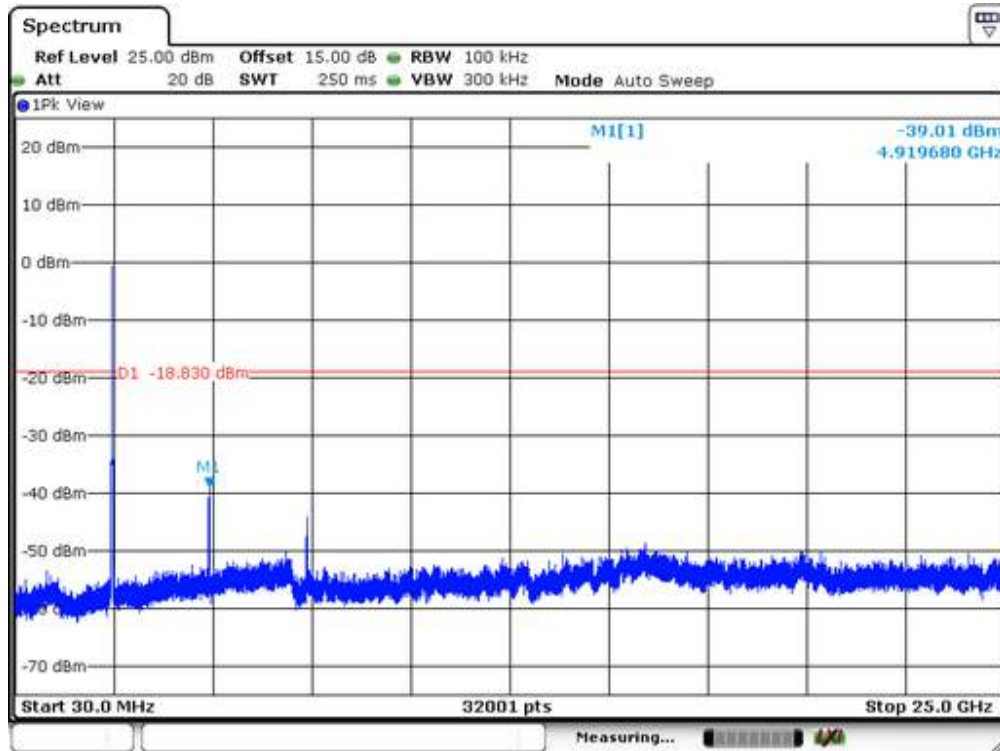

Highest Channel

Test Mode: IEEE 802.11g SISO Ant2

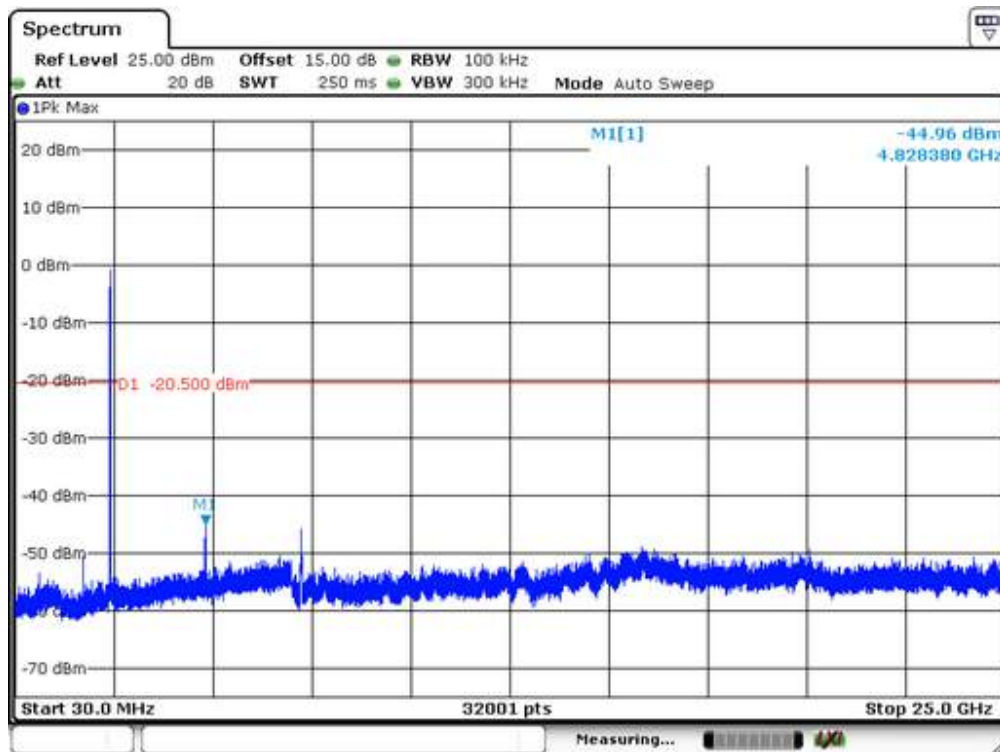

Lowest Channel

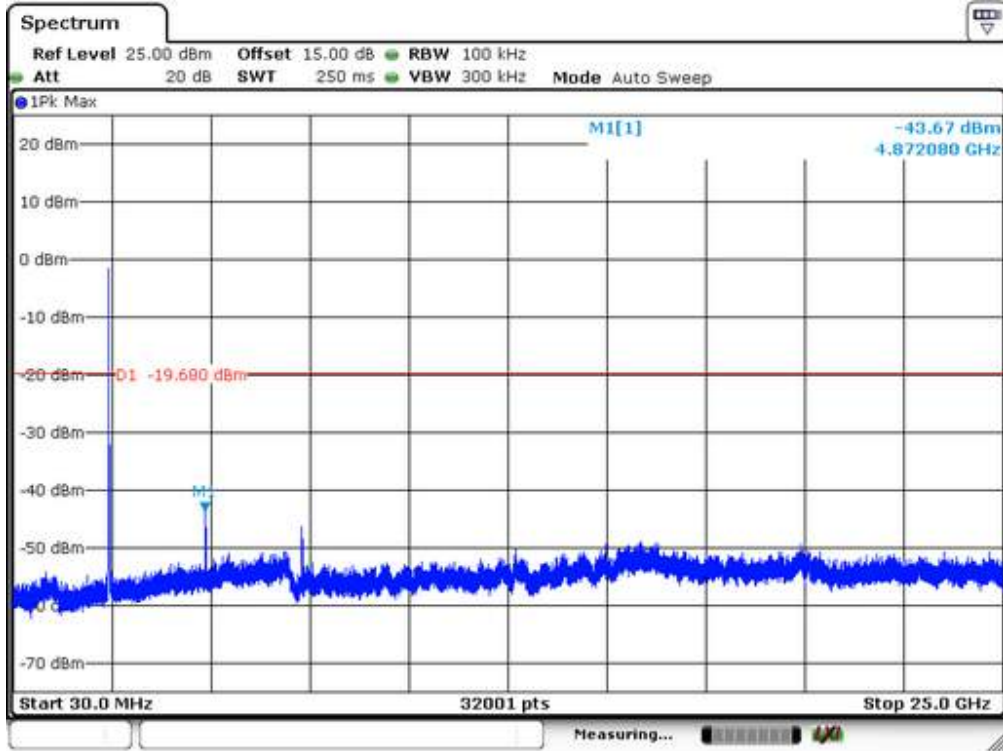

Middle Channel

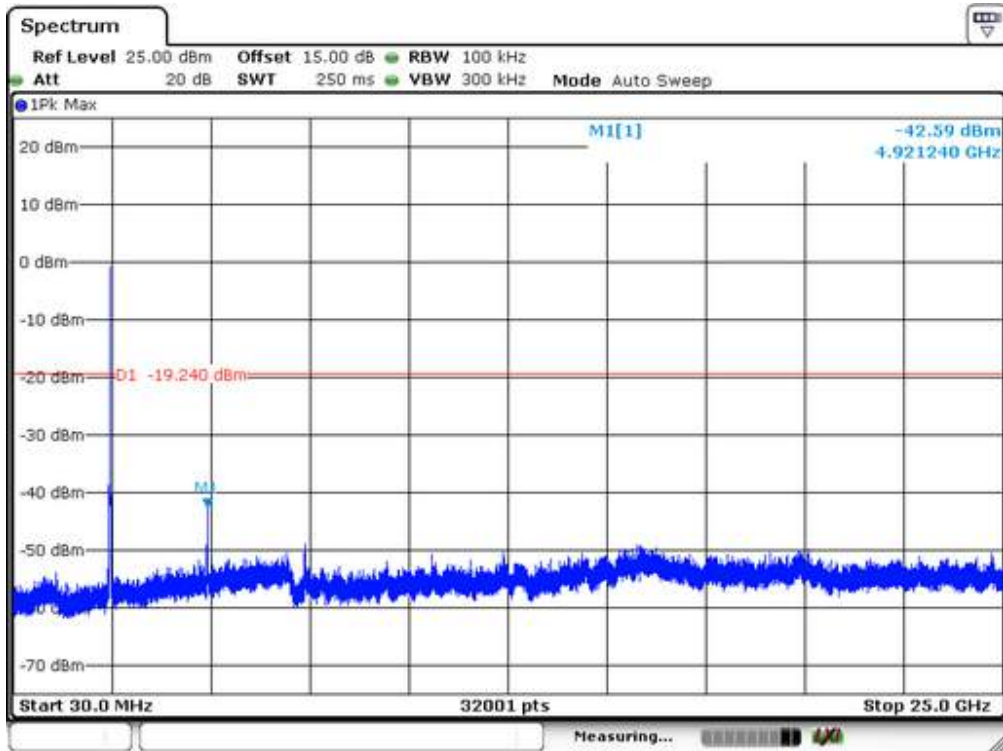

Highest Channel



Test Mode: IEEE 802.11n(H20) MIMO

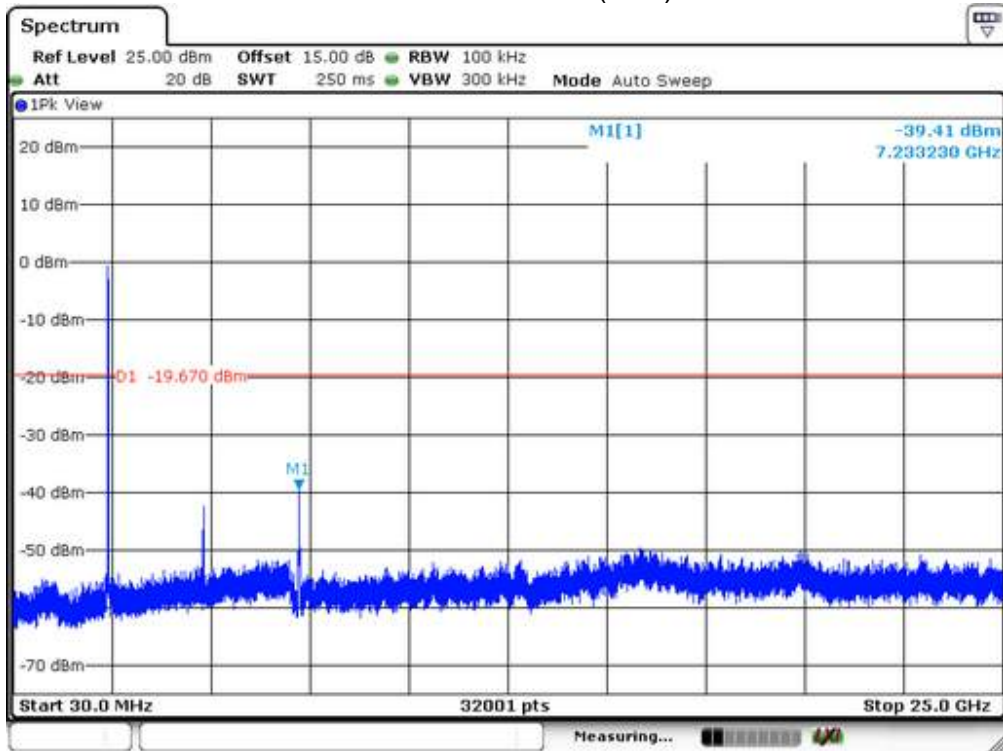

Lowest Channel

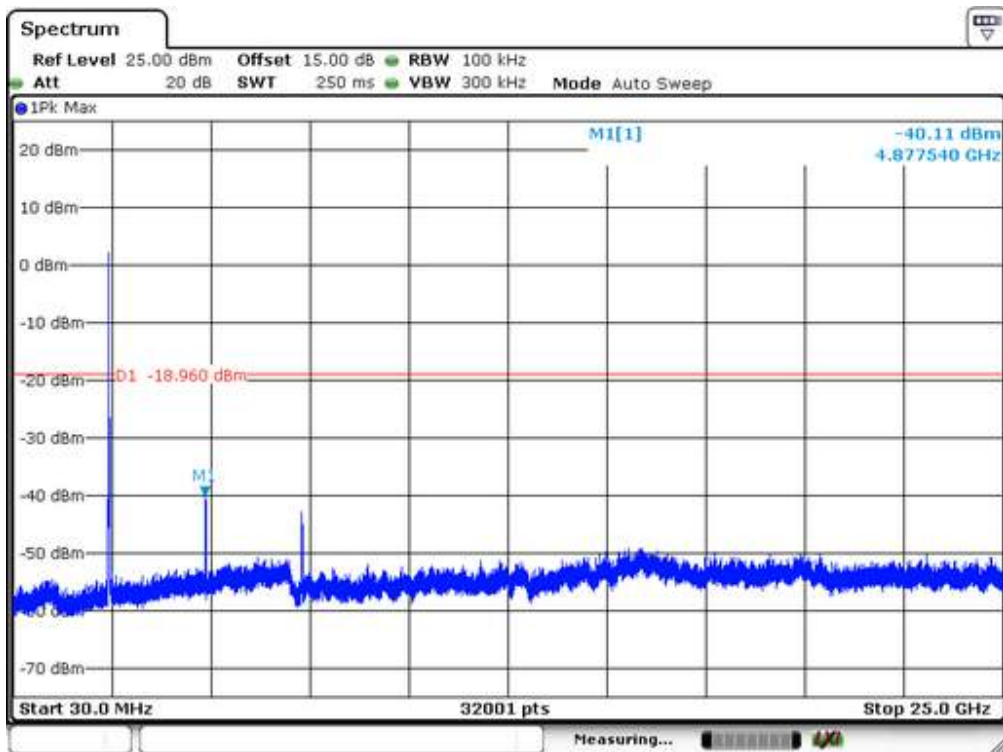

Middle Channel

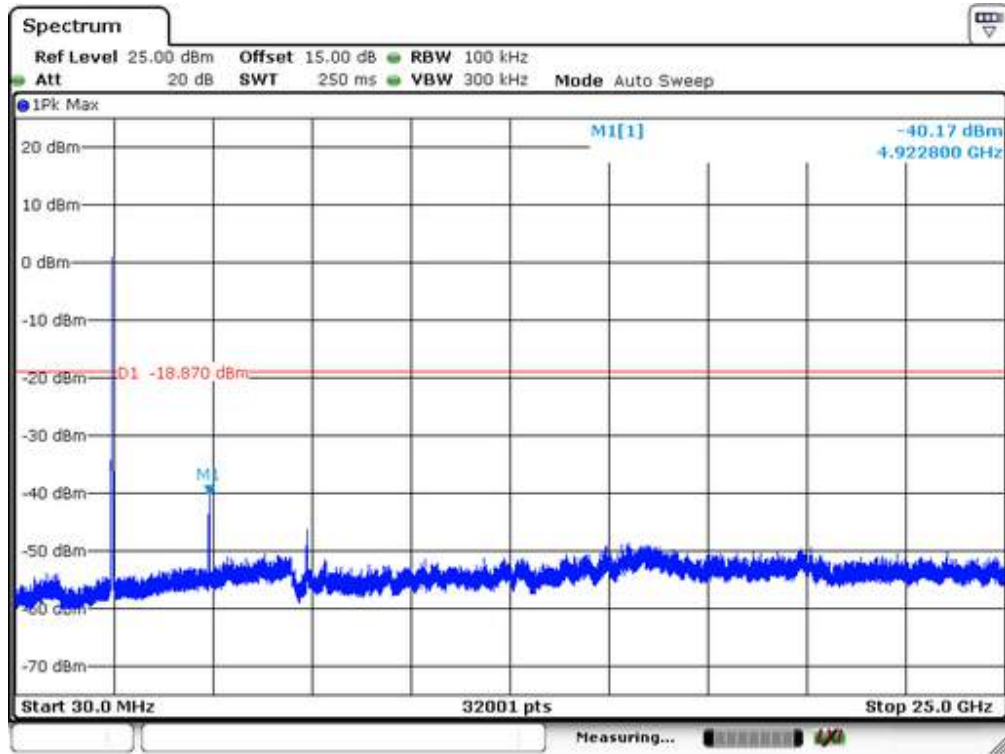

Highest Channel

Test Mode: IEEE802.11n(H40) MIMO

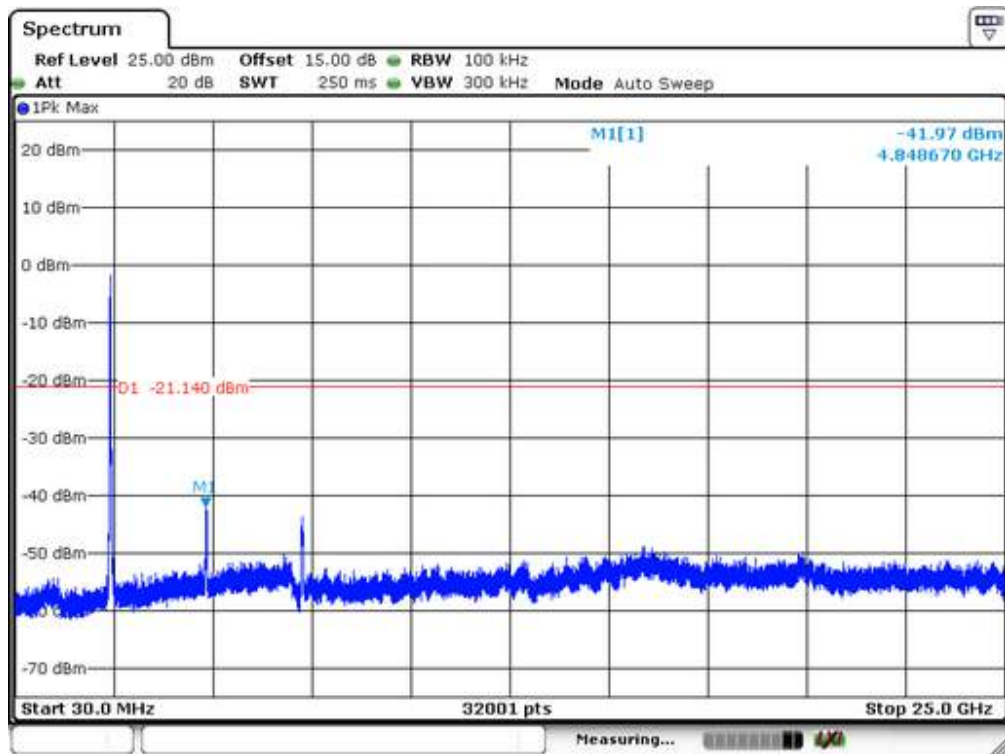

Lowest Channel

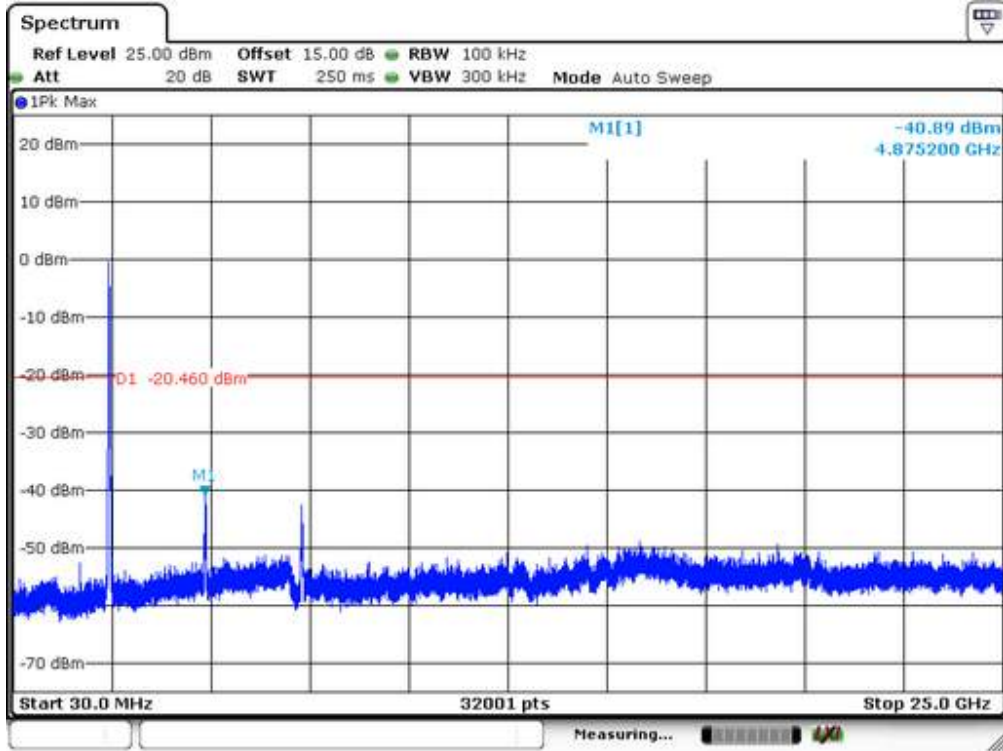

Middle Channel

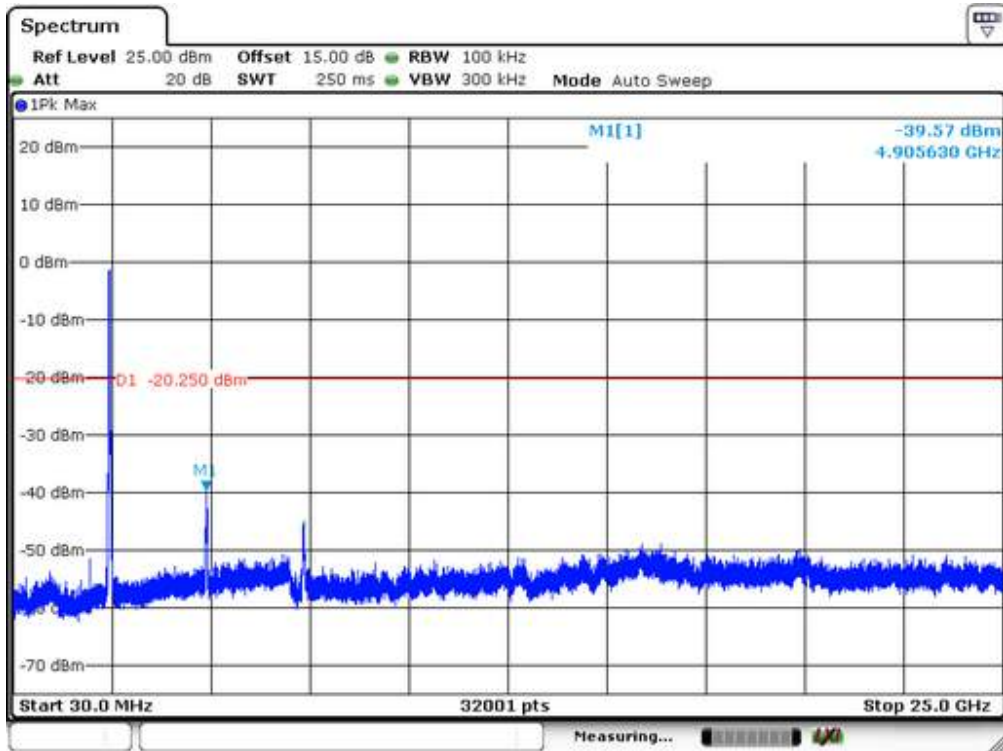

Highest Channel

## **15. Antenna Application**

### **15.1 Antenna Requirement**

For intentional device, according to FCC 47 CFR Section 15.203, an intentional radiator shall be designed to ensure that no antenna other than that furnished by the responsible party shall be used with the device. And according to FCC 47 CFR Section 15.247 (b), if transmitting antennas of directional gain greater than 6dBi are used, the power shall be reduced by the amount in dB that the directional gain of the antenna exceeds 6dBi.

### **15.2 Result**

The EUT'S antenna, permanent attached antenna, is internal PCB antenna. The antenna's gain is 1.8dBi and meets the requirement.

# APPENDIX I (PHOTOS OF EUT)

