



WHA YU INDUSTRIAL CO., LTD. (HEAD OFFICE)
 DONGGUAN AEON TECH CO.,LTD.(CHINA)
 TAI HWA ELECTRONIC CO., LTD.(CHINA)
 SHANGHAI HUA YU ELECTRONIC CO., LTD.(CHINA)
 SU ZHOU AEON TECH CO., LTD. (CHINA)

SPECIFICATION FOR APPROVAL

CUSTOMER: 中磊電子股份有限公司

PART NAME: RF Antenna Assembly

PART NO.: 61720145WY

REVISION:

W. Y. P/NO.: C147-510302-A(SSR-72536)

REV.: X2

	MANUFACTURER SIGNATURE	CUSTOMER SIGNATURE
APPROVED BY :	Andrew 	
DATE :	2007.08.02	

WHA YU GROUP

WHA YU INDUSTRIAL CO., LTD.(HEAD OFFICE)

譚裕實業股份有限公司

Address: No. 326, Sec. 2, Kung Tao 5 Road, Hsin Chu City, Taiwan, R.O.C.

Tel: +886-3-5714225(REP.) Fax: + 886-3-5713853 · + 886-3-5723600

DONGGUAN AEON TECH CO., LTD.(CHINA)

東莞台霖電子通訊有限公司

Address: Lakeside Industrial Park, Da Ling Shan Town, Dong Guan City, Guangdong, China

Tel: + 86-769-85655858 Fax: + 86-769-8565525

TAI HWA ELECTRONIC FACTORY

台樺電業製品廠

Address: Pak Ho District, Hou Street Town, Dong Guan City, Guangdong, China

Tel: + 86-769-85599375 · + 86-769-85912375 Fax: + 86-769-85599376

HUA HONG INTERNATIONAL LTD.

華弘國際有限公司

Address: Rm. 1103A, President Commercial Centre, 608 Nathan Road, Mong Kok, Kowloon, Hong Kong

Tel: + 86-852-27712210 Fax: + 86-852-23843747

SHANGHAI HUA YU ELECTRONIC CO., LTD. (CHINA)

上海譚裕電子有限公司

Address: 3586, Wai Qing Song Road, Qing Pu County, Shanghai China

Tel: + 86-21-59741348 · + 86-21-59744101~4 Fax: + 86-21-59741347

SU ZHOU AEON TECH CO., LTD. (CHINA)

蘇州華廣電通有限公司

Address: Limin North Road, LiLi Town, LiLi Industrial Park, LinHu Economic Zone

Wujiang City, Jiangsu Province, China

Tel: + 86-512-63627980 Fax: + 86-512-63627981

RF Antenna Cable Assembly

Specification

1. Electrical Properties :

- 1.1 Frequency Range..... 2.4GHz ~ 2.5GHz
- 1.2 Impedance 50 Nominal
- 1.3 VSWR 1.92 or less
- 1.4 Return Loss..... -10 dB Maximum
- 1.5 Radiation Detachable dipolar antenna
- 1.6 Gain(peak)..... 2.0dBi
- 1.7 Polarization..... Linear Vertical
- 1.8 Admitted Power..... 1W

2. Physical Properties :

- 2.1 Cable..... RG-178 Coaxial Cable
- 2.2 Antenna Cover..... TPE
- 2.3 Antenna Base..... PC
- 2.4 Antenna Base..... PBT
- 2.5 Operating Temp. -20 ~ +65
- 2.6 Storage Temp. -30 ~ +75
- 2.7 Color Black
- 2.8 Connector..... SMA Plug Reverse

CG-

REV	DATE	DESCRIPTION
X1	9/28-2006	New Issue
X2	8/1-2007	Modify package

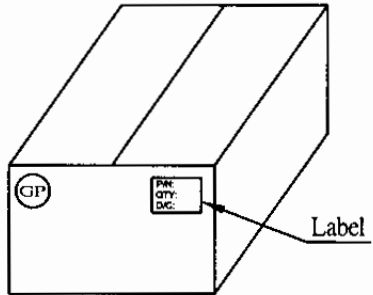
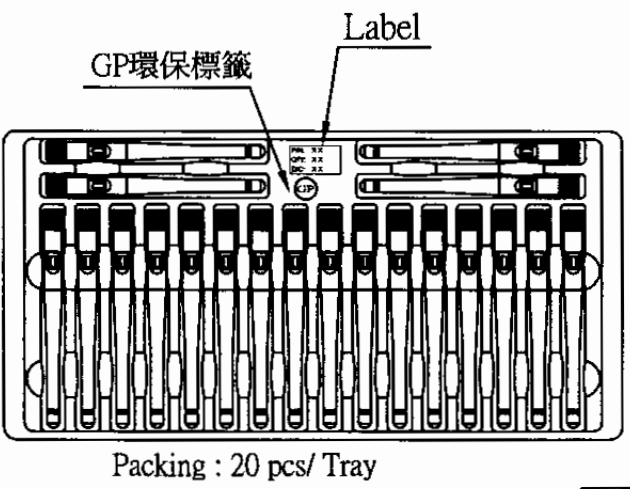
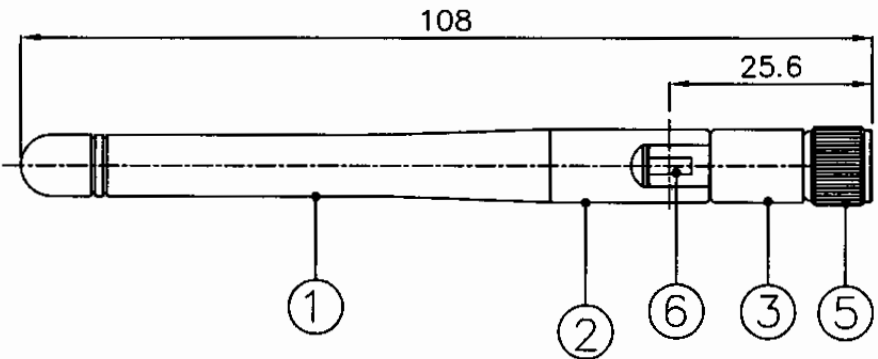
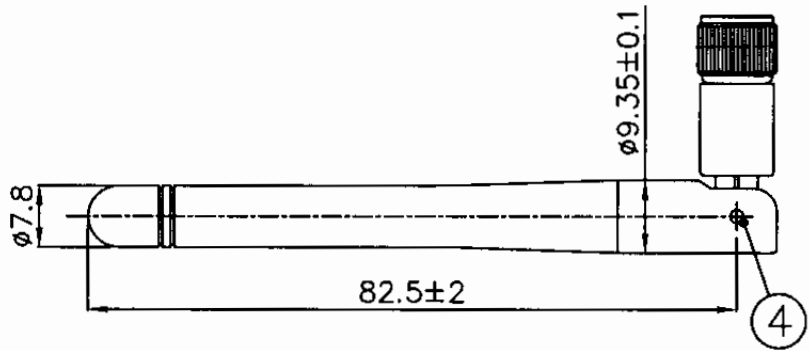

GP標籤貼於外箱兩邊側麥左上角共2PCS
標示Label貼於外箱兩邊側麥共2PCS

6	Cable	RG-178 , Translucent Brown ; 50 Ω	1	
5	Connector	SMA Straight Plug/Reverse	1	
4	Rivet	POM , Black	2	
3	Antenna Base	PBT ; Color:Black	1	
2	Antenna Base	PC ; Color:Black	1	
1	Antenna Cover	TPE ; Color:Black	1	
NO	DESCRIPTION		QTY	REMARK

CUSTOMER'S SINGATURE	XX.	±5	APPROVED	CUSTOMER: 中磊		
	X.	±3.0	Andrews			
	.X	±1.0	CHECKED		PART NO : 61720145WY	
	.XX	±0.5			PARTNAME: RF Antenna Assembly	
	.XXX	±0.1	DRAWING		W.Y P/NO : C147-510302-A	
				REV	UNIT	FILE : SSR-72536
				X2	m/m	SHEET : 1/1

M.gear Wha Yu Group

THIS DRAWING, AND ITS INHERANT DESIGN CONCEPTS, ARE THE PROPERTY OF WHA YU AND AS SUCH MAY NOT BE COPIED, REPRODUCED, OR GIVEN TO THIRD PARTIES WITHOUT THE WRITTEN CONSENT OF WHA YU.



譚裕實業股份有限公司

WHA YU INDUSTRIAL CO., LTD

Connector 材質證明書

譚裕料號 Whayu P/N	100-2001150-AZ	產品名稱 Product Name	SMA Plug Reverse Straight For RG-178
-------------------	----------------	----------------------	--------------------------------------

結構圖面

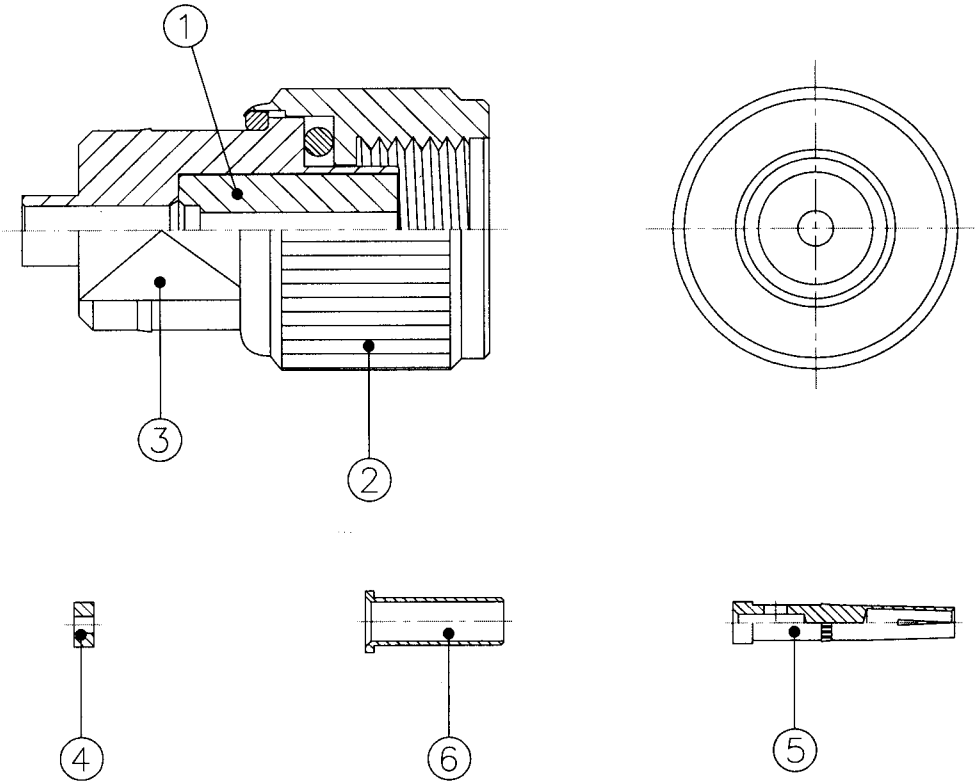

材質成份

表面處理

		材質成份							表面處理	
1	絕緣體	Teflon	PTFE							N/A
2	外殼	Brass	Cu	Pb	Fe	Fe+Sn	Zn		電著	
3	本體	Brass	Cu	Pb	Fe	Fe+Sn	Zn		鍍鎳	
4	絕緣體	Teflon	PTFE							N/A
5	中心針	Phos. Bronze	Cu	Sn	P	Zn	Pb		鍍金	
6	尾管	Brass	Cu	Pb	Fe	Fe+Sn	Zn		鍍鎳	

Remark :



ET-QA-0017-A2

RF Antenna Assembly
 P/NO :C147-510302-A SPEC : 2.4GHz

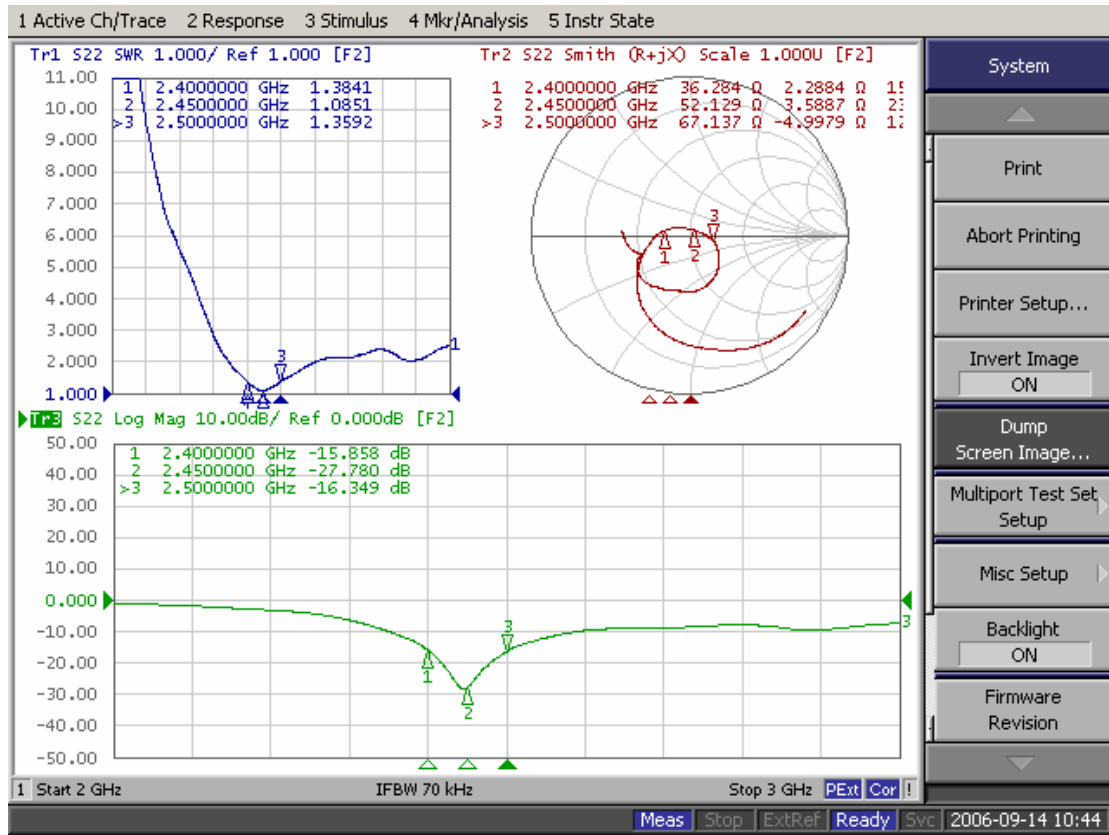

2006/9/21



譚裕實業股份有限公司

WHA YU INDUSTRIAL CO., LTD

Far-field amplitude of C147-510302-A-H.nsi

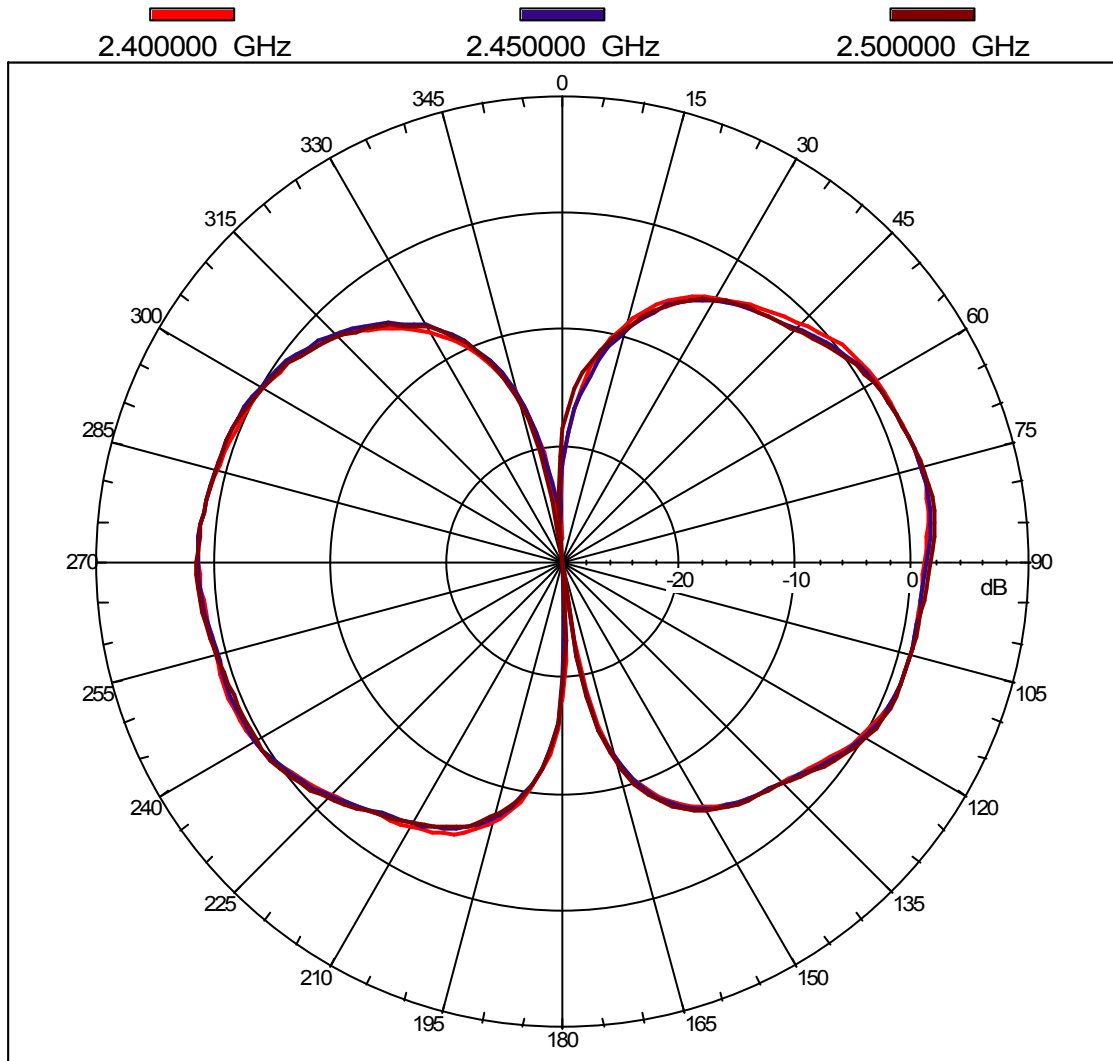



譚裕實業股份有限公司

WHA YU INDUSTRIAL CO., LTD

Far-field amplitude of C147-510302-A-V.nsi

