

1. Products	2
1.1 AdvanceGuard®	3
1.1.1 Technical Manuals - AdvanceGuard	4
1.1.1.1 HDR Series - Installation Guide	5
1.1.1.1.1 Mounting a radar sensor - AdvanceGuard	8
1.1.1.1.2 Connecting a radar sensor - AdvanceGuard	12
1.1.1.1.3 Confirming sensor operation - AdvanceGuard	15
1.1.1.1.4 Levelling a sensor - AdvanceGuard	20
1.1.1.1.5 Using SPx RadarView Lite - AdvanceGuard	24
1.1.1.1.6 Power supply details - AdvanceGuard	28
1.1.1.1.7 FAQ - AdvanceGuard	29
1.1.1.1.8 HDR 100 Series - Mounting Plate Drawing	31
1.1.2 Certification - AdvanceGuard	32

Products

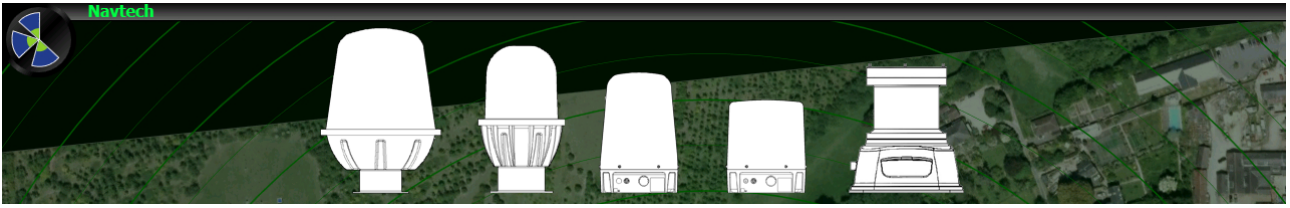

Navtech Radar Ltd. technical documents and certification information

Search this space

- cts-service
- installation
- hdr
- cts350-x
- hardware
- firmware
- health
- safety
- thea
- web-planner

Featured Pages

- [AdvanceGuard®](#)
- [ClearWay™](#)
- [SafeGuard™](#)
- [Popular Topics](#)
- [Technical Manuals - AdvanceGuard](#)
- [Technical Manuals - ClearWay](#)

Recently Updated Pages

- [FAQ - AdvanceGuard](#)
3 minutes ago • updated by [Rick Poulton](#) • [view change](#)
- [On-Board Firmware](#)
Aug 07, 2017 • updated by [Guy Avery](#) • [view change](#)
- [Radar Firmware](#)
Aug 07, 2017 • updated by [Guy Avery](#) • [view change](#)
- [Radar Firmware](#)
Aug 07, 2017 • updated by [Benedict Dakin-Norris](#) • [view change](#)
- [Firmware](#)
Aug 07, 2017 • updated by [Guy Avery](#) • [view change](#)

AdvanceGuard®

HDR Security Surveillance



The AdvanceGuard high definition radar security surveillance solution is an innovative alternative to high-cost manned guarding and provides a reliable, low cost solution that delivers continuous automatic perimeter surveillance. From small sites to large complex compounds, AdvanceGuard provides the most comprehensive security detection system available. It is ideal for applications such as airport surveillance, critical national infrastructure and commercial installations. The all-weather radar system detects, tracks and identifies threats, and by detecting beyond the perimeter, it can

identify potential intruders before they can enter the site.

On this page:

- [HDR Security Surveillance](#)

- [Technical Manuals - AdvanceGuard](#)
- [Certification - AdvanceGuard](#)

Technical Manuals - AdvanceGuard

- [HDR Series - Installation Guide](#)

HDR Series - Installation Guide

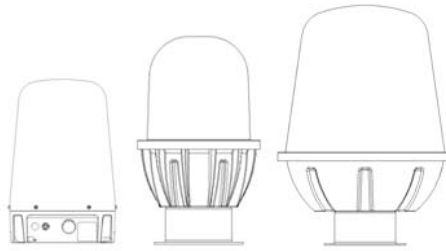

On this page:

- Welcome
- Support
- Essential items
- Parts
- Sensor Specifications
- Next: Mounting a radar sensor
- Related information

Guide Sections:

- Mounting a radar sensor - AdvanceGuard
- Connecting a radar sensor - AdvanceGuard
- Confirming sensor operation - AdvanceGuard
- Levelling a sensor - AdvanceGuard
- Using SPx RadarView Lite - AdvanceGuard
- Power supply details - AdvanceGuard
- FAQ - AdvanceGuard
- HDR 100 Series - Mounting Plate Drawing

Welcome

The purpose of this guide is to provide sufficient information to allow an AdvanceGuard radar to be physically installed, powered up and configured to correctly communicate over a network. This guide assumes that a suitably trained person has already performed a site survey and a suitable mounting location identified. The HDR radar, together with the Navtech Radar software Witness, form the Navtech Radar AdvanceGuard detection system. Service and Maintenance procedures are covered in a separate manual.

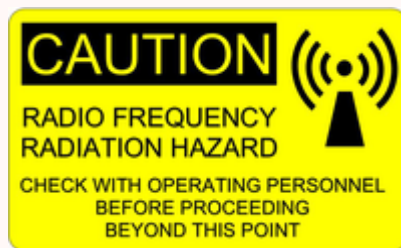

Before performing any maintenance task ensure you are aware of Health & Safety procedures

**Details here:
Health & Safety**

Support

Navtech Radar Ltd offer comprehensive support services both pre and post radar commissioning to ensure you get the best performance and support for your radar installation.

Navtech Radar Ltd have a dedicated Customer Services Support Centre that can offer 1st and 2nd line technical support for both hardware and software queries. The centre is staffed by a highly skilled technical team who can advise and offer support with any technical questions both pre and post commissioning. In the event a fault cannot be diagnosed remotely or a repair is required, the team can arrange for your radar to be returned to base for further diagnostic tests or repair.

Navtech Radar Ltd also offer a number of support plan options during the lifetime of your radar, offering peace of mind for your installation.

For further information on the support plan options or any technical questions please contact the Navtech Customer Services Support Centre on +44 (0) 1235 832419, or email support@navtechradar.com

The Navtech Radar AdvanceGuard system provides high integrity detection, tracking and intelligent alarm generation for wide area intrusion detection systems.

This guide concentrates on installing the key hardware components: Radar sensors; cameras and external inputs/ outputs.

As part of the installation process this guide also covers how to test the radar sensor output and adjust its positioning for optimum performance.

For details about the Witness application group, please refer to the companion **Witness Commissioning Guide**.

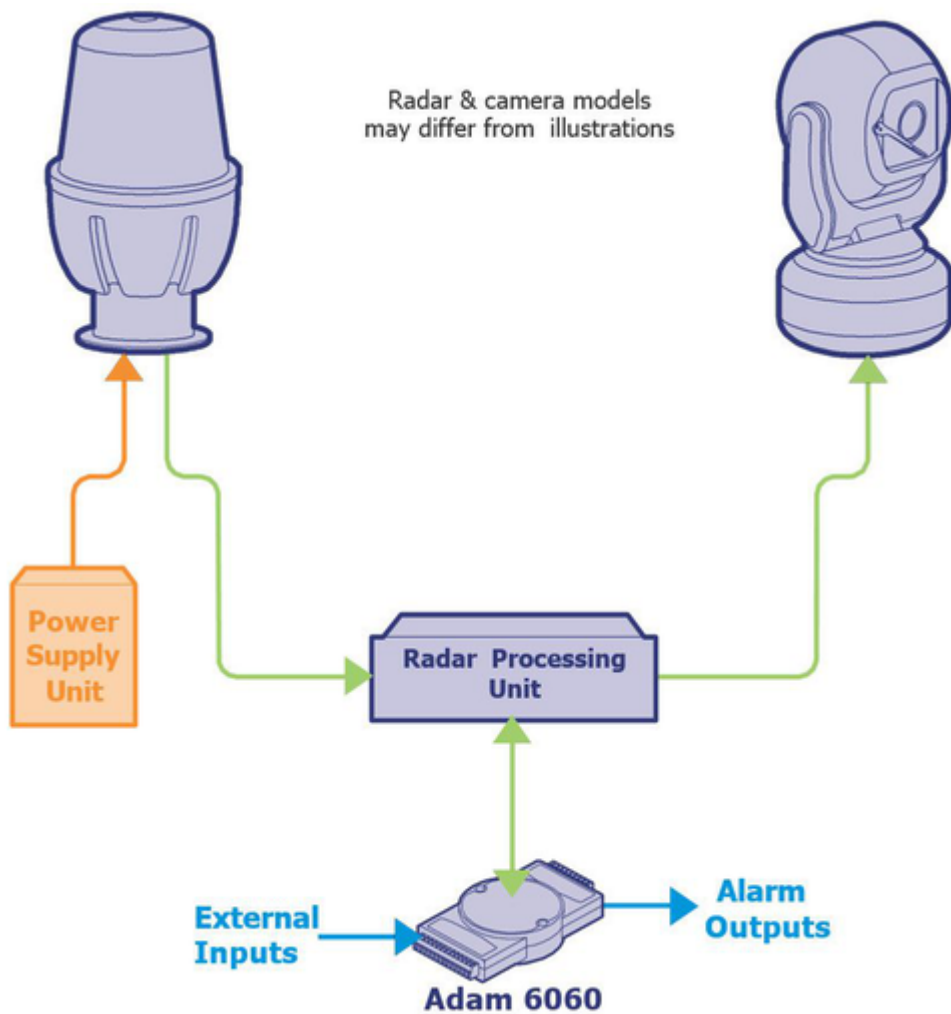

Essential items

The following are the essential additional items that you will need to install a radar sensor:

- Laptop computer with Ethernet port, Web browser (i.e. IE v10 or higher, Chrome) and RadarView Lite software v1.59.3 or higher, with the correct configuration file (see Appendix D)
- Cat5E patch lead
- Digital inclinometer (accurate to 0.1°)
- 25m² radar targets and mounting tripods - Qty 2 of each
- Spanners to suit mounting bracket used
- 4 & 6mm Allen keys for HDR100 Series
- Pair of 2 way radios
- An assistant

Parts

The images below show the main parts that are commonly used in most radar installations (mount poles are not shown). Note that these images are for illustrative purposes only, as items/casing shapes are subject to change.

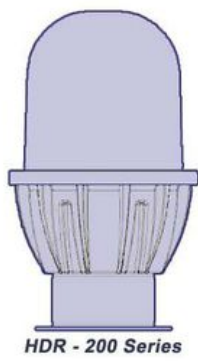

HDR - 200 Series

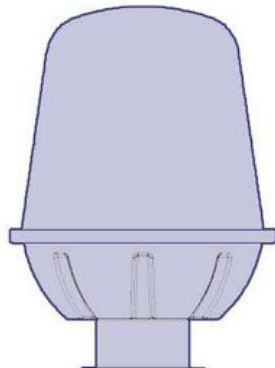

HDR - 300 Series

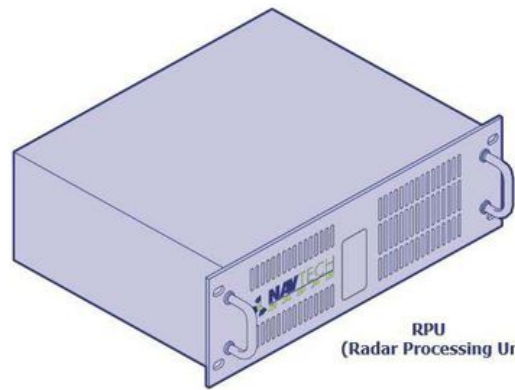

RPU
(Radar Processing Unit)

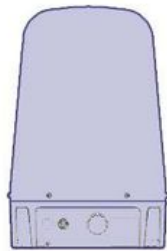

HDR - 100 Series



Radar sensor power cable
(bare ended at enclosure end)

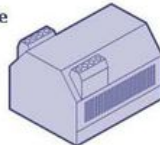

Radar sensor powersupply



Adam 6060 input/output unit



Mil spec shroud for radar sensor data cable connection

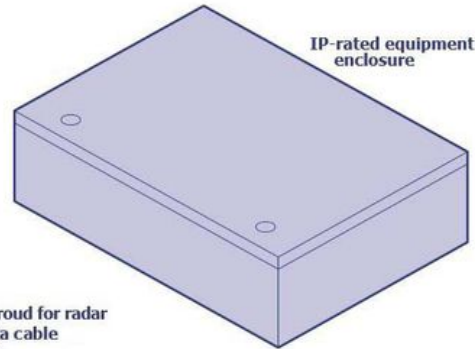

IP-rated equipment enclosure

Sensor Specifications

[HDR 100 Series Technical Specifications](#)

[HDR 200 Series Technical Specifications](#)

[HDR 300 Series Technical Specifications](#)

Next: Mounting a radar sensor

Related information

Patent Information

Patent No.: GB 2 518 344

US Patent Application No.: US14/901 862

International Application No.: PCT/GB2014/052018

Mounting a radar sensor - AdvanceGuard

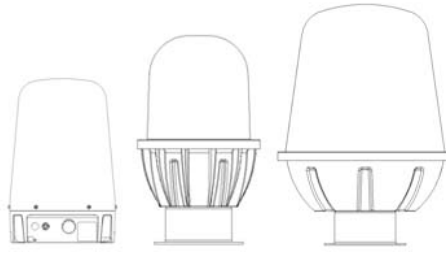

On this page:

- [Mounting a sensor HDR 200/300 Series](#)
- [HDR 100 Series Mounting](#)
- [Mounting the enclosure and power supply](#)
- [Next : Connecting a radar sensor](#)
- [Related information](#)

Mounting a sensor HDR 200/300 Series

Navtech Radar supply a range of radar sensors to mount on posts to suit various installation sites.

- Optimal mount height for a radar will depend upon a suitable site survey and are normally between 2 - 10 metres.
- Mount posts can have integrated CCTV camera arm mounts so radar and camera can be located on a single post.
- Telescopic mount posts which extend over a range of heights can make radar installation easier and safer.

Without a suitable site survey commissioning the system may require the raising or lowering of a sensor to clear obstacles or allow for the local terrain.

Where mounting **HDR 200/300 Series** radar this best practice is recommended. Each Radar should be mounted to the post mount plate using the items in the supplied stainless steel mounting bolts pack which contains:

- M6 x 60mm hex head bolts x4
- M6 Nut x7
- M6 Nyloc Nut x3
- M6 x 25mm Penny Washer x14
- M6 Spring Washer x7

For each of the mounting holes, the bolt is fed from underneath and locked onto the mounting plate with a nut and washers. Two more nuts and washers are then used, a plain nut above and Nyloc nut below the sensor plate so that the sensor can be positioned anywhere up or down the long bolt thread as necessary. See images below.

For HDR Series 200 and Series 300 radar the power and data connectors are made underneath the units. These connections are best made before locking down the radar in position. See section [Connecting a radar sensor - AdvanceGuard](#).

We recommend that you begin with the sensor completely horizontal and then carefully adjust it to suit the using the method described in the later sections.



Top of post mount plate



Underside of post mount plate

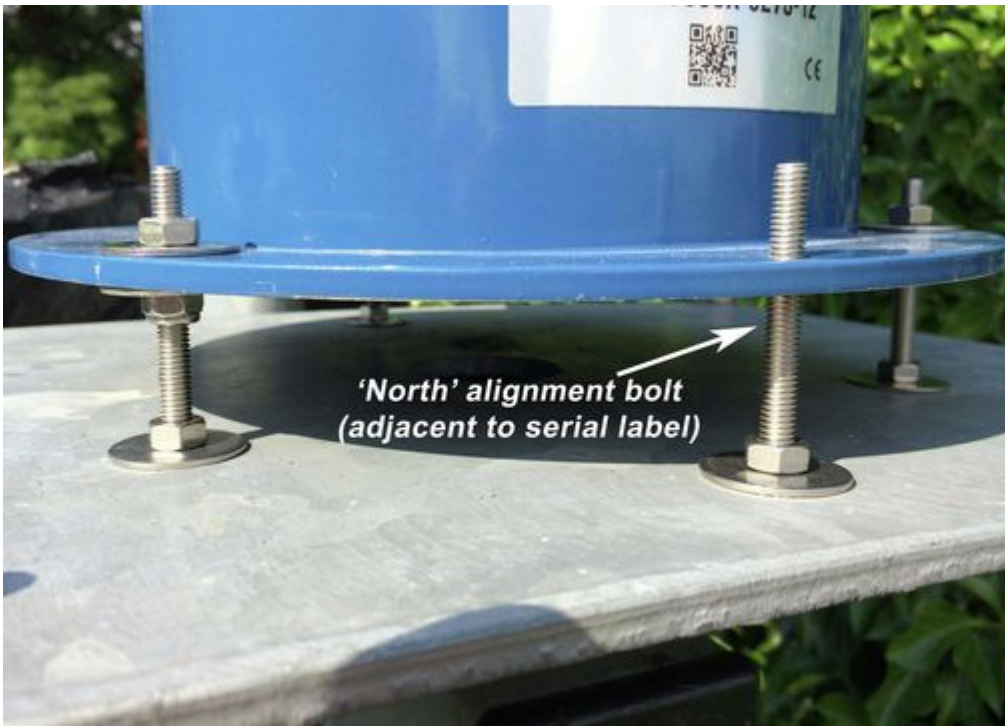



The Nyloc M6 nut used below the radar is so that the radar can be easily positioned and locked in position on the adjustment bolt. The Nyloc nut then holds its commissioning position should the radar be removed and replaced for any reason. Failure to use this method could result in incorrect remounting of the radar, resulting in poor radar performance and/or a rise in false alarms. This could require radar re-commissioning by a Navtech engineer on site.

HDR 100 Series Mounting

The HDR 100 Series can be mounted on a standard HDR 200/300 series post by using an adapter plate Navtech part MBP0143. Or on a dedicated post or other structure (e.g. walls, roofs, gantries) by use of standard CCTV mounting bracket. For correct operation of the radar Navtech recommend that any bracket should not move more than half a degree in any direction whilst carrying a radar under the required operating conditions (customer site specific). It should also be ensured that the radar line of sight is not obscured by any existing infrastructure.

To allow the radar to be installed in the optimum position relative to the detection zone the radar should be fitted to a mounting plate which allows the tilt to be adjusted (see images below). See [HDR 100 Series - Mounting Plate Drawing](#) for a mount plate diagram. The HDR 100 Series is fitted to the mounting plate using 4x M8 bolts in a 4" PCD pattern (standard CCTV mounting). The procedure for adjusting the tilt to optimise the radar performance is detailed in the section [Levelling a sensor](#).

The mounting plate provides a simple method to fine tune the incline of the radar. For each of the mounting holes, the bolt is fed from underneath and locked onto the mounting plate with a nut. Two more nuts are used below the radar base plate and another is used above so that the sensor can be positioned anywhere up or down the bolt thread, as necessary. An extra nut should then be added once the radar is optimally levelled to lock off the position.

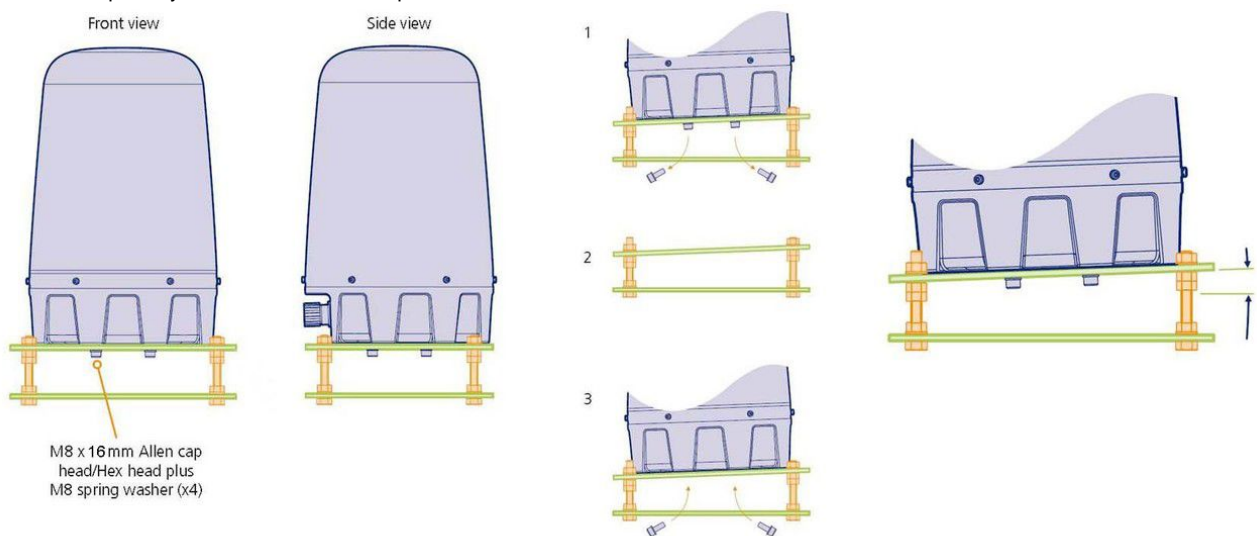

Swapping/removing and replacing a radar on a tilted bracket

Mounting the enclosure and power supply

An IP-rated equipment enclosure is normally located at the base of the radar post and is used to house the radar power supply unit, however, other items may also need to be housed within the enclosure:

- If the radar is mounted more than 70 metres from the RPU server then it is recommended that a fibre optic ethernet link is used. In this case a media converter would also need to be housed within the enclosure.
- If there is a camera option on the post then the camera power supply unit and a possibly a video encoder will also need to be housed.

IMPORTANT: To prevent floating voltage levels on the low output of the radar sensor power supply unit, link the 0v output to earth.

For details of the power supply please see [Power Supply Details](#)

IMPORTANT: Note that each radar is supplied with a pre-installed vent plug. This vent plug maintains ingress protection while allowing radar internal and external pressure to equalize and should be installed at all times. Removing or blocking the vent plug in any way could invalidate the warranty in the event of damage.

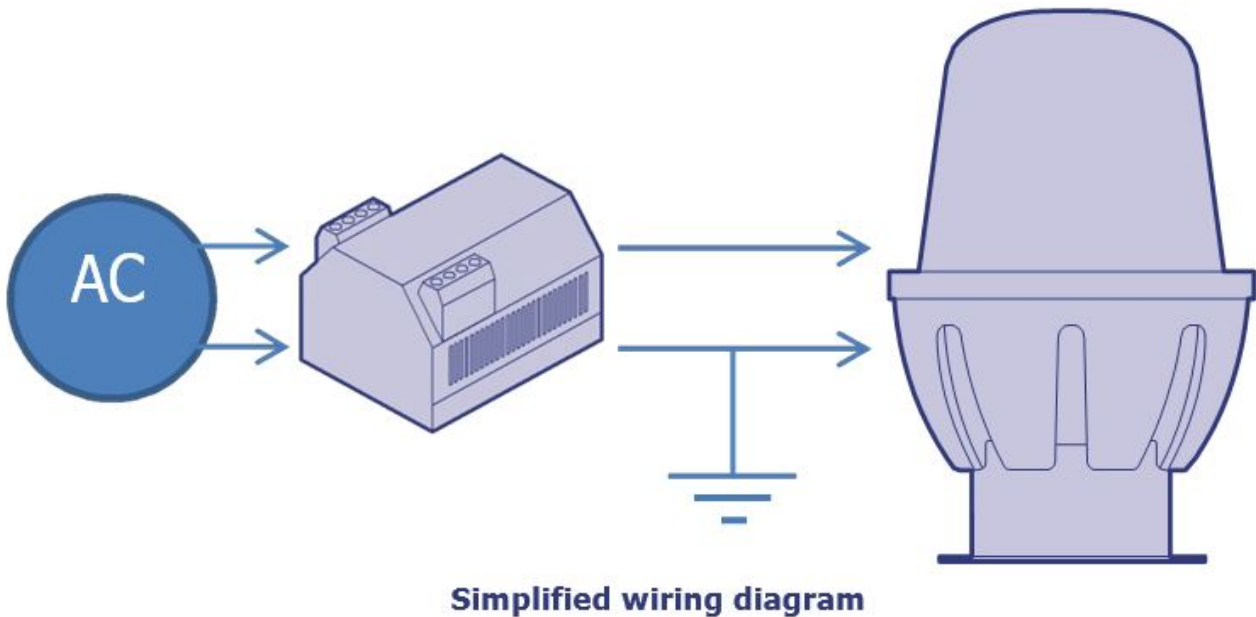

Next : [Connecting a radar sensor](#)

Related information

Patent Information

Patent No.: GB 2 518 344

US Patent Application No.: US14/901 862

International Application No.: PCT/GB2014/052018

Connecting a radar sensor - AdvanceGuard

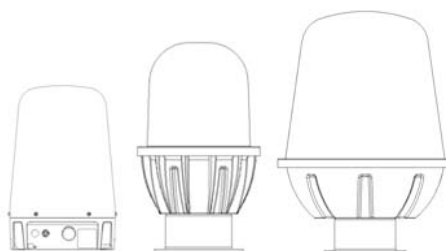

On this page:

- [Connecting a radar sensor](#)
- [Next: Confirming sensor operation](#)
- [Related information](#)

Connecting a radar sensor

Each radar sensor requires a power and a data connection. Both are made using special specification connectors to ensure link integrity in the harshest environmental conditions. In the majority of cases, the power and data connections run from the sensor to the enclosure at the base of the mounting pole where the power supply is situated.

Supplied with each radar sensor is a power cable with an outdoor connector for connection to the sensor and a bare end at the enclosure connection. An environmental shroud is also supplied for use with a suitable environmentally protected Ethernet network cable. It is essential that the supplied shroud is correctly used to ensure that the data connection is water tight.

IMPORTANT: Failure to correctly fit the shroud can invalidate the warranty on sensors that have been caused to fail through water ingress.

Connections to HDR radar series 200 & 300

On Series 200 and Series 300 HDR radar the connections are made underneath the units:

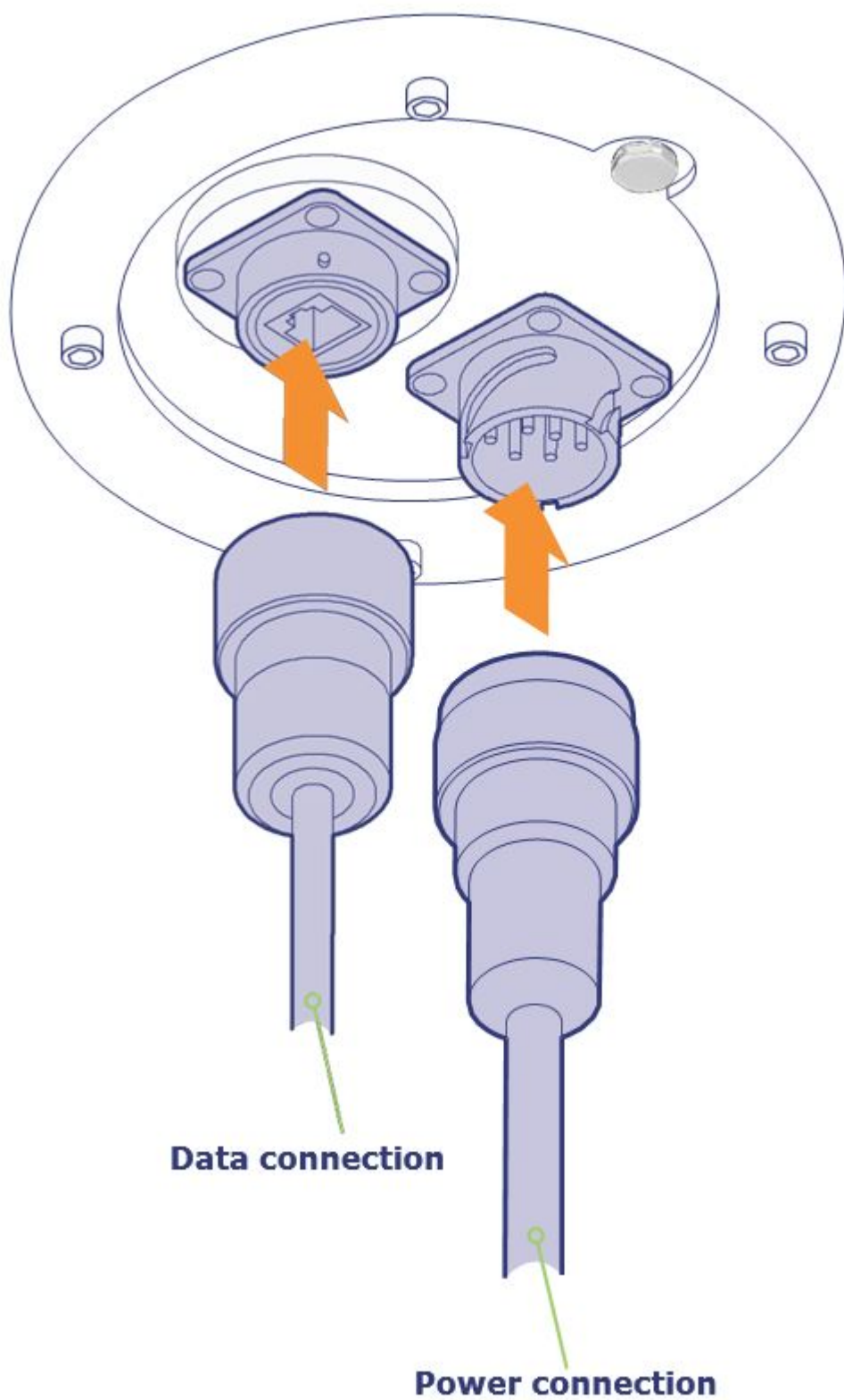

Connections to HDR radar series 100

On Series 100 Series HDR radar the connections are made on the side of the units:

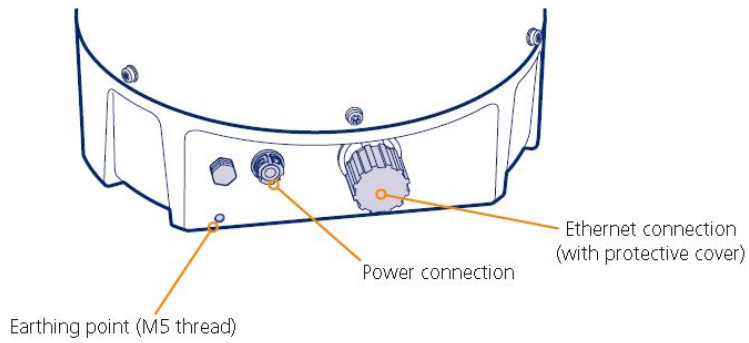

Binder power connector

(99 0771 001 08)
Pins 1 & 3: +24VDC
Pins 2 & 4: GND

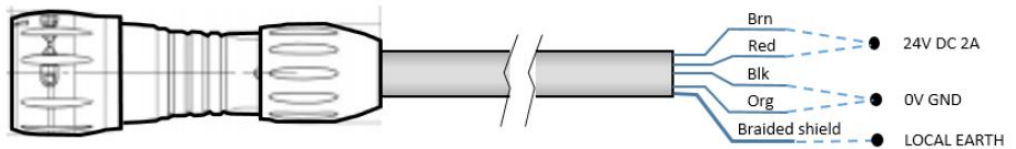

Ethernet connector

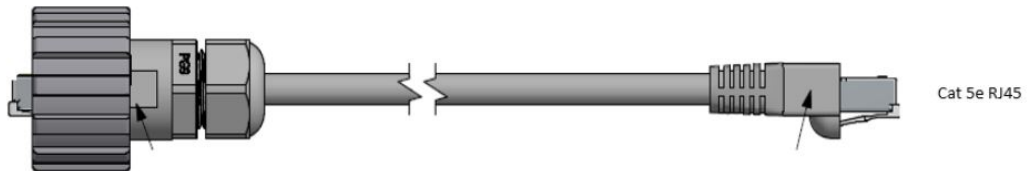

1. Remove the protective cap from the Ethernet connector and attach the RJ45 plug. Ensure that the weatherproof shroud on the Ethernet connector is secure.
2. Attach the 24V DC plug to the connector (by pushing it fully on and turning clockwise to lock).
3. Attach a suitable earth cable to the earthing point (requires an M5 bolt).
4. Ensure that the power and Ethernet cables are securely connected into a suitable junction box that has a suitable 24V DC power supply installed.

Note: The radar typically draws a continuous 800mA, but when the internal heater is active, this rises to approximately 2.2A. Ensure that the Power supply cabling is correctly terminated.

5. Ensure that the junction box has an Ethernet cable/fibre optic running to the infrastructure network switch.
6. When power is applied, ensure that the radar begins rotating - you can easily hear this, although it takes approximately 10 seconds for the radar to start rotating – in cold conditions this could be longer.

Next: Confirming sensor operation

Related information

Patent Information

Patent No.: GB 2 518 344

US Patent Application No.: US14/901 862

International Application No.: PCT/GB2014/052018

Confirming sensor operation - AdvanceGuard

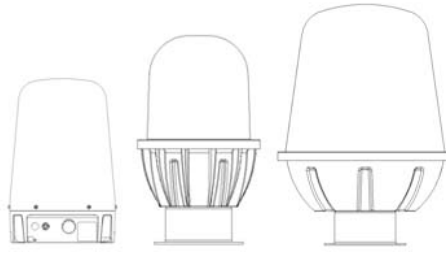

On this page:

- Confirming sensor operation
- Preparing your computer
- Testing a sensor
- Caution - HDR 100/200/300 Series Power removal
- Next: Levelling a sensor

Confirming sensor operation

In order to test the output of the radar sensor, you will require:

- A portable computer running Windows 7 or 10,
- A CAT 5, 5e or 6 network cable (straight or crossover wiring).

Preparing your computer

IMPORTANT: Ensure that your computer has its IP address set to operate within the same subnet as the radar sensor.

The IP address (e.g. 192.168.0.1) of the radar sensor is preset before leaving Navtech Radar Limited according to client specifications and on the Series 200 & 300 radar will be declared on a label attached to the outer casing.

- The subnet mask of the radar sensor is often preset to 255.255.255.0 but could also be set wider (such as 255.255.0.0) if requested.
- Thus, if the sensor IP address is 192.168.0.1 and the mask is 255.255.255.0, then your computer must use an IP address in the range: 192.168.0.2 to 192.168.0.254

Note: If you are connecting to the radar via an Ethernet switch rather than making a direct link, it is important that no other radar client software is already connected before using radar view.

Connecting your computer

You can connect your computer at any point along the signal link from the radar sensor, either directly into the sensor mounted socket; at the pole mounted enclosure (if the signal link is joined there) or at the far end of the link where it will join the RPU (Radar Processing Unit) system. Note: The sensor can be powered on or off while connecting and disconnecting the network link.

The network controller within the radar sensor is autosensing so that you can use either straight through or crossover cables and it will adjust its operation accordingly.

To connect to your computer

1. Connect a link cable between your computer and the network port, either on the sensor or elsewhere along the signal path.

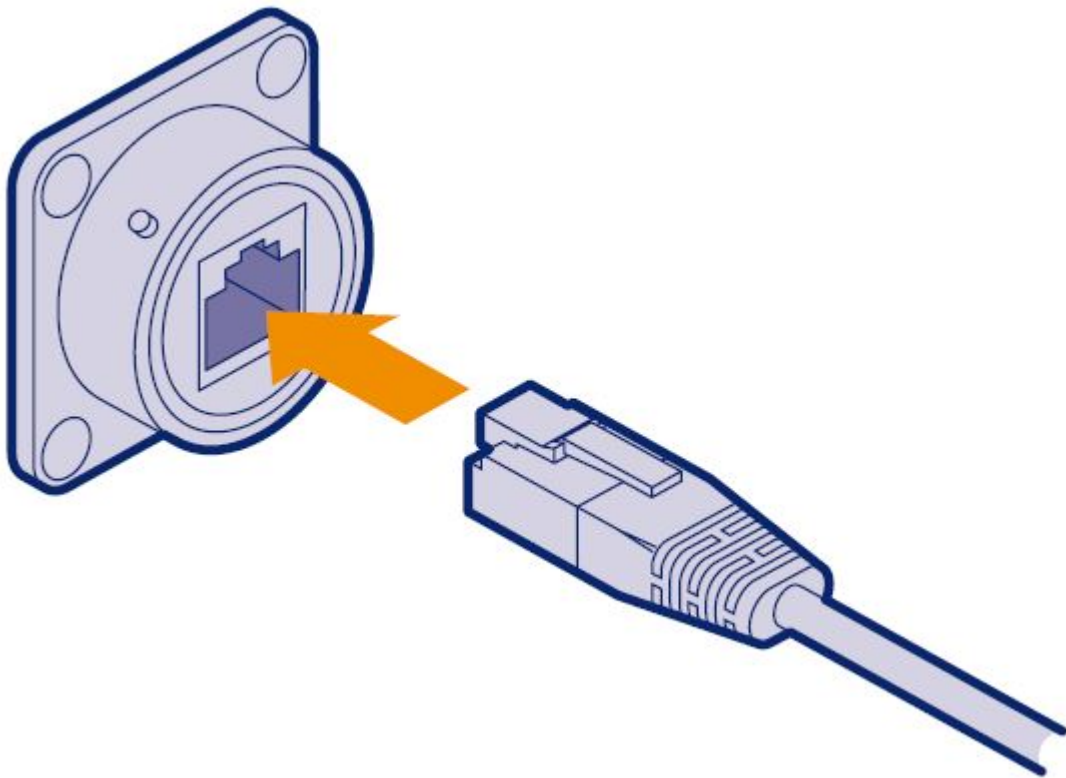

2. Ensure that the radar sensor is powered on and is rotating - you can faintly hear the rotor when it is running.

Testing a sensor

Using the Vertex interface

The HDR radar sensor has a built in web interface (known as Vertex) which provides default user level access to the radar. Vertex allows you to view various operational data as soon as it opens (e.g. IP address, serial number, System Uptime and Radar health, etc.) However, to make any changes you will need to Login.

When first connecting, ensure there is nothing else on the network that is using the same IP address. If necessary, connect a computer directly to the Ethernet port of the radar unit and access Vertex directly in order to change the IP address. For further details:

- See section [Changing the IP address\(es\)](#).
- See the previous sections for details about connecting a computer locally to the radar sensor.

To access the Vertex interface

1. On the computer that is linked to the sensor, open a suitable web browser: Internet Explorer (v10 or above) or Chrome.
2. Type in the address of the sensor in the format `http://192.168.0.1` and press return. This will redirect you to a secure http (https) connection. Accept any security warnings – these are raised because the browser does not recognise the certificate from the radar. To avoid seeing this warning every time you connect, save the IP address of the radar in the secure/trusted sites zone of your browser (although the certificate is regenerated every time the radar reboots). You should now see the Vertex interface opening page:

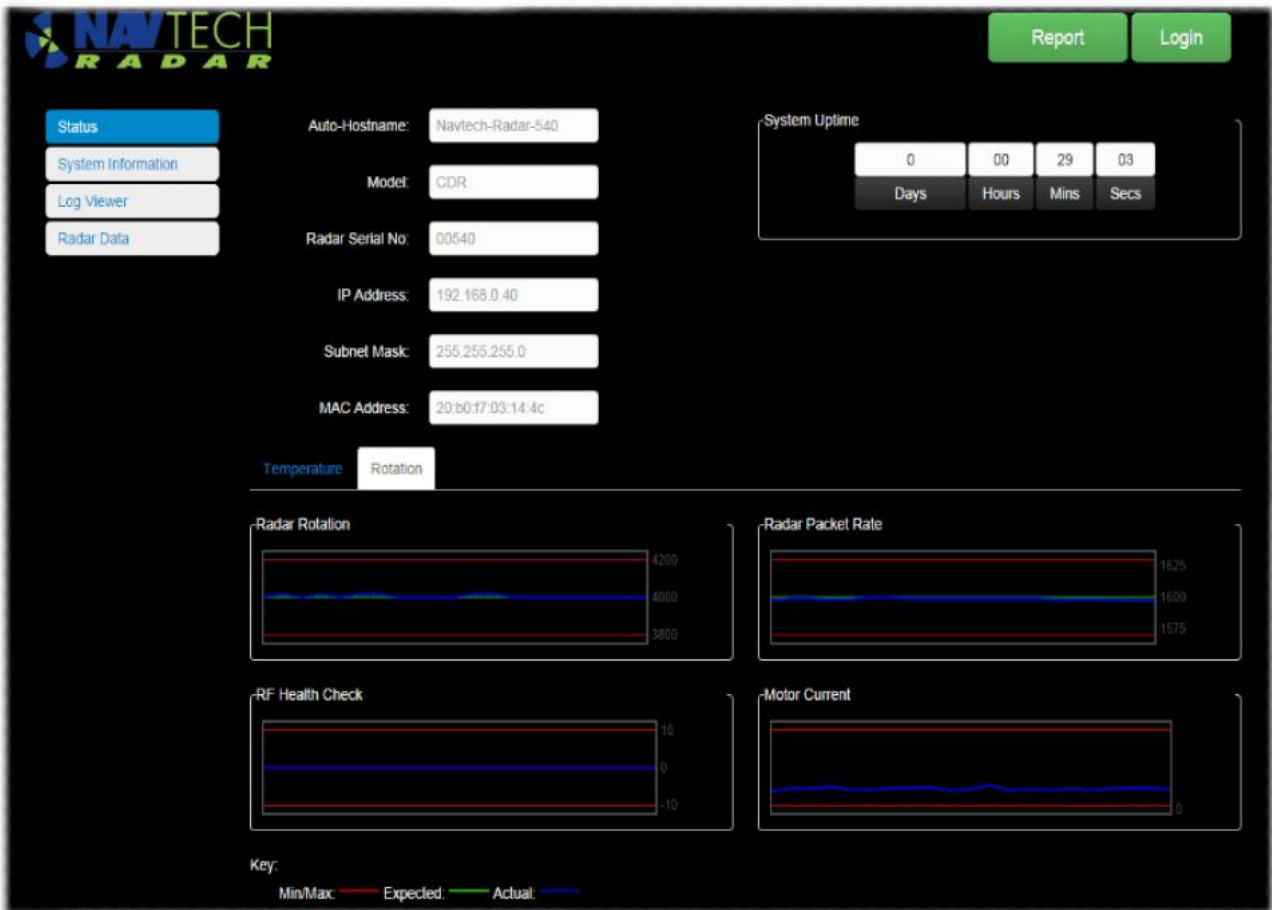

Within the basic view (when not logged in to the sensor), Vertex provides four main pages, accessible from the four buttons in the top left corner:

- **Status** - Displays basic static settings (i.e. auto-hostname, serial number, IP address, etc.) plus dynamic graphs (arranged on two tabs in the lower portion of the page) that provide Temperature and Rotation details. Each graph shows the following about each parameter:
 - **Actual Value (Blue):** Instantaneous value.
 - **Expected Value (Green):** Expected value based on the configuration of the radar.
 - **Min / Max Values (Red):** The min & max allowed values for each metric.
- **System Information** - Provides three pages of detailed settings under the sub headings of System, Radar and Advanced. Click the System Information option to reveal the three sub-headings.
- **Log Viewer** - A full list of all sensor activities. Viewing is possible while not logged-in, however, you must log in if you wish to download the record.
- **Radar Data** - Allows you to view the live radar data.

Two other buttons are shown in green at the top right corner of the page:

- **Report** - Click on this option to display a configuration summary report that details all of the key sensor settings.
- **Login** - Click on this option to login so that changes can be made to the service date.

Using the log viewer

The radar stores a record of activities in order to assist diagnostics. Due to memory restrictions, newer entries will overwrite the oldest and so the log does not retain all historical information.

Enter the number of records that you wish to view and click Go. The requested number of log entries will be displayed with the most recent at the top of the page:

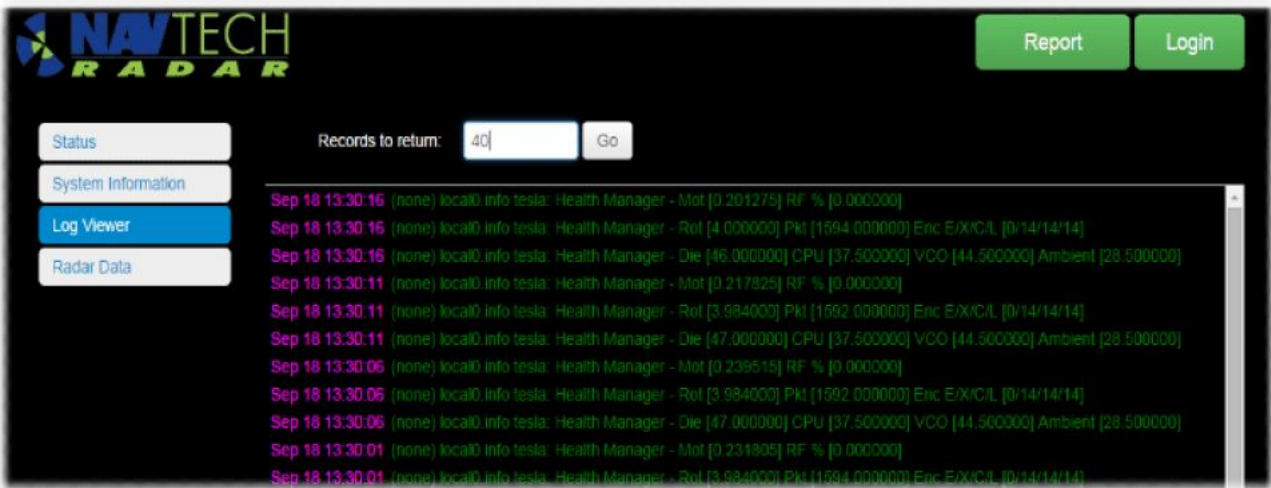

The numbering starts from the latest entry and work backwards in time.

Viewing radar data

Click on the Radar Data button to view live radar data:

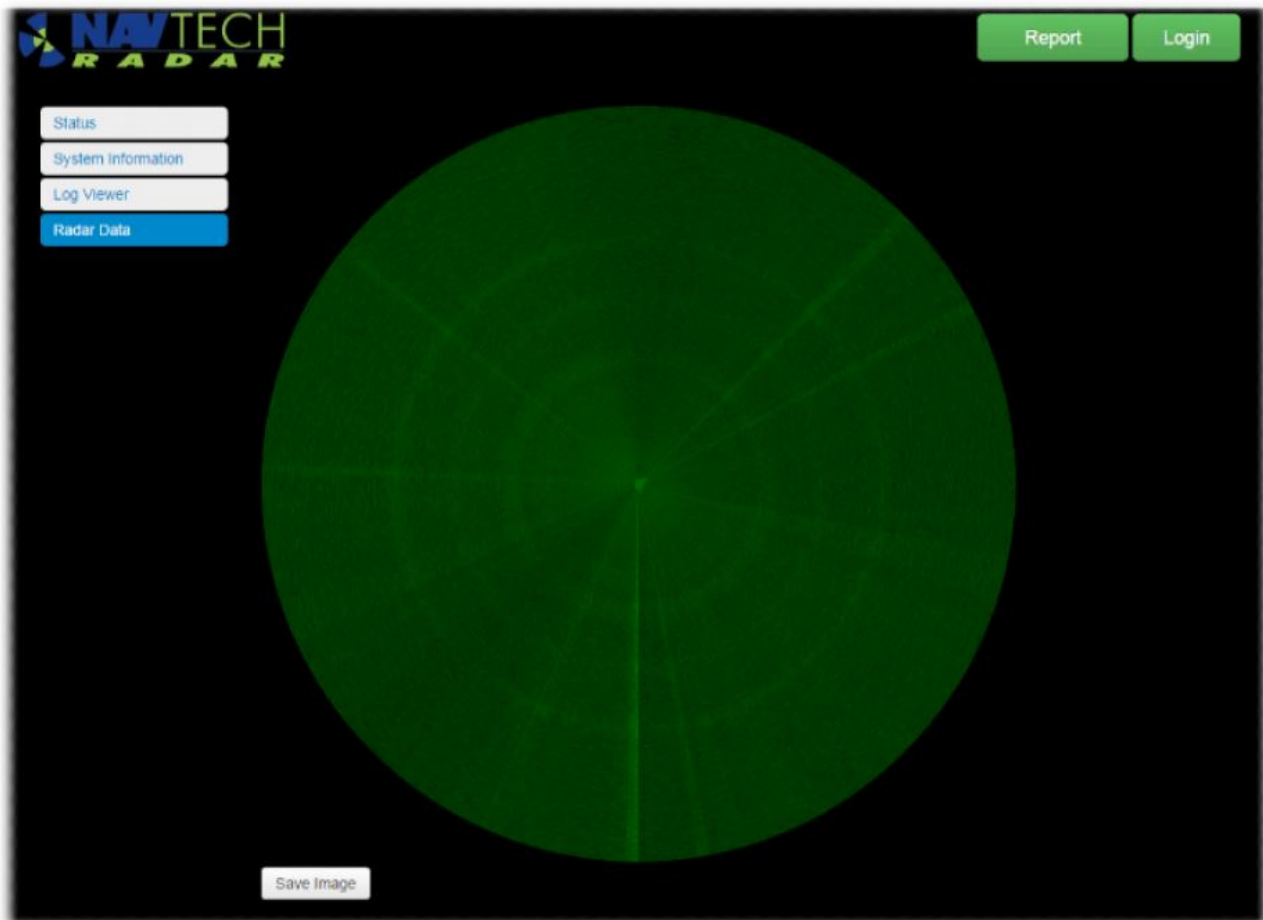

Note: This is a graphically intensive process and update may be slow, depending upon your PC hardware.

Logging in to Vertex

In order to change any radar details, you first need to login to Vertex.

To login

1. Access the Vertex interface as discussed earlier in this section.
2. Click the Login button in the top right hand corner of the screen.
3. Enter the correct Username and Password.
By default these are:
Username: **user** (all lower case)
Password: **Navtech.** (including the capital 'N' and the full stop)
4. Click Login or press Return. This level of access allows basic configuration changes and log downloads.

Changing the IP address(es)

Once you are logged in it is then possible to change various details, such as the radar sensor's own IP address, its Subnet mask, the Gateway IP address and/or the NTP (Network Time Protocol - *where the sensor should derive its time information*) address.

To change IP details

1. Login to Vertex, as described above.
2. Click on the System Configuration button on the left side to display the following page:

3. As required, change the IP Address, Subnet Mask, Gateway and/or NTP Address to suit the installation and then click the blue Apply button in the lower right corner.
4. Click the green Commit Changes button to save the settings to the sensor memory. A message will be displayed when this action has been carried out.
5. Click the red Action button at the top of the page and then click the Reboot option to restart the radar sensor.

Note: If you changed the IP Address, you will need to use the new address to make contact once again with the sensor.



Caution - HDR 100/200/300 Series Power removal

All Navtech HDR Series radars use memory cards for operational functions. These memory devices can suffer corruption if power is removed unexpectedly during key operational stages of use. Users are warned that once power is applied to the unit it should not be removed within the first 2.5 minutes of power on, in order to allow the system to complete its boot cycle. In addition, power to the unit should not be removed during or for 30 seconds after firmware upgrades or configuration changes made from within Vertex.

Next: Levelling a sensor

Levelling a sensor - AdvanceGuard

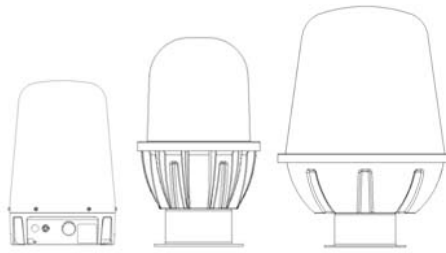

On this page:

- Levelling a sensor
- To adjust the sensor level
- Next: Using SPx Radar/View Lite
- Related information

Levelling a sensor

Due to the very narrow beams (1 or 2 degrees) used by most radar sensors, it is important that each sensor is level in relation to the area that it surveys. Level in this sense may not mean absolutely horizontal. For instance, if the site has a continual slope it may prove beneficial to incline the sensor in line with the slope to ensure that targets are correctly tracked.

The exaggerated examples below show how a sensor with an incorrect incline could miss targets which are lower down the slope:

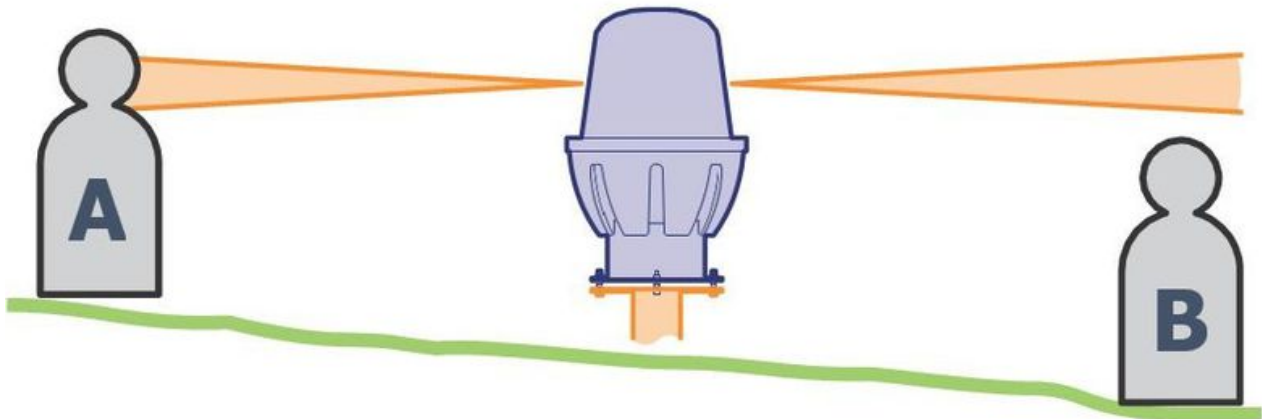

The horizontal radar sensor misses target B.

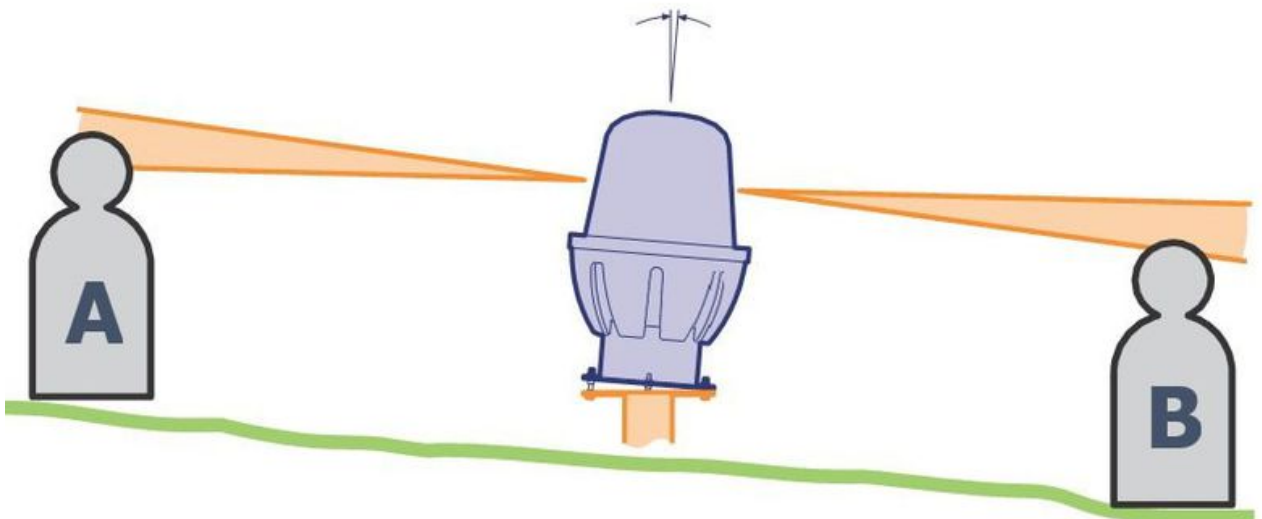

The inclined radar sensor locates both targets.

Note on Camera Mounting

As with the radar, when mounting cameras they should be levelled in relation to the area over which they watch. Their mounting angle should follow the incline of the radar sensor.

To make sensor levelling adjustments

The sensor mounting plate allows for a simple yet effective method to fine tune the incline of the sensor. This helps with the commissioning process and also assists when the radar might need removing from its mount and correctly repositioning to its commissioning alignment again later.

Important: If not correctly followed then issues such as misalignment can occur. Causing unnecessary down time of the radar and a subsequent increase in false alarms or decrease in detection sensitivity for a system. This can lead to a field visit becoming necessary from a Navtech field engineer.

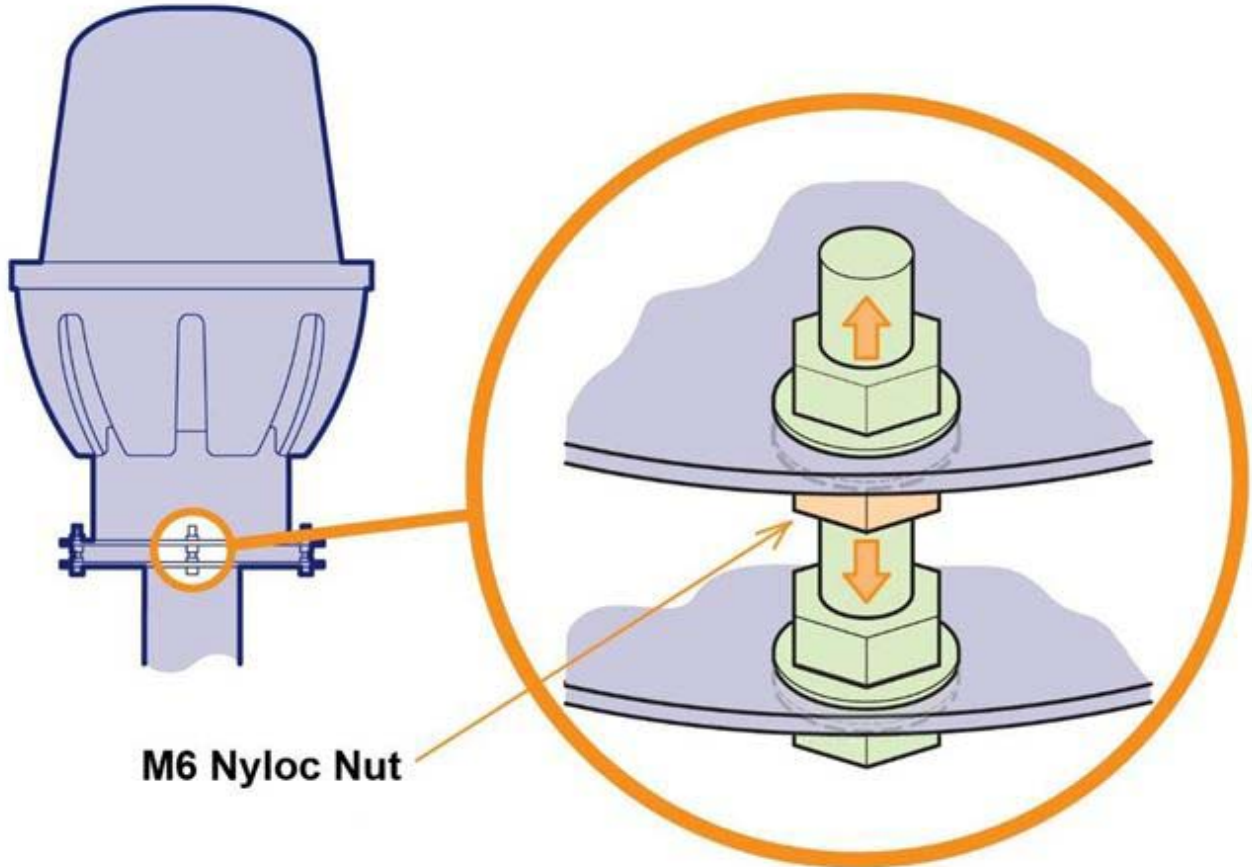

To adjust the sensor level

The recommended procedure to check for the optimum incline is to use two radar targets (Navtech part number MBP0137) mounted on tripods.

- 1 Adjust each target to the same height of 1.3 metres above ground level and locate them on opposite sides of the sensor at the same suitable distance (e.g. 50m +).

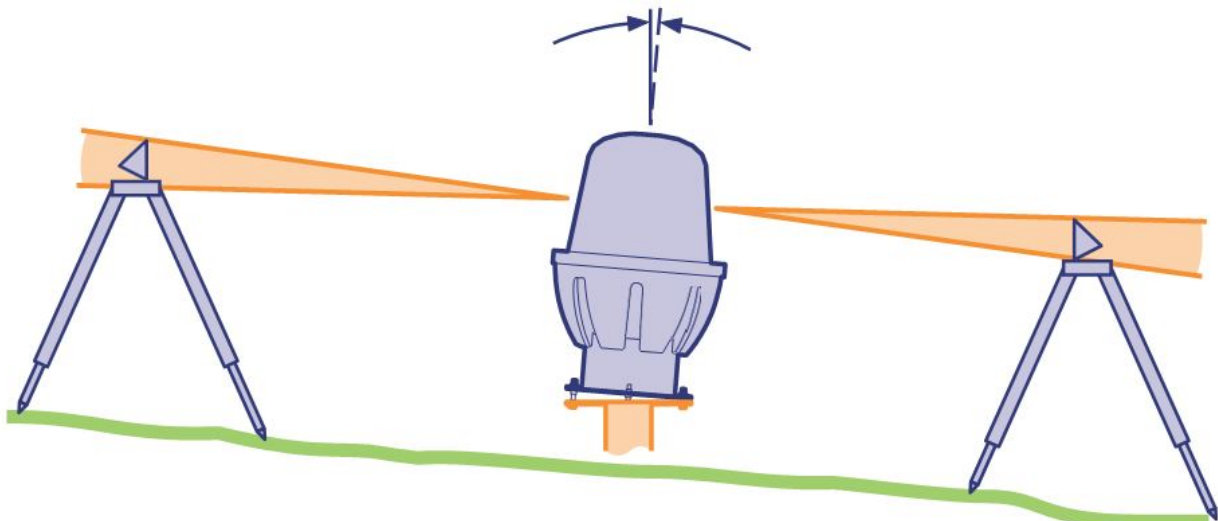

2 Connect a portable computer to the radar sensor and then use the SPx RadarView Lite utility to view the resulting radar scan image:

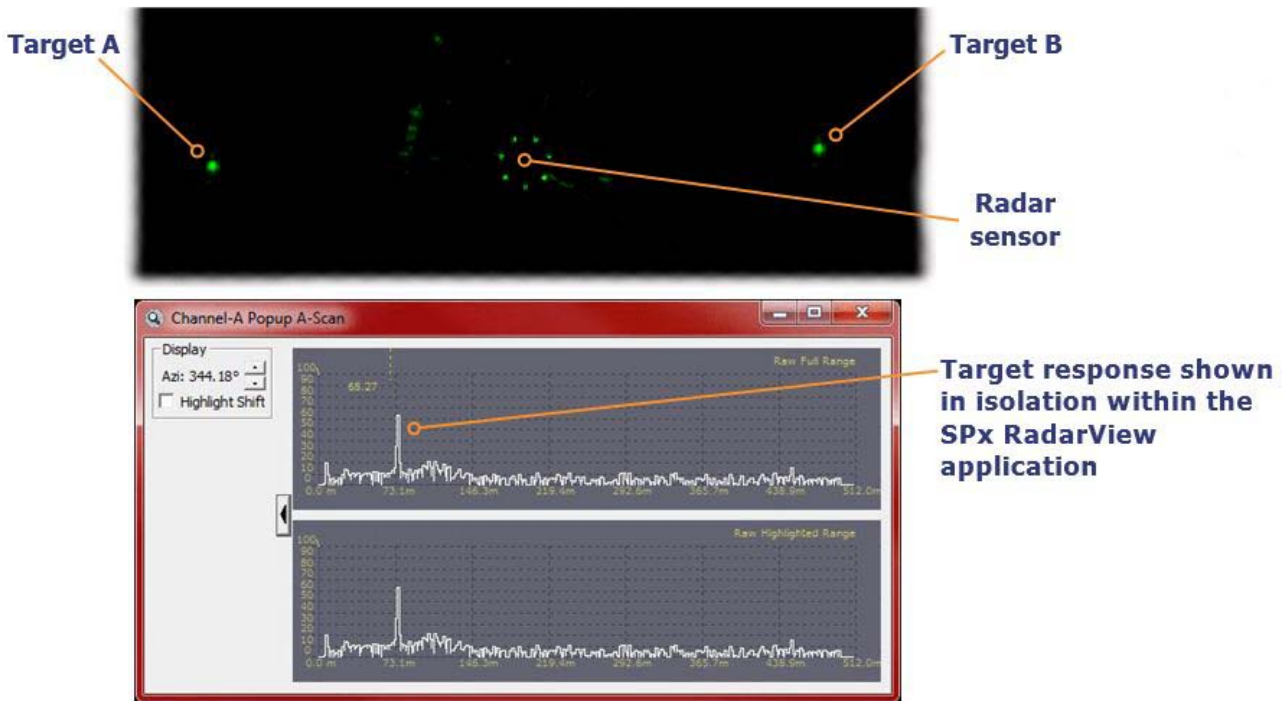

Your aim is to ensure that both targets can be clearly seen by the radar sensor. If necessary, carefully adjust the incline of the sensor until they produce similar traces. It may be necessary at this point to raise or lower the radar in addition to changing the incline.

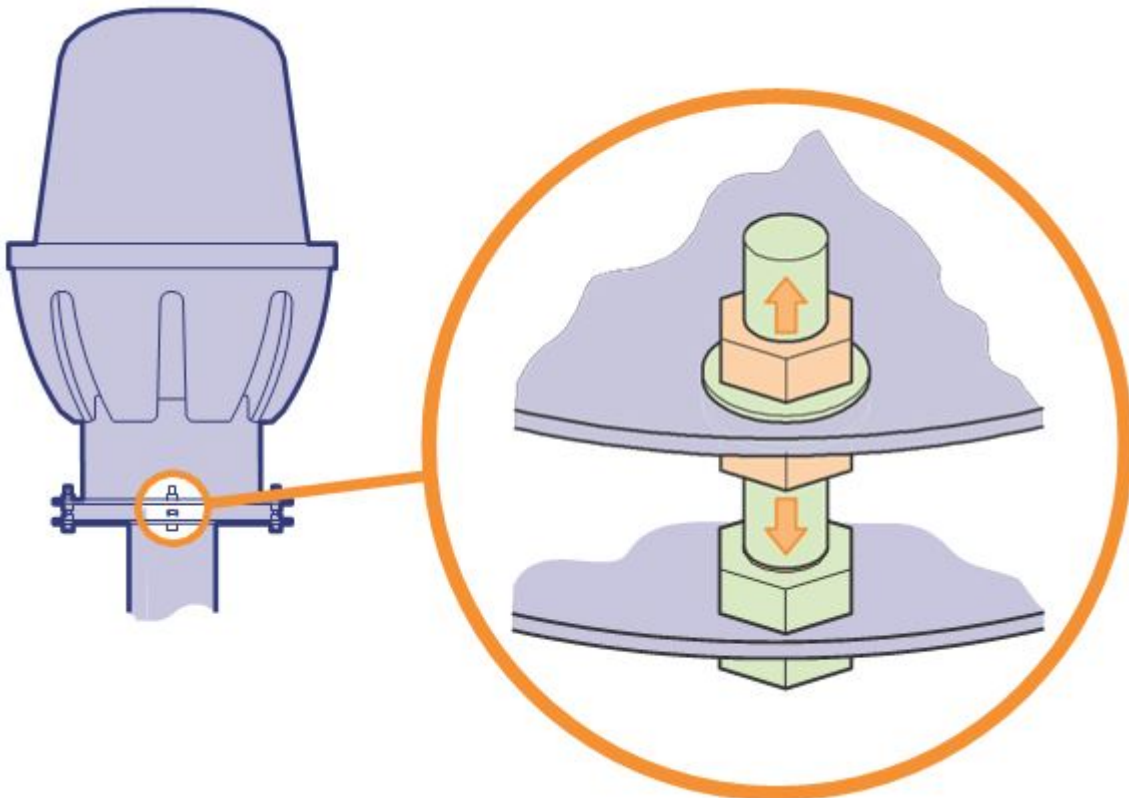

3 Reposition the targets in new locations and repeat the adjustment procedure until targets in various positions can be seen by the radar sensor.

Next: Using SPx RadarView Lite

Related information

Using SPx RadarView Lite - AdvanceGuard

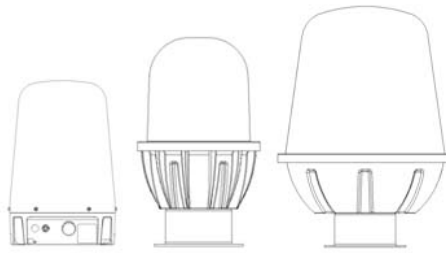

On this page:

- Using SPx RadarView Lite

Using SPx RadarView Lite

The SPx RadarView Lite application can be obtained through contacting Navtech Radar.

This software application consists of two files which must be located in the same folder (any folder) on your computer:

SPXRadarView-Lite.exe and *SPXRadarView Lite <radar model>.cpv* .

Each radar model has a dedicated configuration .cpv file needed for each of the different radar models.

To use SPx RadarView Lite

Run **SPXRadarView-Lite.exe**. You should see a blank main screen.

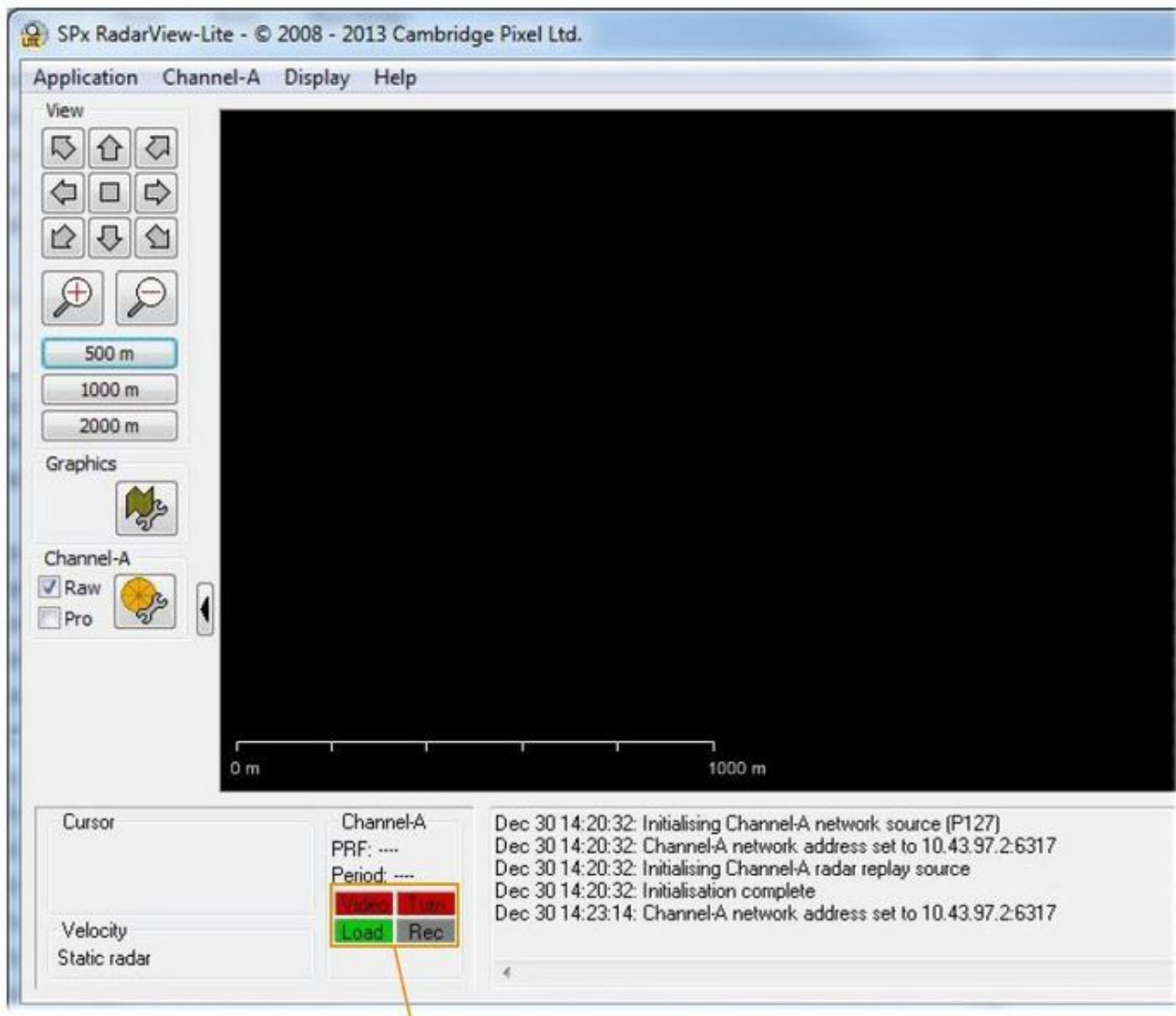

Note: In the lower panel, the Video and Turn indicators will be red to indicate that there is no communication with the sensor.

Click *Channel-A* on the top toolbar and select the **Source...** option.

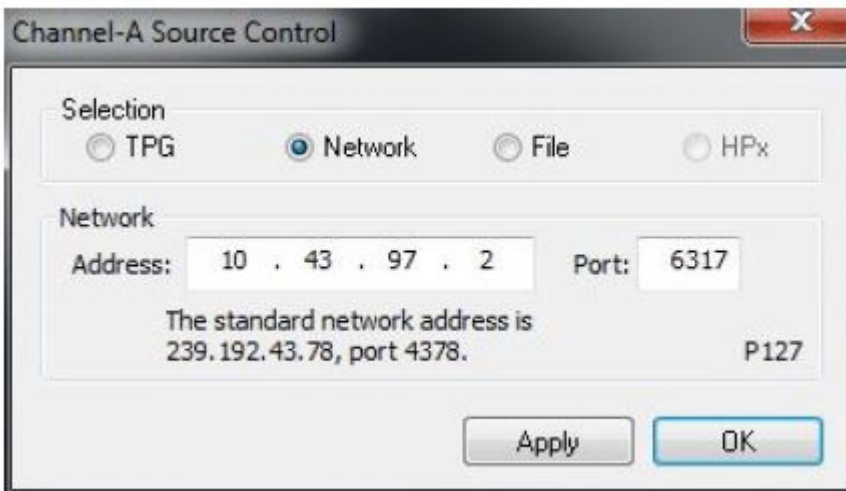

Ensure that the Selection option is set to **Network** and in the section below enter the **IP Address** of the sensor. The **Port** must be set to **6317**. Click **OK**.

Once the IP address and port are correctly set and the application makes contact with the sensor, the Video and Turn indicators should turn green. Shortly afterwards, you should begin to see radar data within the main window:

Note: This operation is graphics intensive and the speed/power of your laptop or PC will have an impact on the display.

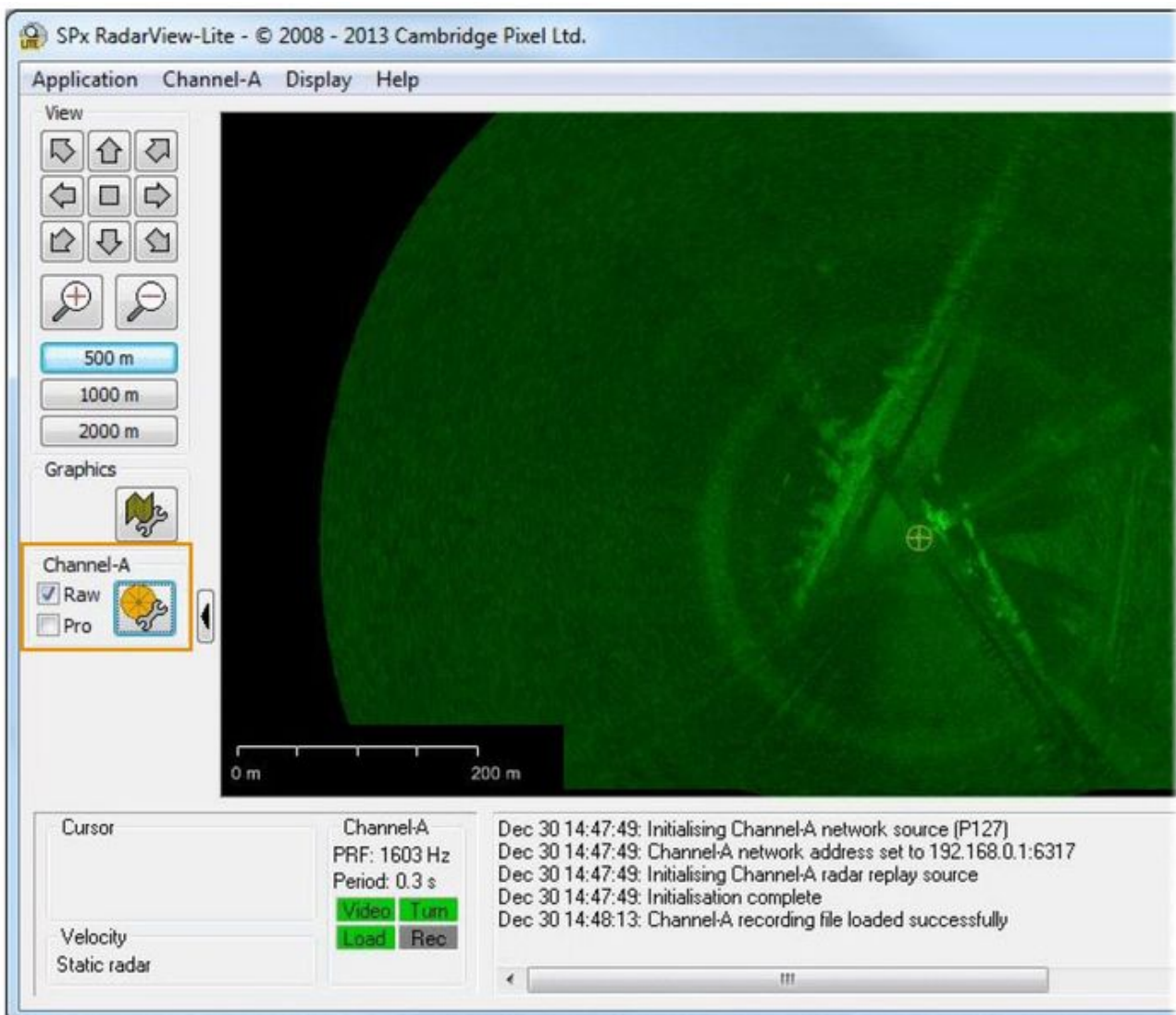

On the left side of the screen ensure the **Raw** option is ticked.



Click the button to show the Display Control dialog box.

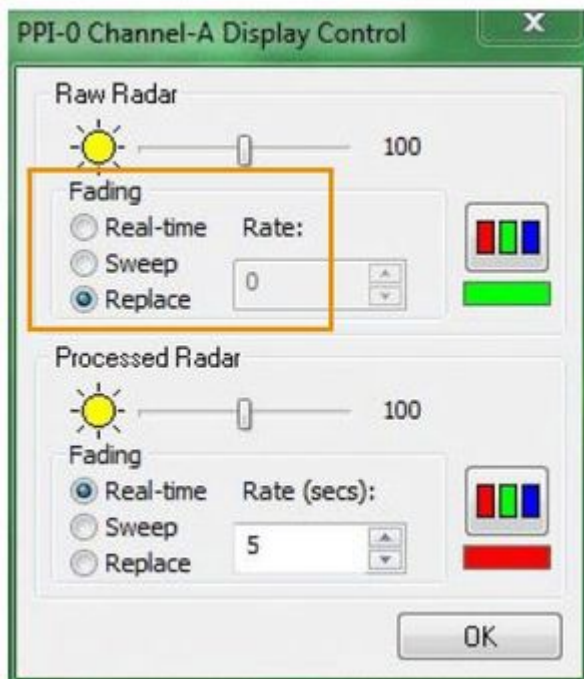

Ensure that in the Raw Radar section the Fading option is set to **Replace**.



Click the button to zoom into the radar view so that you can clearly see both of your test targets.

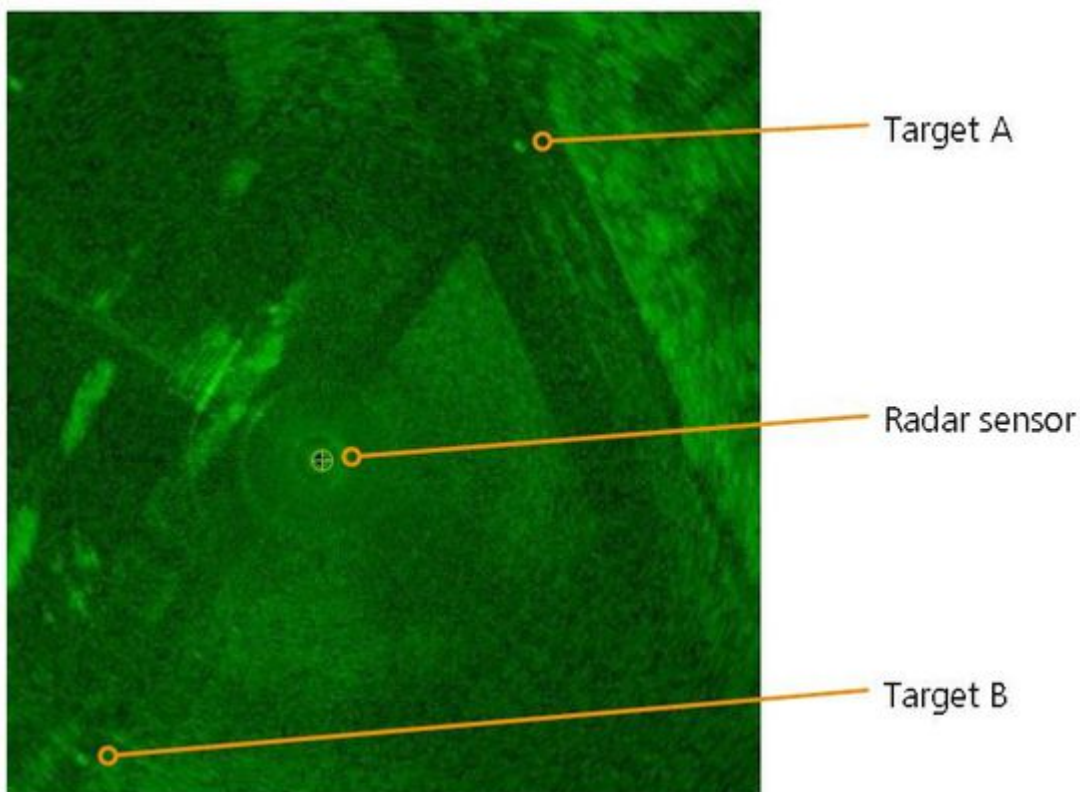

Right click the mouse pointer on the exact middle point of one of the targets to display a popup options box. Click the option **Popup Channel-A, A Scan....** to display a scan window.

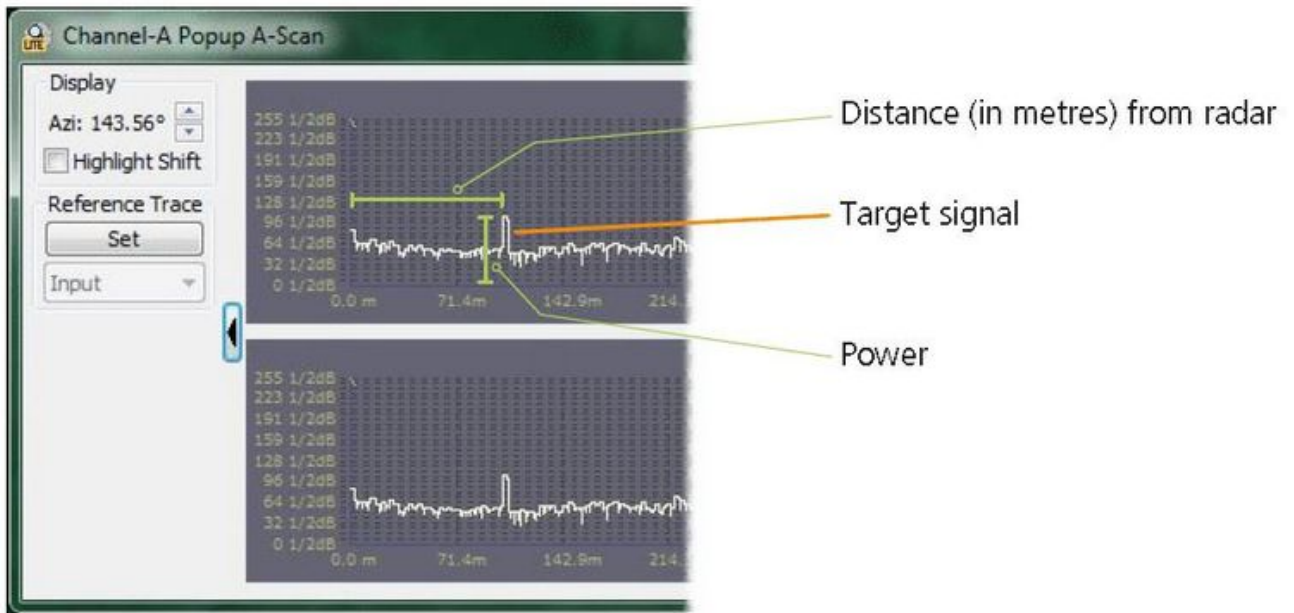

The scan window provides live signal strength data concentrating only on the angular direction of the chosen target from the radar sensor. In each of the two graph plots, the x-axis shows the distance from the sensor while the y-axis indicates the returned signal strength. You should see a spike representing your target at the relevant distance.

Power supply details - AdvanceGuard

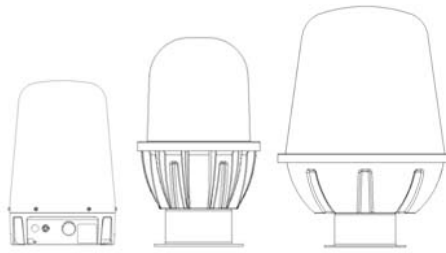

On this page:

- Power Supply Details
- Related information

Power Supply Details

- Siemens Part Number: 6EP1332-1SH52
- 24V Stabilised Power Supply
- Input 100-240V AC
- Output 24V / 4A DC.
- Dimensions: 55mm x 90mm x 90mm
- Will snap to DIN rail EN 60715 35x7.5/15



Related information

FAQ - AdvanceGuard

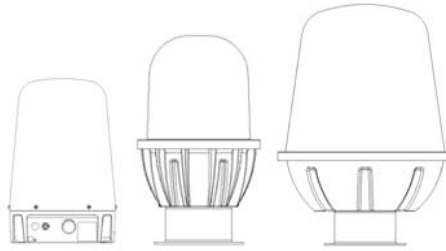

On this page:

- [FAQ](#)
- [Related information](#)

FAQ

What is the power consumption of the radar?

- Up to 25 watts at 24VDC. Please see the data sheet for the exact figure.

What is the network bandwidth usage?

- Up to 25 megabytes per sensor. Please contact Navtech for exact figures for your chosen radar.

What connectivity does the radar support?

- Connection to the radar is via ethernet. Each radar has an RJ45 socket. We recommend cat5 cable to the radar, not to exceed 70m in length. Longer lengths should make use of switches or fibre converters.

What is the ideal mounting height?

- The ideal mounting height can vary depending on the specific site, the type of radar and if the beam is angled. The X units have been designed to be mounted at about 4m, this will give a minimum detection range of about 10m and for a man walking upright, with the maximum according to the sensor data sheet.

What is the beam width?

- The beam width varies per radar sensor. The azimuth beam width is either 1 or 2 degrees with the main elevation beam width of the radars ranging from 3 to 4 degrees. The X radar in addition has a close range infill beam of approximately 25 degrees. Please see the data sheets for clarification.

At what ambient temperatures can the radar operate?

- Please refer to the data sheet for the exact model, but most sensors will operate over -20 to +60 degrees C.

Can the radar be used on the move?

- Not as an intruder detection device, as the radar has to be static in order to be able to detect movement. It can, however, be used as an obstacle detection device to prevent large plant equipment from having collisions.

What is the operating frequency/band width of the radar?

- All radars operate between 76-77GHz. Out of band performance is as per ETSI standard EN 301 091-2 V2.1.1

Does the radar interfere with aviation systems?

- The radar conforms to ETSI standard EN 301 091-2 V2.1.1. Confirmation of compliance with aviation systems is the responsibility of the systems integrator/end user.

Is the radar affected by adverse weather conditions?

- The radar is unaffected by fog, rain, snow etc.

Does Witness provide other interfaces?

- Witness can interface to multiple ethernet relay units, providing multiples of 6 digital inputs and 6 relay outputs. These I/O lines can be linked to various actions/events within Witness.

What cameras does Witness support?

- Witness currently supports a selection of cameras, as detailed in the applicable sales literature. Additional cameras can be added (at cost) if they support absolute positioning.

Related information

HDR 100 Series - Mounting Plate Drawing

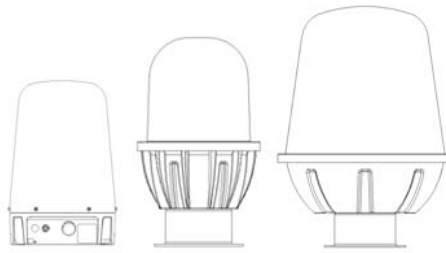

On this page:

- Mounting plate drawing - HDR 100 Series
- Related information

Mounting plate drawing - HDR 100 Series

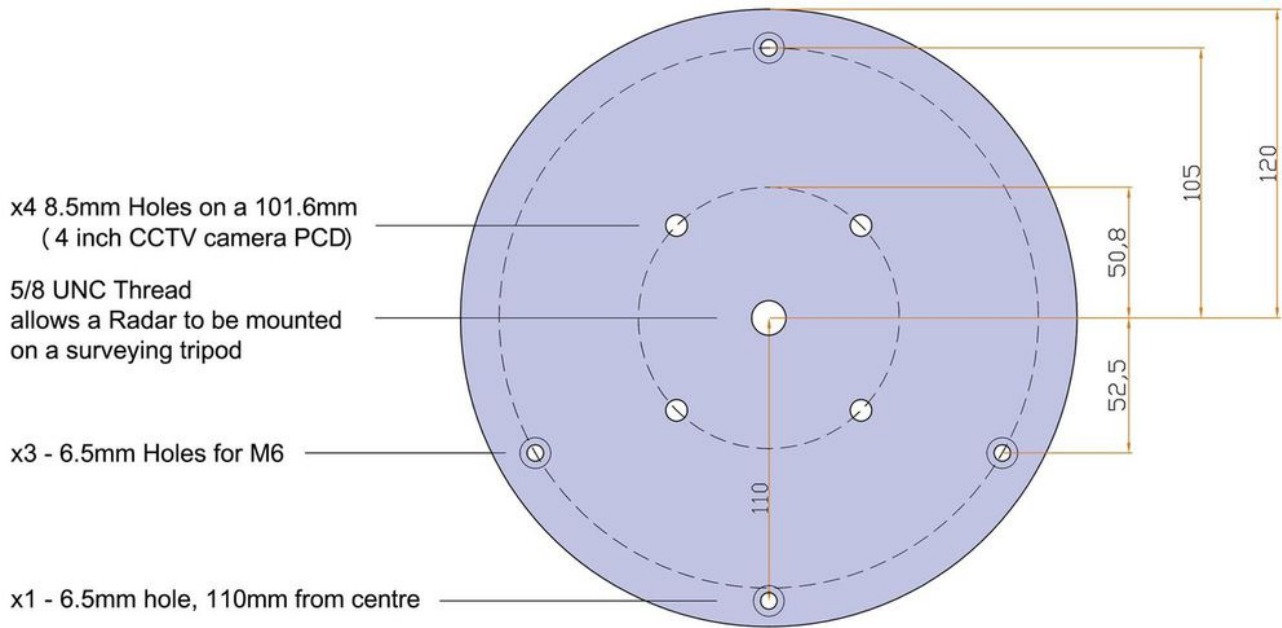

Navtech Part: MBP-0143

Related information

Certification - AdvanceGuard

FCC:

This device complies with Part 15 of the FCC Rules. Operation is subject to the following two conditions: (1) This device may not cause harmful interference, and (2) This device must accept any interference received, including interference that may cause undesired operation.

Operation of this equipment is limited to fixed radar systems used at airport locations for foreign object debris detection on runways and for monitoring aircraft as well as service vehicles on taxiways and other airport vehicle service areas that have no public vehicle access.

This equipment must be mounted in a fixed location maintaining a minimum separation distance from personnel when in general operation, of:

90cm for HDR200 Series Radars

115cm for HDR300 Series Radars

On this page:

- [Related information](#)

Related information