

**ELECTROMAGNETIC EMISSIONS COMPLIANCE REPORT
INTENTIONAL RADIATOR CERTIFICATION TO
FCC PART 15 SUBPART C REQUIREMENT**

OF

Mobile Digital Pen

MODEL No.: XN303I, PEN205I

FCC ID: S7JXN303I

REPORT NO: ES120305012F

ISSUE DATE: March 6, 2012

Prepared for

**SHENZHEN YIFANG DIGITAL TECHNOLOGY CO., LTD.
Building NO.23, Fifth Region, Baiwangxin Industrial Park, Songbai Rd., Nanshan,
Shenzhen, 518108, China**

Prepared by

SHENZHEN EMTEK CO., LTD

**Bldg 69, Majialong Industry Zone, Nanshan District,
Shenzhen, Guangdong, China**

TEL: 86-755-26954280

FAX: 86-755-26954282

VERIFICATION OF COMPLIANCE

Applicant:	SHENZHEN YIFANG DIGITAL TECHNOLOGY CO., LTD. Building NO.23, Fifth Region, Baiwangxin Industrial Park, Songbai Rd., Nanshan, Shenzhen, 518108, China
Product Description:	Mobile Digital Pen
Brand Name:	N/A
Model Number:	XN303I, PEN205I (Note: all the modes have the same PCB, only difference is the appearance and color. We take XN303I for test.)
Serial Number:	N/A
File Number:	ES120305012F
Date of Test:	March 4, 2012 to March 6, 2012

We hereby certify that:

The above equipment was tested by SHENZHEN EMTEK CO., LTD. The test data, data evaluation, test procedures, and equipment configurations shown in this report were made in accordance with the procedures given in ANSI C63.4 (2009) and the energy emitted by the sample EUT tested as described in this report is in compliance with conducted and radiated emission limits of FCC Rules Part 15.247.

The test results of this report relate only to the tested sample identified in this report.

Date of Test : March 4, 2012 to March 6, 2012

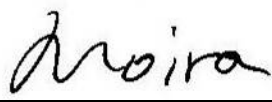
Prepared by : 
(Engineer, Moira)

Reviewer : 
(Quality Manager, June)

Approve & Authorized Signer : 
(Manager, Violet)



Table of Contents

- 1. GENERAL INFORMATION5**
 - 1.1 PRODUCT DESCRIPTION 5
 - 1.2 RELATED SUBMITTAL(S) / GRANT (S) 5
 - 1.3 TEST METHODOLOGY 5
 - 1.4 SPECIAL ACCESSORIES 5
 - 1.5 EQUIPMENT MODIFICATIONS 5
 - 1.6 TEST FACILITY 6
- 2. SYSTEM TEST CONFIGURATION7**
 - 2.1 EUT CONFIGURATION 7
 - 2.2 EUT EXERCISE 7
 - 2.3 TEST PROCEDURE 7
 - 2.4 LIMITATION 7
 - 2.5 CONFIGURATION OF TESTED SYSTEM 10
 - 2.6 EQUIPMENT USED IN TESTED SYSTEM 11
 - 2.7 DESCRIPTION OF TEST MODES..... 12
- 3. SUMMARY OF TEST RESULTS 13**
- 4. CONDUCTED EMISSIONS TEST 14**
 - 4.1 MEASUREMENT PROCEDURE:..... 14
 - 4.2 TEST SET-UP (BLOCK DIAGRAM OF CONFIGURATION)..... 14
 - 4.3 MEASUREMENT EQUIPMENT USED: 14
 - 4.4 CONDUCTED EMISSION LIMIT 14
 - 4.5 MEASUREMENT RESULT: 15
 - 4.6 CONDUCTED MEASUREMENT PHOTOS:..... 16
- 5. RADIATED EMISSION TEST 17**
 - 5.1 MEASUREMENT PROCEDURE..... 17
 - 5.2 TEST SET-UP (BLOCK DIAGRAM OF CONFIGURATION)..... 18
 - 5.3 MEASUREMENT EQUIPMENT USED: 19
 - 5.4 MEASUREMENT RESULT 19
 - 5.5 RADIATED MEASUREMENT PHOTOS:..... 23
- 6. CHANNEL SEPARATION TEST 25**
 - 6.1 MEASUREMENT PROCEDURE..... 25
 - 6.2 TEST SET-UP (BLOCK DIAGRAM OF CONFIGURATION)..... 25
 - 6.3 MEASUREMENT EQUIPMENT USED: 25
 - 6.4 MEASUREMENT RESULTS:..... 25
- 7. BANDWIDTH TEST 28**
 - 7.1 MEASUREMENT PROCEDURE..... 28
 - 7.2 TEST SET-UP (BLOCK DIAGRAM OF CONFIGURATION)..... 28

7.3	MEASUREMENT EQUIPMENT USED:	28
7.4	MEASUREMENT RESULTS:.....	28
8.	QUANTITY OF HOPPING CHANNEL TEST.....	31
8.1	MEASUREMENT PROCEDURE.....	31
8.2	TEST SET-UP (BLOCK DIAGRAM OF CONFIGURATION).....	31
8.3	MEASUREMENT EQUIPMENT USED:	31
8.4	MEASUREMENT RESULTS:.....	31
9.	TIME OF OCCUPANCY (DWELL TIME) TEST	32
9.1	MEASUREMENT PROCEDURE.....	32
9.2	TEST SET-UP (BLOCK DIAGRAM OF CONFIGURATION).....	32
9.3	MEASUREMENT EQUIPMENT USED:	32
9.4	MEASUREMENT RESULTS:.....	32
10.	MAXIMUM PEAK OUTPUT POWER TEST	33
10.1	MEASUREMENT PROCEDURE.....	35
10.2	TEST SET-UP (BLOCK DIAGRAM OF CONFIGURATION).....	35
10.3	MEASUREMENT EQUIPMENT USED:	35
10.4	MEASUREMENT RESULTS:.....	35
11.	BAND EDGE TEST	36
11.1	MEASUREMENT PROCEDURE.....	36
11.2	TEST SET-UP (BLOCK DIAGRAM OF CONFIGURATION).....	36
11.3	MEASUREMENT EQUIPMENT USED:	36
11.4	MEASUREMENT RESULTS:.....	36
12.	ANTENNA PORT EMISSION.....	37
12.1	TEST EQUIPMENT	37
12.2	MEASURING INSTRUMENTS AND SETTING	37
12.3	TEST PROCEDURES	37
12.4	BLOCK DIAGRAM OF TEST SETUP	37
12.5	TEST RESULT	37
13.	ANTENNA APPLICATION.....	39
13.1	ANTENNA REQUIREMENT	39
13.2	RESULT	39

1. GENERAL INFORMATION

1.1 Product Description

The SHENZHEN YIFANG DIGITAL TECHNOLOGY CO., LTD.

Model: XN303I(referred to as the EUT in this report) The EUT is an short range, lower power Device. It is designed by way of utilizing the GFSK, $\pi/4$ -DQPSK, 8-DPSK modulation achieves the system operating.

A major technical descriptions of EUT is described as following:

- A). Operation Frequency: 2402-2480MHz
- B). Modulation: GFSK, $\pi/4$ -DQPSK, 8-DPSK
(All the modulation modes were tested and the data of the worst mode (GFSK) are attached within report.)
- C). Number of Channel: 79
- D). Channel space: 1MHz
- E). RF Output Power:-1.89dBm
- F). BIT Rate of Transmission: 1Mbps, 2Mbps, 3Mbps
- G). Antenna Type: PCB antenna
- H). Antenna GAIN: 0dBi
- I). Power Supply: DC 3.7V from Li-ion Battery or DC 5V from PC

1.2 Related Submittal(s) / Grant (s)

This submittal(s) (test report) is intended for FCC ID: S7JXN303I filing to comply with Section 15.247 of the FCC Part 15, Subpart C Rules. The composite system (receiver) is compliance with Subpart B is authorized under a DoC procedure.

1.3 Test Methodology

Both conducted and radiated testing were performed according to the procedures in ANSI C63.4 (2009) and FCC Public Notice DA 00-705. Radiated testing was performed at an antenna to EUT distance 3 meters.

1.4 Special Accessories

Not available for this EUT intended for grant.

1.5 Equipment Modifications

Not available for this EUT intended for grant.

1.6 Test Facility

Site Description
EMC Lab. : Accredited by CNAS, 2010.10.29
The certificate is valid until 2013.10.28
The Laboratory has been assessed and proved to be in compliance
with CNAS/CL01:2006(identical to ISO/IEC17025: 2005)
The Certificate Registration Number is L2291

Accredited by TUV Rheinland Shenzhen 2010.5.25
The Laboratory has been assessed according to the requirements
ISO/IEC 17025

Accredited by FCC, October 28, 2010
The Certificate Registration Number is 406365.

Accredited by Industry Canada, March 5, 2010
The Certificate Registration Number is 46405-4480.

Name of Firm : SHENZHEN EMTEK CO., LTD
Site Location : Bldg 69, Majialong Industry Zone,
Nanshan District, Shenzhen, Guangdong, China

2. System Test Configuration

2.1 EUT Configuration

The EUT configuration for testing is installed on RF field strength measurement to meet the Commissions requirement and operating in a manner which intends to maximize its emission characteristics in a continuous normal application.

2.2 EUT Exercise

The Transmitter was operated in the normal operating mode. The Tx frequency was fixed which was for the purpose of the measurements.

2.3 Test Procedure

2.3.1 Conducted Emissions

The EUT is a placed on as turn table which is 0.8 m above ground plane. According to the requirements in Section 13.1.4.1 of ANSI C63.4-2009. and RSS GEN Conducted emissions from the EUT measured in the **frequency range between 0.15 MHz and 30MHz** using **CISPR Quasi-Peak and average detector mode**.

2.3.2 Radiated Emissions

The EUT is a placed on as turn table which is 0.8 m above ground plane. The turn table shall rotate 360 degrees to determine the position of maximum emission level. EUT is set 3m away from the receiving antenna which varied from 1m to 4m to find out the highest emission. And also, each emission was to be maximized by changing the polarization of receiving antenna both horizontal and vertical. In order to find out the max. emission, the relative positions of this hand-held transmitter(EUT) was rotated through three orthogonal axes according to the requirements in Section 13.1.4.1 of ANSI C63.4-2009 and RSS GEN.

2.4 Limitation

(1) Channel Separation test

FCC Part 15, Subpart C Section 12.247(a)(1) Frequency hopping systems shall have hopping channel carrier frequencies separated by a minimum of 25kHz or the 20 Bandwidth of the hopping channel, whichever is greater.

Frequency Range (MHz)	Limit(kHz)
902-928	>25kHz
2400-2483.5	>25kHz
5725-5850	>25kHz

(2) **20dB Bandwidth**

Frequency Range(MHz)	Quantity of Hopping Channel	Limit(kHz)			
		50	25	15	75
902-928		<250	>250	NA	NA
2400-2483.5		NA	NA	>1000	<1000

(3) **Quantity of Hopping Channel**

FCC Part 15, Subpart C Section 12.247

Frequency Range (MHz)	Limit(Quantity of Hopping Channel)			
	20dB bandwidth <250kHz	20dB bandwidth >250kHz	20dB bandwidth <1MHz	20dB bandwidth >1MHz
902-928	50	25	NA	NA
2400-2483.5	NA	NA	75	15
5725-5850	NA	NA	75	NA

(4) **Time of Occupancy(Dwell Time)**

FCC Part 15, Subpart C Section 12.247

Frequency Range (MHz)	LIMIT(rms)		
	20dB bandwidth <250kHz(50Channel)	20dB bandwidth >250kHz(25Channel)	20dB bandwidth <1MHz(75Channel)
902-928	400(20S)	400(10S)	NA
2400-2483.5	NA	NA	400(30S)
5725-5850	NA	NA	400(30S)

Note: The “()” is all channel’s average time of occupancy.

(5) **Maximum Peak Output Power**

FCC Part 15, Subpart C Section 12.247

Frequency Range (MHz)	Quantity of Hopping Channel	LIMIT(W)			
		50	25	15	75
902-928		1(30dBm)	0.125(21dBm)	NA	NA
2400-2483.5		NA	NA	0.125(21dBm)	1(30dBm)
5725-5850		NA	NA	NA	1(30dBm)

(6) Band edge

FCC Part15, Subpart C Section 15.247, In any 100kHz bandwidth outside the frequency band in with the spread spectrum intentional radiator is operating, the radio frequency power that is produced by the intentional radiator shall be at least 20dB below that in the 100kHz bandwidth within the band that contains the highest level of the desired power, based on either an RF conducted or a radiated measurement, attenuation below the general limits specified in section 15.209(a) is not required. In addition, radiated emissions which fall in the restricted bands, as defined in section 15.205(a), must also comply with the radiated emission limits specified in section 15.209(a).

Operating Frequency Range(MHz)	Spurious emission frequency	Limit	
		Peak power ration to emission(dBc)	Emission level(dBuV/m)
902-928	<902	>20	NA
	>928	>20	NA
	960-1240	NA	54
2400-2483.5	<2400	>20	NA
	>2483.5-2500	NA	54
5725-5850	<5350-5460	NA	54
	<5725	>20	NA
	>5850	>20	NA

(7) Conducted Emission

Frequency(MHz)	Quasi-peak	Average
0.15-0.5	66-56	56-46
0.5-5.0	56	46
5.0-30.0	60	50

Note:

1. The lower limit shall apply at the transition frequencies
2. The limit decreases in line with the logarithm of the frequency in the range of 0.15 to 0.50MHz.

(8) Radiated Emission

FCC Part 15, Subpart C Section 15.209 limit of radiated emission for frequency below 1000GHz. The emissions from an intentional radiator shall not exceed the field strength level specified in the following table:

Frequency (MHz)	Field strength $\mu\text{V/m}$	Distance(m)	Field strength at 3m $\text{dB}\mu\text{V/m}$
0.009~0.490	2400/F(KHz)	300	See the remark
0.490~1.705	2400/F(KHz)	30	
1.705~30.0	30	30	
30-88	100	3	40
88-216	150	3	43.5
216-960	200	3	46
Above 960	500	3	54

- Remark: 1. Emission level in $\text{dB}\mu\text{V/m}=20 \log (\text{uV/m})$
2. Measurement was performed at an antenna to the closed point of EUT distance of meters.
3. Distance extrapolation factor $=40\log(\text{Specific distance/ test distance})(\text{dB})$;
Limit line= $\text{Specific limits}(\text{dB}\mu\text{V}) + \text{distance extrapolation factor}$.

2.5 Configuration of Tested System

Fig. 2-1 Configuration of Tested System

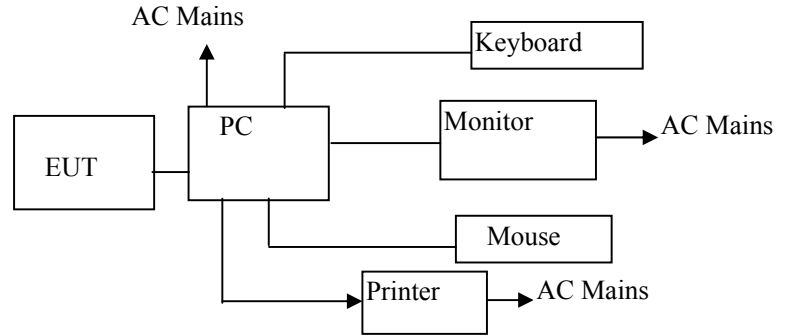

2.6 Equipment Used in Tested System

PC	:	Manufacturer: LENOVO M/N: 9702 S/N: L3C4410 CE, FCC: DOC Power cord : Unshielded, Detachabled, 1.5m
LCD Monitor	:	Manufacturer: LENOVO M/N: 9227-AE6 S/N:4M0293084302824 CE, FCC: DOC Power cord : Unshielded, Detachabled, 1.5m Data Cable: Unshielded, Undetachabled, 2.0m
Keyboard	:	Manufacturer: LENOVO M/N: KU-0225 S/N:0585494 CE, FCC: DOC Data Cable: Unshielded, Undetachabled, 2.0m
Mouse	:	Manufacturer: LENOVO M/N: MO28UOL S/N:44G7862 068 CE, FCC: DOC Data Cable: Unshielded, Undetachabled, 2.0m
Printer	:	Manufacturer: HP M/N: C89520 S/N: CN25S182N6 CE, FCC: DOC USB Cable : Unshielded, Detachabled, 1.8m Power cord :Unshielded, Detachabled, 1.8m

Note:

- (1) Unless otherwise denoted as EUT in 『Remark』 column , device(s) used in tested system is a support equipment.

2.7 Description of test modes

This EUT is a FHSS system. Pre-scanned tests, X, Y, Z in the three orthogonal panels, were conducted to determine the final configuration from all possible combinations. We use blue test to control the EUT, Let EUT hopping on and transmit with highest power, and the worst result was reported with modulation GFSK. 79 Channels are provided by EUT. The 3 channels of lower, medium and higher were chosen for test.

Channel	Frequency(MHz)
1	2402
40	2441
79	2480

3. Summary of Test Results

FCC Rule	Description Of Test	Result
15.247(a)(1)	Channel Separation test	Compliant
15.247(a)(1)	20dB Bandwidth	Compliant
15.247(a)(1)	Quantity of Hopping Channel	Compliant
15.247(a)(1)	Time of Occupancy (Dwell Time)	Compliant
15.247(b)(1)	Max Peak output Power test	Compliant
15.247(d)	Band edge test	Compliant
15.207	AC Power Conducted Emission	Compliant
15.247(d)	Radiated Emission	Compliant
§15.247(d)	Antenna Port Emission	Compliant
15.203&15.247(b)	Antenna Application	Compliant

4. Conducted Emissions Test

4.1 Measurement Procedure:

1. The EUT was placed on a table which is 0.8m above ground plane.
2. Maximum procedure was performed on the six highest emissions to ensure EUT compliance.
3. Repeat above procedures until all frequency measured were complete.

4.2 Test SET-UP (Block Diagram of Configuration)

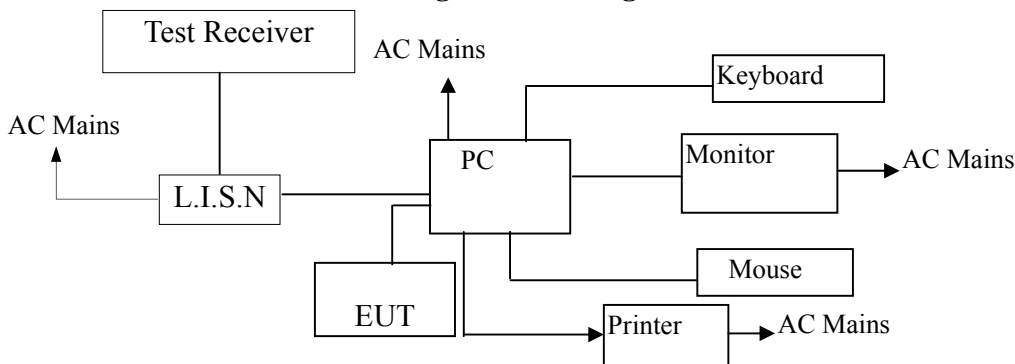

4.3 Measurement Equipment Used:

Conducted Emission Test Site # 4					
EQUIPMENT TYPE	MFR	MODEL NUMBER	SERIAL NUMBER	LAST CAL.	CAL DUE.
Test Receiver	Rohde & Schwarz	ESCS30	828985/018	05/29/2011	05/29/2012
L.I.S.N	Rohde & Schwarz	ESH2-Z5	834549/005	05/29/2011	05/29/2012
L.I.S.N	Rohde & Schwarz	ESH2-Z5	834549/005	05/29/2011	05/29/2012
50ΩCoaxial Switch	Anritsu	MP59B	M20531	005/29/2011	05/29/2012

4.4 Conducted Emission Limit

(7) Conducted Emission

Frequency(MHz)	Quasi-peak	Average
0.15-0.5	66-56	56-46
0.5-5.0	56	46
5.0-30.0	60	50

Note:

1. The lower limit shall apply at the transition frequencies
2. The limit decreases in line with the logarithm of the frequency in the range of 0.15 to 0.50MHz.

4.5 Measurement Result:

Date of Test: March 4, 2012 Temperature: 22°C
 Frequency Detector: 0.15~30MHz Humidity: 50%
 Test Result: PASS Test Mode: Bluetooth Mode

Test Line	Frequency MHz	Emission Level QP dB(μV)	Emission Level AV dB(μV)	Limits QP dB(μV)	Limits AV dB(μV)	Margin QP dB(μV)	Margin AV dB(μV)
Neutral	0.15	39.13	28.06	66	56	-26.87	-27.94
	0.205	33.82	26.11	63.41	53.41	-29.59	-27.3
	0.275	31.84	23.97	60.97	50.97	-29.13	-27
	0.825	32.25	29.45	56	46	-23.75	-16.55
	1.94	29.92	28.65	56	46	-26.08	-17.35
	15.1	37.14	31.86	60	50	-22.86	-18.14
Line	0.205	34.82	26.11	63.41	53.41	-28.59	-27.3
	0.275	32.75	23.97	60.97	50.97	-28.22	-27
	0.345	27.52	19.93	59.08	49.08	-31.56	-29.15
	0.825	30.75	29.45	56	46	-25.25	-16.55
	1.94	30.42	28.65	56	46	-25.58	-17.35
	15.1	37.14	31.86	60	50	-22.86	-18.14

4.6 Conducted Measurement Photos:



5. Radiated Emission Test

5.1 Measurement Procedure

1. The EUT was placed on a turn table which is 0.8m above ground plane.
2. Maximum procedure was performed on the six highest emissions to ensure EUT compliance.
3. And also, each emission was to be maximized by changing the polarization of receiving antenna both horizontal and vertical.
4. Repeat above procedures until all frequency measured were complete.

When spectrum scanned from 30 MHz to 1GHz setting resolution bandwidth 100 kHz and video bandwidth 300kHz. And spectrum scanned above 1GHz setting resolution bandwidth 1MHz, video bandwidth 3MHz.

5.2 Test SET-UP (Block Diagram of Configuration)

(A) Radiated Emission Test Set-Up, Frequency Below 30MHz

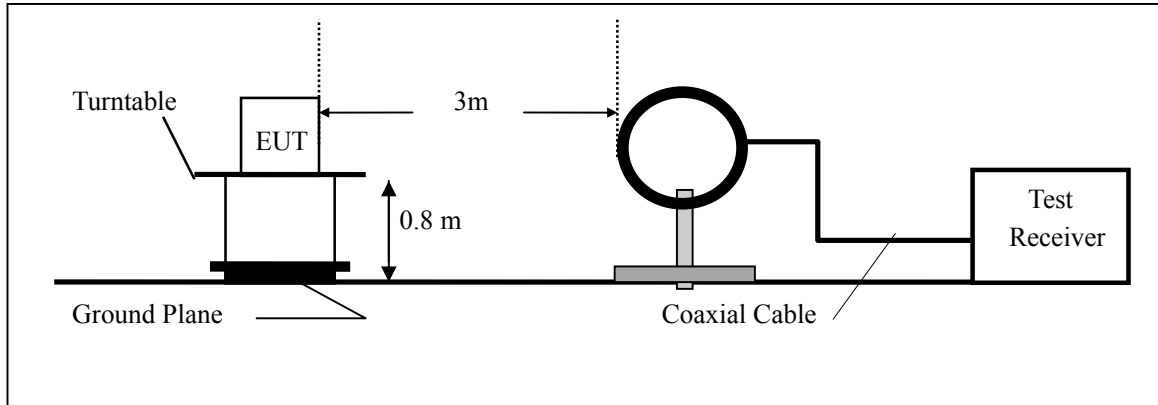

(B) Radiated Emission Test Set-Up, Frequency Below 1000MHz

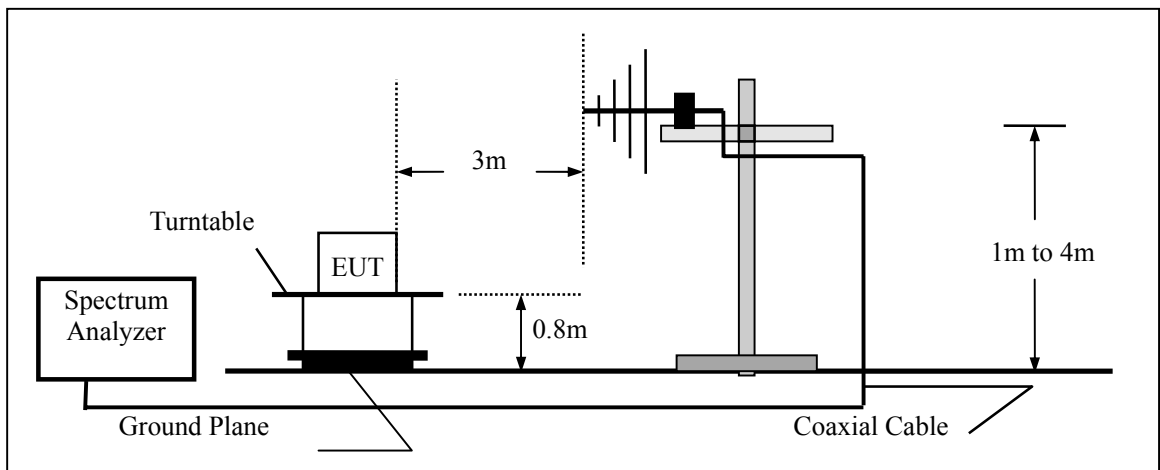

(C) Radiated Emission Test Set-Up, Frequency above 1000MHz

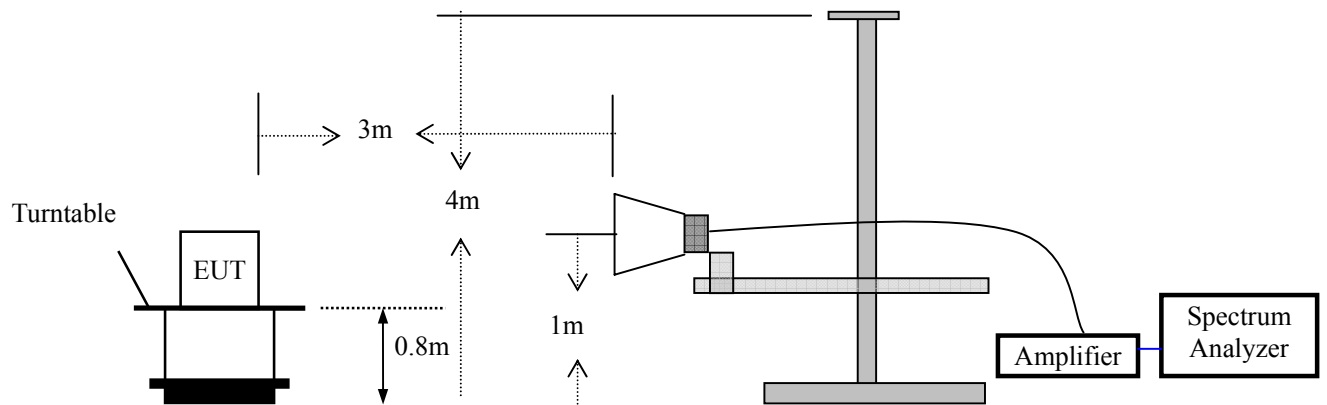

5.3 Measurement Equipment Used:

EQUIPMENT TYPE	MFR	MODEL NUMBER	SERIAL NUMBER	LAST CAL.	CAL DUE.
Spectrum Analyzer	Rohde & Schwarz	FSP7	839511/010	05/29/2011	05/29/2012
Spectrum Analyzer	HP	E4407B	839840481	05/29/2011	05/29/2012
EMI Test Receiver	Rohde & Schwarz	ESCS30	828985/018	05/29/2011	05/29/2012
Pre-Amplifier	HP	8447D	2944A07999	05/29/2011	05/29/2012
Bilog Antenna	Schwarzbeck	VULB9163	142	05/29/2011	05/29/2012
Loop Antenna	ARA	PLA-1030/B	1029	05/29/2011	05/29/2012
Horn Antenna	Electro-Metrics	EM-6961	103314	05/29/2011	05/29/2012
Horn Antenna	Schwarzbeck	BBHA 9120	D143	05/29/2011	05/29/2012

5.4 Measurement Result

Operation Mode: Bluetooth Mode Test Date : 03/05/2012
 Frequency Range: 9KHz~30MHz Temperature : 28°C
 Test Result: PASS Humidity : 65 %
 Measured Distance: 3m Test By: WOLF

Freq. (MHz)	Ant.Pol. H/V	Emission Level (dBuV/m)	Limit 3m (dBuV/m)	Over (dB)
--	--	--	--	--

Note: the amplitude of spurious emission that is attenuated by more than 20dB below the permissible limit has no need to be reported.

Operation Mode: 2402MHz Test Date : 03/05/2012
 Frequency Range: 30~1000MHz Temperature : 28 °C
 Test Result: PASS Humidity : 65 %
 Measured Distance: 3m Test By: KL

Freq. (MHz)	Ant.Pol. H/V	Emission Level (dBuV)	Limit 3m (dBuV/m)	Margin (dB)	Note
104.40	V	37.38	43.50	-6.12	PK
127.93	V	29.83	43.50	-13.67	PK
176.12	V	35.16	43.50	-8.34	PK
239.85	V	29.61	46.00	-16.39	PK
336.23	V	38.52	46.00	-7.48	PK
432.61	V	40.04	46.00	-5.96	PK
104.61	H	37.48	43.50	-6.02	PK
239.85	H	35.60	46.00	-10.40	PK
336.23	H	43.90	46.00	-2.10	PK
432.61	H	43.18	46.00	-2.82	PK
734.18	H	41.96	46.00	-4.04	PK
801.02	H	39.75	46.00	-6.25	PK

Operation Mode: 2441MHz Test Date : 03/05/2012
 Frequency Range: 30~1000MHz Temperature : 28 °C
 Test Result: PASS Humidity : 65 %
 Measured Distance: 3m Test By: KL

Freq. (MHz)	Ant.Pol. H/V	Emission Level (dBuV)	Limit 3m (dBuV/m)	Margin (dB)	Note
104.30	V	37.16	43.50	-6.34	PK
127.53	V	28.73	43.50	-14.77	PK
176.32	V	34.93	43.50	-8.57	PK
240.98	V	30.61	46.00	-15.39	PK
336.48	V	39.17	46.00	-6.83	PK
431.49	V	40.49	46.00	-5.51	PK
104.49	H	36.83	43.50	-6.67	PK
239.71	H	34.87	46.00	-11.13	PK
335.67	H	43.73	46.00	-2.27	PK
431.77	H	43.39	46.00	-2.61	PK
733.14	H	42.60	46.00	-3.40	PK
800.15	H	40.10	46.00	-5.90	PK

Operation Mode: 2480MHz Test Date : 03/05/2012
 Frequency Range: 30~1000MHz Temperature : 28 °C
 Test Result: PASS Humidity : 65 %
 Measured Distance: 3m Test By: KL

Freq. (MHz)	Ant.Pol. H/V	Emission Level (dBuV)	Limit 3m (dBuV/m)	Margin (dB)	Note
104.30	V	37.18	43.50	-6.32	PK
127.53	V	28.33	43.50	-15.17	PK
176.32	V	34.95	43.50	-8.55	PK
240.85	V	30.41	46.00	-15.59	PK
336.48	V	38.96	46.00	-7.04	PK
431.38	V	40.36	46.00	-5.64	PK
104.49	H	36.89	43.50	-6.61	PK
239.70	H	34.91	46.00	-11.09	PK
335.47	H	43.85	46.00	-2.15	PK
431.77	H	43.39	46.00	-2.61	PK
733.68	H	42.59	46.00	-3.41	PK
800.65	H	40.06	46.00	-5.94	PK

- Note:**
- (1) All Readings are Peak Value.
 - (2) Emission Level= Reading Level+Probe Factor +Cable Loss
 - (3) The average measurement was not performed when the peak measured data under the limit of average detection.

Operation Mode: CH1: 2402MHz Test Date : 03/05/2012
 Frequency Range: 1-25GHz Temperature : 28 °C
 Test Result: PASS Humidity : 65 %
 Measured Distance: 3m Test By: Andy

Freq. (MHz)	Ant.Pol. H/V	Emission Level(dBuV)		Limit 3m(dBuV/m)		Margin(dB)	
		PK	AV	PK	AV	PK	AV
7846.15	V	51.86	39.42	74	54	-22.14	-14.58
10403.84	V	56.46	43.22	74	54	-17.54	-10.78
11288.46	V	54.75	43.82	74	54	-19.25	-10.18
--	V	--	--	--	--	--	--
--	V	--	--	--	--	--	--
9980.76	H	55.95	43.82	74	54	-18.05	-10.18
10923.07	H	56.26	44.34	74	54	-17.74	-9.66
12442.3	H	55.65	42.77	74	54	-18.35	-11.23
--	H	--	--	--	--	--	--
--	H	--	--	--	--	--	--

Operation Mode: CH40: 2441MHz Test Date : 03/05/2012
 Frequency Range: 1-25GHz Temperature : 28 °C
 Test Result: PASS Humidity : 65 %
 Measured Distance: 3m Test By: Andy

Freq. (MHz)	Ant.Pol. H/V	Emission Level(dBuV)		Limit 3m(dBuV/m)		Margin(dB)	
		PK	AV	PK	AV	PK	AV
7846.1	V	51.56	39.15	74	54	-22.44	-14.85
10405.25	V	56.46	42.21	74	54	-17.54	-11.79
11285.12	V	55.68	44.72	74	54	-18.32	-9.28
--	V	--	--	--	--	--	--
--	V	--	--	--	--	--	--
9980.56	H	55.89	44.12	74	54	-18.11	-9.88
10925.21	H	56.39	44.34	74	54	-17.61	-9.66
12445	H	55.65	42.87	74	54	-18.35	-11.13
--	H	--	--	--	--	--	--
--	H	--	--	--	--	--	--

Operation Mode: CH79: 2480MHz Test Date : 03/05/2012
 Frequency Range: 1-25GHz Temperature : 28 °C
 Test Result: PASS Humidity : 65 %
 Measured Distance: 3m Test By: Andy

Freq. (MHz)	Ant.Pol. H/V	Emission Level(dBuV)		Limit 3m(dBuV/m)		Margin(dB)	
		PK	AV	PK	AV	PK	AV
7845.02	V	54.36	41.05	74	54	-19.64	-12.95
10405.89	V	55.46	42.36	74	54	-18.54	-11.64
11280.78	V	55.45	43.28	74	54	-18.55	-10.72
--	V	--	--	--	--	--	--
--	V	--	--	--	--	--	--
9980.88	H	55.66	44.25	74	54	-18.34	-9.75
10920.05	H	56.21	44.34	74	54	-17.79	-9.66
12445.27	H	54.87	43.65	74	54	-19.13	-10.35
--	H	--	--	--	--	--	--
--	H	--	--	--	--	--	--

- Note:**
- (1) All Readings are Peak Value and AV.
 - (2) Emission Level= Reading Level+Probe Factor +Cable Loss
 - (3) Data of measurement within this frequency range shown "--" in the table above means the reading of emissions are attenuated more than 20dB below the permissible limits or the field strength is too small to be measured.

5.5 Radiated Measurement Photos:

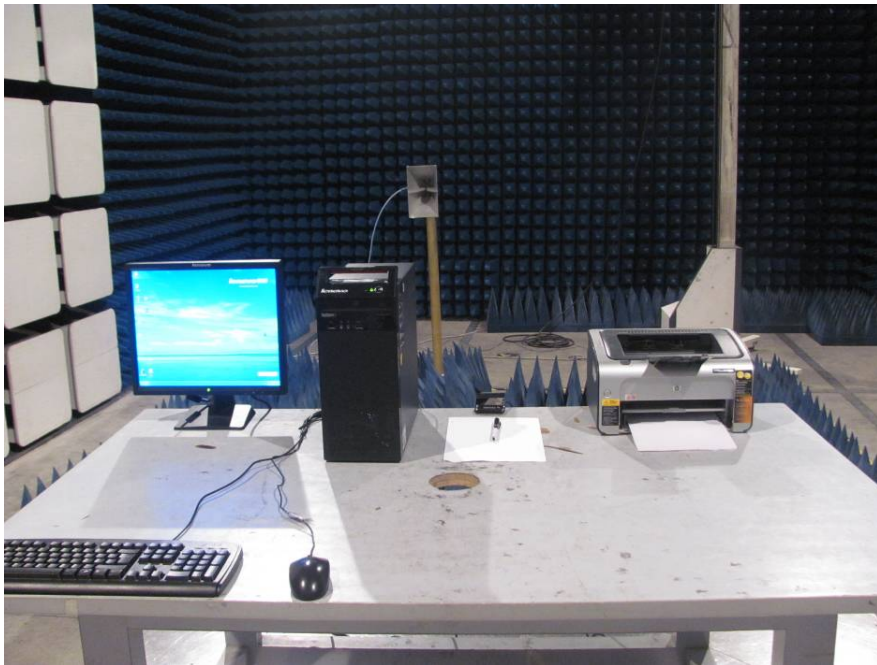
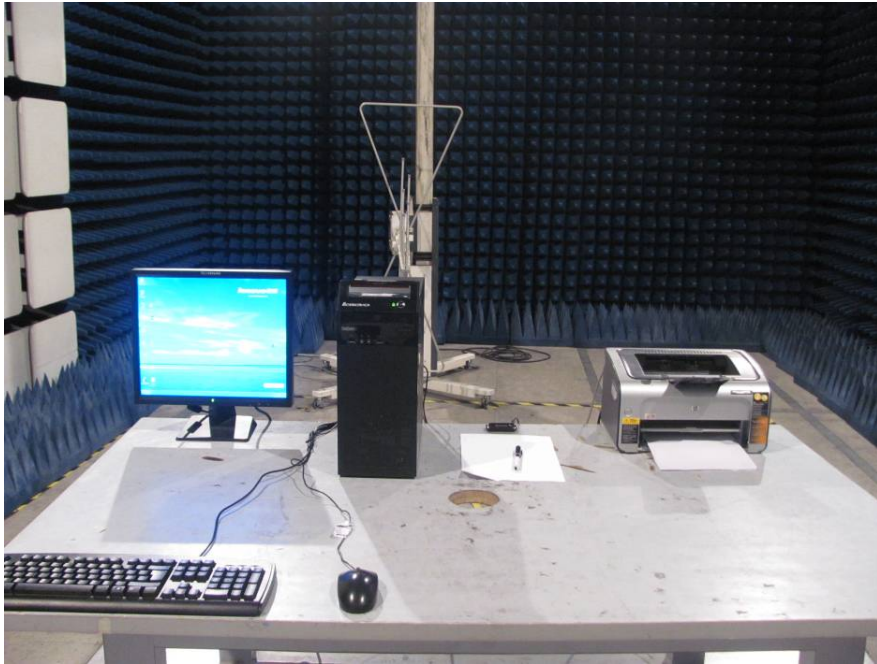

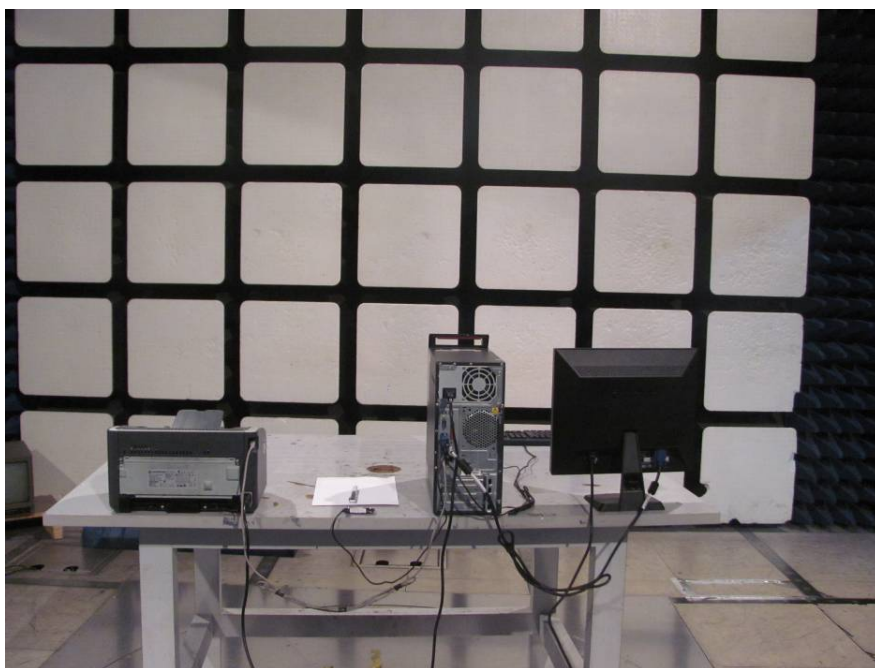

6. Channel Separation test

6.1 Measurement Procedure

The EUT was operating in hopping mode or could be controlled its channel. Printed out the test result from the spectrum by hard copy function.

6.2 Test SET-UP (Block Diagram of Configuration)

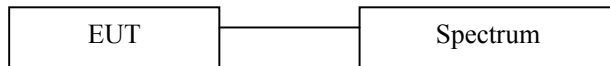

6.3 Measurement Equipment Used:

EQUIPMENT TYPE	MFR	MODEL NUMBER	SERIAL NUMBER	LAST CAL.	CAL DUE.
Spectrum Analyzer	HP	E4407B	839840481	05/29/2011	05/29/2012

6.4 Measurement Results:

Refer to attached data chart.

Spectrum Detector:	PK	Test Date :	03/05/2012
Test By:	Andy	Temperature :	28 °C
Test Result:	PASS	Humidity :	65 %

Channel number	Channel frequency (MHz)	Separation Read Value (kHz)	Separation Limit (kHz)
1	2402	1000.00	>716.67 kHz
40	2441	1000.00	>766.67 kHz
79	2480	1000.00	>742.00 kHz

NOTE: For two-third of the 20db bandwidth (page 28) is greater than 25kHz. So the limit of Separation Limit is just as the above table.

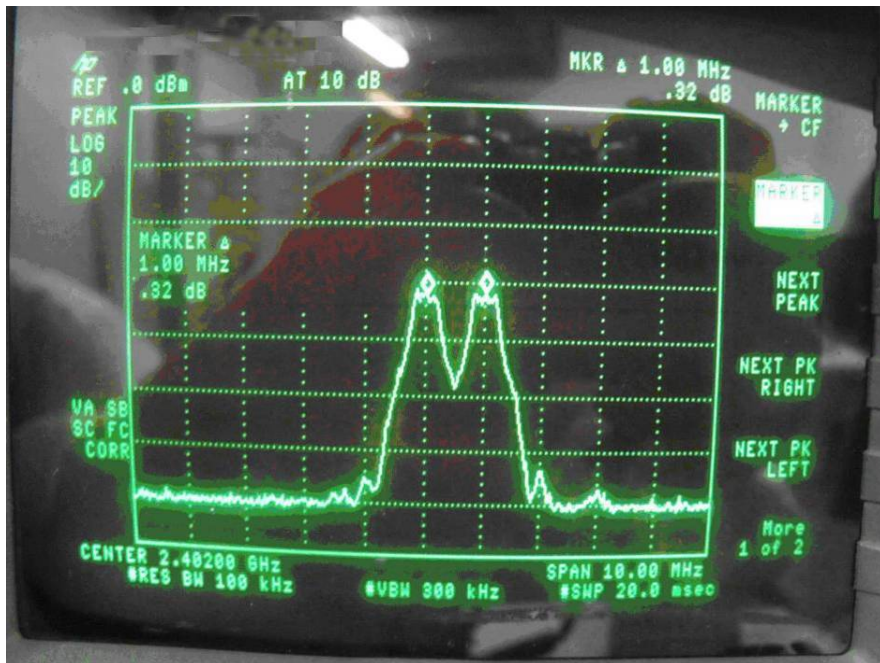

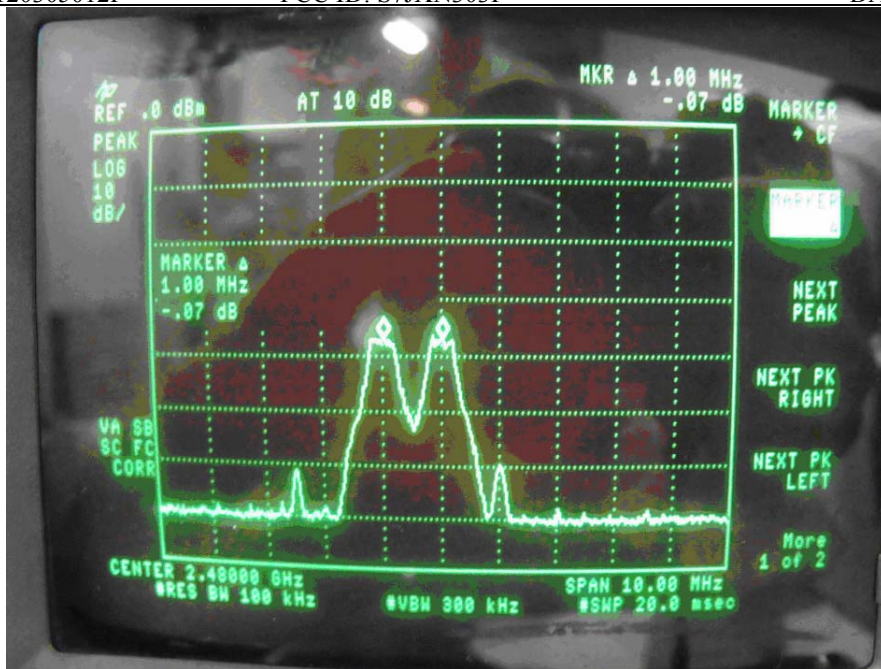

7. Bandwidth test

7.1 Measurement Procedure

The EUT was operating in hopping mode or could be controlled its channel. Printed out the test result from the spectrum by hard copy function.

7.2 Test SET-UP (Block Diagram of Configuration)



7.3 Measurement Equipment Used:

EQUIPMENT TYPE	MFR	MODEL NUMBER	SERIAL NUMBER	LAST CAL.	CAL DUE.
Spectrum Analyzer	HP	E4407B	839840481	05/29/2011	05/29/2012

7.4 Measurement Results:

7.4.1 20dB Bandwidth test data Chart:

Refer to attached data chart.

Spectrum Detector: PK Test Date: 03/05/2012
 Test By: Andy Temperature: 28 °C
 Test Result: PASS Humidity: 65 %

Channel number	Channel frequency (MHz)	20dB Down BW(kHz)
1	2402	1075
40	2441	1150
79	2480	1113





8. Quantity of Hopping Channel Test

8.1 Measurement Procedure

The EUT was operating in hopping mode or could be controlled its channel. Printed out the test result from the spectrum by hard copy function.

8.2 Test SET-UP (Block Diagram of Configuration)

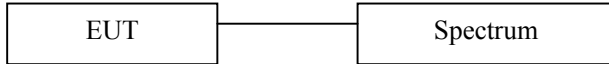

8.3 Measurement Equipment Used:

EQUIPMENT TYPE	MFR	MODEL NUMBER	SERIAL NUMBER	LAST CAL.	CAL DUE.
Spectrum Analyzer	HP	E4407B	839840481	05/29/2011	05/29/2012

8.4 Measurement Results:

Refer to attached data chart.

Spectrum Detector: PK Test Date : 03/05/2012
 Test By: Andy Temperature : 28 °C
 Test Result: PASS Humidity : 65 %

Hopping Channel Frequency Range	Quantity of Hopping Channel	Quantity of Hopping Channel Limit
2402-2480	79	> 15

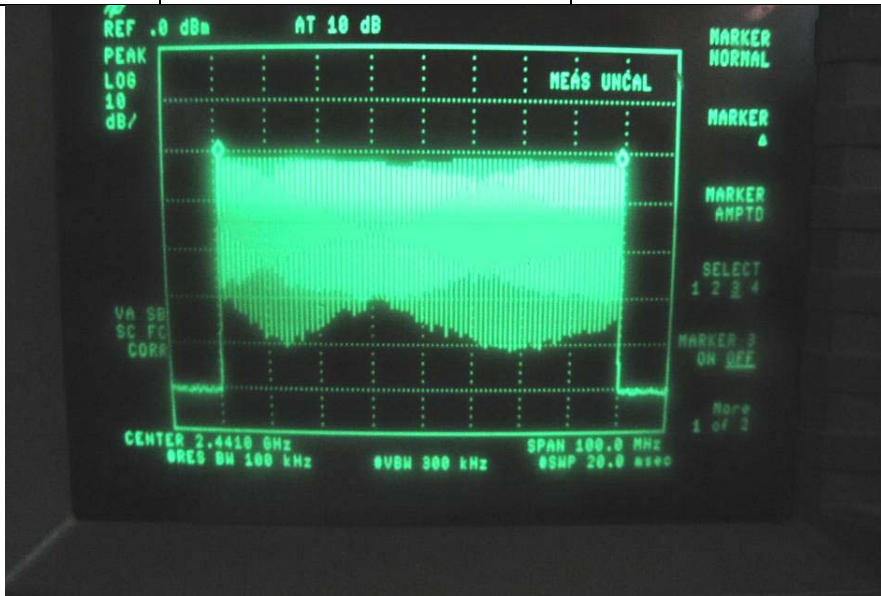

9. Time of Occupancy (Dwell Time) test

9.1 Measurement Procedure

- a. Check the calibration of the measuring instrument(SA) using either an internal calibrator or a known signal from an external generator.
- b. Turn on the EUT and connect its antenna terminal to measurement via a low loss cable. Then set it to any one measured frequency within its operating range and make sure the instrument is operated in its linear range.
- c. Adjust the center frequency of SA on any frequency be measured and set SA to zero span mode. And then, set RBW and VBW of spectrum analyzer to proper value.
- d. Measure the time duration of one transmission on the measured frequency. And then plot the result with time difference of this time duration.
- e. Repeat above procedures until all different time-slot modes have been completed.

9.2 Test SET-UP (Block Diagram of Configuration)



9.3 Measurement Equipment Used:

EQUIPMENT TYPE	MFR	MODEL NUMBER	SERIAL NUMBER	LAST CAL.	CAL DUE.
EMI Test Receiver	Rohde & Schwarz	ESU	1302.6005.26	05/29/2011	05/29/2012

9.4 Measurement Results:

Refer to attached data chart.

Spectrum Detector:	PK	Test Date :	03/05/2012
Test By:	Andy	Temperature :	28 °C
Test Result:	PASS	Humidity :	65 %

Mode	Number of transmission in a 31.6(79 Hopping*0.4)	Length of transmissions time(msec)	Result (msec)	Limit (msec)
DH1	51(times/5 sec)*6.32=322.32 times	0.392628	125.6410	400
DH3	26(times/5 sec)*6.32=164.32 times	1.650641	264.1026	400
DH5	15(times/5 sec)*6.32=94.80 times	2.908654	310.2661	400

DH1

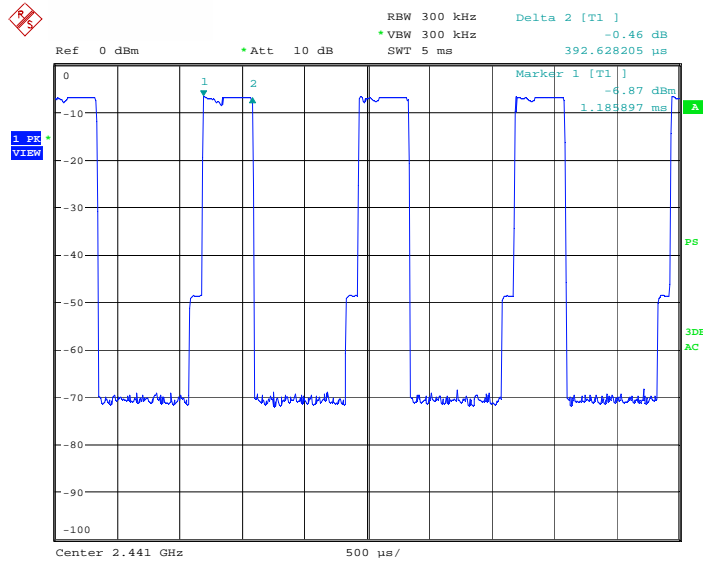

DH3

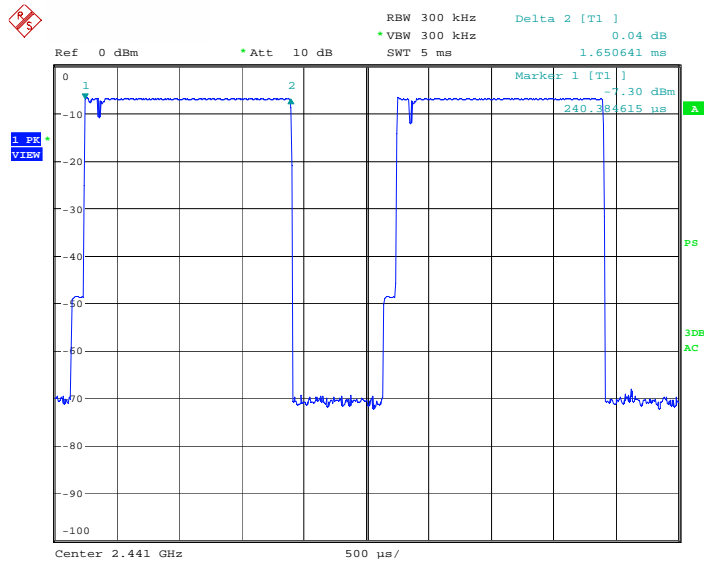

DH5

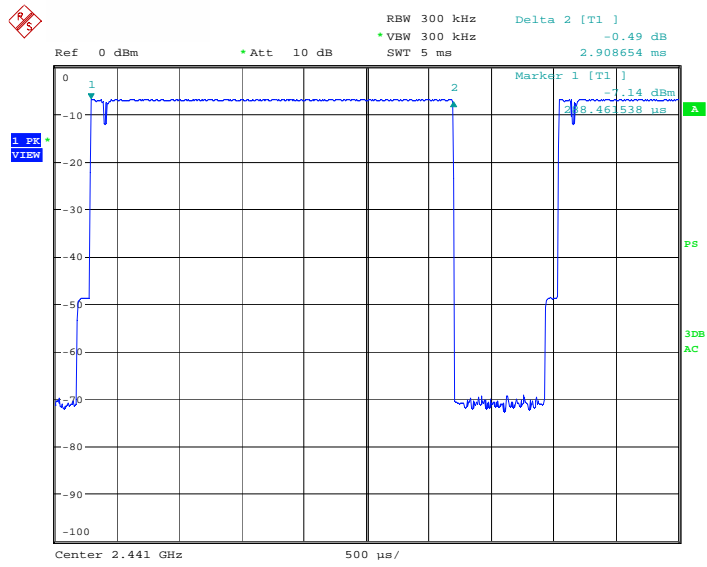

10. MAXIMUM PEAK OUTPUT POWER TEST

10.1 Measurement Procedure

- a. Check the calibration of the measuring instrument(SA) using either an internal calibrator or a known signal from an external generator.
- b. Turn on the EUT and connect it to measurement instrument. Then set it to any one convenient frequency within its operating range. Set a reference level on the measuring instrument equal to the highest peak value.
- c. The center frequency of the spectrum analyzer is set to the fundamental frequency and using proper RBW and VBW setting.
- d. Measure the captured power within the band and recording the plot.
- e. Repeat above procedures until all frequencies required were complete.

10.2 Test SET-UP (Block Diagram of Configuration)

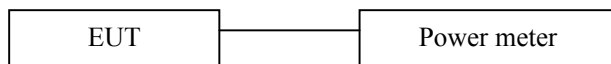

10.3 Measurement Equipment Used:

EQUIPMENT TYPE	MFR	MODEL NUMBER	SERIAL NUMBER	LAST CAL.	CAL DUE.
Power meter	Boonton	4232A	29001	05/29/2011	05/29/2012
Power sensor	Boonton	51011-EMC	31184	05/29/2011	05/29/2012

10.4 Measurement Results:

Refer to attached data chart.

Spectrum Detector:	PK	Test Date :	03/05/2012
Test By:	Andy	Temperature :	28 °C
Test Result:	PASS	Humidity :	65 %

Channel number	Channel Frequency (MHz)	Peak Power output(dBm)	Peak Power output(mW)	Peak Power Limit(mW)	Pass/Fail
1	2402.00	-1.89	0.64	125	PASS
40	2440.00	-2.13	0.61	125	PASS
79	2480.00	-2.05	0.62	125	PASS

11. Band EDGE test

11.1 Measurement Procedure

1. The EUT was Operating in hopping mode or could be controlled its channel. Printed out test result from the spectrum by hard copy function.
2. The EUT was placed on a turn table which is 0.8m above ground plane.
3. Maximum procedure was performed on the six highest emissions to ensure EUT compliance.
4. And also, each emission was to be maximized by changing the polarization of receiving antenna both horizontal and vertical.
5. Repeat above procedures until all frequency measured were complete.

11.2 Test SET-UP (Block Diagram of Configuration)

As 5.2 Test set up (B) and (C)

11.3 Measurement Equipment Used:

Same as 5.3 Radiated Emission Measurement.

11.4 Measurement Results:

Spectrum Detector: PK/AV Test Date : 03/05/2012
 Test By: Andy Temperature : 28 °C
 Test channel: 00 Humidity : 65 %

Frequency (MHz)	Polarity	Level (dBuV/m)		Limited (dBuV/m)	
		PK	AV	PK	AV
2385.56	H	48.77	35.28	74	54
2384.78	V	49.26	36.33	74	54

Spectrum Detector: PK/AV Test Date : 03/05/2012
 Test By: Andy Temperature : 28 °C
 Test channel: 78 Humidity : 65 %

Frequency (MHz)	Polarity	Level (dBuV/m)		Limited (dBuV/m)	
		PK	AV	PK	AV
2484.78	H	51.03	38.54	74	54
2483.65	V	50.47	37.35	74	54

12. Antenna Port Emission

12.1 Test Equipment

EQUIPMENT TYPE	MFR	MODEL NUMBER	SERIAL NUMBER	LAST CAL.	CAL DUE.
EMI Test Receiver	Rohde & Schwarz	ESU	1302.6005.26	05/29/2011	05/29/2012

12.2 Measuring Instruments and setting

The following table is the setting of spectrum analyzer.

Spectrum analyzer	Setting
Attenuation	Auto
RB	100kHz
VB	300kHz
Detector	Peak
Trace	Max hold

12.3 Test Procedures

The conducted spurious emissions were measured conducted using a spectrum analyzer at low, mid, and hi channels, The limit was determined by attenuation 20dB of the RF peak power output.

12.4 Block Diagram of Test setup

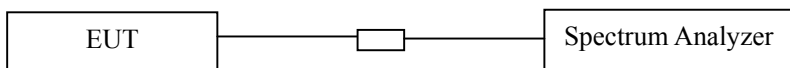

12.5. Test Result

PASS.

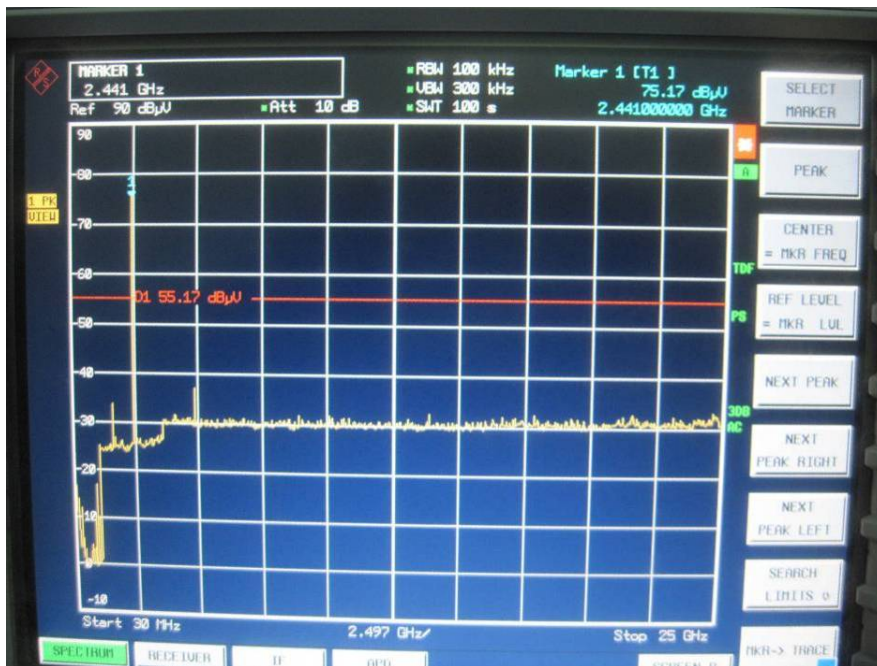
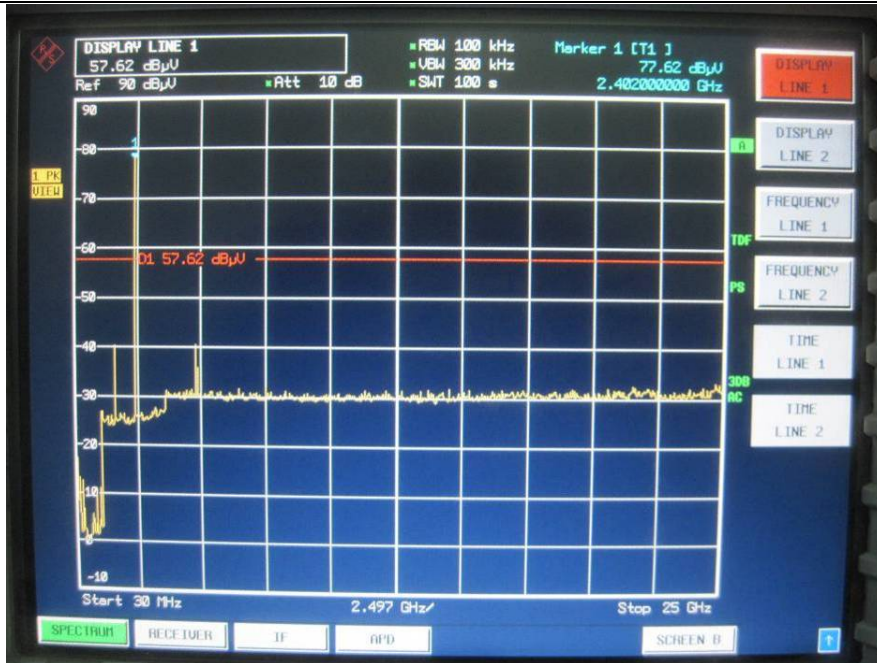

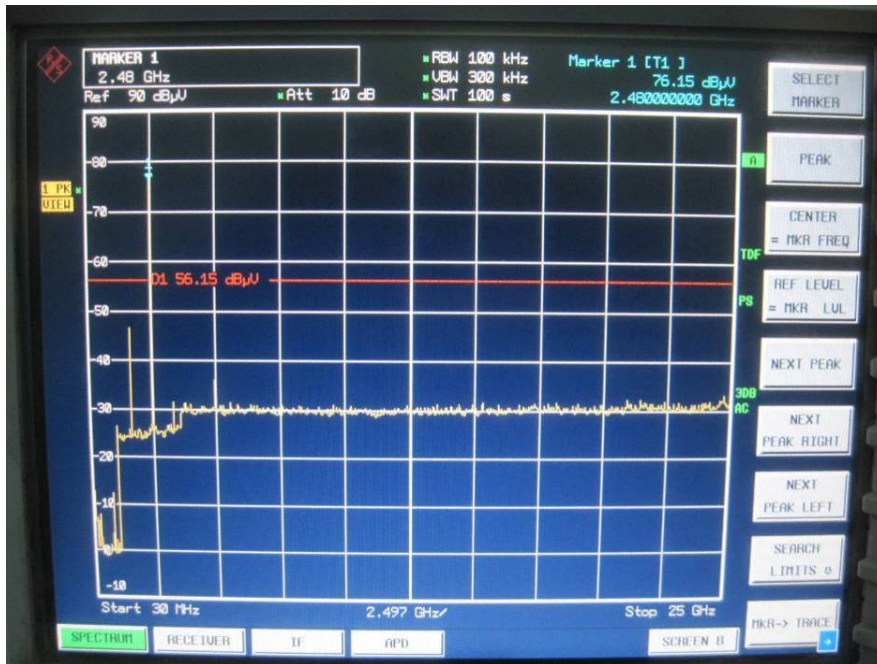

13. Antenna Application

13.1 Antenna requirement

The EUT'S antenna is met the requirement of FCC part 15C section 15.203 and 15.247.

FCC part 15C section 15.247 requirements:

Systems operating in the 2402-2480MHz band that are used exclusively for fixed, point-to-point operations may employ transmitting antennas with directional gain greater than 6dBi provided the maximum peak output power of the intentional radiator is reduced by 1dB for every 3dB that the directional gain of the antenna exceeds 6dBi.

13.2. Result

The EUT's antenna used a chip antenna and integrated on PCB, The antenna's gain is 0dBi and meets the requirement.