

**ELECTROMAGNETIC EMISSIONS COMPLIANCE REPORT
INTENTIONAL RADIATOR CERTIFICATION TO
FCC PART 15 SUBPART C REQUIREMENT**

OF

Mobile Digital Pen

MODEL No.: XN205BT, XN206BT, XN403BT, GSN403BT, KTN205BT

BRAND NAME: N/A

FCC ID: S7JXN205BT

REPORT NO: ES101012024F

ISSUE DATE: October 19, 2010

Prepared for

**SHENZHEN YIFANG DIGITAL TECHNOLOGY CO., LTD.
Building NO.23, Fifth Region, Baiwangxin Industrial Park, Songbai Rd., Nanshan,
Shenzhen, 518108, China**

Prepared by

SHENZHEN EMTEK CO., LTD

**Bldg 69, Majialong Industry Zone, Nanshan District,
Shenzhen, Guangdong, China**

TEL: 86-755-26954280

FAX: 86-755-26954282

VERIFICATION OF COMPLIANCE

Applicant:	SHENZHEN YIFANG DIGITAL TECHNOLOGY CO., LTD. Building NO.23, Fifth Region, Baiwangxin Industrial Park, Songbai Rd., Nanshan, Shenzhen, 518108, China
Product Description:	Mobile Digital Pen
Brand Name:	N/A
Model Number:	XN205BT, XN206BT, XN403BT, GSN403BT, KTN205BT (Note: all the modes have the same PCB, only difference are the appearance and color. We take XN205BT for test.)
Serial Number:	N/A
File Number:	ES101012024F
Date of Test:	October 11, 2010 to October 19, 2010

We hereby certify that:

The above equipment was tested by SHENZHEN EMTEK CO., LTD. The test data, data evaluation, test procedures, and equipment configurations shown in this report were made in accordance with the procedures given in ANSI C63.4 (2009) and the energy emitted by the sample EUT tested as described in this report is in compliance with conducted and radiated emission limits of FCC Rules Part 15.247 .

The test results of this report relate only to the tested sample identified in this report.

Approved By



David Lee / Q.A. Manager
SHENZHEN EMTEK CO., LTD.

Table of Contents

1.	GENERAL INFORMATION	5
1.1	PRODUCT DESCRIPTION	5
1.2	RELATED SUBMITTAL(S) / GRANT (S)	5
1.3	TEST METHODOLOGY	5
1.4	SPECIAL ACCESSORIES	5
1.5	EQUIPMENT MODIFICATIONS	5
1.6	TEST FACILITY	6
2.	SYSTEM TEST CONFIGURATION	7
2.1	EUT CONFIGURATION	7
2.2	EUT EXERCISE	7
2.3	TEST PROCEDURE	7
2.4	LIMITATION	7
2.5	CONFIGURATION OF TESTED SYSTEM	11
2.6	EQUIPMENT USED IN TESTED SYSTEM	11
2.7	DESCRIPTION OF TEST MODES	12
3.	SUMMARY OF TEST RESULTS	13
4.	CONDUCTED EMISSIONS TEST	14
4.1	MEASUREMENT PROCEDURE:	14
4.2	TEST SET-UP (BLOCK DIAGRAM OF CONFIGURATION)	14
4.3	MEASUREMENT EQUIPMENT USED:	14
4.4	CONDUCTED EMISSION LIMIT	14
4.5	MEASUREMENT RESULT:	15
4.6	CONDUCTED MEASUREMENT PHOTOS:	16
5.	RADIATED EMISSION TEST	17
5.1	MEASUREMENT PROCEDURE	17
5.2	TEST SET-UP (BLOCK DIAGRAM OF CONFIGURATION)	18
5.3	MEASUREMENT EQUIPMENT USED:	19
5.4	MEASUREMENT RESULT	19
5.5	RADIATED MEASUREMENT PHOTOS:	25
6.	CHANNEL SEPARATION TEST	27
6.1	MEASUREMENT PROCEDURE	27
6.2	TEST SET-UP (BLOCK DIAGRAM OF CONFIGURATION)	27
6.3	MEASUREMENT EQUIPMENT USED:	27
6.4	MEASUREMENT RESULTS:	27
7.	BANDWIDTH TEST	30
7.1	MEASUREMENT PROCEDURE	30
7.2	TEST SET-UP (BLOCK DIAGRAM OF CONFIGURATION)	30

7.3 MEASUREMENT EQUIPMENT USED: 30

7.4 MEASUREMENT RESULTS:..... 30

8. QUANTITY OF HOPPING CHANNEL TEST..... 33

8.1 MEASUREMENT PROCEDURE..... 33

8.2 TEST SET-UP (BLOCK DIAGRAM OF CONFIGURATION)..... 33

8.3 MEASUREMENT EQUIPMENT USED: 33

8.4 MEASUREMENT RESULTS:..... 33

9. TIME OF OCCUPANCY (DWELL TIME) TEST 34

9.1 MEASUREMENT PROCEDURE..... 34

9.2 TEST SET-UP (BLOCK DIAGRAM OF CONFIGURATION)..... 34

9.3 MEASUREMENT EQUIPMENT USED: 34

9.4 MEASUREMENT RESULTS:..... 34

10. MAXIMUM PEAK OUTPUT POWER TEST 37

10.1 MEASUREMENT PROCEDURE..... 37

10.2 TEST SET-UP (BLOCK DIAGRAM OF CONFIGURATION)..... 37

10.3 MEASUREMENT EQUIPMENT USED: 37

10.4 MEASUREMENT RESULTS:..... 37

11. BAND EDGE TEST 38

11.1 MEASUREMENT PROCEDURE..... 38

11.2 TEST SET-UP (BLOCK DIAGRAM OF CONFIGURATION)..... 38

11.3 MEASUREMENT EQUIPMENT USED: 38

11.4 MEASUREMENT RESULTS:..... 38

12. ANTENNA PORT EMISSION..... 40

12.1 TEST EQUIPMENT 40

12.2 MEASURING INSTRUMENTS AND SETTING 40

12.3 TEST PROCEDURES 40

12.4 BLOCK DIAGRAM OF TEST SETUP..... 40

12.5. TEST RESULT 40

13. ANTENNA APPLICATION..... 42

13.1 ANTENNA REQUIREMENT 42

13.2. RESULT 42

1. GENERAL INFORMATION

1.1 Product Description

The SHENZHEN YIFANG DIGITAL TECHNOLOGY CO., LTD.

Model: XN205BT(referred to as the EUT in this report) The EUT is an short range, lower power, Mobile Digital Pen designed as an " Input Device. It is designed by way of utilizing the GFSK, DQPSK and 8DPSK modulation achieves the system operating.

A major technical descriptions of EUT is described as following:

- A). Operation Frequency: 2402-2480MHz
- B). Modulation: GFSK, DQPSK, 8DPSK
- C). Number of Channel: 79
- D). Channel space: 1MHz
- E). Rated RF Output Power:-1.89dBm
- F). BIT Rate of Transmission: 2Mbps, 3Mbps
- G). Antenna Type: PCB antenna
- H). Antenna GAIN: 0dBi
- I). Power Supply: DC 5V From PC
- J). Adapter: N/A

1.2 Related Submittal(s) / Grant (s)

This submittal(s) (test report) is intended for FCC ID: S7JXN205BT filing to comply with Section 15.247 of the FCC Part 15, Subpart C Rules. The composite system (receiver) is compliance with Subpart B is authorized under a DoC procedure.

1.3 Test Methodology

Both conducted and radiated testing were performed according to the procedures in ANSI C63.4 (2009). Radiated testing was performed at an antenna to EUT distance 3 meters.

1.4 Special Accessories

Not available for this EUT intended for grant.

1.5 Equipment Modifications

Not available for this EUT intended for grant.

1.6 Test Facility

Site Description
EMC Lab. : Accredited by CNAS, 2005.11.02
The certificate is valid until 2010.11
The Laboratory has been assessed and proved to be in compliance
with CNAS/CL01:2006(identical to ISO/IEC17025: 2005)
The Certificate Registration Number is L2291

Accredited by TUV Rheinland Shenzhen 2010.5.25
The Laboratory has been assessed according to the requirements
ISO/IEC 17025

Accredited by FCC, March 18, 2008
The Certificate Registration Number is 709623.

Accredited by Industry Canada, March 5, 2010
The Certificate Registration Number is 46405-4480.

Name of Firm : SHENZHEN EMTEK CO., LTD
Site Location : Bldg 69, Majialong Industry Zone,
Nanshan District, Shenzhen, Guangdong, China

2. System Test Configuration

2.1 EUT Configuration

The EUT configuration for testing is installed on RF field strength measurement to meet the Commissions requirement and operating in a manner which intends to maximize its emission characteristics in a continuous normal application.

2.2 EUT Exercise

The Transmitter was operated in the normal operating mode. The Tx frequency was fixed which was for the purpose of the measurements.

2.3 Test Procedure

2.3.1 Conducted Emissions

The EUT is a placed on as turn table which is 0.8 m above ground plane. According to the requirements in Section 13.1.4.1 of ANSI C63.4-2009. and RSS GEN Conducted emissions from the EUT measured in the **frequency range between 0.15 MHz and 30MHz** using **CISPR Quasi-Peak and average detector mode**.

2.3.2 Radiated Emissions

The EUT is a placed on as turn table which is 0.8 m above ground plane. The turn table shall rotate 360 degrees to determine the position of maximum emission level. EUT is set 3m away from the receiving antenna which varied from 1m to 4m to find out the highest emission. And also, each emission was to be maximized by changing the polarization of receiving antenna both horizontal and vertical. In order to find out the max. emission, the relative positions of this hand-held transmitter(EUT) was rotated through three orthogonal axes according to the requirements in Section 13.1.4.1 of ANSI C63.4-2009 and RSS GEN.

2.4 Limitation

(1) Channel Separation test

FCC Part 15, Subpart C Section 12.247(a)(1) Frequency hopping systems shall have hopping channel carrier frequencies separated by a minimum of 25kHz or the 20 Bandwidth of the hopping channel, whichever is greater.

Frequency Range (MHz)	Limit(kHz)
902-928	>25kHz
2400-2483.5	>25kHz
5725-5850	>25kHz

(2) **20dB Bandwidth**

Frequency Range(MHz)	Quantity of Hopping Channel	Limit(kHz)			
		50	25	15	75
902-928		<250	>250	NA	NA
2400-2483.5		NA	NA	>1000	<1000

(3) **Quantity of Hopping Channel**

FCC Part 15, Subpart C Section 12.247

Frequency Range (MHz)	Limit(Quantity of Hopping Channel)			
	20dB bandwidth <250kHz	20dB bandwidth >250kHz	20dB bandwidth <1MHz	20dB bandwidth >1MHz
902-928	50	25	NA	NA
2400-2483.5	NA	NA	75	15
5725-5850	NA	NA	75	NA

(4) **Time of Occupancy(Dwell Time)**

FCC Part 15, Subpart C Section 12.247

Frequency Range (MHz)	LIMIT(rms)		
	20dB bandwidth <250kHz(50Channel)	20dB bandwidth >250kHz(25Channel)	20dB bandwidth <1MHz(75Channel)
902-928	400(20S)	400(10S)	NA
2400-2483.5	NA	NA	400(30S)
5725-5850	NA	NA	400(30S)

Note: The “()” is all channel’s average time of occupancy.

(5) **Maximum Peak Output Power**

FCC Part 15, Subpart C Section 12.247

Frequency Range (MHz)	Quantity of Hopping Channel	LIMIT(W)			
		50	25	15	75
902-928		1(30dBm)	0.125(21dBm)	NA	NA
2400-2483.5		NA	NA	0.125(21dBm)	1(30dBm)
5725-5850		NA	NA	NA	1(30dBm)

(6) Band edge

FCC Part15, Subpart C Section 15.247, In any 100kHz bandwidth outside the frequency band in with the spread spectrum intentional radiator is operating, the radio frequency power that is produced by the intentional radiator shall be at least 20dB below that in the 100kHz bandwidth within the band that contains the highest level of the desired power, based on either an RF conducted or a radiated measurement, attenuation below the general limits specified in section 15.209(a) is not required. In addition, radiated emissions which fall in the restricted bands, as defined in section 15.205(a), must also comply with the radiated emission limits specified in section 15.209(a).

Operating Frequency Range(MHz)	Spurious emission frequency	Limit Peak power ration to emission(dBc)	Limit Emission level(dBuV/m)
902-928	<902	>20	NA
	>928	>20	NA
	960-1240	NA	54
2400-2483.5	<2400	>20	NA
	>2483.5-2500	NA	54
5725-5850	<5350-5460	NA	54
	<5725	>20	NA
	>5850	>20	NA

(7) Conducted Emission

Frequency(MHz)	Quasi-peak	Average
0.15-0.5	66-56	56-46
0.5-5.0	56	46
5.0-30.0	60	50

Note:

1. The lower limit shall apply at the transition frequencies
2. The limit decreases in line with the logarithm of the frequency in the range of 0.15 to 0.50MHz.

(8) Radiated Emission

FCC Part 15, Subpart C Section 15.209 limit of radiated emission for frequency below 1000GHz. The emissions from an intentional radiator shall not exceed the field strength level specified in the following table:

Frequency (MHz)	Field strength $\mu\text{V/m}$	Distance(m)	Field strength at 3m $\text{dB}\mu\text{V/m}$
30-88	100	3	40
88-216	150	3	43.5
216-960	200	3	46
Above 960	500	3	54

Remark: 1. Emission level in $\text{dB}\mu\text{V/m} = 20 \log(\text{uV/m})$
 2. Measurement was performed at an antenna to the closed point of EUT distance of meters.

FCC Part 15, Section 15.35(b) limit of radiated emission for frequency above 1000MHz

Frequency(MHz)	Class A($\text{dB}\mu\text{V/m}$)(at 3m)		Class B($\text{dB}\mu\text{V/m}$)(at 3m)	
	PEAK	AVERAGE	PEAK	AVERAGE
Above 1000	80.0	60.0	74.0	54.0

FCC Part 15, Subpart C Section 15.249 The field strength of emissions from intentional radiators operated within these frequency bands shall comply with the following:

Frequency(MHz)	Filed Strength of Fundamental(at 3m)		Filed Strength of Harmonics(at 3m)	
	PEAK	AVERAGE	PEAK	AVERAGE
902-928	114	94	74.0	54.0
2400-2483.5	114	94	74.0	54.0
5725-5875	114	94	74.0	54.0
24000-24250	128	108	88.0	68.0

2.5 Configuration of Tested System

Fig. 2-1 Configuration of Tested System

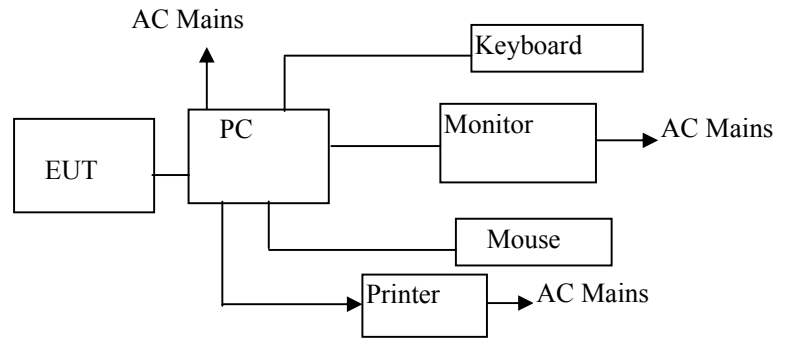

2.6 Equipment Used in Tested System

Item	Equipment	Mfr/Brand	Model/Type No.	FCC ID	Series No.	Note
1.	Mobile Digital Pen	N/A	N/A	S7JXN205BT	N/A	<i>EUT</i>

Note:

- (1) Unless otherwise denoted as EUT in 『Remark』 column , device(s) used in tested system is a support equipment.

2.7 Description of test modes

The EUT (Mobile Digital Pen) has been tested under normal operating condition.

This EUT is a FHSS system, we use blue test to control the EUT with parallel port, Let EUT hopping on and transmit at every channel with highest power, Only output power use conducted method, others are using radiated method. After sirfdemo330R1 send the command to EUT, it can be removed, and the EUT keep hopping. 79 Channels are provided by EUT. The 3 channels of lower, medium and higher were chosen for best.

Channel	Frequency(MHz)
1	2402
40	2441
79	2480

3. Summary of Test Results

FCC Rules	Description Of Test	Result
§15.247(a)(1)	Channel Separation test	Compliant
§15.247(a)(1)	20dB Bandwidth	Compliant
§15.247(a)(1)(iii)	Quantity of Hopping Channel	Compliant
§15.247(a)(1)(iii)	Time of Occupancy (Dwell Time)	Compliant
§15.247(b)	Max Peak output Power test	Compliant
§15.247(d)	Band edge test	Compliant
§15.207	AC Power Conducted Emission	Compliant
§15.247(d),§15.209	Radiated Emission	Compliant
§15.203	Antenna Requirement	Compliant
§15.109	Receiver spurious emissions	Compliant

4. Conducted Emissions Test

4.1 Measurement Procedure:

1. The EUT was placed on a table which is 0.8m above ground plane.
2. Maximum procedure was performed on the six highest emissions to ensure EUT compliance.
3. Repeat above procedures until all frequency measured were complete.

4.2 Test SET-UP (Block Diagram of Configuration)

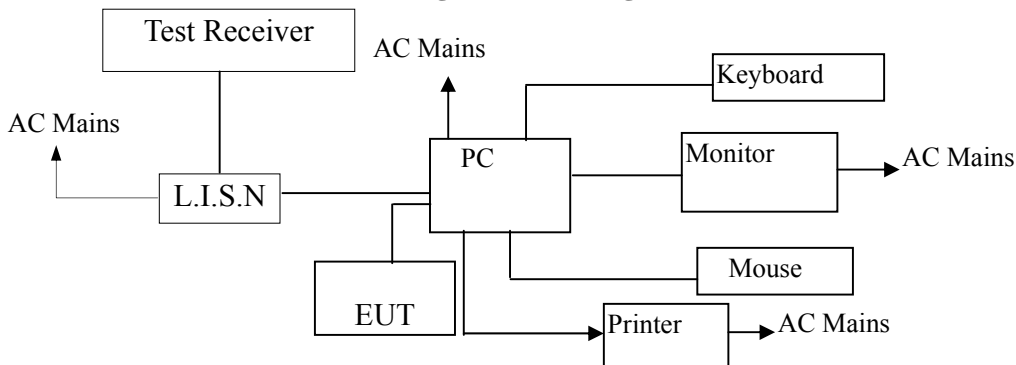

4.3 Measurement Equipment Used:

Conducted Emission Test Site # 4					
EQUIPMENT TYPE	MFR	MODEL NUMBER	SERIAL NUMBER	LAST CAL.	CAL DUE.
Test Receiver	Rohde & Schwarz	ESCS30	828985/018	05/29/2010	05/29/2011
L.I.S.N	Rohde & Schwarz	ESH2-Z5	834549/005	05/29/2010	05/29/2011
L.I.S.N	Rohde & Schwarz	ESH2-Z5	834549/005	05/29/2010	05/29/2011
50ΩCoaxial Switch	Anritsu	MP59B	M20531	005/29/2010	05/29/2011

4.4 Conducted Emission Limit

(7) Conducted Emission

Frequency(MHz)	Quasi-peak	Average
0.15-0.5	66-56	56-46
0.5-5.0	56	46
5.0-30.0	60	50

Note:

1. The lower limit shall apply at the transition frequencies
2. The limit decreases in line with the logarithm of the frequency in the range of 0.15 to 0.50MHz.

4.5 Measurement Result:

Date of Test: 10/16/2010 Temperature: 22°C
 Frequency Detector: 0.15~30MHz Humidity: 50%
 Test Result: PASS Test Mode: Bluetooth Mode

Test Line	Frequency MHz	Emission Level QP dB(μV)	Emission Level AV dB(μV)	Limits QP dB(μV)	Limits AV dB(μV)	Margin QP dB(μV)	Margin AV dB(μV)
Neutral	0.15	39.13	28.06	66	56	-26.87	-27.94
	0.205	33.82	26.11	63.41	53.41	-29.59	-27.3
	0.275	31.84	23.97	60.97	50.97	-29.13	-27
	0.825	32.25	29.45	56	46	-23.75	-16.55
	1.94	29.92	28.65	56	46	-26.08	-17.35
	15.1	37.14	31.86	60	50	-22.86	-18.14
Line	0.205	34.82	26.11	63.41	53.41	-28.59	-27.3
	0.275	32.75	23.97	60.97	50.97	-28.22	-27
	0.345	27.52	19.93	59.08	49.08	-31.56	-29.15
	0.825	30.75	29.45	56	46	-25.25	-16.55
	1.94	30.42	28.65	56	46	-25.58	-17.35
	15.1	37.14	31.86	60	50	-22.86	-18.14

4.6 Conducted Measurement Photos:



5. Radiated Emission Test

5.1 Measurement Procedure

- 1 The EUT was placed on a turn table which is 0.8m above ground plane.
2. Maximum procedure was performed on the six highest emissions to ensure EUT compliance.
3. And also, each emission was to be maximized by changing the polarization of receiving antenna both horizontal and vertical.
4. Repeat above procedures until all frequency measured were complete.

5.2 Test SET-UP (Block Diagram of Configuration)

(A) Radiated Emission Test Set-Up, Frequency Below 30MHz

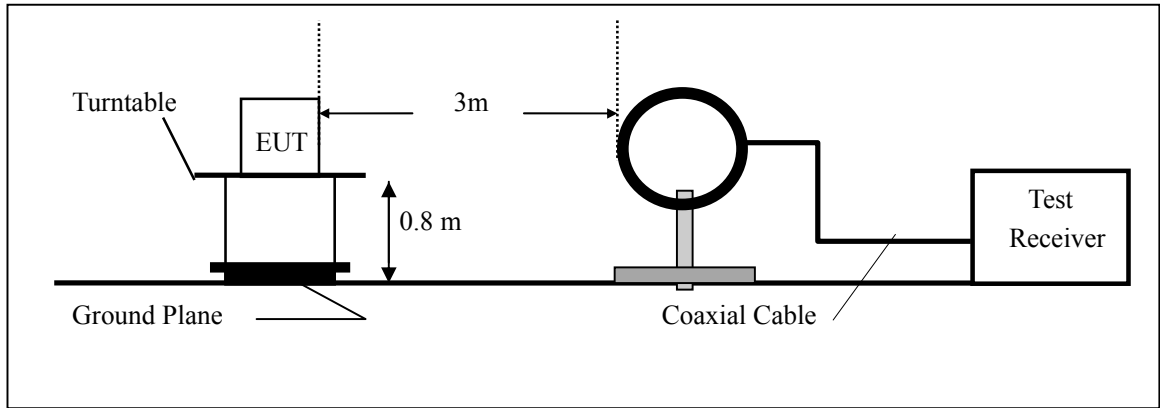

(B) Radiated Emission Test Set-Up, Frequency Below 1000MHz

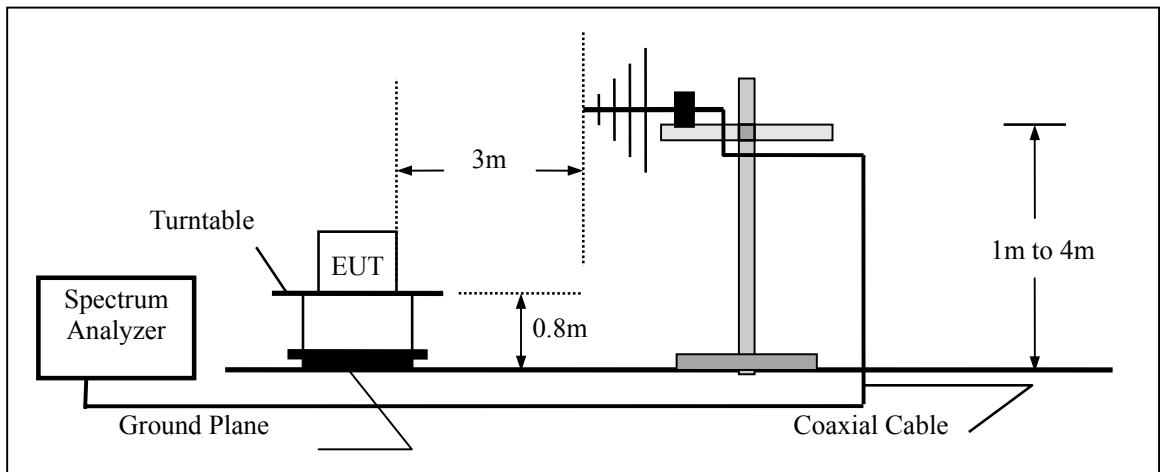

(C) Radiated Emission Test Set-Up, Frequency above 1000MHz

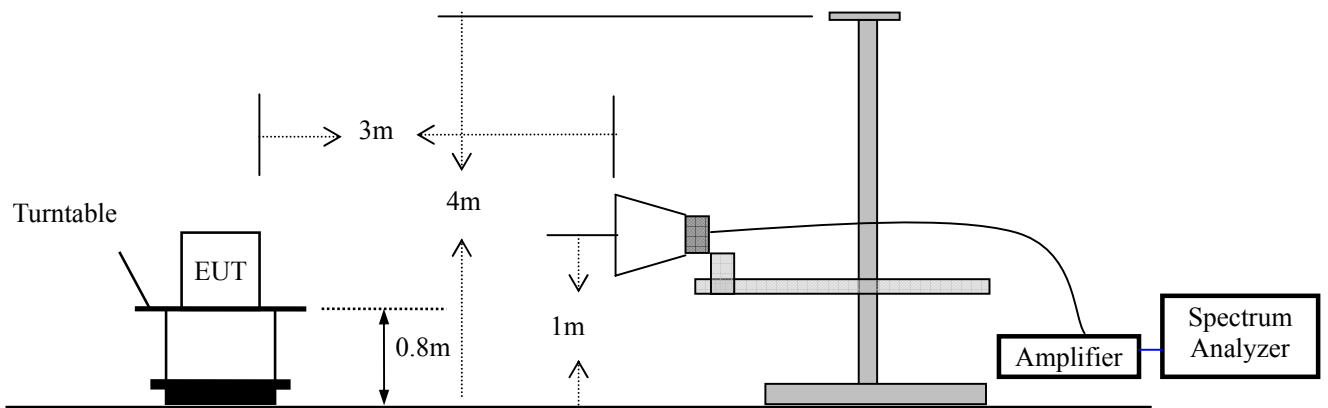

5.3 Measurement Equipment Used:

EQUIPMENT TYPE	MFR	MODEL NUMBER	SERIAL NUMBER	LAST CAL.	CAL DUE.
Spectrum Analyzer	Rohde & Schwarz	FSP7	839511/010	05/29/2010	05/29/2011
Spectrum Analyzer	HP	E4407B	839840481	05/29/2010	05/29/2011
EMI Test Receiver	Rohde & Schwarz	ESCS30	828985/018	05/29/2010	05/29/2011
Pre-Amplifier	HP	8447D	2944A07999	05/29/2010	05/29/2011
Bilog Antenna	Schwarzbeck	VULB9163	142	05/29/2010	05/29/2011
Loop Antenna	ARA	PLA-1030/B	1029	05/29/2010	05/29/2011
Horn Antenna	Electro-Metrics	EM-6961	103314	05/29/2010	05/29/2011
Horn Antenna	Schwarzbeck	BBHA 9120	D143	05/29/2010	05/29/2011

5.4 Measurement Result

TX mode:

Operation Mode: 2402MHz Test Date : 10/17/2010
 Frequency Range: 30~1000MHz Temperature : 28 °C
 Test Result: PASS Humidity : 65 %
 Measured Distance: 3m Test By: KL

Freq. (MHz)	Ant.Pol. H/V	Emission Level (dBuV)	Limit 3m (dBuV/m)	Margin (dB)	Note
104.4	V	37.38	43.5	-6.12	PK
127.93	V	29.83	46	-16.17	PK
176.12	V	35.16	46	-10.84	PK
239.85	V	29.61	46	-16.39	PK
336.23	V	38.52	46	-7.48	PK
432.61	V	40.04	46	-5.96	PK
104.61	H	37.48	43.5	-6.02	PK
239.85	H	35.6	46	-10.4	PK
336.23	H	43.9	46	-2.1	PK
432.61	H	43.18	46	-2.82	PK
734.18	H	41.96	46	-4.04	PK
801.02	H	39.75	46	-6.25	PK

Note: (1) All Readings are Peak Value.
 (2) Emission Level= Reading Level+Probe Factor +Cable Loss
 (3) The average measurement was not performed when the peak measured data under the limit of average detection.

TX mode:

Operation Mode: 2441MHz Test Date : 10/17/2010
Frequency Range: 30~1000MHz Temperature : 28 °C
Test Result: PASS Humidity : 65 %
Measured Distance: 3m Test By: KL

Freq. (MHz)	Ant.Pol. H/V	Emission Level (dBuV)	Limit 3m (dBuV/m)	Margin (dB)	Note
104.3	V	37.16	43.5	-6.34	PK
127.53	V	28.73	46	-17.27	PK
176.32	V	34.93	46	-11.07	PK
240.98	V	30.61	46	-15.39	PK
336.48	V	39.17	46	-6.83	PK
431.49	V	40.49	46	-5.51	PK
104.49	H	36.83	43.5	-6.67	PK
239.71	H	34.87	46	-11.13	PK
335.67	H	43.73	46	-2.27	PK
431.77	H	43.39	46	-2.61	PK
733.14	H	42.6	46	-3.4	PK
800.15	H	40.1	46	-5.9	PK

- Note:**
- (1) All Readings are Peak Value.
 - (2) Emission Level= Reading Level+Probe Factor +Cable Loss
 - (3) The average measurement was not performed when the peak measured data under the limit of average detection.

TX mode:

Operation Mode: 2480MHz Test Date : 10/17/2010
Frequency Range: 30~1000MHz Temperature : 28 °C
Test Result: PASS Humidity : 65 %
Measured Distance: 3m Test By: KL

Freq. (MHz)	Ant.Pol. H/V	Emission Level (dBuV)	Limit 3m (dBuV/m)	Margin (dB)	Note
104.3	V	37.18	43.5	-6.32	PK
127.53	V	28.33	46	-17.67	PK
176.32	V	34.95	46	-11.05	PK
240.85	V	30.41	46	-15.59	PK
336.48	V	38.96	46	-7.04	PK
431.38	V	40.36	46	-5.64	PK
104.49	H	36.89	43.5	-6.61	PK
239.7	H	34.91	46	-11.09	PK
335.47	H	43.85	46	-2.15	PK
431.77	H	43.39	46	-2.61	PK
733.68	H	42.59	46	-3.41	PK
800.65	H	40.06	46	-5.94	PK

- Note:**
- (1) All Readings are Peak Value.
 - (2) Emission Level= Reading Level+Probe Factor +Cable Loss
 - (3) The average measurement was not performed when the peak measured data under the limit of average detection.

TX mode:

Operation Mode: CH1: 2402MHz Test Date : 10/17/2010
 Frequency Range: 1-25GHz Temperature : 28 °C
 Test Result: PASS Humidity : 65 %
 Measured Distance: 3m Test By: Andy

Freq. (MHz)	Ant.Pol. H/V	Emission Level(dBuV)		Limit 3m(dBuV/m)		Margin(dB)	
		PK	AV	PK	AV	PK	AV
7846.15	V	51.86	39.42	74	54	-22.14	-14.58
10403.84	V	56.46	43.22	74	54	-17.54	-10.78
11288.46	V	54.75	43.82	74	54	-19.25	-10.18
--	V	--	--	74	54	--	--
--	V	--	--	74	54	--	--
9980.76	H	55.95	43.82	74	54	-18.05	-10.18
10923.07	H	56.26	44.34	74	54	-17.74	-9.66
12442.3	H	55.65	42.77	74	54	-18.35	-11.23
--	H	--	--	74	54	--	--
--	H	--	--	74	54	--	--

Other harmonics emissions are lower than 20dB below the allowable limit.

- Note:**
- (1) All Readings are Peak Value and AV.
 - (2) Emission Level= Reading Level + Probe Factor +Cable Loss
 - (3) Data of measurement within this frequency range shown “ -- ” in the table above means the reading of emissions are attenuated more than 20dB below the permissible limits or the field strength is too small to be measured.

TX mode:

Operation Mode: CH40: 2441MHz Test Date : 10/17/2010
 Frequency Range: 1-25GHz Temperature : 28 °C
 Test Result: PASS Humidity : 65 %
 Measured Distance: 3m Test By: Andy

Freq. (MHz)	Ant.Pol. H/V	Emission Level(dBuV)		Limit 3m(dBuV/m)		Margin(dB)	
		PK	AV	PK	AV	PK	AV
7846.1	V	51.56	39.15	74	54	-22.44	-14.85
10405.25	V	56.46	42.21	74	54	-17.54	-11.79
11285.12	V	55.68	44.72	74	54	-18.32	-9.28
--	V	--	--	74	54	--	--
--	V	--	--	74	54	--	--
9980.56	H	55.89	44.12	74	54	-18.11	-9.88
10925.21	H	56.39	44.34	74	54	-17.61	-9.66
12445	H	55.65	42.87	74	54	-18.35	-11.13
--	H	--	--	--	--	--	--
--	H	--	--	--	--	--	--

Other harmonics emissions are lower than 20dB below the allowable limit.

- Note:**
- (1) All Readings are Peak Value and AV.
 - (2) Emission Level= Reading Level+Probe Factor +Cable Loss
 - (3) Data of measurement within this frequency range shown “ -- ” in the table above means the reading of emissions are attenuated more than 20dB below the permissible limits or the field strength is too small to be measured.

TX mode:

Operation Mode: CH79: 2480MHz Test Date : 10/17/2010
 Frequency Range: 1-25GHz Temperature : 28 °C
 Test Result: PASS Humidity : 65 %
 Measured Distance: 3m Test By: Andy

Freq. (MHz)	Ant.Pol. H/V	Emission Level(dBuV)		Limit 3m(dBuV/m)		Margin(dB)	
		PK	AV	PK	AV	PK	AV
7845.02	V	54.36	41.05	74	54	-19.64	-12.95
10405.89	V	55.46	42.36	74	54	-18.54	-11.64
11280.78	V	55.45	43.28	74	54	-18.55	-10.72
--	V	--	--	74	54	--	--
--	V	--	--	74	54	--	--
9980.88	H	55.66	44.25	74	54	-18.34	-9.75
10920.05	H	56.21	44.34	74	54	-17.79	-9.66
12445.27	H	54.87	43.65	74	54	-19.13	-10.35
--	H	--	--	74.00	54.00	--	--
--	H	--	--	74.00	54.00	--	--

Other harmonics emissions are lower than 20dB below the allowable limit.

- Note:**
- (1) All Readings are Peak Value and AV.
 - (2) Emission Level= Reading Level+Probe Factor +Cable Loss
 - (3) Data of measurement within this frequency range shown “ -- ” in the table above means the reading of emissions are attenuated more than 20dB below the permissible limits or the field strength is too small to be measured.

5.5 Radiated Measurement Photos:



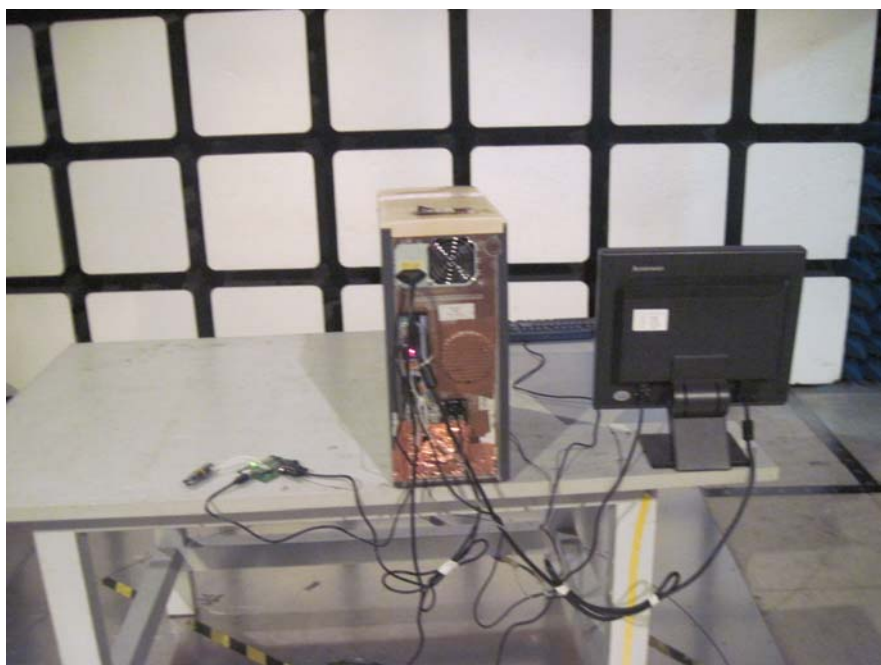

6. Channel Separation test

6.1 Measurement Procedure

The EUT was operating in hopping mode or could be controlled its channel. Printed out the test result from the spectrum by hard copy function.

6.2 Test SET-UP (Block Diagram of Configuration)

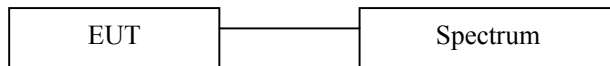

6.3 Measurement Equipment Used:

Same as 4.3 Radiated Emission Measurement.

6.4 Measurement Results:

Refer to attached data chart.

Spectrum Detector:	PK	Test Date :	10/13/2010
Test By:	Andy	Temperature :	28 °C
Test Result:	PASS	Humidity :	65 %

Channel number	Channel frequency (MHz)	Separation Read Value (kHz)	Separation Limit (kHz)
1	2402	1000.00	>775 kHz
40	2441	1000.00	>775 kHz
79	2480	1000.00	>758 kHz

NOTE: For two-third of the 20db bandwidth (page 33) is greater than 25kHz. So the limit of Separation Limit are just as the above table.

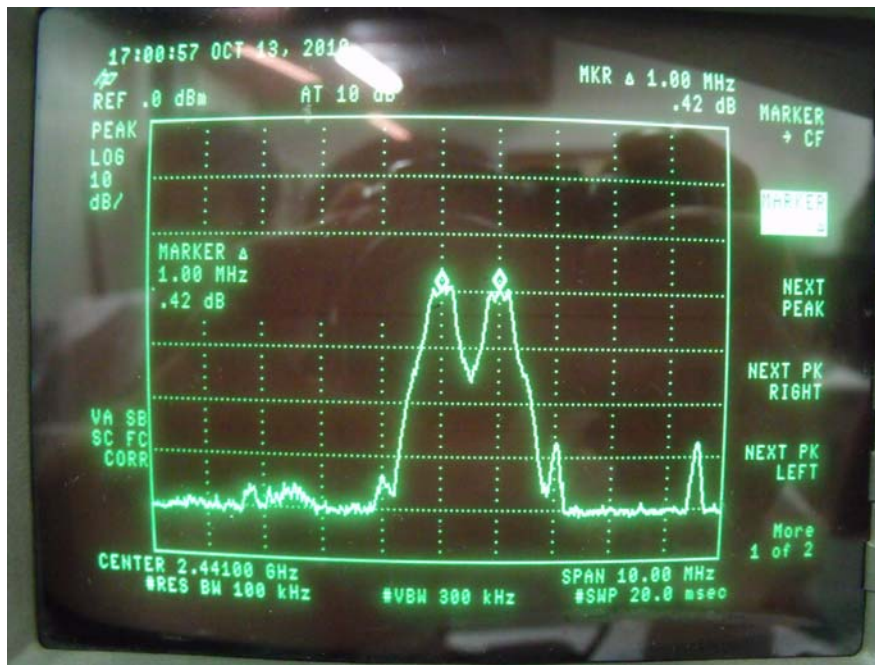
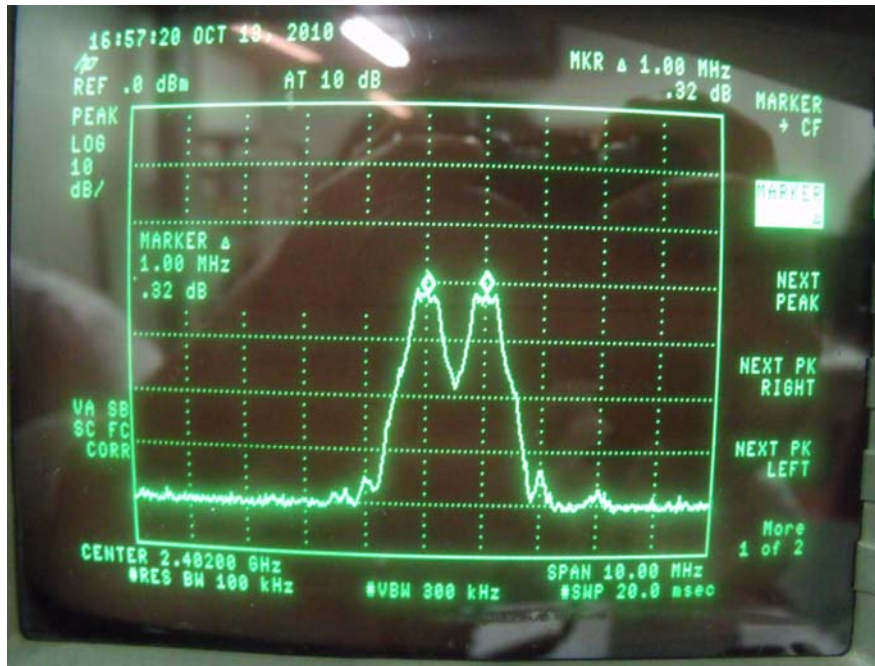

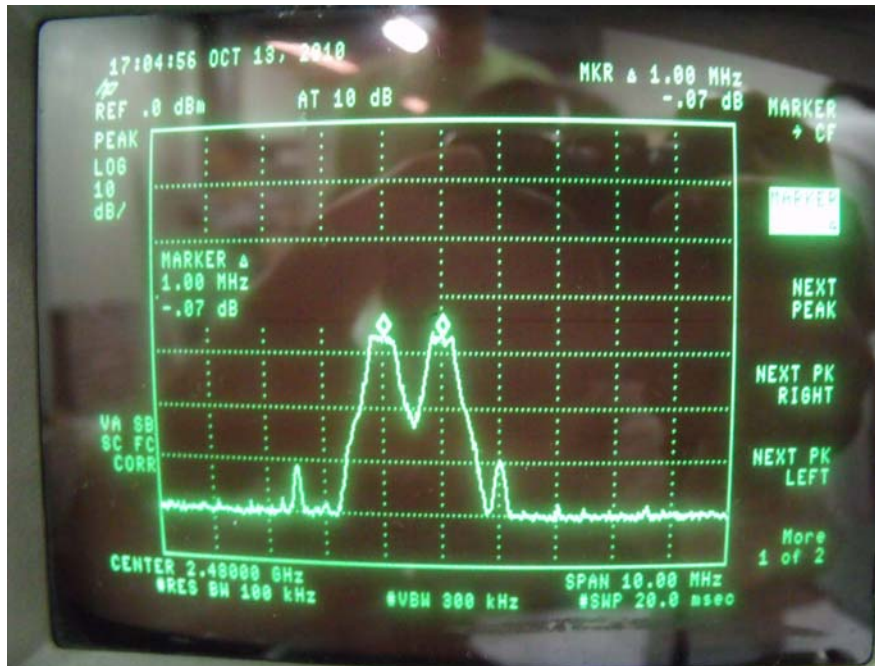

7. Bandwidth test

7.1 Measurement Procedure

The EUT was operating in hopping mode or could be controlled its channel. Printed out the test result from the spectrum by hard copy function.

7.2 Test SET-UP (Block Diagram of Configuration)

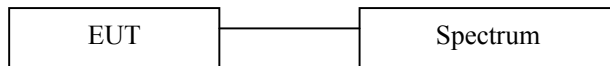

7.3 Measurement Equipment Used:

Same as 4.3 Radiated Emission Measurement.

7.4 Measurement Results:

7.4.1 20dB Bandwidth test data Chart:

Refer to attached data chart.

Spectrum Detector:	PK	Test Date:	10/13/2010
Test By:	Andy	Temperature:	28 °C
Test Result:	PASS	Humidity:	65 %

Channel number	Channel frequency (MHz)	20dB Down BW(kHz)
1	2402	1075
40	2441	1150
79	2480	1113

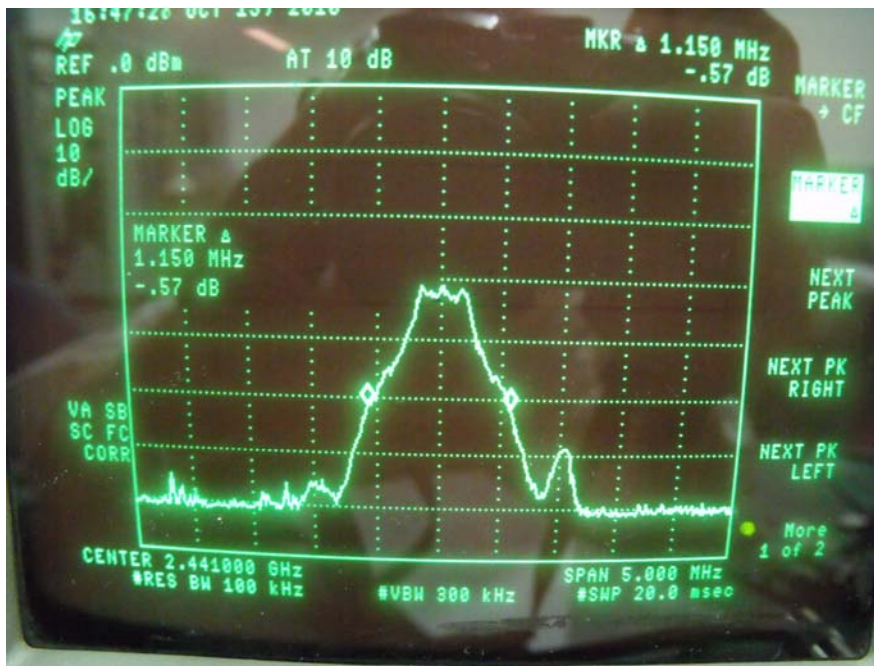
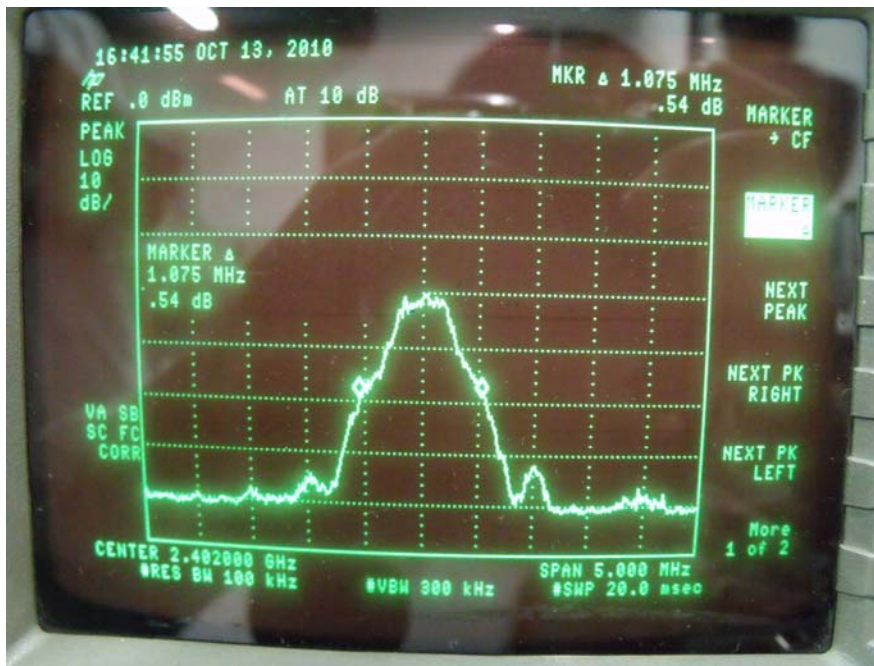

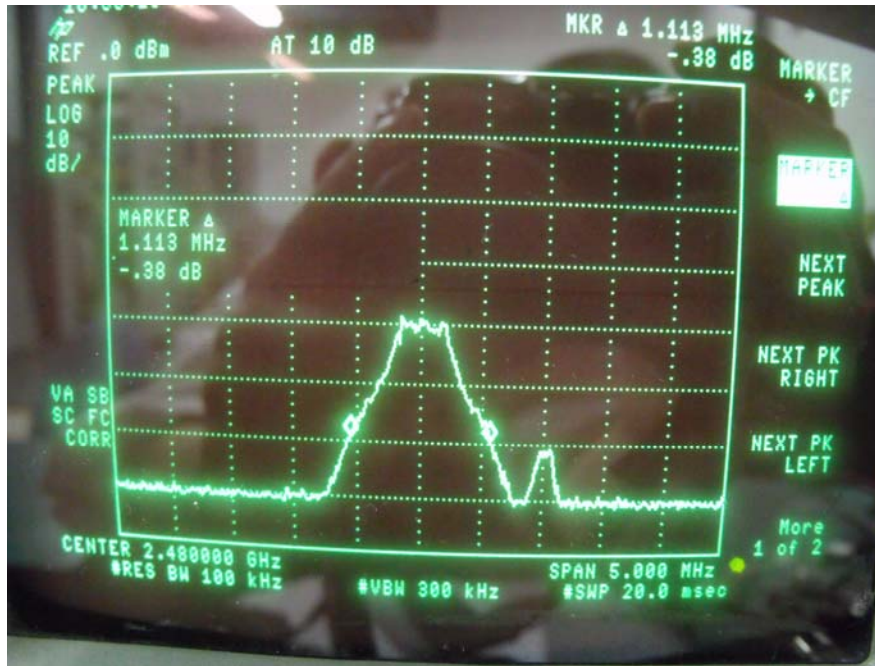

8. Quantity of Hopping Channel Test

8.1 Measurement Procedure

The EUT was operating in hopping mode or could be controlled its channel. Printed out the test result from the spectrum by hard copy function.

8.2 Test SET-UP (Block Diagram of Configuration)

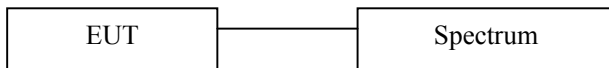

8.3 Measurement Equipment Used:

Same as 4.3 Radiated Emission Measurement.

8.4 Measurement Results:

Refer to attached data chart.

Spectrum Detector:	PK	Test Date :	10/13/2010
Test By:	Andy	Temperature :	28 °C
Test Result:	PASS	Humidity :	65 %

Hopping Channel Frequency Range	Quantity of Hopping Channel	Quantity of Hopping Channel
2402-2480	79	79

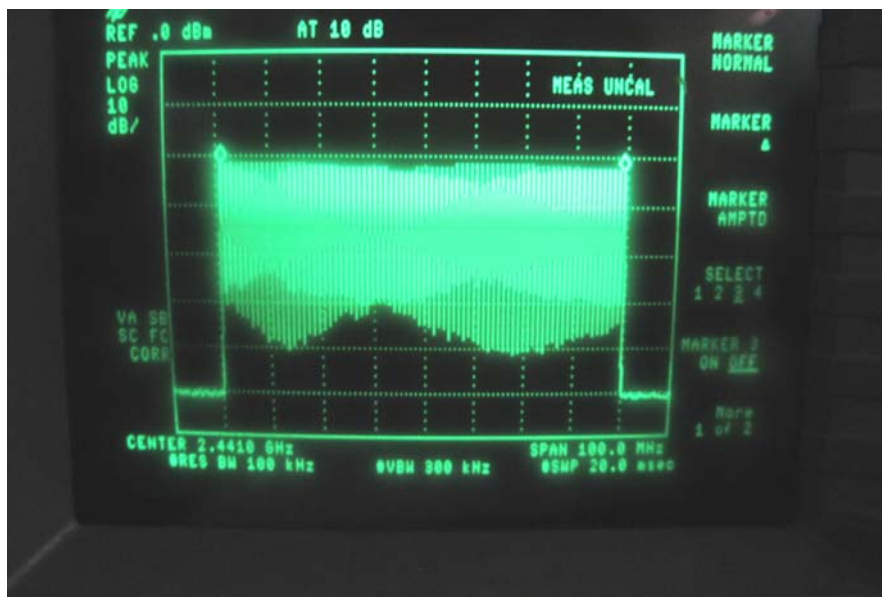

9. Time of Occupancy (Dwell Time) test

9.1 Measurement Procedure

- a. Check the calibration of the measuring instrument(SA) using either an internal calibrator or a known signal from an external generator.
- b. Turn on the EUT and connect its antenna terminal to measurement via a low loss cable. Then set it to any one measured frequency within its operating range and make sure the instrument is operated in its linear range.
- c. Adjust the center frequency of SA on any frequency be measured and set SA to zero span mode. And then, set RBW and VBW of spectrum analyzer to proper value.
- d. Measure the time duration of one transmission on the measured frequency. And then plot the result with time difference of this time duration.
- e. Repeat above procedures until all different time-slot modes have been completed.

9.2 Test SET-UP (Block Diagram of Configuration)

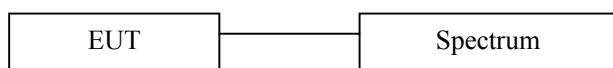

9.3 Measurement Equipment Used:

Same as 4.3 Radiated Emission Measurement.

9.4 Measurement Results:

Refer to attached data chart.

Spectrum Detector:	PK	Test Date :	10/13/2010
Test By:	Andy	Temperature :	28 °C
Test Result:	PASS	Humidity :	65 %

Mode	Number of transmission in a 31.6(79 Hopping*0.4)	Length of transmissions time(msec)	Result (msec)	Limit (msec)
DH1	51(times/5 sec)*6.32=322.32 times	0.435	140.2092	400
DH3	26(times/5 sec)*6.32=164.32 times	0.862	141.6438	400
DH5	15(times/5 sec)*6.32=94.80 times	1.01	95.748	400

DH1

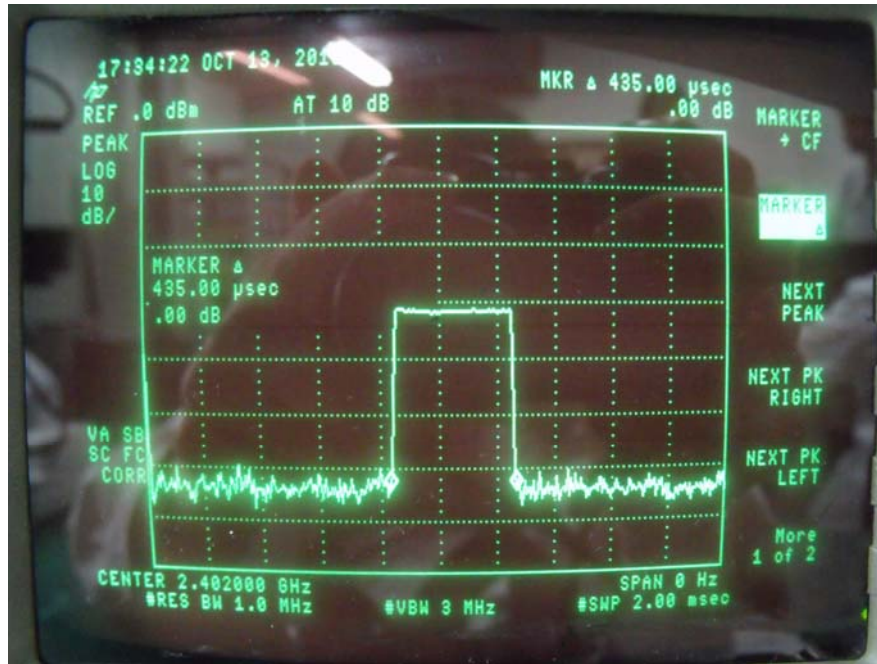

DH3

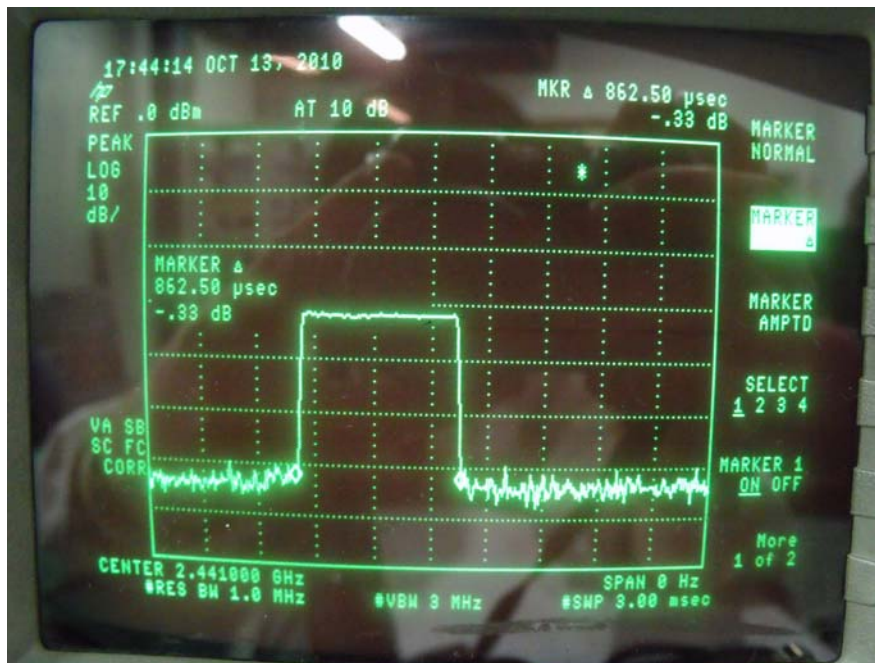

DH5

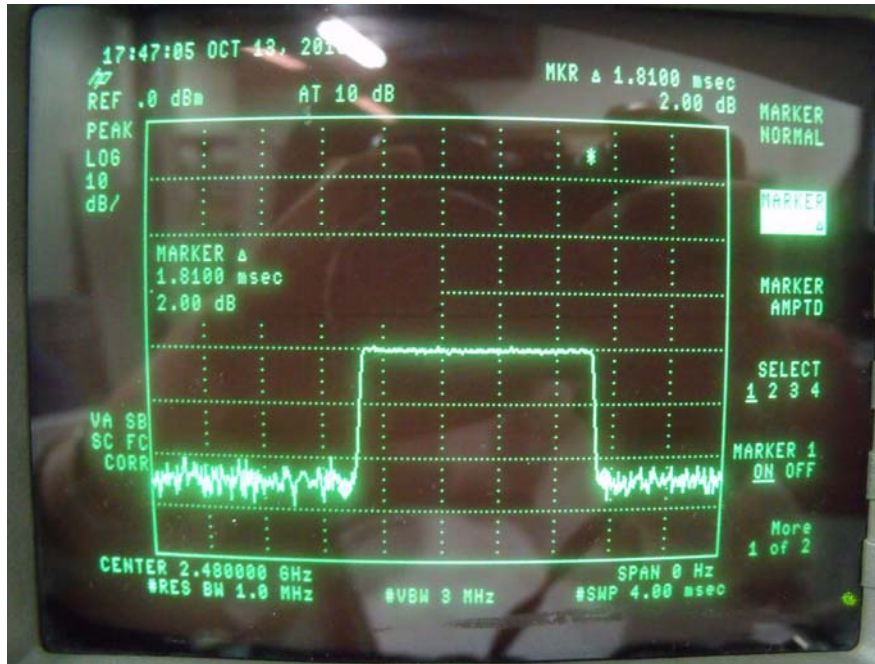

10. MAXIMUM PEAK OUTPUT POWER TEST

10.1 Measurement Procedure

- a. Check the calibration of the measuring instrument(SA) using either an internal calibrator or a known signal from an external generator.
- b. Turn on the EUT and connect it to measurement instrument. Then set it to any one convenient frequency within its operating range. Set a reference level on the measuring instrument equal to the highest peak value.
- c. The center frequency of the spectrum analyzer is set to the fundamental frequency and using proper RBW and VBW setting.
- d. Measure the captured power within the band and recording the plot.
- e. Repeat above procedures until all frequencies required were complete.

10.2 Test SET-UP (Block Diagram of Configuration)

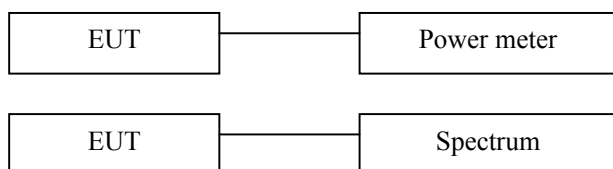

10.3 Measurement Equipment Used:

EQUIPMENT TYPE	MFR	MODEL NUMBER	SERIAL NUMBER	LAST CAL.	CAL DUE.
Spectrum Analyzer	Rohde & Schwarz	FSP7	839511/010	05/29/2010	05/29/2011
Power meter	Boonton	4232A	29001	05/29/2010	05/29/2011
Power sensor	Boonton	51011-EMC	31184	05/29/2010	05/29/2011

10.4 Measurement Results:

Refer to attached data chart.

Spectrum Detector:	PK	Test Date :	10/17/2010
Test By:	Andy	Temperature :	28 °C
Test Result:	PASS	Humidity :	65 %

Channel number	Channel Frequency (MHz)	Peak Power output(dBm)	Peak Power output(mW)	Peak Power Limit(mW)	Pass/Fail
1	2401.00	-1.89	0.64	125	PASS
40	2440.00	-2.13	0.61	125	PASS
79	2480.00	-2.05	0.62	125	PASS

11. Band EDGE test

11.1 Measurement Procedure

1. The EUT was Operating in hopping mode or could be controlled its channel. Printed out test result from the spectrum by hard copy function.
2. The EUT was placed on a turn table which is 0.8m above ground plane.
3. Maximum procedure was performed on the six highest emissions to ensure EUT compliance.
4. And also, each emission was to be maximized by changing the polarization of receiving antenna both horizontal and vertical.
5. Repeat above procedures until all frequency measured were complete.

11.2 Test SET-UP (Block Diagram of Configuration)

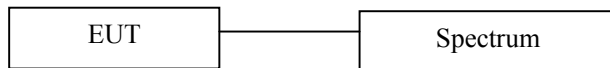

11.3 Measurement Equipment Used:

Same as 4.3 Radiated Emission Measurement.

11.4 Measurement Results:

Refer to attached data chart.

Spectrum Detector:	PK	Test Date :	10/17/2010
Test By:	Andy	Temperature :	28 °C
Test Result:	PASS	Humidity :	65 %

1. Conducted Test

Frequency (MHz)	Peak Power Output(dBm)	Emission read Value(dBm)	Result of Band edge(dBc)	Band edge Limit(dBc)
<2400	-37.84	-70.26	32.42	>20dBc
>2483.5	-42.5	-70.29	27.79	>20dBc

2. Radiated emission test

Frequency (MHz)	Antenna polarization (H/V)	Emission (dBuV/m)		Band edge Limit (dBuV/m)	
		QP	AV	QP	AV
<2400	V	56.22	43.18	74.00	54.00
>2483.5	V	55.78	41.29	74.00	54.00

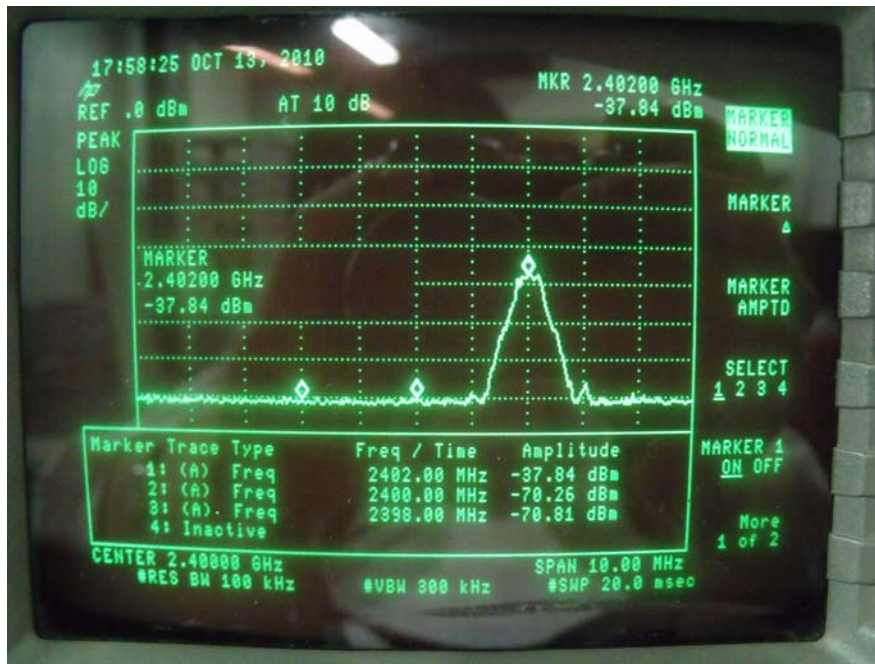

12. Antenna Port Emission

12.1 Test Equipment

EQUIPMENT TYPE	MFR	MODEL NUMBER	SERIAL NUMBER	LAST CAL.	CAL DUE.
EMI Test Receiver	Rohde & Schwarz	ESU	1302.6005.26	05/29/2010	05/29/2011

12.2 Measuring Instruments and setting

The following table is the setting of spectrum analyzer.

Spectrum analyzer	Setting
Attenuation	Auto
RB	100kHz
VB	300kHz
Detector	Peak
Trace	Max hold

12.3 Test Procedures

The conducted spurious emissions were measured conducted using a spectrum analyzer at low, mid, and hi channels, The limit was determined by attenuation 20dB of the RF peak power output.

12.4 Block Diagram of Test setup

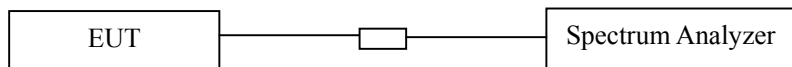

12.5. Test Result

PASS.

