

**FCC 47 CFR PART 15 SUBPART C**

**CERTIFICATION TEST REPORT**

*For*

**nextbook**

**MODEL No.: NXA116QC164, NXW116QC264**

**FCC ID: S7JNXA116QC164**

**Trade Mark: N/A**

**REPORT NO: ES141227345E3-1**

**ISSUE DATE: March 30, 2015**

*Prepared for*

**SHENZHEN YIFANG DIGITAL TECHNOLOGY CO.,LTD.  
Building NO.22,23,Fifth Region, Baiwangxin Industrial Park ,Songbai Rd.,  
Nanshan, Shenzhen 518108,China**

*Prepared by*

**SHENZHEN EMTEK CO., LTD.**

**Bldg 69, Majialong Industry Zone, Nanshan District, Shenzhen,  
Guangdong, China  
TEL: 86-755-26954280  
FAX: 86-755-26954282**

**Table of Contents**

**1 TEST RESULT CERTIFICATION..... 3**

**2 EUT TECHNICAL DESCRIPTION ..... 4**

**3 SUMMARY OF TEST RESULT ..... 6**

**4 TEST METHODOLOGY ..... 7**

4.1 GENERAL DESCRIPTION OF APPLIED STANDARDS ..... 7

4.2 MEASUREMENT EQUIPMENT USED..... 7

4.3 DESCRIPTION OF TEST MODES ..... 8

**5 FACILITIES AND ACCREDITATIONS ..... 9**

5.1 FACILITIES ..... 9

5.2 LABORATORY ACCREDITATIONS AND LISTINGS..... 9

**6 TEST SYSTEM UNCERTAINTY ..... 10**

**7 SETUP OF EQUIPMENT UNDER TEST ..... 11**

7.1 RADIO FREQUENCY TEST SETUP 1 ..... 11

7.2 RADIO FREQUENCY TEST SETUP 2 ..... 11

7.3 CONDUCTED EMISSION TEST SETUP ..... 12

7.4 SUPPORT EQUIPMENT ..... 12

**8 TEST REQUIREMENTS..... 13**

8.1 DTS 6DB BANDWIDTH ..... 13

8.2 MAXIMUM PEAK CONDUCTED OUTPUT POWER ..... 16

8.3 MAXIMUM POWER SPECTRAL DENSITY ..... 19

8.4 UNWANTED EMISSIONS IN NON-RESTRICTED FREQUENCY BANDS ..... 22

8.5 RADIATED SPURIOUS EMISSION ..... 27

8.6 CONDUCTED EMISSIONS TEST..... 51

8.7 ANTENNA APPLICATION..... 58

**1 TEST RESULT CERTIFICATION**

Applicant:	SHENZHEN YIFANG DIGITAL TECHNOLOGY CO.,LTD.
Manufacturer:	SHENZHEN YIFANG DIGITAL TECHNOLOGY CO.,LTD.
Product Description:	nextbook
Model Number:	NXA116QC164, NXW116QC264 (Note: These models are identical in circuitry and electrical, mechanical and physical construction; the only differences are the silk-screen, color and model no. for trading purpose. We prepare NXA116QC164 for test, and the worst result recorded in the report.)
File Number:	ES141227345E3-1
Date of Test:	December 29, 2014 to January 29, 2015 March 16, 2015 to March 30, 2015

Measurement Procedure Used:

APPLICABLE STANDARDS	
STANDARD	TEST RESULT
FCC 47 CFR Part 2, Subpart J FCC 47 CFR Part 15, Subpart C	PASS

The above equipment was tested by SHENZHEN EMTEK CO., LTD. The test data, data evaluation, test procedures, and equipment configurations shown in this report were made in accordance with the procedures given in ANSI C63.4 (2009) and the energy emitted by the sample EUT tested as described in this report is in compliance with the requirements of FCC Rules Part 2 and Part 15.247

The test results of this report relate only to the tested sample identified in this report

Date of Test : December 29, 2014 to January 29, 2015  
March 16, 2015 to March 30, 2015

---

Prepared by : *Yaping Shen*  
Yaping Shen/Editor

---

Reviewer : *Joe Xia*  
Joe Xia/Supervisor

---

Approve & Authorized Signer : *[Signature]*  
Lisa Wang/Manager

## 2 EUT TECHNICAL DESCRIPTION

Characteristics	Description
<b>IEEE 802.11 WLAN Mode Supported</b>	<input checked="" type="checkbox"/> 802.11b <input checked="" type="checkbox"/> 802.11g <input checked="" type="checkbox"/> 802.11n(20MHz channel bandwidth) <input checked="" type="checkbox"/> 802.11n(40MHz channel bandwidth)
<b>Bluetooth</b>	Bluetooth V4.0
<b>Data Rate</b>	WIFI: 802.11 b:1,2,5.5,11Mbps; 802.11 g:6,9,12,18,24,36,48,54Mbps; 802.11n(HT20):MCS0-MCS7; 802.11n(HT40):MCS0-MCS7; Bluetooth: 1Mbps
<b>Modulation</b>	WIFI: DSSS with DBPSK/DQPSK/CCK for 802.11b; OFDM with BPSK/QPSK/16QAM/64QAM for 802.11g/n; Bluetooth: GFSK
<b>Operating Frequency Range</b>	WIFI: 2412-2462MHz for 802.11b/g; 2412-2462MHz for 802.11n(HT20); 2422-2452MHz for 802.11n(HT40); Bluetooth: 2402-2480MHz
<b>Number of Channels</b>	WIFI: 11 channels for 802.11b/g; 11 channels for 802.11n(HT20); 7 channels for 802.11n(HT40); Bluetooth: 40 Channels
<b>Transmit Power Max</b>	WIFI: 9.47dBm for 802.11b; 8.81dBm for 802.11g; 8.14dBm for 802.11n(HT20); 7.80dBm for 802.11n(HT40); Bluetooth: -0.13dBm
<b>Antenna Type</b>	Integral Antenna
<b>Antenna Gain</b>	2.0dBi
<b>Power supply</b>	<input checked="" type="checkbox"/> DC supply: DC 3.7V by Battery
	<input checked="" type="checkbox"/> Adapter supply: Adapter 1: Model: PS18C050K3000UD Input:100-240~ 50/60 0.5A Max Output: DC 5V 3A Adapter 2: Model: TEKA018-0503000XX Input:100-240~ 50/60 0.5A Max Output: DC 5V 3A Adapter 3: Model: TEKA018-0502500UK Input:100-240~ 50/60 0.5A Max Output: DC 5V 2.5A
<b>Temperature Range</b>	-20°C ~ +55°C

**Note:** for more details, please refer to the User's manual of the EUT.

## Modified Information

Ver.	Report No.	Date of Rev.	Summary
Ver 1.0	ES141227345E3	/	Original Report
Ver 1.1	ES141227345E3-1	March 30, 2015	Add Adapter Add model number

### 3 SUMMARY OF TEST RESULT

FCC Part Clause	Test Parameter	Verdict	Remark
15.247(a)(2)	DTS (6dB) Bandwidth	PASS	
15.247(b)(3)	Maximum Peak Conducted Output Power	PASS	
15.247(e)	Maximum Power Spectral Density Level	PASS	
15.247(d)	Unwanted Emission Into Non-Restricted Frequency Bands	PASS	
15.247(d) 15.209	Unwanted Emission Into Restricted Frequency Bands (conducted)	PASS	
15.247(d) 15.209	Radiated Spurious Emission	PASS	
15.207	Conducted Emission Test	PASS	Note 3
15.247(b)	Antenna Application	PASS	Note 3
NOTE1: N/A (Not Applicable) NOTE2: According to FCC OET KDB 558074, the report use radiated measurements in the restricted frequency bands. In addition, the radiated test is also performed to ensure the emissions emanating from the device cabinet also comply with the applicable limits. NOTE 3: Original test data for adapter 1 and 2, also adding test result for adapter 3			

RELATED SUBMITTAL(S) / GRANT(S):

This submittal(s) (test report) is intended for FCC ID: S7JNXA116QC164 filing to comply with Section 15.247 of the FCC Part 15, Subpart C Rules.

## 4 TEST METHODOLOGY

### 4.1 GENERAL DESCRIPTION OF APPLIED STANDARDS

According to its specifications, the EUT must comply with the requirements of the following standards:

FCC 47 CFR Part 2, Subpart J

FCC 47 CFR Part 15, Subpart C

FCC KDB 558074 D01 DTS Meas Guidance v03r02

FCC KDB 662911 D01 Multiple Transmitter Output v01

FCC KDB 662911 D02 MIMO With Cross Polarized Antenna V01

### 4.2 MEASUREMENT EQUIPMENT USED

#### 4.2.1 Conducted Emission Test Equipment

EQUIPMENT TYPE	MFR	MODEL NUMBER	SERIAL NUMBER	LAST CAL.
Test Receiver	Rohde & Schwarz	ESCS30	828985/018	05/17/2014
L.I.S.N.	Schwarzbeck	NNLK8129	8129203	05/17/2014
50Ω Coaxial Switch	Anritsu	MP59B	M20531	N/A
Pulse Limiter	Rohde & Schwarz	ESH3-Z2	100006	05/17/2014
Voltage Probe	Rohde & Schwarz	TK9416	N/A	05/17/2014
I.S.N	Rohde & Schwarz	ENY22	1109.9508.02	05/17/2014

#### 4.2.2 Radiated Emission Test Equipment

EQUIPMENT TYPE	MFR	MODEL NUMBER	SERIAL NUMBER	LAST CAL.
EMI Test Receiver	Rohde & Schwarz	ESU	1302.6005.26	05/17/2014
Pre-Amplifier	HP	8447D	2944A07999	05/17/2014
Bilog Antenna	Schwarzbeck	VULB9163	142	05/17/2014
Loop Antenna	ARA	PLA-1030/B	1029	05/17/2014
Horn Antenna	Schwarzbeck	BBHA 9170	BBHA9170399	05/17/2014
Horn Antenna	Schwarzbeck	BBHA 9120	D143	05/17/2014
Cable	Schwarzbeck	AK9513	ACRX1	05/17/2014
Cable	Rosenberger	N/A	FP2RX2	05/17/2014
Cable	Schwarzbeck	AK9513	CRPX1	05/17/2014
Cable	Schwarzbeck	AK9513	CRRX2	05/17/2014

#### 4.2.3 Radio Frequency Test Equipment

EQUIPMENT TYPE	MFR	MODEL NUMBER	SERIAL NUMBER	LAST CAL.
Spectrum Analyzer	Agilent	E4407B	88156318	05/17/2014
Power meter	Anritsu	ML2495A	0824006	05/17/2014
Power sensor	Anritsu	MA2411B	0738172	05/17/2014

**Remark:** Each piece of equipment is scheduled for calibration once a year.

### 4.3 DESCRIPTION OF TEST MODES

The EUT has been tested under its typical operating condition.

The EUT configuration for testing is installed on RF field strength measurement to meet the Commissions requirement and operating in a manner which intends to maximize its emission characteristics in a continuous normal application.

The Transmitter was operated in the normal operating mode. The TX frequency was fixed which was for the purpose of the measurements.

Test of channel included the lowest and middle and highest frequency to perform the test, then record on this report.

Those data rates (Bluetooth 4.0 DTS :1Mbps) were used for all test.

Pre-defined engineering program for regulatory testing used to control the EUT for staying in continuous transmitting and receiving mode is programmed.

Frequency and Channel list for Bluetooth 4.0 DTS:

Channel	Frequency (MHz)	Channel	Frequency (MHz)	Channel	Frequency (MHz)
0	2402	19	2440	...	...
1	2404	20	2442	37	2476
2	2406	21	2444	38	2478
...	...	...	...	39	2480
Note: $f_c = 2402\text{MHz} + k \times 1\text{MHz}$ $k = 1$ to $39$					

Test Frequency and channel for Bluetooth 4.0 DTS:

Lowest Frequency		Middle Frequency		Highest Frequency	
Channel	Frequency (MHz)	Channel	Frequency (MHz)	Channel	Frequency (MHz)
0	2402	19	2440	39	2480



## 5 FACILITIES AND ACCREDITATIONS

### 5.1 FACILITIES

All measurement facilities used to collect the measurement data are located at

Bldg 69, Majialong Industry Zone District, Nanshan District, Shenzhen, China

The sites are constructed in conformance with the requirements of ANSI C63.7, ANSI C63.4 and CISPR Publication 22.

### 5.2 LABORATORY ACCREDITATIONS AND LISTINGS

Site Description

- EMC Lab.
- : Accredited by CNAS, 2013.10.28  
The certificate is valid until 2016.10.29  
The Laboratory has been assessed and proved to be in compliance with CNAS-CL01: 2006(identical to ISO/IEC17025: 2005)  
The Certificate Registration Number is L229
  - : Accredited by TUV Rheinland Shenzhen, 2010.5.25  
The Laboratory has been assessed according to the requirements ISO/IEC 17025.
  - : Accredited by FCC, October 28, 2010  
The Certificate Registration Number is 406365.
  - : Accredited by FCC, February 28, 2013  
The Certificate Registration Number is 709623.
  - : Accredited by Industry Canada, May 24, 2008  
The Certificate Registration Number is 4480A-2

## 6 TEST SYSTEM UNCERTAINTY

The following measurement uncertainty levels have been estimated for tests performed on the apparatus:

Parameter	Uncertainty
Radio Frequency	$\pm 1 \times 10^{-5}$
Maximum Peak Output Power Test	$\pm 1.0\text{dB}$
Conducted Emissions Test	$\pm 2.0\text{dB}$
Radiated Emission Test	$\pm 2.0\text{dB}$
Power Density	$\pm 2.0\text{dB}$
Occupied Bandwidth Test	$\pm 1.0\text{dB}$
Band Edge Test	$\pm 3\text{dB}$
All emission, radiated	$\pm 3\text{dB}$
Antenna Port Emission	$\pm 3\text{dB}$
Temperature	$\pm 0.5^\circ\text{C}$
Humidity	$\pm 3\%$

Measurement Uncertainty for a level of Confidence of 95%

## 7 SETUP OF EQUIPMENT UNDER TEST

### 7.1 RADIO FREQUENCY TEST SETUP 1

The Bluetooth 4.0 DTS component's antenna ports(s) of the EUT are connected to the measurement instrument per an appropriate attenuator. The EUT is controlled by PC/software to emit the specified signals for the purpose of measurements.

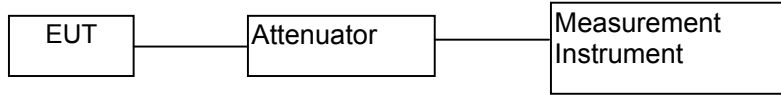

### 7.2 RADIO FREQUENCY TEST SETUP 2

The test site semi-anechoic chamber has met the requirement of NSA tolerance 4 dB according to the standards: ANSI C63.4. The test distance is 3m. The setup is according to the requirements in Section 13.1.4.1 of ANSI C63.4-2009 and CAN/CSA-CEI/IEC CISPR 22.

Below 30MHz:

The EUT is placed on a turntable 0.8 meters above the ground in the chamber, 3 meter away from the antenna (loop antenna). The Antenna should be positioned with its plane vertical at the specified distance from the EUT and rotated about its vertical axis for maximum response at each azimuth about the EUT. The center of the loop shall be 1 m above the ground. For certain applications, the loop antenna plane may also need to be positioned horizontally at the specified distance from the EUT.

Above 1GHz:

The EUT is placed on a turntable 0.8 meters above the ground in the chamber, 3 meter away from the antenna. The maximal emission value is acquired by adjusting the antenna height, polarisation and turntable azimuth. Normally, the height range of antenna is 1 m to 4 m, the azimuth range of turntable is 0° to 360°, and the receive antenna has two polarizations Vertical (V) and Horizontal (H).

(a) Radiated Emission Test Set-Up, Frequency Below 30MHz

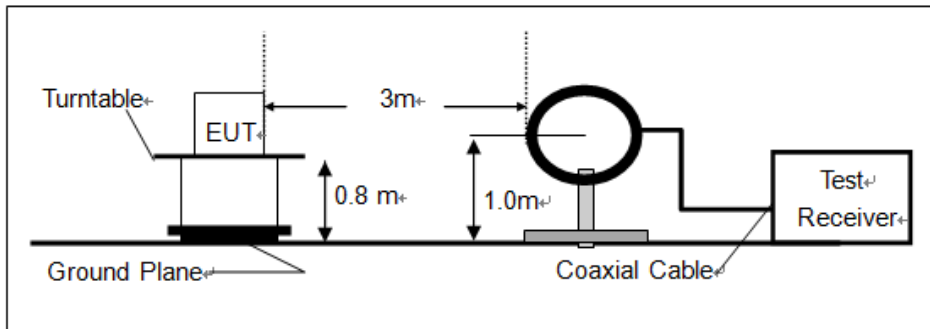

(b) Radiated Emission Test Set-Up, Frequency Below 1000MHz

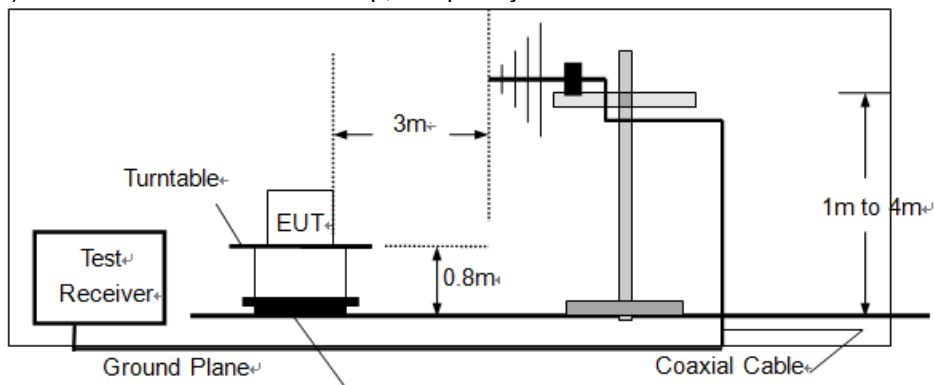

(c) Radiated Emission Test Set-Up, Frequency above 1000MHz

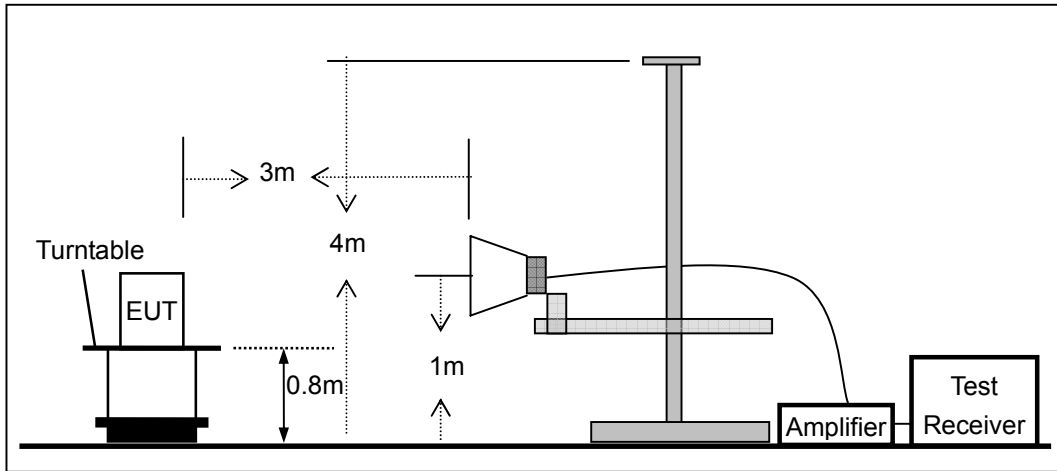

**7.3 CONDUCTED EMISSION TEST SETUP**

The mains cable of the EUT (maybe per AC/DC Adapter) must be connected to LISN. The LISN shall be placed 0.8 m from the boundary of EUT and bonded to a ground reference plane for LISN mounted on top of the ground reference plane. This distance is between the closest points of the LISN and the EUT. All other units of the EUT and associated equipment shall be at least 0.8m from the LISN.

Ground connections, where required for safety purposes, shall be connected to the reference ground point of the LISN and, where not otherwise provided or specified by the manufacturer, shall be of same length as the mains cable and run parallel to the mains connection at a separation distance of not more than 0.1 m.

According to the requirements in Section 13.1.4.1 of ANSI C63.4-2009 Conducted emissions from the EUT measured in the frequency range between 0.15 MHz and 30 MHz using CISPR Quasi-Peak and average detector mode.

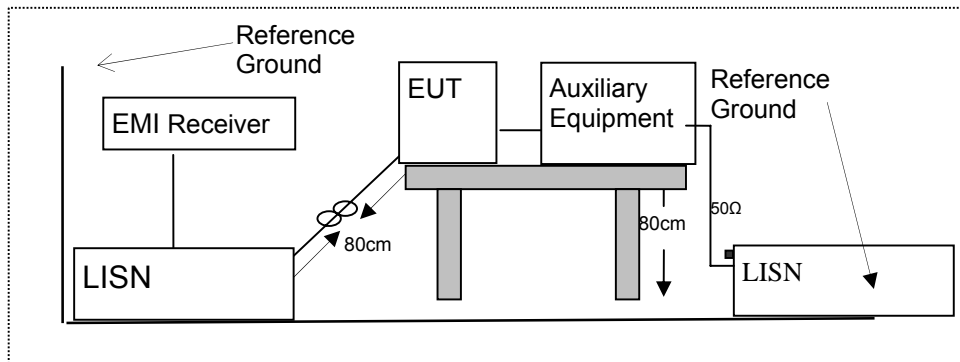

**7.4 SUPPORT EQUIPMENT**

Item	Equipment	Mfr/Brand	Model/Type No.	FCC ID	Series No.	Note
1.	N/A	N/A	N/A	N/A	N/A	N/A

**Notes:**

1. All the equipment/cables were placed in the worst-case configuration to maximize the emission during the test.
2. Grounding was established in accordance with the manufacturer's requirements and conditions for the intended use.

## 8 TEST REQUIREMENTS

### 8.1 DTS 6DB BANDWIDTH

#### 8.1.1 Applicable Standard

According to FCC Part 15.247(a)(2) and KDB 558074 DTS 01 Meas. Guidance v03r02

#### 8.1.2 Conformance Limit

The minimum -6 dB bandwidth shall be at least 500 kHz.

#### 8.1.3 Test Configuration

Test according to clause 7.1 radio frequency test setup 1

#### 8.1.4 Test Procedure

The EUT was operating in Bluetooth 4.0DTS mode and controlled its channel. Printed out the test result from the spectrum by hard copy function.

The RF output of EUT was connected to the spectrum analyzer by RF cable and attenuator. The path loss was compensated to the results for each measurement.

Set to the maximum power setting and enable the EUT transmit continuously

Set RBW = 100 kHz.

Set the video bandwidth (VBW) =300 kHz.

Set Span=2 times OBW

Set Detector = Peak.

Set Trace mode = max hold.

Set Sweep = auto couple.

Allow the trace to stabilize.

Measure the maximum width of the emission that is constrained by the frequencies associated with the two outermost amplitude points (upper and lower frequencies) that are attenuated by 6 dB relative to the maximum level measured in the fundamental emission.

Measure and record the results in the test report.

### Test Results

Temperature : 28°C      Test Date : January 04, 2014  
Humidity : 55 %      Test By: KK

Operation Mode	Channel Number	Channel Frequency (MHz)	Measurement Bandwidth (kHz)	Limit (kHz)	Verdict
Bluetooth 4.0DTS	0	2402	795.855	>500	PASS
	19	2440	793.286	>500	PASS
	39	2480	792.705	>500	PASS

Test Model	DTS (6dB) Bandwidth Bluetooth4.0DTS Channel 0: 2402MHz
------------	--------------------------------------------------------------

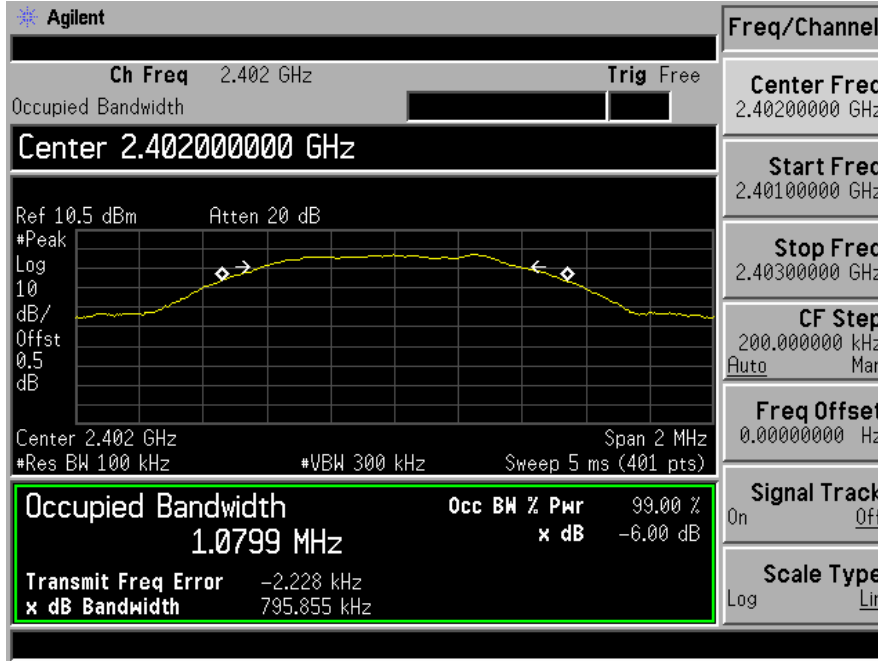

Test Model	DTS (6dB) Bandwidth Bluetooth4.0DTS Channel 19: 2440MHz
------------	---------------------------------------------------------------

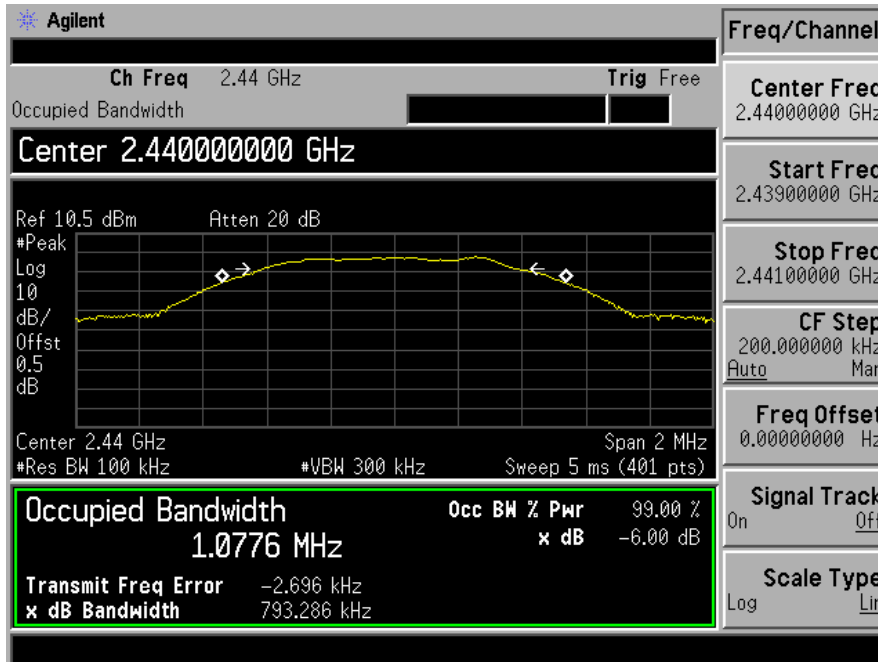

Test Model	DTS (6dB) Bandwidth Bluetooth4.0DTS Channel 39: 2480MHz
------------	---------------------------------------------------------------

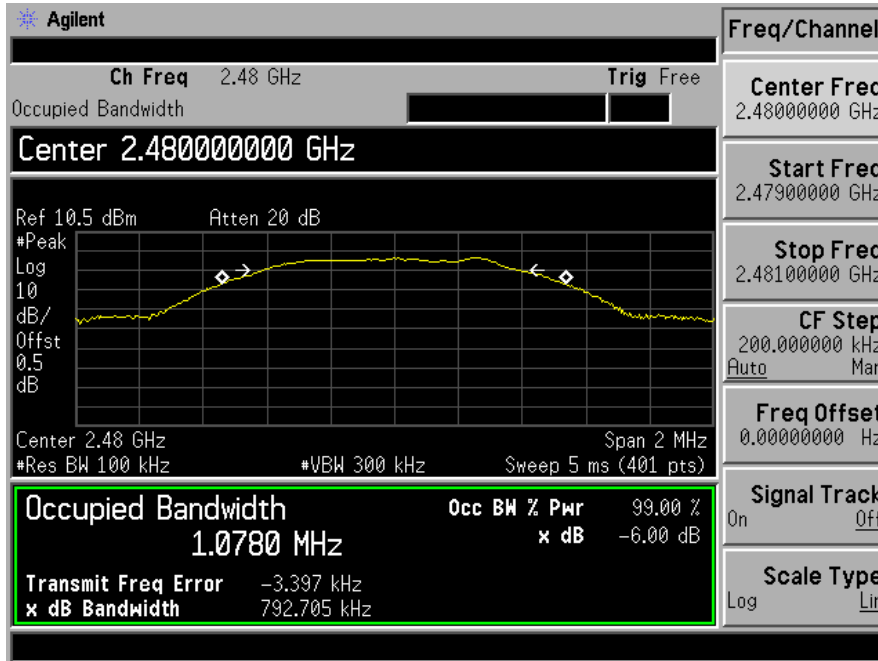

**8.2 MAXIMUM PEAK CONDUCTED OUTPUT POWER**

**8.2.1 Applicable Standard**

According to FCC Part 15.247(b)(3) and KDB 558074 DTS 01 Meas. Guidance v03r02

**8.2.2 Conformance Limit**

The maximum peak conducted output power of the intentional radiator for systems using digital modulation in the 2400 - 2483.5 MHz bands shall not exceed: 1 Watt (30dBm).

**8.2.3 Test Configuration**

Test according to clause 7.1 radio frequency test setup 1

**8.2.4 Test Procedure**

- According to FCC Part 15.247(b)(3)

As an alternative to a peak power measurement, compliance with the one Watt limit can be based on a measurement of the maximum conducted output power. For smart system, Maximum Conducted Output Power is defined as the total transmit power delivered to all antennas and antenna elements averaged across all symbols in the signaling alphabet when the transmitter is operating at its maximum power control level. Power must be summed across all antennas and antenna elements. If multiple modes of operation are possible (e.g., alternative modulation methods), the maximum conducted output power is the highest total transmit power occurring in any mode.

Set the RBW  $\cong$  DTS bandwidth (about 1MHz). Set VBW = 3\*RBW (about 3MHz)

Set the span  $\cong$  3\*RBW

Set Sweep time = auto couple.

Set Detector = peak. Set Trace mode = max hold.

Allow trace to fully stabilize. Use peak marker function to determine the peak amplitude level.

- According to FCC Part 15.247(b)(4):

Conducted output power limit specified in paragraph (b) of this section is based on the use of antennas with directional gains that do not exceed 6 dBi. If transmitting antennas of directional gain greater than 6 dBi are used, the conducted output power from the intentional radiator shall be reduced below the stated values in paragraphs (b)(3) of this section, as appropriate, by the amount in dB that the directional gain of the antenna exceeds 6 dBi.

**Test Results**

Temperature : 28°C      Test Date : January 04, 2014  
 Humidity : 55 %      Test By: KK

Operation Mode	Channel Number	Channel Frequency (MHz)	Measurement Level (dBm)	Limit (dBm)	Verdict
Bluetooth 4.0DTS	0	2402	-0.928	30	PASS
	19	2440	-0.130	30	PASS
	39	2480	-1.395	30	PASS



Test Model	Maximum Conducted Output Power Bluetooth4.0DTS Channel 0: 2402MHz
------------	-------------------------------------------------------------------------

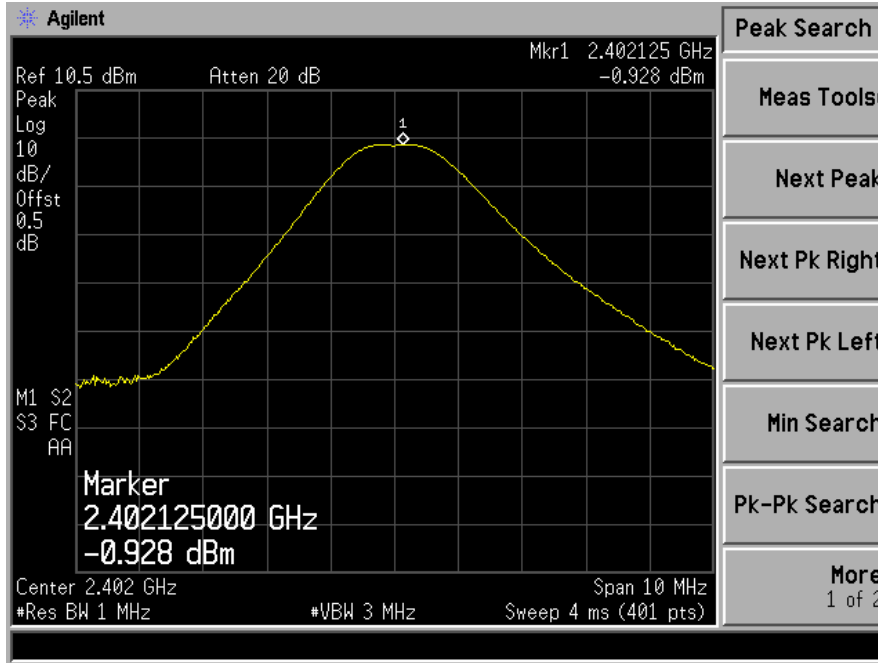

Test Model	Maximum Conducted Output Power Bluetooth4.0DTS Channel 19: 2440MHz
------------	--------------------------------------------------------------------------

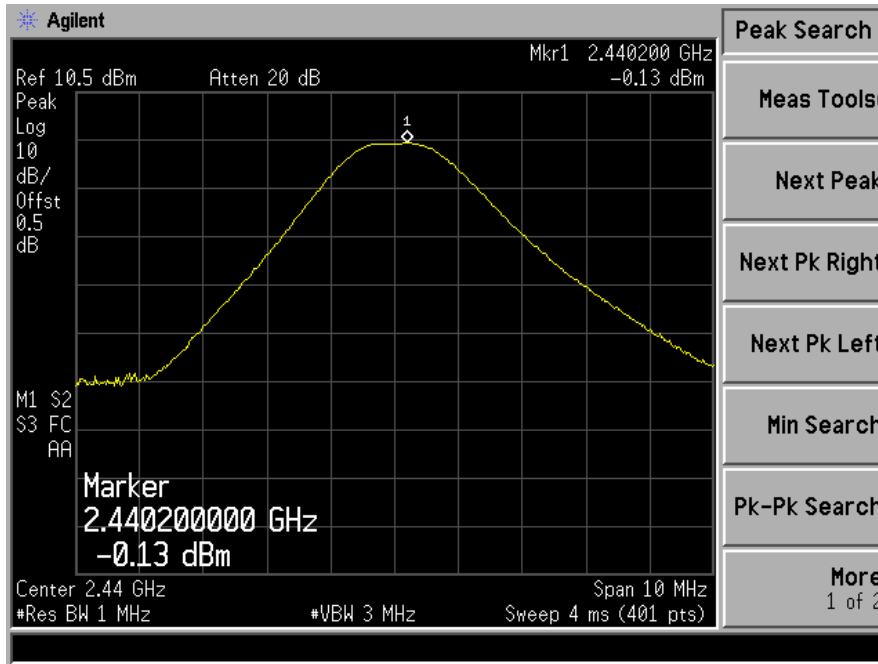

Test Model	Maximum Conducted Output Power Bluetooth4.0DTS Channel 39: 2480MHz
------------	--------------------------------------------------------------------------

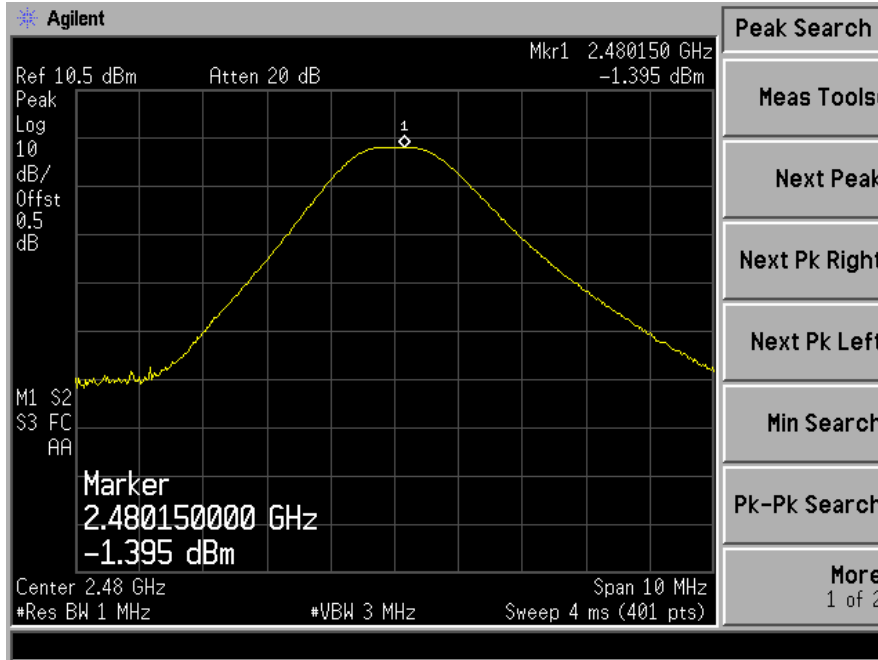

**8.3 MAXIMUM POWER SPECTRAL DENSITY**

**8.3.1 Applicable Standard**

According to FCC Part 15.247(e) and KDB 558074 DTS 01 Meas. Guidance v03r02

**8.3.2 Conformance Limit**

The transmitter power spectral density conducted from the transmitter to the antenna shall not be greater than 8 dBm in any 3 kHz band during any time interval of continuous transmission.

**8.3.3 Test Configuration**

Test according to clause 7.1 radio frequency test setup 1

**8.3.4 Test Procedure**

This procedure shall be used if maximum peak conducted output power was used to demonstrate compliance

The transmitter output (antenna port) was connected to the spectrum analyzer

Set analyzer center frequency to DTS channel center frequency.

Set the span to 1.5 times the DTS bandwidth.

Set the RBW to: 3 kHz

Set the VBW to: 10 kHz.

Set Detector = peak.

Set Sweep time = auto couple.

Set Trace mode = max hold.

Allow trace to fully stabilize.

Use the peak marker function to determine the maximum amplitude level within the RBW.

**8.3.5 Test Results**

Temperature : 28°C      Test Date : January 04, 2014  
 Humidity : 55 %      Test By: KK

Operation Mode	Channel Number	Channel Frequency (MHz)	Measurement Level (dBm/3kHz)	Limit (dBm/3kHz)	Verdict
Bluetooth 4.0 DTS	0	2402	-17.19	8	PASS
	19	2440	-16.60	8	PASS
	39	2480	-17.70	8	PASS
Note: N/A					

Test Model | Power Spectral Density  
Bluetooth 4.0 DTS  
Channel 0: 2402MHz

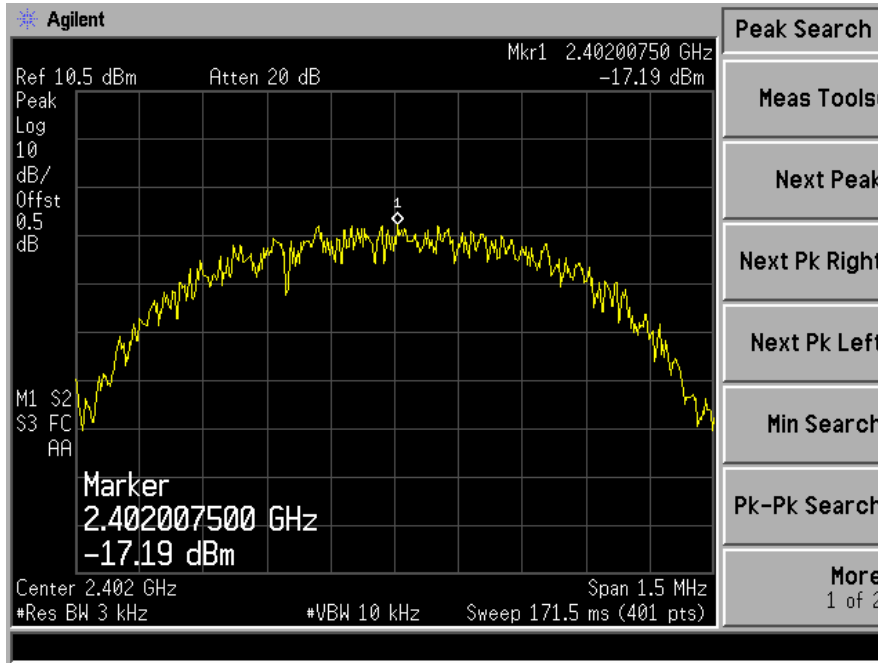

Test Model | Power Spectral Density  
Bluetooth 4.0 DTS  
Channel 19: 2440MHz

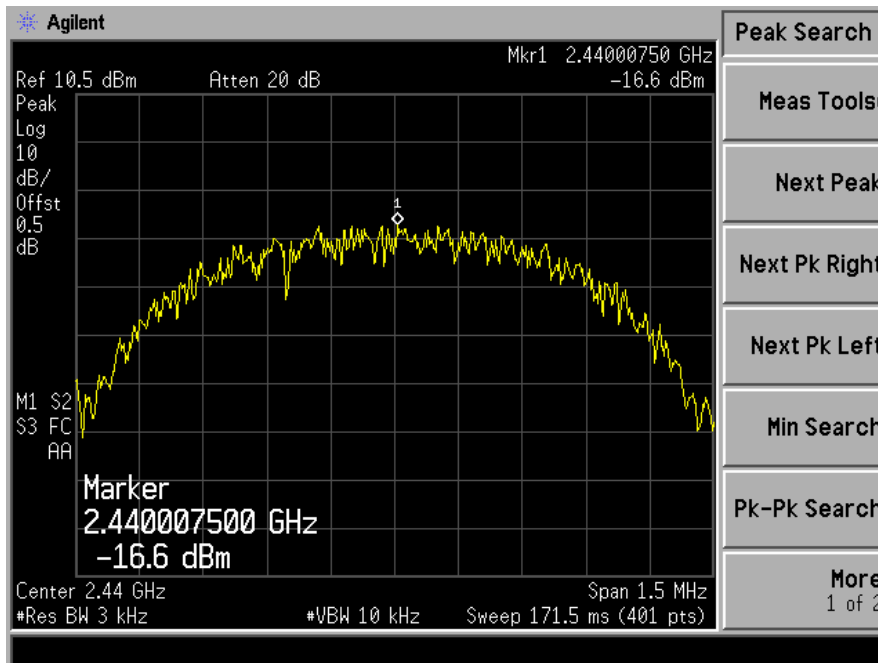

Test Model	<b>Power Spectral Density</b> <b>Bluetooth 4.0 DTS</b> Channel 39: 2480MHz
------------	----------------------------------------------------------------------------------

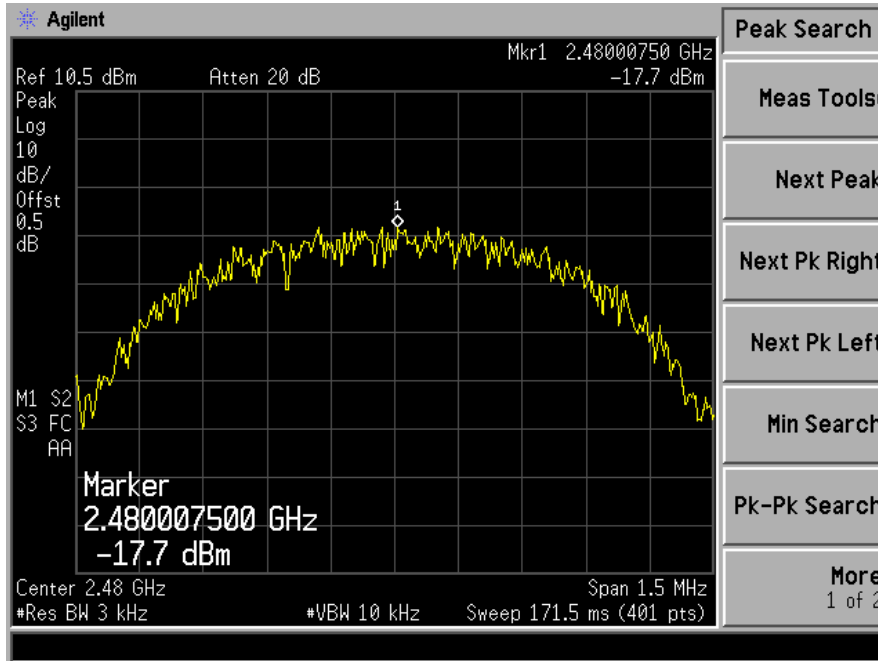

## 8.4 UNWANTED EMISSIONS IN NON-RESTRICTED FREQUENCY BANDS

### 8.4.1 Applicable Standard

According to FCC Part 15.247(d) and KDB 558074 DTS 01 Meas. Guidance v03r02

### 8.4.2 Conformance Limit

According to FCC Part 15.247(d):

In any 100 kHz bandwidth outside the frequency band in which the spread spectrum or digitally modulated intentional radiator is operating, the radio frequency power that is produced by the intentional radiator shall be at least 20 dB below that in the 100 kHz bandwidth within the band that contains the highest level of the desired power, based on either an RF conducted or a radiated measurement, provided the transmitter demonstrates compliance with the peak conducted power limits. If the transmitter complies with the conducted power limits based on the use of RMS averaging over a time interval, as permitted under paragraph (b)(3) of this section, the attenuation required under this paragraph shall be 30 dB instead of 20 dB.

### 8.4.3 Test Configuration

Test according to clause 7.1 radio frequency test setup 1

### 8.4.4 Test Procedure

The transmitter output (antenna port) was connected to the spectrum analyzer

#### ■ Reference level measurement

Establish a reference level by using the following procedure:

Set instrument center frequency to DTS channel center frequency.

Set the span to = 1.5 times the DTS bandwidth.

Set the RBW = 100 kHz.

Set the VBW  $\geq 3 \times$  RBW.

Set Detector = peak.

Set Sweep time = auto couple.

Set Trace mode = max hold.

Allow trace to fully stabilize.

Use the peak marker function to determine the maximum PSD level.

Note that the channel found to contain the maximum PSD level can be used to establish the reference level.

#### ■ Emission level measurement

Set the center frequency and span to encompass frequency range to be measured.

Set the RBW = 100 kHz.

Set the VBW = 300 kHz.

Set Detector = peak

Sweep time = auto couple.

Trace mode = max hold.

Allow trace to fully stabilize.

Use the peak marker function to determine the maximum amplitude level.

Ensure that the amplitude of all unwanted emissions outside of the authorized frequency band (excluding restricted frequency bands) are attenuated by at least the minimum requirements. Report the three highest emissions relative to the limit.

### 8.4.5 Test Results

Test Model	PSD(Power Spectral Density ) RBW=100kHz Bluetooth 4.0 DTS Channel 0: 2402MHz
------------	------------------------------------------------------------------------------------

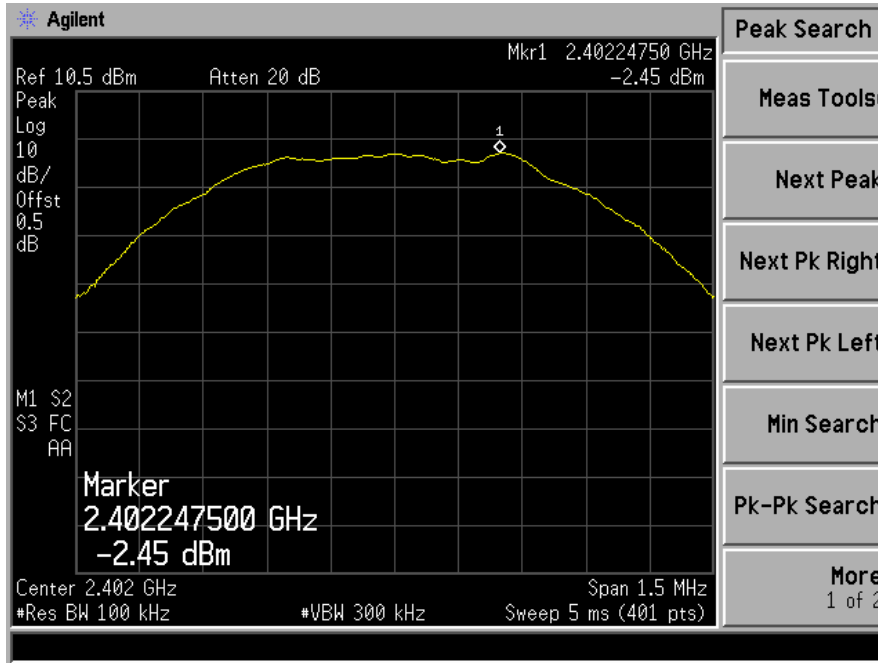

Test Model	Unwanted Emissions in non-restricted frequency bands Bluetooth 4.0 DTS Channel 0: 2402MHz
------------	-------------------------------------------------------------------------------------------------

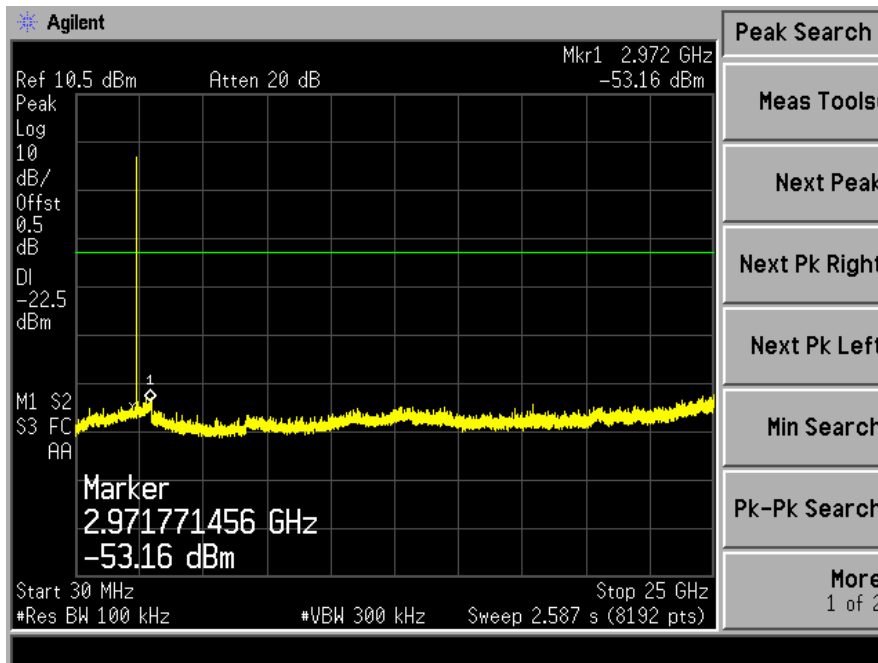

Test Model Band edge  
Bluetooth 4.0 DTS  
Channel 0: 2402MHz

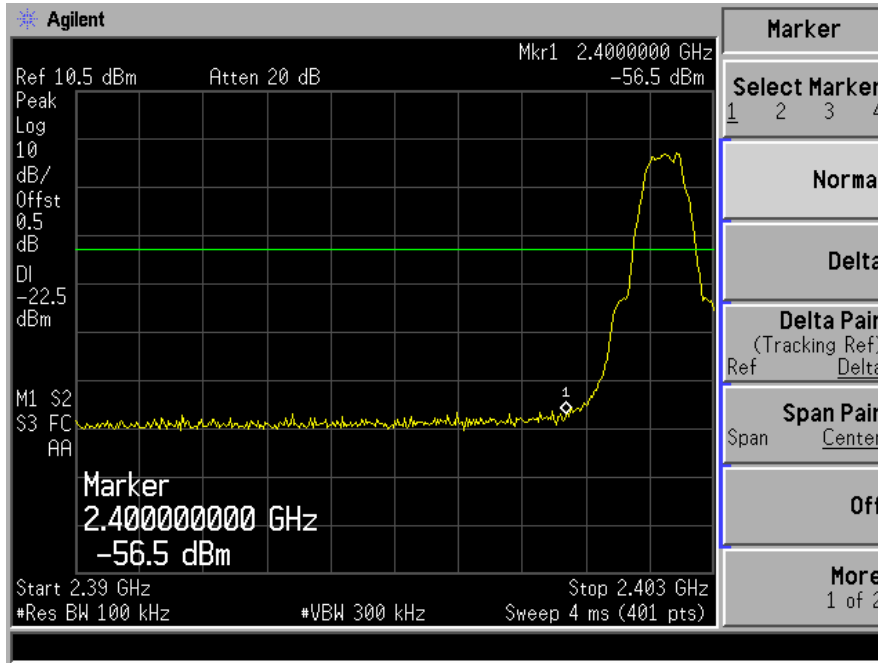

Test Model PSD(Power Spectral Density ) RBW=100kHz  
Bluetooth 4.0 DTS  
Channel 19: 2440MHz

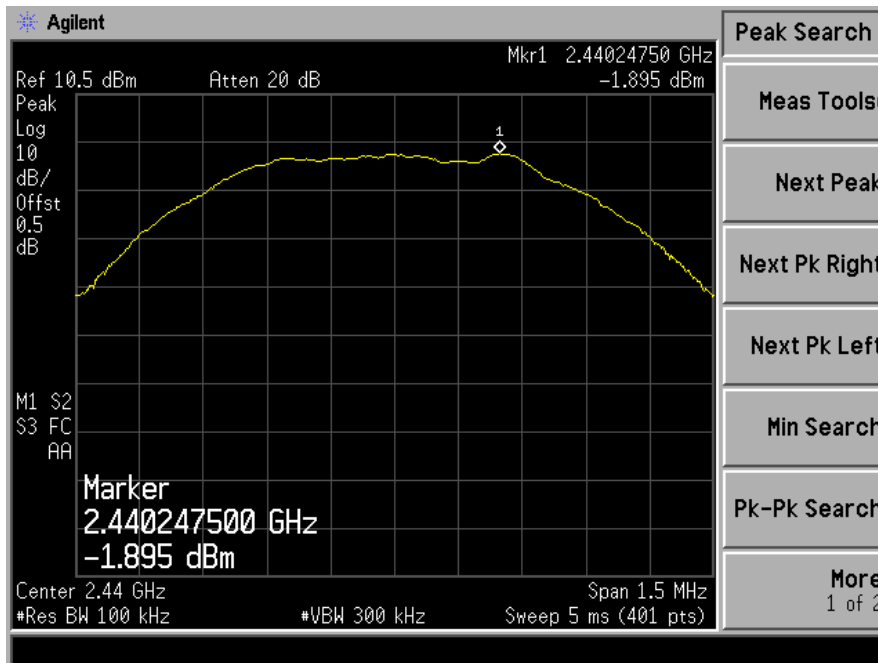



Test Model      Unwanted Emissions In Non-Restricted Frequency Bands  
Bluetooth 4.0 DTS  
Channel 19: 2440MHz

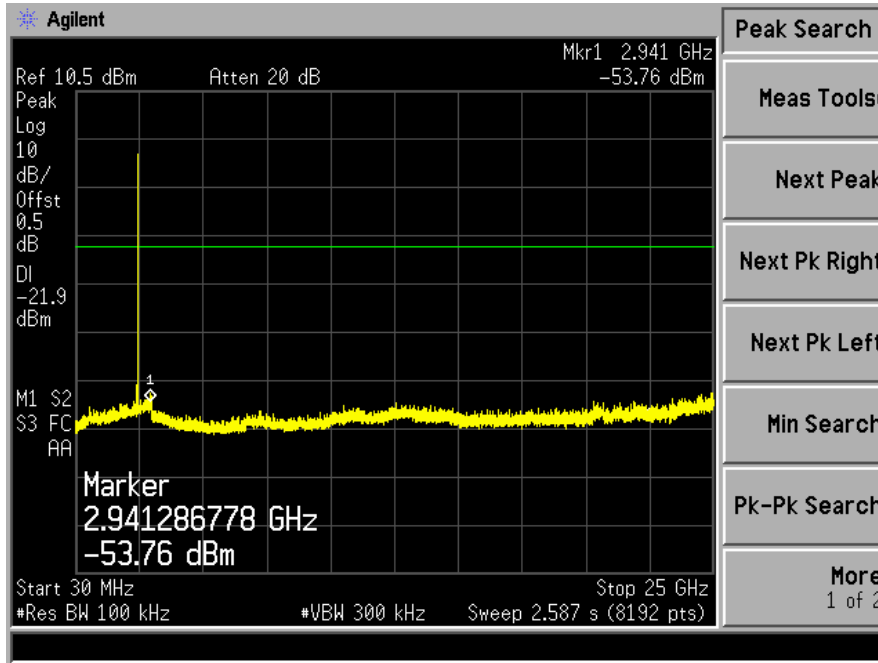

Test Model      PSD(Power Spectral Density ) RBW=100kHz  
Bluetooth 4.0 DTS  
Channel 19: 2480MHz

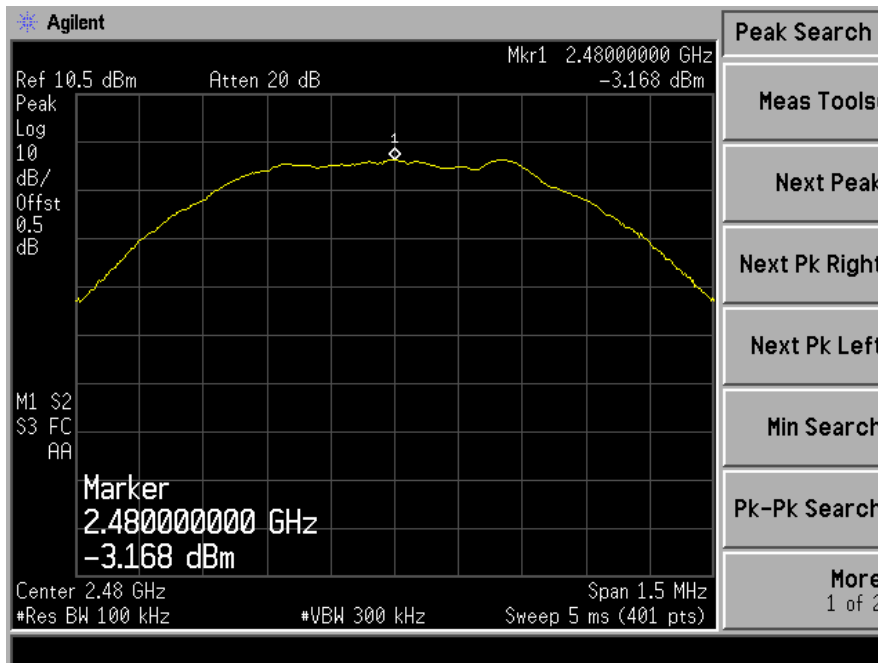

Test Model      Unwanted Emissions In Non-Restricted Frequency Bands  
Bluetooth 4.0 DTS  
Channel 39: 2480MHz

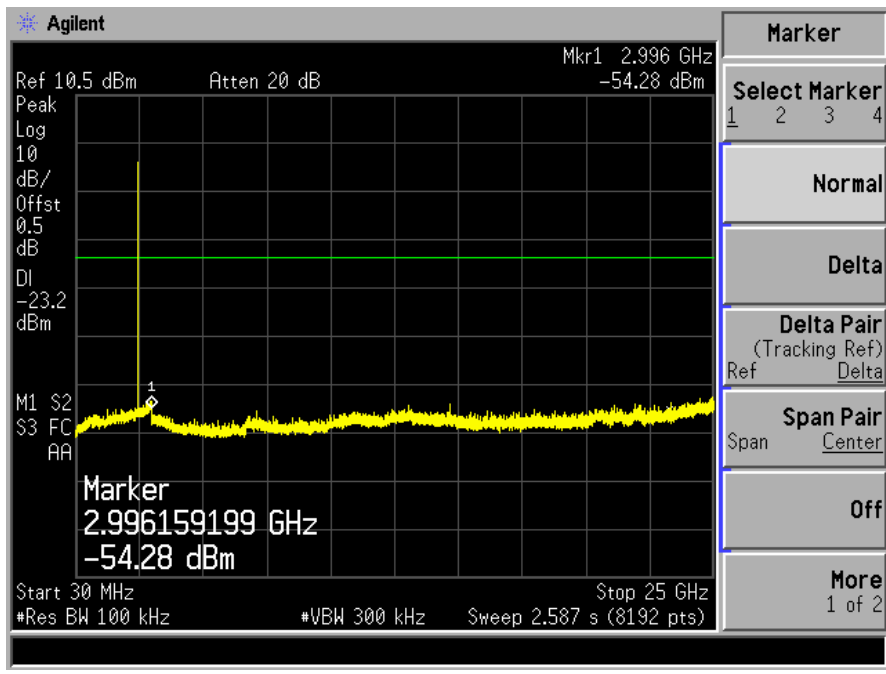

Test Model      Band edge  
Bluetooth 4.0 DTS  
Channel 39: 2480MHz

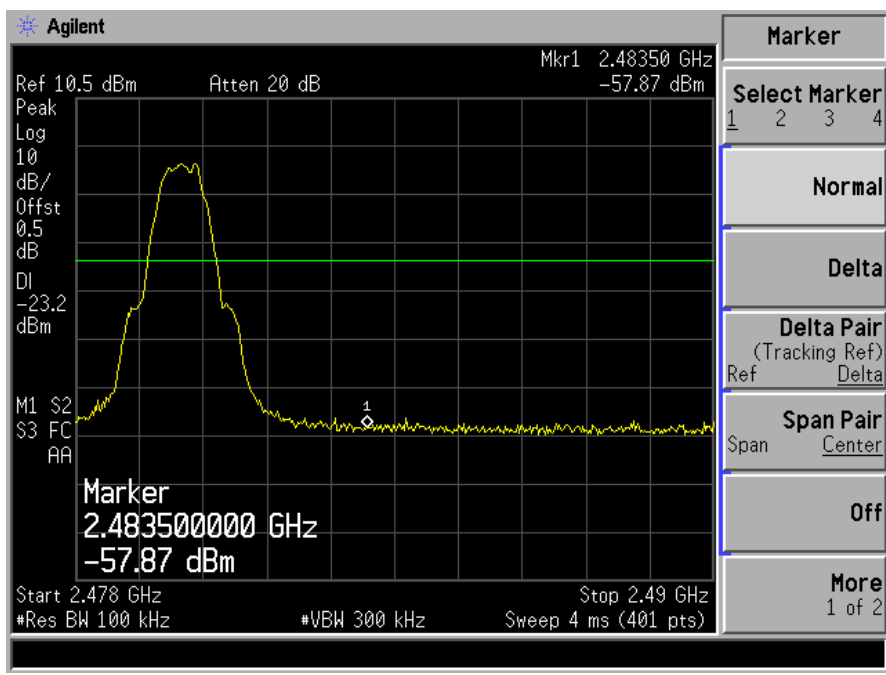

## 8.5 RADIATED SPURIOUS EMISSION

### 8.5.1 Applicable Standard

According to FCC Part 15.247(d) and 15.209 and KDB 558074 DTS 01 Meas. Guidance v03r02

### 8.5.2 Conformance Limit

According to FCC Part 15.247(d): radiated emissions which fall in the restricted bands, as defined in §15.205(a), must also comply with the radiated emission limits specified in §15.209(a) (see §15.205(c)).  
According to FCC Part 15.205, Restricted bands

MHz	MHz	MHz	GHz
0.090-0.110	16.42-16.423	399.9-410	4.5-5.15
10.495-0.505	16.69475-16.69525	608-614	5.35-5.46
2.1735-2.1905	16.80425-16.80475	960-1240	7.25-7.75
4.125-4.128	25.5-25.67	1300-1427	8.025-8.5
4.17725-4.17775	37.5-38.25	1435-1626.5	9.0-9.2
4.20725-4.20775	73-74.6	1645.5-1646.5	9.3-9.5
6.215-6.218	74.8-75.2	1660-1710	10.6-12.7
6.26775-6.26825	123-138	2200-2300	14.47-14.5
8.291-8.294	149.9-150.05	2310-2390	15.35-16.2
8.362-8.366	156.52475-156.52525	2483.5-2500	17.7-21.4
8.37625-8.38675	156.7-156.9	2690-2900	22.01-23.12
8.41425-8.41475	162.0125-167.17	3260-3267	23.6-24.0
12.29-12.293	167.72-173.2	3332-3339	31.2-31.8
12.51975-12.52025	240-285	3345.8-3358	36.43-36.5
12.57675-12.57725	322-335.4	3600-4400	(2)
13.36-13.41			

According to FCC Part 15.205, the level of any transmitter spurious emission in Restricted bands shall not exceed the level of the emission specified in the following table

Restricted Frequency(MHz)	Field Strength (μV/m)	Field Strength (dBμV/m)	Measurement Distance
0.009-0.490	2400/F(KHz)	20 log (uV/m)	300
0.490-1.705	2400/F(KHz)	20 log (uV/m)	30
1.705-30	30	29.5	30
30-88	100	40	3
88-216	150	43.5	3
216-960	200	46	3
Above 960	500	54	3

### 8.5.3 Test Configuration

Test according to clause 7.2 radio frequency test setup 2

### 8.5.4 Test Procedure

This test is required for any spurious emission that falls in a Restricted Band, as defined in Section 15.205. It must be performed with the highest gain of each type of antenna proposed for use with the EUT. Use the following spectrum analyzer settings:

The EUT was placed on a turn table which is 0.8m above ground plane.

Maximum procedure was performed on the highest emissions to ensure EUT compliance.

Span = wide enough to fully capture the emission being measured

RBW = 1 MHz for  $f \geq 1$  GHz (1GHz to 25GHz), 100 kHz for  $f < 1$  GHz (30MHz to 1GHz)

VBW  $\geq$  RBW

Sweep = auto

Detector function = peak

Trace = max hold

Follow the guidelines in ANSI C63.4-2003 with respect to maximizing the emission by rotating the EUT, measuring the emission while the EUT is situated in three orthogonal planes (if appropriate), adjusting the measurement antenna height and polarization, etc. A pre-amp and a high pass filter are required for this test, in order to provide the measuring system with sufficient sensitivity. Allow the trace to stabilize. The peak reading of the emission, after being corrected by the antenna factor, cable loss, pre-amp gain, etc., is the peak field strength, which must comply with the limit specified in Section 15.35(b). Submit this data. Now set the VBW to 10 Hz, while maintaining all of the other instrument settings. This peak level, once corrected, must comply with the limit specified in Section 15.209. If the dwell time per channel of the hopping signal is less than 100 ms, then the reading obtained with the 10 Hz VBW may be further adjusted by a “duty cycle correction factor”, derived from  $20\log(\text{dwell time}/100 \text{ ms})$ , in an effort to demonstrate compliance with the 15.209 limit. Submit this data. Repeat above procedures until all frequency measured was complete.

### 8.5.5 Test Results

■ Spurious Emission below 30MHz (9KHz to 30MHz)

Temperature:	24 °C	Test Date:	January 04, 2014
Humidity:	53 %	Test By:	KK
Test mode:	TX Mode		

Freq. (MHz)	Ant.Pol. H/V	Emission Level(dBuV/m)		Limit 3m(dBuV/m)		Over(dB)	
		PK	AV	PK	AV	PK	AV
--	--	--	--	--	--	--	--

Note: the amplitude of spurious emission that is attenuated by more than 20dB below the permissible limit has no need to be reported.

Distance extrapolation factor =  $40\log(\text{Specific distance}/ \text{test distance})$  (dB);

Limit line = Specific limits(dBuV) + distance extrapolation factor

■ Spurious Emission Above 1GHz (1GHz to 25GHz)

Bluetooth 4.0 DTS mode have been tested, and the worst result was report as below:

Temperature :	28 °C	Test Date :	January 04, 2014
Humidity :	55 %	Test By:	KK
Test mode:	Bluetooth 4.0 DTS	Frequency:	Channel 0: 2402MHz

Freq. (MHz)	Ant.Pol. H/V	Emission Level(dBuV/m)		Limit 3m(dBuV/m)		Over(dB)	
		PK	AV	PK	AV	PK	AV
4841.35	V	49.59	32.30	74.00	54.00	-24.41	-21.70
7456.73	V	51.84	34.60	74.00	54.00	-22.16	-19.40
10072.11	V	51.16	34.10	74.00	54.00	-22.84	-19.90
3860.58	H	47.96	31.30	74.00	54.00	-26.04	-22.70
4950.32	H	51.08	32.60	74.00	54.00	-22.92	-21.40
7293.27	H	49.79	32.00	74.00	54.00	-24.21	-22.00

Temperature : 28°C Test Date : January 04, 2014  
 Humidity : 55 % Test By: KK  
 Test mode: Bluetooth 4.0 DTS Frequency: Channel 19: 2440MHz

Freq. (MHz)	Ant.Pol. H/V	Emission Level(dBuV/m)		Limit 3m(dBuV/m)		Over(dB)	
		PK	AV	PK	AV	PK	AV
4895.83	V	51.54	34.10	74.00	54.00	-22.46	-19.90
6584.94	V	50.28	33.00	74.00	54.00	-23.72	-21.00
7865.39	V	51.25	33.90	74.00	54.00	-22.75	-20.10
1381.41	H	47.72	31.00	74.00	54.00	-26.28	-23.00
3778.85	H	46.78	30.50	74.00	54.00	-27.22	-23.50
4895.83	H	49.64	32.50	74.00	54.00	-24.36	-21.50

Temperature : 28°C Test Date : January 04, 2014  
 Humidity : 55 % Test By: KK  
 Test mode: Bluetooth 4.0 DTS Frequency: Channel 39: 2480MHz

Freq. (MHz)	Ant.Pol. H/V	Emission Level(dBuV/m)		Limit 3m(dBuV/m)		Over(dB)	
		PK	AV	PK	AV	PK	AV
1599.36	V	48.94	31.50	74.00	54.00	-25.06	-22.50
4078.53	V	47.49	30.60	74.00	54.00	-26.51	-23.40
4923.08	V	49.30	33.00	74.00	54.00	-24.70	-21.00
1381.41	H	47.20	30.50	74.00	54.00	-26.80	-23.50
1681.09	H	43.64	29.10	74.00	54.00	-30.36	-24.90
3969.55	H	46.94	30.60	74.00	54.00	-27.06	-23.40

- Note:**
- (1) All Readings are Peak Value (VBW=3MHz) and Peak Value (VBW=10Hz).
  - (2) Emission Level= Reading Level+Probe Factor +Cable Loss.
  - (3) Data of measurement within this frequency range shown "--" in the table above means the reading of emissions are attenuated more than 20dB below the permissible limits or the field strength is too small to be measured.

■ Spurious Emission in Restricted Band 2310-2390MHz and 2483.5-2500MHz

Temperature : 28°C Test Date : January 04, 2014  
 Humidity : 55 % Test By: KK  
 Test mode: Bluetooth 4.0 DTS Frequency: Channel 0: 2402MHz

Frequency (MHz)	Polarity	PK(dBuV/m) (VBW=3MHz)	Limit 3m (dBuV/m)	Margin (dB)	AV(dBuV/m) (VBW=10Hz)	Limit 3m (dBuV/m)	Margin (dB)
2386.88	H	40.51	74.00	-33.49	29.63	54.00	-24.37
2388.56	V	40.66	74.00	-33.34	28.62	54.00	-25.38

Temperature : 28°C Test Date : January 04, 2014  
 Humidity : 55 % Test By: KK  
 Test mode: Bluetooth 4.0 DTS Frequency: Channel 39: 2480MHz

Frequency (MHz)	Polarity	PK(dBuV/m) (VBW=3MHz)	Limit 3m (dBuV/m)	Margin (dB)	AV(dBuV/m) (VBW=10Hz)	Limit 3m (dBuV/m)	Margin (dB)
2483.764	H	41.82	74.00	-32.18	30.59	54.00	-23.41
2483.615	V	39.73	74.00	-34.27	27.68	54.00	-26.32

- Note:** (1) All Readings are Peak Value (VBW=3MHz) and Peak Value (VBW=10Hz).  
 (2) Emission Level= Reading Level+Probe Factor +Cable Loss.  
 (3) Data of measurement within this frequency range shown "--" in the table above means the reading of emissions are attenuated more than 20dB below the permissible limits or the field strength is too small to be measured.

All the modulation modes were tested, the data of the worst mode are described in the following table

Test Model Spurious Emission in Restricted Band 2310-2390MHz  
Bluetooth 4.0 DTS  
Channel 0: 2402MHz

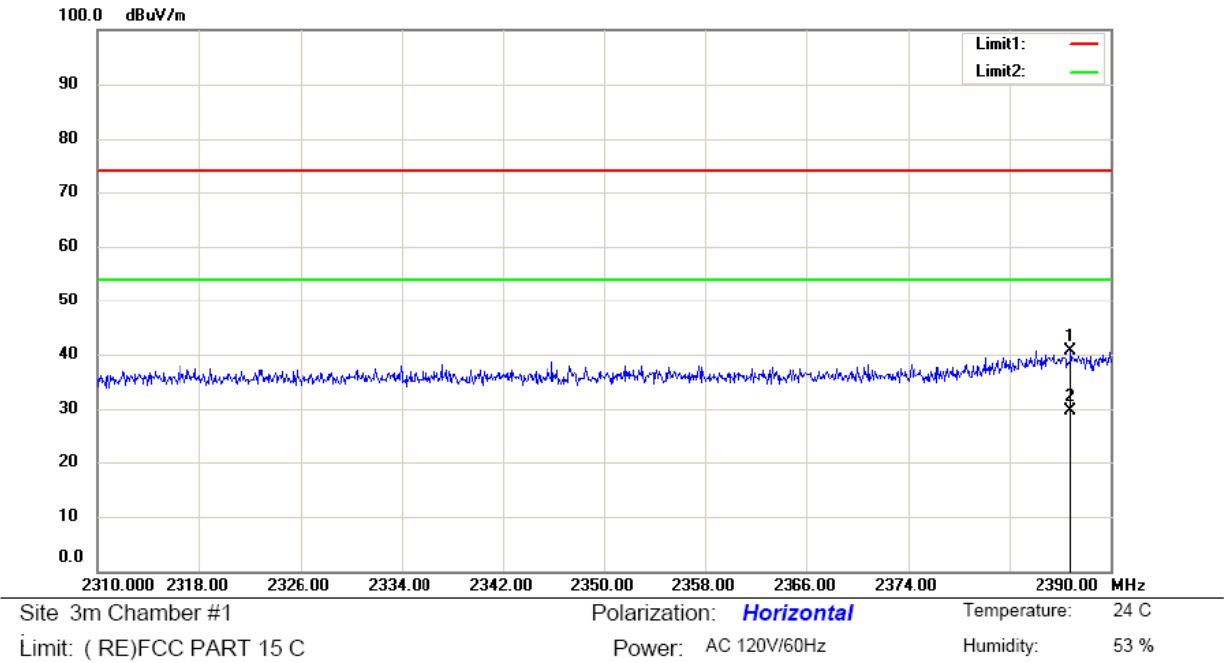

Test Model Spurious Emission in Restricted Band 2483.5-2500MHz  
Bluetooth 4.0 DTS  
Channel 0: 2402MHz

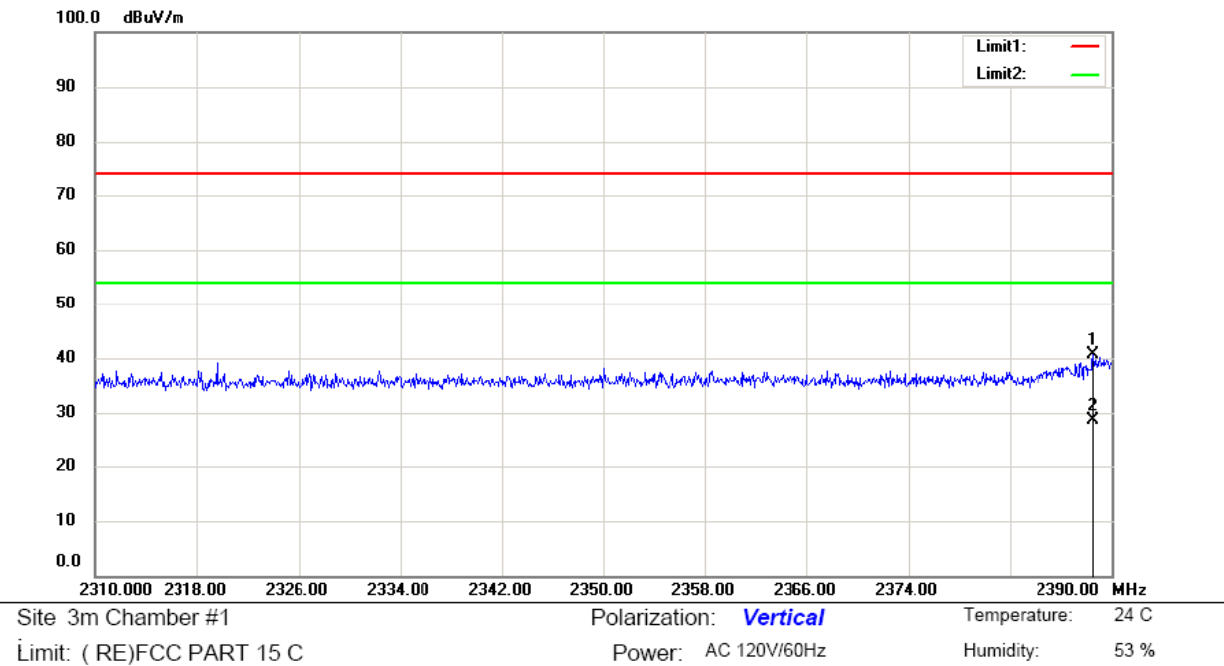

Test Model Spurious Emission in Restricted Band 2310-2390MHz  
Bluetooth 4.0 DTS  
Channel 39: 2480MHz

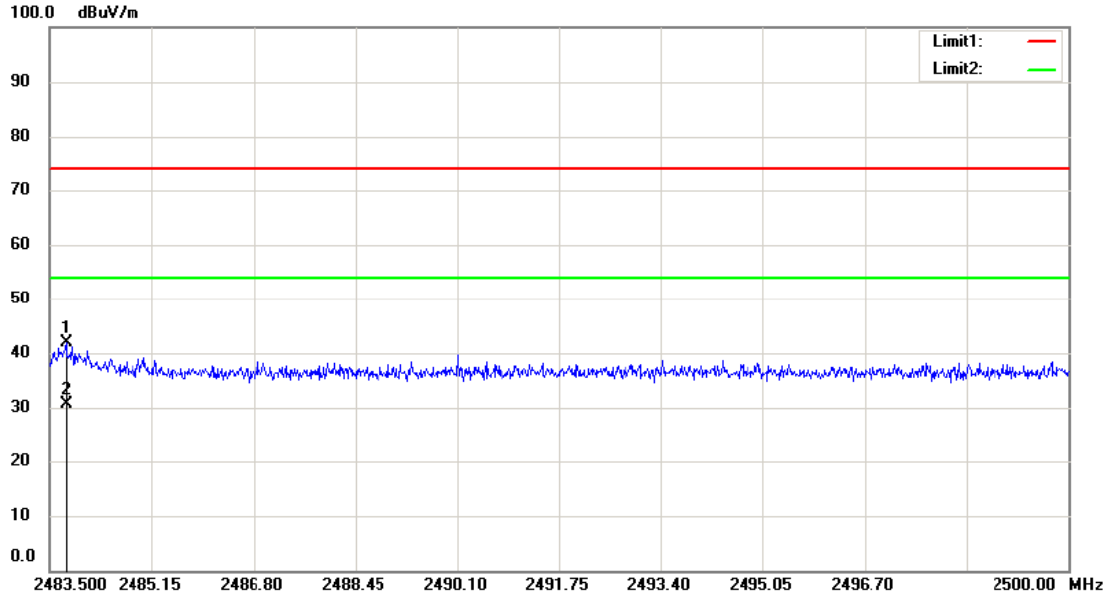

Site 3m Chamber #1 Polarization: **Horizontal** Temperature: 24 C  
 Limit: (RE)FCC PART 15 C Power: AC 120V/60Hz Humidity: 53 %

Test Model Spurious Emission in Restricted Band 2483.5-2500MHz  
Bluetooth 4.0 DTS  
Channel 39: 2480MHz

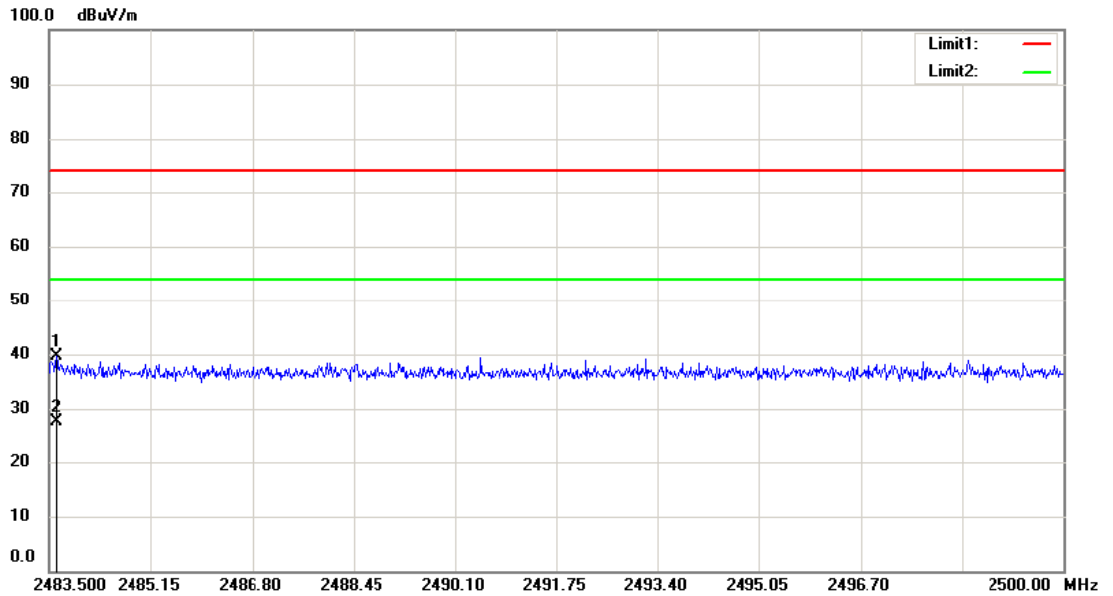

Site 3m Chamber #1 Polarization: **Vertical** Temperature: 24 C  
 Limit: (RE)FCC PART 15 C Power: AC 120V/60Hz Humidity: 53 %



■ Spurious Emission below 1GHz (30MHz to 1GHz)  
Bluetooth 4.0 DTS mode have been tested, and the worst result was report as below:  
**Original test data for adapter 1 and 2:**

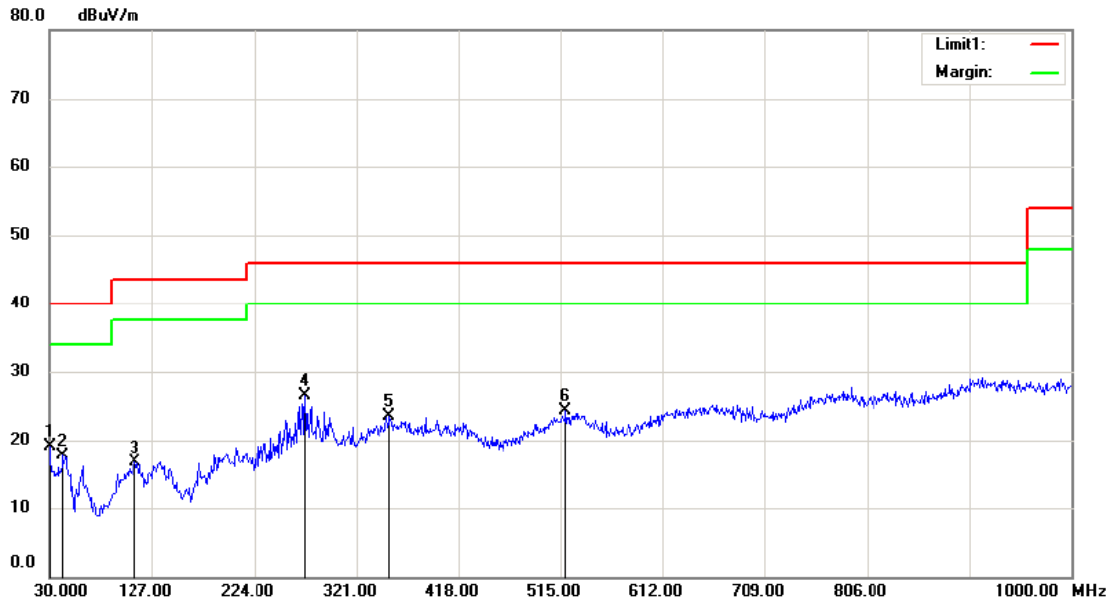

Site 3m Chamber #1 Polarization: **Horizontal** Temperature: 24 C  
Limit: (RE)FCC PART 15 C Power: AC 120V/60Hz Humidity: 53 %  
Mode: TX 2402  
Note:

No.	Mk.	Freq.	Reading Level	Correct Factor	Measurement	Limit	Over	Antenna Height	Table Degree	
		MHz	dBuV	dB	dBuV/m	dBuV/m	dB	cm	degree	Comment
1		30.0000	33.85	-14.70	19.15	40.00	-20.85	QP		
2		42.6100	29.90	-12.26	17.64	40.00	-22.36	QP		
3		110.5100	30.27	-13.64	16.63	43.50	-26.87	QP		
4	*	272.5000	37.32	-10.82	26.50	46.00	-19.50	QP		
5		353.0100	33.08	-9.66	23.42	46.00	-22.58	QP		
6		519.8500	30.53	-6.31	24.22	46.00	-21.78	QP		

\*:Maximum data x:Over limit l:over margin

Operator: KK

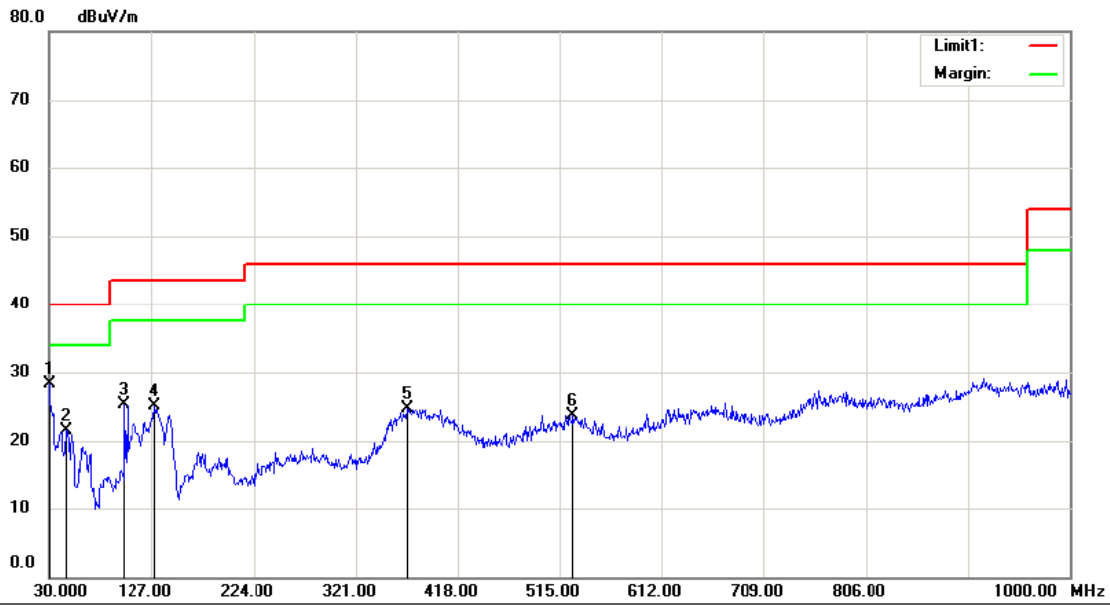

Site: 3m Chamber #1      Polarization: **Vertical**      Temperature: 24 C  
 Limit: (RE)FCC PART 15 C      Power: AC 120V/60Hz      Humidity: 53 %  
 Mode: TX 2402  
 Note:

No.	Mk.	Freq. MHz	Reading Level dBuV	Correct Factor dB	Measure- ment dBuV/m	Limit dBuV/m	Over dB	Antenna Height cm	Table Degree degree	Comment
1	*	30.0000	43.00	-14.70	28.30	40.00	-11.70	QP		
2		45.5200	33.82	-12.37	21.45	40.00	-18.55	QP		
3		100.8100	38.87	-13.57	25.30	43.50	-18.20	QP		
4		129.9100	41.39	-16.37	25.02	43.50	-18.48	QP		
5		370.4700	34.06	-9.36	24.70	46.00	-21.30	QP		
6		527.6100	29.73	-6.01	23.72	46.00	-22.28	QP		

\*:Maximum data    x:Over limit    !:over margin

Operator: KK

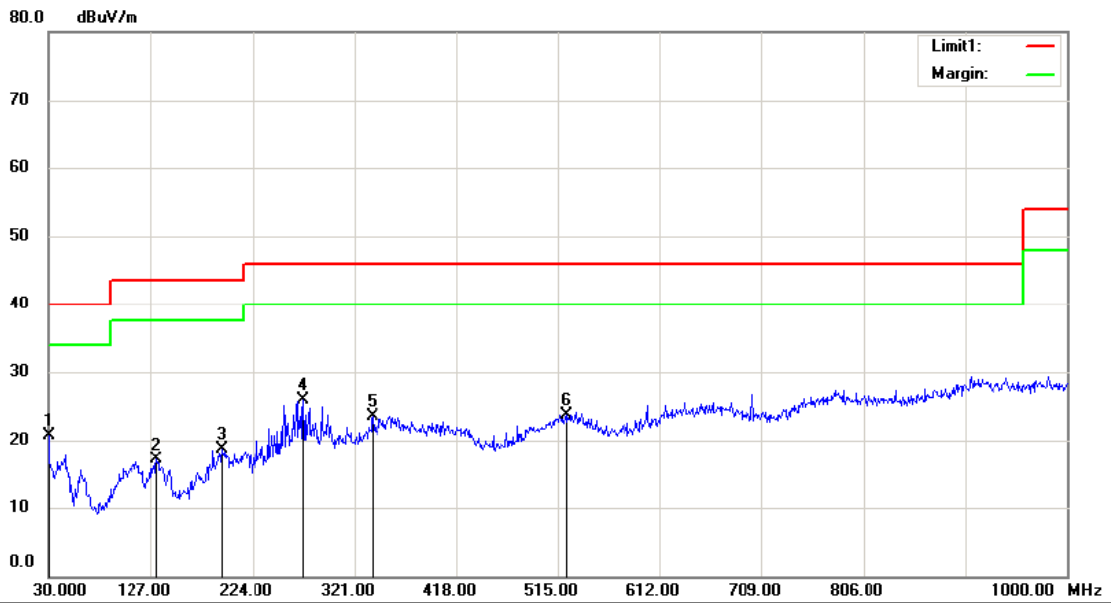

Site 3m Chamber #1 Polarization: **Horizontal** Temperature: 24 C  
 Limit: (RE)FCC PART 15 C Power: AC 120V/60Hz Humidity: 53 %  
 Mode:TX 2440  
 Note:

No.	Mk.	Freq.	Reading Level	Correct Factor	Measurement	Limit	Over	Antenna Height	Table Degree	
		MHz	dBuV	dB	dBuV/m	dBuV/m	dB	cm	degree	Comment
1	*	30.0000	35.43	-14.70	20.73	40.00	-19.27	QP		
2		132.8200	33.49	-16.46	17.03	43.50	-26.47	QP		
3		194.9000	34.12	-15.35	18.77	43.50	-24.73	QP		
4		272.5000	36.65	-10.82	25.83	46.00	-20.17	QP		
5		338.4600	34.24	-10.77	23.47	46.00	-22.53	QP		
6		523.7300	29.95	-6.16	23.79	46.00	-22.21	QP		

\*:Maximum data x:Over limit !:over margin

Operator: KK

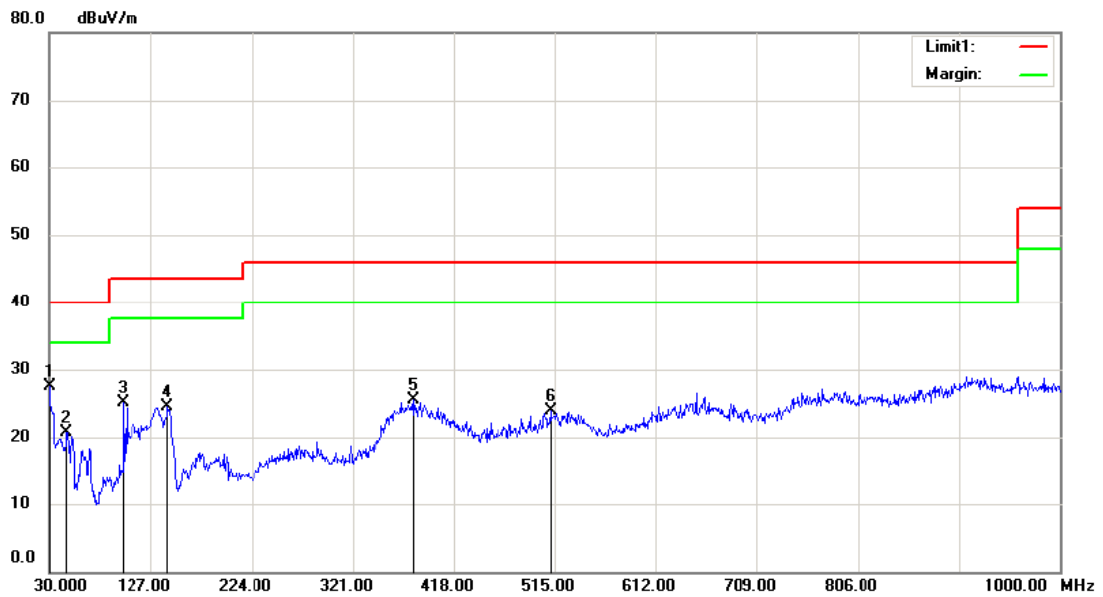

Site 3m Chamber #1      Polarization: **Vertical**      Temperature: 24 C  
 Limit: (RE)FCC PART 15 C      Power: AC 120V/60Hz      Humidity: 53 %  
 Mode:TX 2440  
 Note:

No.	Mk.	Freq. MHz	Reading Level dBuV	Correct Factor dB	Measure- ment dBuV/m	Limit dBuV/m	Over dB	Antenna Height cm	Table Degree	Comment
1	*	30.0000	42.18	-14.70	27.48	40.00	-12.52	QP		
2		46.4900	33.73	-12.94	20.79	40.00	-19.21	QP		
3		100.8100	38.70	-13.57	25.13	43.50	-18.37	QP		
4		143.4900	41.71	-17.19	24.52	43.50	-18.98	QP		
5		380.1700	34.36	-8.91	25.45	46.00	-20.55	QP		
6		511.1200	30.42	-6.57	23.85	46.00	-22.15	QP		

\*:Maximum data    x:Over limit    !:over margin

Operator: KK

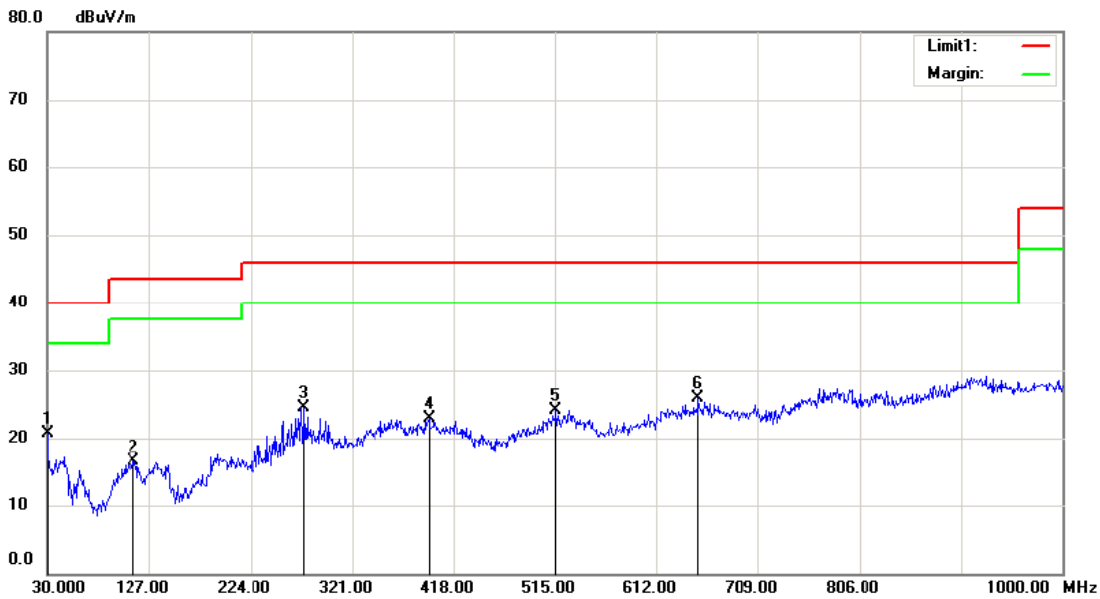

Site 3m Chamber #1 Polarization: **Horizontal** Temperature: 24 C  
 Limit: (RE)FCC PART 15 C Power: AC 120V/60Hz Humidity: 53 %  
 Mode:TX 2480  
 Note:

No.	Mk.	Freq.	Reading Level	Correct Factor	Measurement	Limit	Over	Antenna Height	Table Degree	
		MHz	dBuV	dB	dBuV/m	dBuV/m	dB	cm	degree	Comment
1	*	30.0000	35.32	-14.70	20.62	40.00	-19.38	QP		
2		111.4800	30.33	-13.88	16.45	43.50	-27.05	QP		
3		275.4100	35.17	-10.71	24.46	46.00	-21.54	QP		
4		394.7200	31.13	-8.19	22.94	46.00	-23.06	QP		
5		515.9700	30.58	-6.43	24.15	46.00	-21.85	QP		
6		651.7700	30.86	-4.91	25.95	46.00	-20.05	QP		

\*:Maximum data x:Over limit !:over margin

Operator: KK

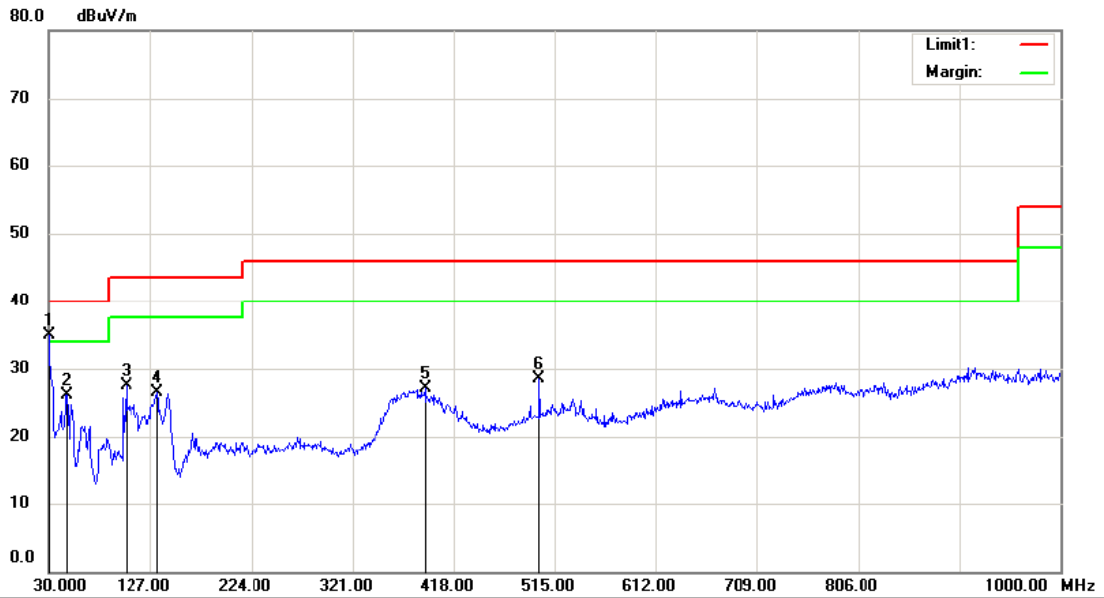

Site: 3m Chamber #1      Polarization: **Vertical**      Temperature: 24 C  
 Limit: (RE)FCC PART 15 C      Power: AC 120V/60Hz      Humidity: 53 %  
 Mode: TX 2480  
 Note:

No.	Mk.	Freq. MHz	Reading Level dBuV	Correct Factor dB	Measure- ment dBuV/m	Limit dBuV/m	Over dB	Antenna Height cm	Table Degree degree	Comment
1	*	30.0000	49.66	-14.70	34.96	40.00	-5.04	QP		
2		47.4600	39.42	-13.40	26.02	40.00	-13.98	QP		
3		103.7200	41.03	-13.46	27.57	43.50	-15.93	QP		
4		133.7900	42.92	-16.50	26.42	43.50	-17.08	QP		
5		390.8400	35.38	-8.34	27.04	46.00	-18.96	QP		
6		500.4500	36.13	-7.56	28.57	46.00	-17.43	QP		

\*:Maximum data    x:Over limit    !:over margin

Operator: KK

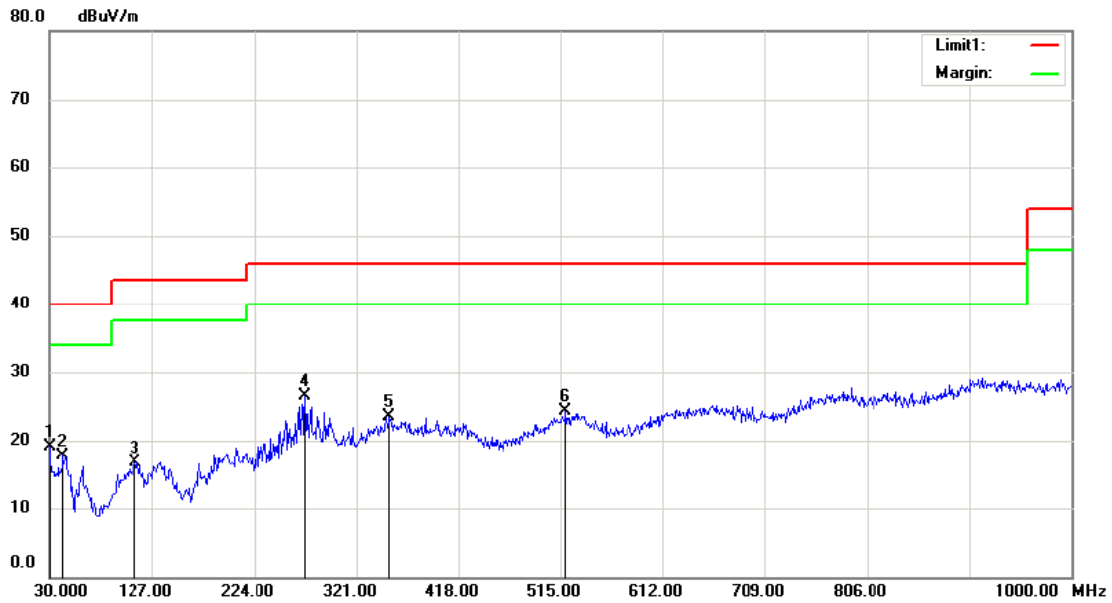

Site 3m Chamber #1      Polarization: **Horizontal**      Temperature: 24 C  
 Limit: (RE)FCC PART 15 C      Power: AC 120V/60Hz      Humidity: 53 %  
 Mode: TX 2402  
 Note:

No.	Mk.	Freq. MHz	Reading Level dBuV	Correct Factor dB	Measure- ment dBuV/m	Limit dBuV/m	Over dB	Antenna Height cm	Table Degree	Detector	Comment
1		30.0000	33.85	-14.70	19.15	40.00	-20.85			QP	
2		42.6100	29.90	-12.26	17.64	40.00	-22.36			QP	
3		110.5100	30.27	-13.64	16.63	43.50	-26.87			QP	
4	*	272.5000	37.32	-10.82	26.50	46.00	-19.50			QP	
5		353.0100	33.08	-9.66	23.42	46.00	-22.58			QP	
6		519.8500	30.53	-6.31	24.22	46.00	-21.78			QP	

\*:Maximum data    x:Over limit    !:over margin

Operator: KK

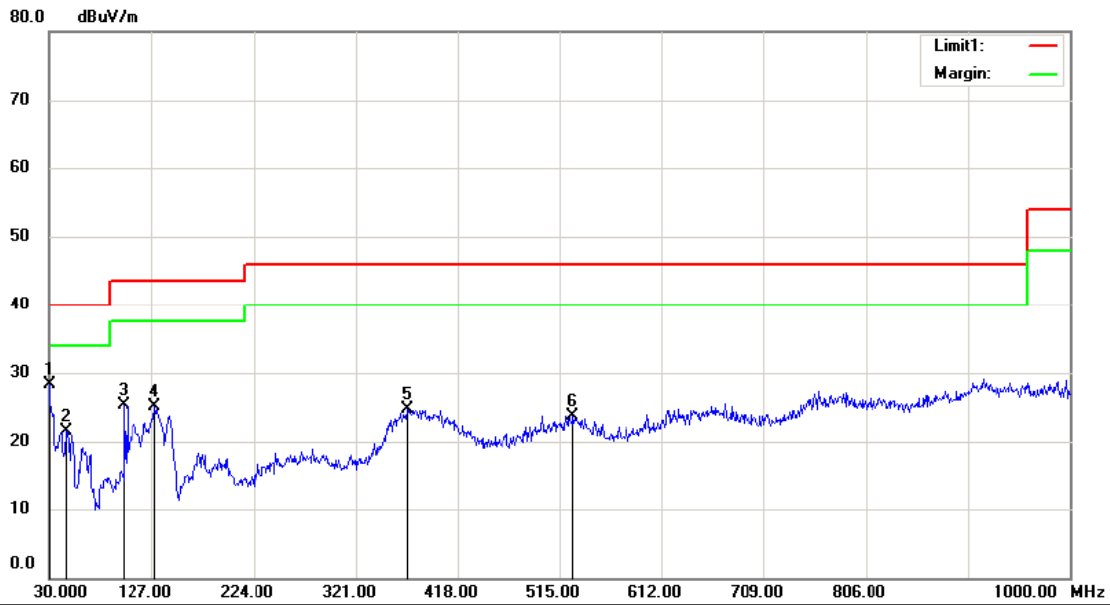

Site: 3m Chamber #1      Polarization: **Vertical**      Temperature: 24 C  
 Limit: (RE)FCC PART 15 C      Power: AC 120V/60Hz      Humidity: 53 %  
 Mode: TX 2402  
 Note:

No.	Mk.	Freq. MHz	Reading Level dBuV	Correct Factor dB	Measure- ment dBuV/m	Limit dBuV/m	Over dB	Detector	Antenna Height cm	Table Degree degree	Comment
1	*	30.0000	43.00	-14.70	28.30	40.00	-11.70	QP			
2		45.5200	33.82	-12.37	21.45	40.00	-18.55	QP			
3		100.8100	38.87	-13.57	25.30	43.50	-18.20	QP			
4		129.9100	41.39	-16.37	25.02	43.50	-18.48	QP			
5		370.4700	34.06	-9.36	24.70	46.00	-21.30	QP			
6		527.6100	29.73	-6.01	23.72	46.00	-22.28	QP			

\*:Maximum data    x:Over limit    !:over margin

Operator: KK



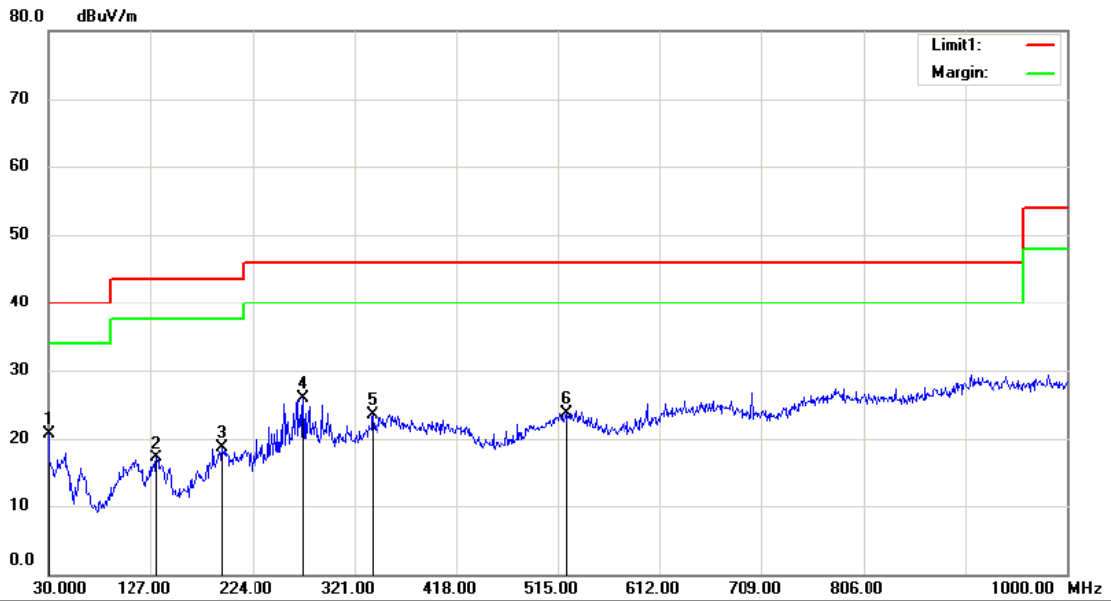

Site 3m Chamber #1 Polarization: **Horizontal** Temperature: 24 C  
 Limit: (RE)FCC PART 15 C Power: AC 120V/60Hz Humidity: 53 %  
 Mode:TX 2440  
 Note:

No.	Mk.	Freq.	Reading Level	Correct Factor	Measurement	Limit	Over	Antenna Height	Table Degree	
		MHz	dBuV	dB	dBuV/m	dBuV/m	dB	cm	degree	Comment
1	*	30.0000	35.43	-14.70	20.73	40.00	-19.27	QP		
2		132.8200	33.49	-16.46	17.03	43.50	-26.47	QP		
3		194.9000	34.12	-15.35	18.77	43.50	-24.73	QP		
4		272.5000	36.65	-10.82	25.83	46.00	-20.17	QP		
5		338.4600	34.24	-10.77	23.47	46.00	-22.53	QP		
6		523.7300	29.95	-6.16	23.79	46.00	-22.21	QP		

\*:Maximum data x:Over limit !:over margin

Operator: KK

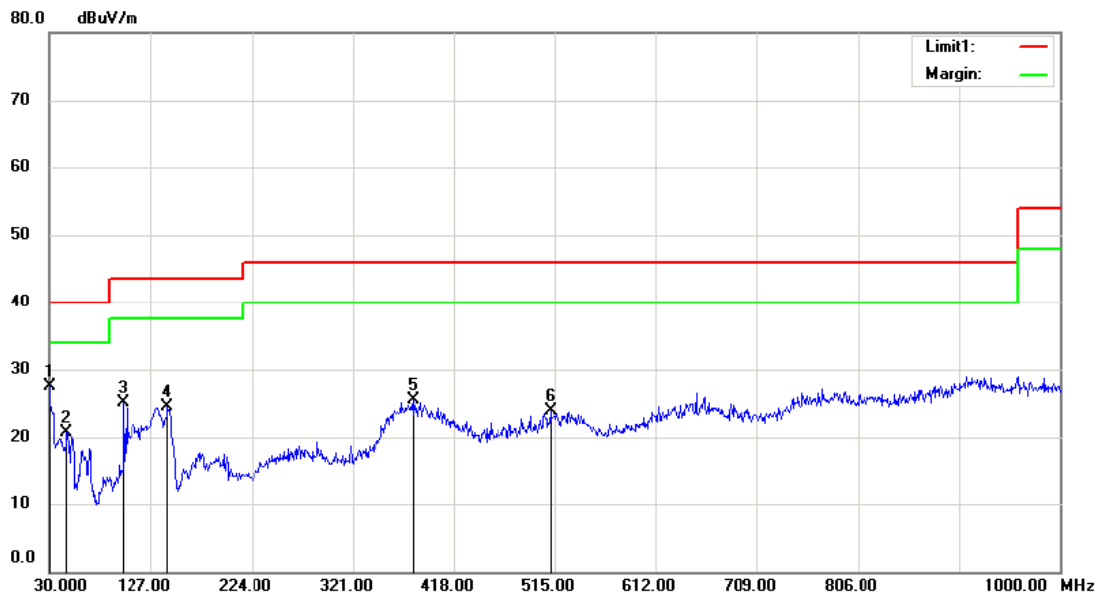

Site 3m Chamber #1      Polarization: **Vertical**      Temperature: 24 C  
 Limit: (RE)FCC PART 15 C      Power: AC 120V/60Hz      Humidity: 53 %  
 Mode:TX 2440  
 Note:

No.	Mk.	Freq. MHz	Reading Level dBuV	Correct Factor dB	Measure- ment dBuV/m	Limit dBuV/m	Over dB	Antenna Height cm	Table Degree	Comment
1	*	30.0000	42.18	-14.70	27.48	40.00	-12.52	QP		
2		46.4900	33.73	-12.94	20.79	40.00	-19.21	QP		
3		100.8100	38.70	-13.57	25.13	43.50	-18.37	QP		
4		143.4900	41.71	-17.19	24.52	43.50	-18.98	QP		
5		380.1700	34.36	-8.91	25.45	46.00	-20.55	QP		
6		511.1200	30.42	-6.57	23.85	46.00	-22.15	QP		

\*:Maximum data    x:Over limit    !:over margin

Operator: KK

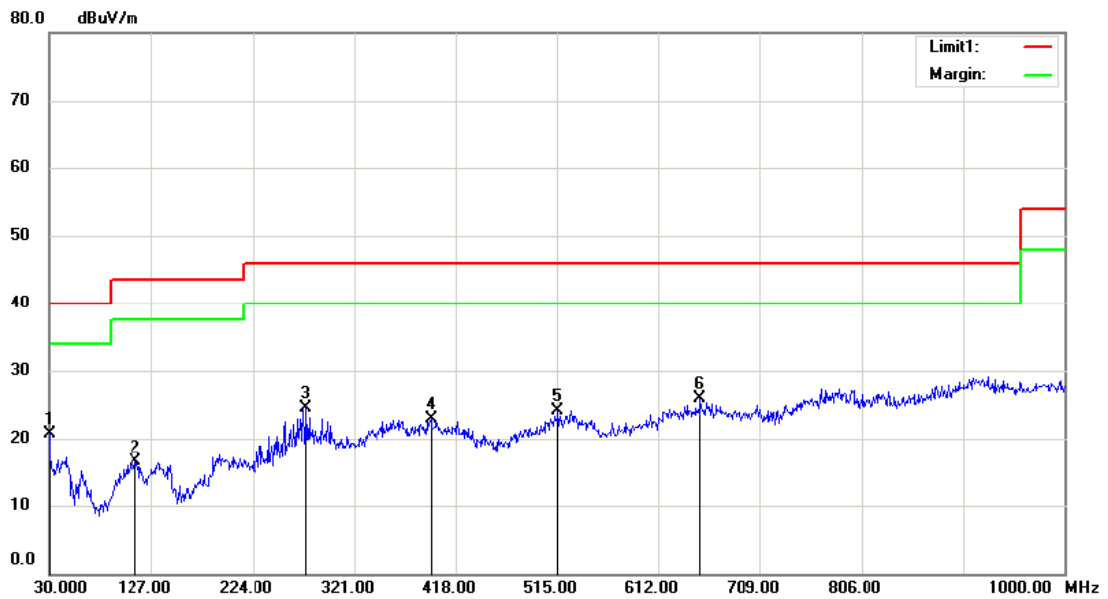

Site 3m Chamber #1 Polarization: **Horizontal** Temperature: 24 C  
 Limit: (RE)FCC PART 15 C Power: AC 120V/60Hz Humidity: 53 %  
 Mode:TX 2480  
 Note:

No.	Mk.	Freq. MHz	Reading Level dBuV	Correct Factor dB	Measure- ment dBuV/m	Limit dBuV/m	Over dB	Antenna Height cm	Table Degree	Detector	Comment
1	*	30.0000	35.32	-14.70	20.62	40.00	-19.38			QP	
2		111.4800	30.33	-13.88	16.45	43.50	-27.05			QP	
3		275.4100	35.17	-10.71	24.46	46.00	-21.54			QP	
4		394.7200	31.13	-8.19	22.94	46.00	-23.06			QP	
5		515.9700	30.58	-6.43	24.15	46.00	-21.85			QP	
6		651.7700	30.86	-4.91	25.95	46.00	-20.05			QP	

\*:Maximum data x:Over limit !:over margin

Operator: KK

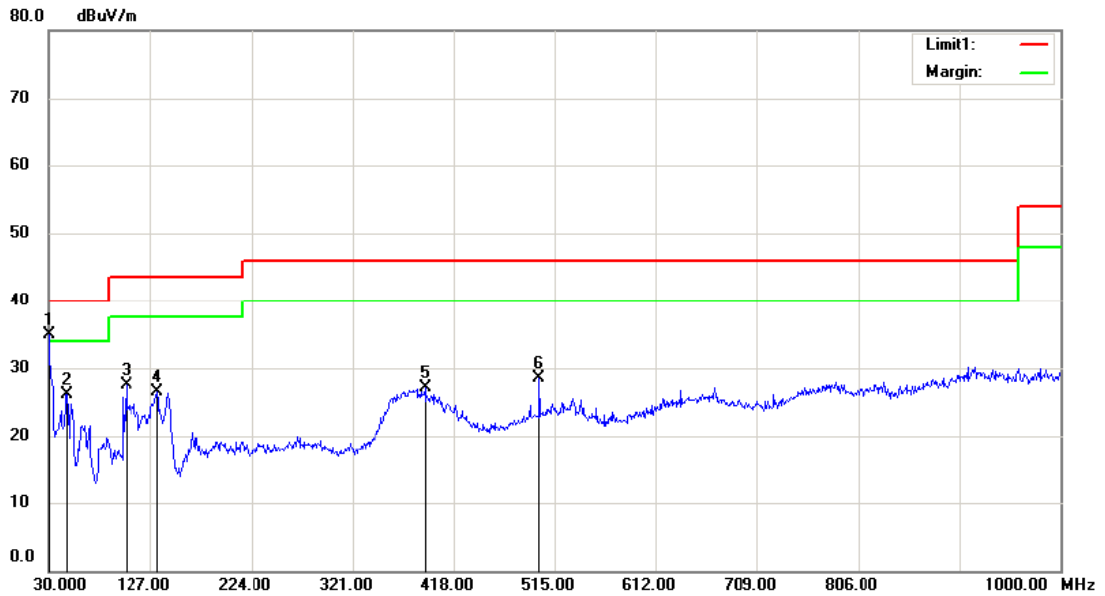

Site: 3m Chamber #1      Polarization: **Vertical**      Temperature: 24 C  
 Limit: (RE)FCC PART 15 C      Power: AC 120V/60Hz      Humidity: 53 %  
 Mode: TX 2480  
 Note:

No.	Mk.	Freq. MHz	Reading Level dBuV	Correct Factor dB	Measure- ment dBuV/m	Limit dBuV/m	Over dB	Antenna Height cm	Table Degree degree	Comment
1	*	30.0000	49.66	-14.70	34.96	40.00	-5.04	QP		
2		47.4600	39.42	-13.40	26.02	40.00	-13.98	QP		
3		103.7200	41.03	-13.46	27.57	43.50	-15.93	QP		
4		133.7900	42.92	-16.50	26.42	43.50	-17.08	QP		
5		390.8400	35.38	-8.34	27.04	46.00	-18.96	QP		
6		500.4500	36.13	-7.56	28.57	46.00	-17.43	QP		

\*:Maximum data    x:Over limit    !:over margin

Operator: KK

**Add test results for adapter 3:**

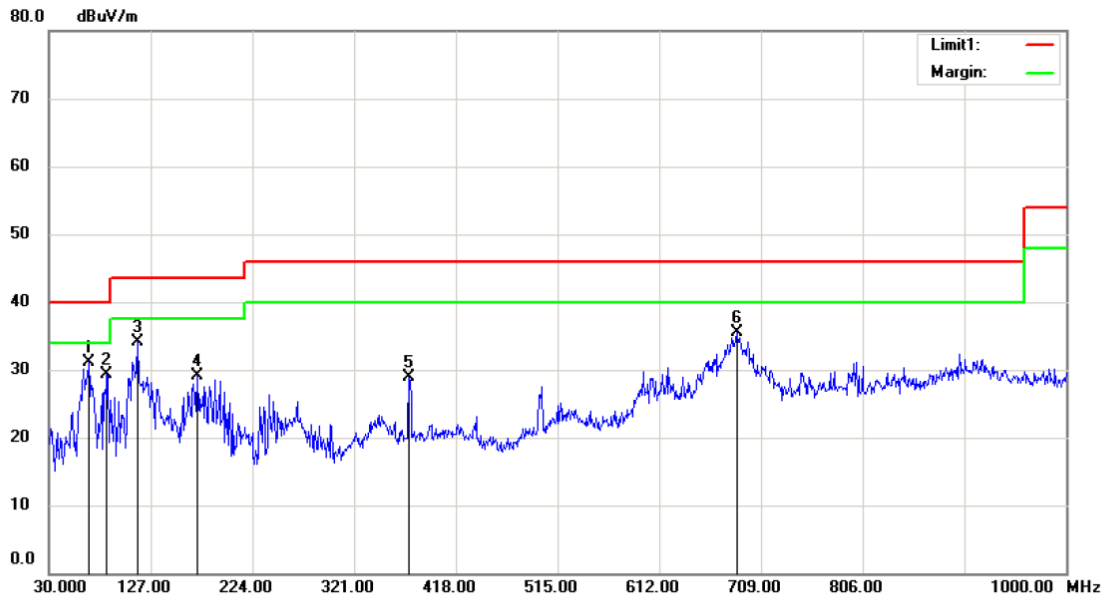

Site 3m Chamber #1  
 Limit: (RE)FCC PART 15C  
 Mode:TX(2402)  
 Note:

Polarization: *Horizontal*  
 Power: AC 120V/60Hz

Temperature: 24 C  
 Humidity: 53 %

No.	Mk.	Freq.	Reading Level	Correct Factor	Measurement	Limit	Over	Antenna Height	Table Degree	
		MHz	dBuV	dB	dBuV/m	dBuV/m	dB	cm	degree	Comment
1	*	67.8300	48.14	-17.08	31.06	40.00	-8.94			QP
2		85.2900	46.99	-17.62	29.37	40.00	-10.63			QP
3		114.3900	48.67	-14.58	34.09	43.50	-9.41			QP
4		171.6200	47.34	-18.24	29.10	43.50	-14.40			QP
5		373.3800	38.12	-9.23	28.89	46.00	-17.11			QP
6		685.7200	41.10	-5.60	35.50	46.00	-10.50			QP

\*:Maximum data    x:Over limit    !:over margin

Operator: ZHL

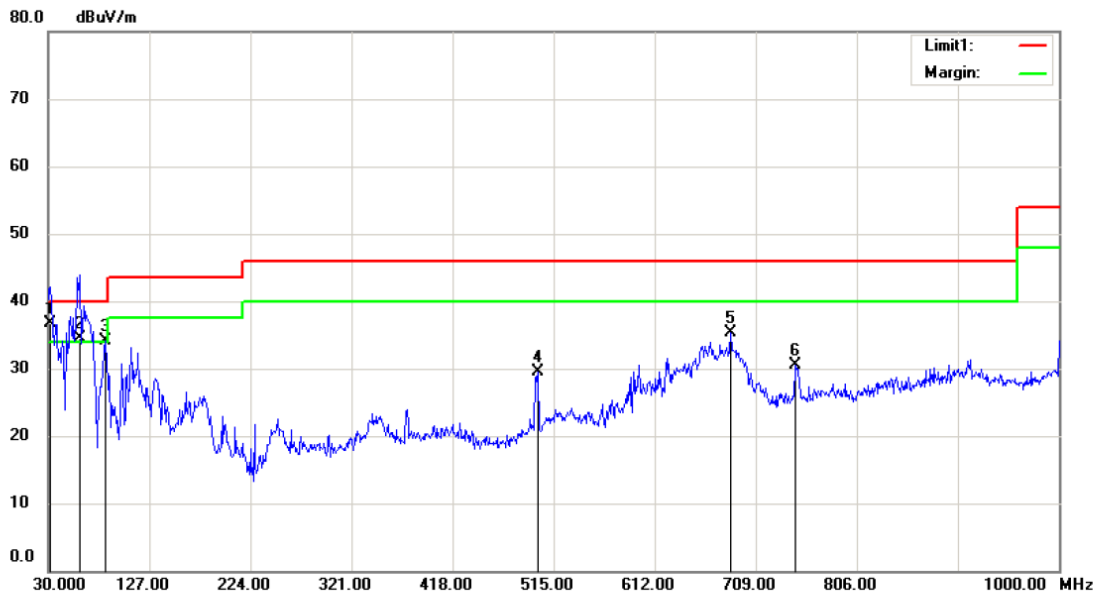

Site 3m Chamber #1 Polarization: **Vertical** Temperature: 24 C  
 Limit: (RE)FCC PART 15C Power: AC 120V/60Hz Humidity: 53 %  
 Mode:TX(2402)  
 Note:

No.	Mk.	Freq.	Reading Level	Correct Factor	Measurement	Limit	Over	Antenna Height	Table Degree	
		MHz	dBuV	dB	dBuV/m	dBuV/m	dB	cm	degree	Comment
1	*	31.9400	50.89	-14.09	36.80	40.00	-3.20			QP
2	!	60.0700	47.93	-13.43	34.50	40.00	-5.50			QP
3	!	84.3200	51.98	-17.88	34.10	40.00	-5.90			QP
4		500.4500	37.04	-7.56	29.48	46.00	-16.52			QP
5		684.7500	40.88	-5.59	35.29	46.00	-10.71			QP
6		746.8300	34.60	-4.08	30.52	46.00	-15.48			QP

\*:Maximum data x:Over limit !:over margin

Operator: ZHL

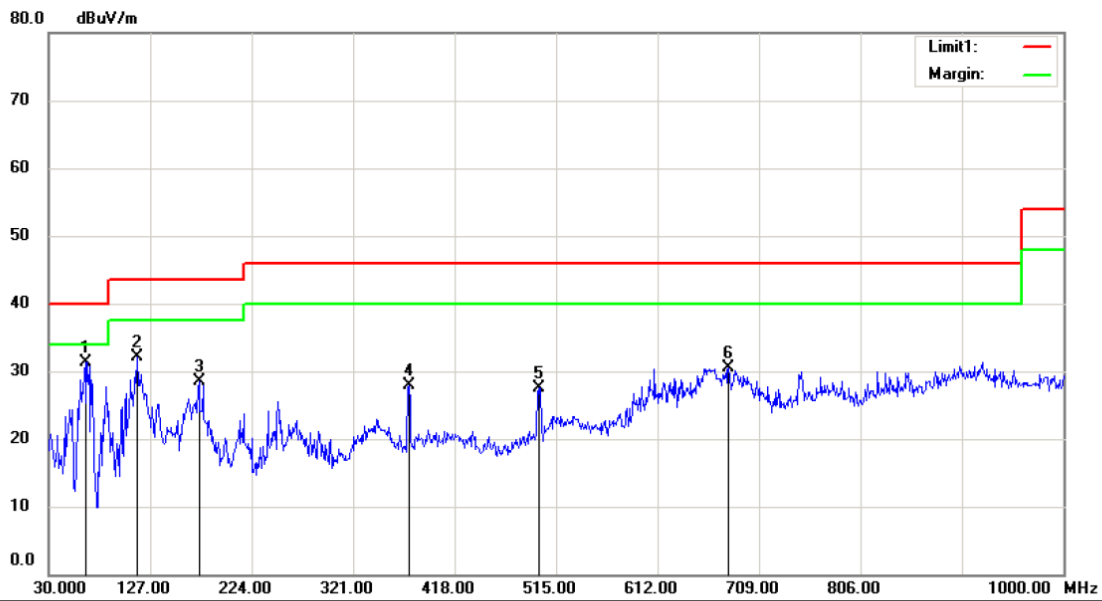

Site 3m Chamber #1 Polarization: *Horizontal* Temperature: 24 C  
 Limit: (RE)FCC PART 15C Power: AC 120V/60Hz Humidity: 53 %  
 Mode:TX(2440)  
 Note:

No.	Mk.	Freq.	Reading Level	Correct Factor	Measurement	Limit	Over	Antenna Height	Table Degree	
		MHz	dBuV	dB	dBuV/m	dBuV/m	dB	cm	degree	Comment
1	*	64.9200	47.14	-15.89	31.25	40.00	-8.75	QP		
2		114.3900	46.76	-14.58	32.18	43.50	-11.32	QP		
3		173.5600	46.67	-18.14	28.53	43.50	-14.97	QP		
4		374.3500	36.98	-9.17	27.81	46.00	-18.19	QP		
5		498.5100	35.16	-7.67	27.49	46.00	-18.51	QP		
6		679.9000	35.92	-5.50	30.42	46.00	-15.58	QP		

\*:Maximum data x:Over limit !:over margin

Operator: ZHL

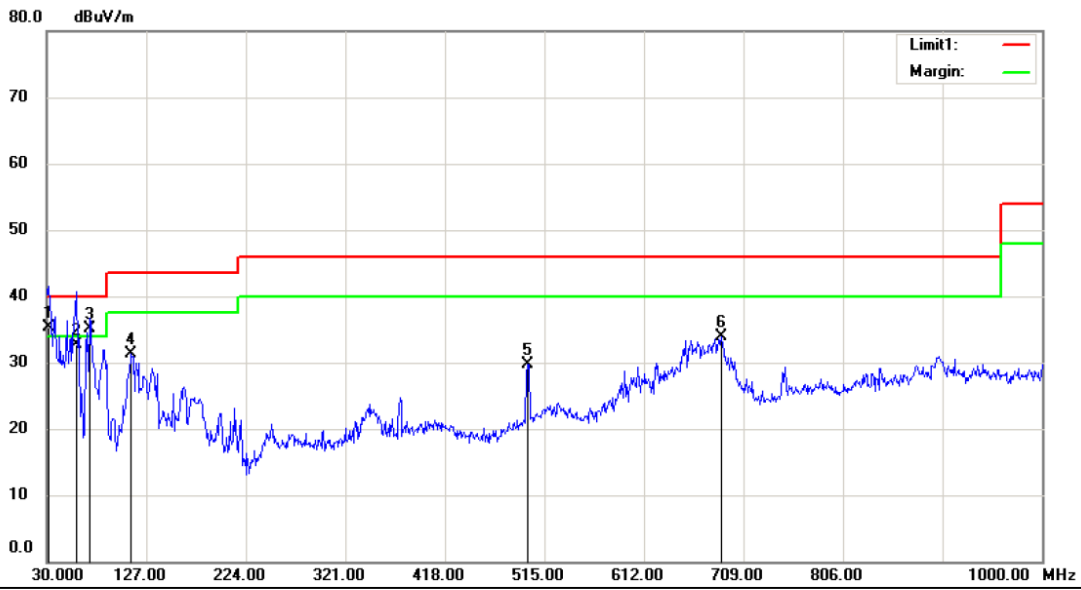

Site 3m Chamber #1      Polarization: *Vertical*      Temperature: 24 C  
 Limit: (RE)FCC PART 15C      Power: AC 120V/60Hz      Humidity: 53 %  
 Mode:TX(2440)  
 Note:

No.	Mk.	Freq. MHz	Reading Level dBuV	Correct Factor dB	Measure- ment dBuV/m	Limit dBuV/m	Over dB	Antenna Height cm	Table Degree degree	Comment
1	*	31.9400	49.49	-14.09	35.40	40.00	-4.60			QP
2		59.1000	46.74	-13.94	32.80	40.00	-7.20			QP
3	!	71.7100	53.58	-18.38	35.20	40.00	-4.80			QP
4		112.4500	45.47	-14.11	31.36	43.50	-12.14			QP
5		498.5100	37.41	-7.67	29.74	46.00	-16.26			QP
6		687.6600	39.61	-5.63	33.98	46.00	-12.02			QP

\*:Maximum data    x:Over limit    !:over margin

Operator: ZHL



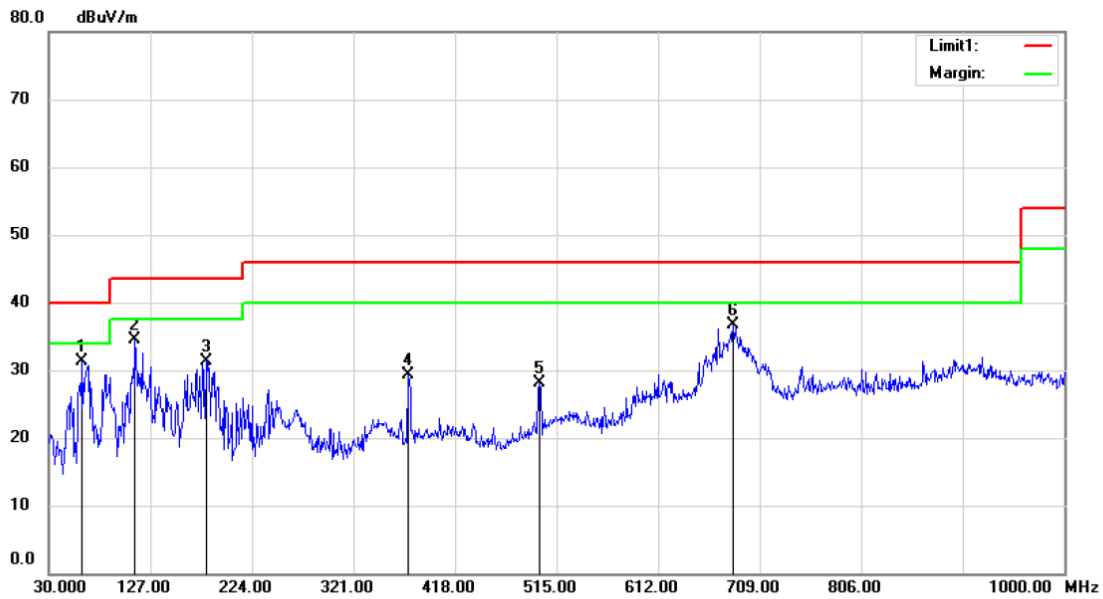

Site 3m Chamber #1 Polarization: *Horizontal* Temperature: 24 C  
 Limit: (RE)FCC PART 15C Power: AC 120V/60Hz Humidity: 53 %  
 Mode:TX(2480)  
 Note:

No.	Mk.	Freq.	Reading Level	Correct Factor	Measurement	Limit	Over	Antenna Height	Table Degree	
		MHz	dBuV	dB	dBuV/m	dBuV/m	dB	cm	degree	Comment
1	*	62.0100	45.72	-14.41	31.31	40.00	-8.69			QP
2		112.4500	48.64	-14.11	34.53	43.50	-8.97			QP
3		180.3500	48.80	-17.57	31.23	43.50	-12.27			QP
4		373.3800	38.59	-9.23	29.36	46.00	-16.64			QP
5		498.5100	35.78	-7.67	28.11	46.00	-17.89			QP
6		683.7800	42.29	-5.57	36.72	46.00	-9.28			QP

\*:Maximum data x:Over limit !:over margin

Operator: ZHL

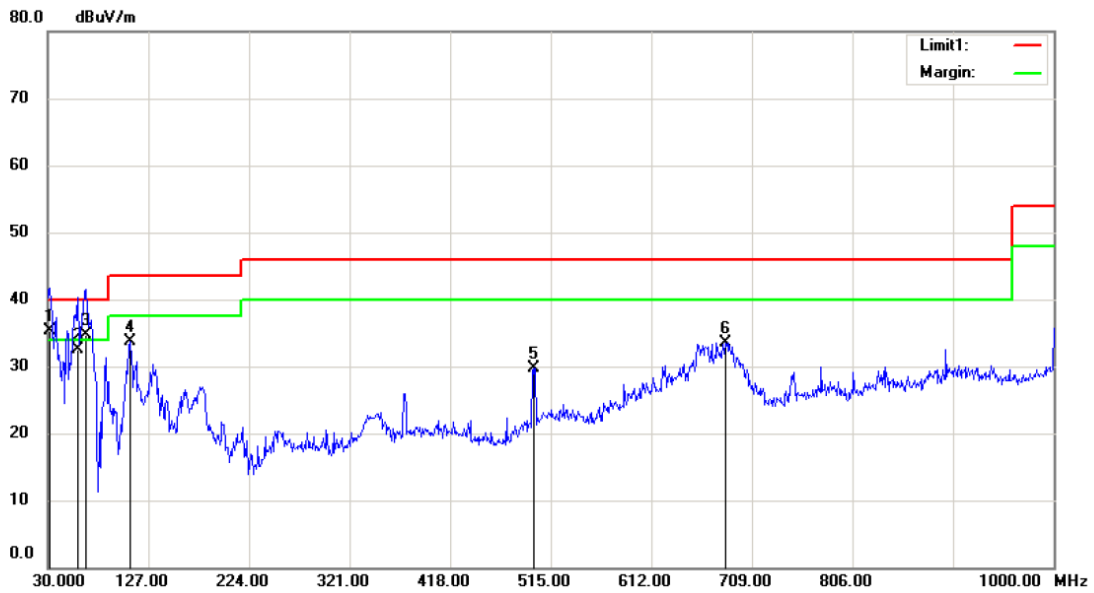

Site 3m Chamber #1 Polarization: **Vertical** Temperature: 24 C  
 Limit: (RE)FCC PART 15C Power: AC 120V/60Hz Humidity: 53 %  
 Mode:TX(2480)  
 Note:

No.	Mk.	Freq.	Reading Level	Correct Factor	Measurement	Limit	Over	Antenna Height	Table Degree	
		MHz	dBuV	dB	dBuV/m	dBuV/m	dB	cm	degree	Comment
1	*	31.9400	49.39	-14.09	35.30	40.00	-4.70			QP
2		59.1000	46.44	-13.94	32.50	40.00	-7.50			QP
3	!	66.8600	51.48	-16.68	34.80	40.00	-5.20			QP
4		109.5400	47.19	-13.51	33.68	43.50	-9.82			QP
5		498.5100	37.46	-7.67	29.79	46.00	-16.21			QP
6		683.7800	39.12	-5.57	33.55	46.00	-12.45			QP

\*:Maximum data x:Over limit !:over margin

Operator: ZHL

## 8.6 CONDUCTED EMISSIONS TEST

### 8.6.1 Applicable Standard

According to FCC Part 15.207(a)

### 8.6.2 Conformance Limit

Frequency(MHz)	Conducted Emission Limit	
	Quasi-peak	Average
0.15-0.5	66-56	56-46
0.5-5.0	56	46
5.0-30.0	60	50

Note: 1. The lower limit shall apply at the transition frequencies  
2. The limit decreases in line with the logarithm of the frequency in the range of 0.15 to 0.50MHz.

### 8.6.3 Test Configuration

Test according to clause 7.3 conducted emission test setup

### 8.6.4 Test Procedure

The EUT was placed on a table which is 0.8m above ground plane.  
Maximum procedure was performed on the highest emissions to ensure EUT compliance.  
Repeat above procedures until all frequency measured were complete.

### 8.6.5 Test Results

All the adapter to be tested under the AC 120 V and AC 240 V voltage, the worst results is recorded in the following page.

Pass

Original test data for adapter 1 and 2:

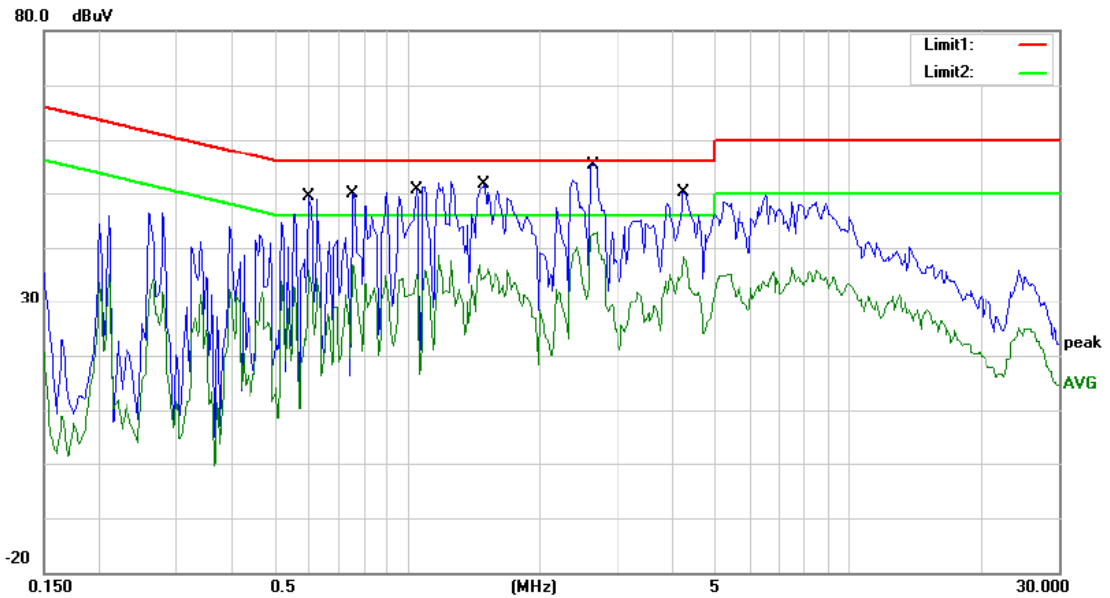

Site Conducted #3 Phase: **L1** Temperature: 23  
 Limit: (CE)FCC PART 15 C Power: AC 120V/60Hz Humidity: 55 %  
 Mode: WIFI+BT ON  
 Note:

No.	Mk.	Freq.	Reading Level	Correct Factor	Measurement	Limit	Over	Detector	Comment
		MHz	dBuV	dB	dBuV	dBuV	dB		
1		0.5950	49.49	0.00	49.49	56.00	-6.51	QP	
2		0.5950	35.98	0.00	35.98	46.00	-10.02	AVG	
3		0.7500	49.89	0.00	49.89	56.00	-6.11	QP	
4		0.7500	36.88	0.00	36.88	46.00	-9.12	AVG	
5		1.0500	50.67	0.00	50.67	56.00	-5.33	QP	
6		1.0500	38.70	0.00	38.70	46.00	-7.30	AVG	
7		1.4950	46.20	0.00	46.20	56.00	-9.80	QP	
8		1.4950	36.86	0.00	36.86	46.00	-9.14	AVG	
9		2.6500	50.60	0.00	50.60	56.00	-5.40	QP	
10	*	2.6500	42.99	0.00	42.99	46.00	-3.01	AVG	
11		4.2300	50.20	0.00	50.20	56.00	-5.80	QP	
12		4.2300	38.30	0.00	38.30	46.00	-7.70	AVG	

\*:Maximum data x:Over limit l:over margin Comment: Factor build in receiver. Operator: KK

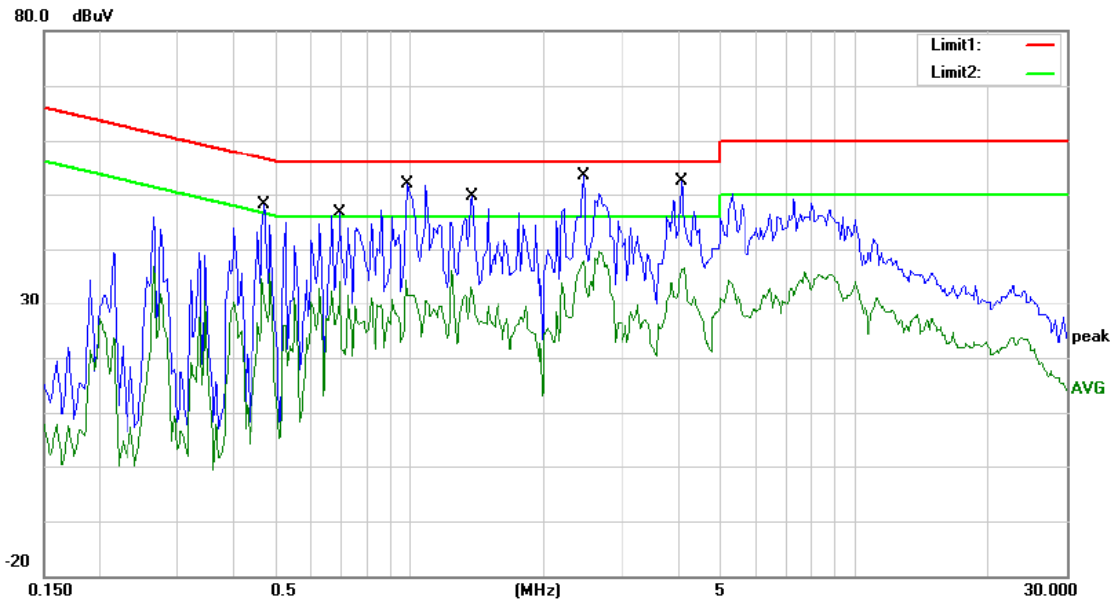

Site Conducted #3 Phase: **N** Temperature: 23  
 Limit: (CE)FCC PART 15 C Power: AC 120V/60Hz Humidity: 55 %  
 Mode: WIFI+BT ON  
 Note:

No.	Mk.	Freq. MHz	Reading Level dBuV	Correct Factor dB	Measure- ment dBuV	Limit dBuV	Over dB	Detector	Comment
1		0.4700	48.15	0.00	48.15	56.51	-8.36	QP	
2		0.4700	35.52	0.00	35.52	46.51	-10.99	AVG	
3		0.6950	46.64	0.00	46.64	56.00	-9.36	QP	
4		0.6950	34.01	0.00	34.01	46.00	-11.99	AVG	
5	*	0.9850	51.85	0.00	51.85	56.00	-4.15	QP	
6		0.9850	34.37	0.00	34.37	46.00	-11.63	AVG	
7		1.3750	49.64	0.00	49.64	56.00	-6.36	QP	
8		1.3750	36.22	0.00	36.22	46.00	-9.78	AVG	
9		2.4500	46.80	0.00	46.80	56.00	-9.20	QP	
10		2.4500	39.51	0.00	39.51	46.00	-6.49	AVG	
11		4.0800	42.80	0.00	42.80	56.00	-13.20	QP	
12		4.0800	36.52	0.00	36.52	46.00	-9.48	AVG	

\*:Maximum data x:Over limit !:over margin Comment: Factor build in receiver. Operator: KK

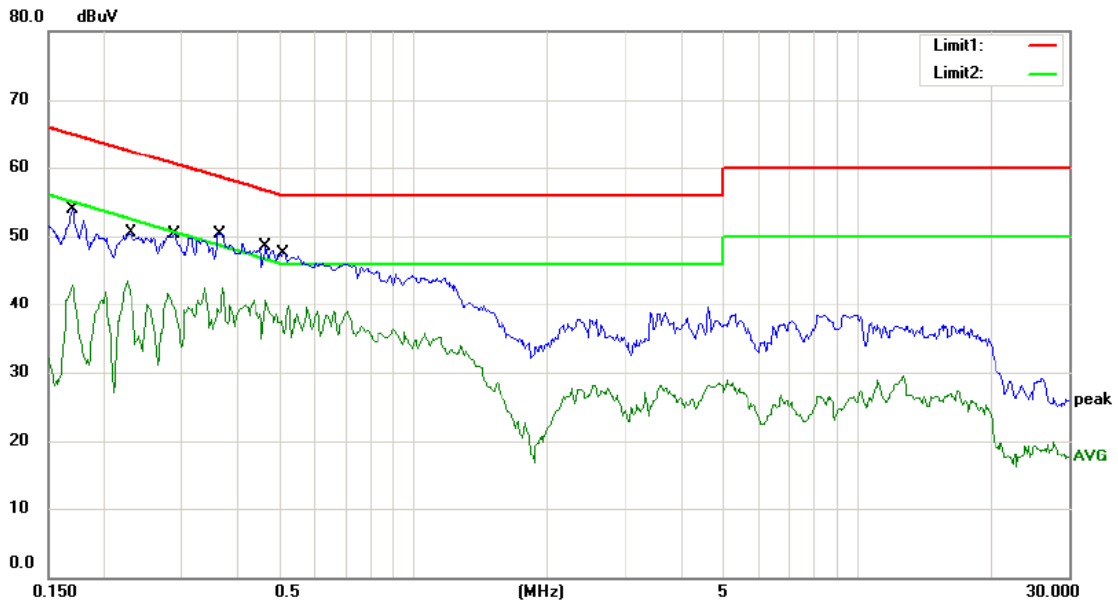

Site: 3m Chamber #2  
 Limit: (CE)FCC PART 15 C  
 Mode: WIFI+Bluetooth ON  
 Note:

Phase: **L1**  
 Power: AC 120V/60Hz

Temperature: 22 C  
 Humidity: 50 %

No.	Mk.	Freq. MHz	Reading Level dBuV	Correct Factor dB	Measure- ment dBuV	Limit dBuV	Over dB	Detector	Comment
1		0.1700	53.94	0.00	53.94	64.96	-11.02	QP	
2		0.1700	42.91	0.00	42.91	54.96	-12.05	AVG	
3		0.2303	50.51	0.00	50.51	62.44	-11.93	QP	
4		0.2303	43.28	0.00	43.28	52.44	-9.16	AVG	
5		0.2878	50.37	0.00	50.37	60.59	-10.22	QP	
6		0.2878	40.30	0.00	40.30	50.59	-10.29	AVG	
7		0.3650	50.35	0.00	50.35	58.61	-8.26	QP	
8		0.3650	42.59	0.00	42.59	48.61	-6.02	AVG	
9		0.4650	48.43	0.00	48.43	56.60	-8.17	QP	
10	*	0.4650	40.69	0.00	40.69	46.60	-5.91	AVG	
11		0.5100	47.58	0.00	47.58	56.00	-8.42	QP	
12		0.5100	39.02	0.00	39.02	46.00	-6.98	AVG	

\*:Maximum data    x:Over limit    !:over margin    Comment: Factor build in receiver.    Operator: KK

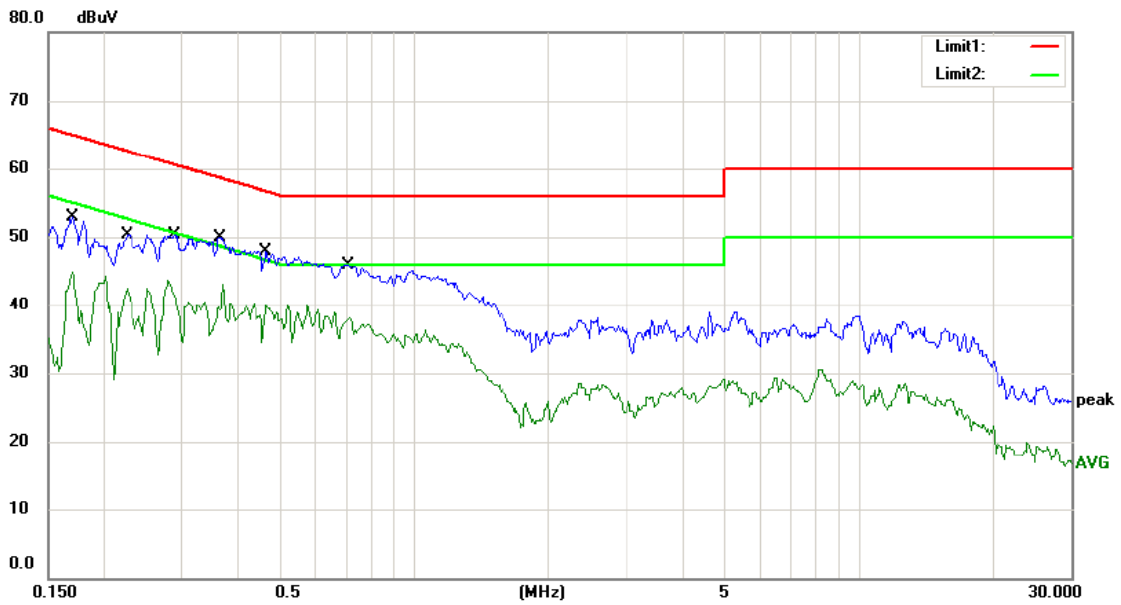

Site 3m Chamber #2 Phase: **N** Temperature: 22 C  
 Limit: (CE)FCC PART 15 C Power: AC 120V/60Hz Humidity: 50 %  
 Mode: WIFI+Bluetooth ON  
 Note:

No.	Mk.	Freq. MHz	Reading Level dBuV	Correct Factor dB	Measure- ment dBuV	Limit dBuV	Over dB	Detector	Comment
1		0.1700	52.94	0.00	52.94	64.96	-12.02	QP	
2		0.1700	44.91	0.00	44.91	54.96	-10.05	AVG	
3		0.2250	50.36	0.00	50.36	62.63	-12.27	QP	
4		0.2250	42.54	0.00	42.54	52.63	-10.09	AVG	
5		0.2878	50.37	0.00	50.37	60.59	-10.22	QP	
6		0.2878	42.30	0.00	42.30	50.59	-8.29	AVG	
7		0.3650	49.85	0.00	49.85	58.61	-8.76	QP	
8	*	0.3650	43.09	0.00	43.09	48.61	-5.52	AVG	
9		0.4650	47.93	0.00	47.93	56.60	-8.67	QP	
10		0.4650	40.19	0.00	40.19	46.60	-6.41	AVG	
11		0.7050	45.97	0.00	45.97	56.00	-10.03	QP	
12		0.7050	38.07	0.00	38.07	46.00	-7.93	AVG	

\*:Maximum data x:Over limit !:over margin Comment: Factor build in receiver. Operator: KK

**Add test results for adapter 3:**

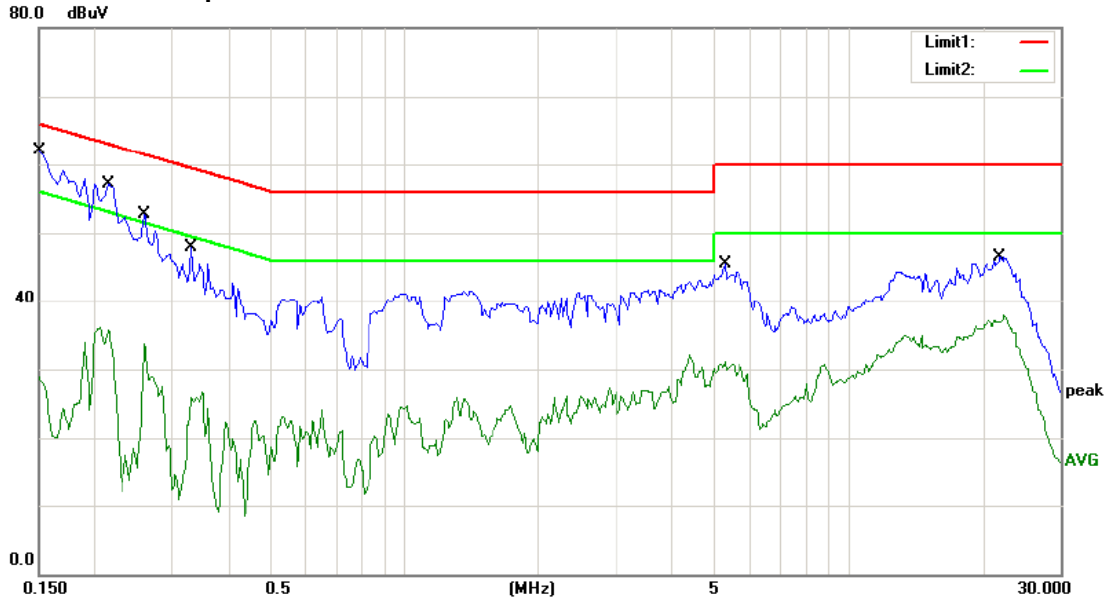

Site Conduction #1 Phase: **L1** Temperature: 26  
 Limit: (CE)FCC Part 15 C Power: AC 230V/50Hz Humidity: 60 %  
 Mode: WIFI+BT ON  
 Note:

No.	Mk.	Freq.	Reading Level	Correct Factor	Measurement	Limit	Over	Detector	Comment
		MHz	dBuV	dB	dBuV	dBuV	dB		
1	*	0.1500	62.01	0.00	62.01	66.00	-3.99	QP	
2		0.1500	28.81	0.00	28.81	56.00	-27.19	AVG	
3		0.2162	56.89	0.00	56.89	62.96	-6.07	QP	
4		0.2162	36.13	0.00	36.13	52.96	-16.83	AVG	
5		0.2600	52.67	0.00	52.67	61.43	-8.76	QP	
6		0.2600	33.70	0.00	33.70	51.43	-17.73	AVG	
7		0.3300	47.82	0.00	47.82	59.45	-11.63	QP	
8		0.3300	26.77	0.00	26.77	49.45	-22.68	AVG	
9		5.2500	45.46	0.00	45.46	60.00	-14.54	QP	
10		5.2500	31.01	0.00	31.01	50.00	-18.99	AVG	
11		22.0500	46.44	0.00	46.44	60.00	-13.56	QP	
12		22.0500	37.92	0.00	37.92	50.00	-12.08	AVG	

\*:Maximum data x:Over limit l:over margin Comment: Factor build in receiver. Operator: Cai



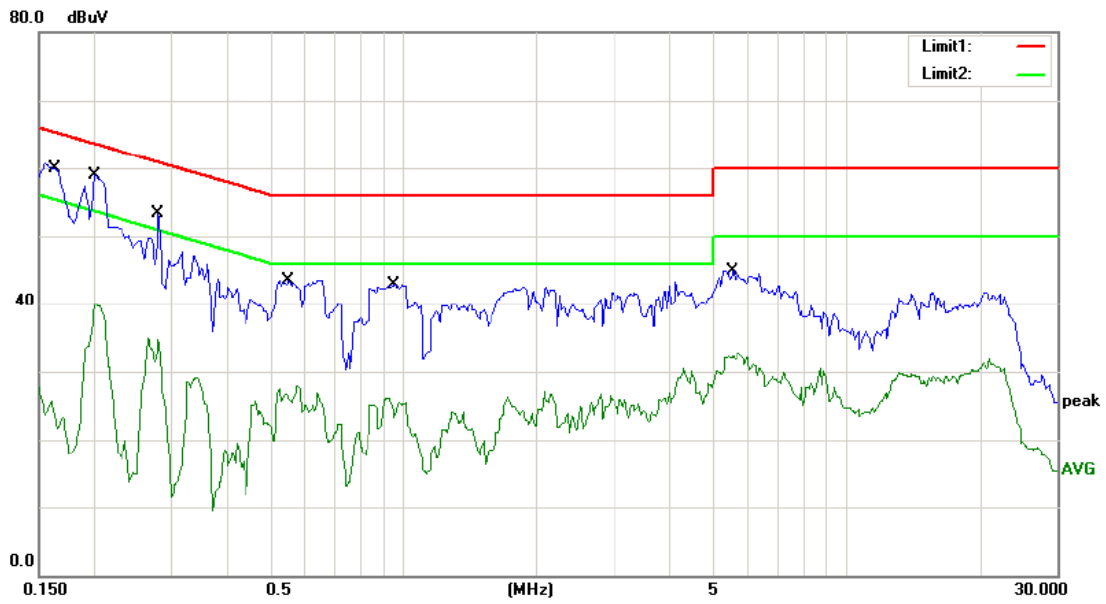

Site Conduction #1  
 Limit: (CE)FCC Part 15 C  
 Mode: WIFI+BT ON  
 Note:

Phase: **N** Temperature: 26  
 Power: AC 230V/50Hz Humidity: 60 %

No.	Mk.	Freq. MHz	Reading Level dBuV	Correct Factor dB	Measure- ment dBuV	Limit dBuV	Over dB	Detector	Comment
1		0.1641	59.78	0.00	59.78	65.25	-5.47	QP	
2		0.1641	27.64	0.00	27.64	55.25	-27.61	AVG	
3	*	0.2000	58.94	0.00	58.94	63.61	-4.67	QP	
4		0.2000	39.89	0.00	39.89	53.61	-13.72	AVG	
5		0.2800	53.21	0.00	53.21	60.82	-7.61	QP	
6		0.2800	34.91	0.00	34.91	50.82	-15.91	AVG	
7		0.5500	43.56	0.00	43.56	56.00	-12.44	QP	
8		0.5500	27.58	0.00	27.58	46.00	-18.42	AVG	
9		0.9550	42.87	0.00	42.87	56.00	-13.13	QP	
10		0.9550	26.19	0.00	26.19	46.00	-19.81	AVG	
11		5.5600	44.96	0.00	44.96	60.00	-15.04	QP	
12		5.5600	32.76	0.00	32.76	50.00	-17.24	AVG	

\*:Maximum data x:Over limit l:over margin Comment: Factor build in receiver. Operator: Cai

## 8.7 ANTENNA APPLICATION

### 8.7.1 Antenna Requirement

Standard	Requirement
FCC CRF Part 15.203	An intentional radiator shall be designed to ensure that no antenna other than that furnished by the responsible party shall be used with the device. The use of a permanently attached antenna or of an antenna that uses a unique coupling to the intentional radiator shall be considered sufficient to comply with the provisions of this section. The manufacturer may design the unit so that a broken antenna can be replaced by the user, but the use of a standard antenna jack or electrical connector is prohibited. This requirement does not apply to carrier current devices or to devices operated under the provisions of §15.211, §15.213, §15.217, §15.219, or §15.221. Further, this requirement does not apply to intentional radiators that must be professionally installed, such as perimeter protection systems and some field disturbance sensors, or to other intentional radiators which, in accordance with §15.31(d), must be measured at the installation site. However, the installer shall be responsible for ensuring that the proper antenna is employed so that the limits in this part are not exceeded.

For intentional device, according to FCC 47 CFR Section 15.203, an intentional radiator shall be designed to ensure that no antenna other than that furnished by the responsible party shall be used with the device. And according to FCC 47 CFR Section 15.247 (b), if transmitting antennas of directional gain greater than 6dBi are used, the power shall be reduced by the amount in dB that the directional gain of the antenna exceeds 6dBi.

### 8.7.2 Result

The EUT has a Integral antenna, the antenna is permanent attached antenna, the gain is 2.0 dBi, which in accordance to section 15.203, please refer to the internal photos.