

**ELECTROMAGNETIC EMISSIONS COMPLIANCE REPORT  
INTENTIONAL RADIATOR CERTIFICATION TO  
FCC PART 15 SUBPART C AND CANADIAN RSS 210 ISSUE 8  
REQUIREMENTS**

*OF*

**nextbook**

**MODEL No.: NX785QC8G**

**FCC ID: S7JNX785QC**

**IC ID: 8082A-NX785QC**

**Trademark: N/A**

**REPORT NO.: ES131228327E**

**ISSUE DATE: January 16, 2014**

*Prepared for*

**SHENZHEN YIFANG DIGITAL TECHNOLOGY CO., LTD.  
Building NO.22, 23, Fifth Region, Baiwangxin Industrial Park, Songbai Rd.,  
Nanshan, Shenzhen 518108, China**

*Prepared by*

**SHENZHEN EMTEK CO., LTD**

**Bldg 69, Majialong Industry Zone, Nanshan District,  
Shenzhen, Guangdong, China  
TEL: 86-755-26954280  
FAX: 86-755-26954282**

## VERIFICATION OF COMPLIANCE

Applicant:	SHENZHEN YIFANG DIGITAL TECHNOLOGY CO., LTD. Building NO.22, 23, Fifth Region, Baiwangxin Industrial Park, Songbai Rd., Nanshan, Shenzhen 518108, China
Manufacturer:	SHENZHEN YIFANG DIGITAL TECHNOLOGY CO., LTD. Building NO.22, 23, Fifth Region, Baiwangxin Industrial Park, Songbai Rd., Nanshan, Shenzhen 518108, China
Product Description:	nextbook
Model Number:	NX785QC8G
File Number:	ES131228327E
Date of Test:	January 2, 2014 to January 14, 2014

### We hereby certify that:

The above equipment was tested by SHENZHEN EMTEK CO., LTD. The test data, data evaluation, test procedures, and equipment configurations shown in this report were made in accordance with the procedures given in ANSI C63.4 (2009) and the energy emitted by the sample EUT tested as described in this report is in compliance with conducted and radiated emission limits of FCC Rules Part 15.247 and Canadian RSS 210 ISSUE 8 REQUIREMENTS

The test results of this report relate only to the tested sample identified in this report.

Date of Test : January 2, 2014 to January 14, 2014

Prepared by :   
Joe Xia/Editor

Reviewer :   
June Xie/Supervisor

Approve & Authorized Signer :   
Lisa Wang/Manager

## Table of Contents

<b>1. GENERAL INFORMATION .....</b>	<b>5</b>
1.1 PRODUCT DESCRIPTION .....	5
1.2 RELATED SUBMITTAL(S) / GRANT(S).....	5
1.3 TEST METHODOLOGY .....	6
1.4 SPECIAL ACCESSORIES.....	6
1.5 EQUIPMENT MODIFICATIONS .....	6
1.6 TEST FACILITY .....	6
<b>2. SYSTEM TEST CONFIGURATION .....</b>	<b>7</b>
2.1 EUT CONFIGURATION.....	7
2.2 EUT EXERCISE .....	7
2.3 TEST PROCEDURE .....	7
2.4 CONFIGURATION OF TESTED SYSTEM .....	7
<b>3. DESCRIPTION OF TEST MODES .....</b>	<b>9</b>
<b>4. SUMMARY OF TEST RESULTS.....</b>	<b>10</b>
<b>5. CONDUCTED EMISSIONS TEST .....</b>	<b>11</b>
5.1 MEASUREMENT PROCEDURE .....	11
5.2 TEST SET-UP (BLOCK DIAGRAM OF CONFIGURATION) .....	11
5.3 MEASUREMENT EQUIPMENT USED .....	11
5.4 CONDUCTED EMISSION LIMIT .....	11
5.5 MEASUREMENT RESULT.....	12
<b>6. RADIATED EMISSION TEST .....</b>	<b>14</b>
6.1 MEASUREMENT PROCEDURE .....	14
6.2 TEST SET-UP (BLOCK DIAGRAM OF CONFIGURATION) .....	14
6.3 MEASUREMENT EQUIPMENT USED .....	15
6.4 RADIATED EMISSION LIMIT.....	15
6.5 MEASUREMENT RESULT.....	17
<b>7. 6DB BANDWIDTH TEST AND 99% BANDWIDTH TEST .....</b>	<b>23</b>
7.1 MEASUREMENT PROCEDURE .....	23
7.2 TEST SET-UP (BLOCK DIAGRAM OF CONFIGURATION) .....	23
7.3 MEASUREMENT EQUIPMENT USED .....	23
7.4 MEASUREMENT RESULTS .....	23
<b>8. MAXIMUM PEAK OUTPUT POWER TEST.....</b>	<b>36</b>
8.1 MEASUREMENT PROCEDURE .....	36
8.2 TEST SET-UP (BLOCK DIAGRAM OF CONFIGURATION) .....	36
8.3 MEASUREMENT EQUIPMENT USED .....	36
8.4 PEAK POWER OUTPUT LIMIT .....	36
8.5 MEASUREMENT RESULTS.....	36
<b>9. BAND EDGE TEST .....</b>	<b>38</b>
9.1 MEASUREMENT PROCEDURE .....	38
9.2 TEST SET-UP (BLOCK DIAGRAM OF CONFIGURATION) .....	38
9.3 MEASUREMENT EQUIPMENT USED .....	38
9.4 MEASUREMENT RESULTS .....	38
<b>10. POWER DENSITY .....</b>	<b>40</b>
10.1 TEST EQUIPMENT .....	40

10.2	MEASURING INSTRUMENTS AND SETTING.....	40
10.3	TEST PROCEDURES .....	40
10.4	BLOCK DIAGRAM OF TEST SETUP .....	40
10.5	LIMIT .....	40
10.6	TEST RESULT .....	41
<b>11.</b>	<b>ANTENNA PORT EMISSION .....</b>	<b>47</b>
11.1	TEST EQUIPMENT .....	47
11.2	MEASURING INSTRUMENTS AND SETTING.....	47
11.3	TEST PROCEDURES .....	47
11.4	BLOCK DIAGRAM OF TEST SETUP .....	47
11.5	TEST RESULT .....	47
<b>12.</b>	<b>ANTENNA APPLICATION.....</b>	<b>51</b>
12.1	ANTENNA REQUIREMENT.....	51
12.2	RESULT .....	51
<b>13.</b>	<b>UNCERTAINTY .....</b>	<b>52</b>

## 1. General Information

### 1.1 Product Description

A major technical descriptions of EUT is described as following:

- A). Standards: FCC Rules Part 15.247 and Canadian RSS 210 ISSUE 8
- B). Operation Frequency: WIFI: 2412-2462MHz;
- C). Modulation: OFDM with BPSK/QPSK/16QAM/64QAM for 802.11g/n,  
DSSS with DBPSK/DQPSK/CCK for 802.11b;
- D). Number of Channel: 802.11b/g/n: 11Channels;
- E). Conducted Power: 9.82dBm(802.11b), 9.07dBm(802.11g), 8.78dBm(802.11n);
- F) Antenna Gain: 1dBi
- G). Antenna Type: PCB Antenna
- H). Power Supply: DC 5V with AC Adapter and DC 3.7V from Li-ion Battery.
- I). Adapter : Model: HNEA050150UU  
 Input: AC 100-240V, 50/60Hz,0.35A Max  
 Output: DC 5.0V, 1.5A

Channel	Frequency (MHz)	Channel	Frequency (MHz)	Channel	Frequency (MHz)
1	2412	5	2432	9	2452
2	2417	6	2437	10	2457
3	2422	7	2442	11	2462
4	2427	8	2447		

Note:

1. This device is Tablet included 802.11b, 802.11g, 802.11n 2.4GHz transceiver function.
2. Test of channel was included the lowest middle and highest frequency in lowest data rate and to perform the test, then record on this report.

### 1.2 Related Submittal(s) / Grant(s)

This submittal(s) (test report) is intended for FCC ID: S7JNX785QC filing to comply with Section 15.247 of the FCC Part 15, Subpart C Rules and also intended for IC ID: 8082A-NX785QC filing to comply with Canadian RSS 210 Issue 8.0. The composite system is compliance with Subpart B is authorized under a DOC procedure.

### 1.3 Test Methodology

All the test program has follow FCC new test procedure KDB558074 D01 v03r01, Both conducted and radiated testing was performed according to the procedures in ANSI C63.10 (2009). Radiated testing was performed at an antenna to EUT distance 3 meters.

### 1.4 Special Accessories

Not available for this EUT intended for grant.

### 1.5 Equipment Modifications

Not available for this EUT intended for grant.

### 1.6 Test Facility

#### Site Description

EMC Lab. : Accredited by CNAS, 2013.10.29  
The certificate is valid until 2016.10.28  
The Laboratory has been assessed and proved to be in compliance with CNAS/CL01: 2006(identical to ISO/IEC17025: 2005)  
The Certificate Registration Number is L2291

Accredited by TUV Rheinland Shenzhen 2010.5.25  
The Laboratory has been assessed according to the requirements ISO/IEC 17025

Accredited by FCC, October 28, 2010  
The Certificate Registration Number is 406365.

Accredited by Industry Canada, March 05, 2010  
The Certificate Registration Number is 46405-4480.

Name of Firm : SHENZHEN EMTEK CO., LTD.  
Site Location : Bldg 69, Majialong Industry Zone,  
Nanshan District, Shenzhen, Guangdong, China

## 2. System Test Configuration

### 2.1 EUT Configuration

The EUT configuration for testing is installed on RF field strength measurement to meet the Commissions requirement and operating in a manner which intends to maximize its emission characteristics in a continuous normal application.

### 2.2 EUT Exercise

The Transmitter was operated in the normal operating mode. The TX frequency was fixed which was for the purpose of the measurements.

### 2.3 Test Procedure

#### 2.3.1 Conducted Emissions

The EUT is a placed on as turn table which is 0.8 m above ground plane. According to the requirements in Section 13.1.4.1 of ANSI C63.4-2009 Conducted emissions from the EUT measured in the frequency range between 0.15 MHz and 30 MHz using CISPR Quasi-Peak and average detector mode.

#### 2.3.2 Radiated Emissions

The EUT is a placed on as turn table which is 0.8 m above ground plane. The turn table shall rotate 360 degrees to determine the position of maximum emission level. EUT is set 3m away from the receiving antenna which varied from 1m to 4m to find out the highest emission. And also, each emission was to be maximized by changing the polarization of receiving antenna both horizontal and vertical. In order to find out the max. Emission, the relative positions of this hand-held transmitter (EUT) was rotated through three orthogonal axes according to the requirements in Section 13.1.4.1 of ANSI C63.4-2009.

### 2.4 Configuration of Tested System

**Fig. 2-1 Configuration of Tested System**

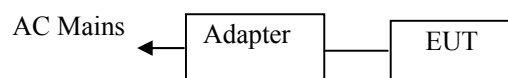

**Table 2-1 Equipment Used in Tested System**

Item	Equipment	Mfr/Brand	Model/Type No.	FCC ID	IC ID	Series No.	Note
1.	nextbook	N/A	NX785QC8G	S7JNX785QC	8082A-NX785QC	N/A	EUT
2.	Earphone	N/A	N/A	N/A	N/A	N/A	

**Note:**

- (1) Unless otherwise denoted as EUT in 『Remark』 column, device(s) used in tested system is a support equipment.



### **3. Description of Test Modes**

The Transmitter of EUT is an Mobile Internet Device and powered by host equipment; these is Digital Transmission system (DTS) and have modulation OFDM, DSSS, DBPSK, DQPSK, CCK, 16QAM, 64QAM. According exploratory test, EUT will have maximum output power in those data rate (802.11b: 1 Mbps; 802.11g: 6 Mbps; 802.11n: MCS0), so those data rate were used for all test.

The equipment enables high-speed access without wires to network assets. This adapter uses the IEEE 802.11 protocol to enable wireless communications between the host and Wireless router.

For 802.11b/g/n:

1. For lowest channel : 2412MHz (Channel 1)
2. For middle channel : 2437MHz (Channel 6)
3. For highest channel : 2462MHz (Channel 11)

#### 4. Summary of Test Results

<b>FCC Rules</b>	<b>IC Rule</b>	<b>Description Of Test</b>	<b>Result</b>
§15.247(a)(2)	RSS-210, A8.2(a)	6dB bandwidth	Pass
§15.247(b)(3)	RSS-210, A8.4(2)	Max Peak output Power test	Pass
§15.247(e)	RSS-210, A8.2(b)	Power density	Pass
§15.247(d)	RSS-210, A2.9, A8.5	Band edge test	Pass
§15.207	RSS-GEN, Section 7.2.2	AC Power Conducted Emission	Pass
§15.247(d), §15.209	RSS-210, A2.9, A8.5	Radiated Emission	Pass
§15.247(d)	RSS-210, A8.5 RSS-GEN, Section 7.2.3	Antenna Port Emission	Pass
§15.247(b)&§15.203	N/A	Antenna Application	Pass
N/A	RSS-210, A1.1.3	99%dB Bandwidth	Pass

## 5. Conducted Emissions Test

### 5.1 Measurement Procedure

1. The EUT was placed on a table which is 0.8m above ground plane.
2. Maximum procedure was performed on the six highest emissions to ensure EUT compliance.
3. Repeat above procedures until all frequency measured were complete.

### 5.2 Test SET-UP (Block Diagram of Configuration)

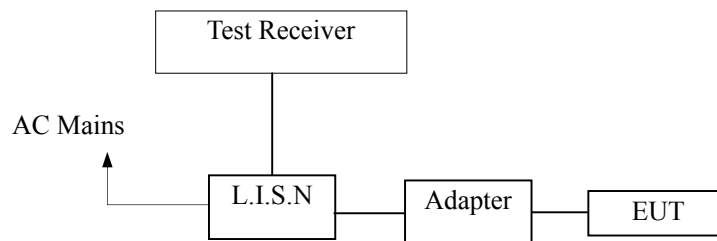

### 5.3 Measurement Equipment Used

Conducted Emission Test Site					
EQUIPMENT TYPE	MFR	MODEL NUMBER	SERIAL NUMBER	LAST CAL.	CAL DUE.
Test Receiver	Rohde & Schwarz	ESCS30	828985/018	05/28/2013	05/27/2014
L.I.S.N.	Schwarzbeck	NNLK8129	8129203	05/28/2013	05/27/2014
50Ω Coaxial Switch	Anritsu	MP59B	M20531	N/A	N/A
Pulse Limiter	Rohde & Schwarz	ESH3-Z2	100006	05/28/2013	05/27/2014
Voltage Probe	Rohde & Schwarz	TK9416	N/A	05/28/2013	05/27/2014
I.S.N	Rohde & Schwarz	ENY22	1109.9508.02	05/28/2013	05/27/2014

### 5.4 Conducted Emission Limit

Conducted Emission Frequency(MHz)	Quasi-peak	Average
0.15-0.5	66-56	56-46
0.5-5.0	56	46
5.0-30.0	60	50

- Note:** 1. The lower limit shall apply at the transition frequencies  
 2. The limit decreases in line with the logarithm of the frequency in the range of 0.15 to 0.50MHz.

### 5.5 Measurement Result

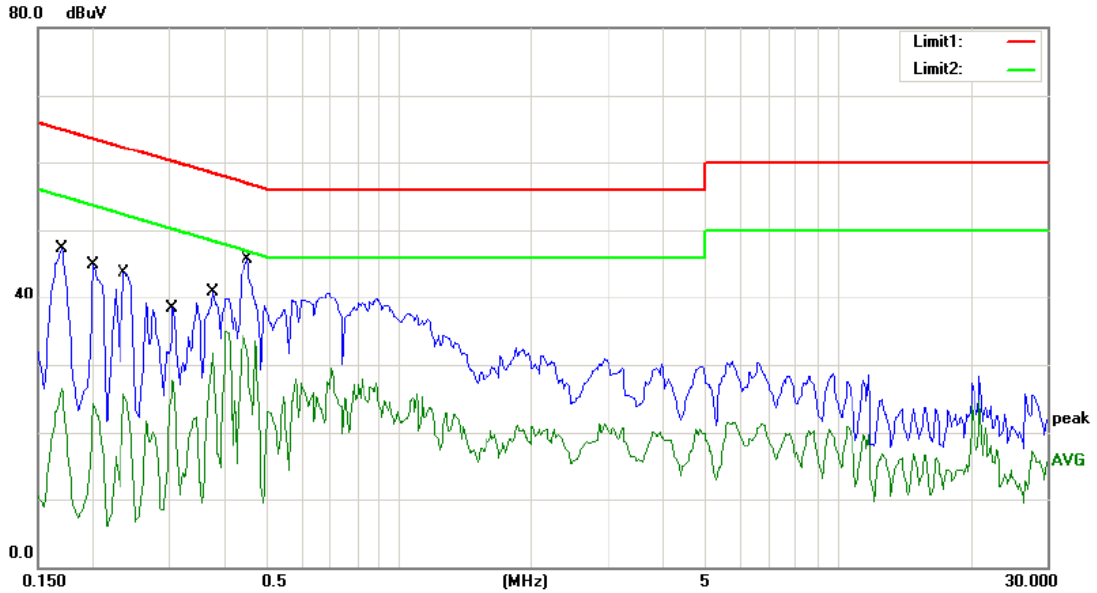

Site Conduction #1 Phase: **N** Temperature: 24  
 Limit: (CE)FCC PART 15 class B\_QP Power: AC 120V/60Hz Humidity: 53 %  
 Mode: WIFI ON  
 Note:

No. Mk.	Freq. MHz	Reading Level dBuV	Correct Factor dB	Measure- ment dBuV	Limit dBuV	Over dB	Detector	Comment
1	0.1700	47.36	0.00	47.36	64.96	-17.60	QP	
2	0.1700	26.53	0.00	26.53	54.96	-28.43	AVG	
3	0.2000	44.93	0.00	44.93	63.61	-18.68	QP	
4	0.2000	24.21	0.00	24.21	53.61	-29.40	AVG	
5	0.2350	43.73	0.00	43.73	62.27	-18.54	QP	
6	0.2350	25.79	0.00	25.79	52.27	-26.48	AVG	
7	0.3050	38.39	0.00	38.39	60.11	-21.72	QP	
8	0.3050	27.67	0.00	27.67	50.11	-22.44	AVG	
9	0.3750	40.99	0.00	40.99	58.39	-17.40	QP	
10	0.3750	31.74	0.00	31.74	48.39	-16.65	AVG	
11 *	0.4500	45.64	0.00	45.64	56.88	-11.24	QP	
12	0.4500	34.20	0.00	34.20	46.88	-12.68	AVG	

\*:Maximum data x:Over limit !:over margin Comment: Factor build in receiver. Operator: FENG

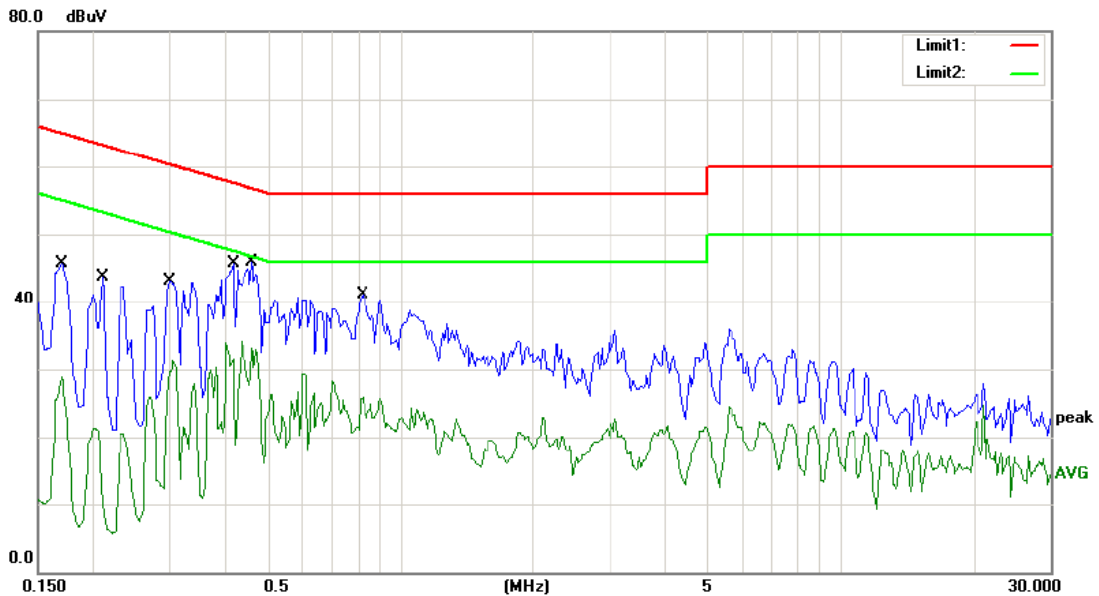

Site Conduction #1 Phase: **L1** Temperature: 24  
 Limit: (CE)FCC PART 15 class B\_QP Power: AC 120V/60Hz Humidity: 53 %  
 Mode: WIFI ON  
 Note:

No.	Mk.	Freq. MHz	Reading Level dBuV	Correct Factor dB	Measure- ment dBuV	Limit dBuV	Over dB	Detector	Comment
1		0.1700	45.71	0.00	45.71	64.96	-19.25	QP	
2		0.1700	28.85	0.00	28.85	54.96	-26.11	AVG	
3		0.2100	43.66	0.00	43.66	63.21	-19.55	QP	
4		0.2100	21.37	0.00	21.37	53.21	-31.84	AVG	
5		0.3000	43.07	0.00	43.07	60.24	-17.17	QP	
6		0.3000	31.22	0.00	31.22	50.24	-19.02	AVG	
7		0.4150	45.65	0.00	45.65	57.55	-11.90	QP	
8		0.4150	33.96	0.00	33.96	47.55	-13.59	AVG	
9	*	0.4600	45.80	0.00	45.80	56.69	-10.89	QP	
10		0.4600	34.15	0.00	34.15	46.69	-12.54	AVG	
11		0.8200	41.11	0.00	41.11	56.00	-14.89	QP	
12		0.8200	26.87	0.00	26.87	46.00	-19.13	AVG	

\*:Maximum data x:Over limit !:over margin Comment: Factor build in receiver. Operator: FENG

## 6. Radiated Emission Test

### 6.1 Measurement Procedure

1. The EUT was placed on a turntable which is 0.8m above ground plane.
2. Maximum procedure was performed on the six highest emissions to ensure EUT compliance.
3. And also, each emission was to be maximized by changing the polarization of receiving antenna both horizontal and vertical.
4. Repeat above procedures until all frequency measured was complete.

For emissions measurement set the bandwidth of the Spectrum's RBW at 1MHz above 1GHz and RBW 100 KHz below 1GHz.

### 6.2 Test SET-UP (Block Diagram of Configuration)

(A) Radiated Emission Test Set-Up, Frequency Below 30MHz

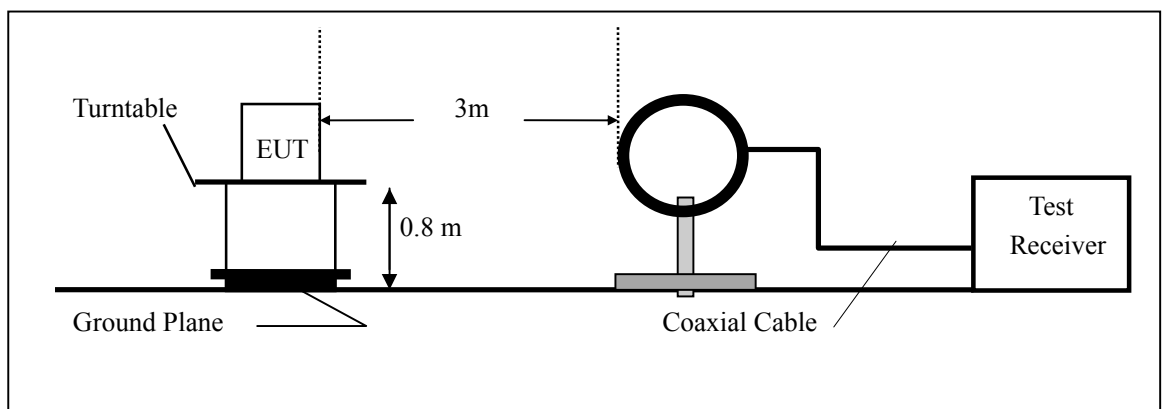

(B) Radiated Emission Test Set-Up, Frequency Below 1000MHz

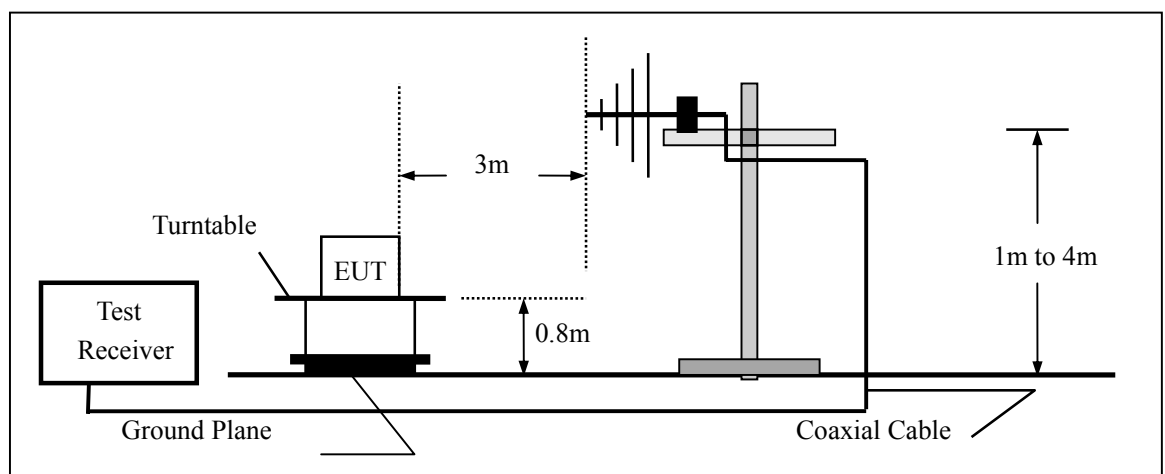

(C) Radiated Emission Test Set-Up, Frequency above 1000MHz

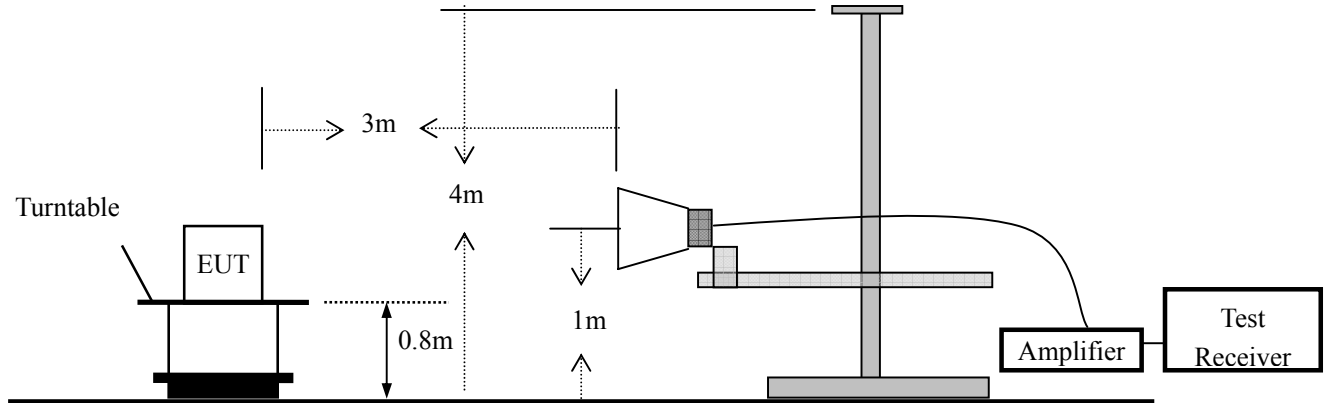

**6.3 Measurement Equipment Used**

EQUIPMENT TYPE	MFR	MODEL NUMBER	SERIAL NUMBER	LAST CAL.	CAL DUE.
EMI Test Receiver	Rohde & Schwarz	ESU	1302.6005.26	05/28/2013	05/27/2014
Pre-Amplifier	HP	8447D	2944A07999	05/28/2013	05/27/2014
Bilog Antenna	Schwarzbeck	VULB9163	142	05/14/2013	05/13/2014
Loop Antenna	ARA	PLA-1030/B	1029	05/14/2013	05/13/2014
Horn Antenna	Schwarzbeck	BBHA 9170	BBHA9170399	05/14/2013	05/13/2014
Horn Antenna	Schwarzbeck	BBHA 9120	D143	05/14/2013	05/13/2014
Cable	Schwarzbeck	AK9513	ACRX1	05/28/2013	05/27/2014
Cable	Rosenberger	N/A	FP2RX2	05/28/2013	05/27/2014
Cable	Schwarzbeck	AK9513	CRPX1	05/28/2013	05/27/2014
Cable	Schwarzbeck	AK9513	CRRX2	05/28/2013	05/27/2014

**6.4 Radiated Emission Limit**

The emissions from an intentional radiator shall not exceed the field strength levels specified in the following table 15.209(a):

Frequencies (MHz)	Field Strength (micovolts/meter)	Measurement Distance (meters)
0.009~0.490	2400/F(KHz)	300
0.490~1.705	24000/F(KHz)	30
1.705~30.0	30	30
30~88	100	3
88~216	150	3
216~960	200	3
Above 960	500	3

15.205 Restricted bands of operation

MHz	MHz	MHz	GHz
0.090 - 0.110	16.42 - 16.423	399.9 - 410	4.5 - 5.15
<sup>1</sup> 0.495 - 0.505	16.69475 - 16.69525	608 - 614	5.35 - 5.46
2.1735 - 2.1905	16.80425 - 16.80475	960 - 1240	7.25 - 7.75
4.125 - 4.128	25.5 - 25.67	1300 - 1427	8.025 - 8.5
4.17725 - 4.17775	37.5 - 38.25	1435 - 1626.5	9.0 - 9.2
4.20725 - 4.20775	73 - 74.6	1645.5 - 1646.5	9.3 - 9.5
6.215 - 6.218	74.8 - 75.2	1660 - 1710	10.6 - 12.7
6.26775 - 6.26825	108 - 121.94	1718.8 - 1722.2	13.25 - 13.4
6.31175 - 6.31225	123 - 138	2200 - 2300	14.47 - 14.5
8.291 - 8.294	149.9 - 150.05	2310 - 2390	15.35 - 16.2
8.362 - 8.366	156.52475 - 156.52525	2483.5 - 2500	17.7 - 21.4
8.37625 - 8.38675	156.7 - 156.9	2690 - 2900	22.01 - 23.12
8.41425 - 8.41475	162.0125 - 167.17	3260 - 3267	23.6 - 24.0
12.29 - 12.293	167.72 - 173.2	3332 - 3339	31.2 - 31.8
12.51975 - 12.52025	240 - 285	3345.8 - 3358	36.43 - 36.5
12.57675 - 12.57725	322 - 335.4	3600 - 4400	( <sup>2</sup> )

- Remark:
1. Emission level in dBuV/m=20 log (uV/m)
  2. Measurement was performed at an antenna to the closed point of EUT distance of meters.
  3. Only spurious frequency is permitted to locate within the Restricted Bands specified in provision of § 15.205, and the emissions located in restricted bands also comply with 15.209 limit.



### 6.5 Measurement Result

Below 1GHz:

All the modulation modes were tested the data of the worst mode (802.11b) are recorded in the following pages.

Operation Mode: TX Mode Test Date : January 14, 2014  
 Frequency Range: 9KHz~30MHz Temperature : 28°C  
 Test Result: PASS Humidity : 65 %  
 Measured Distance: 3m Test By: WOLF

Note:

Freq. (MHz)	Ant.Pol. H/V	Emission Level (dBuV/m)	Limit 3m (dBuV/m)	Over (dB)
--	--	--	--	--

Note: the amplitude of spurious emission that is attenuated by more than 20dB below the permissible limit has no need to be reported.

Distance extrapolation factor =  $40 \log(\text{Specific distance} / \text{test distance})$  (dB);

Limit line = Specific limits (dBuV) + distance extrapolation factor.

Operation Mode: 802.11b TX Channel 1 Test Date : January 14, 2014  
 Frequency Range: 30~1000MHz Temperature : 28°C  
 Test Result: PASS Humidity : 65 %  
 Measured Distance: 3m Test By: WOLF

Note:

Freq. (MHz)	Ant.Pol. H/V	Emission Level (dBuV/m)	Limit 3m (dBuV/m)	Over (dB)	Note
39.33	V	33.66	40.00	-6.34	QP
51.76	V	34.82	40.00	-5.18	QP
62.64	V	32.74	40.00	-7.26	QP
126.38	V	42.13	43.50	-1.37	QP
190.11	V	32.34	43.50	-11.16	QP
891.19	V	33.45	46.00	-12.55	QP
54.87	H	31.31	40.00	-8.69	QP
78.19	H	33.56	40.00	-6.44	QP
126.38	H	36.89	43.50	-6.61	QP
190.11	H	36.75	43.50	-6.75	QP
205.66	H	33.11	43.50	-10.39	QP
445.05	H	32.08	46.00	-13.92	QP

- Note:**
- (1) All Readings are Peak Value.
  - (2) Emission Level = Reading Level + Probe Factor + Cable Loss.
  - (3) The average measurement was not performed when the peak measured data under the limit of average detection.
  - (4) EUT stood on the table position is the worst case result in the report.

Operation Mode: 802.11b TX Channel 6 Test Date : January 14, 2014  
 Frequency Range: 30~1000MHz Temperature : 28°C  
 Test Result: PASS Humidity : 65 %  
 Measured Distance: 3m Test By: WOLF

Freq. (MHz)	Ant.Pol. H/V	Emission Level (dBuV/m)	Limit 3m (dBuV/m)	Over (dB)	Note
37.77	V	32.35	40.00	-7.65	QP
51.76	V	35.22	40.00	-4.78	QP
62.64	V	33.87	40.00	-6.13	QP
126.38	V	42.03	43.50	-1.47	QP
190.11	V	32.20	43.50	-11.30	QP
892.74	V	33.45	46.00	-12.55	QP
54.87	H	31.70	40.00	-8.30	QP
78.19	H	33.16	40.00	-6.84	QP
126.38	H	36.50	43.50	-7.00	QP
190.11	H	33.69	43.50	-9.81	QP
207.21	H	32.10	43.50	-11.40	QP
445.05	H	34.95	46.00	-11.05	QP

- Note:**
- (1) All Readings are Peak Value.
  - (2) Emission Level= Reading Level+Probe Factor +Cable Loss.
  - (3) The average measurement was not performed when the peak measured data under the limit of average detection.
  - (4) EUT stood on the table position is the worst case result in the report.

Operation Mode: 802.11b TX Channel 11 Test Date : January 14, 2014  
 Frequency Range: 30~1000MHz Temperature : 28°C  
 Test Result: PASS Humidity : 65 %  
 Measured Distance: 3m Test By: WOLF

Freq. (MHz)	Ant.Pol. H/V	Emission Level (dBuV/m)	Limit 3m (dBuV/m)	Over (dB)	Note
40.88	V	33.06	40.00	-6.94	QP
51.76	V	34.12	40.00	-5.88	QP
62.64	V	32.74	40.00	-7.26	QP
126.38	V	42.13	43.50	-1.37	QP
190.11	V	32.56	43.50	-10.94	QP
445.05	V	34.09	46.00	-11.91	QP
54.87	H	31.46	40.00	-8.54	QP
78.19	H	33.56	40.00	-6.44	QP
126.38	H	36.72	40.00	-3.28	QP
190.11	H	36.23	43.50	-7.27	QP
208.77	H	33.42	43.50	-10.08	QP
445.05	H	32.69	46.00	-13.31	QP

- Note:**
- (1) All Readings are Peak Value.
  - (2) Emission Level= Reading Level+Probe Factor +Cable Loss.
  - (3) The average measurement was not performed when the peak measured data under the limit of average detection.
  - (4) EUT stood on the table position is the worst case result in the report.

**Above 1GHz:**

Operation Mode: 802.11b TX Channel 1      Test Date : January 14, 2014  
 Frequency Range: 1GHz~25GHz      Temperature : 28°C  
 Test Result: PASS      Humidity : 65 %  
 Measured Distance: 3m      Test By: WOLF

Freq. (MHz)	Ant.Pol. H/V	Emission Level(dBuV/m)		Limit 3m(dBuV/m)		Over(dB)	
		PK	AV	PK	AV	PK	AV
4843.21	V	51.29	36.02	74	54	-21.64	-18.22
7246.55	V	52.33	35.09	74	54	-20.79	-17.47
9652.37	V	51.87	39.23	74	54	-22.81	-19.08
--	--	--	--	--	--	--	--
--	--	--	--	--	--	--	--
--	--	--	--	--	--	--	--
4844.63	H	52.82	36.05	74	54	-21.15	-17.95
7246.92	H	51.09	35.48	74	54	-22.79	-18.52
9645.39	H	51.16	34.91	74	54	-21.69	-18.25

**All emissions not reported were more than 20dB below the specified limit or in the noise floor.**

- Note:**
- (1) All Readings are Peak Value and AV.
  - (2) Emission Level= Reading Level+Probe Factor +Cable Loss.
  - (3) Data of measurement within this frequency range shown “ -- ” in the table above means the reading of emissions are attenuated more than 20dB below the permissible limits or the field strength is too small to be measured.

Operation Mode: 802.11b TX Channel 6 Test Date : January 14, 2014  
 Frequency Range: 1GHz~25GHz Temperature : 28°C  
 Test Result: PASS Humidity : 65 %  
 Measured Distance: 3m Test By: WOLF

Freq. (MHz)	Ant.Pol. H/V	Emission Level(dBuV/m)		Limit 3m(dBuV/m)		Over(dB)	
		PK	AV	PK	AV	PK	AV
4896.65	V	51.77	35.47	74.00	54.00	-22.23	-18.53
7317.60	V	52.36	35.80	74.00	54.00	-21.64	-18.20
9752.00	V	52.54	35.59	74.00	54.00	-21.46	-18.41
--	--	--	--	--	--	--	--
--	--	--	--	--	--	--	--
--	--	--	--	--	--	--	--
4896.28	H	52.40	35.78	74.00	54.00	-21.60	-18.22
7322.53	H	50.53	35.16	74.00	54.00	-23.47	-18.84
9748.44	H	51.08	34.82	74.00	54.00	-22.92	-19.18

**All emissions not reported were more than 20dB below the specified limit or in the noise floor.**

- Note:**
- (1) All Readings are Peak Value and AV.
  - (2) Emission Level= Reading Level+Probe Factor +Cable Loss.
  - (3) Data of measurement within this frequency range shown “ -- ” in the table above means the reading of emissions are attenuated more than 20dB below the permissible limits or the field strength is too small to be measured.

Operation Mode: 802.11b TX (Channel 11) Test Date : January 14, 2014  
 Frequency Range: 1GHz~25GHz Temperature : 28°C  
 Test Result: PASS Humidity : 65 %  
 Measured Distance: 3m Test By: WOLF

Freq. (MHz)	Ant.Pol. H/V	Emission Level(dBuV/m)		Limit 3m(dBuV/m)		Over(dB)	
		PK	AV	PK	AV	PK	AV
4944.53	V	51.45	34.89	74.00	54.00	-22.55	-19.11
7386.57	V	52.16	35.85	74.00	54.00	-21.84	-18.15
9855.61	V	51.56	34.56	74.00	54.00	-22.44	-19.44
--	--	--	--	--	--	--	--
--	--	--	--	--	--	--	--
--	--	--	--	--	--	--	--
4944.46	H	53.80	36.34	74.00	54.00	-20.20	-17.66
7389.13	H	52.29	36.31	74.00	54.00	-21.71	-17.69
9846.73	H	51.46	35.19	74.00	54.00	-22.54	-18.81

**No others harmonics emissions are higher than 20dB below the limits of 47 CFR Part 15.247.**

- Note:**
- (1) All Readings are Peak Value and AV.
  - (2) Emission Level= Reading Level+Probe Factor +Cable Loss.
  - (3) Data of measurement within this frequency range shown “ -- ” in the table above means the reading of emissions are attenuated more than 20dB below the permissible limits or the field strength is too small to be measured.

## 7. 6dB Bandwidth Test and 99% Bandwidth Test

### 7.1 Measurement Procedure

The EUT was operating in IEEE 802.11b/g/n mode or could be controlled its channel. Printed out the test result from the spectrum by hard copy function.

1. Set resolution bandwidth (RBW) = 100 kHz.
2. Set the video bandwidth (VBW)  $\geq 3 \times$  RBW.
3. Detector = Peak.
4. Trace mode = max hold.
5. Sweep = auto couple.
6. Allow the trace to stabilize.
7. Measure the maximum width of the emission that is constrained by the frequencies associated with the two outermost amplitude points (upper and lower frequency) that are attenuated by 6 dB relative to the maximum level measured in the fundamental emission.

### 7.2 Test SET-UP (Block Diagram of Configuration)

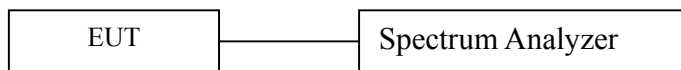

### 7.3 Measurement Equipment Used

EQUIPMENT TYPE	MFR	MODEL NUMBER	SERIAL NUMBER	LAST CAL.	CAL DUE.
Spectrum Analyzer	Agilent	E4407B	88156318	05/28/2013	05/27/2014

### 7.4 Measurement Results

6db Bandwidth Test Data Chart and 99% Bandwidth Test Data Chart:  
 Refer to attached data chart.

6db Bandwidth Test

Spectrum Detector: PK                      Test Date : January 7, 2014  
 Test By: Andy                              Temperature : 28°C  
 Test Result: PASS                      Humidity : 65 %  
 Operation Mode: 802.11b

Channel number	Channel frequency (MHz)	Measurement level (MHz)	Mode
1	2412	8.053	6db Bandwidth
6	2437	7.674	6db Bandwidth
11	2462	7.565	6db Bandwidth

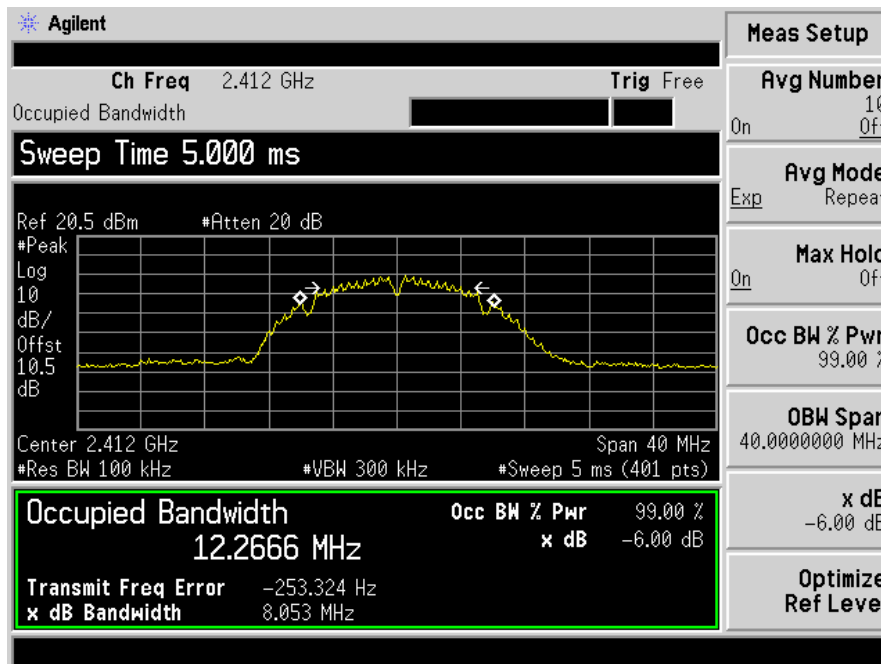



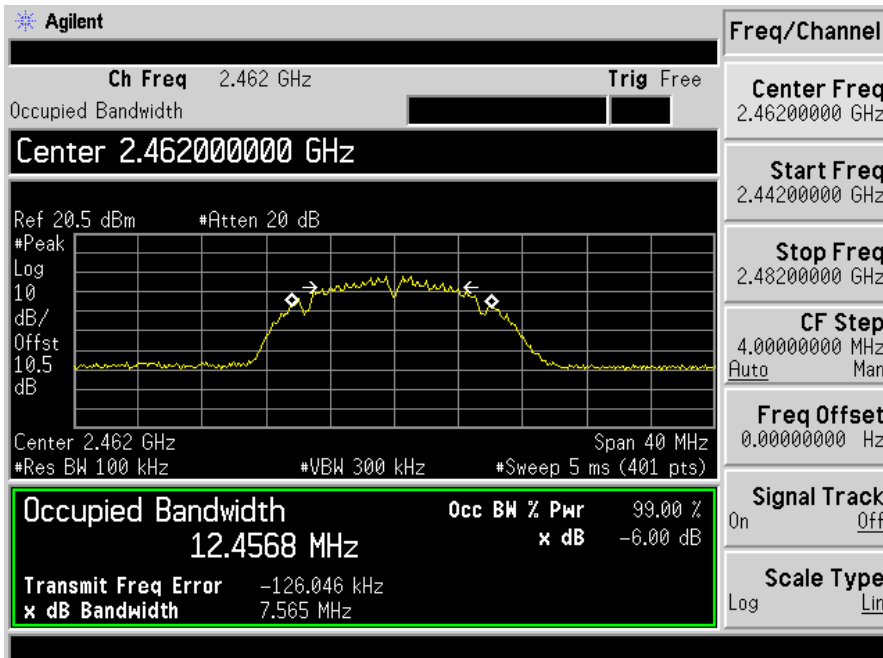
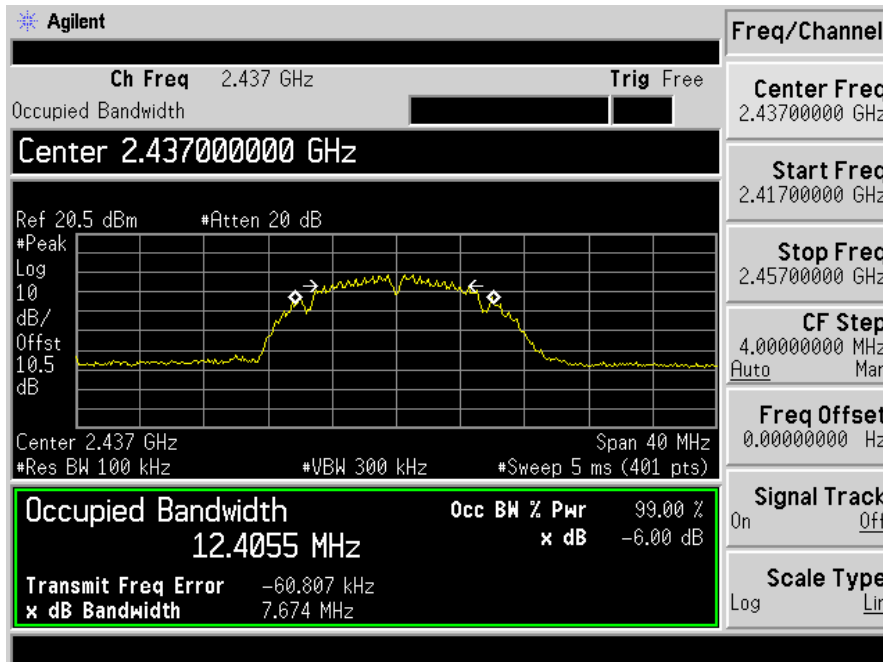

Spectrum Detector: PK Test Date : January 7, 2014  
 Test By: Andy Temperature : 28°C  
 Test Result: PASS Humidity : 65 %  
 Operation Mode: 802.11 g

Channel number	Channel frequency (MHz)	Measurement level (MHz)	Mode
1	2412	15.729	6db Bandwidth
6	2437	15.243	6db Bandwidth
11	2462	15.615	6db Bandwidth

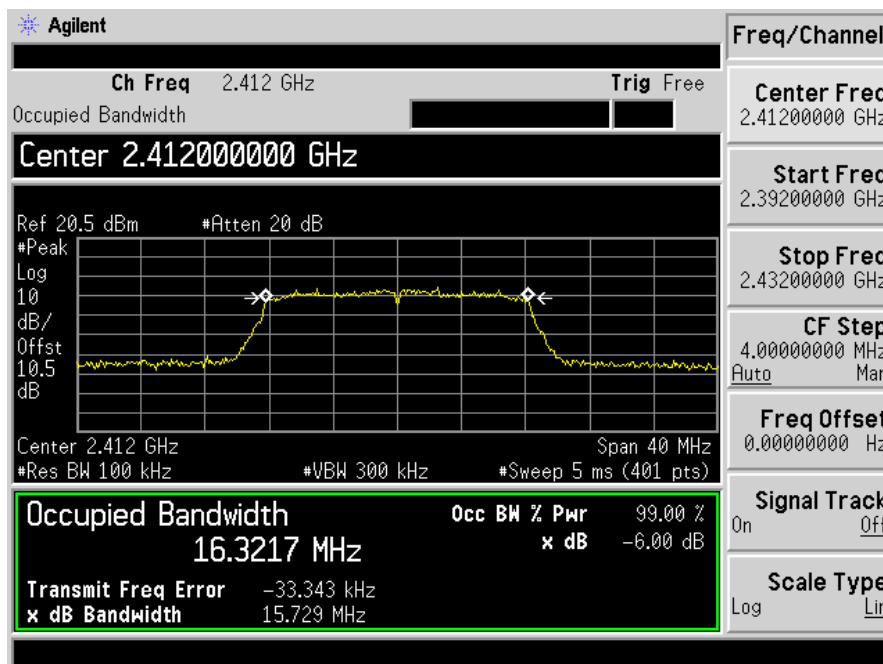

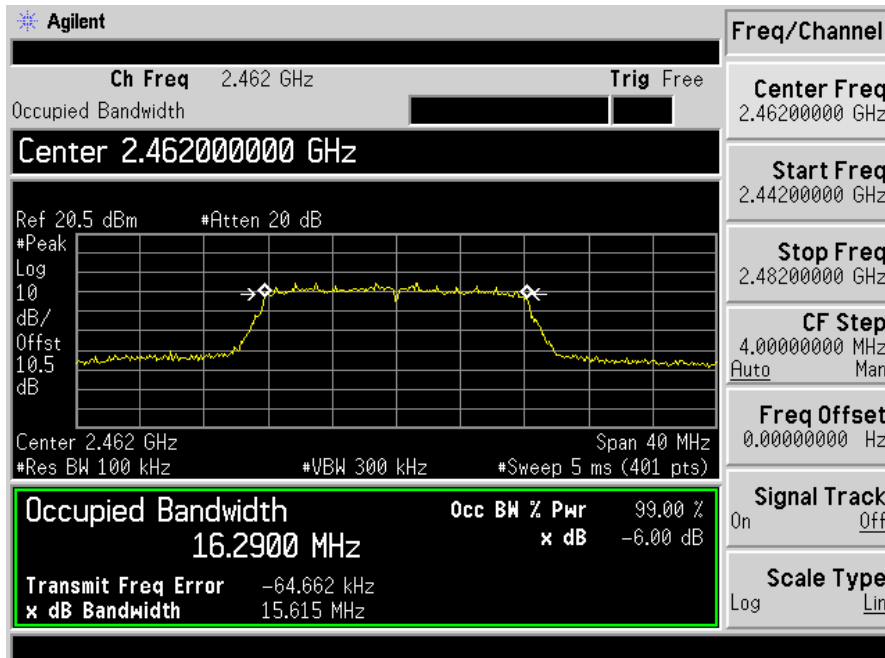
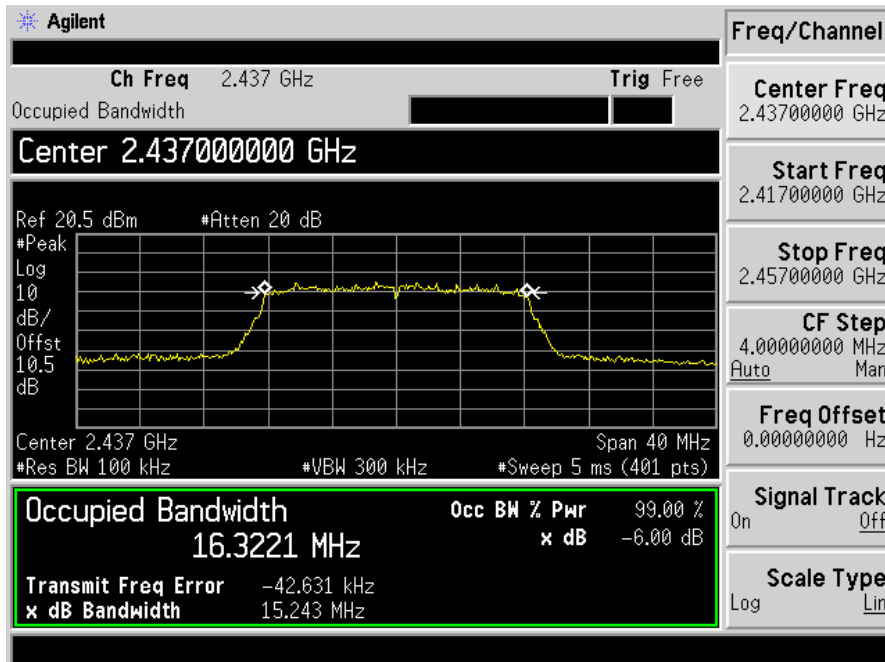

Spectrum Detector: PK Test Date : January 7, 2014  
 Test By: Andy Temperature : 28°C  
 Test Result: PASS Humidity : 65 %  
 Operation Mode: 802.11 n

Channel number	Channel frequency (MHz)	Measurement level (MHz)	Mode
1	2412	16.465	6db Bandwidth
6	2437	17.104	6db Bandwidth
11	2462	15.428	6db Bandwidth

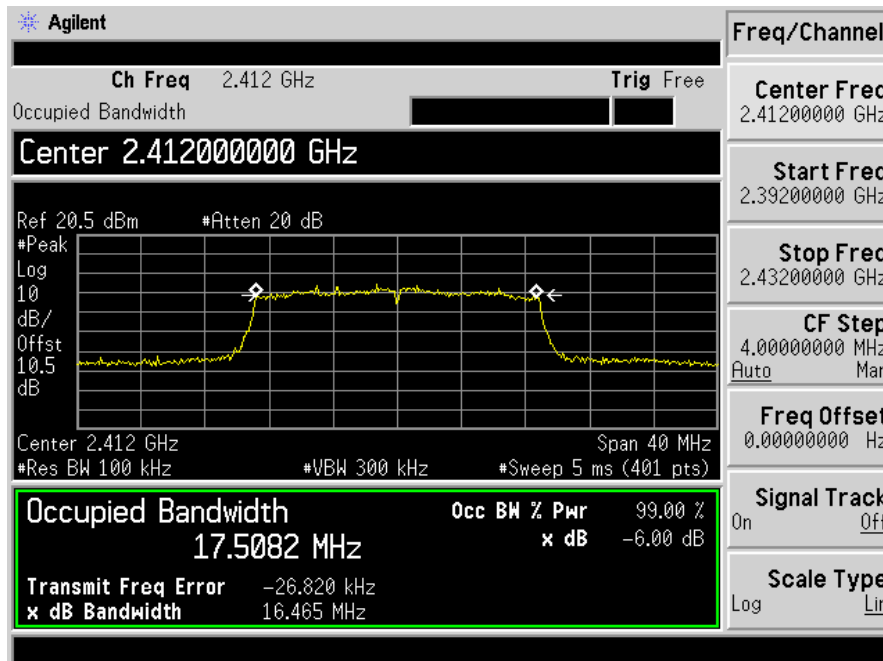

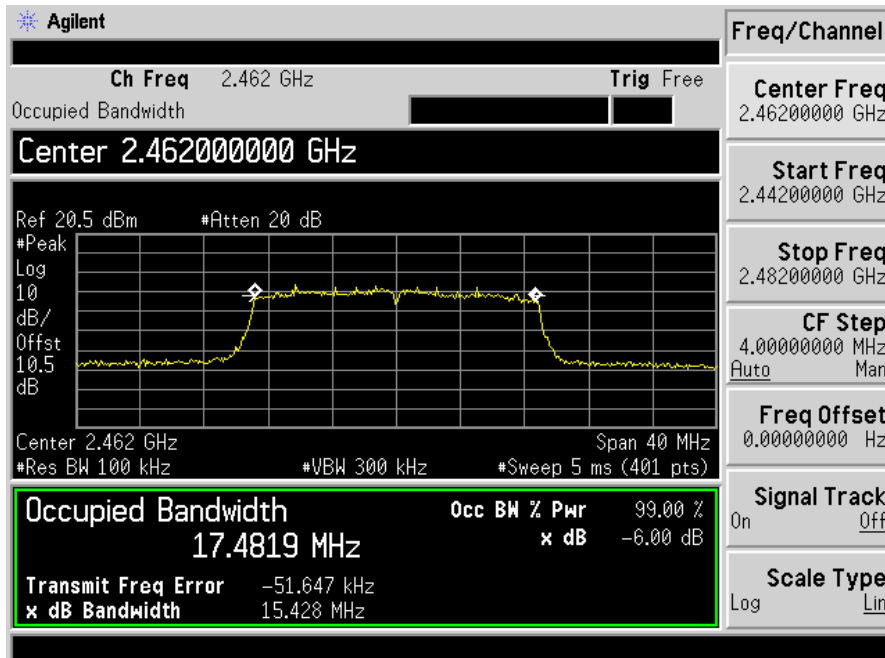
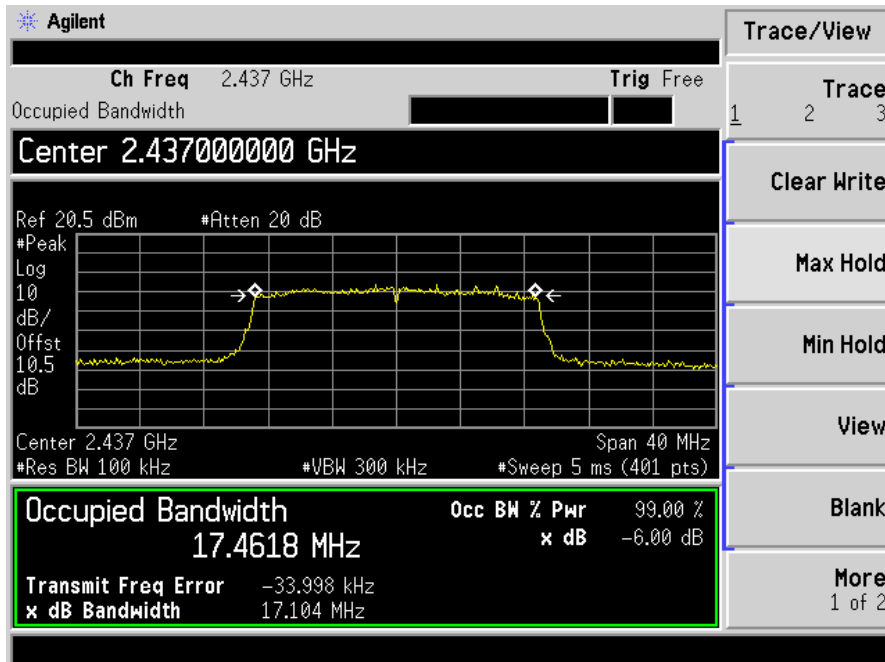

99% Bandwidth Test

Spectrum Detector:	PK	Test Date :	January 7, 2014
Test By:	Andy	Temperature :	28°C
Test Result:	PASS	Humidity :	65 %
Operation Mode:	802.11b		

Channel number	Channel frequency (MHz)	Measurement level (MHz)	Mode
1	2412	12.6373	99% Bandwidth Test
6	2437	12.6397	99% Bandwidth Test
11	2462	12.6432	99% Bandwidth Test

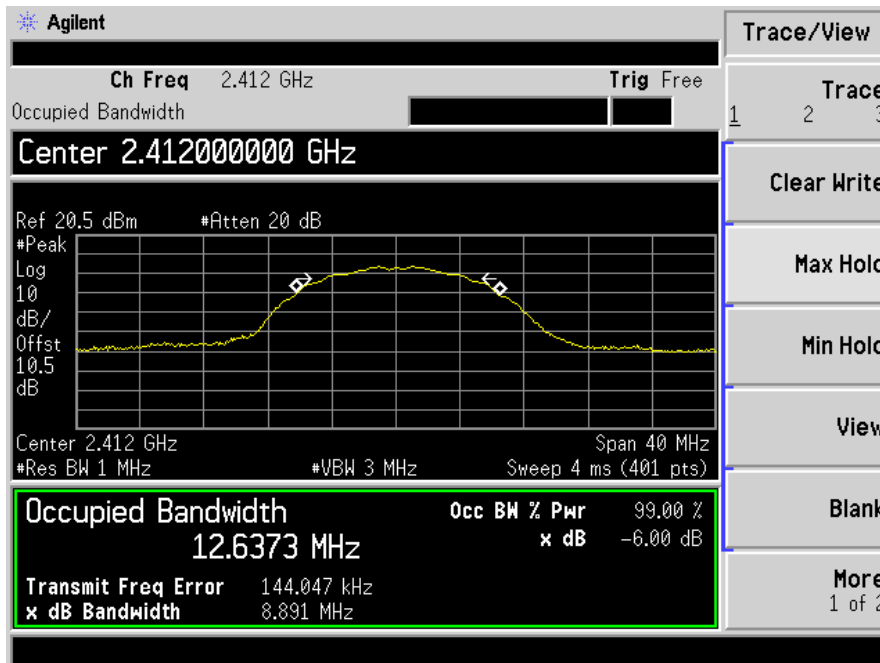

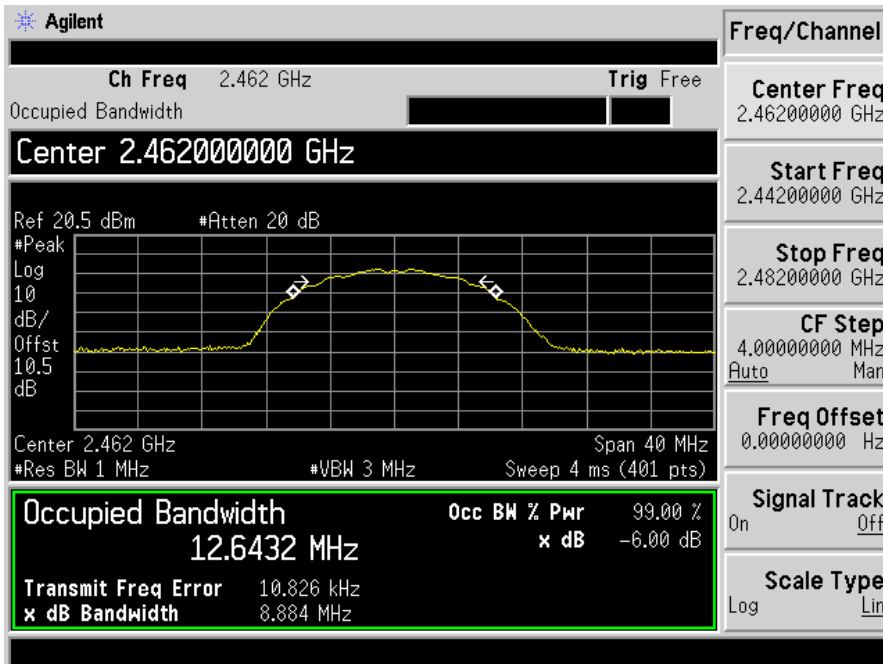
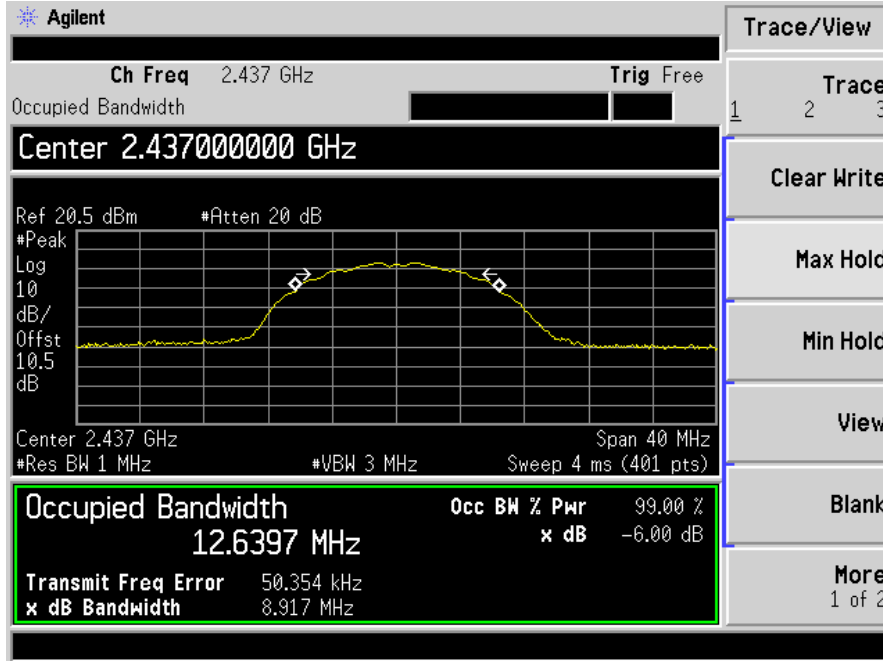

Spectrum Detector: PK                      Test Date : January 7, 2014  
 Test By: Andy                              Temperature : 28°C  
 Test Result: PASS                        Humidity : 65 %  
 Operation Mode: 802.11 g

Channel number	Channel frequency (MHz)	Measurement level (MHz)	Mode
1	2412	17.2287	99% Bandwidth Test
6	2437	17.2505	99% Bandwidth Test
11	2462	17.0896	99% Bandwidth Test

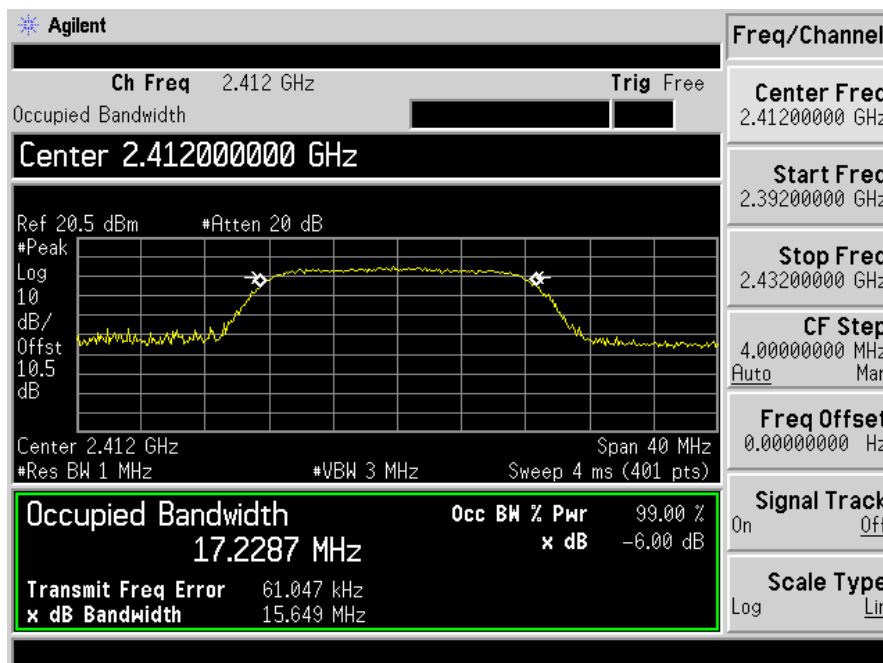



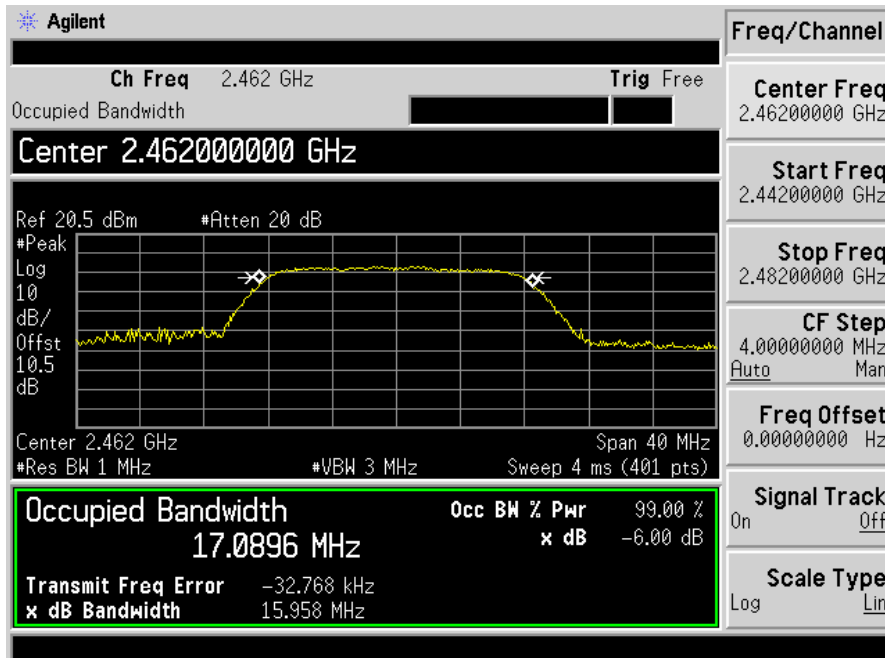
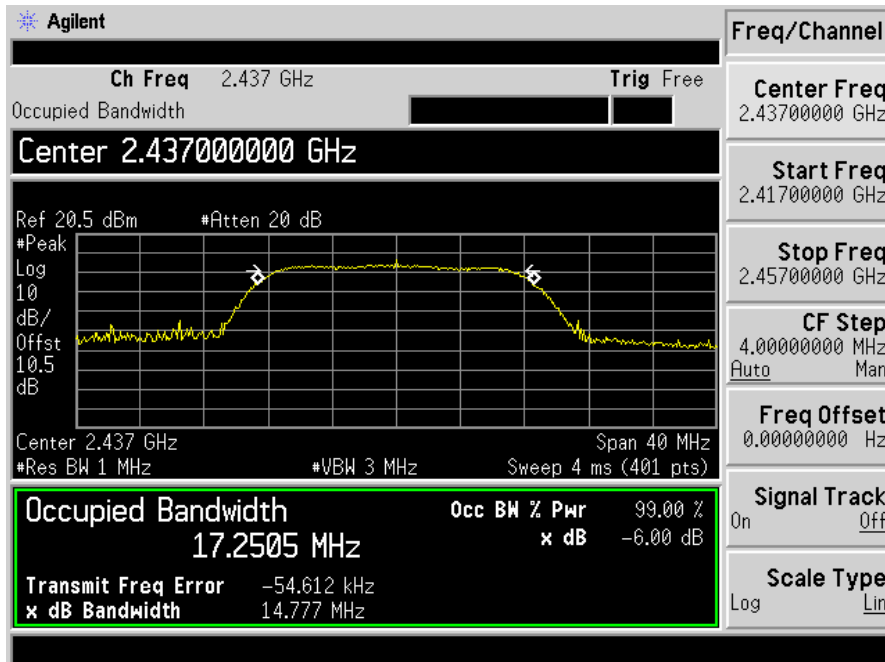

Spectrum Detector: PK Test Date : January 7, 2014  
 Test By: Andy Temperature : 28°C  
 Test Result: PASS Humidity : 65 %  
 Operation Mode: 802.11 n

Channel number	Channel frequency (MHz)	Measurement level (MHz)	Mode
1	2412	17.9146	99% Bandwidth Test
6	2437	17.9152	99% Bandwidth Test
11	2462	17.9364	99% Bandwidth Test

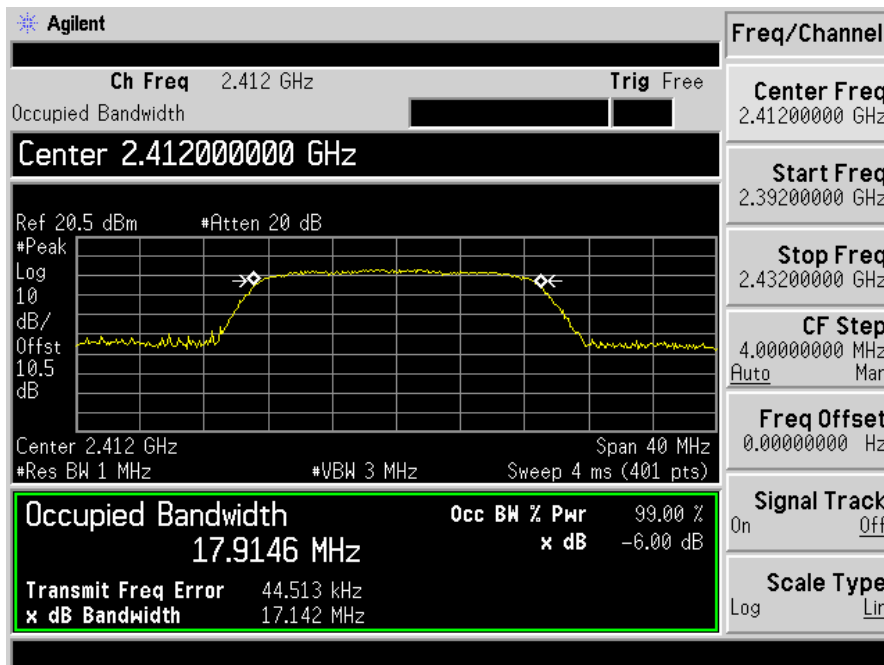

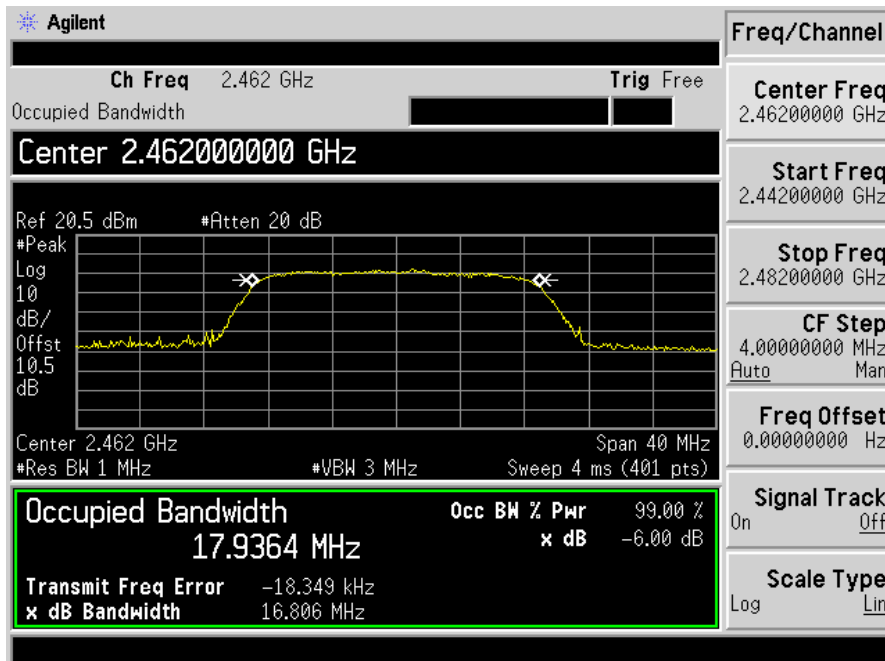
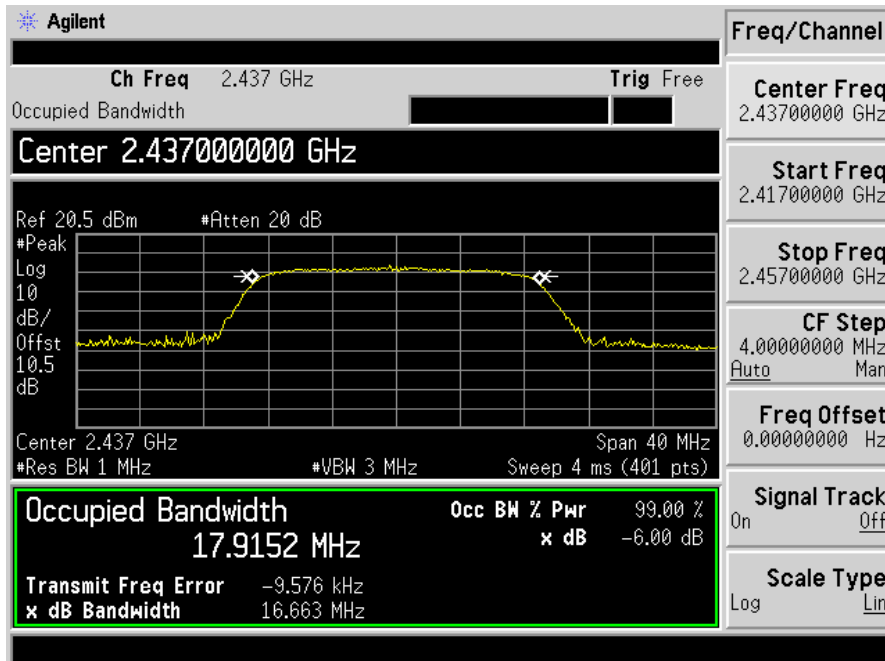

## 8. Maximum Peak Output Power Test

### 8.1 Measurement Procedure

The maximum peak conducted output power can be measured using a broadband peak RF power meter. The power meter must have a video bandwidth that is greater than or equal to the DTS bandwidth and shall utilize a fast, average-responding diode type sensor.

- a. The Transmitter output (antenna port) was connected to the power meter.
- b. Turn on the EUT and power meter and then record the peak power value.
- c. Repeat above procedures on all channels needed to be tested.

### 8.2 Test SET-UP (Block Diagram of Configuration)



### 8.3 Measurement Equipment Used

EQUIPMENT TYPE	MODEL NUMBER	SERIAL NUMBER	LAST CAL.	CAL DUE.
Power meter	ML2495A	0824006	05/28/2013	05/27/2014
Power sensor	MA2411B	0738172	05/28/2013	05/27/2014

### 8.4 Peak Power output limit

The maximum peak power shall be less 1Watt.

### 8.5 Measurement Results

Spectrum Detector: PK                      Test Date :                      January 14, 2014  
 Test By: Andy                                  Temperature :                      28°C  
 Test Result: PASS                              Humidity :                          65 %  
 Operation Mode: 802.11b

Channel number	Channel Frequency(MHz)	Peak Power output(dBm)	Peak Power Limit(W)	Pass/Fail
1	2412	9.82	1W(30dBm)	PASS
6	2437	9.76	1W(30dBm)	PASS
11	2462	9.51	1W(30dBm)	PASS

Spectrum Detector: PK Test Date : January 14, 2014  
 Test By: Andy Temperature : 28°C  
 Test Result: PASS Humidity : 65 %  
 Operation Mode: 802.11g

Channel number	Channel Frequency (MHz)	Peak Power output(dBm)	Peak Power Limit(W)	Pass/Fail
1	2412.00	9.07	1W(30dBm)	PASS
6	2437.00	8.89	1W(30dBm)	PASS
11	2462.00	8.92	1W(30dBm)	PASS

Spectrum Detector: PK Test Date : January 14, 2014  
 Test By: Andy Temperature : 28°C  
 Test Result: PASS Humidity : 65 %  
 Operation Mode: 802.11n

Channel number	Channel Frequency (MHz)	Peak Power output(dBm)	Peak Power Limit(W)	Pass/Fail
1	2412.00	8.78	1W(30dBm)	PASS
6	2437.00	8.75	1W(30dBm)	PASS
11	2462.00	8.77	1W(30dBm)	PASS

## 9. Band Edge Test

### 9.1 Measurement Procedure

1. The EUT was Operating in hopping mode or could be controlled its channel. Printed out test result from the spectrum by hard copy function.
2. The EUT was placed on a turn table which is 0.8m above ground plane.
3. Maximum procedure was performed on the six highest emissions to ensure EUT compliance.
4. And also, each emission was to be maximized by changing the polarization of receiving antenna both horizontal and vertical.
5. Repeat above procedures until all frequency measured were complete.

### 9.2 Test SET-UP (Block Diagram of Configuration)

As 6.2 Test set up (B) and (C)

### 9.3 Measurement Equipment Used

Same as 6.3 Radiated Emission Measurement.

### 9.4 Measurement Results

Test mode: 802.11b

Spectrum Detector: PK/AV                      Test Date :                      January 14, 2014  
 Test By: Andy                                      Temperature :                      28 °C  
 Test channel: 01                                      Humidity :                              65 %

Frequency (MHz)	Polarity	Level (dBuV/m)		Limited (dBuV/m)	
		PK	AV	PK	AV
2390	H	43.29	30.38	74	54
2390	V	43.15	30.51	74	54

Spectrum Detector: PK/AV                      Test Date :                      January 14, 2014  
 Test By: Andy                                      Temperature :                      28 °C  
 Test channel: 11                                      Humidity :                              65 %

Frequency (MHz)	Polarity	Level (dBuV/m)		Limited (dBuV/m)	
		PK	AV	PK	AV
2485.5	H	42.21	29.44	74	54
2485.5	V	41.52	28.85	74	54

Test mode: 802.11g

Spectrum Detector: PK/AV      Test Date : January 14, 2014  
 Test By: Andy      Temperature : 28 °C  
 Test channel: 01      Humidity : 65 %

Frequency (MHz)	Polarity	Level (dBuV/m)		Limited (dBuV/m)	
		PK	AV	PK	AV
2390	H	43.59	30.73	74	54
2390	V	42.92	29.87	74	54

Spectrum Detector: PK/AV      Test Date : January 14, 2014  
 Test By: Andy      Temperature : 28 °C  
 Test channel: 11      Humidity : 65 %

Frequency (MHz)	Polarity	Level (dBuV/m)		Limited (dBuV/m)	
		PK	AV	PK	AV
2485.5	H	42.86	29.68	74	54
2485.5	V	41.75	28.58	74	54

Test mode: 802.11n

Spectrum Detector: PK/AV      Test Date : January 14, 2014  
 Test By: Andy      Temperature : 28 °C  
 Test channel: 01      Humidity : 65 %

Frequency (MHz)	Polarity	Level (dBuV/m)		Limited (dBuV/m)	
		PK	AV	PK	AV
2390	H	43.51	30.58	74	54
2390	V	43.01	30.95	74	54

Spectrum Detector: PK/AV      Test Date : January 14, 2014  
 Test By: Andy      Temperature : 28 °C  
 Test channel: 11      Humidity : 65 %

Frequency (MHz)	Polarity	Level (dBuV/m)		Limited (dBuV/m)	
		PK	AV	PK	AV
2485.5	H	43.19	30.19	74	54
2485.5	V	40.54	28.53	74	54

## 10. Power Density

### 10.1 Test Equipment

EQUIPMENT TYPE	MFR	MODEL NUMBER	SERIAL NUMBER	LAST CAL.	CAL DUE.
Spectrum Analyzer	Agilent	E4407B	88156318	05/28/2013	05/27/2014

### 10.2 Measuring Instruments and Setting

The following table is the setting of spectrum analyzer.

Spectrum analyzer	Setting
Attenuation	Auto
Span Frequency	Set the span to 1.5 times the DTS bandwidth.
RB	3kHz $\leq$ RBW $\leq$ 100KHz
VB	3 x RBW
Detector	Peak
Trace	Max hold
Sweep Time	Automatic

### 10.3 Test Procedures

- The transmitter output (antenna port) was connected to the spectrum analyzer.
- Set analyzer center frequency to DTS channel center frequency.
- Set the analyzer span to a minimum of 1.5 times the DTS bandwidth.
- Set the RBW  $\geq$  3 kHz. Set the VBW  $\geq$  3 x RBW.
- Detector = peak.
- Sweep time = auto couple.
- Trace mode = max hold.
- Allow trace to fully stabilize.
- Use the peak marker function to determine the maximum amplitude level within the RBW.

### 10.4 Block Diagram of Test Setup

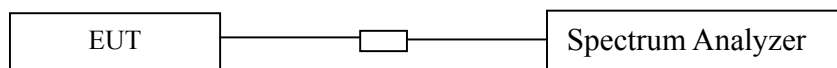

### 10.5 Limit

The transmitted power density averaged over any 1 second interval shall not be greater +8dBm in any 3 kHz bandwidth.



### 10.6 Test Result

Spectrum Detector:	PK	Test Date :	January 7, 2014
Test By:	Andy	Temperature :	28°C
Test Result:	PASS	Humidity :	65 %
Operation Mode:	802.11 b		

Channel	Measurement Level (dBm)	Required Limit (dBm)	Result
1	-14.25	<8dBm	PASS
6	-12.15	<8dBm	PASS
11	-14.81	<8dBm	PASS

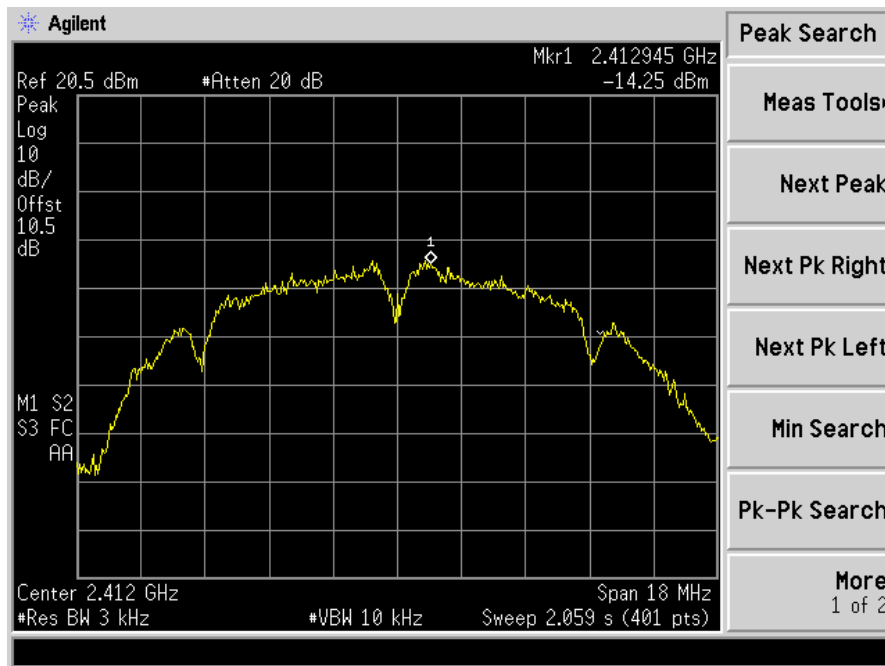

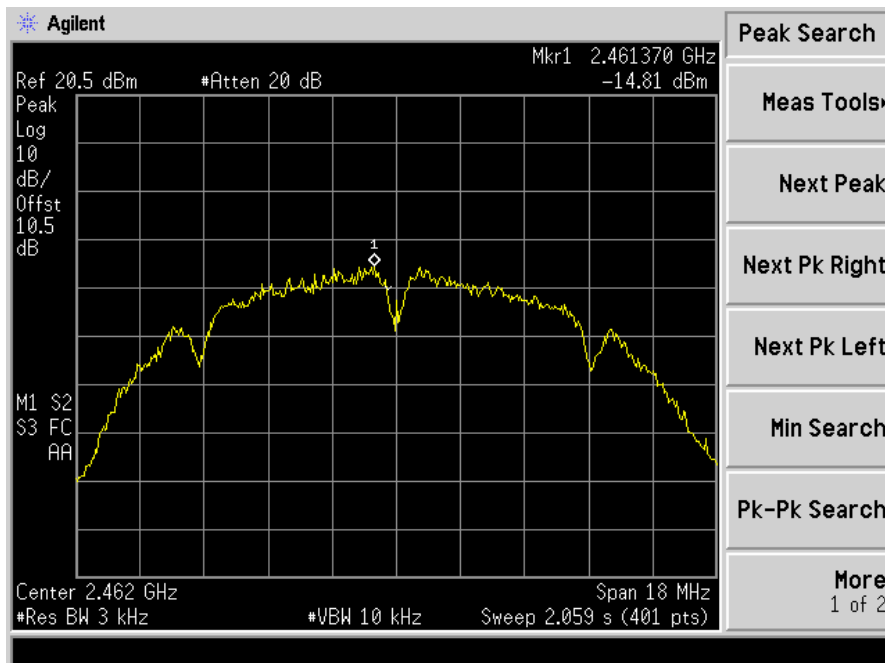
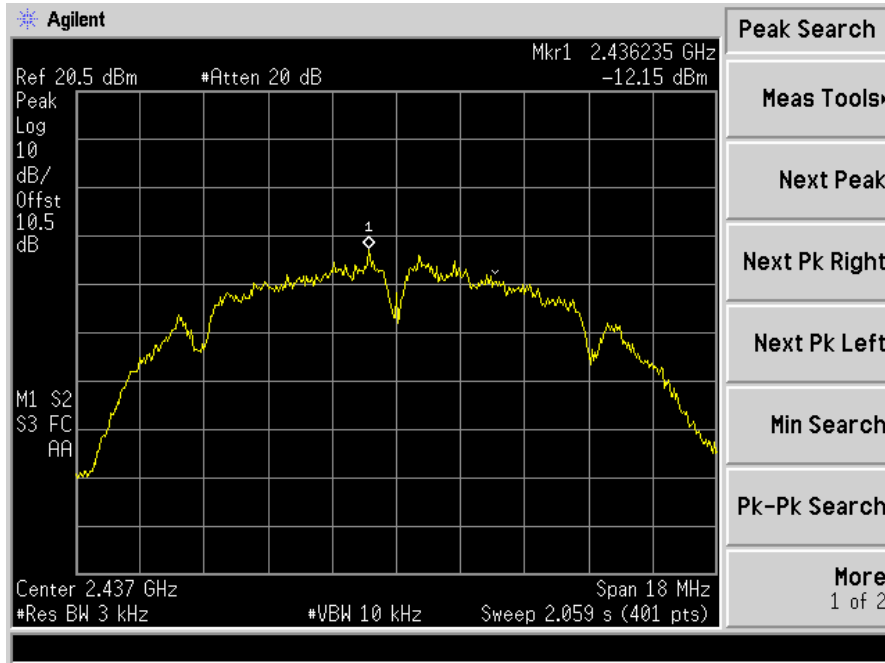

Spectrum Detector: PK                      Test Date :            January 7, 2014  
 Test By: Andy                              Temperature :        28°C  
 Test Result: PASS                        Humidity :            65 %  
 Operation Mode: 802.11 g

Channel	Measurement Level (dBm)	Required Limit (dBm)	Result
1	-16.45	<8dBm	PASS
6	-17.33	<8dBm	PASS
11	-18.23	<8dBm	PASS

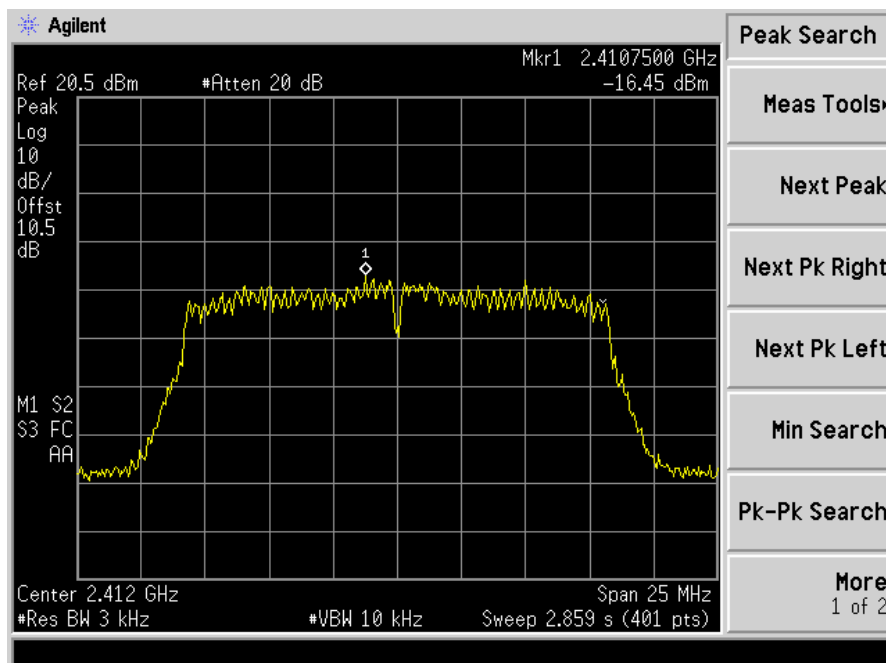

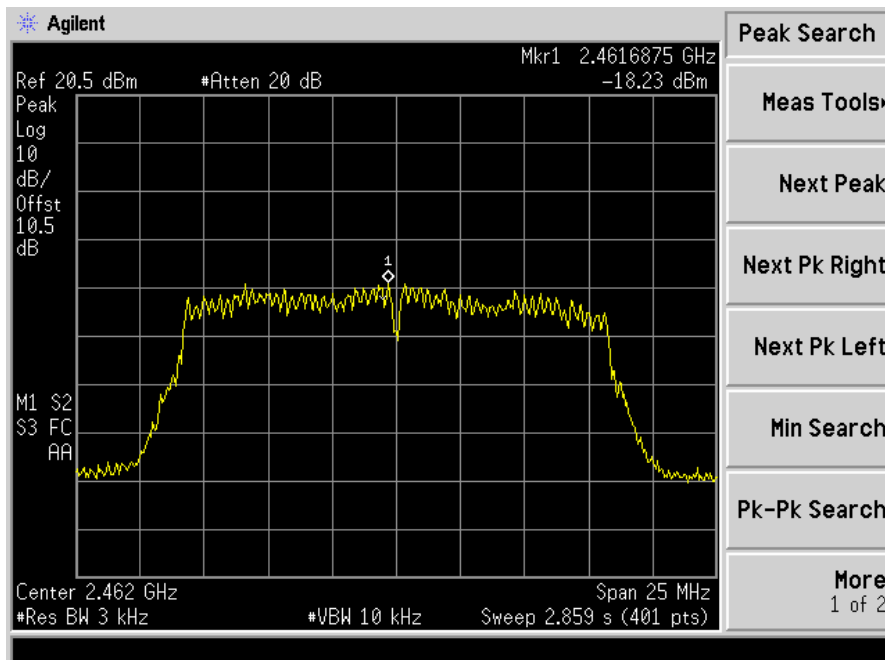
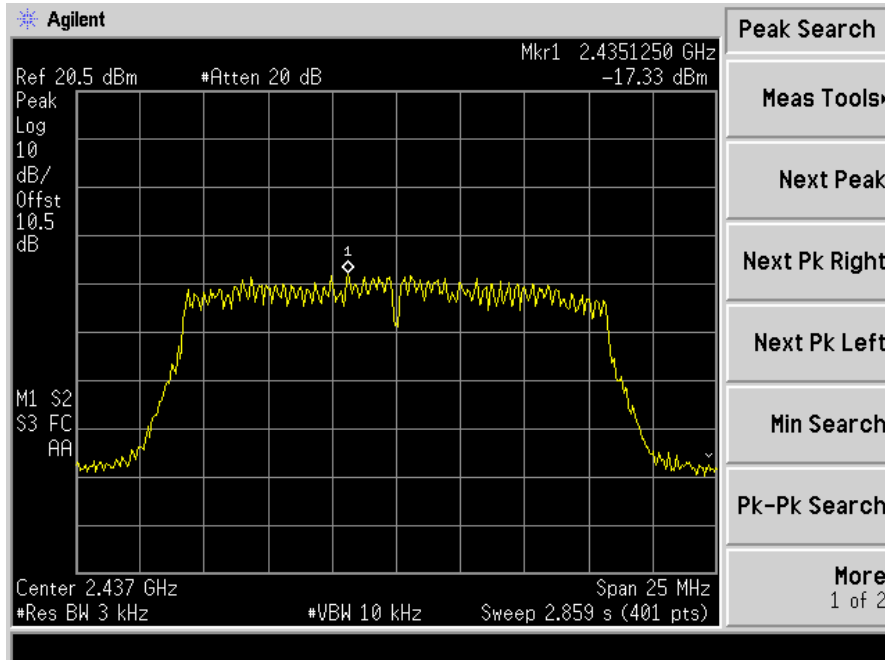

Spectrum Detector: PK                      Test Date :            January 7, 2014  
 Test By:                                      Andy                      Temperature :        28°C  
 Test Result:                                PASS                     Humidity :            65 %  
 Operation Mode: 802.11 n

Channel	Measurement Level (dBm)	Required Limit (dBm)	Result
1	-18.86	<8dBm	PASS
6	-18.22	<8dBm	PASS
11	-19.23	<8dBm	PASS

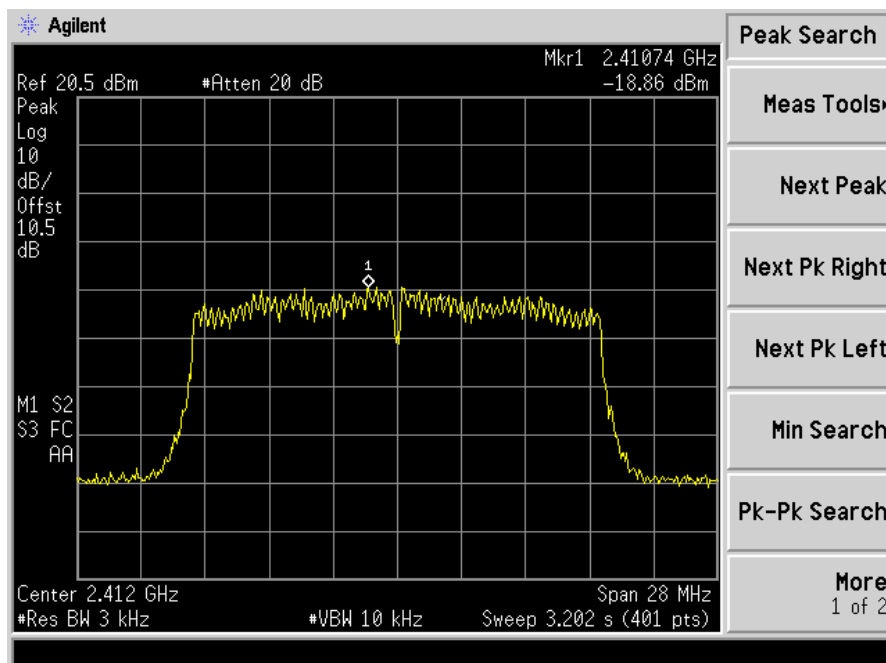

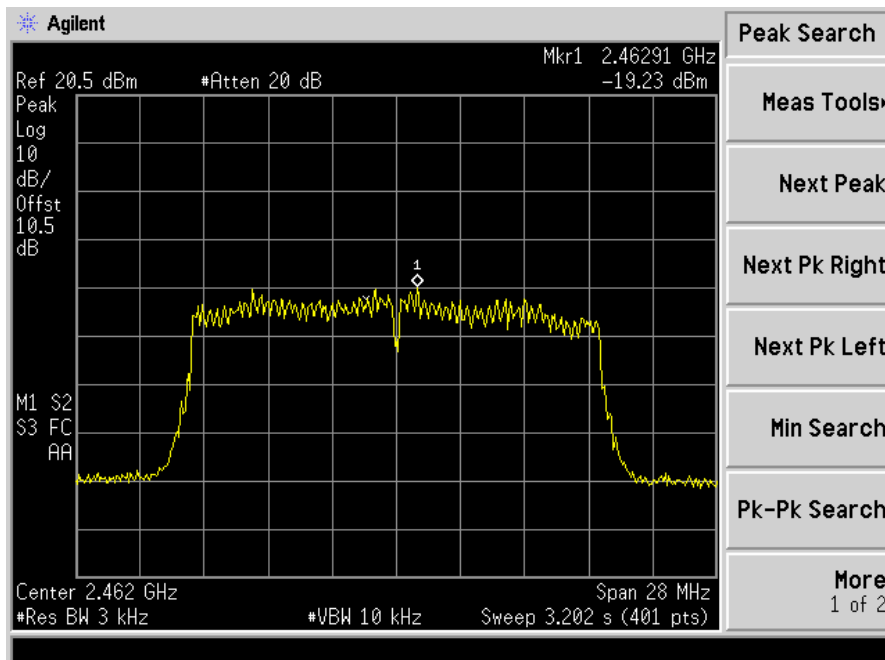
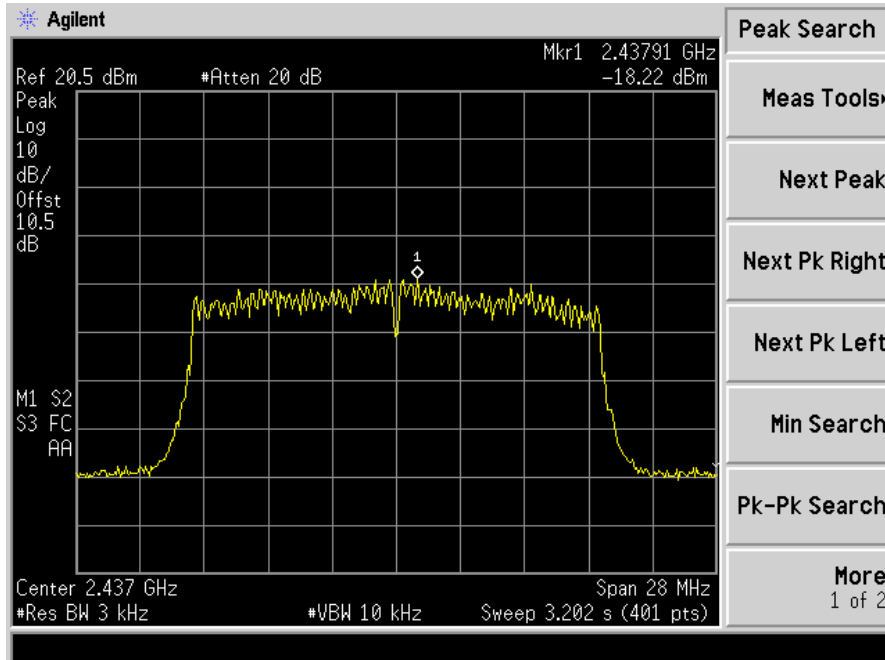

## 11. Antenna Port Emission

### 11.1 Test Equipment

EQUIPMENT TYPE	MFR	MODEL NUMBER	SERIAL NUMBER	LAST CAL.	CAL DUE.
Spectrum Analyzer	Agilent	E4407B	88156318	05/28/2013	05/27/2014

### 11.2 Measuring Instruments and Setting

The following table is the setting of spectrum analyzer.

Spectrum analyzer	Setting
Attenuation	Auto
RB	100kHz for below 1GHz, 1MHz for above 1GHz
VB	300kHz for below 1GHz, 3MHz for above 1GHz
Detector	Peak
Trace	Max hold

### 11.3 Test Procedures

The conducted spurious emissions were measured conducted using a spectrum analyzer at low, Middle, and high channels, the limit was determined by attenuation 20dB of the RF peak power output.

### 11.4 Block Diagram of Test setup

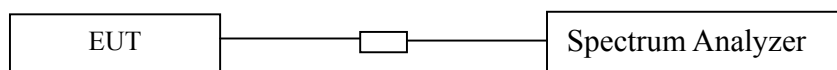

### 11.5 Test Result

**PASS.**

All the modes have been tested, the worst result 802.11b was recorded as below.

802.11b Low Channel 1

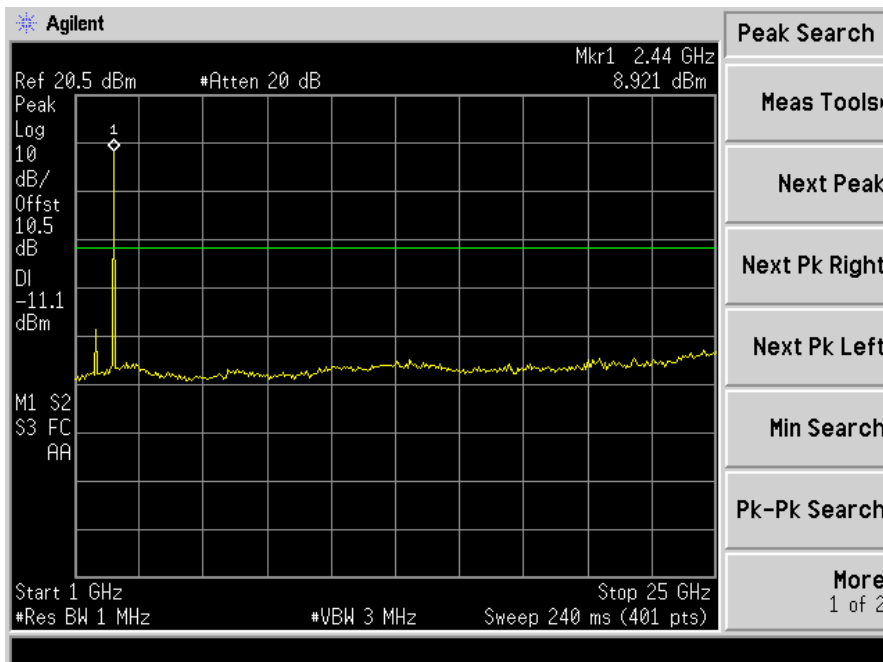
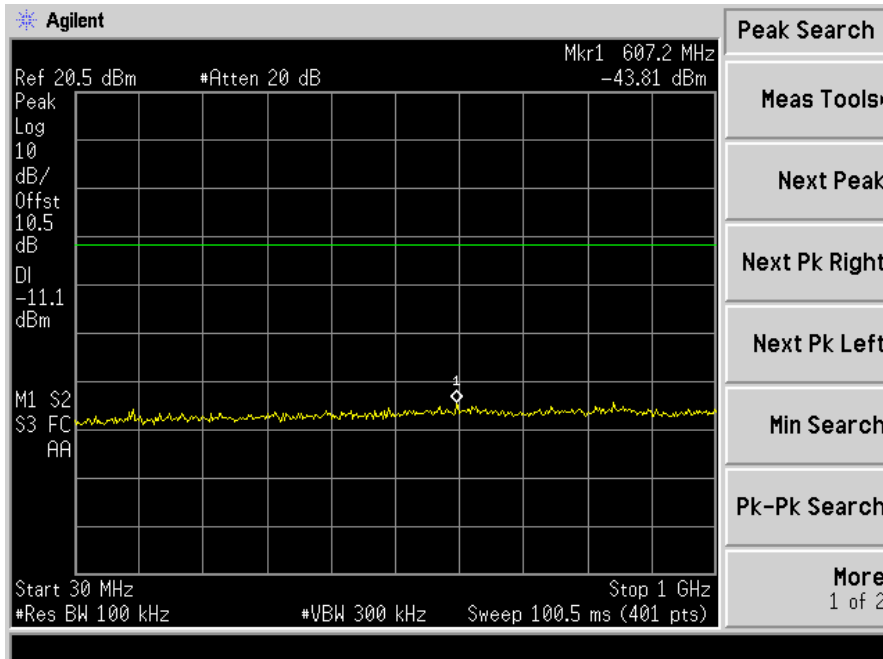



### 802.11b Mid Channel 6

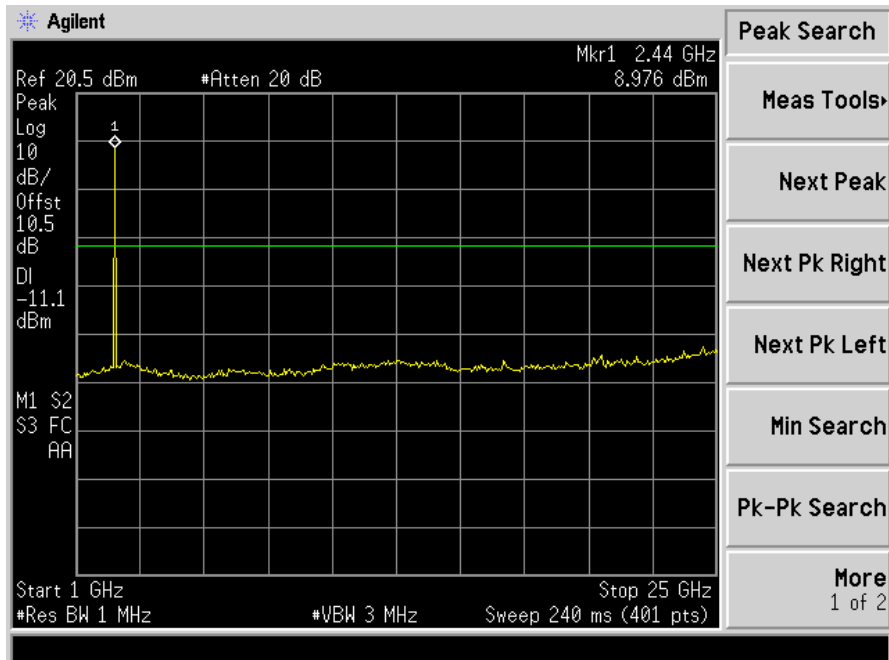
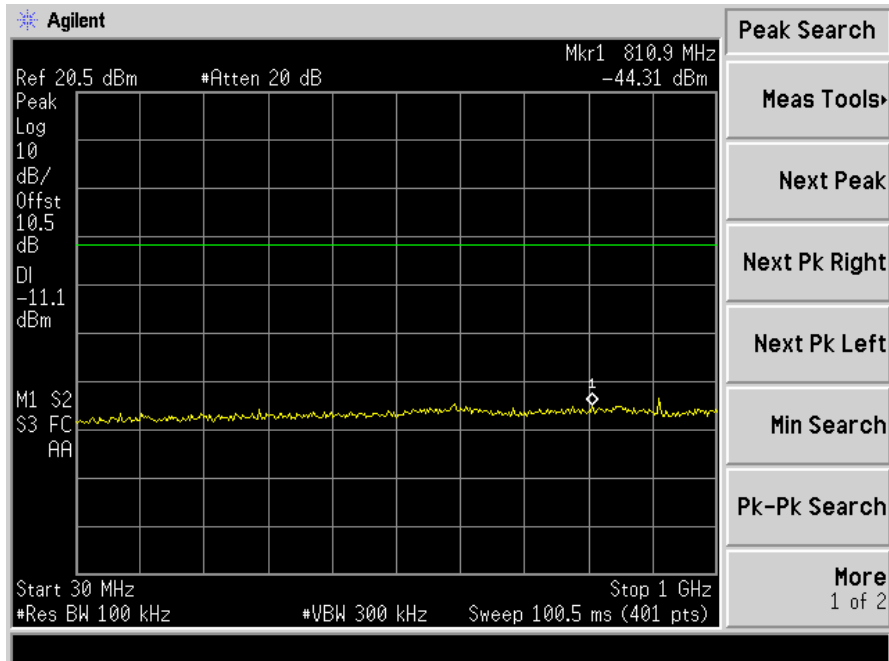

802.11b High Channel 11

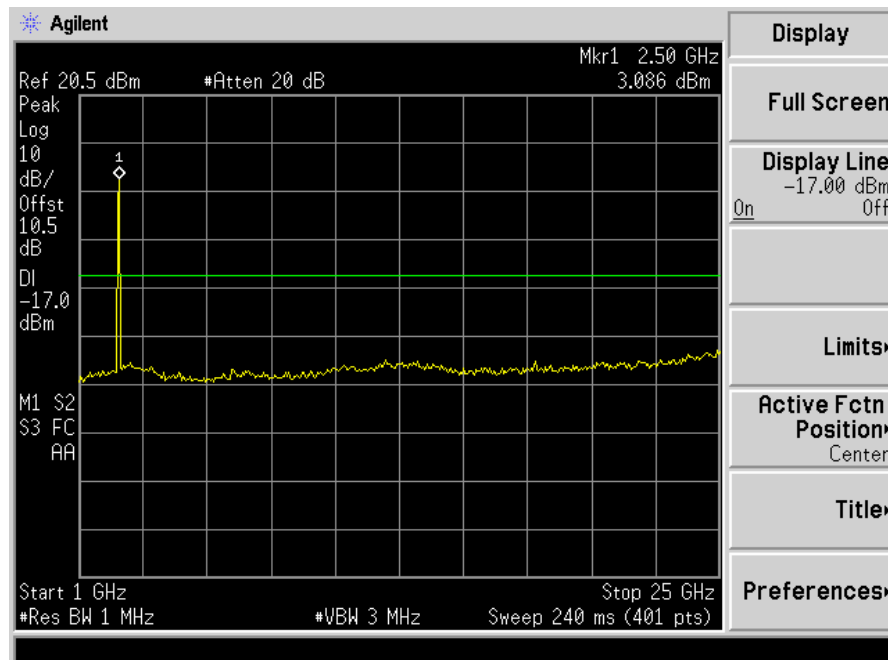
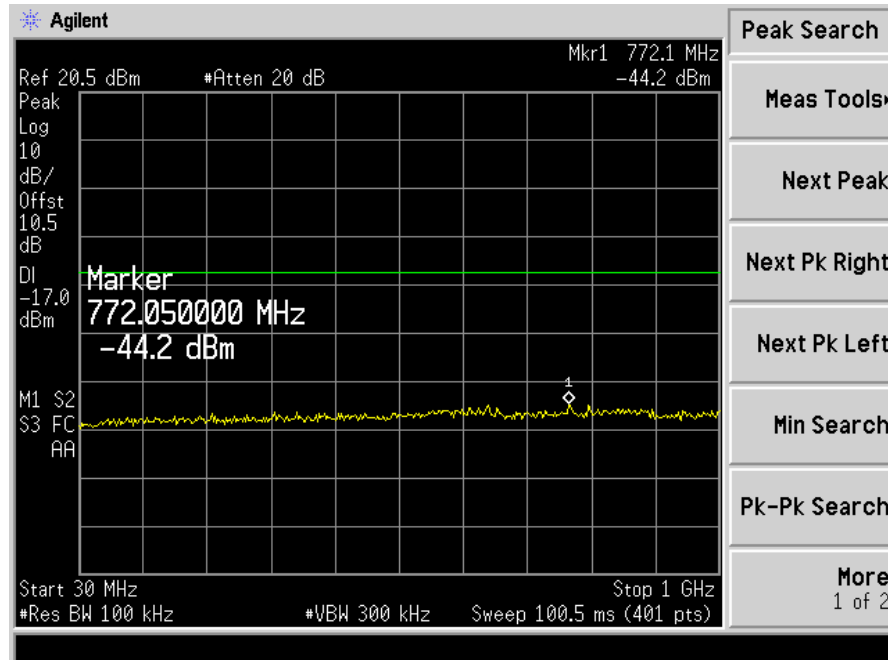

## **12. Antenna Application**

### **12.1 Antenna Requirement**

For intentional device, according to FCC 47 CFR Section 15.203, an intentional radiator shall be designed to ensure that no antenna other than that furnished by the responsible party shall be used with the device. And according to FCC 47 CFR Section 15.247 (b), if transmitting antennas of directional gain greater than 6dBi are used, the power shall be reduced by the amount in dB that the directional gain of the antenna exceeds 6dBi.

### **12.2 Result**

The EUT'S antenna is a PCB Antenna. The antenna's gain is 1dBi and meets the requirement.

### 13. Uncertainty

Measurement Uncertainty for a level of Confidence of 95%

Parameter	Uncertainty
Radio Frequency	$\pm 1 \times 10^{-5}$
Maximum Peak Output Power Test	$\pm 1.0\text{dB}$
Conducted Emissions Test	$\pm 2.0\text{dB}$
Radiated Emission Test	$\pm 2.0\text{dB}$
Power Density	$\pm 2.0\text{dB}$
Occupied Bandwidth Test	$\pm 1.0\text{dB}$
Band Edge Test	$\pm 3\text{dB}$
All emission, radiated	$\pm 3\text{dB}$
Antenna Port Emission	$\pm 3\text{dB}$
Temperature	$\pm 0.5^{\circ}\text{C}$
Humidity	$\pm 3\%$