



FCC 47 CFR PART 15 SUBPART C 15.247

**TEST REPORT
FOR
Portable Computer**

Model : M1021AAP, M1021AAP *, NX16A10132SP, NX16A10132SP *

Trade Name : N/A

Issued to

Shenzhen Yifang Digital Technology Co., Ltd.

YIFANG Building, No.315, Shuang Ming Avenue, Guang Ming Street, Guang Ming District, Shenzhen 518107, Guangdong, China

Issued by

WH Technology Corp.



Open Site		No.120, Ln. 5, Hudong St., Xizhi Dist., New Taipei City 221, Taiwan (R.O.C.)
EMC Test Site	Xizhi Office and Lab	7F., No.262, Sec. 3, Datong Rd., Xizhi Dist., New Taipei City 221, Taiwan (R.O.C.)
Tel.: +886-2-7729-7707 Fax: +886-2- 8648-1311		
Test Firm Registration: 749714		

Note: This test refers exclusively to the test presented test model and sample. This report shall not be reproduced except in full, without the written approval of WH Technology Corp. This document may be altered or revised by WH Technology Corp. Personnel only, and shall be noted in the revision section of the document.



Contents

1. General Information	4
2. Report of Measurements and Examinations	5
2.1 List of Measurements and Examinations	5
3. Test Configuration of Equipment under Test	6
3.1 Description of the tested samples	6
3.2 Carrier Frequency of Channels	7
3.3 Test Mode and Test Software	8
3.4 TEST Methodology & General Test Procedures	9
3.5 Measurement Uncertainty	10
3.6 Description of the Support Equipments	10
4. Test and measurement equipment	11
4.1 calibration	11
4.2 equipment	11
5. Antenna Requirements	14
5.1 Standard Applicable	14
5.2 Antenna Construction and Directional Gain	14
6. Test of Conducted Emission	15
6.1 Test Limit	15
6.2 Test Procedures	15
6.3 Typical Test Setup	16
6.4 Test Result and Data	17
7. Test of Radiated Emission	19
7.1 Test Limit	19
7.2 Test Procedures	19
7.3 Typical Test Setup	20
7.4 Test Result and Data (9kHz ~ 30MHz)	22
7.5 Test Result and Data (30MHz ~ 1GHz, worst emissions found)	22
7.6 Test Result and Data (Above 1GHz)	24
8. 6dB Bandwidth Measurement Data	36
8.1 Test Limit	36
8.2 Test Procedures	36
8.3 Test Setup Layout	36
8.4 Test Result and Data	37
9. Maximum Peak Output Power	44
9.1 Test Limit	44
9.2 Test Procedures	44
9.3 Test Setup Layout	44
9.4 Test Result and Data	45



10. Power Spectral Density	46
10.1 Test Limit	46
10.2 Test Procedures	46
10.3 Test Setup Layout	46
10.4 Test Result and Data	47
11. Band Edges Measurement	54
11.1 Test Limit	54
11.2 Test Procedure	54
11.3 Test Setup Layout	54
11.4 Test Result and Data	55
11.5 Restrict Band Emission Measurement Data	60
12. Conducted Spurious Emission	63
12.1 Test Limit	63
12.2 Test Procedure	63
12.3 Test Setup Layout	63
12.4 Test Result:	63
Conducted Emission Test Setup	77

**APPENDIX 1 PHOTOS OF TEST CONFIGURATION
PHOTOS OF EUT**



1. General Information

Applicant : Shenzhen Yifang Digital Technology Co., Ltd.

Address : YIFANG Building, No.315, Shuang Ming Avenue, Guang Ming Street, Guang Ming District, Shenzhen 518107, Guangdong, China

Manufacturer : Same as applicant

Address : Same as applicant

EUT : Portable Computer

Model Name : M1021AAP, M1021AAP *, NX16A10132SP, NX16A10132SP *

Model Differences : M1021AAP *, NX16A10132SP * (* represent 0 to 9, a to z, '-' or blank, these model all the same except color and model name)
According to the declaration from the applicant, the electrical circuit design, layout, components used and internal wiring were identical for all models, with only difference being the model name.

Therefore only one model NX16A10132SP was tested in this report.

Is here with confirmed to comply with the requirements set out in the FCC Rules and Regulations Part 15 Subpart C and the measurement procedures were according to ANSI C63.10-2013. The said equipment in the configuration described in this report shows the maximum emission levels emanating

FCC part 15 subpart C

Receipt Date : 09/01/2017

Final Test Date : 01/17/2018

Tested By:

Reviewed by:

Jan 18, 2018

Date

Bell Wei/ Engineer

Jan 18, 2018

Date

Mike Lee / Manager
Designation Number: TW1083



2. Report of Measurements and Examinations

2.1 List of Measurements and Examinations

FCC Rule	Description of Test	Result
15.203	. Antenna Requirement	Pass
15.207	. Conducted Emission	Pass
15.209 15.247(d)	. Radiated Emission	Pass
15.247(a)(2)	. 6dB Bandwidth	Pass
15.247(b)	. Maximum Peak Output Power	Pass
15.247(d)	. 100kHz Bandwidth of Frequency Band Edges	Pass
15.247(d)	. Conducted Spurious Emission (30MHz to 25GHz)	Pass
15.247(e)	. Power Spectral Density	Pass



3. Test Configuration of Equipment under Test

3.1 Description of the tested samples

EUT Name : Portable Computer

Model Number : NX16A10132SP

FCCID : S7JNX16A10132SP

Receipt Date : 09/01/2017

Input Voltage : 5Vdc from adaptor

Power From : Inside Outside
Adaptor Battery AC Power Source DC Power Source
Support Unit PC

Operate Frequency : Refer to the channel list as described below (2.412 ~2.462 GHz)

Modulation Technique : 802.11b: CCK/QPSK/BPSK
802.11g/n: BPSK/QPSK/16QAM/64QAM

Number of Channels : 802.11b, 802.11g, 802.11n HT20 : 11
802.11n HT40 : 7

Channel spacing : N/A 5 MHz

Operating Mode : Simplex Half Duplex

Antenna Type : Internal Antenna (PCB Antenna)

Antenna gain : 2.0 dBi



3.2 Carrier Frequency of Channels

802.11b, 802.11g, 802.11n HT 20 (2412MHz~2462MHz)

Channel	Frequency(MHz)	Channel	Frequency(MHz)
01	2412	07	2442
02	2417	08	2447
03	2422	09	2452
04	2427	10	2457
05	2432	11	2462
06	2437	---	---

802.11n HT 40 (2422MHz~2452MHz)

Channel	Frequency(MHz)	Channel	Frequency(MHz)
03	2422	07	2442
04	2427	08	2447
05	2432	09	2452
06	2437	---	---



3.3 Test Mode and Test Software

- a. During testing, the interface cables and equipment positions were varied according to ANSI C63.10.
- b. The complete test system included Notebook and EUT for RF test.
- c. An executive "QATEST" under XP was executed to keep transmitting and receiving data via Wireless.
- d. The following test modes were performed for test:
 - 802.11b/g/n HT20: CH01: 2412MHz, CH06: 2437MHz, CH11: 2462MHz
 - 802.11n HT40: CH03: 2422MHz, CH06: 2437MHz, CH09: 2452MHz



3.4 TEST Methodology & General Test Procedures

All testing as described bellowed were performed in accordance with ANSI C63.10:2013 and FCC CFR 47 Part 15 Subpart C.

Conducted Emissions

The EUT is placed on a wood table, which is at 0.8 m above ground plane acceding to clause 15.207 and requirements of ANSI C63.10:2013. Conducted emissions from the EUT measured in the frequency range between 0.15 MHz and 30MHz are using CISPR Quasi-Peak / Average detectors.

Radiated Emissions

The EUT is a placed on a turn table, which is 0.8 m or 1.5m above ground plane. The turntable was rotated through 360 degrees to determine the position of maximum emission level. The EUT is placed at 3m away from the receiving antenna, which varied from 1m to 4m to find out the highest emission. Each emission was to be maximized by changing the polarization of receiving antenna both horizontal and vertical.

- 1) Putting the EUT on the platform and turning on the EUT (on/off button on the bottom of the EUT).
- 2) Setting test channel described as “Channel setting and operating condition”, and testing channel by channel.
- 3) For the maximum output power measurement, we followed the method of measurement KDB558074 D01 v03r05.
- 4) For the spurious emission test based on ANSI C63.10-2013, at the frequency where below 1GHz used quasi-peak detector mode; where above 1GHz used the peak and average detector mode. IF the peak value may be under average limit, the average mode will not be performed.



3.5 Measurement Uncertainty

Measurement Item	Uncertainty
Radiated emission	±4.11dB
Peak Output Power(conducted)	±1.38dB
Peak Output Power(Radiated)	±1.70dB
Power Spectral Density	±1.39dB
Radiated emission(3m)	±4.11dB
Radiated emission(10m)	±3.89dB

3.6 Description of the Support Equipments

Setup Diagram

See test photographs attached in appendix 1 for the actual connections between EUT and support equipment.

Support Equipment

Peripherals Devices:

OUTSIDE SUPPORT EQUIPMENT							
No.	Equipment	Model	Serial No.	FCC ID/ BSMI ID	Trade name	Data Cable	Power Cord
1.	NA	NA	NA	NA	NA	NA	NA
INSIDE SUPPORT EQUIPMENT							
No.	Equipment	Model	Serial No.	FCC ID/ BSMI ID	Trade name	Data Cable	Power Cord
1.	AC adaptor	KSC-10A- 050200HU	N/A	N/A	N/A	N/A	N/A
2.	AC adaptor	NBS10B0 50200VUU	N/A	N/A	N/A	N/A	N/A

Note: All the above equipment /cable were placed in worse case position to maximize emission signals during emission test

Grounding: Grounding was in accordance with the manufacturer's requirement and conditions for the intended use.



4. Test and measurement equipment

4.1 calibration

The measuring equipment utilized to perform the tests documented in the report has been calibrated once a year or in accordance with the manufacturer's recommendations, and is traceable to recognized national standards.

4.2 equipment

The following list contains measurement equipment used for testing. The equipment conforms to the requirement of CISPR 16-1, ANSI C63.10 and. Other required standards.

Calibration of all test and measurement, including any accessories that may effect such calibration, is checked frequently to ensure the accuracy. Adjustments are made and correction factors are applied in accordance with the instructions contained in the respective.



TABLELIST OF TEST AND MEASUREMENT EQUIPMENT

Test Site	Instrument	Manufacturer	Model No.	S/N	Next Cal. Date
Conduction	Spectrum (9K--3GHz)	R&S	FSP3	833387/010	2018/09/20
	EMI Receiver	R&S	ESHS10	830223/008	2018/06/06
	LISN	Rolf Heine Hochfrequenztechnik	NNB-2/16z	98062	2018/06/11
	ISN	Schwarzbeck	8-Wire ISN CAT5	CAT5-8158-0094	2018/09/21
	RF Cable	N/A	N/A	EMI-3	2018/10/19
Radiation	Bilog antenna (30M-1G)	ETC	MCTD2786B	BLB16M04004/JB-5-004	2018/05/18
	Double Ridged Guide Horn antenna (1G-18G)	ETC	MCTD 1209	DRH15N02009	2018/11/23
	Horn antenna (18G-26G)	com-power	AH-826	81000	2018/08/16
	LOOP Antenna (Below 30M)	com-power	AL-130	17117	2018/10/04
	Pre amplifier (30M-1G)	EMC INSTRUMENT	EMC9135	980334	2018/05/03
	Microwave Preamplifier (1G-18G)	EMC INSTRUMENT	EMC051845	980108&A T -18001	2018/10/23
	Pre amplifier (18G~26G)	MITEQ	JS4-18002600-3 0-5A	808329	2018/08/09



	EMI Test Receiver	R&S	ESVS30 (20M-1000MHz)	826006/00 2	2018/11/28
	RF Cable (open site)	EMCI	N male on end of both sides (EMI4)	30m	2018/10/19
	RF CABLE (1~26G)	HARBOUT INDUSTRIES	LL142MI(4M+4M)	NA	2018/04/17
	RF CABLE (1~26G)	HARBOUR INDUSTRIES	LL142MI(7M)	NA	2018/08/09
	Spectrum (9K--7GHz)	R&S	FSP7	830180/00 6	2018/04/14
	Spectrum (9K--40GHz)	AGILENT	8564EC	4046A003 2	2018/03/01
Software	e3	AUDIX	N/A	N/A	N/A
SG	SINGAL GENERATOR R(100k-1GHz)	HP	8648A	3619U004 26	N/A

***CALIBRATION INTERVAL OF INSTRUMENTS LISTED ABOVE IS ONE YEAR**



5. Antenna Requirements

5.1 Standard Applicable

For intentional device, according to FCC 47 CFR Section 15.203, an intentional radiator shall be designed to ensure that no antenna other than that furnished by the responsible party shall be used with the device.

And according to FCC 47 CFR Section 15.247 (b), if transmitting antennas of directional gain greater than 6dBi are used, the power shall be reduced by the amount in dB that the directional gain of the antenna exceeds 6dBi.

5.2 Antenna Construction and Directional Gain

BT and WiFi 802.11b/g/n:

Antenna Type: Internal Antenna (PCB Antenna)

Antenna Gain: 2.0 dBi



6. Test of Conducted Emission

6.1 Test Limit

Conducted Emissions were measured from 150 kHz to 30 MHz with a bandwidth of 9 KHz on the 120 VAC power and return leads of the EUT according to the methods defined in ANSI C63.10-2013 Section 3.1. The EUT was placed on a nonmetallic stand in a shielded room 0.8 meters above the ground plane as shown in section 2.2. The interface cables and equipment positioning were varied within limits of reasonable applications to determine the position produced maximum conducted emissions.

Frequency (MHz)	Quasi Peak (dB μ V)	Average (dB μ V)
0.15 – 0.5	66-56*	56-46*
0.5 – 5.0	56	46
5.0 – 30.0	60	50

*Decreases with the logarithm of the frequency.

6.2 Test Procedures

- a. The EUT was placed 0.4 meter from the conducting wall of the shielding room was kept at least 80 centimeters from any other grounded conducting surface.
- b. Connect EUT to the power mains through a line impedance stabilization network (LISN).
- c. All the support units are connecting to the other LISN.
- d. The LISN provides 50 ohm coupling impedance for the measuring instrument.
- e. The FCC states that a 50 ohm, 50 micro-Henry LISN should be used.
- f. Both sides of AC line were checked for maximum conducted interference.
- g. The frequency range from 150 kHz to 30 MHz was searched.
- h. Set the test-receiver system to Peak Detect Function and Specified Bandwidth with Maximum Hold Mode.



6.3 Typical Test Setup

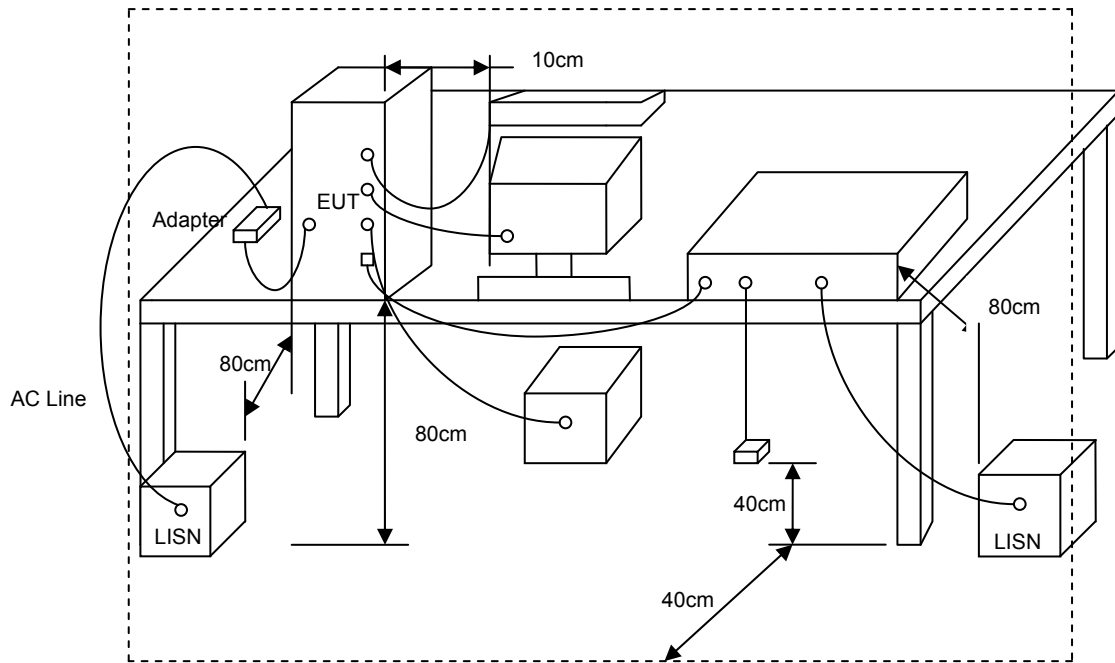



6.4 Test Result and Data

Power	: AC 120V/60Hz	Pol/Phase	: LINE
Test Mode 1	: 802.11 b CH11 TX (Worst)	Temperature	: 26 °C
Memo	:	Humidity	: 55 %

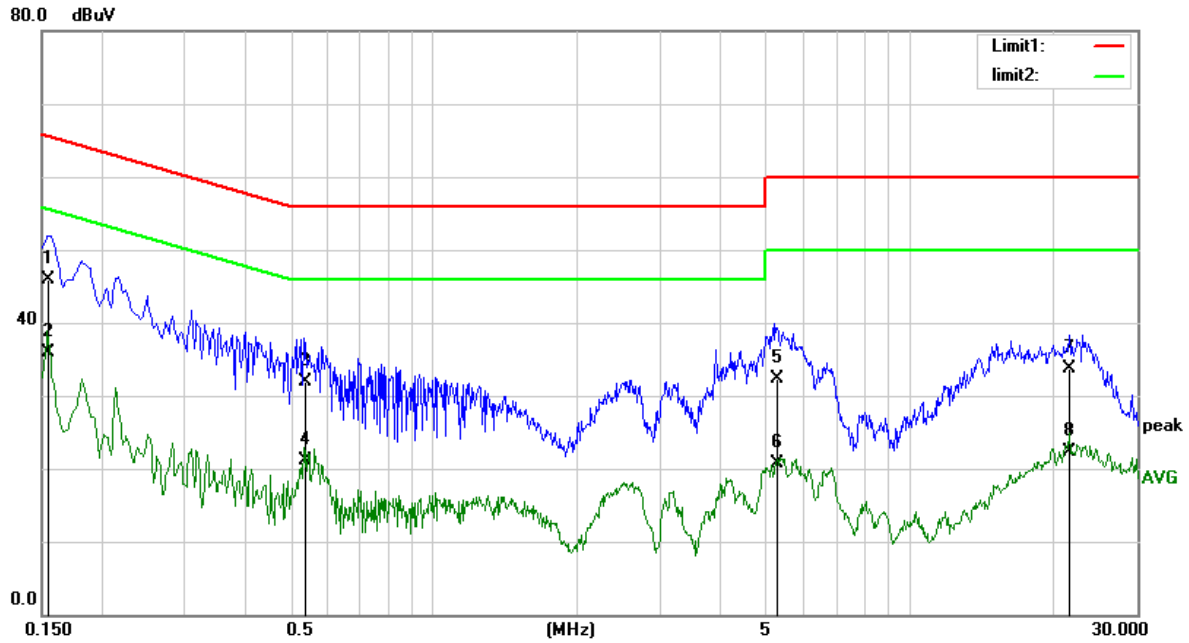

No.	Mk.	Freq. MHz	Reading Level dBuV	Correct Factor dB	Measure- ment dBuV	Limit dB	Over dB	Detector	Comment
1	*	0.1547	36.14	9.79	45.93	65.74	-19.81	QP	
2		0.1547	26.11	9.79	35.90	55.74	-19.84	AVG	
3		0.5385	22.44	9.55	31.99	56.00	-24.01	QP	
4		0.5385	11.48	9.55	21.03	46.00	-24.97	AVG	
5		5.2306	19.86	12.47	32.33	60.00	-27.67	QP	
6		5.2306	8.18	12.47	20.65	50.00	-29.35	AVG	
7		21.6603	21.02	12.70	33.72	60.00	-26.28	QP	
8		21.6603	9.56	12.70	22.26	50.00	-27.74	AVG	



Power	: AC 120V/60Hz	Pol/Phase	: NEUTRAL
Test Mode 1	: 802.11 b CH11 TX (Worst)	Temperature	: 26 °C
Memo	:	Humidity	: 55 %

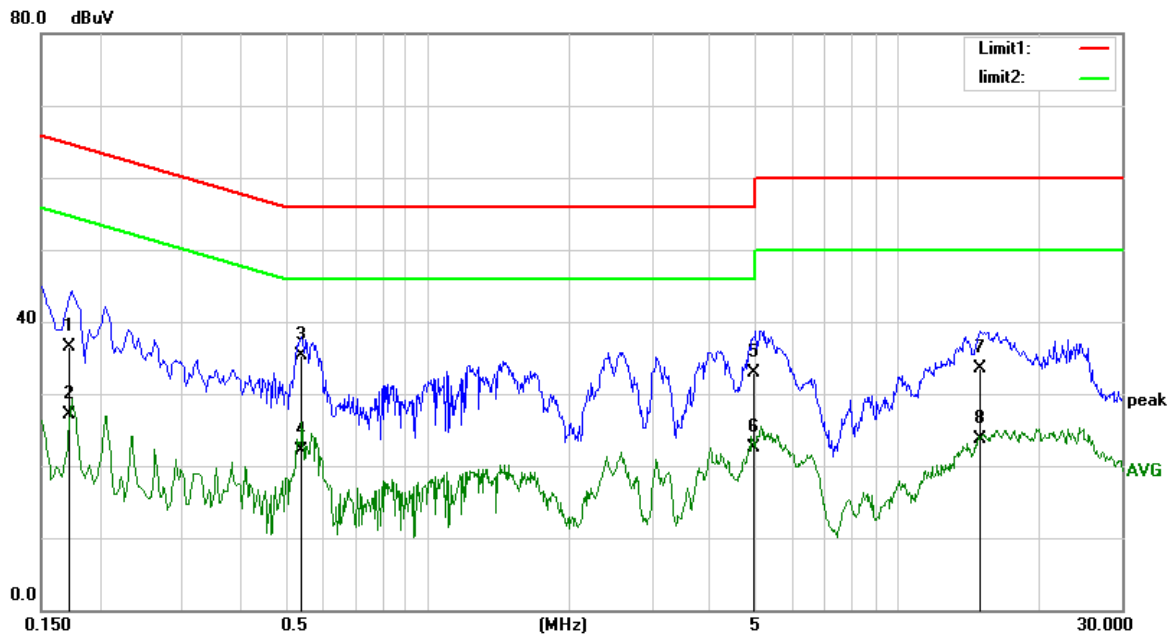

No.	Mk.	Freq. MHz	Reading Level dBuV	Correct Factor dB	Measure- ment dBuV	Limit dB	Over dB	Detector	Comment
1		0.1719	26.72	9.73	36.45	64.86	-28.41	QP	
2		0.1719	17.41	9.73	27.14	54.86	-27.72	AVG	
3	*	0.5375	25.73	9.53	35.26	56.00	-20.74	QP	
4		0.5375	12.59	9.53	22.12	46.00	-23.88	AVG	
5		4.9569	20.47	12.40	32.87	56.00	-23.13	QP	
6		4.9569	10.19	12.40	22.59	46.00	-23.41	AVG	
7		14.9615	20.77	12.73	33.50	60.00	-26.50	QP	
8		14.9615	11.04	12.73	23.77	50.00	-26.23	AVG	



7. Test of Radiated Emission

7.1 Test Limit

In any 100kHz bandwidth outside the frequency band in which the spread spectrum or digitally modulated intentional radiator is operating, the radio frequency power that is produced by the intentional radiator shall be at least 20dB below that in the 100kHz bandwidth within the band that contains the highest level of the desired power, based on either an RF conducted or a radiated measurement. If the transmitter measurement is based on the maximum conducted output power, the attenuation required under this paragraph shall be 30dB instead of 20dB. In addition, radiated emissions which fall in section 15.205(a) the restricted bands must also comply with the radiated emission limit specified in section 15.209(a).

Frequency (MHz)	Field Strength (microvolt/meter)	Measurement Distance (meters)
0.009 ~ 0.490	2400/F(kHz)	300
0.490 ~ 1.705	24000/F(kHz)	30
1.705 ~ 30.0	30	30
30 ~ 88	100	3
88 ~ 216	150	3
216 ~ 960	200	3
Above 960	500	3

7.2 Test Procedures

- a. The EUT was placed on a rotatable table top 0.8 meter above ground.
- b. The EUT was set 3 meters from the interference receiving antenna which was mounted on the top of a variable height antenna tower.
- c. The table was rotated 360 degrees to determine the position of the highest radiation.
- d. The antenna is a broadband antenna and its height is varied between one meter and four meters above ground to find the maximum value of the field strength both horizontal polarization and vertical polarization of the antenna are set to make the measurement.
- e. For each suspected emission the EUT was arranged to its worst case and then tune the antenna tower (from 1 M to 4 M) and turn table (from 0 degree to 360 degrees) to find the maximum reading.
- f. Set the test-receiver system to Peak or CISPR quasi-peak Detect Function and specified bandwidth with Maximum Hold Mode.
- g. If the emission level of the EUT in peak mode was 3 dB lower than the limit specified, then testing will be stopped and peak values of EUT will be reported, otherwise, the emissions which do not have 3 dB margin will be repeated one by one using the quasi-peak method and reported.
- h. For testing above 1GHz, the emission level of the EUT in peak mode was 20dB lower than average limit (that means the emission level in peak mode also complies with the limit in



average mode), then testing will be stopped and peak values of EUT will be reported, otherwise, the emissions will be measured in average mode again and reported.

- i. "Cone of radiation" has been considered to be 3dB bandwidth of the measurement antenna.

7.3 Typical Test Setup

For radiated emissions below 30MHz

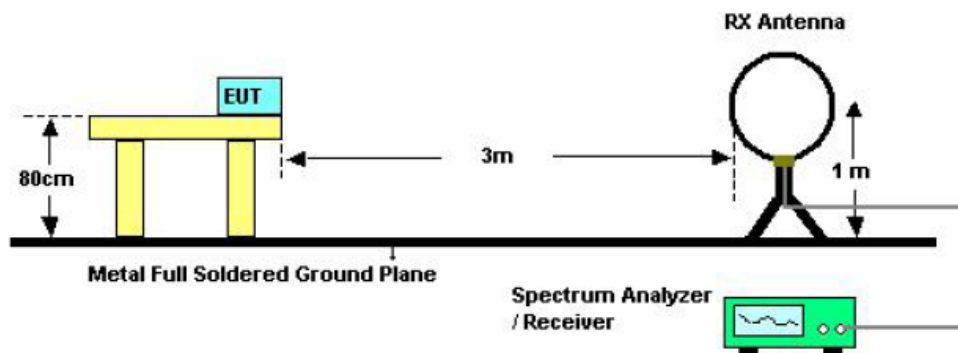

For radiated emissions above 30MHz

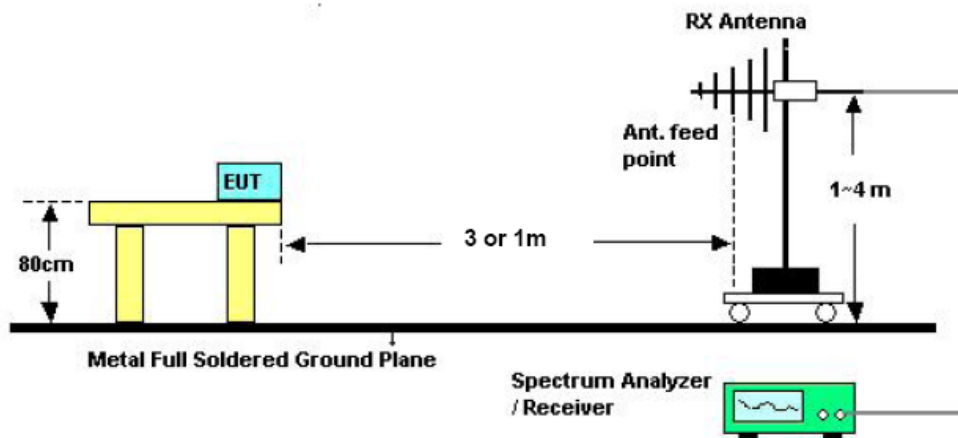



For radiated emissions frequency above 1GHz

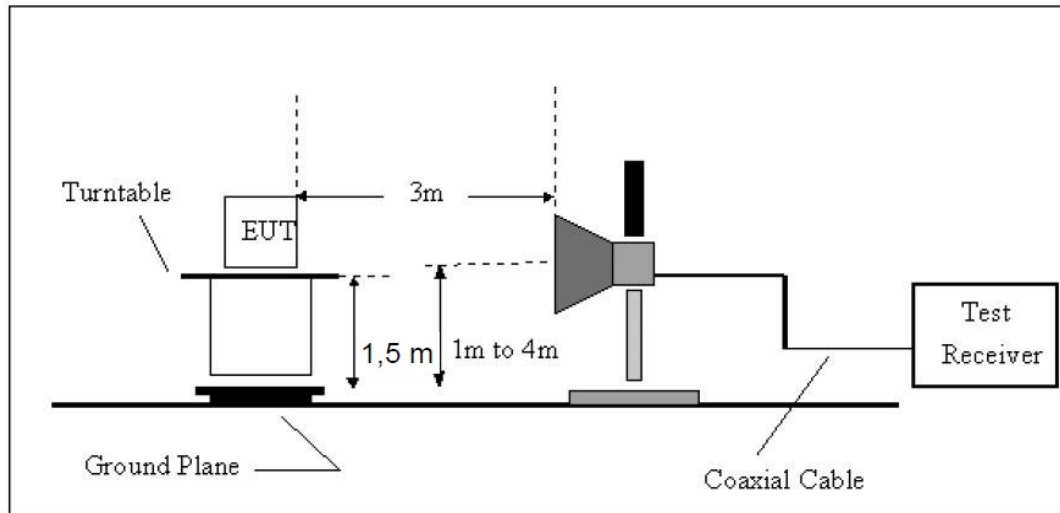

Above 10 GHz shall be extrapolated to the specified distance using an extrapolation factor of 20 dB/decade from 3m to 1m.

Distance extrapolation factor = $20 \log (\text{specific distance [3m]} / \text{test distance [1m]})$ (dB);

Limit line = specific limits (dBuV) + distance extrapolation factor [9.54 dB].



7.4 Test Result and Data (9kHz ~ 30MHz)

The 9kHz - 30MHz spurious emission is under limit 20dB more.

7.5 Test Result and Data (30MHz ~ 1GHz, worst emissions found)

Power	: 3.8VDC	Pol/Phase	: HORIZONTAL
Test Mode 1	: 802.11 b CH11 TX (Worst)	Temperature	: 25 °C
Memo	:	Humidity	: 66 %

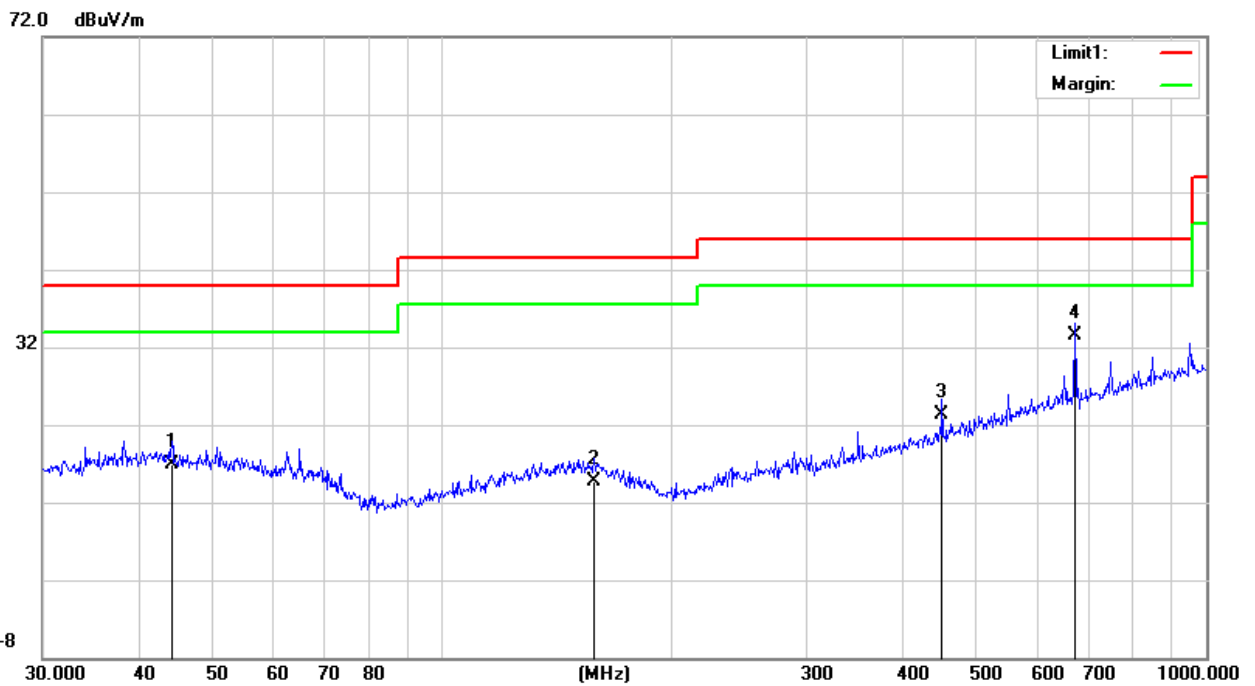

No.	Mk.	Freq. MHz	Reading Level dBuV	Correct Factor dB	Measure- ment dBuV/m	Limit dB/m	Over dB	Detector	Comment
1		44.2751	3.62	13.29	16.91	40.00	-23.09	QP	
2		158.1123	2.08	12.66	14.74	43.50	-28.76	QP	
3		451.1349	6.91	16.32	23.23	46.00	-22.77	QP	
4	*	672.8444	13.10	20.47	33.57	46.00	-12.43	QP	



Power	: 3.8VDC	Pol/Phase	: VERTICAL
Test Mode 1	: 802.11 b CH11 TX (Worst)	Temperature	: 25 °C
Memo	:	Humidity	: 66 %

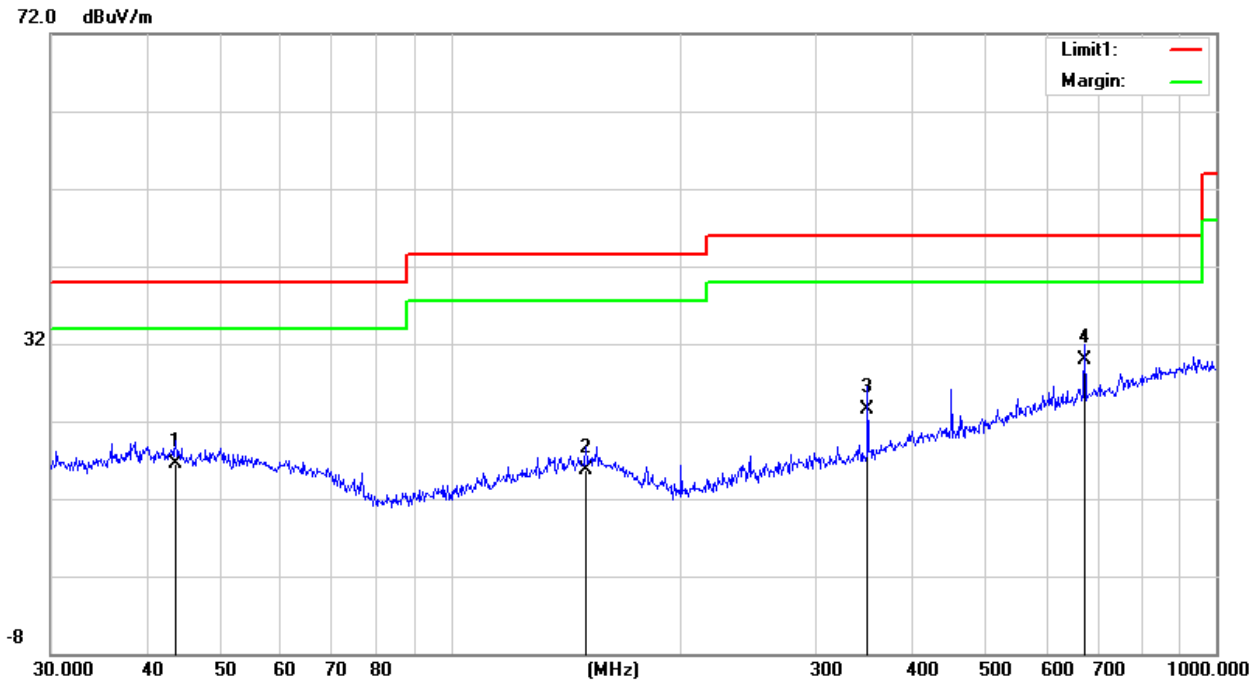

No.	Mk.	Freq. MHz	Reading Level dBuV	Correct Factor dB	Measure- ment dBuV/m	Limit dB/m	Over dB	Detector	Comment
1		43.6584	3.23	13.32	16.55	40.00	-23.45	QP	
2		150.0107	3.28	12.50	15.78	43.50	-27.72	QP	
3		350.4768	9.32	14.11	23.43	46.00	-22.57	QP	
4	*	672.8444	9.47	20.47	29.94	46.00	-16.06	QP	



7.6 Test Result and Data (Above 1GHz)

Power	: 3.8VDC	Pol/Phase	: H/V
Test Mode 1	: 802.11b, 1Mbps, CH1 TX	Temperature	: 25 °C
Memo	:	Humidity	: 66 %

(a) Antenna polarization: Horizontal

Frequency (MHz)	Reading Level (dBuV)	Correct Factor (dB)	Measure Level (dBuV/m)	Limit (dBuV/m)	Margin (dB)	Detector Type
4824.00	65.90	-6.06	59.84	74.00	-14.16	PEAK
4824.00	52.09	-6.06	46.03	54.00	-7.97	AVERAGE
7236.00	50.75	0.18	50.93	74.00	-23.07	PEAK
7236.00	42.09	0.18	42.27	54.00	-11.73	AVERAGE

(b) Antenna polarization: Vertical

Frequency (MHz)	Reading Level (dBuV)	Correct Factor (dB)	Measure Level (dBuV/m)	Limit (dBuV/m)	Margin (dB)	Detector Type
4824.00	62.76	-6.06	56.70	74.00	-17.30	PEAK
4824.00	52.02	-6.06	45.96	54.00	-8.04	AVERAGE
7236.00	51.05	0.18	51.23	74.00	-22.77	PEAK
7236.00	40.22	0.18	40.40	54.00	-13.60	AVERAGE



Power	: 3.8VDC	Pol/Phase	: H/V
Test Mode 1	: 802.11b, 1Mbps, CH6 TX	Temperature	: 25 °C
Memo	:	Humidity	: 66 %

(a) Antenna polarization: Horizontal

Frequency (MHz)	Reading Level (dBuV)	Correct Factor (dB)	Measure Level (dBuV/m)	Limit (dBuV/m)	Margin (dB)	Detector Type
4874.00	62.18	-5.93	56.25	74.00	-17.75	PEAK
4874.00	53.18	-5.93	47.25	54.00	-6.75	AVERAGE
7311.00	53.03	0.51	53.54	74.00	-20.46	PEAK
7311.00	39.08	0.51	39.59	54.00	-14.41	AVERAGE

(b) Antenna polarization: Vertical

Frequency (MHz)	Reading Level (dBuV)	Correct Factor (dB)	Measure Level (dBuV/m)	Limit (dBuV/m)	Margin (dB)	Detector Type
4874.00	60.92	-5.93	54.99	74.00	-19.01	PEAK
4874.00	51.59	-5.93	45.66	54.00	-8.34	AVERAGE
7311.00	52.71	0.51	53.22	74.00	-20.78	PEAK
7311.00	39.78	0.51	40.29	54.00	-13.71	AVERAGE



Power	: 3.8VDC	Pol/Phase	: H/V
Test Mode 1	: 802.11b, 1Mbps, CH11 TX	Temperature	: 25 °C
Memo	:	Humidity	: 66 %

(a) Antenna polarization: Horizontal

Frequency (MHz)	Reading Level (dBuV)	Correct Factor (dB)	Measure Level (dBuV/m)	Limit (dBuV/m)	Margin (dB)	Detector Type
4924.00	60.57	-5.70	54.87	74.00	-19.13	PEAK
4924.00	49.61	-5.70	43.91	54.00	-10.09	AVERAGE
7386.00	52.24	0.81	53.05	74.00	-20.95	PEAK
7386.00	38.36	0.81	39.17	54.00	-14.83	AVERAGE

(b) Antenna polarization: Vertical

Frequency (MHz)	Reading Level (dBuV)	Correct Factor (dB)	Measure Level (dBuV/m)	Limit (dBuV/m)	Margin (dB)	Detector Type
4924.00	58.55	-5.70	52.85	74.00	-21.15	PEAK
4924.00	45.65	-5.70	39.95	54.00	-14.05	AVERAGE
7386.00	51.03	0.81	51.84	74.00	-22.16	PEAK
7386.00	37.26	0.81	38.07	54.00	-15.93	AVERAGE



Power	: 3.8VDC	Pol/Phase	: H/V
Test Mode 1	: 802.11g, 6Mbps, CH1 TX	Temperature	: 25 °C
Memo	:	Humidity	: 66 %

(a) Antenna polarization: Horizontal

Frequency (MHz)	Reading Level (dBuV)	Correct Factor (dB)	Measure Level (dBuV/m)	Limit (dBuV/m)	Margin (dB)	Detector Type
4824.00	59.53	-6.06	53.47	74.00	-20.53	PEAK
4824.00	46.17	-6.06	40.11	54.00	-13.89	AVERAGE
7236.00	52.10	0.18	52.28	74.00	-21.72	PEAK
7236.00	38.25	0.18	38.43	54.00	-15.57	AVERAGE

(b) Antenna polarization: Vertical

Frequency (MHz)	Reading Level (dBuV)	Correct Factor (dB)	Measure Level (dBuV/m)	Limit (dBuV/m)	Margin (dB)	Detector Type
4824.00	59.99	-6.06	53.93	74.00	-20.07	PEAK
4824.00	45.11	-6.06	39.05	54.00	-14.95	AVERAGE
7236.00	52.77	0.18	52.95	74.00	-21.05	PEAK
7236.00	37.06	0.18	37.24	54.00	-16.76	AVERAGE



Power	:	3.8VDC	Pol/Phase	:	H/V
Test Mode 1	:	802.11g, 6Mbps, CH6 TX	Temperature	:	25 °C
Memo	:		Humidity	:	66 %

(a) Antenna polarization: Horizontal

Frequency (MHz)	Reading Level (dBuV)	Correct Factor (dB)	Measure Level (dBuV/m)	Limit (dBuV/m)	Margin (dB)	Detector Type
4874.00	59.93	-5.93	54.00	74.00	-20.00	PEAK
4874.00	48.37	-5.93	42.44	54.00	-11.56	AVERAGE
7311.00	51.28	0.51	51.79	74.00	-22.21	PEAK
7311.00	37.77	0.51	38.28	54.00	-15.72	AVERAGE

(b) Antenna polarization: Vertical

Frequency (MHz)	Reading Level (dBuV)	Correct Factor (dB)	Measure Level (dBuV/m)	Limit (dBuV/m)	Margin (dB)	Detector Type
4874.00	59.66	-5.93	53.73	74.00	-20.27	PEAK
4874.00	47.41	-5.93	41.48	54.00	-12.52	AVERAGE
7311.00	50.92	0.51	51.43	74.00	-22.57	PEAK
7311.00	38.08	0.51	38.59	54.00	-15.41	AVERAGE



Power	: 3.8VDC	Pol/Phase	: H/V
Test Mode 1	: 802.11g, 6Mbps, CH11 TX	Temperature	: 25 °C
Memo	:	Humidity	: 66 %

(a) Antenna polarization: Horizontal

Frequency (MHz)	Reading Level (dBuV)	Correct Factor (dB)	Measure Level (dBuV/m)	Limit (dBuV/m)	Margin (dB)	Detector Type
4924.00	63.80	-5.70	58.10	74.00	-15.90	PEAK
4924.00	50.35	-5.70	44.65	54.00	-9.35	AVERAGE
7386.00	52.85	0.81	53.66	74.00	-20.34	PEAK
7386.00	38.49	0.81	39.30	54.00	-14.70	AVERAGE

(b) Antenna polarization: Vertical

Frequency (MHz)	Reading Level (dBuV)	Correct Factor (dB)	Measure Level (dBuV/m)	Limit (dBuV/m)	Margin (dB)	Detector Type
4924.00	59.24	-5.70	53.54	74.00	-20.46	PEAK
4924.00	47.18	-5.70	41.48	54.00	-12.52	AVERAGE
7386.00	53.74	0.81	54.55	74.00	-19.45	PEAK
7386.00	40.84	0.81	41.65	54.00	-12.35	AVERAGE



Power	: 3.8VDC	Pol/Phase	: H/V
Test Mode 1	: 802.11n HT20, 7.2Mbps, CH1 TX	Temperature	: 25 °C
Memo	:	Humidity	: 66 %

(a) Antenna polarization: Horizontal

Frequency (MHz)	Reading Level (dBuV)	Correct Factor (dB)	Measure Level (dBuV/m)	Limit (dBuV/m)	Margin (dB)	Detector Type
4824.00	62.54	-6.06	56.48	74.00	-17.52	PEAK
4824.00	50.26	-6.06	44.20	54.00	-9.80	AVERAGE
7236.00	52.06	0.18	52.24	74.00	-21.76	PEAK
7236.00	38.64	0.18	38.82	54.00	-15.18	AVERAGE

(b) Antenna polarization: Vertical

Frequency (MHz)	Reading Level (dBuV)	Correct Factor (dB)	Measure Level (dBuV/m)	Limit (dBuV/m)	Margin (dB)	Detector Type
4824.00	62.12	-6.06	56.06	74.00	-17.94	PEAK
4824.00	50.42	-6.06	44.36	54.00	-9.64	AVERAGE
7236.00	52.16	0.18	52.34	74.00	-21.66	PEAK
7236.00	39.23	0.18	39.41	54.00	-14.59	AVERAGE



Power	: 3.8VDC	Pol/Phase	: H/V
Test Mode 1	: 802.11n HT20, 7.2Mbps, CH6 TX	Temperature	: 25 °C
Memo	:	Humidity	: 66 %

(a) Antenna polarization: Horizontal

Frequency (MHz)	Reading Level (dBuV)	Correct Factor (dB)	Measure Level (dBuV/m)	Limit (dBuV/m)	Margin (dB)	Detector Type
4874.00	63.49	-5.93	57.56	74.00	-16.44	PEAK
4874.00	52.52	-5.93	46.59	54.00	-7.41	AVERAGE
7311.00	52.51	0.51	53.02	74.00	-20.98	PEAK
7311.00	40.36	0.51	40.87	54.00	-13.13	AVERAGE

(b) Antenna polarization: Vertical

Frequency (MHz)	Reading Level (dBuV)	Correct Factor (dB)	Measure Level (dBuV/m)	Limit (dBuV/m)	Margin (dB)	Detector Type
4874.00	63.75	-5.93	57.82	74.00	-16.18	PEAK
4874.00	49.07	-5.93	43.14	54.00	-10.86	AVERAGE
7311.00	52.58	0.51	53.09	74.00	-20.91	PEAK
7311.00	41.66	0.51	42.17	54.00	-11.83	AVERAGE



Power	: 3.8VDC	Pol/Phase	: H/V
Test Mode 1	: 802.11n HT20, 7.2Mbps, CH11 TX	Temperature	: 25 °C
Memo	:	Humidity	: 66 %

(a) Antenna polarization: Horizontal

Frequency (MHz)	Reading Level (dBuV)	Correct Factor (dB)	Measure Level (dBuV/m)	Limit (dBuV/m)	Margin (dB)	Detector Type
4924.00	60.54	-5.70	54.84	74.00	-19.16	PEAK
4924.00	50.40	-5.70	44.70	54.00	-9.30	AVERAGE
7386.00	52.59	0.81	53.40	74.00	-20.60	PEAK
7386.00	37.75	0.81	38.56	54.00	-15.44	AVERAGE

(b) Antenna polarization: Vertical

Frequency (MHz)	Reading Level (dBuV)	Correct Factor (dB)	Measure Level (dBuV/m)	Limit (dBuV/m)	Margin (dB)	Detector Type
4924.00	61.03	-5.70	55.33	74.00	-18.67	PEAK
4924.00	49.81	-5.70	44.11	54.00	-9.89	AVERAGE
7386.00	53.13	0.81	53.94	74.00	-20.06	PEAK
7386.00	37.80	0.81	38.61	54.00	-15.39	AVERAGE



Power	: 3.8VDC	Pol/Phase	: H/V
Test Mode 1	: 802.11n HT40, 15Mbps, CH3 TX	Temperature	: 25 °C
Memo	:	Humidity	: 66 %

(a) Antenna polarization: Horizontal

Frequency (MHz)	Reading Level (dBuV)	Correct Factor (dB)	Measure Level (dBuV/m)	Limit (dBuV/m)	Margin (dB)	Detector Type
4844.00	57.56	-6.07	51.49	74.00	-22.51	PEAK
4844.00	48.87	-6.07	42.80	54.00	-11.20	AVERAGE
7266.00	53.90	0.17	54.07	74.00	-19.93	PEAK
7266.00	43.60	0.17	43.77	54.00	-10.23	AVERAGE

(b) Antenna polarization: Vertical

Frequency (MHz)	Reading Level (dBuV)	Correct Factor (dB)	Measure Level (dBuV/m)	Limit (dBuV/m)	Margin (dB)	Detector Type
4844.00	60.65	-6.07	54.58	74.00	-19.42	PEAK
4844.00	50.64	-6.07	44.57	54.00	-9.43	AVERAGE
7266.00	54.76	0.17	54.93	74.00	-19.07	PEAK
7266.00	42.74	0.17	42.91	54.00	-11.09	AVERAGE



Power	: 3.8VDC	Pol/Phase	: H/V
Test Mode 1	: 802.11n HT40, 15Mbps, CH6 TX	Temperature	: 25 °C
Memo	:	Humidity	: 66 %

(a) Antenna polarization: Horizontal

Frequency (MHz)	Reading Level (dBuV)	Correct Factor (dB)	Measure Level (dBuV/m)	Limit (dBuV/m)	Margin (dB)	Detector Type
4874.00	57.85	-5.93	51.92	74.00	-22.08	PEAK
4874.00	50.44	-5.93	44.51	54.00	-9.49	AVERAGE
7311.00	58.63	0.51	59.14	74.00	-14.86	PEAK
7311.00	39.71	0.51	40.22	54.00	-13.78	AVERAGE

(b) Antenna polarization: Vertical

Frequency (MHz)	Reading Level (dBuV)	Correct Factor (dB)	Measure Level (dBuV/m)	Limit (dBuV/m)	Margin (dB)	Detector Type
4874.00	60.96	-5.93	55.03	74.00	-18.97	PEAK
4874.00	48.08	-5.93	42.15	54.00	-11.85	AVERAGE
7311.00	58.54	0.51	59.05	74.00	-14.95	PEAK
7311.00	39.23	0.51	39.74	54.00	-14.26	AVERAGE



Power	: 3.8VDC	Pol/Phase	: H/V
Test Mode 1	: 802.11n HT40, 15Mbps, CH9 TX	Temperature	: 25 °C
Memo	:	Humidity	: 66 %

(a) Antenna polarization: Horizontal

Frequency (MHz)	Reading Level (dBuV)	Correct Factor (dB)	Measure Level (dBuV/m)	Limit (dBuV/m)	Margin (dB)	Detector Type
4904.00	59.07	-5.71	53.36	74.00	-20.64	PEAK
4904.00	49.74	-5.71	44.03	54.00	-9.97	AVERAGE
7356.00	54.89	0.80	55.69	74.00	-18.31	PEAK
7356.00	38.33	0.80	39.13	54.00	-14.87	AVERAGE

(b) Antenna polarization: Vertical

Frequency (MHz)	Reading Level (dBuV)	Correct Factor (dB)	Measure Level (dBuV/m)	Limit (dBuV/m)	Margin (dB)	Detector Type
4904.00	57.58	-5.71	51.87	74.00	-22.13	PEAK
4904.00	50.99	-5.71	45.28	54.00	-8.72	AVERAGE
7356.00	58.01	0.80	58.81	74.00	-15.19	PEAK
7356.00	40.16	0.80	40.96	54.00	-13.04	AVERAGE

The field strength is calculated by adding the Antenna Factor. Cable Factor & Preamplifier. The basic equation with a sample calculation is as follows:

Measure Level = Reading Level + Correct Factor.

As shown in Section, for frequencies above 1000 MHz. the above field strength limits are based on average limits. However, the peak field strength of any emission shall not exceed the maximum permitted average limits specified above by more than 20 dB under any condition of modulation.

No any other emissions level which are attenuated less than 20dB below the limit. According to 15.31(o), The amplitude of spurious emissions from intentional radiators and emissions from unintentional radiators which are attenuated more than 20 dB below the permissible value need not be reported unless specifically required elsewhere in this Part. Hence there no other emissions have been reported.



8. 6dB Bandwidth Measurement Data

8.1 Test Limit

The minimum of 6dB Bandwidth Measurement is 0.5 MHz.

8.2 Test Procedures

- a. The transmitter output was connected to the spectrum analyzer.
- b. Set RBW of spectrum analyzer to 1~5% of the emission bandwidth and $VBW \geq 3x RBW$.
- c. The 6 dB bandwidth is defined as the total spectrum the power of which is higher than peak power minus 6 dB.
- d. The 6dB Bandwidth was measured and recorded.

8.3 Test Setup Layout

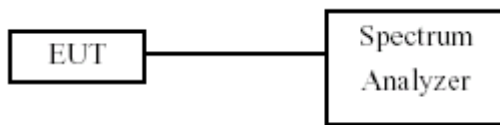



8.4 Test Result and Data

Test Date: Nov. 25, 2017

Temperature: 24°C

Atmospheric pressure: 996 pha

Humidity: 58%

Modulation Standard	Channel	Frequency (MHz)	6dB Bandwidth (MHz)
802.11b (1Mbps)	01	2412	10.26
	06	2437	10.26
	11	2462	10.20
802.11g (6Mbps)	01	2412	16.62
	06	2437	16.68
	11	2462	16.68
802.11n HT20 (7.2Mbps)	01	2412	17.94
	06	2437	17.82
	11	2462	17.88
802.11n HT40 (15Mbps)	03	2422	36.70
	06	2437	36.60
	09	2452	36.60



Modulation Standard: 802.11b (1Mbps)
Channel: 01

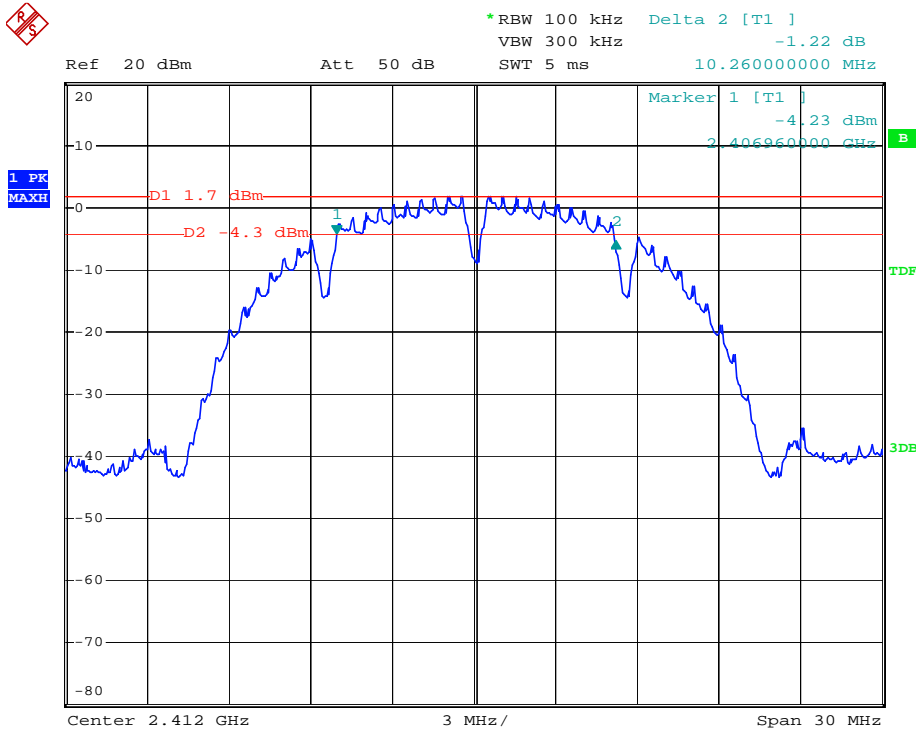

Modulation Standard: 802.11b (1Mbps)
Channel: 06

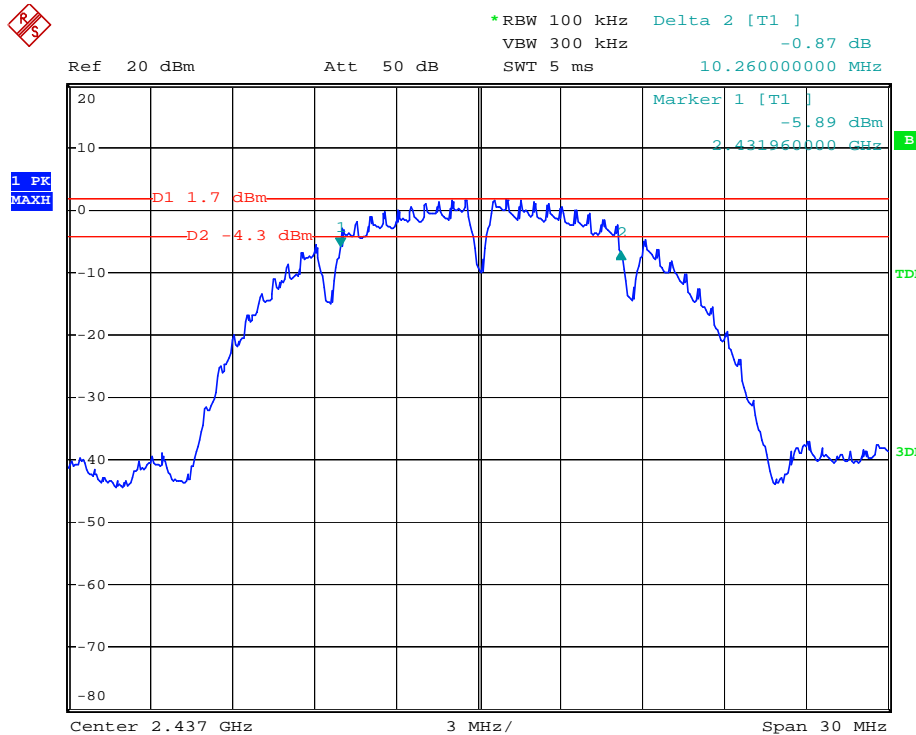



Modulation Standard: 802.11b (1Mbps)
Channel: 11

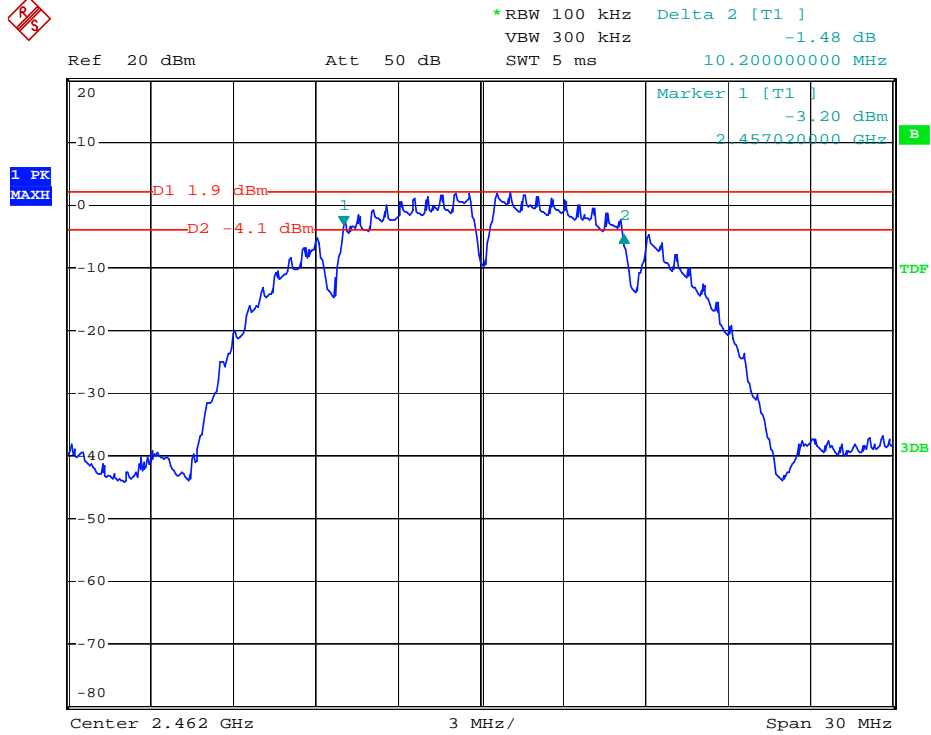

Modulation Standard: 802.11g (6Mbps)
Channel: 01

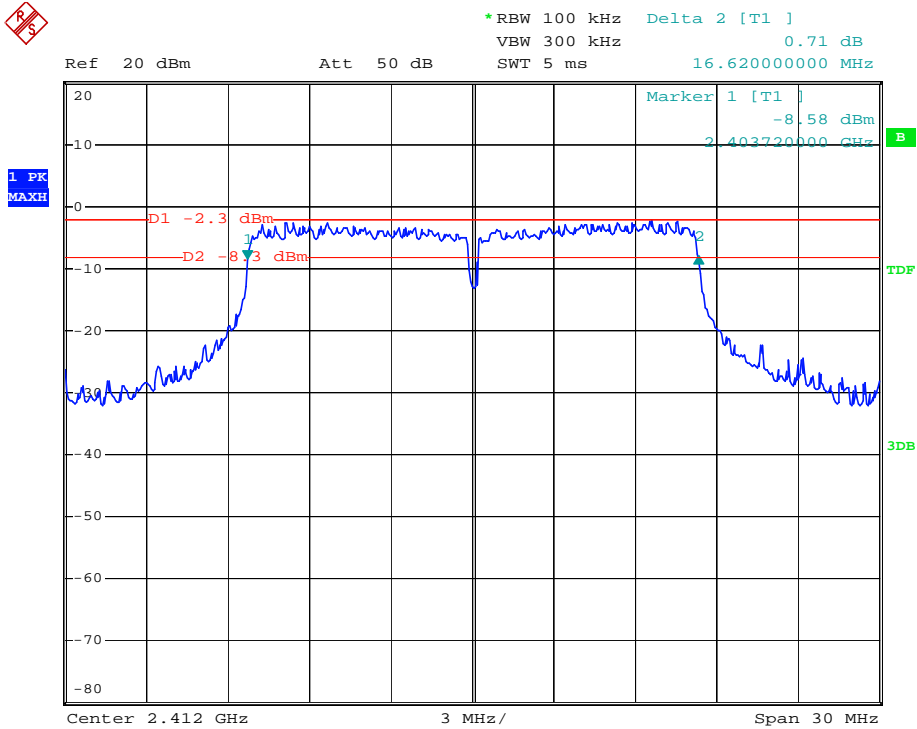



Modulation Standard: 802.11g (6Mbps)
Channel: 06

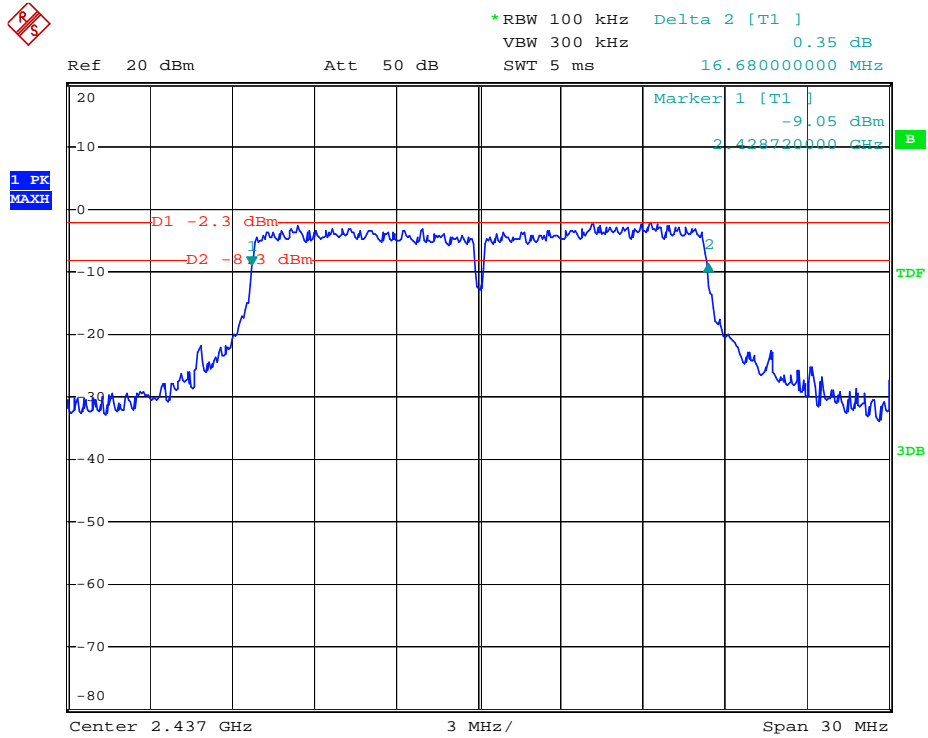

Modulation Standard: 802.11g (6Mbps)
Channel: 11

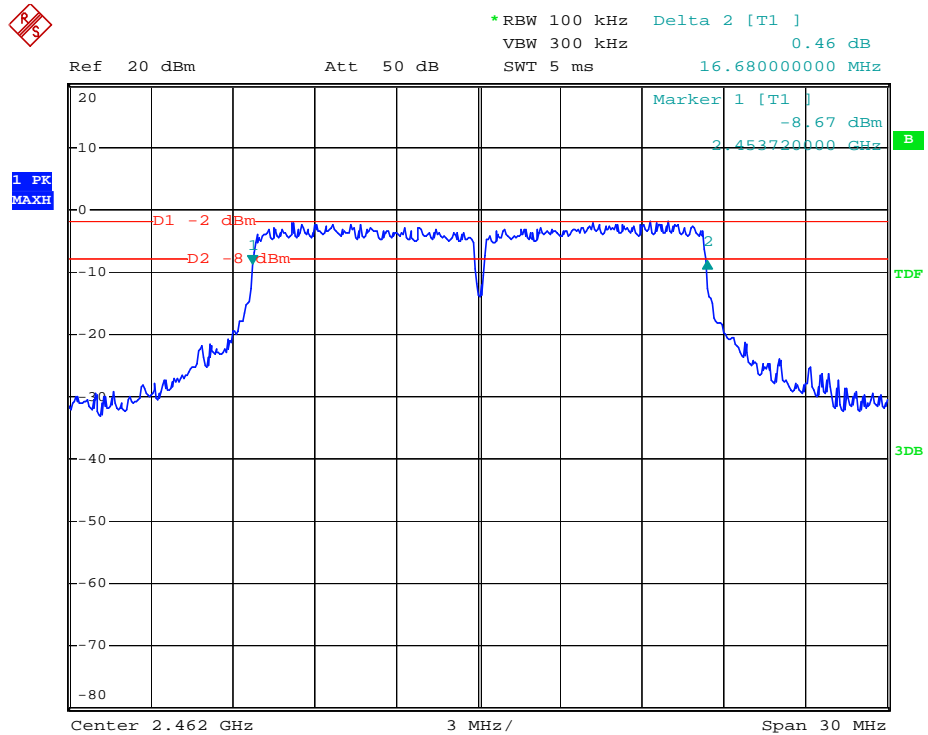



Modulation Standard: 802.11n HT20 (7.2Mbps)
Channel: 01

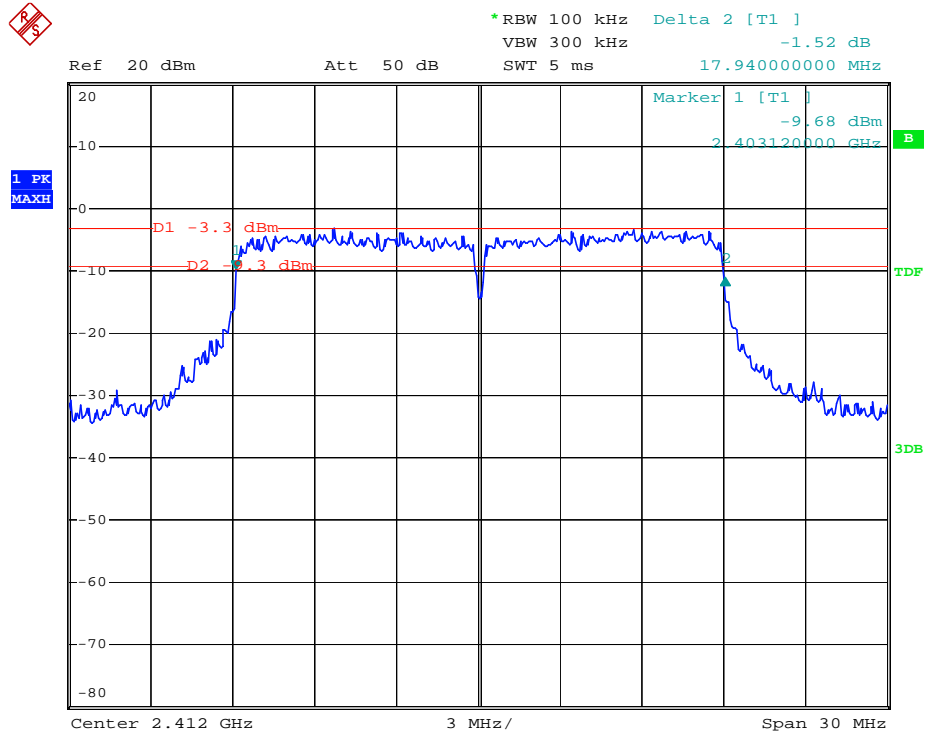

Modulation Standard: 802.11n HT20 (7.2Mbps)
Channel: 06

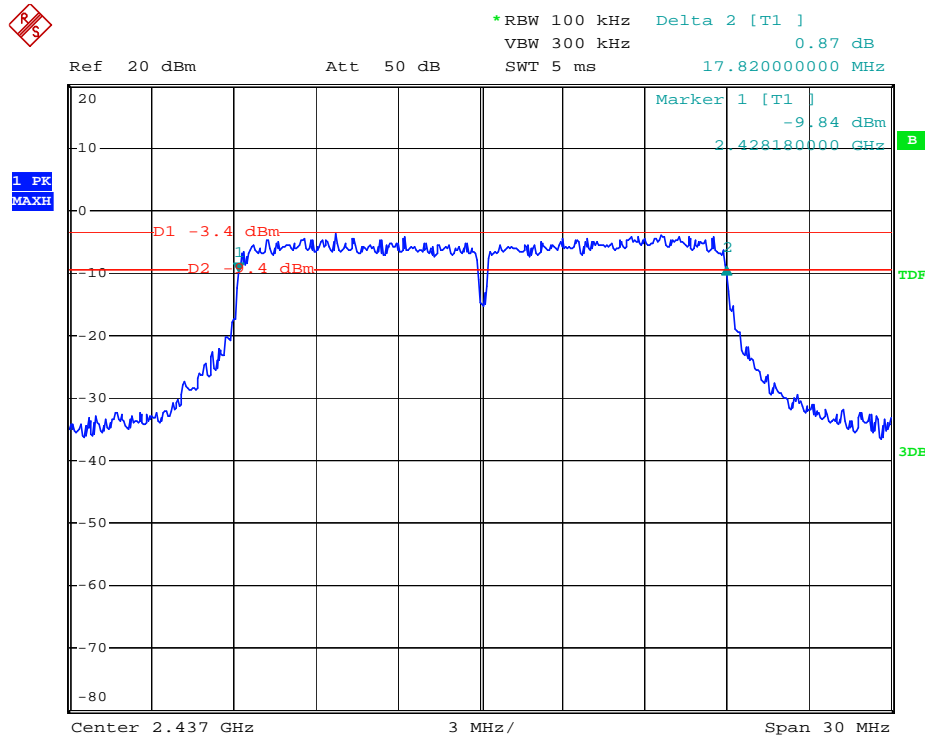



Modulation Standard: 802.11n HT20 (7.2Mbps)
Channel: 11

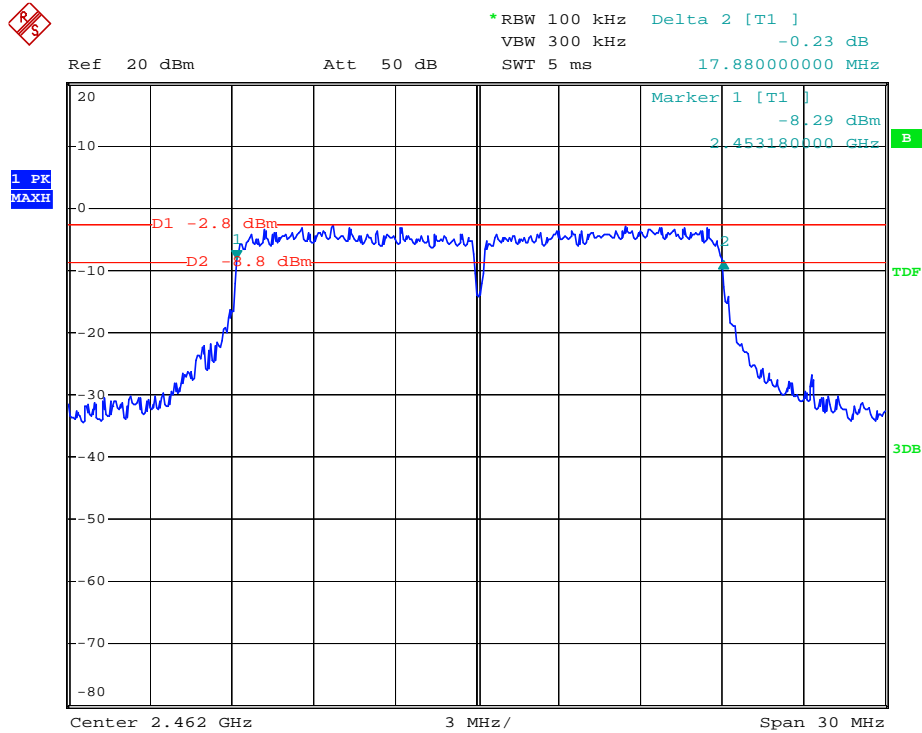

Modulation Standard: 802.11n HT40 (15Mbps)
Channel: 03

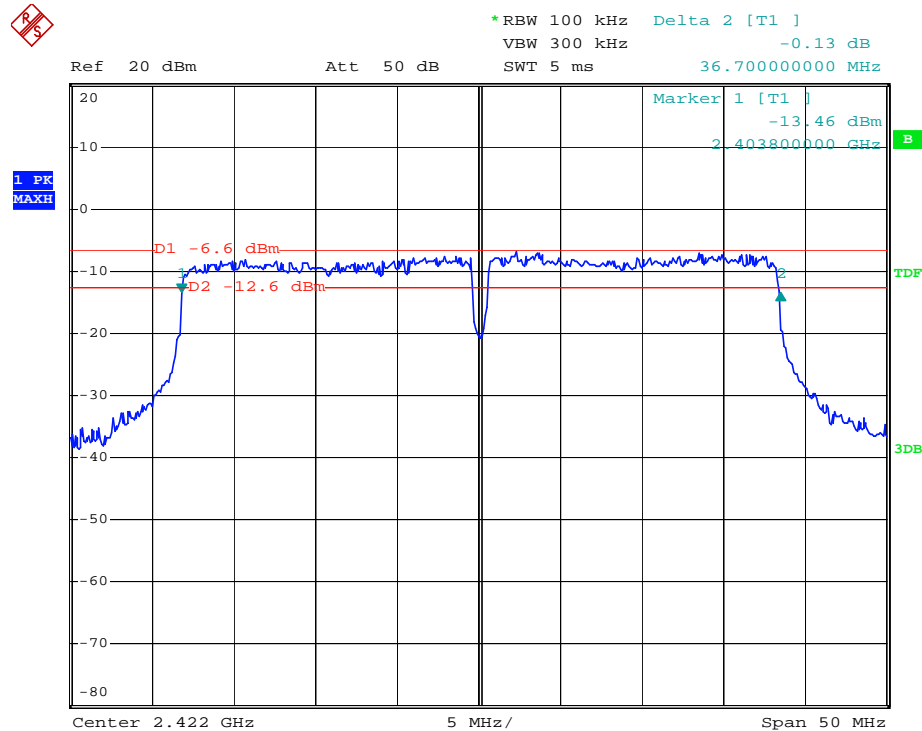



Modulation Standard: 802.11n HT40 (15Mbps)

Channel: 06

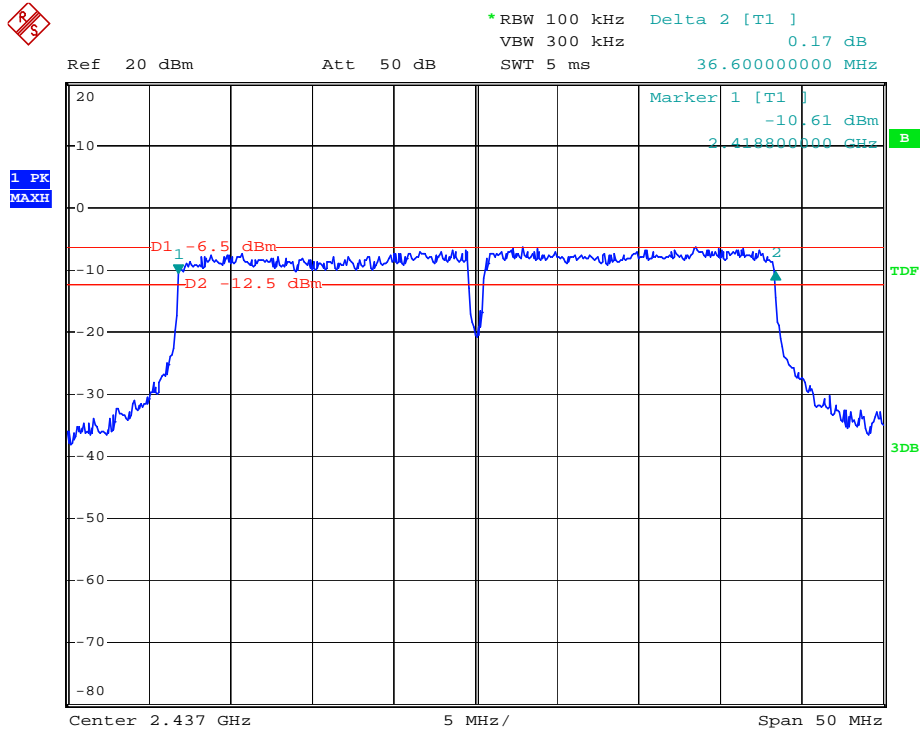

Modulation Standard: 802.11n HT40 (15Mbps)

Channel: 09

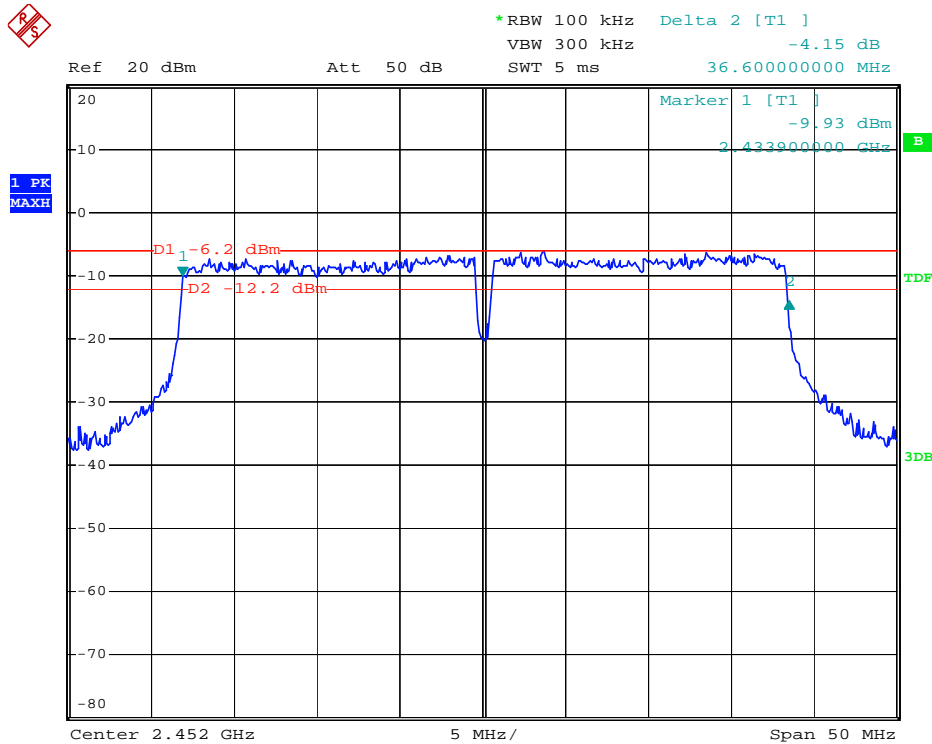



9. Maximum Peak Output Power

9.1 Test Limit

(b)(3) For systems using digital modulation in the 902-928 MHz, 2400-2483.5 MHz, and 5725-5850 MHz bands: 1 Watt.

9.2 Test Procedures

According to FCC/KDB-558074 D01 v04 Measurement using an RF average power meter.

9.3 Test Setup Layout

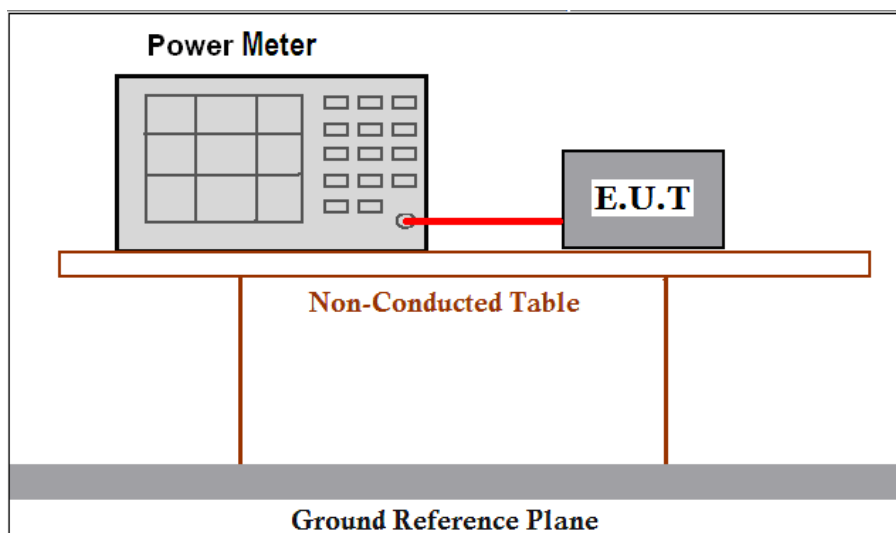



9.4 Test Result and Data

Test Date: Nov. 25, 2017

Temperature: 24°C

Atmospheric pressure: 996 pha

Humidity: 58%

Modulation Standard	Channel	Frequency (MHz)	Peak Power Output (dBm)	Peak Power Output (mW)
802.11b (1Mbps)	01	2412	16.15	41.21
	06	2437	16.35	43.15
	11	2462	16.26	42.27
802.11g (6Mbps)	01	2412	14.74	29.79
	06	2437	14.63	29.04
	11	2462	14.77	29.99

Modulation Standard	Channel	Frequency (MHz)	Peak Power Output (dBm)	Peak Power Output (mW)
802.11n HT20 (7.2Mbps)	01	2412	14.34	27.16
	06	2437	14.28	26.79
	11	2462	14.56	28.58
802.11n HT40 (15Mbps)	03	2422	13.86	24.32
	06	2437	13.57	22.75
	09	2452	13.74	23.66



10. Power Spectral Density

10.1 Test Limit

The Maximum of Power Spectral Density Measurement is 8dBm

10.2 Test Procedures

- a. The transmitter output was connected to spectrum analyzer.
- b. The spectrum analyzer's resolution bandwidth were set at 3KHz RBW and 30KHz VBW as that of the fundamental frequency. Set the sweep time=auto couple.
- c. The power spectral density was measured and recorded.

10.3 Test Setup Layout

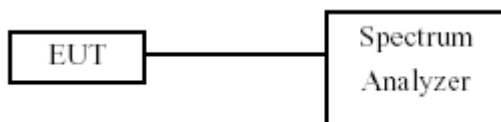



10.4 Test Result and Data

Test Date: Nov. 25, 2017

Temperature: 24°C

Atmospheric pressure: 996 pha

Humidity: 58%

Modulation Standard	Channel	Frequency (MHz)	Measured Power Density (dBm)
802.11b (1Mbps)	01	2412	-19.57
	06	2437	-18.71
	11	2462	-18.29
802.11g (6Mbps)	01	2412	-17.27
	06	2437	-16.87
	11	2462	-15.45

Modulation Standard	Channel	Frequency (MHz)	Measured Power Density (dBm)
802.11n HT20 (7.2Mbps)	01	2412	-17.04
	06	2437	-15.84
	11	2462	-15.67
802.11n HT40 (15Mbps)	03	2422	-18.97
	06	2437	-19.26
	09	2452	-19.18



Modulation Standard: 802.11b (1Mbps)
Channel: 01



*RBW 3 kHz Marker 1 [T1]
VBW 10 kHz -19.57 dBm
SWT 3.4 s 2.412840000 GHz

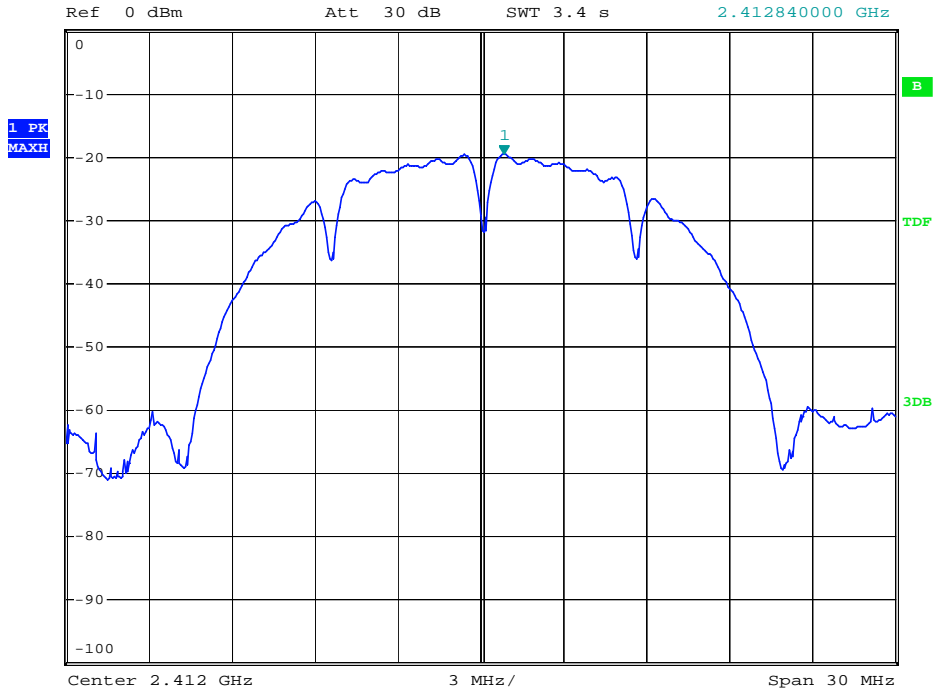

Modulation Standard: 802.11b (1Mbps)
Channel: 06



*RBW 3 kHz Marker 1 [T1]
VBW 10 kHz -18.71 dBm
SWT 3.4 s 2.437780000 GHz

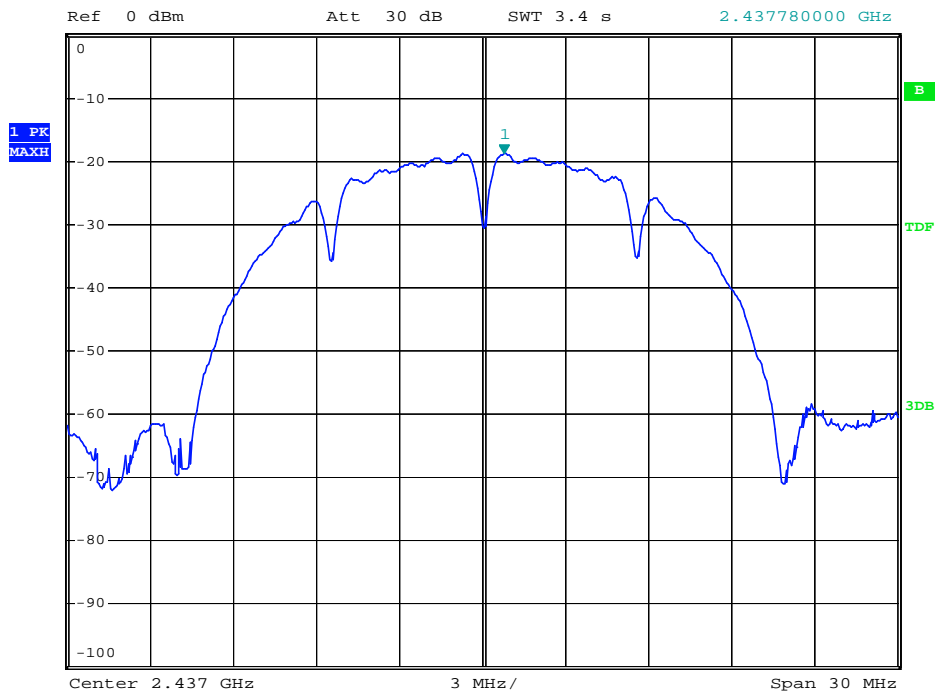



Modulation Standard: 802.11b (1Mbps)
Channel: 11

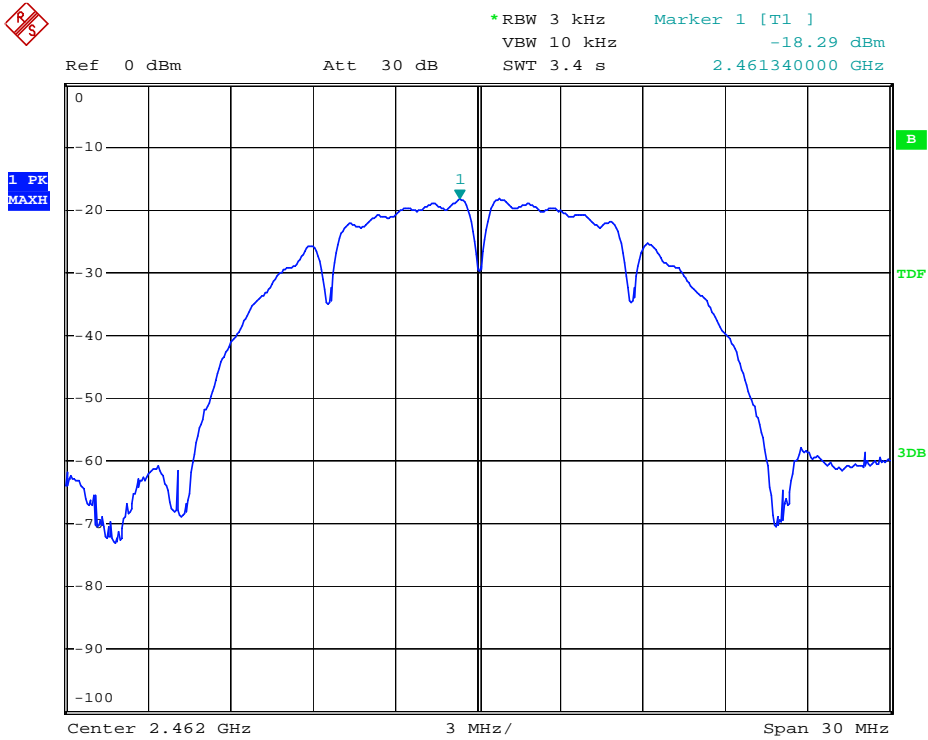

Modulation Standard: 802.11g (6Mbps)
Channel: 01

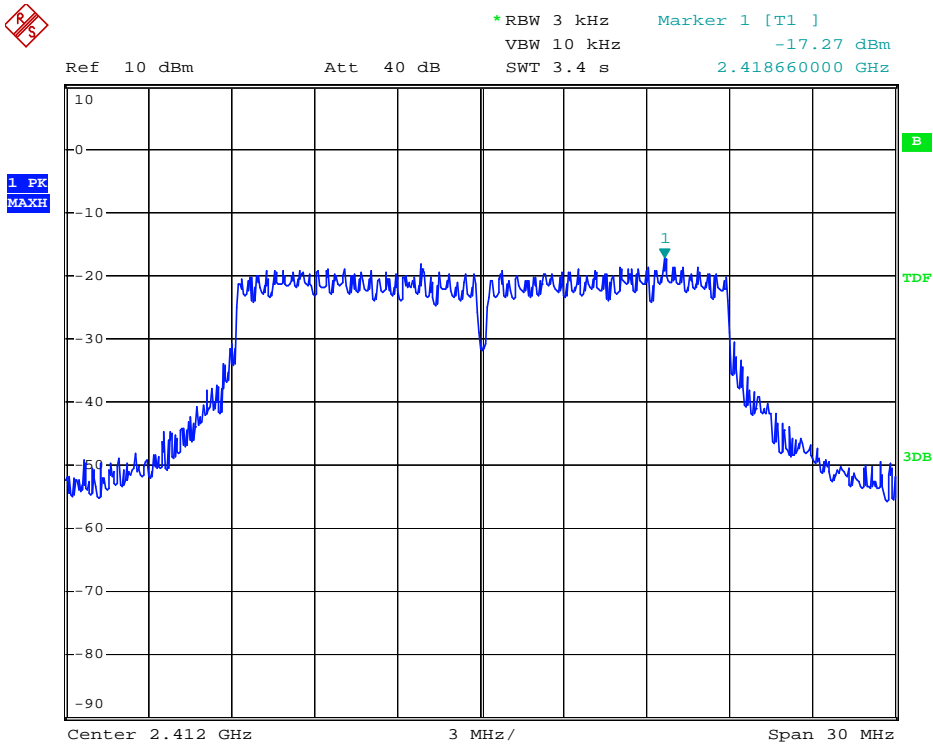



Modulation Standard: 802.11g (6Mbps)

Channel: 06

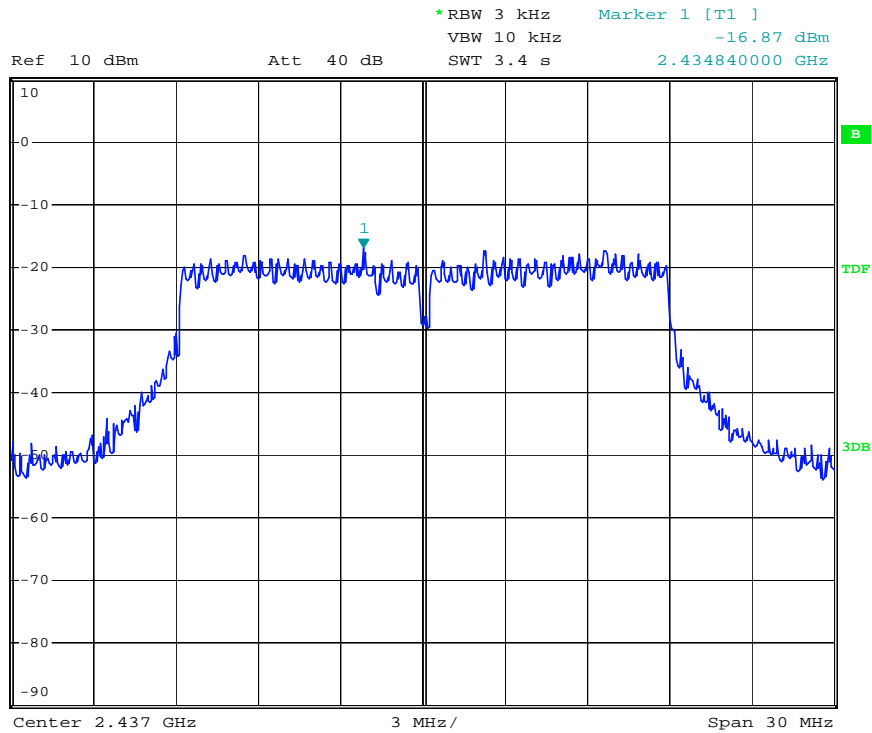

Modulation Standard: 802.11g (6Mbps)

Channel: 11

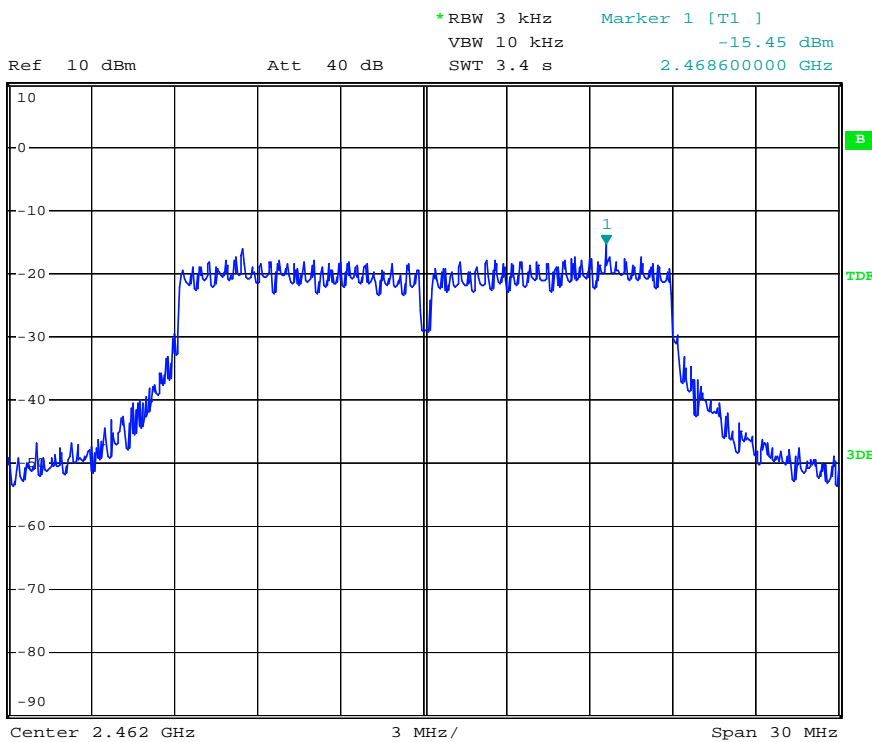



Modulation Standard: 802.11n HT20 (7.2Mbps)
Channel: 01

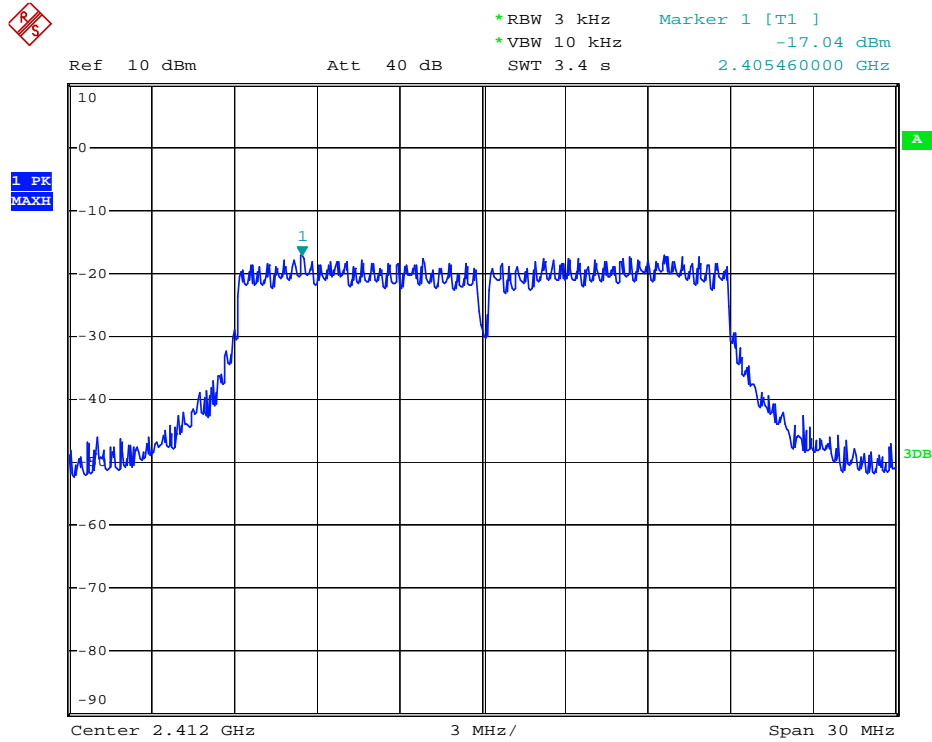

Modulation Standard: 802.11n HT20 (7.2Mbps)
Channel: 06

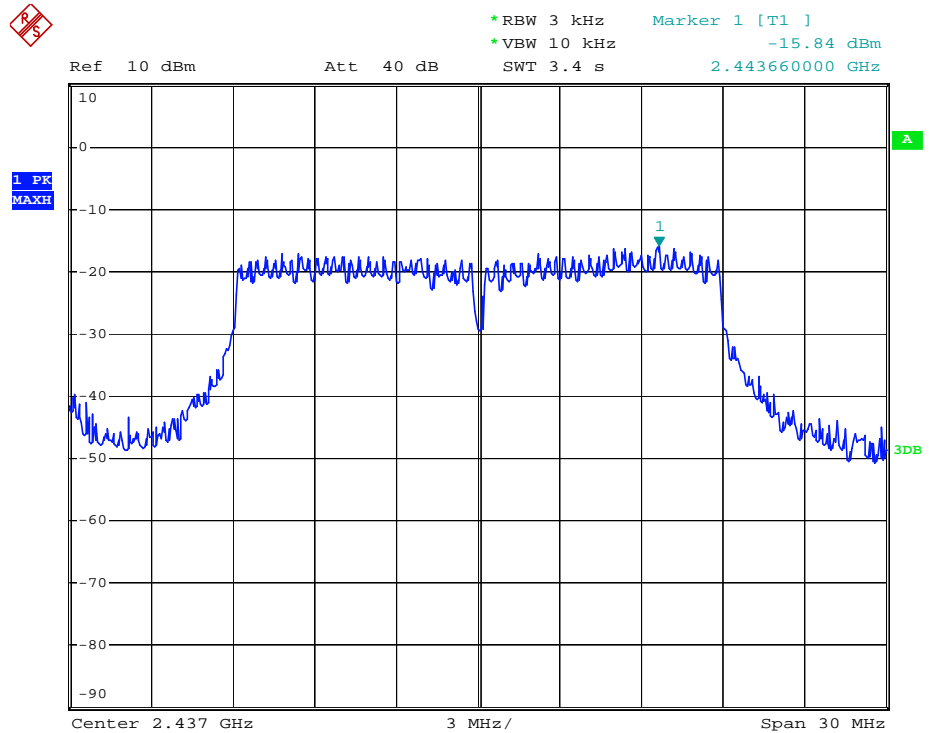



Modulation Standard: 802.11n HT20 (7.2Mbps)

Channel: 11

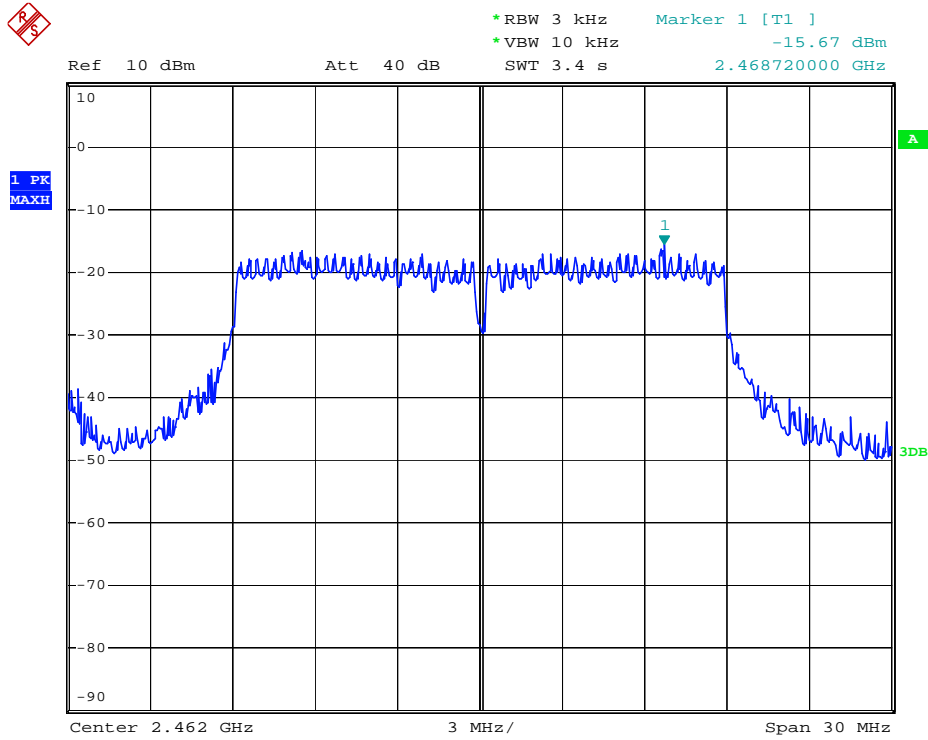

Modulation Standard: 802.11n HT40 (15Mbps)

Channel: 03

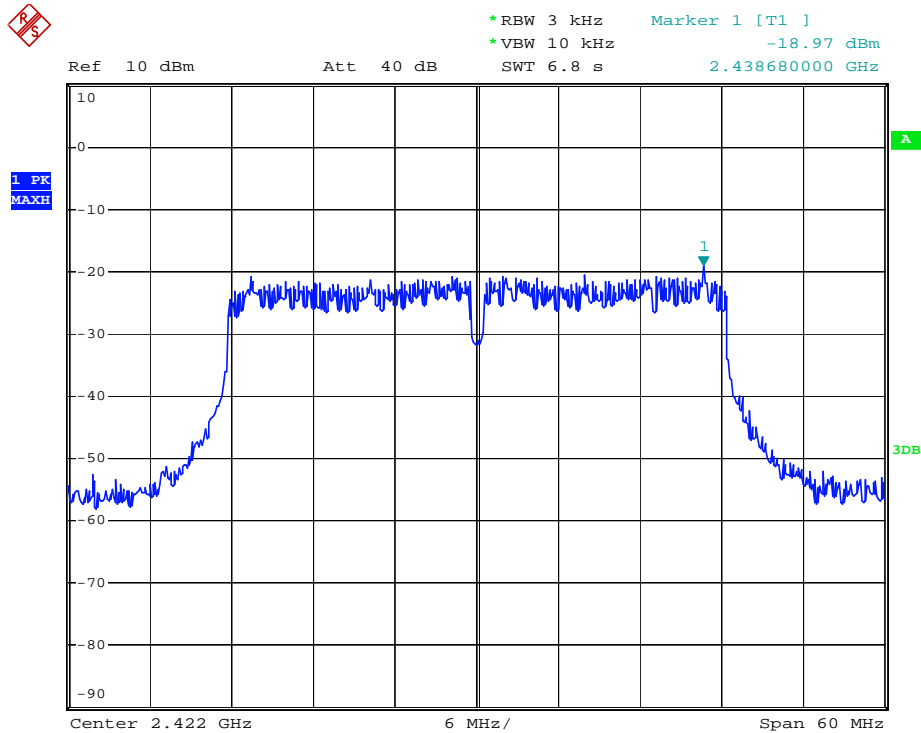



Modulation Standard: 802.11n HT40 (15Mbps)
Channel: 06



Ref 10 dBm Att 40 dB SWT 6.8 s
*RBW 3 kHz *VBW 10 kHz
Marker 1 [T1] -19.26 dBm
2.440480000 GHz

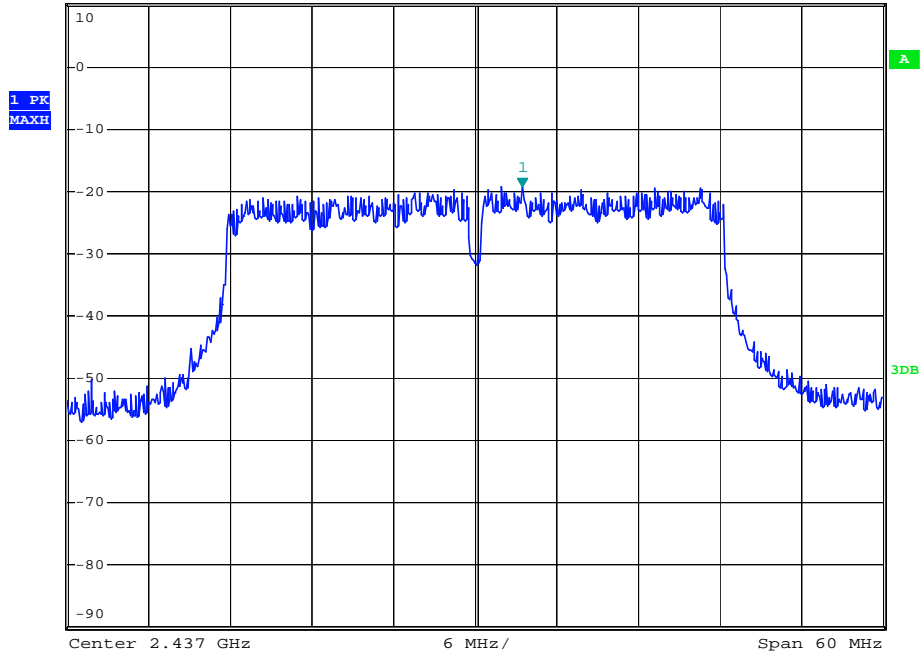

Modulation Standard: 802.11n HT40 (15Mbps)
Channel: 09



Ref 10 dBm Att 40 dB SWT 6.8 s
*RBW 3 kHz *VBW 10 kHz
Marker 1 [T1] -19.18 dBm
2.468680000 GHz

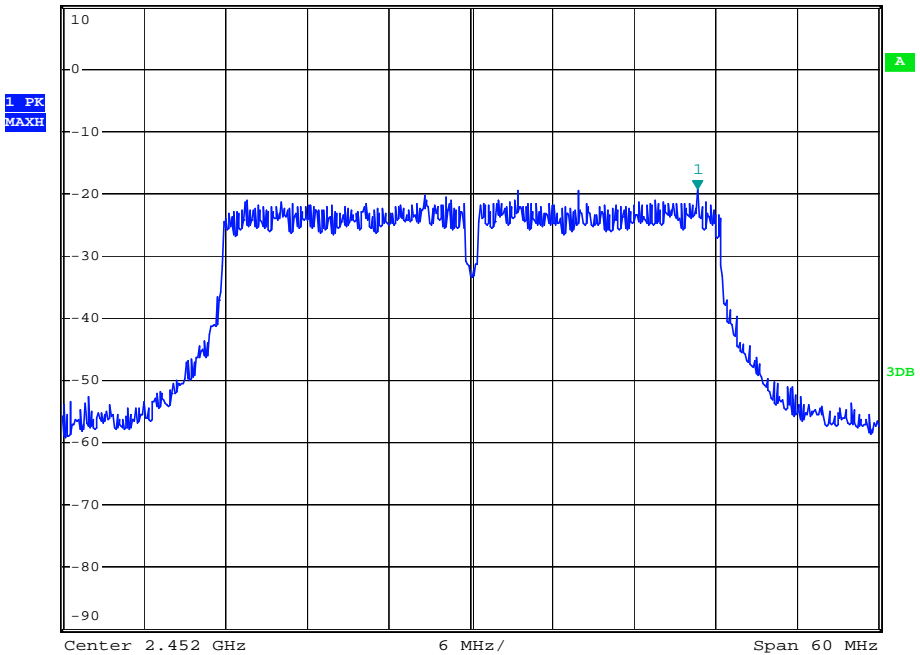



11. Band Edges Measurement

11.1 Test Limit

In any 100 kHz bandwidth outside the frequency band in which the spread spectrum or digitally modulated intentional radiator is operating. The radio frequency power that is produced by the intentional radiator shall be at least 20 dB below that in the 100 kHz bandwidth within the band that contains the highest level of the desired power. Based on either an RF conducted or a radiated measurement. Provided the transmitter demonstrates compliance with the peak conducted power limits.

11.2 Test Procedure

- a. The transmitter output was connected to the spectrum analyzer via a low lose cable.
- b. Set RBW of spectrum analyzer to 100 KHz and VBW of spectrum analyzer to 300 KHz with convenient frequency span including 100 KHz bandwidth from band edge.
- c. Peak conducted output power measured within any 100 kHz outside the authorized frequency band shall be attenuated by at least 20dB relative to the maximum measured in-band peak PSD level.
- d. The band edges was measured and recorded.

11.3 Test Setup Layout

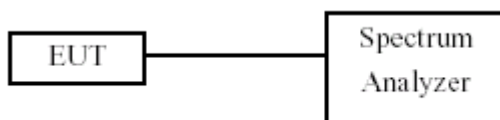



11.4 Test Result and Data

Test Date: Nov. 25, 2017

Temperature: 24°C

Atmospheric pressure: 996 pha

Humidity: 58%

Modulation Standard	Channel	Frequency (MHz)	maximum value in frequency (MHz)	maximum value (dBm)
802.11b (1Mbps)	01	2412	2400.00	-37.55
	11	2462	2483.50	-47.67
802.11g (6Mbps)	01	2412	2400.00	-37.61
	11	2462	2483.50	-39.95
802.11n HT20 (7.2Mbps)	01	2412	2400.00	-36.05
	11	2462	2483.50	-40.59
802.11n HT40 (15Mbps)	03	2422	2400.00	-40.94
	09	2452	2483.50	-39.26



Modulation Standard: 802.11b (1Mbps)
Channel: 01

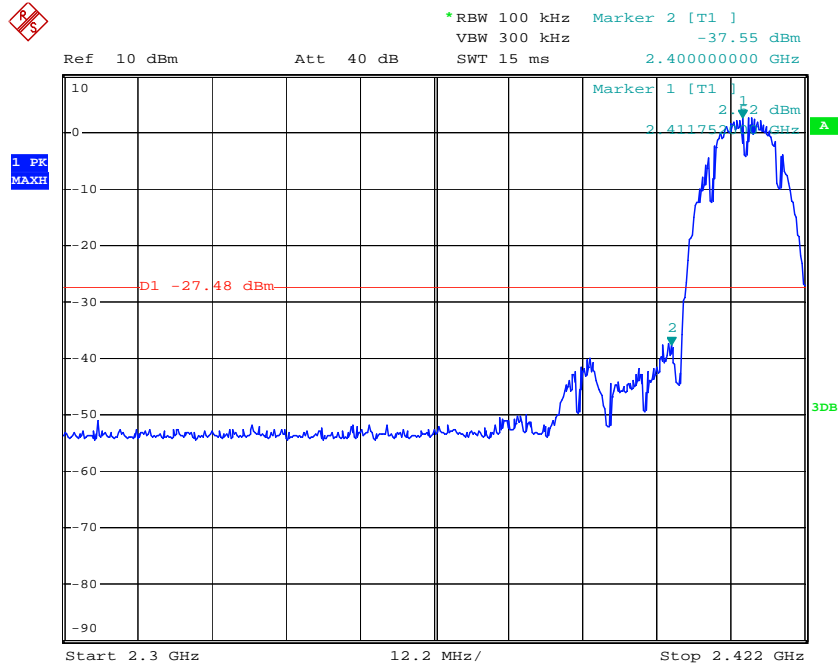

Modulation Standard: 802.11b (1Mbps)
Channel: 11

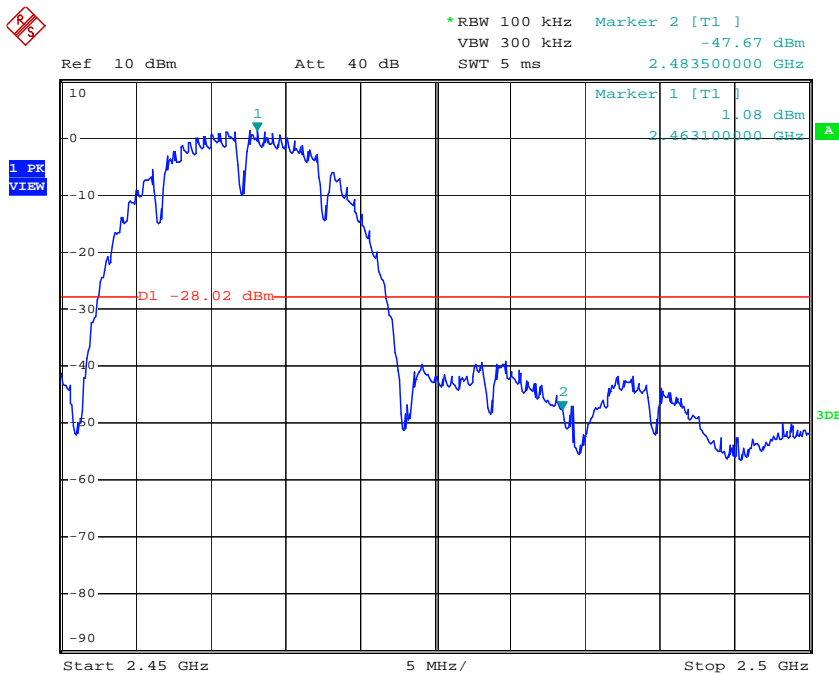



Modulation Standard: 802.11g (6Mbps)

Channel: 1

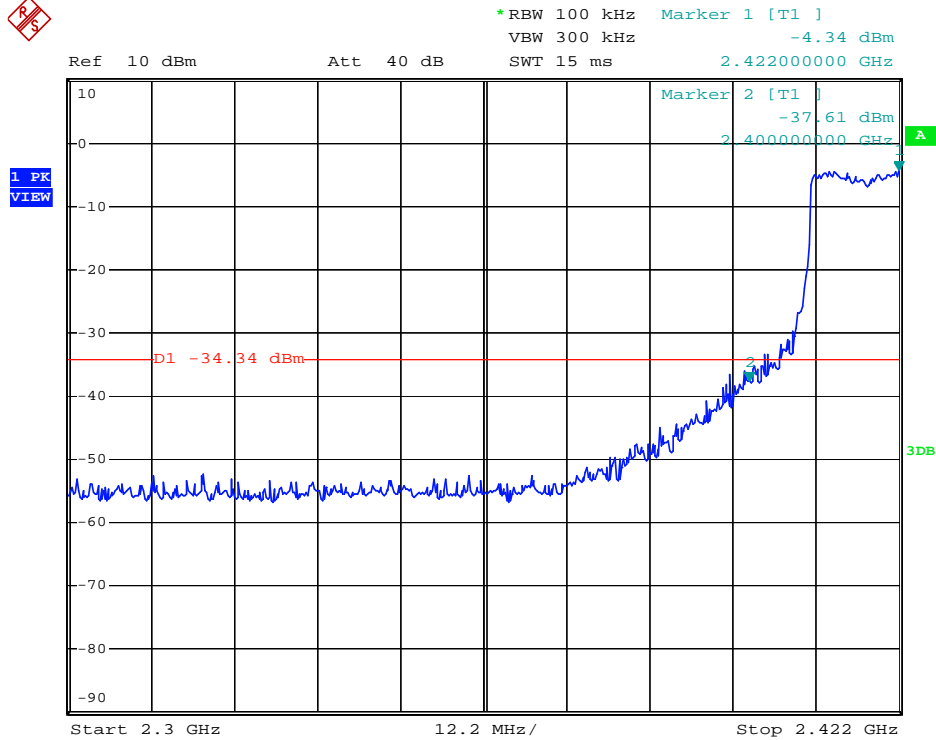

Modulation Standard: 802.11g (6Mbps)

Channel: 11

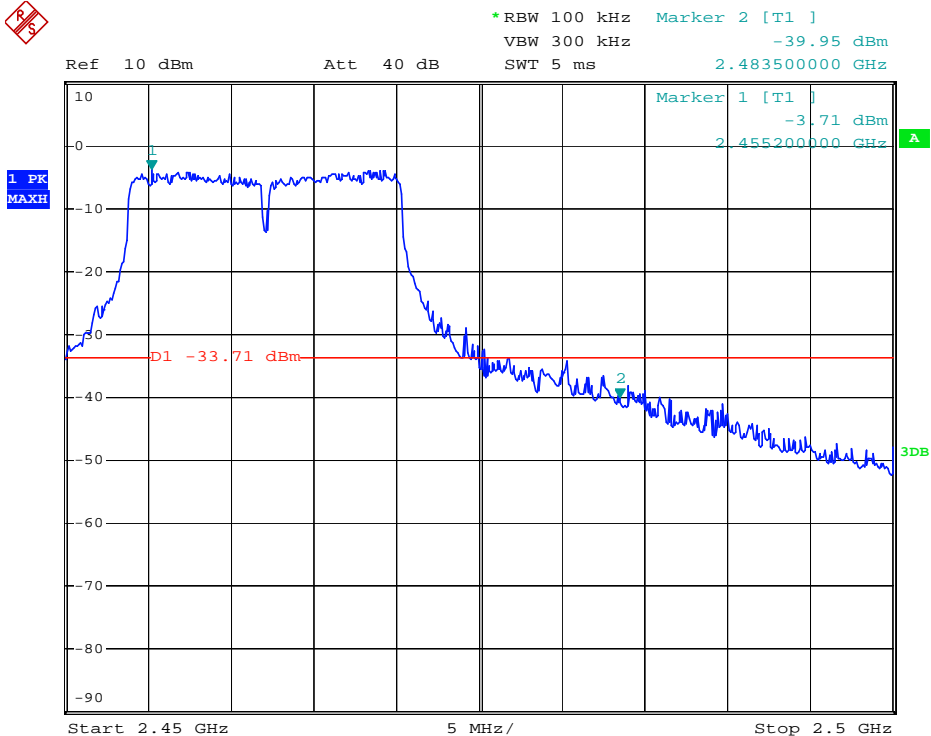



Modulation Standard: 802.11n HT20 (7.2Mbps)
Channel: 01

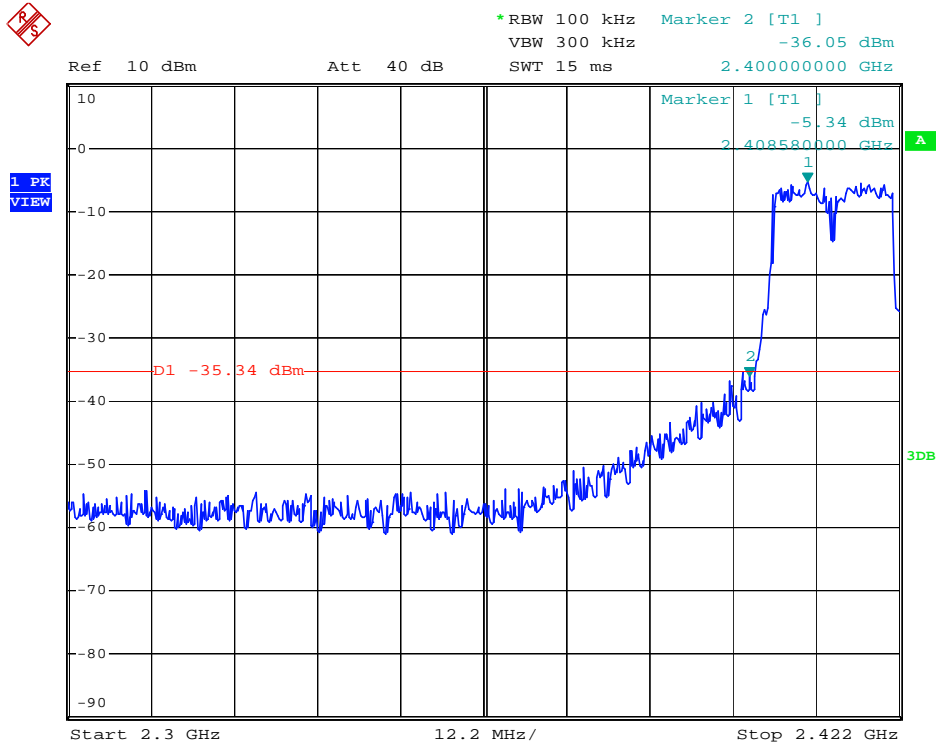

Modulation Standard: 802.11n HT20 (7.2Mbps)
Channel: 11

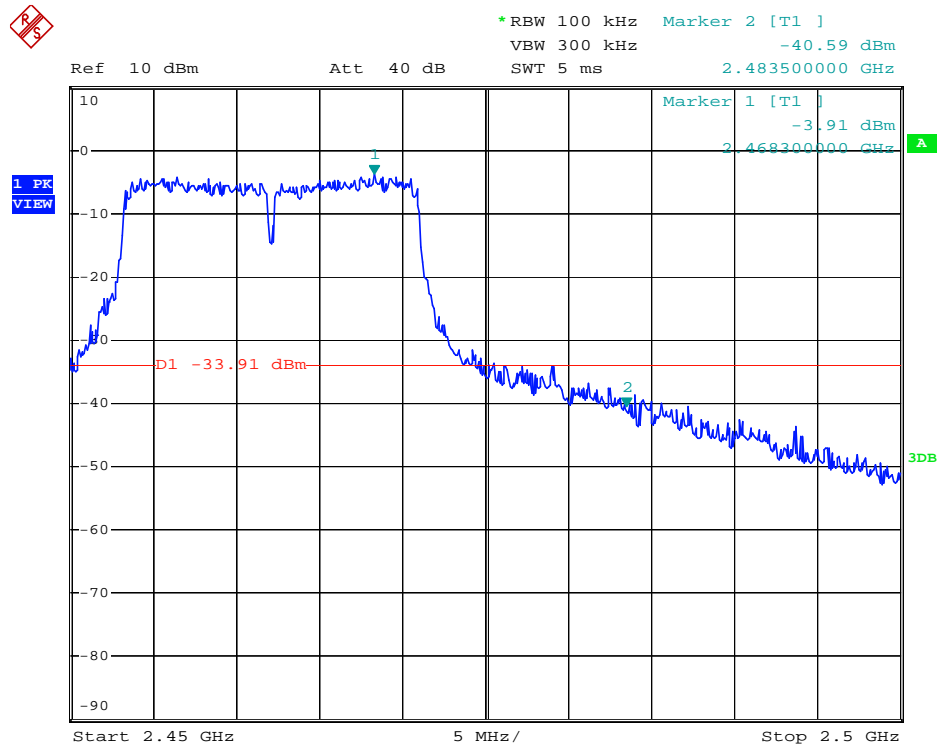



Modulation Standard: 802.11n HT40 (15Mbps)
Channel: 03

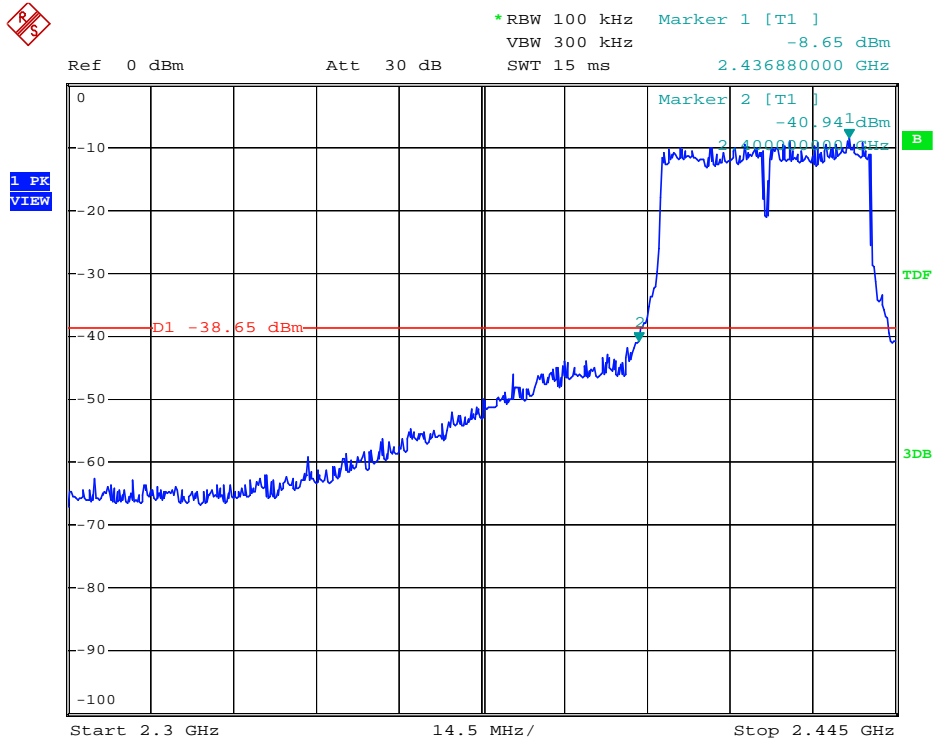

Modulation Standard: 802.11n HT40 (15Mbps)
Channel: 09

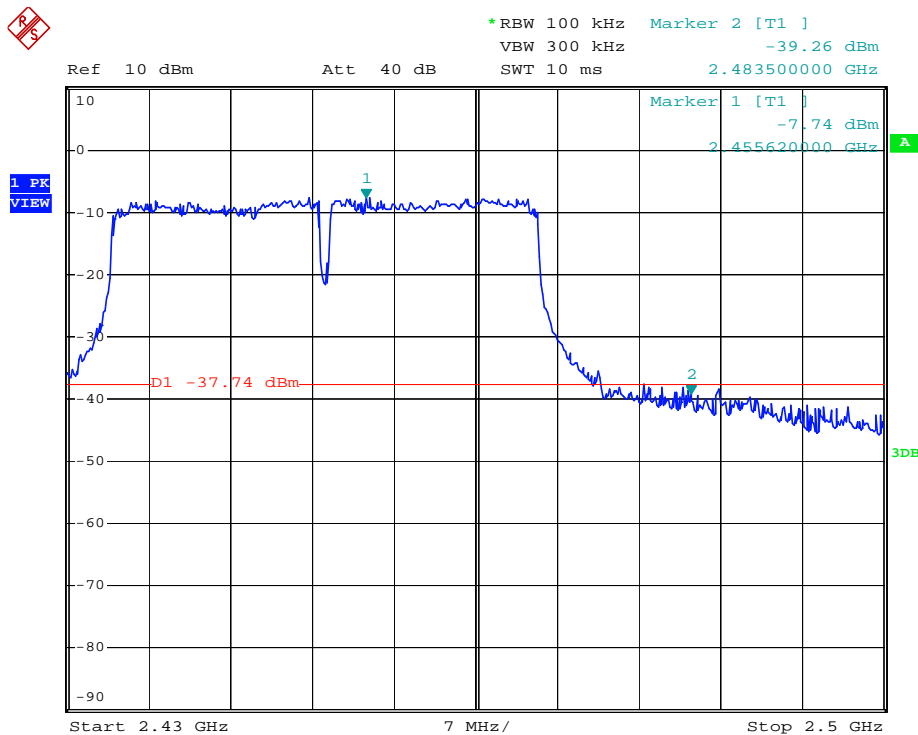



11.5 Restrict Band Emission Measurement Data

Power	: 3.8VDC	Pol/Phase	: H/V
Test Mode 1	: Tx	Temperature	: 26 °C
Memo	:	Humidity	: 55 %

IEEE 802.11b mode with 1Mbps data rate

Channel 1						Fundamental Frequency: 2412 MHz				
Frequency (MHz)	Ant-Pol H/V	Meter Reading (dBuV)	Corrected Factor (dB)	Result (dBuV/m)	Remark	Limit (dBuV/m)		Margin (dB)	Table Deg.	Ant High (m)
						Peak	Ave			
						Peak	Ave			
2390.00	H	54.6	-14.08	40.52	Peak	74	--	-33.48	0	1.5
2390.00	H	44.39	-14.08	30.31	Ave	--	54	-23.69	0	1.5
2351.88	V	53.48	-14.05	39.43	Peak	74	--	-34.57	360	1.5
2351.88	V	43.27	-14.05	29.22	Ave	--	54	-24.78	360	1.5
Channel 11						Fundamental Frequency: 2462 MHz				
Frequency (MHz)	Ant-Pol H/V	Meter Reading (dBuV)	Corrected Factor (dB)	Result (dBuV/m)	Remark	Limit (dBuV/m)		Margin (dB)	Table Deg.	Ant High (m)
						Peak	Ave			
						Peak	Ave			
2483.50	H	53.13	-13.79	39.34	Peak	74	--	-34.66	356	1.5
2483.50	H	42.07	-13.79	28.28	Ave	--	54	-25.72	356	1.5
2493.74	V	51.62	-13.83	37.79	Peak	74	--	-36.21	360	1.5
2493.74	V	41.64	-13.83	27.81	Ave	--	54	-26.19	360	1.5



IEEE 802.11g mode with 6 Mbps data rate

Channel 1						Fundamental Frequency: 2412 MHz				
Frequency (MHz)	Ant-Pol H/V	Meter Reading (dBuV)	Corrected Factor (dB)	Result (dBuV/m)	Remark	Limit (dBuV/m)		Margin (dB)	Table Deg.	Ant High (m)
						Peak	Ave			
2390.00	H	55.45	-14.08	41.37	Peak	74	--	-32.63	0	1.5
2390.00	H	44.73	-14.08	30.65	Ave	--	54	-23.35	0	1.5
2349.53	V	58.2	-14.05	44.15	Peak	74	--	-29.85	360	1.5
2349.53	V	49.45	-14.05	35.4	Ave	--	54	-18.6	360	1.5
Channel 11						Fundamental Frequency: 2462 MHz				
Frequency (MHz)	Ant-Pol H/V	Meter Reading (dBuV)	Corrected Factor (dB)	Result (dBuV/m)	Remark	Limit (dBuV/m)		Margin (dB)	Table Deg.	Ant High (m)
						Peak	Ave			
2483.50	H	56.85	-13.79	43.06	Peak	74	--	-30.94	0	1.5
2483.50	H	44.25	-13.79	30.46	Ave	--	54	-23.54	0	1.5
2496.23	V	52.47	-13.83	38.64	Peak	74	--	-35.36	2	1.5
2496.23	V	41.98	-13.83	28.15	Ave	--	54	-25.85	2	1.5

IEEE 802.11n HT20 mode with 7.2Mbps data rate

Channel 1						Fundamental Frequency: 2412 MHz				
Frequency (MHz)	Ant-Pol H/V	Meter Reading (dBuV)	Corrected Factor (dB)	Result (dBuV/m)	Remark	Limit (dBuV/m)		Margin (dB)	Table Deg.	Ant High (m)
						Peak	Ave			
2390.00	H	55.45	-14.08	41.37	Peak	74	--	-32.63	0	1.5
2390.00	H	44.73	-14.08	30.65	Ave	--	54	-23.35	0	1.5
2387.61	V	58.2	-14.03	44.17	Peak	74	--	-29.83	360	1.5
2387.61	V	49.45	-14.03	35.42	Ave	--	54	-18.58	360	1.5
Channel 11						Fundamental Frequency: 2462 MHz				
Frequency (MHz)	Ant-Pol H/V	Meter Reading (dBuV)	Corrected Factor (dB)	Result (dBuV/m)	Remark	Limit (dBuV/m)		Margin (dB)	Table Deg.	Ant High (m)
						Peak	Ave			
2483.50	H	54.47	-13.79	40.68	Peak	74	--	-33.32	3	1.5
2483.50	H	45.79	-13.79	32.0	Ave	--	54	-22.0	3	1.5
2493.43	V	53.8	-13.83	39.97	Peak	74	--	-34.03	360	1.5
2493.43	V	42.49	-13.83	28.66	Ave	--	54	-25.34	360	1.5



IEEE 802.11n HT40 mode with 15Mbps data rate

Channel 3						Fundamental Frequency: 2422 MHz				
Frequency (MHz)	Ant-Pol H/V	Meter Reading (dBuV)	Corrected Factor (dB)	Result (dBuV/m)	Remark	Limit (dBuV/m)		Margin (dB)	Table Deg.	Ant High (m)
						Peak	Ave			
2390.00	V	57.63	-14.08	43.55	Peak	74	--	-30.45	0	1.5
2390.00	V	45.58	-14.08	31.5	Ave	--	54	-22.5	0	1.5
2335.03	H	58.54	-14.16	44.38	Peak	74	--	-29.62	360	1.5
2335.03	H	53.17	-14.16	39.01	Ave	--	54	-14.99	360	1.5
Channel 9						Fundamental Frequency: 2452 MHz				
Frequency (MHz)	Ant-Pol H/V	Meter Reading (dBuV)	Corrected Factor (dB)	Result (dBuV/m)	Remark	Limit (dBuV/m)		Margin (dB)	Table Deg.	Ant High (m)
						Peak	Ave			
2483.50	V	55.32	-13.79	41.53	Peak	74	--	-32.47	5	1.5
2483.50	V	47.97	-13.79	34.18	Ave	--	54	-19.82	5	1.5
2493.68	H	54.65	-13.83	40.82	Peak	74	--	-33.18	360	1.5
2493.68	H	42.83	-13.83	29	Ave	--	54	-25	360	1.5

Note:

1. Result = Reading + Correction factor
2. Correction factor : Antenna factor, Cable loss, Pre-Amp, etc.
3. All emissions as described above were determining by rotating the EUT through three orthogonal axes to maximizing the emissions if the EUT belongs to hand-held or body-worn devices.
4. Measurements above 1000 MHz, Peak detector setting:
1 MHz RBW with 1 MHz VBW (Peak Detector).
5. Measurements above 1000 MHz, Average detector setting:
1 MHz RBW with 10Hz VBW (RMS Detector).
6. Peak detector measurement data will represent the worst case results.
7. Where limits are specified for both average and peak detector functions, if the peak measured value complies with the average limit, it is unnecessary to perform an average measurement.



12. Conducted Spurious Emission

12.1 Test Limit

In any 100 kHz bandwidth outside the frequency band in which the spread spectrum or digitally modulated intentional radiator is operating, the radio frequency power that is produced by the intentional radiator shall be at least 20 dB below that in the 100 kHz bandwidth within the band that contains the highest level of the desired power. Based on either an RF conducted or a radiated measurement. Provided the transmitter demonstrates compliance with the peak conducted power limits.

12.2 Test Procedure

1. Remove the antenna from the EUT and then connect a low RF cable from the antenna port to the spectrum analyzer or power meter.
2. Set the spectrum analyzer: RBW=100 KHz, VBW = 300KHz. Sweep = auto; Detector Function = Peak. Trace = Max Hold, Scan up through 10th harmonic.
3. Measure the Conducted Spurious Emissions of the test frequency with special test status.
4. Repeat until all the test status is investigated.

Report the worse case.

12.3 Test Setup Layout

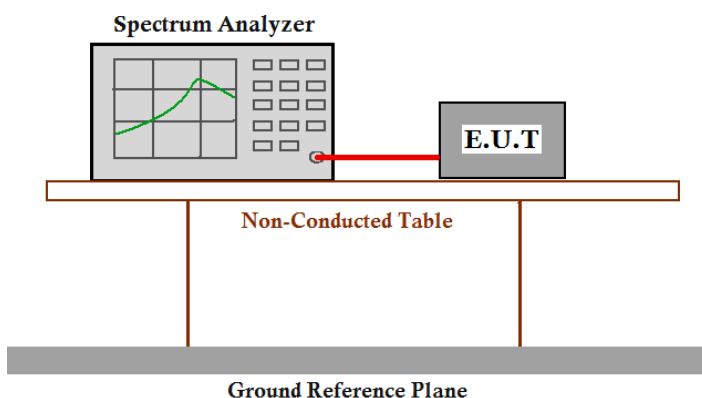

12.4 Test Result:



802.11b mode with 1Mbps data rate

Channel 1: 2.412GHz:

30 MHz to 1 GHz

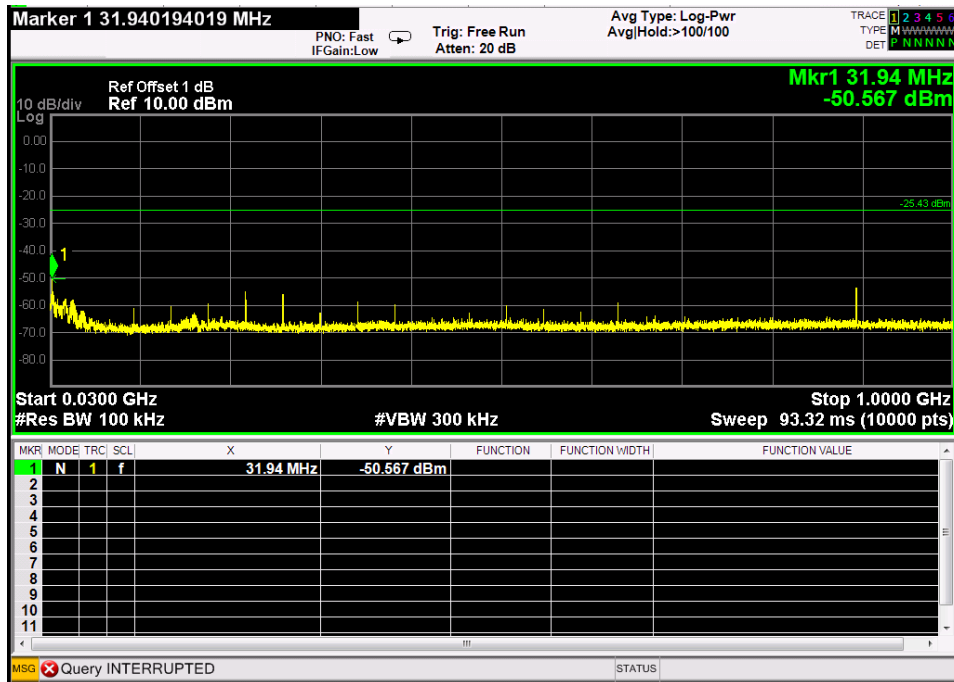

1GHz to 26.5 GHz

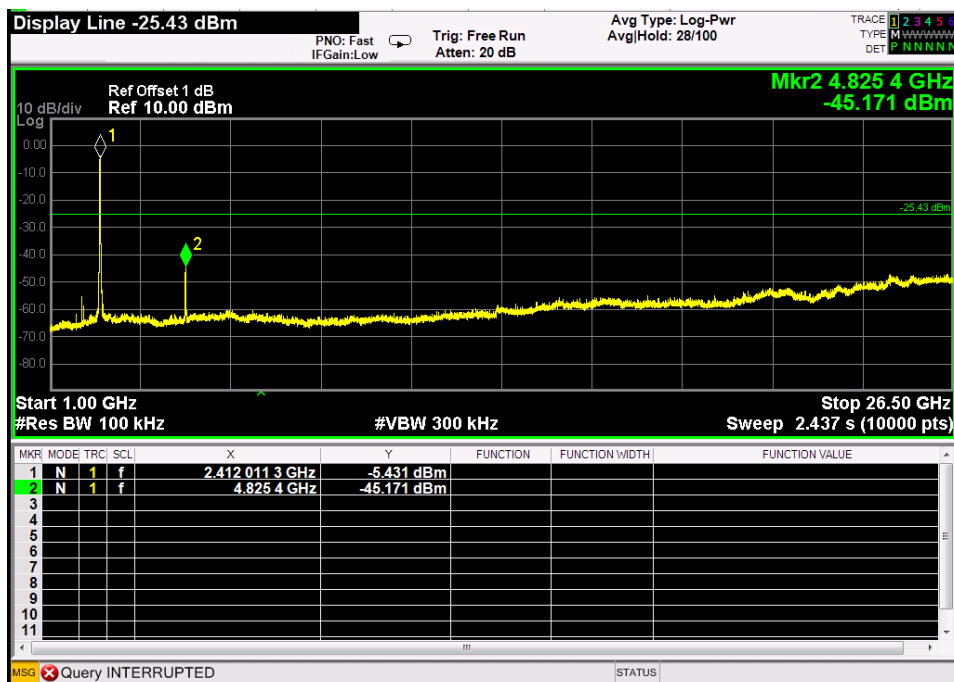



Channel 6: 2.437GHz:

30 MHz to 1 GHz

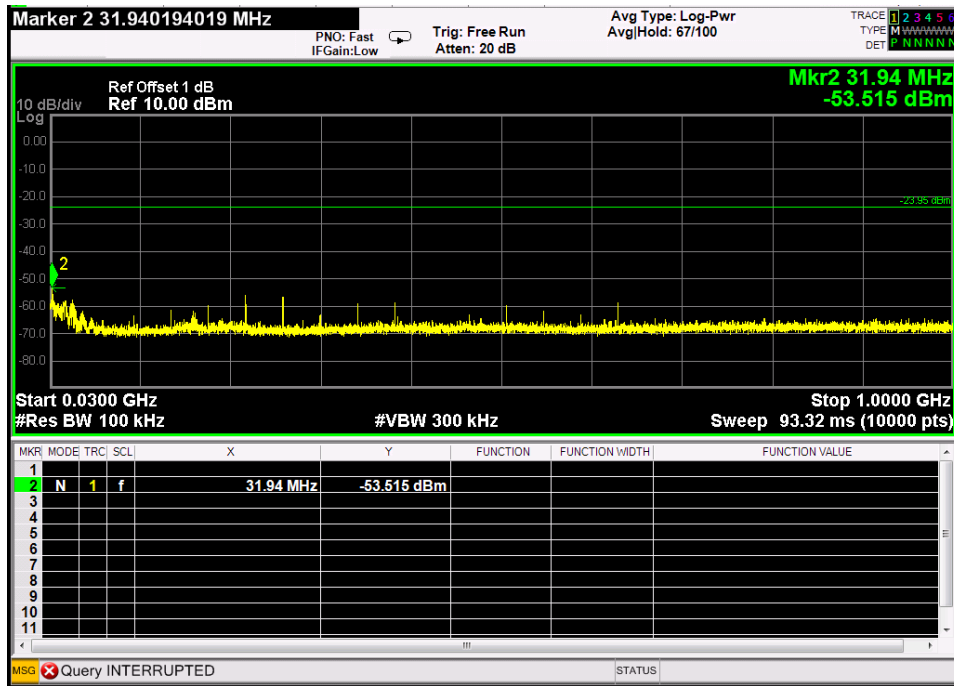

1GHz to 26.5 GHz

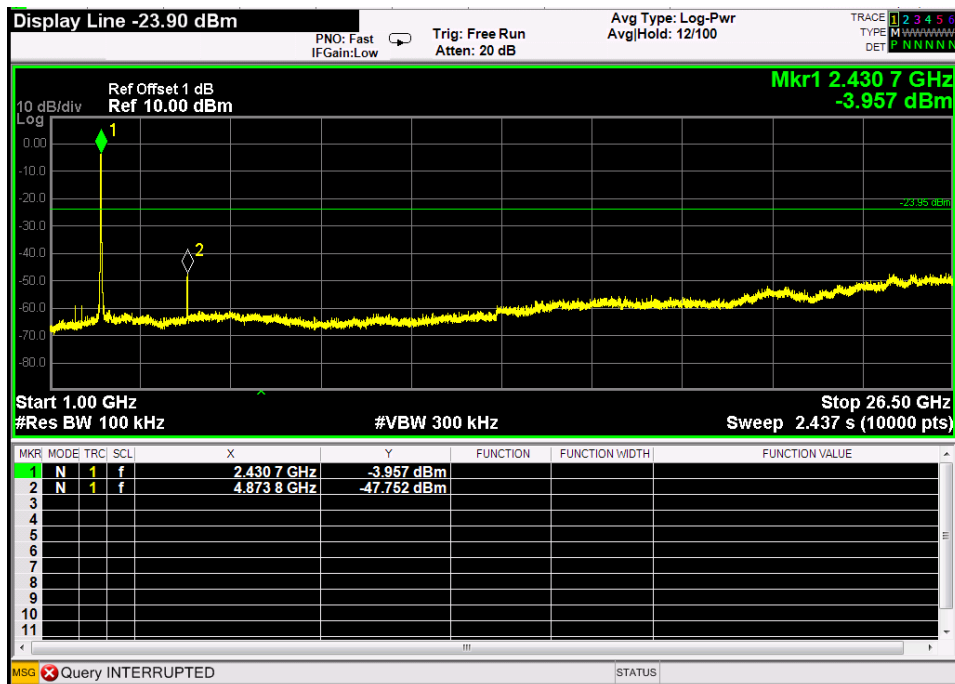



Channel 11:2.462 GHz

30 MHz to 1 GHz

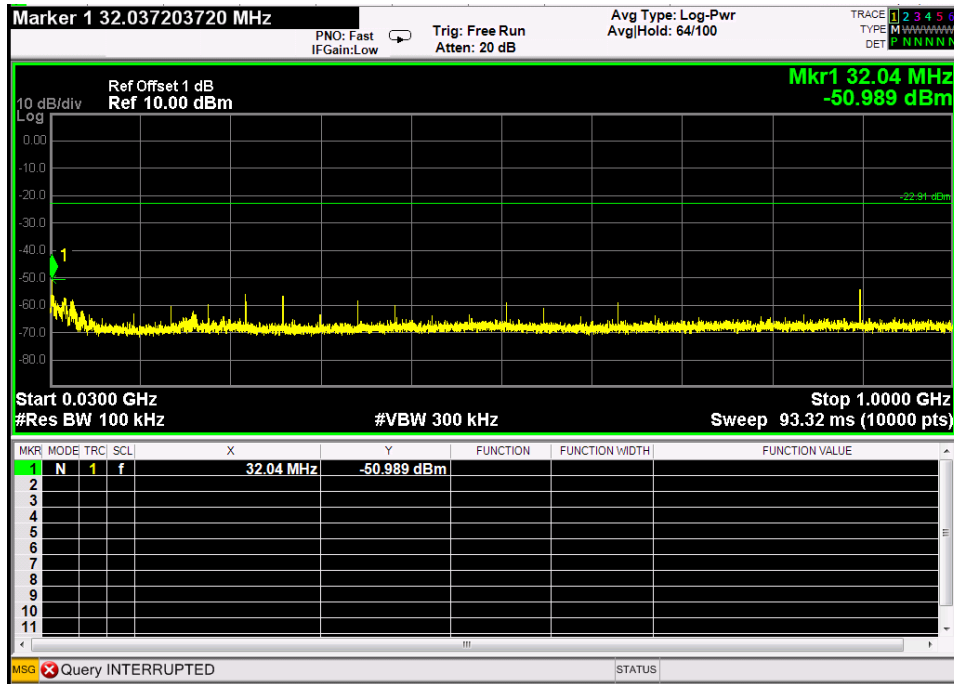

1GHz to 26.5 GHz

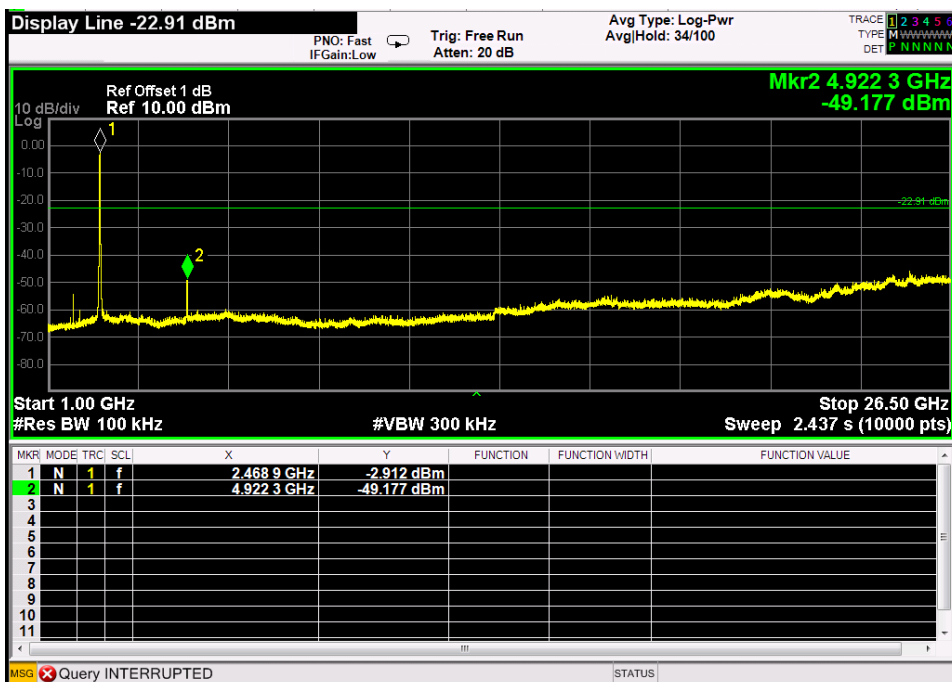



802.11g mode with 6Mbps data rate

Channel 1: 2.412GHz:

30 MHz to 1 GHz

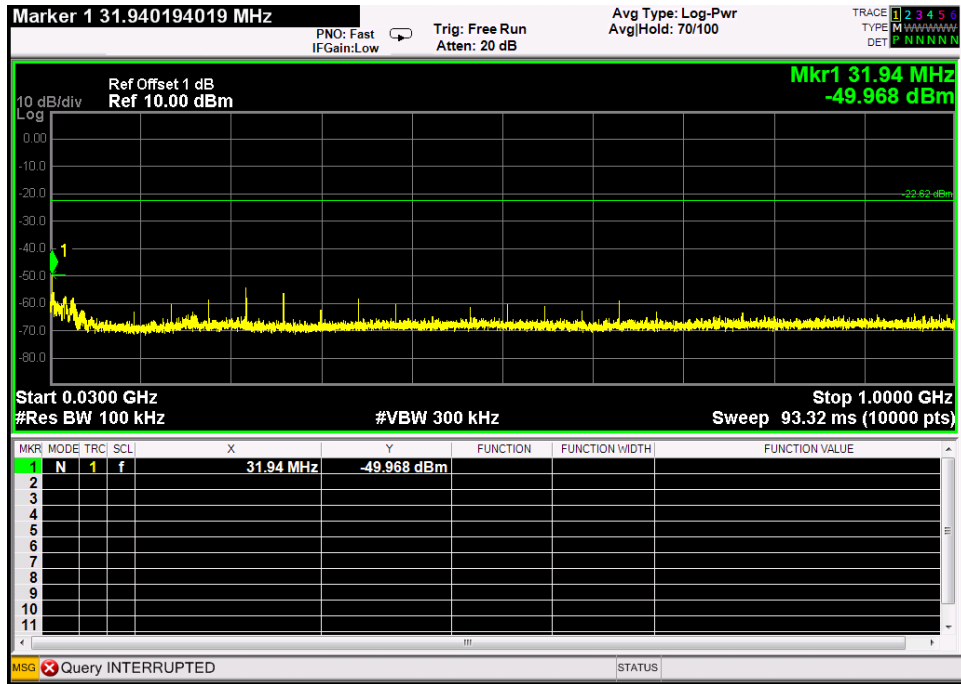

1GHz to 26.5 GHz





Channel 6: 2.437GHz:

30 MHz to 1 GHz

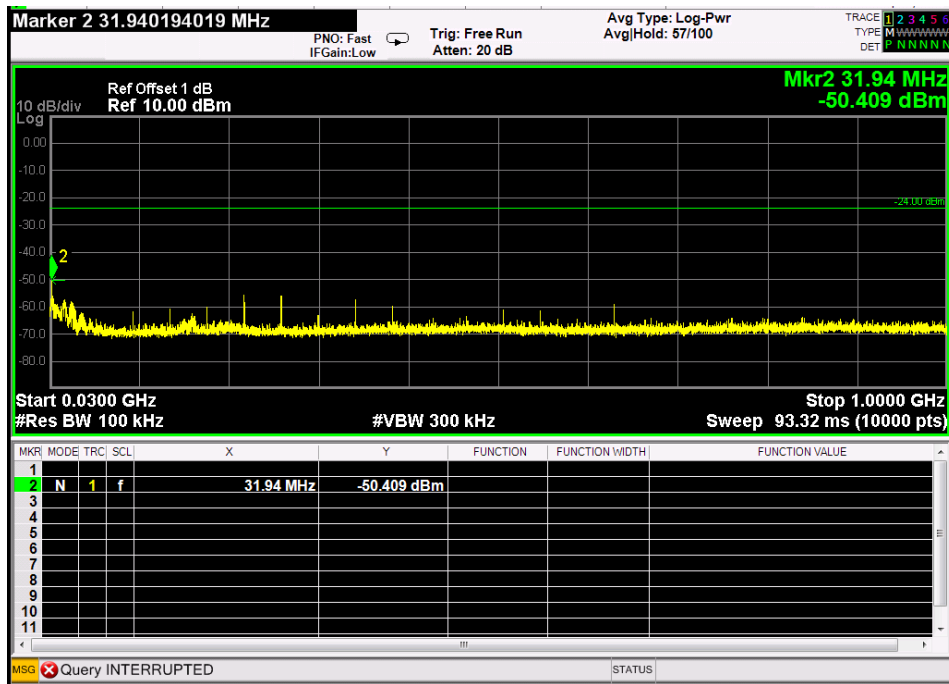

1GHz to 26.5 GHz

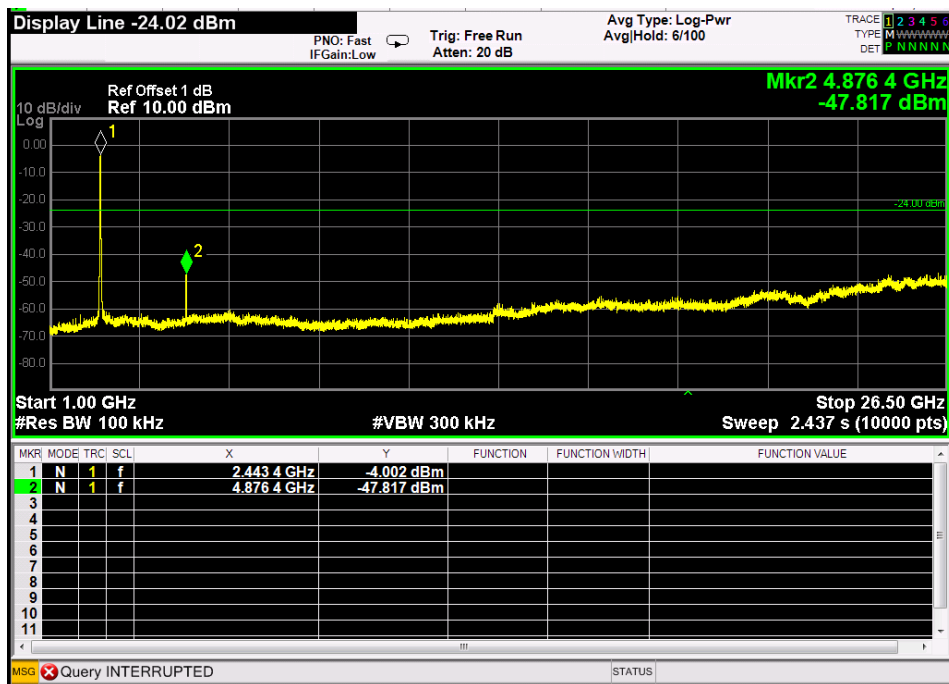



Channel 11:2.462 GHz

30 MHz to 1 GHz

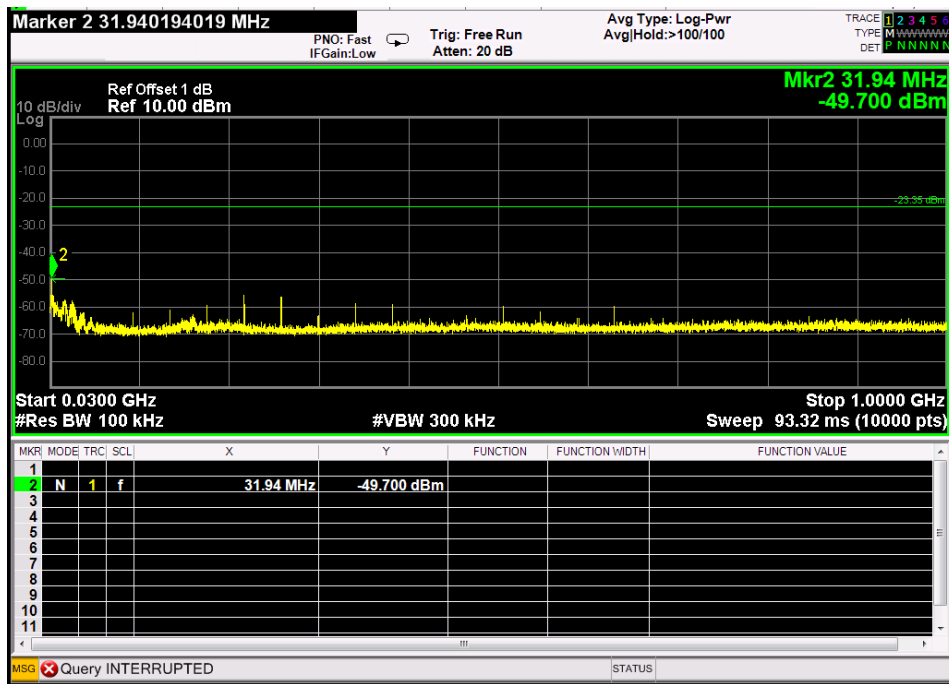

1GHz to 26.5 GHz

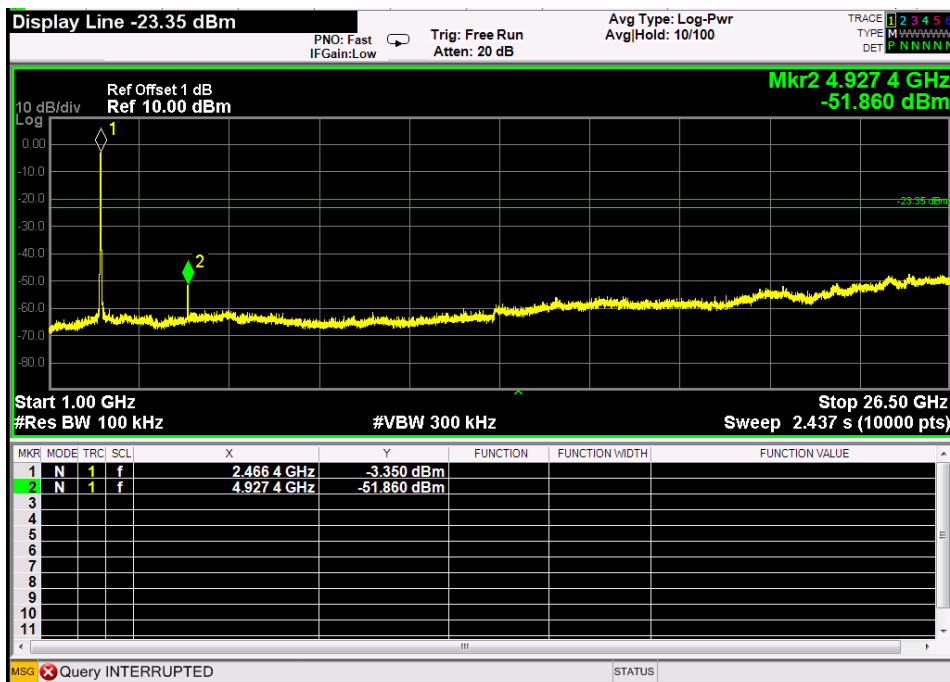



802.11n(HT20) mode with 7.2Mbps data rate

Channel 1: 2.412GHz:

30 MHz to 1 GHz

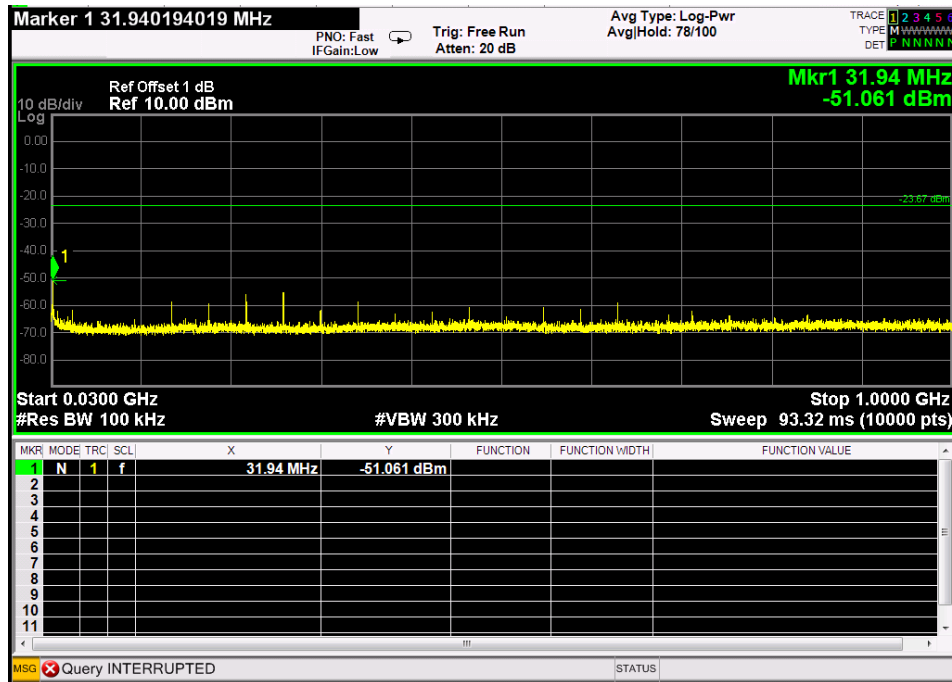

1GHz to 26.5 GHz

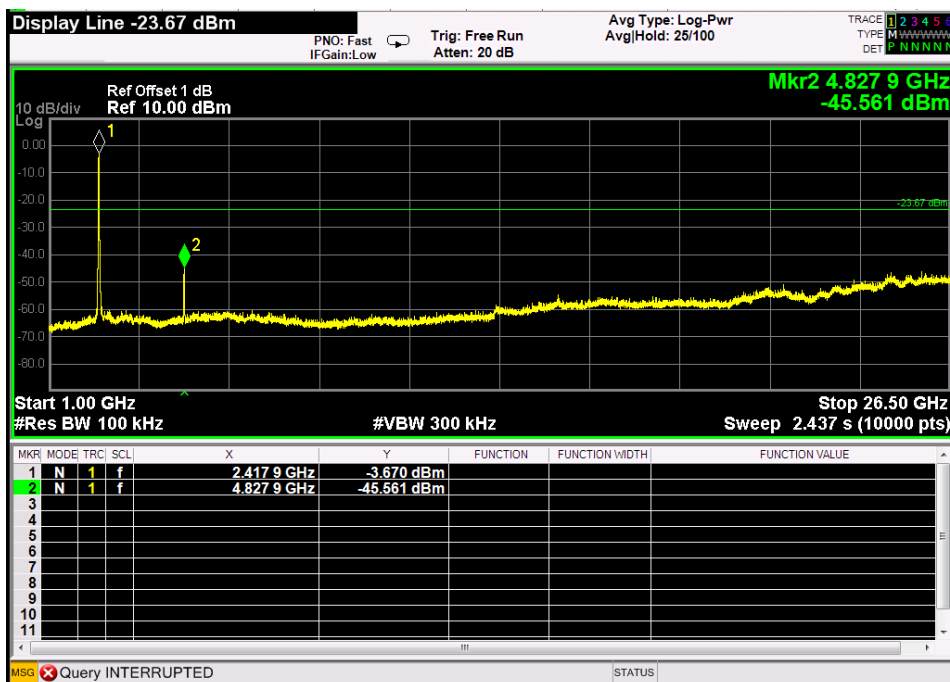



Channel 6: 2.437GHz:

30 MHz to 1 GHz

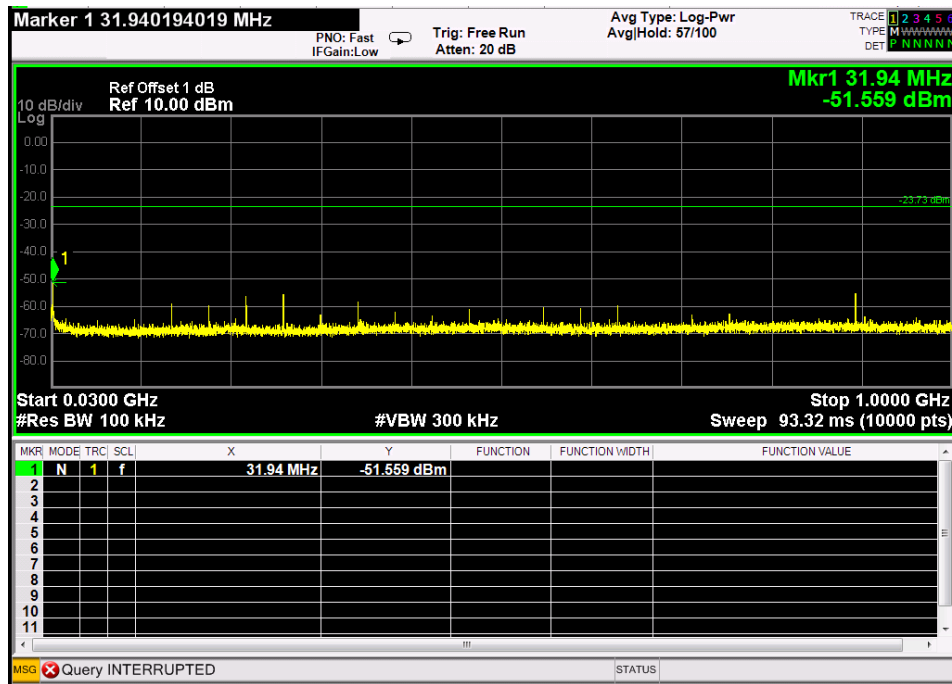

1GHz to 26.5 GHz

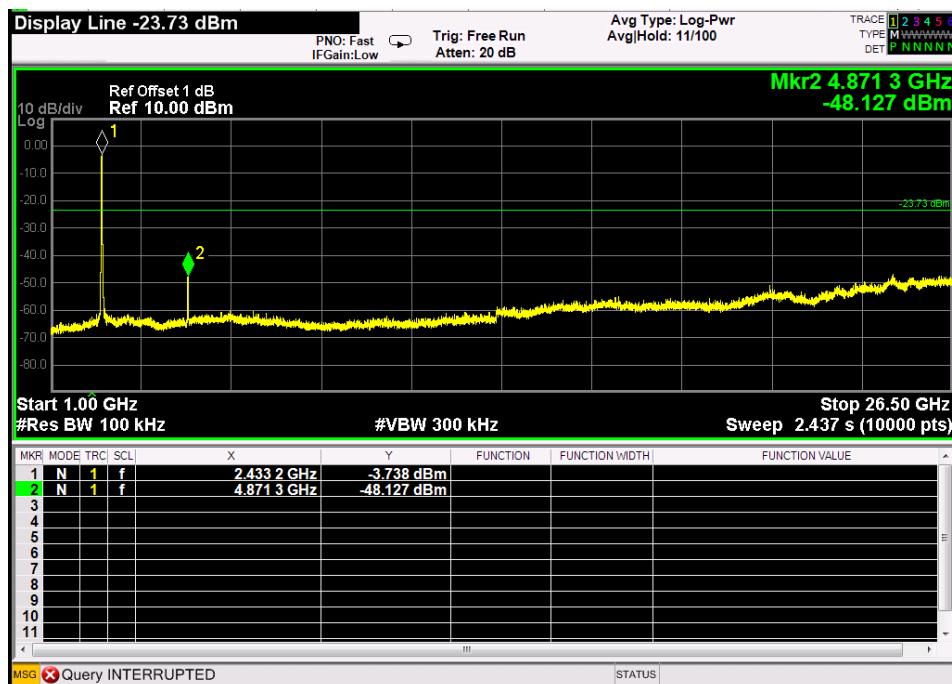



Channel 11:2.462 GHz

30 MHz to 1 GHz

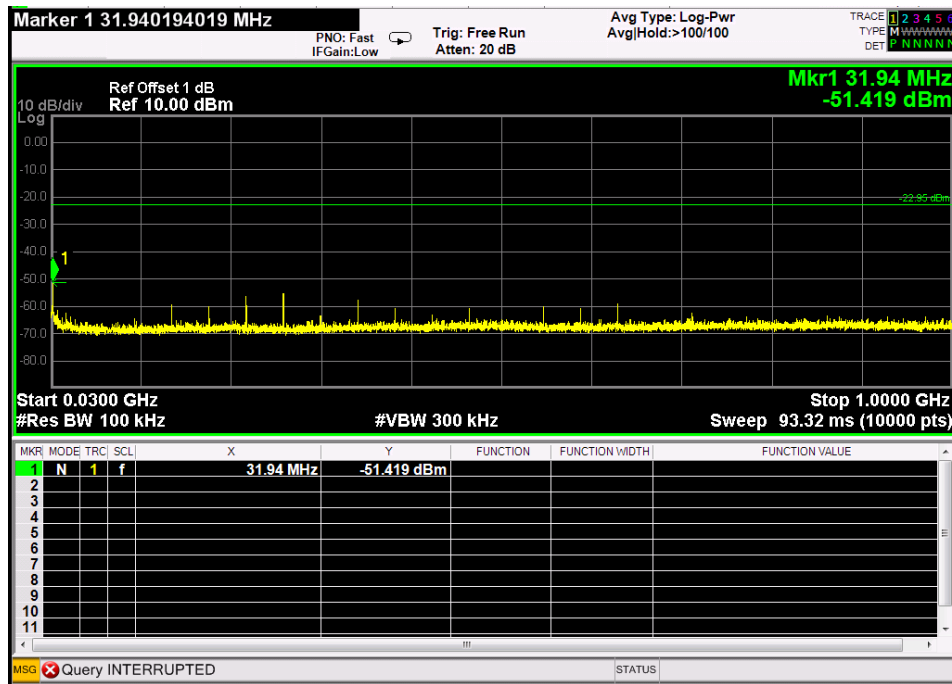

1GHz to 26.5 GHz

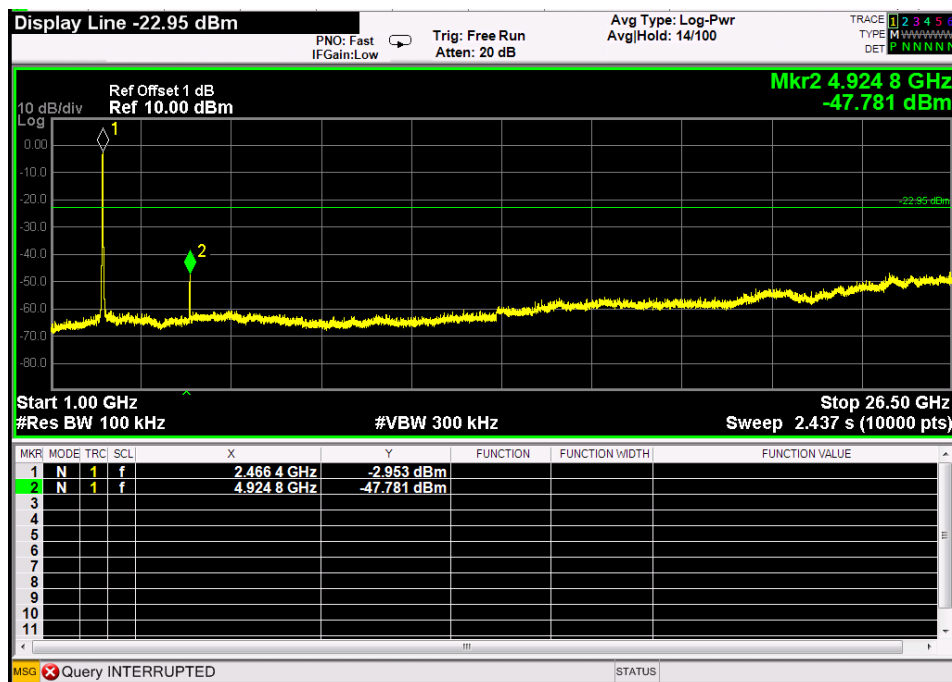



802.11n(HT40) mode with 15Mbps data rate

Channel 3: 2.422GHz:

30 MHz to 1 GHz

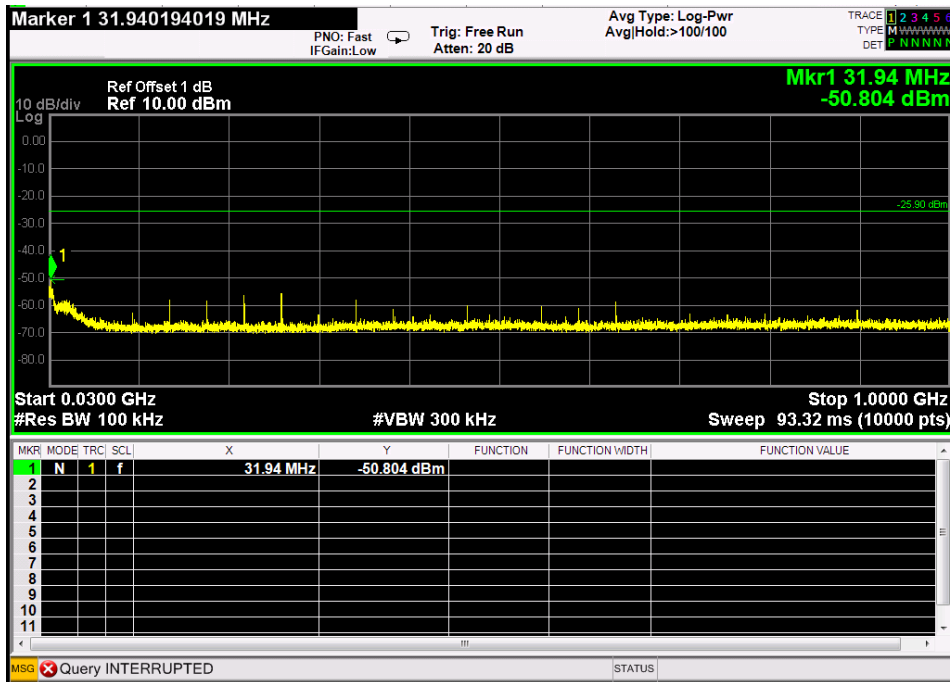

1GHz to 26.5 GHz

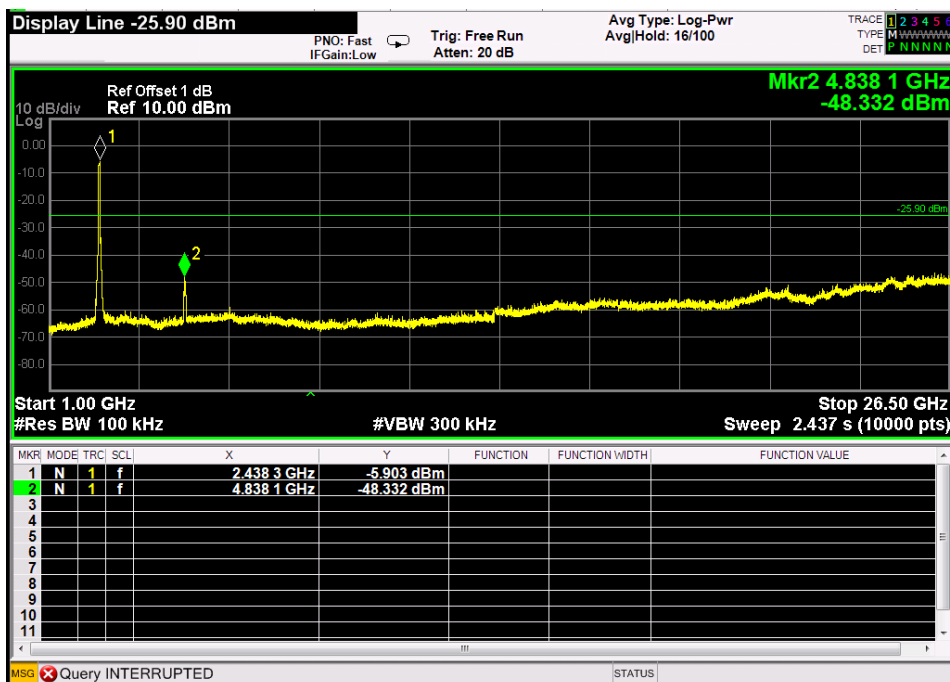



Channel 6: 2.437GHz:

30 MHz to 1 GHz

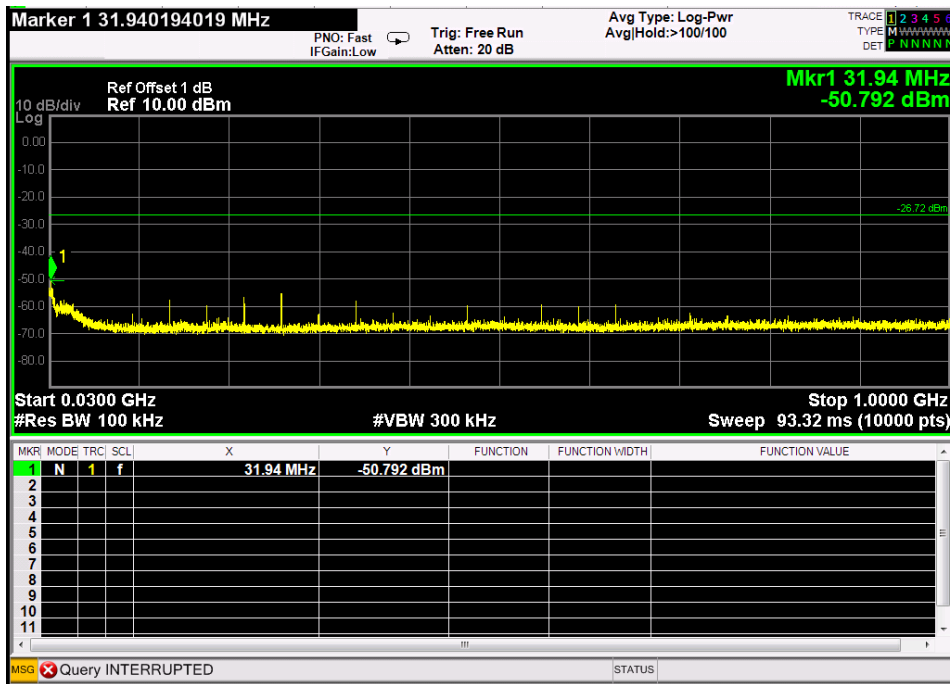

1GHz to 26.5 GHz

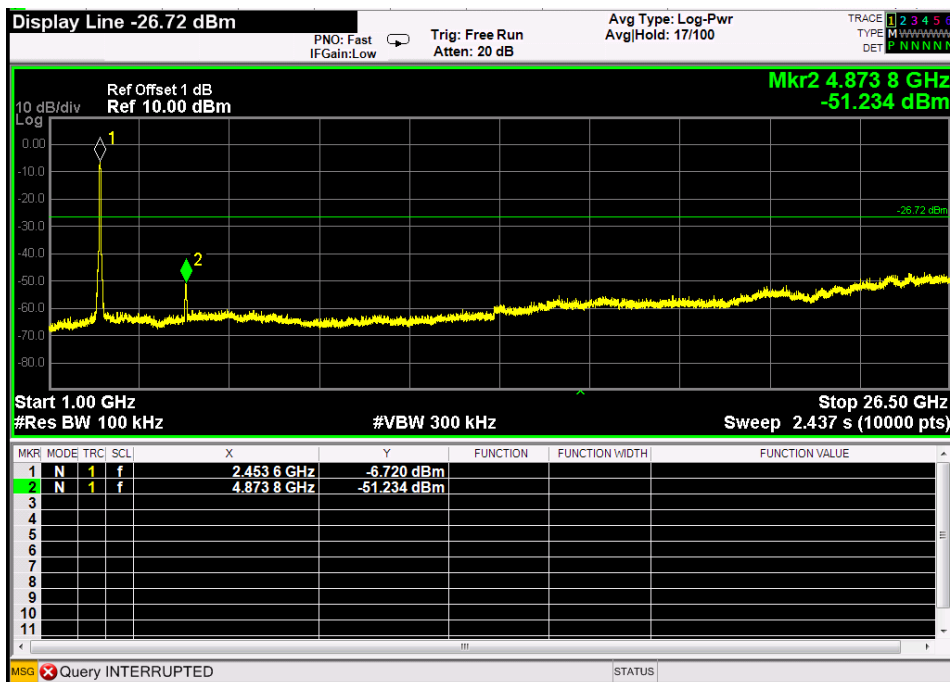



Channel 9:2.452 GHz

30 MHz to 1 GHz

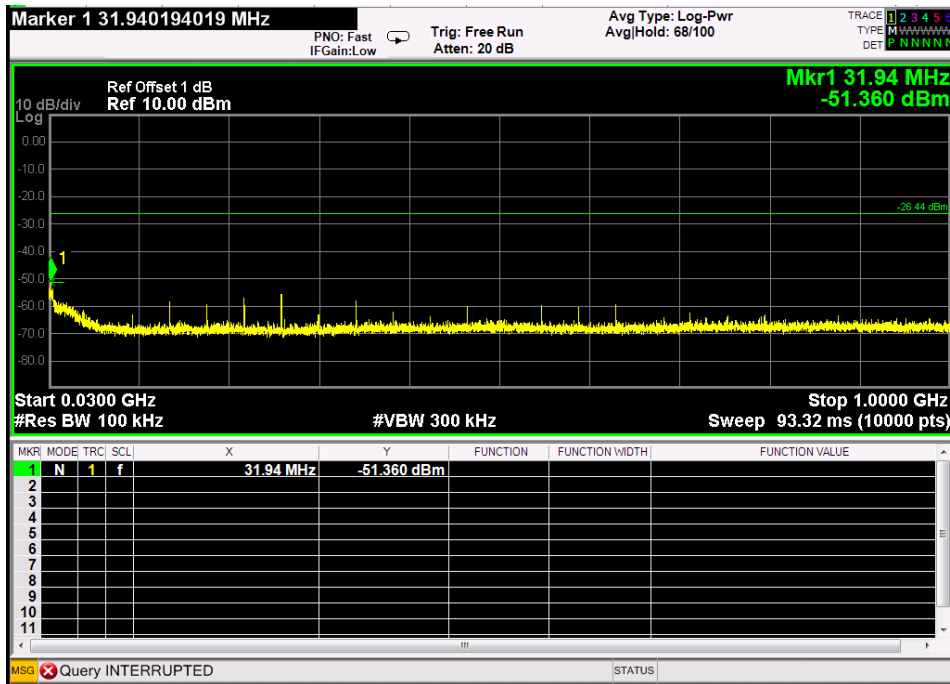

1GHz to 26.5 GHz

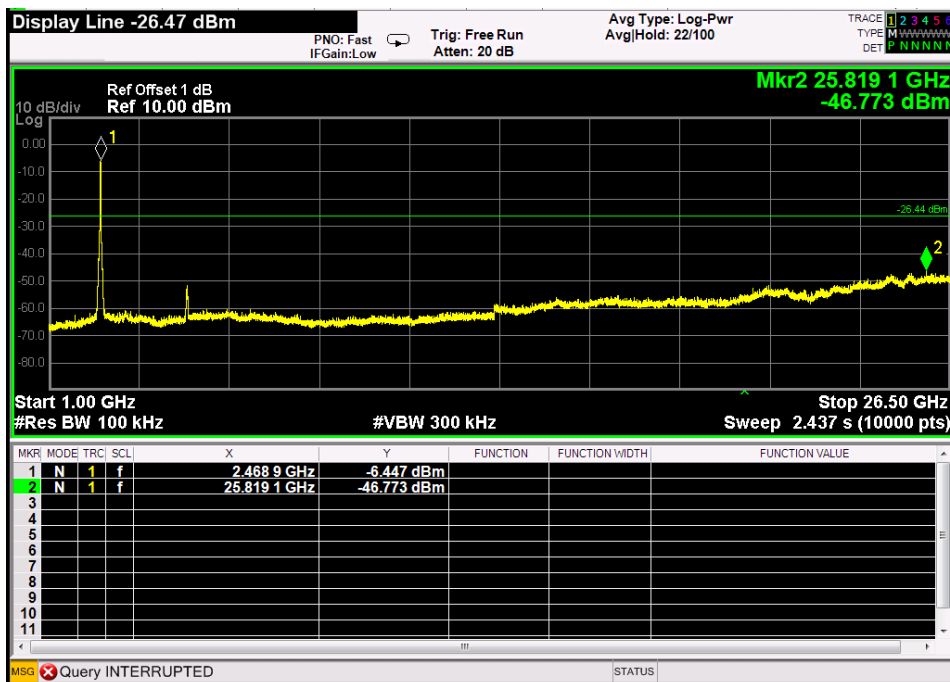



APPENDIX 1

PHOTOS OF TEST CONFIGURATION

1GHz below



1GHz above





Conducted Emission Test Setup

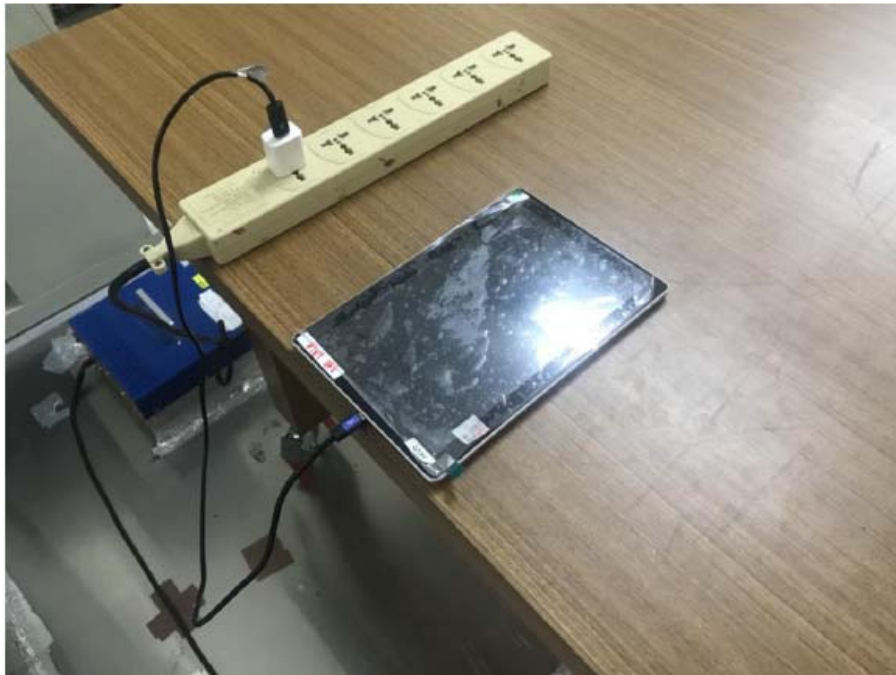



PHOTOS OF EUT



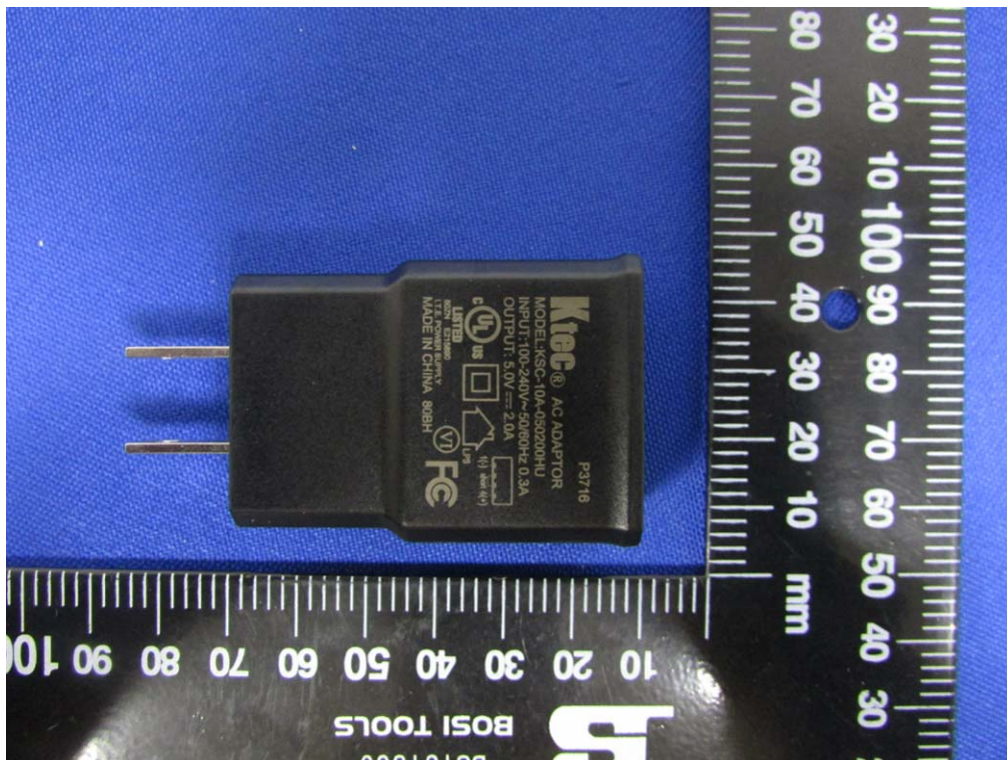
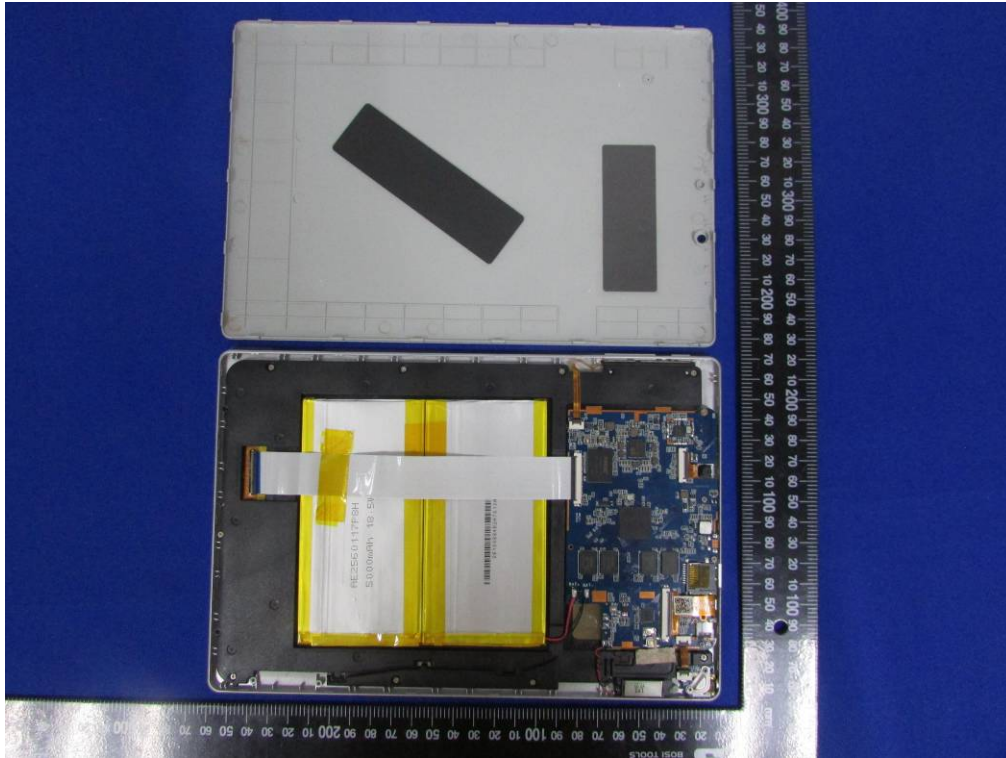

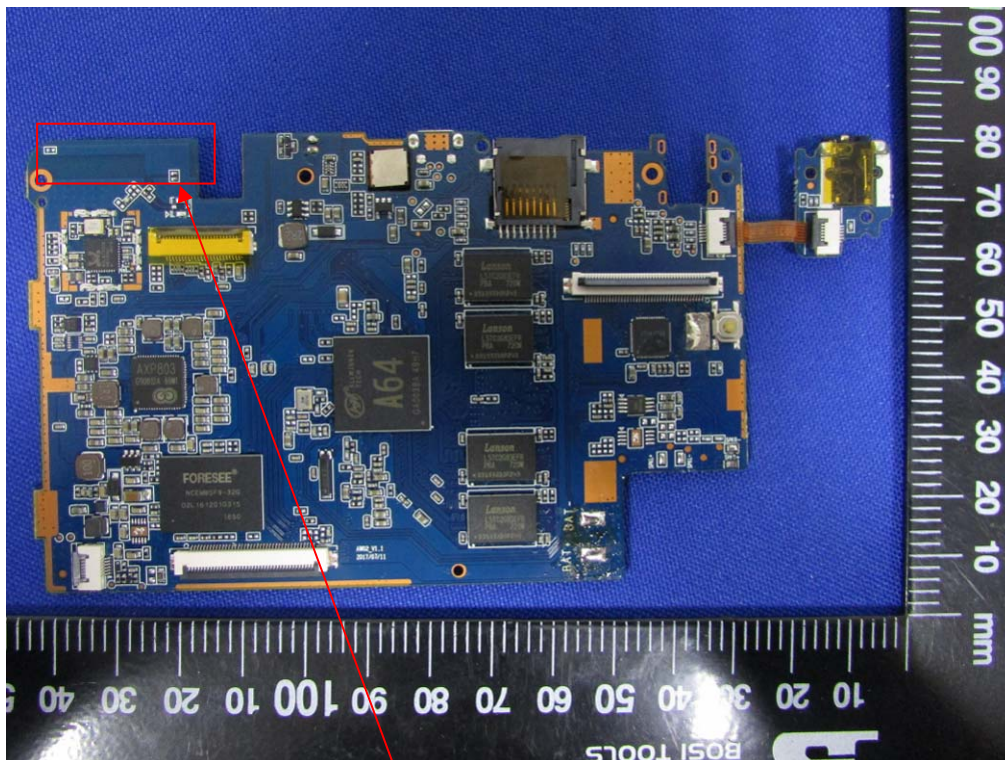
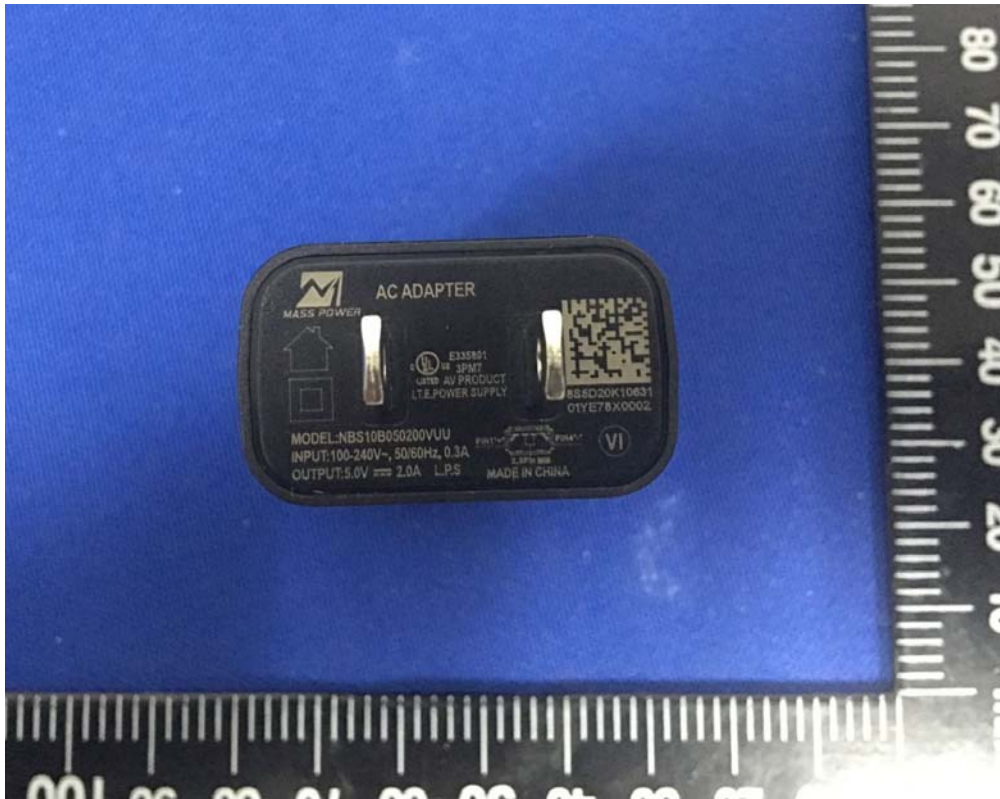

WiFi & BT Antenna

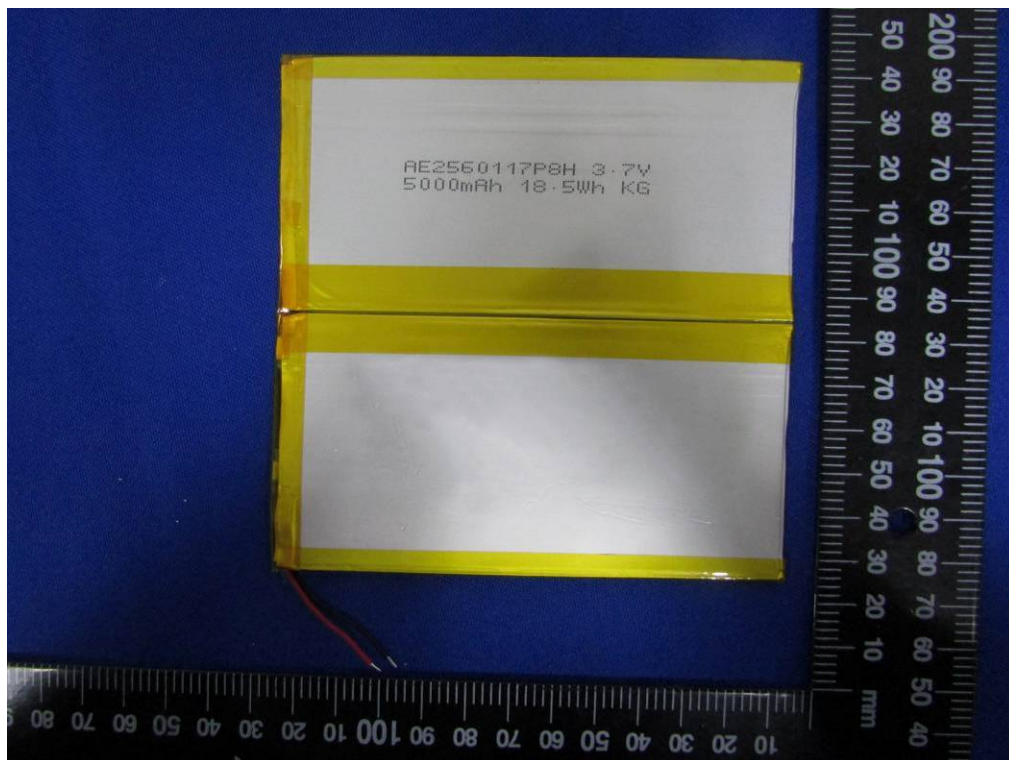
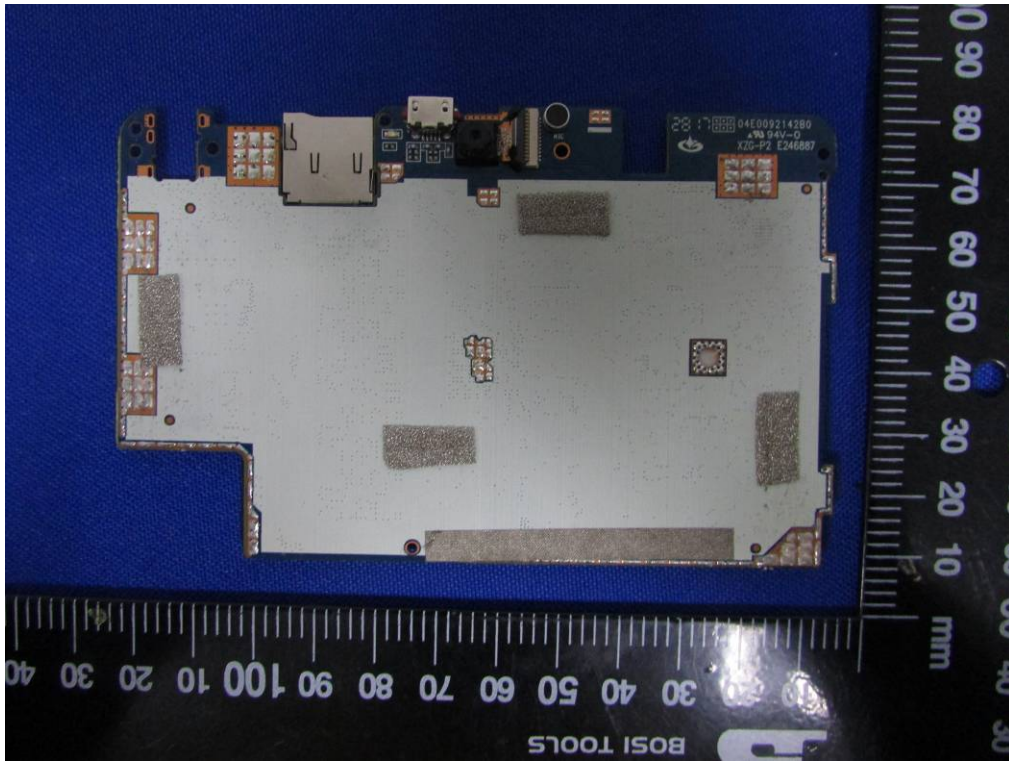

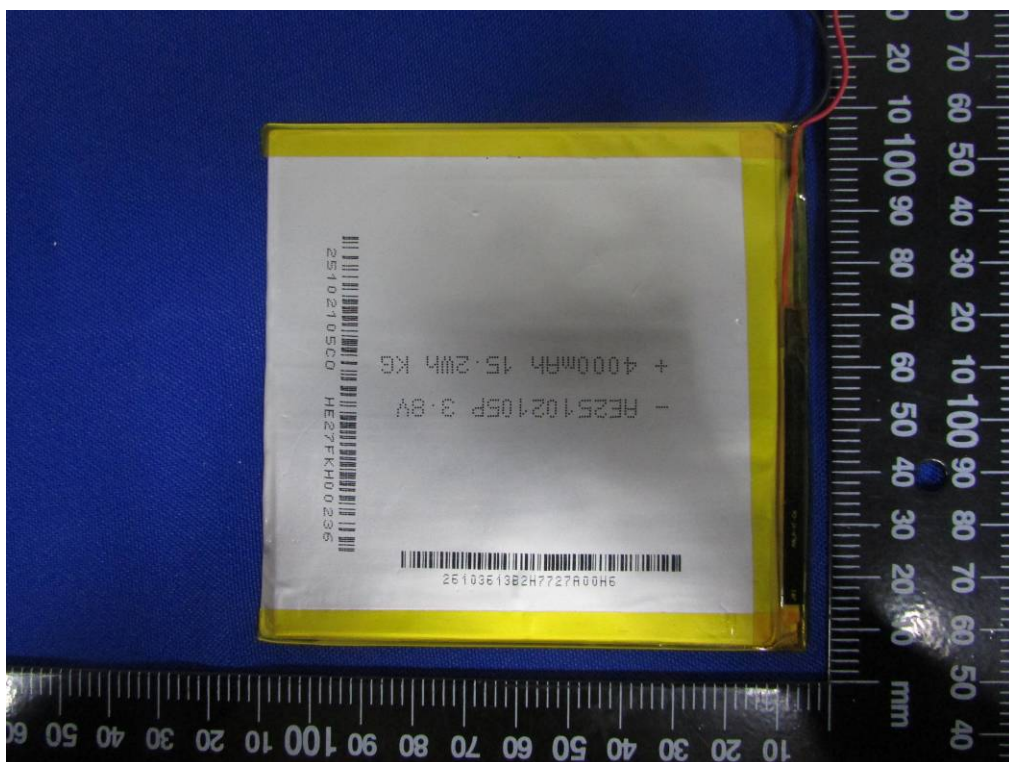
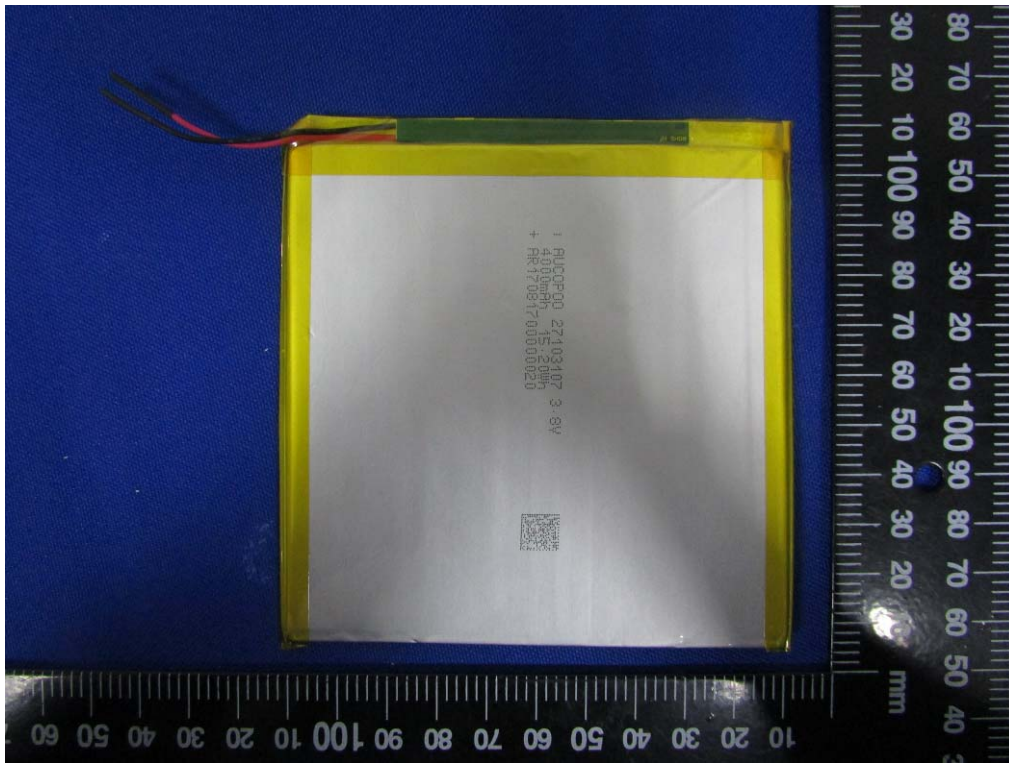

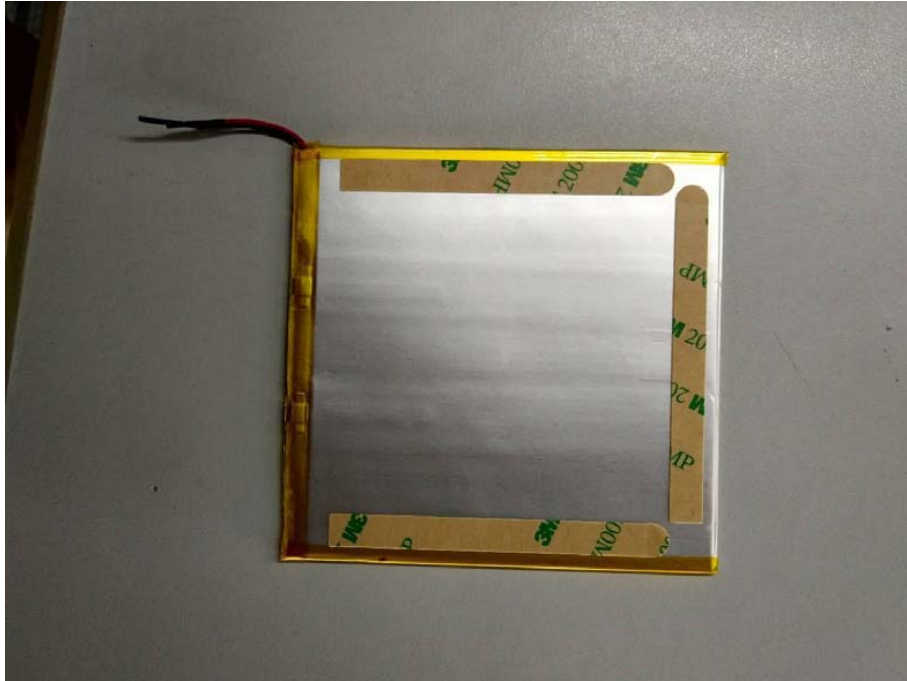

****End of report****