

**ELECTROMAGNETIC EMISSIONS COMPLIANCE REPORT
INTENTIONAL RADIATOR CERTIFICATION TO
FCC PART 15 SUBPART C REQUIREMENT**

OF

Android MID, nextbook

MODEL No.: M1010KP, NXM1010KP, NX010HI8G, NX010HI

FCC ID: S7JNX010HI8G

REPORT NO: ES130307050E

ISSUE DATE: March 17, 2013

Prepared for

**SHENZHEN YIFANG DIGITAL TECHNOLOGY CO., LTD.
Building NO.22,23, Fifth Region, Baiwangxin Industrial Park, Songbai Rd.,
Nanshan, Shenzhen 518108, China**

Prepared by

SHENZHEN EMTEK CO., LTD.

**Bldg 69, Majialong Industry Zone, Nanshan District,
Shenzhen, Guangdong, China**

TEL: 86-755-26954280

FAX: 86-755-26954282

VERIFICATION OF COMPLIANCE

Applicant:	SHENZHEN YIFANG DIGITAL TECHNOLOGY CO., LTD. Building NO.22,23, Fifth Region, Baiwangxin Industrial Park, Songbai Rd., Nanshan, Shenzhen 518108, China
Manufacturer:	SHENZHEN YIFANG DIGITAL TECHNOLOGY CO., LTD. Building NO.22,23, Fifth Region, Baiwangxin Industrial Park, Songbai Rd., Nanshan, Shenzhen 518108, China
Product Description:	Android MID, nextbook
Model Number:	M1010KP, NXM1010KP, NX010HI8G, NX010HI (Note: all the models are the same, except their model number. We take NX010HI8G to test.)
File Number:	ES130307050E
Date of Test:	March 07, 2013 to March 17, 2013

We hereby certify that:

The above equipment was tested by SHENZHEN EMTEK CO., LTD. The test data, data evaluation, test procedures, and equipment configurations shown in this report were made in accordance with the procedures given in ANSI C63.4 (2009) and the energy emitted by the sample EUT tested as described in this report is in compliance with conducted and radiated emission limits of FCC Rules Part 15.247.

The test results of this report relate only to the tested sample identified in this report.

Date of Test : March 07, 2013 to March 17, 2013

Prepared by : Jessie Hu
 Jessie Hu/Editor

Reviewer : King Wang
 King Wang/Supervisor

Approve & Authorized Signer : Lisa Wang
 Lisa Wang/Manager



Table of Contents

1. GENERAL INFORMATION	5
1.1 PRODUCT DESCRIPTION	5
1.2 RELATED SUBMITTAL(S) / GRANT(S).....	5
1.3 TEST METHODOLOGY	6
1.4 SPECIAL ACCESSORIES.....	6
1.5 EQUIPMENT MODIFICATIONS	6
1.6 TEST FACILITY	6
2. SYSTEM TEST CONFIGURATION	7
2.1 EUT CONFIGURATION.....	7
2.2 EUT EXERCISE	7
2.3 TEST PROCEDURE	7
2.4 CONFIGURATION OF TESTED SYSTEM	7
3. DESCRIPTION OF TEST MODES	9
4. SUMMARY OF TEST RESULTS.....	10
5. CONDUCTED EMISSIONS TEST	11
5.1 MEASUREMENT PROCEDURE	11
5.2 TEST SET-UP (BLOCK DIAGRAM OF CONFIGURATION)	11
5.3 MEASUREMENT EQUIPMENT USED	11
5.4 CONDUCTED EMISSION LIMIT	11
5.5 MEASUREMENT RESULT.....	12
6. RADIATED EMISSION TEST	13
6.1 MEASUREMENT PROCEDURE	13
6.2 TEST SET-UP (BLOCK DIAGRAM OF CONFIGURATION)	13
6.3 MEASUREMENT EQUIPMENT USED	14
6.4 RADIATED EMISSION LIMIT.....	14
6.5 MEASUREMENT RESULT.....	16
7. 6DB BANDWIDTH TEST.....	40
7.1 MEASUREMENT PROCEDURE	40
7.2 TEST SET-UP (BLOCK DIAGRAM OF CONFIGURATION)	40
7.3 MEASUREMENT EQUIPMENT USED	40
7.4 MEASUREMENT RESULTS.....	40
8. MAXIMUM PEAK OUTPUT POWER TEST.....	49
8.1 MEASUREMENT PROCEDURE	49
8.2 TEST SET-UP (BLOCK DIAGRAM OF CONFIGURATION)	49
8.3 MEASUREMENT EQUIPMENT USED	49
8.4 PEAK POWER OUTPUT LIMIT	49
8.5 MEASUREMENT RESULTS.....	49
9. BAND EDGE TEST	51
9.1 MEASUREMENT PROCEDURE	51
9.2 TEST SET-UP (BLOCK DIAGRAM OF CONFIGURATION)	51
9.3 MEASUREMENT EQUIPMENT USED	51
9.4 MEASUREMENT RESULTS.....	51
10. POWER DENSITY	54
10.1 TEST EQUIPMENT.....	54
10.2 MEASURING INSTRUMENTS AND SETTING.....	54
10.3 TEST PROCEDURES	54
10.4 BLOCK DIAGRAM OF TEST SETUP.....	54

10.5	LIMIT	54
10.6	TEST RESULT	55
11.	ANTENNA PORT EMISSION	63
11.1	TEST EQUIPMENT	63
11.2	MEASURING INSTRUMENTS AND SETTING.....	63
11.3	TEST PROCEDURES	63
11.4	BLOCK DIAGRAM OF TEST SETUP	63
11.5	TEST RESULT	63
12.	ANTENNA APPLICATION.....	76
12.1	ANTENNA REQUIREMENT.....	76
12.2	RESULT	76

1. General Information

1.1 Product Description

A major technical descriptions of EUT is described as following:

- A). Standards: IEEE802.11b/g/n
- B). Operation Frequency: 802.11b/g/nHT20: 2412-2462MHz;
802.11n(HT40):2422-2452MHz;
- C). Modulation: OFDM with BPSK/QPSK/16QAM/64QAM for 802.11g/n,
DSSS with DBPSK/DQPSK/CCK for 802.11b
- D). Number of Channel: 802.11b/g/n(HT20): 11Channels; 802.11n(HT40): 7 Channels;
- E). Support Data Rate: 1, 2, 5.5, 11, 6, 9, 12, 24, 36, 48, 54, 65, 72.2, 150Mbps;
- F).Conducted Power: 8.39dBm(802.11b), 8.80dBm(802.11g), 8.68dBm(802.11n HT20),
8.24dbm (802.11n HT40)
- G) Antenna Gain: 1dBi
- H). Antenna Type: PCB Antenna
- I). Power Supply: DC 12V with AC Adapter and DC 7.4V from Li-ion Battery.
- J). Adapter : Model: DYS182-120150W-2
 Input: AC 100-240V, 50/60Hz, 0.45A MAX
 Output: DC 12.0V, 1.5A

Channel	Frequency (MHz)	Channel	Frequency (MHz)	Channel	Frequency (MHz)
1	2412	5	2432	9	2452
2	2417	6	2437	10	2457
3	2422	7	2442	11	2462
4	2427	8	2447		

Note:

1. This device is Android MID, nextbook included 802.11b, 802.11g, and 802.11n 2.4GHz transceiver function.
2. Test of channel was included the lowest middle and highest frequency in lowest data rate and to perform the test, then record on this report.

1.2 Related Submittal(s) / Grant(s)

This submittal(s) (test report) is intended for FCC ID: S7JNX010HI8G filing to comply with Section 15.247 of the FCC Part 15, Subpart C Rules. The composite system is compliance with Subpart B is authorized under a DOC procedure.

1.3 Test Methodology

All the test program has follow FCC new test procedure KDB558074, Both conducted and radiated testing was performed according to the procedures in ANSI C63.10 (2009). Radiated testing was performed at an antenna to EUT distance 3 meters.

1.4 Special Accessories

Not available for this EUT intended for grant.

1.5 Equipment Modifications

Not available for this EUT intended for grant.

1.6 Test Facility

Site Description

EMC Lab.

: Accredited by CNAS, 2010.10.29
The certificate is valid until 2013.10.28
The Laboratory has been assessed and proved to be in compliance with CNAS/CL01: 2006(identical to ISO/IEC17025: 2005)
The Certificate Registration Number is L2291

Accredited by TUV Rheinland Shenzhen 2010.5.25
The Laboratory has been assessed according to the requirements ISO/IEC 17025

Accredited by FCC, October 28, 2010
The Certificate Registration Number is 406365.

Accredited by Industry Canada, March 05, 2010
The Certificate Registration Number is 46405-4480.

Name of Firm

: SHENZHEN EMTEK CO., LTD.

Site Location

: Bldg 69, Majialong Industry Zone,
Nanshan District, Shenzhen, Guangdong, China

2. System Test Configuration

2.1 EUT Configuration

The EUT configuration for testing is installed on RF field strength measurement to meet the Commissions requirement and operating in a manner which intends to maximize its emission characteristics in a continuous normal application.

2.2 EUT Exercise

The Transmitter was operated in the normal operating mode. The TX frequency was fixed which was for the purpose of the measurements.

2.3 Test Procedure

2.3.1 Conducted Emissions

The EUT is placed on a turn table which is 0.8 m above ground plane. According to the requirements in Section 13.1.4.1 of ANSI C63.4-2009 Conducted emissions from the EUT measured in the frequency range between 0.15 MHz and 30 MHz using CISPR Quasi-Peak and average detector mode.

2.3.2 Radiated Emissions

The EUT is placed on a turn table which is 0.8 m above ground plane. The turn table shall rotate 360 degrees to determine the position of maximum emission level. EUT is set 3m away from the receiving antenna which varied from 1m to 4m to find out the highest emission. And also, each emission was to be maximized by changing the polarization of receiving antenna both horizontal and vertical. In order to find out the max. Emission, the relative positions of this hand-held transmitter (EUT) was rotated through three orthogonal axes according to the requirements in Section 13.1.4.1 of ANSI C63.4-2009.

2.4 Configuration of Tested System

Fig. 2-1 Configuration of Tested System

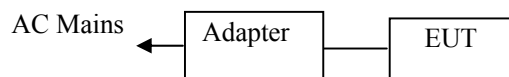

Table 2-1 Equipment Used in Tested System

Item	Equipment	Mfr/Brand	Model/Type No.	FCC ID	Series No.	Note
1.	Android MID, nextbook	YIFANG	NX010HI8G	S7JNX010HI8G	N/A	EUT
2.	Adapter	N/A	DYS182-120150W-2	N/A	N/A	
3.	Earphone	N/A	N/A	N/A	N/A	

Note:

- (1) Unless otherwise denoted as EUT in 『Remark』 column, device(s) used in tested system is a support equipment.

3. Description of Test Modes

The Transmitter of EUT is an Android MID, nextbook and powered by host equipment; these is Digital Transmission system (DTS) and have modulation OFDM, DSSS, DBPSK, DQPSK, CCK, 16QAM, 64QAM. According exploratory test, EUT will have maximum output power in those data rate (802.11b: 1 Mbps; 802.11g: 6 Mbps; 802.11n: MCS0), so those data rate were used for all test.

The equipment enables high-speed access without wires to network assets. This adapter uses the IEEE 802.11 protocol to enable wireless communications between the host and Wireless router.

For 802.11b/g/n20:

1. For lowest channel : 2412MHz (Channel 1)
2. For middle channel : 2437MHz (Channel 6)
3. For highest channel: 2462MHz (Channel 11)

For 802.11 n40:

1. For lowest channel : 2422MHz (Channel 3)
2. For middle channel : 2437MHz (Channel 6)
3. For highest channel: 2452MHz (Channel 9)

4. Summary of Test Results

FCC Rules	Description Of Test	Result
§15.247(a)(2)	6dB bandwidth	Compliant
§15.247(b)(3)	Max Peak output Power test	Compliant
§15.247(e)	Power density	Compliant
§15.247(d)	Band edge test	Compliant
§15.207	AC Power Conducted Emission	Compliant
§15.247(d), §15.209	Radiated Emission	Compliant
§15.247(d)	Antenna Port Emission	Compliant
§15.247(b)&§15.203	Antenna Application	Compliant

5. Conducted Emissions Test

5.1 Measurement Procedure

1. The EUT was placed on a table which is 0.8m above ground plane.
2. Maximum procedure was performed on the six highest emissions to ensure EUT compliance.
3. Repeat above procedures until all frequency measured were complete.

5.2 Test SET-UP (Block Diagram of Configuration)

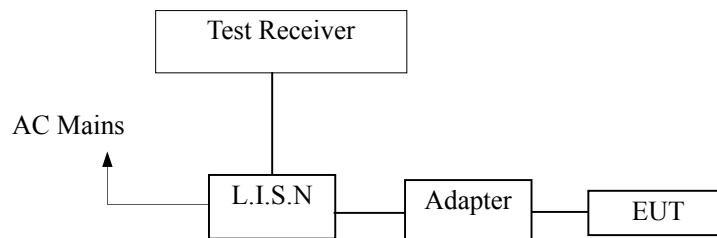

5.3 Measurement Equipment Used

Conducted Emission Test Site					
EQUIPMENT TYPE	MFR	MODEL NUMBER	SERIAL NUMBER	LAST CAL.	CAL DUE.
Test Receiver	Rohde & Schwarz	ESCS30	828985/018	05/29/2012	05/28/2013
L.I.S.N.	Schwarzbeck	NNLK8129	8129203	05/29/2012	05/28/2013
50Ω Coaxial Switch	Anritsu	MP59B	M20531	N/A	N/A
Pulse Limiter	Rohde & Schwarz	ESH3-Z2	100006	05/29/2012	05/28/2013
Voltage Probe	Rohde & Schwarz	TK9416	N/A	05/29/2012	05/28/2013
I.S.N	Rohde & Schwarz	ENY22	1109.9508.02	05/29/2012	05/28/2013

5.4 Conducted Emission Limit

Conducted Emission

Frequency(MHz)	Quasi-peak	Average
0.15-0.5	66-56	56-46
0.5-5.0	56	46
5.0-30.0	60	50

- Note:** 1. The lower limit shall apply at the transition frequencies
 2. The limit decreases in line with the logarithm of the frequency in the range of 0.15 to 0.50MHz.

5.5 Measurement Result

We take 802.11b/g/n mode to test, and the worst test data as following and all modulation methods do not exceed the above mentioned limits.

Date of Test: March 14, 2013 Temperature: 22°C
 Frequency Detector: 0.15~30MHz Humidity: 50%
 Test Result: PASS Test Mode: TX Mode

Test Line	Frequency MHz	Emission Level QP dB(μV)	Emission Level AV dB(μV)	Limits QP dB(μV)	Limits AV dB(μV)	Over QP dB(μV)	Over AV dB(μV)
Line	0.18	49.38	35.40	64.49	54.49	-15.11	-19.09
	0.25	49.90	27.69	61.76	51.76	-11.86	-24.07
	0.30	46.51	31.46	60.24	50.24	-13.73	-18.78
	0.35	49.56	31.40	58.96	48.96	-9.40	-17.56
	0.42	49.76	31.50	57.45	47.45	-7.69	-15.95
	0.53	49.99	31.57	56.00	46.00	-6.01	-14.43
Neutral	0.18	48.44	34.84	64.49	54.49	-16.05	-19.65
	0.31	45.66	28.96	59.97	49.97	-14.31	-21.01
	0.37	47.00	28.07	58.50	48.50	-11.50	-20.43
	0.41	49.17	33.64	57.65	47.65	-8.48	-14.01
	0.49	47.51	31.64	56.17	46.17	-8.66	-14.53
	0.53	48.20	30.61	56.00	46.00	-7.80	-15.39

6. Radiated Emission Test

6.1 Measurement Procedure

1. The EUT was placed on a turntable which is 0.8m above ground plane.
2. Maximum procedure was performed on the six highest emissions to ensure EUT compliance.
3. And also, each emission was to be maximized by changing the polarization of receiving antenna both horizontal and vertical.
4. Repeat above procedures until all frequency measured was complete.

For emissions measurement set the bandwidth of the Spectrum's RBW at 1MHz above 1GHz and RBW 100 KHz below 1GHz.

6.2 Test SET-UP (Block Diagram of Configuration)

(A) Radiated Emission Test Set-Up, Frequency Below 30MHz

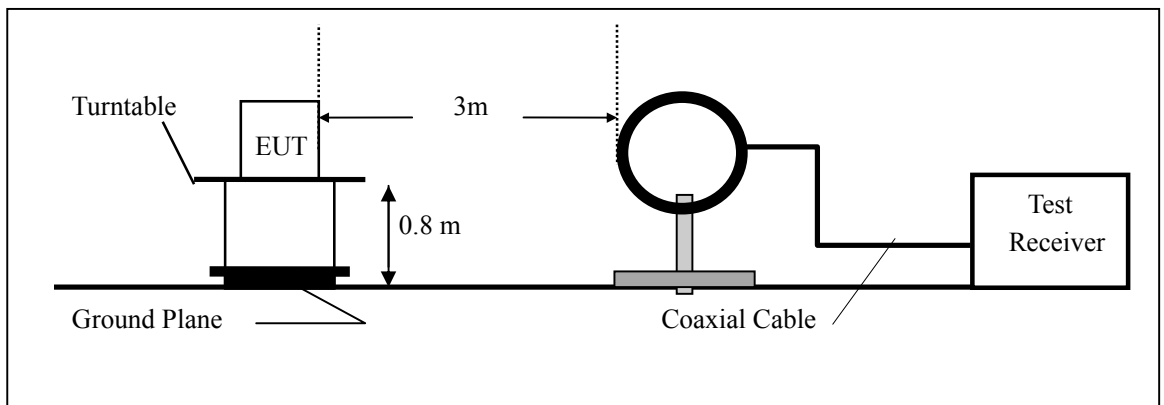

(B) Radiated Emission Test Set-Up, Frequency Below 1000MHz

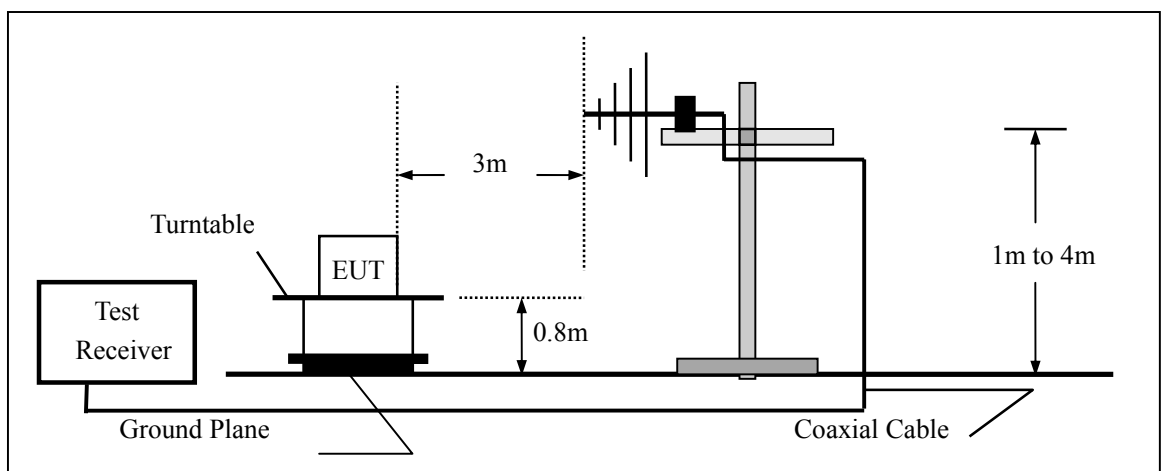

(C) Radiated Emission Test Set-Up, Frequency above 1000MHz

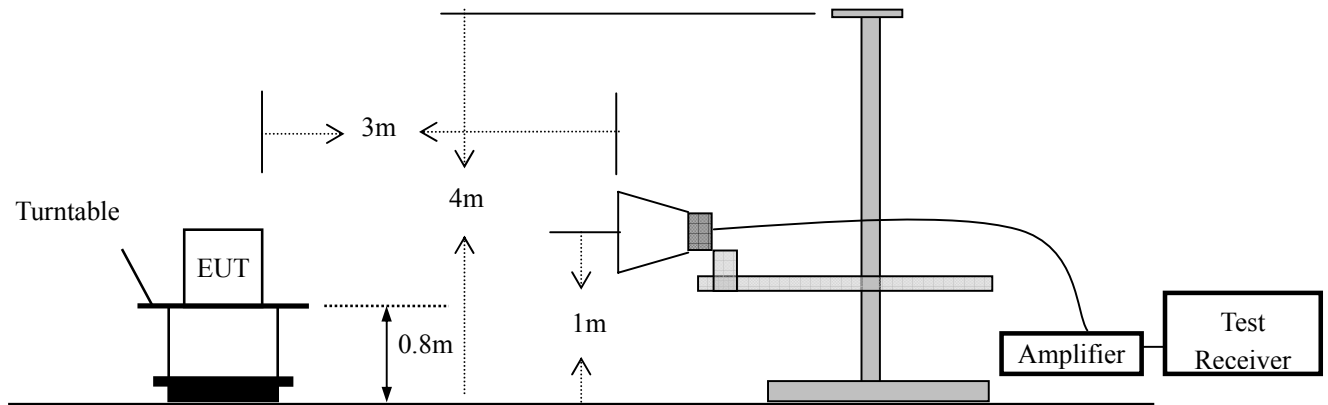

6.3 Measurement Equipment Used

EQUIPMENT TYPE	MFR	MODEL NUMBER	SERIAL NUMBER	LAST CAL.	CAL DUE.
EMI Test Receiver	Rohde & Schwarz	ESU	1302.6005.26	May 29, 2012	05/28/2013
Pre-Amplifier	HP	8447D	2944A07999	May 29, 2012	05/28/2013
Bilog Antenna	Schwarzbeck	VULB9163	142	May 29, 2012	05/28/2013
Loop Antenna	ARA	PLA-1030/B	1029	May 29, 2012	05/28/2013
Horn Antenna	Schwarzbeck	BBHA 9170	BBHA9170399	May 29, 2012	05/28/2013
Horn Antenna	Schwarzbeck	BBHA 9120	D143	May 29, 2012	05/28/2013
Cable	Schwarzbeck	AK9513	ACRX1	May 29, 2012	05/28/2013
Cable	Rosenberger	N/A	FP2RX2	May 29, 2012	05/28/2013
Cable	Schwarzbeck	AK9513	CRPX1	May 29, 2012	05/28/2013
Cable	Schwarzbeck	AK9513	CRRX2	May 29, 2012	05/28/2013

6.4 Radiated Emission Limit

The emissions from an intentional radiator shall not exceed the field strength levels specified in the following table 15.209(a):

Frequencies (MHz)	Field Strength (micровolts/meter)	Measurement Distance (meters)
0.009~0.490	2400/F(KHz)	300
0.490~1.705	24000/F(KHz)	30
1.705~30.0	30	30
30~88	100	3
88~216	150	3
216~960	200	3
Above 960	500	3

15.205 Restricted bands of operation

MHz	MHz	MHz	GHz
0.090 - 0.110	16.42 - 16.423	399.9 - 410	4.5 - 5.15
¹ 0.495 - 0.505	16.69475 - 16.69525	608 - 614	5.35 - 5.46
2.1735 - 2.1905	16.80425 - 16.80475	960 - 1240	7.25 - 7.75
4.125 - 4.128	25.5 - 25.67	1300 - 1427	8.025 - 8.5
4.17725 - 4.17775	37.5 - 38.25	1435 - 1626.5	9.0 - 9.2
4.20725 - 4.20775	73 - 74.6	1645.5 - 1646.5	9.3 - 9.5
6.215 - 6.218	74.8 - 75.2	1660 - 1710	10.6 - 12.7
6.26775 - 6.26825	108 - 121.94	1718.8 - 1722.2	13.25 - 13.4
6.31175 - 6.31225	123 - 138	2200 - 2300	14.47 - 14.5
8.291 - 8.294	149.9 - 150.05	2310 - 2390	15.35 - 16.2
8.362 - 8.366	156.52475 - 156.52525	2483.5 - 2500	17.7 - 21.4
8.37625 - 8.38675	156.7 - 156.9	2690 - 2900	22.01 - 23.12
8.41425 - 8.41475	162.0125 - 167.17	3260 - 3267	23.6 - 24.0
12.29 - 12.293	167.72 - 173.2	3332 - 3339	31.2 - 31.8
12.51975 - 12.52025	240 - 285	3345.8 - 3358	36.43 - 36.5
12.57675 - 12.57725	322 - 335.4	3600 - 4400	(²)

- Remark: 1. Emission level in dBuV/m=20 log (uV/m)
 2. Measurement was performed at an antenna to the closed point of EUT distance of meters.
 3. Only spurious frequency is permitted to locate within the Restricted Bands specified in provision of § 15.205, and the emissions located in restricted bands also comply with 15.209 limit.

6.5 Measurement Result

Operation Mode: TX Mode Test Date : March 14, 2013
 Frequency Range: 9KHz~30MHz Temperature : 28°C
 Test Result: PASS Humidity : 65 %
 Measured Distance: 3m Test By: WOLF
 Note:

Freq. (MHz)	Ant.Pol. H/V	Emission Level (dBuV/m)	Limit 3m (dBuV/m)	Over (dB)
--	--	--	--	--

Note: the amplitude of spurious emission that is attenuated by more than 20dB below the permissible limit has no need to be reported.

Distance extrapolation factor = $40 \log(\text{Specific distance} / \text{test distance})$ (dB);
 Limit line = Specific limits (dBuV) + distance extrapolation factor.

Operation Mode: 802.11b TX Channel 1 Test Date : March 14, 2013
 Frequency Range: 30~1000MHz Temperature : 28°C
 Test Result: PASS Humidity : 65 %
 Measured Distance: 3m Test By: WOLF
 Note:

Freq. (MHz)	Ant.Pol. H/V	Emission Level (dBuV/m)	Limit 3m (dBuV/m)	Over (dB)	Note
31.25	V	36.33	40.00	-3.67	PK
109.21	V	33.11	43.50	-10.39	PK
131.25	V	33.25	43.50	-10.25	PK
359.36	V	38.49	46.00	-7.51	PK
504.55	V	35.29	46.00	-10.71	PK
665.54	V	32.59	46.00	-13.41	PK
141.92	H	30.51	43.50	-12.99	PK
216.54	H	30.80	46.00	-15.20	PK
239.86	H	31.18	46.00	-14.82	PK
252.29	H	36.00	46.00	-10.00	PK
359.55	H	39.46	46.00	-6.54	PK
378.21	H	38.39	46.00	-7.61	PK

- Note:**
- (1) All Readings are Peak Value.
 - (2) Emission Level = Reading Level + Probe Factor + Cable Loss.
 - (3) The average measurement was not performed when the peak measured data under the limit of average detection.
 - (4) EUT stood on the table position is the worst case result in the report.

Operation Mode: 802.11b TX Channel 6 Test Date : March 14, 2013
 Frequency Range: 30~1000MHz Temperature : 28°C
 Test Result: PASS Humidity : 65 %
 Measured Distance: 3m Test By: WOLF
 Note: Adapter 1

Freq. (MHz)	Ant.Pol. H/V	Emission Level (dBuV/m)	Limit 3m (dBuV/m)	Over (dB)	Note
31.24	V	39.16	43.50	-4.34	PK
109.21	V	35.90	46.00	-10.10	PK
131.24	V	35.54	46.00	-10.46	PK
359.42	V	39.72	46.00	-6.28	PK
504.37	V	35.74	46.00	-10.26	PK
665.98	V	40.32	54.00	-13.68	PK
143.28	H	30.03	43.50	-13.47	PK
214.46	H	31.58	46.00	-14.42	PK
240.13	H	29.91	46.00	-16.09	PK
252.54	H	35.49	46.00	-10.51	PK
360.53	H	39.25	46.00	-6.75	PK
378.64	H	45.98	54.00	-8.02	PK

- Note:**
- (1) All Readings are Peak Value.
 - (2) Emission Level= Reading Level+Probe Factor +Cable Loss.
 - (3) The average measurement was not performed when the peak measured data under the limit of average detection.
 - (4) EUT stood on the table position is the worst case result in the report.

Operation Mode: 802.11b TX Channel 11 Test Date : March 14, 2013
 Frequency Range: 30~1000MHz Temperature : 28°C
 Test Result: PASS Humidity : 65 %
 Measured Distance: 3m Test By: WOLF

Freq. (MHz)	Ant.Pol. H/V	Emission Level (dBuV/m)	Limit 3m (dBuV/m)	Over (dB)	Note
31.58	V	39.58	43.50	-3.92	PK
108.57	V	34.86	46.00	-11.14	PK
132.75	V	34.70	46.00	-11.30	PK
359.47	V	37.18	46.00	-8.82	PK
504.25	V	32.31	46.00	-13.69	PK
664.97	V	36.88	54.00	-17.12	PK
140.77	H	28.19	43.50	-15.31	PK
217.67	H	30.11	46.00	-15.89	PK
240.94	H	30.06	46.00	-15.94	PK
250.24	H	34.86	46.00	-11.14	PK
360.33	H	37.58	46.00	-8.42	PK
379.06	H	45.60	54.00	-8.40	PK

- Note:**
- (1) All Readings are Peak Value.
 - (2) Emission Level= Reading Level+Probe Factor +Cable Loss.
 - (3) The average measurement was not performed when the peak measured data under the limit of average detection.
 - (4) EUT stood on the table position is the worst case result in the report.

Operation Mode: 802.11g TX Channel 1 Test Date : March 14, 2013
 Frequency Range: 30~1000MHz Temperature : 28°C
 Test Result: PASS Humidity : 65 %
 Measured Distance: 3m Test By: WOLF

Freq. (MHz)	Ant.Pol. H/V	Emission Level (dBuV/m)	Limit 3m (dBuV/m)	Over (dB)	Note
31.24	V	40.49	43.50	-3.01	PK
109.24	V	35.22	46.00	-10.78	PK
132.24	V	35.10	46.00	-10.90	PK
358.27	V	38.17	46.00	-7.83	PK
504.97	V	34.93	46.00	-11.07	PK
665.37	V	40.81	54.00	-13.19	PK
140.90	H	30.78	43.50	-12.72	PK
217.27	H	31.18	46.00	-14.82	PK
240.35	H	29.40	46.00	-16.60	PK
255.34	H	35.22	46.00	-10.78	PK
360.69	H	39.82	46.00	-6.18	PK
379.66	H	45.98	54.00	-8.02	PK

- Note:**
- (1) All Readings are Peak Value.
 - (2) Emission Level= Reading Level+Probe Factor +Cable Loss.
 - (3) The average measurement was not performed when the peak measured data under the limit of average detection.
 - (4) EUT stood on the table position is the worst case result in the report.

Operation Mode: 802.11g TX Channel 6 Test Date : March 14, 2013
 Frequency Range: 30~1000MHz Temperature : 28°C
 Test Result: PASS Humidity : 65%
 Measured Distance: 3m Test By: WOLF

Freq. (MHz)	Ant.Pol. H/V	Emission Level (dBuV/m)	Limit 3m (dBuV/m)	Over (dB)	Note
31.56	V	39.47	43.50	-4.03	PK
109.57	V	34.17	46.00	-11.83	PK
131.37	V	34.89	46.00	-11.11	PK
359.97	V	37.62	46.00	-8.38	PK
504.37	V	35.05	46.00	-10.95	PK
665.93	V	40.73	54.00	-13.27	PK
141.95	H	30.35	43.50	-13.15	PK
214.79	H	30.84	46.00	-15.16	PK
241.36	H	29.17	46.00	-16.83	PK
254.29	H	34.17	46.00	-11.83	PK
361.74	H	39.97	46.00	-6.03	PK
380.98	H	45.53	54.00	-8.47	PK

- Note:**
- (1) All Readings are Peak Value.
 - (2) Emission Level= Reading Level+Probe Factor +Cable Loss.
 - (3) The average measurement was not performed when the peak measured data under the limit of average detection.
 - (4) EUT stood on the table position is the worst case result in the report.

Operation Mode: 802.11g TX Channel 11 Test Date : March 14, 2013
 Frequency Range: 30~1000MHz Temperature : 28°C
 Test Result: PASS Humidity : 65 %
 Measured Distance: 3m Test By: WOLF

Freq. (MHz)	Ant.Pol. H/V	Emission Level (dBuV/m)	Limit 3m (dBuV/m)	Over (dB)	Note
31.58	V	40.18	43.50	-3.32	PK
109.97	V	34.10	46.00	-11.90	PK
131.68	V	33.05	46.00	-12.95	PK
359.46	V	35.95	46.00	-10.05	PK
504.98	V	36.30	46.00	-9.70	PK
665.37	V	43.48	54.00	-10.52	PK
142.26	H	28.12	43.50	-15.38	PK
218.75	H	30.80	46.00	-15.20	PK
237.83	H	26.35	46.00	-19.65	PK
257.40	H	34.10	46.00	-11.90	PK
361.40	H	38.46	46.00	-7.54	PK
380.99	H	45.21	54.00	-8.79	PK

- Note:**
- (1) All Readings are Peak Value.
 - (2) Emission Level= Reading Level+Probe Factor +Cable Loss.
 - (3) The average measurement was not performed when the peak measured data under the limit of average detection.
 - (4) EUT stood on the table position is the worst case result in the report.

Operation Mode: 802.11n HT20 Test Date : March 14, 2013
 TX Channel 1
 Frequency Range: 30~1000MHz Temperature : 28°C
 Test Result: PASS Humidity : 65 %
 Measured Distance: 3m Test By: WOLF

Freq. (MHz)	Ant.Pol. H/V	Emission Level (dBuV/m)	Limit 3m (dBuV/m)	Over (dB)	Note
31.57	V	39.37	43.50	-4.13	PK
109.37	V	36.06	46.00	-9.94	PK
131.39	V	35.50	46.00	-10.50	PK
359.35	V	38.34	46.00	-7.66	PK
504.25	V	34.94	46.00	-11.06	PK
665.57	V	40.41	54.00	-13.59	PK
141.27	H	30.40	43.50	-13.10	PK
216.95	H	30.24	46.00	-15.76	PK
240.88	H	30.14	46.00	-15.86	PK
251.24	H	35.48	46.00	-10.52	PK
360.65	H	39.91	46.00	-6.09	PK
379.16	H	47.44	54.00	-6.56	PK

- Note:**
- (1) All Readings are Peak Value.
 - (2) Emission Level= Reading Level+Probe Factor +Cable Loss.
 - (3) The average measurement was not performed when the peak measured data under the limit of average detection.
 - (4) EUT stood on the table position is the worst case result in the report.

Operation Mode: 802.11n HT20 Test Date : March 14, 2013
 TX Channel 6
 Frequency Range: 30~1000MHz Temperature : 28°C
 Test Result: PASS Humidity : 65 %
 Measured Distance: 3m Test By: WOLF

Freq. (MHz)	Ant.Pol. H/V	Emission Level (dBuV/m)	Limit 3m (dBuV/m)	Over (dB)	Note
31.57	V	38.83	43.50	-4.67	PK
109.87	V	34.89	46.00	-11.11	PK
131.27	V	35.32	46.00	-10.68	PK
359.55	V	37.78	46.00	-8.22	PK
504.85	V	34.58	46.00	-11.42	PK
665.87	V	40.19	54.00	-13.81	PK
142.32	H	29.04	43.50	-14.46	PK
219.58	H	30.86	46.00	-15.14	PK
242.32	H	31.15	46.00	-14.85	PK
249.23	H	34.92	46.00	-11.08	PK
357.40	H	40.27	46.00	-5.73	PK
378.11	H	47.03	54.00	-6.97	PK

- Note:**
- (1) All Readings are Peak Value.
 - (2) Emission Level= Reading Level+Probe Factor +Cable Loss.
 - (3) The average measurement was not performed when the peak measured data under the limit of average detection.
 - (4) EUT stood on the table position is the worst case result in the report.

Operation Mode: 802.11n HT20 Test Date : March 14, 2013
 TX Channel 11
 Frequency Range: 30~1000MHz Temperature : 28°C
 Test Result: PASS Humidity : 65 %
 Measured Distance: 3m Test By: WOLF

Freq. (MHz)	Ant.Pol. H/V	Emission Level (dBuV/m)	Limit 3m (dBuV/m)	Over (dB)	Note
31.87	V	38.72	43.50	-4.78	PK
109.97	V	34.81	46.00	-11.19	PK
132.79	V	34.48	46.00	-11.52	PK
360.35	V	37.29	46.00	-8.71	PK
505.25	V	35.96	46.00	-10.04	PK
665.58	V	39.29	54.00	-14.71	PK
142.63	H	29.72	43.50	-13.78	PK
218.43	H	30.02	46.00	-15.98	PK
237.15	H	28.01	46.00	-17.99	PK
253.30	H	33.70	46.00	-12.30	PK
361.40	H	38.37	46.00	-7.63	PK
380.43	H	46.39	54.00	-7.61	PK

- Note:**
- (1) All Readings are Peak Value.
 - (2) Emission Level= Reading Level+Probe Factor +Cable Loss.
 - (3) The average measurement was not performed when the peak measured data under the limit of average detection.
 - (4) EUT stood on the table position is the worst case result in the report.

Operation Mode: 802.11n HT40 TX Channel 3 Test Date : March 14, 2013
 Frequency Range: 30~1000MHz Temperature : 28°C
 Test Result: PASS Humidity : 65 %
 Measured Distance: 3m Test By: WOLF

Freq. (MHz)	Ant.Pol. H/V	Emission Level (dBuV/m)	Limit 3m (dBuV/m)	Over (dB)	Note
31.57	V	37.88	43.5	-5.62	PK
109.27	V	34.42	46	-11.58	PK
131.97	V	34.21	46	-11.79	PK
359.87	V	37.46	46	-8.54	PK
506.59	V	33.8	46	-12.2	PK
665.87	V	39.2	54	-14.8	PK
142.94	H	28.82	43.5	-14.68	PK
220.59	H	29.81	46	-16.19	PK
240.88	H	30.03	46	-15.97	PK
249.59	H	34.14	46	-11.86	PK
356.99	H	39.22	46	-6.78	PK
378.34	H	47.03	54	-6.97	PK

- Note:**
- (1) All Readings are Peak Value.
 - (2) Emission Level= Reading Level+Probe Factor +Cable Loss.
 - (3) The average measurement was not performed when the peak measured data under the limit of average detection.
 - (4) EUT stood on the table position is the worst case result in the report.

Operation Mode: 802.11n HT40 TX Channel 6 Test Date : March 14, 2013
 Frequency Range: 30~1000MHz Temperature : 28°C
 Test Result: PASS Humidity : 65 %
 Measured Distance: 3m Test By: WOLF

Freq. (MHz)	Ant.Pol. H/V	Emission Level (dBuV/m)	Limit 3m (dBuV/m)	Over (dB)	Note
31.58	V	37.77	43.5	-5.73	PK
109.98	V	34.34	46	-11.66	PK
132.63	V	33.37	46	-12.63	PK
358.87	V	36.97	46	-9.03	PK
505.36	V	35.18	46	-10.82	PK
665.85	V	38.3	54	-15.7	PK
143.25	H	29.5	43.5	-14	PK
219.44	H	28.97	46	-17.03	PK
235.71	H	26.89	46	-19.11	PK
253.66	H	32.92	46	-13.08	PK
360.99	H	37.32	46	-8.68	PK
380.66	H	46.39	54	-7.61	PK

- Note:**
- (1) All Readings are Peak Value.
 - (2) Emission Level= Reading Level+Probe Factor +Cable Loss.
 - (3) The average measurement was not performed when the peak measured data under the limit of average detection.
 - (4) EUT stood on the table position is the worst case result in the report.

Operation Mode: 802.11n HT40 TX Channel 9 Test Date : March 14, 2013
 Frequency Range: 30~1000MHz Temperature : 28°C
 Test Result: PASS Humidity : 65 %
 Measured Distance: 3m Test By: WOLF

Freq. (MHz)	Ant.Pol. H/V	Emission Level (dBuV/m)	Limit 3m (dBuV/m)	Over (dB)	Note
31.24	V	39.23	43.5	-4.27	PK
109.57	V	33.63	46	-12.37	PK
131.87	V	31.94	46	-14.06	PK
358.67	V	35.63	46	-10.37	PK
504.66	V	35.52	46	-10.48	PK
665.36	V	42.49	54	-11.51	PK
142.88	H	27.9	43.5	-15.6	PK
219.76	H	29.75	46	-16.25	PK
236.39	H	25.23	46	-20.77	PK
257.76	H	33.32	46	-12.68	PK
360.99	H	37.41	46	-8.59	PK
381.22	H	45.21	54	-8.79	PK

- Note:**
- (1) All Readings are Peak Value.
 - (2) Emission Level= Reading Level+Probe Factor +Cable Loss.
 - (3) The average measurement was not performed when the peak measured data under the limit of average detection.
 - (4) EUT stood on the table position is the worst case result in the report.

Operation Mode: 802.11b TX Channel 1 Test Date : March 14, 2013
 Frequency Range: Above 1GHz Temperature : 28°C
 Test Result: PASS Humidity : 65 %
 Measured Distance: 3m Test By: WOLF

Freq. (MHz)	Ant.Pol. H/V	Emission Level(dBuV/m)		Limit 3m(dBuV/m)		Over(dB)	
		PK	AV	PK	AV	PK	AV
4825.167	V	44.97	33.08	74.00	54.00	-29.03	-20.92

7237.628	V	52.21	39.25	74.00	54.00	-21.79	-14.75
9649.538	V	57.39	44.17	74.00	54.00	-16.61	-9.83
--	--	--	--	--	--	--	--
--	--	--	--	--	--	--	--
--	--	--	--	--	--	--	--
4825.513	H	51.32	33.25	74.00	54.00	-22.68	-20.75
7237.423	H	51.48	33.44	74.00	54.00	-22.52	-20.56
9649.39	H	51.68	33.87	74.00	54.00	-22.32	-20.13

All emissions not reported were more than 20dB below the specified limit or in the noise floor.

- Note:** (1) All Readings are Peak Value and AV.
 (2) Emission Level= Reading Level+Probe Factor +Cable Loss.
 (3) Data of measurement within this frequency range shown “ -- ” in the table above means the reading of emissions are attenuated more than 20dB below the permissible limits or the field strength is too small to be measured.

Operation Mode: 802.11b TX Channel 6 Test Date : March 14, 2013
 Frequency Range: Above 1GHz Temperature : 28°C
 Test Result: PASS Humidity : 65 %
 Measured Distance: 3m Test By: WOLF

Freq. (MHz)	Ant.Pol. H/V	Emission Level(dBuV/m)		Limit 3m(dBuV/m)		Over(dB)	
		PK	AV	PK	AV	PK	AV
4875.15	V	45.32	32.74	74.00	54.00	-28.68	-21.26
7312.98	V	51.86	38.52	74.00	54.00	-22.14	-15.48
9749.47	V	58.49	44.95	74.00	54.00	-15.51	-9.05
--	--	--	--	--	--	--	--
--	--	--	--	--	--	--	--
--	--	--	--	--	--	--	--
4875.15	V	45.32	32.74	74.00	54.00	-28.68	-21.26
7312.98	V	51.86	38.52	74.00	54.00	-22.14	-15.48
9749.47	V	58.49	44.95	74.00	54.00	-15.51	-9.05

All emissions not reported were more than 20dB below the specified limit or in the noise floor.

- Note:**
- (1) All Readings are Peak Value and AV.
 - (2) Emission Level= Reading Level+Probe Factor +Cable Loss.
 - (3) Data of measurement within this frequency range shown “ -- ” in the table above means the reading of emissions are attenuated more than 20dB below the permissible limits or the field strength is too small to be measured.

Operation Mode: 802.11b TX (Channel 11) Test Date : March 14, 2013
 Frequency Range: Above 1GHz Temperature : 28°C
 Test Result: PASS Humidity : 65 %
 Measured Distance: 3m Test By: WOLF

Freq. (MHz)	Ant.Pol. H/V	Emission Level(dBuV/m)		Limit 3m(dBuV/m)		Over(dB)	
		PK	AV	PK	AV	PK	AV
4945.19	V	44.06	32.19	74.00	54.00	-29.94	-21.81
7462.70	V	51.16	38.57	74.00	54.00	-22.84	-15.43
9889.80	V	57.76	43.81	74.00	54.00	-16.24	-10.19
--	--	--	--	--	--	--	--
--	--	--	--	--	--	--	--
--	--	--	--	--	--	--	--
4945.04	H	52.27	33.54	74.00	54.00	-21.73	-20.46
7462.69	H	52.56	34.27	74.00	54.00	-21.44	-19.73
9889.74	H	50.83	33.31	74.00	54.00	-23.17	-20.69

No others harmonics emissions are higher than 20dB below the limits of 47 CFR Part 15.247.

- Note:**
- (1) All Readings are Peak Value and AV.
 - (2) Emission Level= Reading Level+Probe Factor +Cable Loss.
 - (3) Data of measurement within this frequency range shown “ -- ” in the table above means the reading of emissions are attenuated more than 20dB below the permissible limits or the field strength is too small to be measured.

Operation Mode: 802.11g TX Channel 1 Test Date : March 14, 2013
 Frequency Range: Above 1GHz Temperature : 28°C
 Test Result: PASS Humidity : 65 %
 Measured Distance: 3m Test By: WOLF

Freq. (MHz)	Ant.Pol. H/V	Emission Level(dBuV/m)		Limit 3m(dBuV/m)		Over(dB)	
		PK	AV	PK	AV	PK	AV
4825.54	V	44.43	33.89	74.00	54.00	-29.57	-20.11
7237.68	V	51.86	39.81	74.00	54.00	-22.14	-14.19
9649.42	V	58.44	43.15	74.00	54.00	-15.56	-10.85
--	--	--	--	--	--	--	--
--	--	--	--	--	--	--	--
--	--	--	--	--	--	--	--
4825.16	H	51.94	33.69	74.00	54.00	-22.06	-20.31
7237.38	H	52.56	34.46	74.00	54.00	-21.44	-19.54
9649.34	H	51.78	34.31	74.00	54.00	-22.22	-19.69

All emissions not reported were more than 20dB below the specified limit or in the noise floor.

- Note:**
- (1) All Readings are Peak Value and AV.
 - (2) Emission Level= Reading Level +Probe Factor +Cable Loss.
 - (3) Data of measurement within this frequency range shown “ -- ” in the table above means the reading of emissions are attenuated more than 20dB below the permissible limits or the field strength is too small to be measured.

Operation Mode: 802.11g TX (Channel 6) Test Date : March 14, 2013
 Frequency Range: Above 1GHz Temperature : 28°C
 Test Result: PASS Humidity : 65 %
 Measured Distance: 3m Test By: WOLF

Freq. (MHz)	Ant.Pol. H/V	Emission Level(dBuV/m)		Limit 3m(dBuV/m)		Over(dB)	
		PK	AV	PK	AV	PK	AV
4875.77	V	42.98	32.99	74.00	54.00	-31.02	-21.01
7312.45	V	53.98	40.48	74.00	54.00	-20.02	-13.52
9749.49	V	59.77	44.36	74.00	54.00	-14.23	-9.64
--	--	--	--	--	--	--	--
--	--	--	--	--	--	--	--
--	--	--	--	--	--	--	--
4875.38	H	53.55	34.53	74.00	54.00	-20.45	-19.47
7312.01	H	53.31	34.11	74.00	54.00	-20.69	-19.89
9749.11	H	52.99	34.43	74.00	54.00	-21.01	-19.57

All emissions not reported were more than 20dB below the specified limit or in the noise floor.

- Note:**
- (1) All Readings are Peak Value and AV.
 - (2) Emission Level= Reading Level+Probe Factor +Cable Loss.
 - (3) Data of measurement within this frequency range shown “ -- ” in the table above means the reading of emissions are attenuated more than 20dB below the permissible limits or the field strength is too small to be measured.

Operation Mode: 802.11g TX (Channel 11) Test Date : March 14, 2013
 Frequency Range: Above 1GHz Temperature : 28°C
 Test Result: PASS Humidity : 65 %
 Measured Distance: 3m Test By: WOLF

Freq. (MHz)	Ant.Pol. H/V	Emission Level(dBuV/m)		Limit 3m(dBuV/m)		Over(dB)	
		PK	AV	PK	AV	PK	AV
4945.98	V	43.29	31.84	74.00	54.00	-30.71	-22.16
7462.85	V	51.45	37.97	74.00	54.00	-22.55	-16.03
9889.75	V	60.77	43.72	74.00	54.00	-13.23	-10.28
--	--	--	--	--	--	--	--
--	--	--	--	--	--	--	--
--	--	--	--	--	--	--	--
4945.70	H	53.15	34.78	74.00	54.00	-20.85	-19.22
7462.67	H	52.87	34.51	74.00	54.00	-21.13	-19.49
9889.76	H	50.53	33.33	74.00	54.00	-23.47	-20.67

No others harmonics emissions are higher than 20dB below the limits of 47 CFR Part 15.247.

- Note:**
- (1) All Readings are Peak Value and AV.
 - (2) Emission Level= Reading Level+Probe Factor +Cable Loss.
 - (3) Data of measurement within this frequency range shown “ -- ” in the table above means the reading of emissions are attenuated more than 20dB below the permissible limits or the field strength is too small to be measured.

Operation Mode: 802.11n HT20 TX Channel 1 Test Date : March 14, 2013
 Frequency Range: Above 1GHz Temperature : 28°C
 Test Result: PASS Humidity : 65 %
 Measured Distance: 3m Test By: WOLF

Freq. (MHz)	Ant.Pol. H/V	Emission Level(dBuV/m)		Limit 3m(dBuV/m)		Over(dB)	
		PK	AV	PK	AV	PK	AV
4824.67	V	44.05	34.4	74	54	-29.95	-19.6
7237.05	V	51.45	40.02	74	54	-22.55	-13.98
9650.23	V	58.96	42.9	74	54	-15.04	-11.1
--	--	--	--	--	--	--	--
--	--	--	--	--	--	--	--
--	--	--	--	--	--	--	--
4826.14	H	52.45	32.64	74	54	-21.55	-21.36
7237.02	H	52.77	34.25	74	54	-21.23	-19.75
9650.23	H	51.53	34.31	74	54	-22.47	-19.69

No others harmonics emissions are higher than 20dB below the limits of 47 CFR Part 15.247.

- Note:**
- (1) All Readings are Peak Value and AV.
 - (2) Emission Level= Reading Level+Probe Factor +Cable Loss.
 - (3) Data of measurement within this frequency range shown “ -- ” in the table above means the reading of emissions are attenuated more than 20dB below the permissible limits or the field strength is too small to be measured.

Operation Mode: 802.11n HT20 TX Channel 6 Test Date : March 14, 2013
 Frequency Range: Above 1GHz Temperature : 28°C
 Test Result: PASS Humidity : 65 %
 Measured Distance: 3m Test By: WOLF

Freq. (MHz)	Ant.Pol. H/V	Emission Level(dBuV/m)		Limit 3m(dBuV/m)		Over(dB)	
		PK	AV	PK	AV	PK	AV
4875.78	V	46.11	32.88	74.00	54.00	-27.89	-21.12
7312.31	V	53.87	40.43	74.00	54.00	-20.13	-13.57
9749.29	V	59.39	45.41	74.00	54.00	-14.61	-8.59
--	--	--	--	--	--	--	--
--	--	--	--	--	--	--	--
--	--	--	--	--	--	--	--
4875.78	V	46.11	32.88	74.00	54.00	-27.89	-21.12
7312.31	V	53.87	40.43	74.00	54.00	-20.13	-13.57
9749.29	V	59.39	45.41	74.00	54.00	-14.61	-8.59

All emissions not reported were more than 20dB below the specified limit or in the noise floor.

- Note:**
- (1) All Readings are Peak Value and AV.
 - (2) Emission Level= Reading Level+Probe Factor +Cable Loss.
 - (3) Data of measurement within this frequency range shown “ -- ” in the table above means the reading of emissions are attenuated more than 20dB below the permissible limits or the field strength is too small to be measured.

Operation Mode: 802.11n HT20 TX Channel 11 Test Date : March 14, 2013
 Frequency Range: Above 1GHz Temperature : 28°C
 Test Result: PASS Humidity : 65 %
 Measured Distance: 3m Test By: WOLF

Freq. (MHz)	Ant.Pol. H/V	Emission Level(dBuV/m)		Limit 3m(dBuV/m)		Over(dB)	
		PK	AV	PK	AV	PK	AV
4945.83	V	47.02	34.44	74.00	54.00	-26.98	-19.56
7462.65	V	51.98	39.17	74.00	54.00	-22.02	-14.83
9889.97	V	60.27	45.84	74.00	54.00	-13.73	-8.16
--	--	--	--	--	--	--	--
--	--	--	--	--	--	--	--
--	--	--	--	--	--	--	--
4945.38	H	53.60	32.98	74.00	54.00	-20.40	-21.02
7462.36	H	51.21	33.21	74.00	54.00	-22.79	-20.79
9889.43	H	50.88	33.45	74.00	54.00	-23.12	-20.55

No others harmonics emissions are higher than 20dB below the limits of 47 CFR Part 15.247.

Note: (1) All Readings are Peak Value and AV.
 (2) Emission Level= Reading Level+Probe Factor +Cable Loss.
 (3) Data of measurement within this frequency range shown “ -- ” in the table above means the reading of emissions are attenuated more than 20dB below the permissible limits or the field strength is too small to be measured.

Operation Mode: 802.11n HT40 TX Channel 3 Test Date : March 14, 2013
 Frequency Range: Above 1GHz Temperature : 28°C
 Test Result: PASS Humidity : 65 %
 Measured Distance: 3m Test By: WOLF

Freq. (MHz)	Ant.Pol. H/V	Emission Level(dBuV/m)		Limit 3m(dBuV/m)		Over(dB)	
		PK	AV	PK	AV	PK	AV
4840.297	V	44.59	33.59	74	54	-29.41	-20.41
7256.998	V	51.8	39.46	74	54	-22.2	-14.54
9684.348	V	57.91	43.92	74	54	-16.09	-10.08
--	--	--	--	--	--	--	--
--	--	--	--	--	--	--	--
--	--	--	--	--	--	--	--
4840.493	H	51.83	32.2	74	54	-22.17	-21.8
7256.063	H	51.69	33.23	74	54	-22.31	-20.77
9684.28	H	51.43	33.87	74	54	-22.57	-20.13

No others harmonics emissions are higher than 20dB below the limits of 47 CFR Part 15.247.

- Note:**
- (1) All Readings are Peak Value and AV.
 - (2) Emission Level= Reading Level+Probe Factor +Cable Loss.
 - (3) Data of measurement within this frequency range shown “ -- ” in the table above means the reading of emissions are attenuated more than 20dB below the permissible limits or the field strength is too small to be measured.

Operation Mode: 802.11n HT40 TX Channel 6 Test Date : March 14, 2013
 Frequency Range: Above 1GHz Temperature : 28°C
 Test Result: PASS Humidity : 65 %
 Measured Distance: 3m Test By: WOLF

Freq. (MHz)	Ant.Pol. H/V	Emission Level(dBuV/m)		Limit 3m(dBuV/m)		Over(dB)	
		PK	AV	PK	AV	PK	AV
4874.28	V	44.94	33.25	74	54	-29.06	-20.75
7312.35	V	51.45	38.73	74	54	-22.55	-15.27
9750.28	V	59.01	44.7	74	54	-14.99	-9.3
--	--	--	--	--	--	--	--
--	--	--	--	--	--	--	--
--	--	--	--	--	--	--	--
4876.13	V	45.83	31.69	74	54	-28.17	-22.31
7312.62	V	52.07	38.31	74	54	-21.93	-15.69
9750.36	V	58.24	44.95	74	54	-15.76	-9.05

No others harmonics emissions are higher than 20dB below the limits of 47 CFR Part 15.247.

- Note:**
- (1) All Readings are Peak Value and AV.
 - (2) Emission Level= Reading Level+Probe Factor +Cable Loss.
 - (3) Data of measurement within this frequency range shown “ -- ” in the table above means the reading of emissions are attenuated more than 20dB below the permissible limits or the field strength is too small to be measured.

Operation Mode: 802.11n HT40 TX Channel 9 Test Date : March 14, 2013
 Frequency Range: Above 1GHz Temperature : 28°C
 Test Result: PASS Humidity : 65 %
 Measured Distance: 3m Test By: WOLF

Freq. (MHz)	Ant.Pol. H/V	Emission Level(dBuV/m)		Limit 3m(dBuV/m)		Over(dB)	
		PK	AV	PK	AV	PK	AV
4904.32	V	43.68	32.7	74	54	-30.32	-21.3
7357.07	V	50.75	38.78	74	54	-23.25	-15.22
9807.61	V	58.28	43.56	74	54	-15.72	-10.44
--	--	--	--	--	--	--	--
--	--	--	--	--	--	--	--
--	--	--	--	--	--	--	--
4904.02	H	52.78	32.49	74	54	-21.22	-21.51
7357.33	H	52.77	34.06	74	54	-21.23	-19.94
9807.63	H	50.58	33.31	74	54	-23.42	-20.69

No others harmonics emissions are higher than 20dB below the limits of 47 CFR Part 15.247.

- Note:**
- (1) All Readings are Peak Value and AV.
 - (2) Emission Level= Reading Level+Probe Factor +Cable Loss.
 - (3) Data of measurement within this frequency range shown “ -- ” in the table above means the reading of emissions are attenuated more than 20dB below the permissible limits or the field strength is too small to be measured.

7. 6dB Bandwidth Test

7.1 Measurement Procedure

The EUT was operating in IEEE 802.11b/g/n mode or could be controlled its channel. Printed out the test result from the spectrum by hard copy function.

7.2 Test SET-UP (Block Diagram of Configuration)

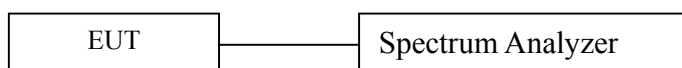

7.3 Measurement Equipment Used

EQUIPMENT TYPE	MFR	MODEL NUMBER	SERIAL NUMBER	LAST CAL.	CAL DUE.
Spectrum Analyzer	Agilent	E4407B	88156318	05/29/2012	05/28/2013

7.4 Measurement Results

6 Bandwidth Test Data Chart:
Refer to attached data chart.

Spectrum Detector: PK Test Date : March 14, 2013
 Test By: Andy Temperature : 28°C
 Test Result: PASS Humidity : 65 %
 Operation Mode: 802.11b

Channel number	Channel frequency (MHz)	Measurement level (MHz)	Required Limit (kHz)
1	2412	10.086	>500
6	2437	9.492	>500
11	2462	9.324	>500

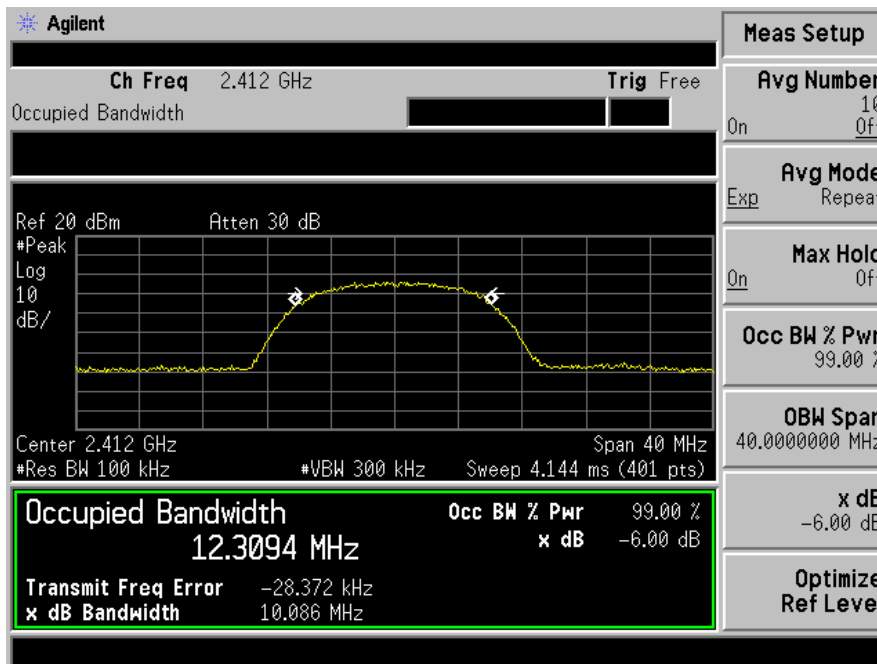

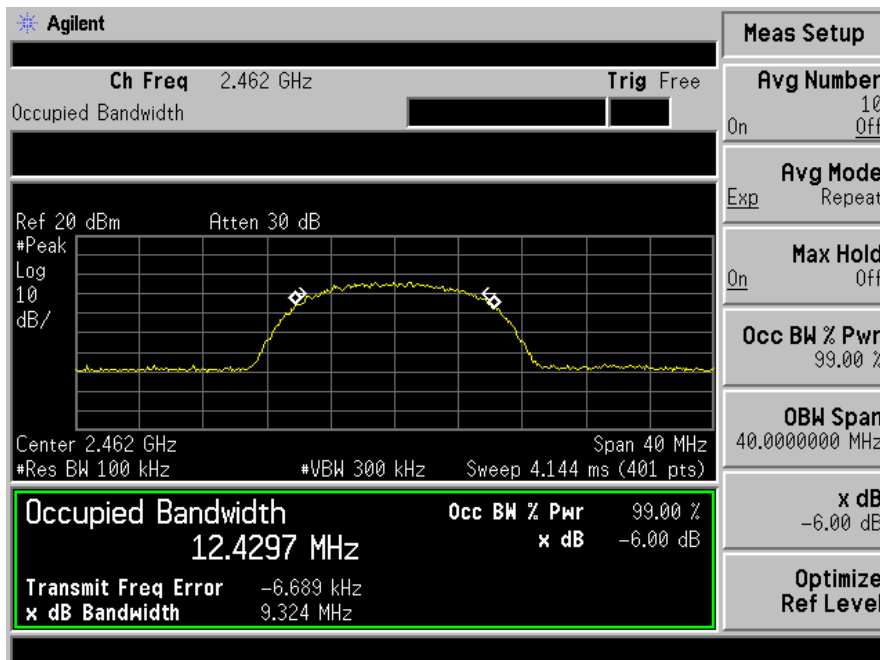
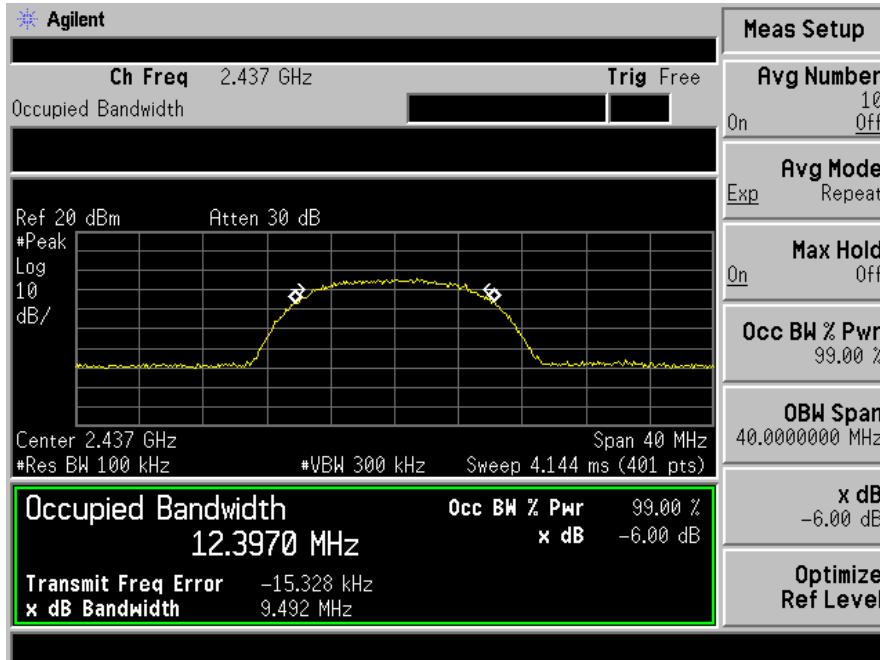

Spectrum Detector: PK Test Date : March 14, 2013
 Test By: Andy Temperature : 28°C
 Test Result: PASS Humidity : 65 %
 Operation Mode: 802.11 g

Channel number	Channel frequency (MHz)	Measurement level (MHz)	Required Limit (kHz)
1	2412	16.577	>500
6	2437	16.560	>500
11	2462	16.521	>500

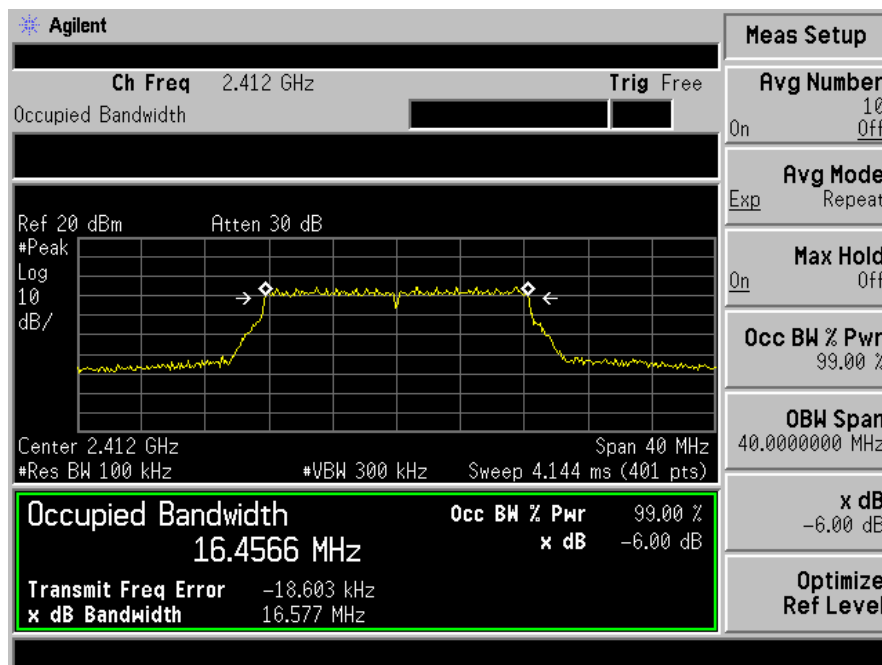

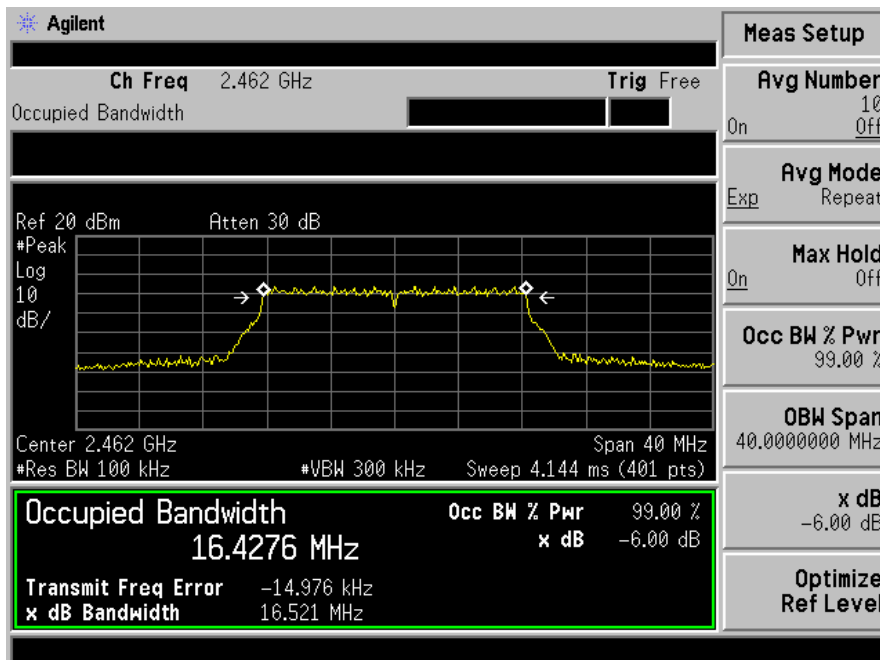
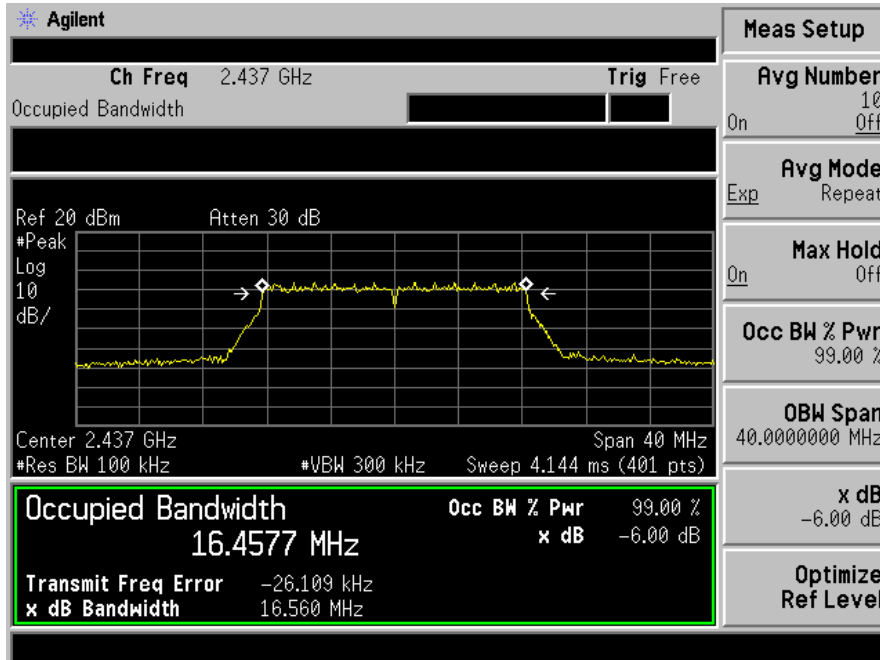

Spectrum Detector: PK Test Date : March 14, 2013
 Test By: Andy Temperature : 28 °C
 Test Result: PASS Humidity : 65 %
 Operation Mode: 802.11 n HT20

Channel number	Channel frequency (MHz)	Measurement level (MHz)	Required Limit (kHz)
1	2412	17.832	>500
6	2437	17.760	>500
11	2462	17.785	>500

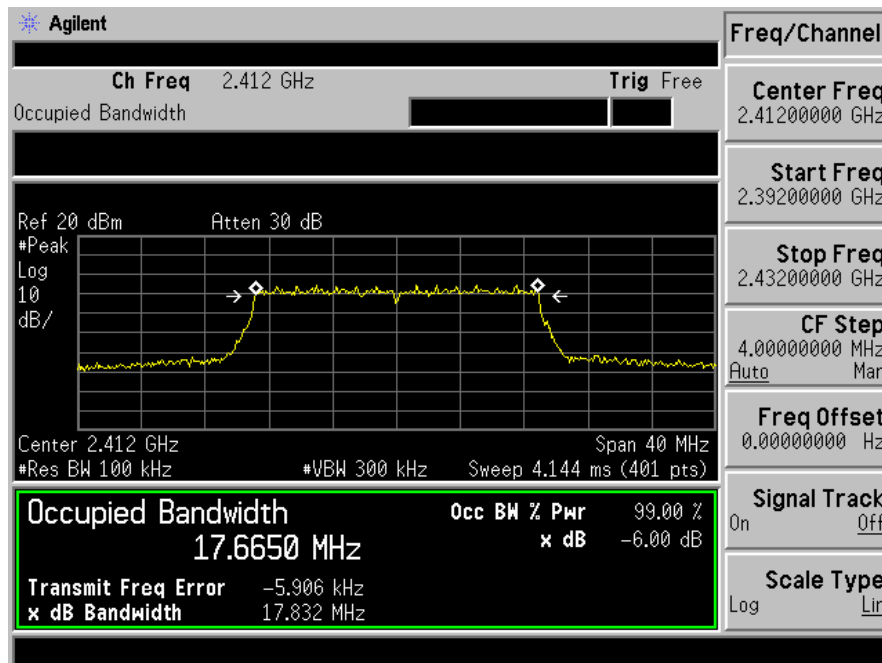

Spectrum Detector: PK Test Date : March 14, 2013
 Test By: Andy Temperature : 28°C
 Test Result: PASS Humidity : 65 %
 Operation Mode: 802.11 n HT40

Channel number	Channel frequency (MHz)	Measurement level (MHz)	Required Limit (kHz)
3	2422	36.447	>500
6	2437	36.483	>500
9	2452	36.427	>500

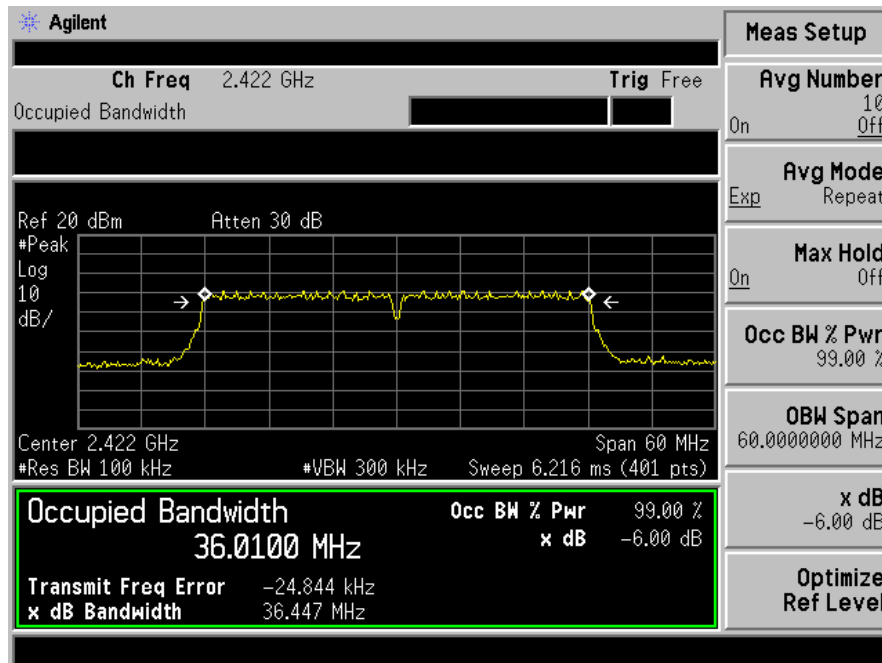

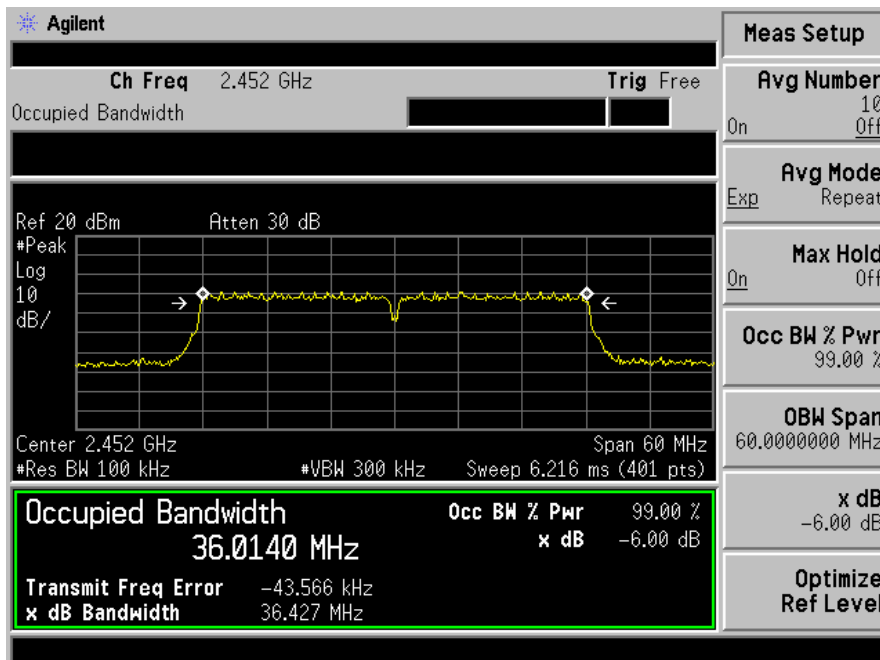
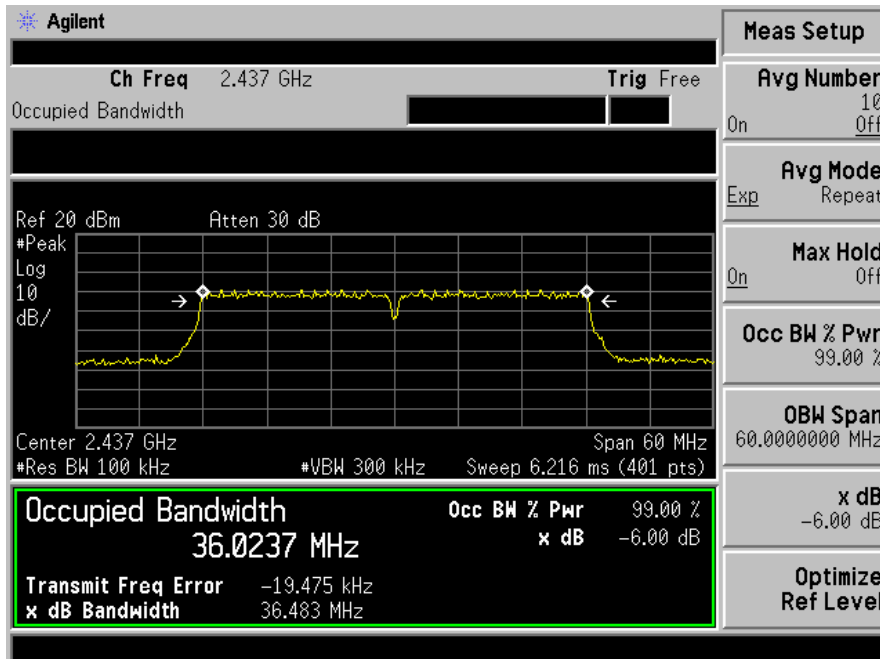

8. Maximum Peak Output Power Test

8.1 Measurement Procedure

- a. The Transmitter output (antenna port) was connected to the power meter.
- b. Turn on the EUT and power meter and then record the peak power value.
- c. Repeat above procedures on all channels needed to be tested.

8.2 Test SET-UP (Block Diagram of Configuration)



8.3 Measurement Equipment Used

EQUIPMENT TYPE	MODEL NUMBER	SERIAL NUMBER	LAST CAL.	CAL DUE.
Power meter	ML2495A	0824006	05/29/2012	05/28/2013
Power sensor	MA2411B	0738172	05/29/2012	05/28/2013

8.4 Peak Power output limit

The maximum peak power shall be less 1Watt.

8.5 Measurement Results

Spectrum Detector: PK Test Date : March 14, 2013
 Test By: Andy Temperature : 28°C
 Test Result: PASS Humidity : 65 %
 Operation Mode: 802.11b

Channel number	Channel Frequency(MHz)	Peak Power output(dBm)	Peak Power Limit(W)	Pass/Fail
1	2412	8.39	1W(30dBm)	PASS
6	2437	8.06	1W(30dBm)	PASS
11	2462	8.01	1W(30dBm)	PASS

Spectrum Detector: PK Test Date : March 14, 2013
 Test By: Andy Temperature : 28°C
 Test Result: PASS Humidity : 65 %
 Operation Mode: 802.11g

Channel number	Channel Frequency (MHz)	Peak Power output(dBm)	Peak Power Limit(W)	Pass/Fail
1	2412.00	8.80	1W(30dBm)	PASS
6	2437.00	8.54	1W(30dBm)	PASS
11	2462.00	8.47	1W(30dBm)	PASS

Spectrum Detector: PK Test Date : March 14, 2013
 Test By: Andy Temperature : 28°C
 Test Result: PASS Humidity : 65 %
 Operation Mode: 802.11n H20

Channel number	Channel Frequency (MHz)	Peak Power output(dBm)	Peak Power Limit(W)	Pass/Fail
1	2412.00	8.68	1W(30dBm)	PASS
6	2437.00	8.34	1W(30dBm)	PASS
11	2462.00	8.18	1W(30dBm)	PASS

Spectrum Detector: PK Test Date : March 14, 2013
 Test By: Andy Temperature : 28°C
 Test Result: PASS Humidity : 65 %
 Operation Mode: 802.11n H40

Channel number	Channel Frequency (MHz)	Peak Power output(dBm)	Peak Power Limit(W)	Pass/Fail
3	2422.00	8.24	1W(30dBm)	PASS
6	2437.00	7.78	1W(30dBm)	PASS
9	2452.00	8.01	1W(30dBm)	PASS

9. Band Edge Test

9.1 Measurement Procedure

1. The EUT was Operating in hopping mode or could be controlled its channel. Printed out test result from the spectrum by hard copy function.
2. The EUT was placed on a turn table which is 0.8m above ground plane.
3. Maximum procedure was performed on the six highest emissions to ensure EUT compliance.
4. And also, each emission was to be maximized by changing the polarization of receiving antenna both horizontal and vertical.
5. Repeat above procedures until all frequency measured were complete.

9.2 Test SET-UP (Block Diagram of Configuration)

As 6.2 Test set up (B) and (C)

9.3 Measurement Equipment Used

Same as 6.3 Radiated Emission Measurement.

9.4 Measurement Results

Test mode: 802.11b

Spectrum Detector: PK/AV Test Date : March 14, 2013
 Test By: Andy Temperature : 28 °C
 Test channel: 01 Humidity : 65 %

Frequency (MHz)	Polarity	Level (dBuV/m)		Limited (dBuV/m)	
		PK	AV	PK	AV
2390.00	H	51.28	45.45	74	54
2390.00	V	49.48	43.19	74	54

Spectrum Detector: PK/AV Test Date : January 20, 2013
 Test By: Andy Temperature : 28 °C
 Test channel: 11 Humidity : 65 %

Frequency (MHz)	Polarity	Level (dBuV/m)		Limited (dBuV/m)	
		PK	AV	PK	AV
2483.50	H	48.49	42.38	74	54
2483.50	V	46.59	40.48	74	54

Test mode: 802.11g

Spectrum Detector: PK/AV Test Date : March 14, 2013
 Test By: Andy Temperature : 28 °C
 Test channel: 01 Humidity : 65 %

Frequency (MHz)	Polarity	Level (dBuV/m)		Limited (dBuV/m)	
		PK	AV	PK	AV
2390.00	H	49.80	42.64	74	54
2390.00	V	47.70	41.51	74	54

Spectrum Detector: PK/AV Test Date : March 14, 2013
 Test By: Andy Temperature : 28 °C
 Test channel: 11 Humidity : 65 %

Frequency (MHz)	Polarity	Level (dBuV/m)		Limited (dBuV/m)	
		PK	AV	PK	AV
2483.50	H	47.51	42.48	74	54
2483.50	V	46.46	40.25	74	54

Test mode: 802.11n HT20

Spectrum Detector: PK/AV Test Date : March 14, 2013
 Test By: Andy Temperature : 28 °C
 Test channel: 01 Humidity : 65 %

Frequency (MHz)	Polarity	Level (dBuV/m)		Limited (dBuV/m)	
		PK	AV	PK	AV
2390.00	H	47.49	42.64	74	54
2390.00	V	46.75	40.82	74	54

Spectrum Detector: PK/AV Test Date : March 14, 2013
 Test By: Andy Temperature : 28 °C
 Test channel: 11 Humidity : 65 %

Frequency (MHz)	Polarity	Level (dBuV/m)		Limited (dBuV/m)	
		PK	AV	PK	AV
2483.50	H	47.14	41.65	74	54
2483.50	V	46.45	40.85	74	54

Test mode: 802.11n HT40

Spectrum Detector: PK/AV Test Date : March 14, 2013
 Test By: Andy Temperature : 28 °C
 Test channel: 03 Humidity : 65 %

Frequency (MHz)	Polarity	Level (dBuV/m)		Limited (dBuV/m)	
		PK	AV	PK	AV
2390.00	H	47.49	42.38	74	54
2390.00	V	46.49	40.48	74	54

Spectrum Detector: PK/AV Test Date : March 14, 2013
 Test By: Andy Temperature : 28 °C
 Test channel: 09 Humidity : 65 %

Frequency (MHz)	Polarity	Level (dBuV/m)		Limited (dBuV/m)	
		PK	AV	PK	AV
2483.50	H	47.79	41.48	74	54
2483.50	V	46.92	40.85	74	54

10. Power Density

10.1 Test Equipment

EQUIPMENT TYPE	MFR	MODEL NUMBER	SERIAL NUMBER	LAST CAL.	CAL DUE.
Spectrum Analyzer	Agilent	E4407B	88156318	05/29/2012	05/28/2013

10.2 Measuring Instruments and Setting

The following table is the setting of spectrum analyzer.

Spectrum analyzer	Setting
Attenuation	Auto
Span Frequency	Set the analyzer span to a minimum of 1.5 times the EBW.
RB	3kHz
VB	10kHz
Detector	Peak
Trace	Max hold
Sweep Time	Automatic

10.3 Test Procedures

- a. The transmitter output (antenna port) was connected to the spectrum analyzer.
- b. Set analyzer center frequency to DTS channel center frequency.
- c. Set the analyzer span to a minimum of 1.5 times the EBW.
- d. Set the RBW ≥ 3 kHz. Set the VBW $\geq 3 \times$ RBW.
- e. Detector = peak.
- f. Sweep time = auto couple.
- g. Trace mode = max hold.
- h. Allow trace to fully stabilize.
- i. Use the peak marker function to determine the maximum amplitude level.

10.4 Block Diagram of Test Setup

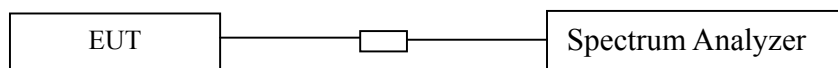

10.5 Limit

The transmitted power density averaged over any 1 second interval shall not be greater +8dBm in any 3 kHz bandwidth.

10.6 Test Result

Spectrum Detector: PK Test Date : March 14, 2013
 Test By: Andy Temperature : 28°C
 Test Result: PASS Humidity : 65 %
 Operation Mode: 802.11 b

Channel	Measurement Level (dBm)	Required Limit (dBm)	Result
1	-18.23	<8dBm	PASS
6	-18.28	<8dBm	PASS
11	-18.09	<8dBm	PASS

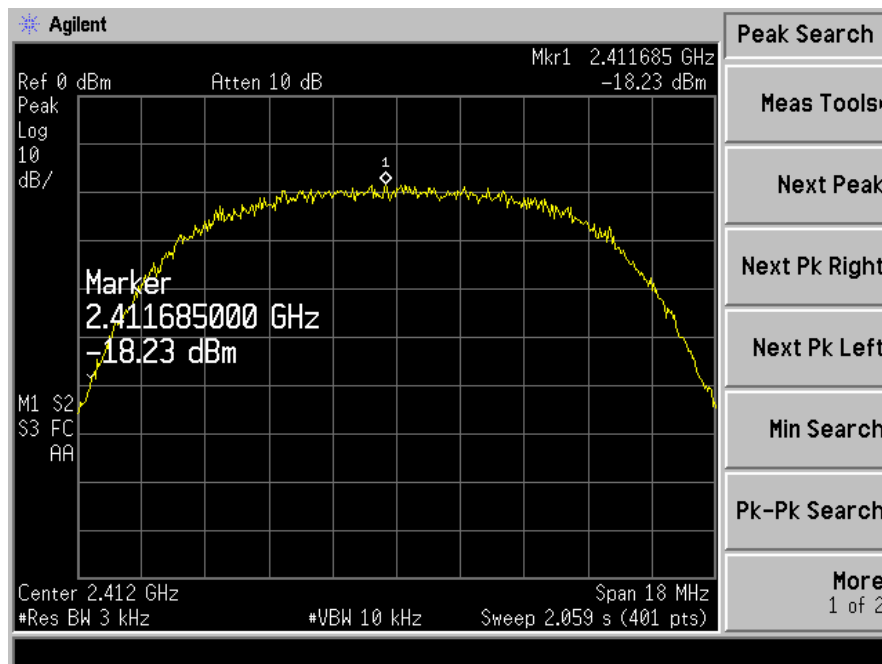

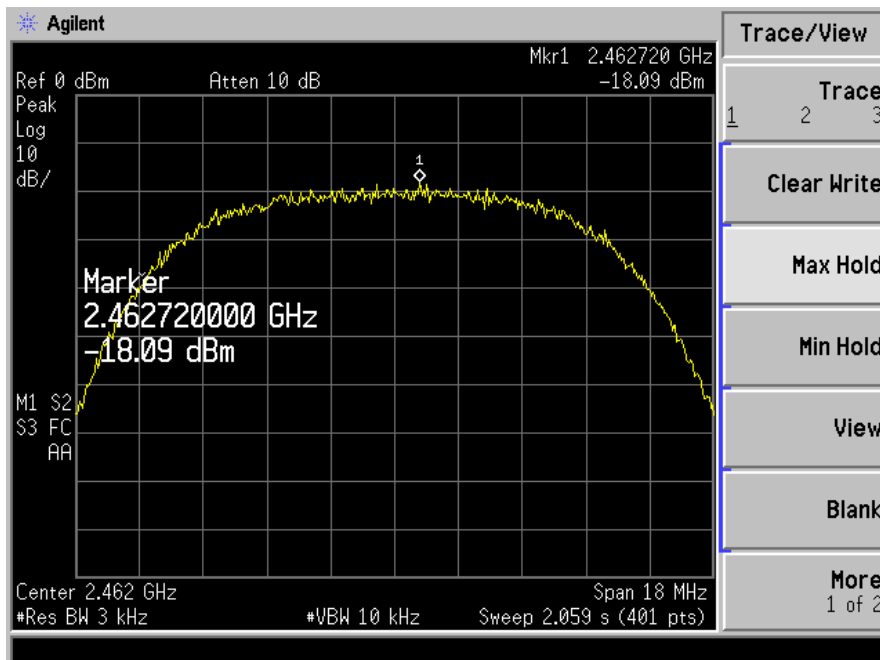
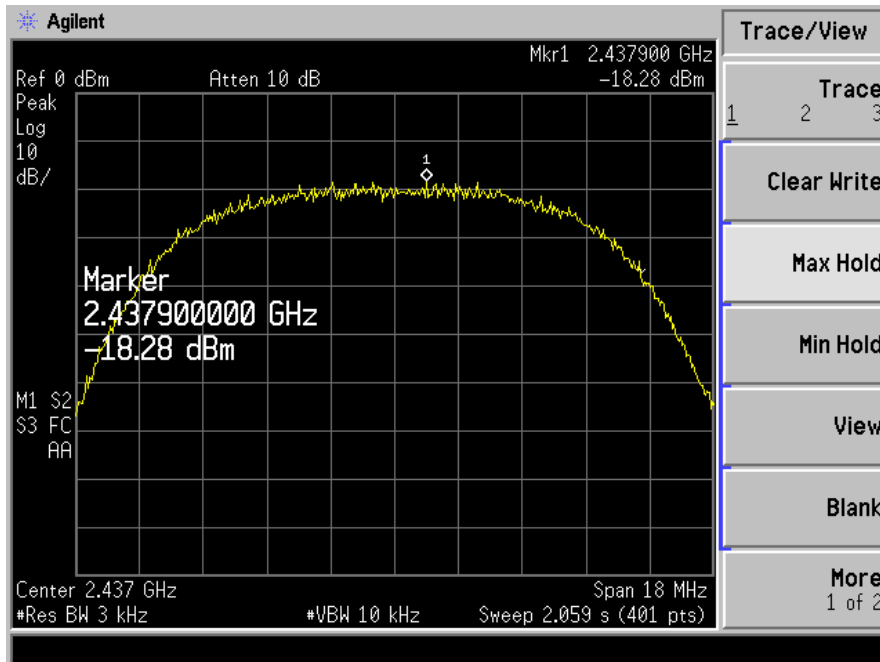

Spectrum Detector: PK Test Date : March 14, 2013
 Test By: Andy Temperature : 28 °C
 Test Result: PASS Humidity : 65 %
 Operation Mode: 802.11 g

Channel	Measurement Level (dBm)	Required Limit (dBm)	Result
1	-18.79	<8dBm	PASS
6	-19.86	<8dBm	PASS
11	-20.4	<8dBm	PASS

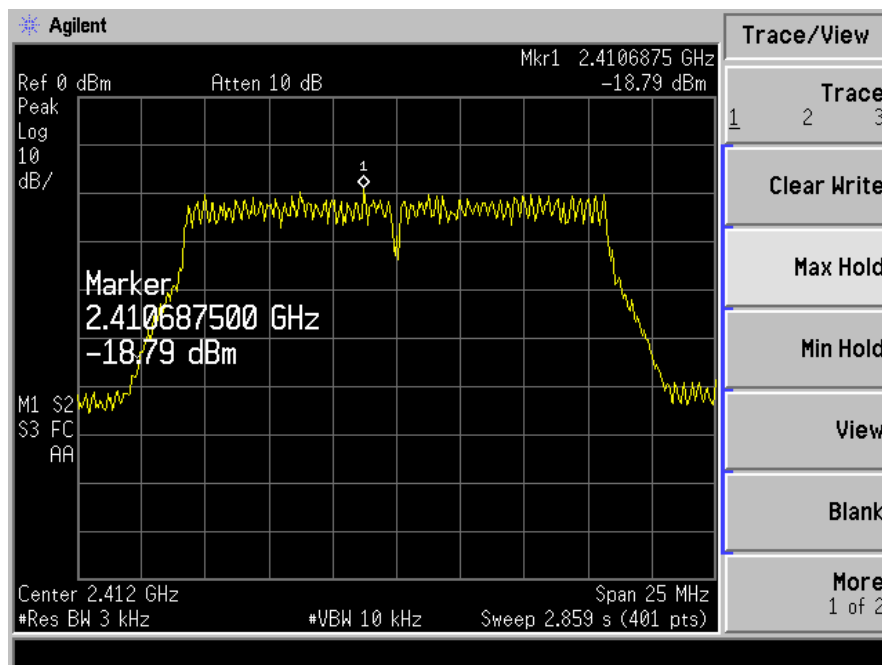

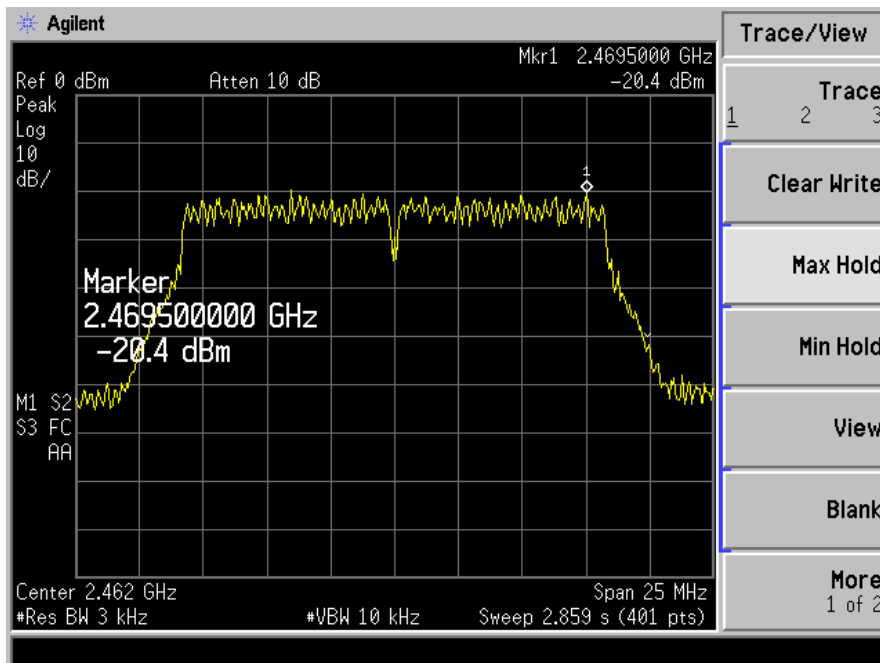
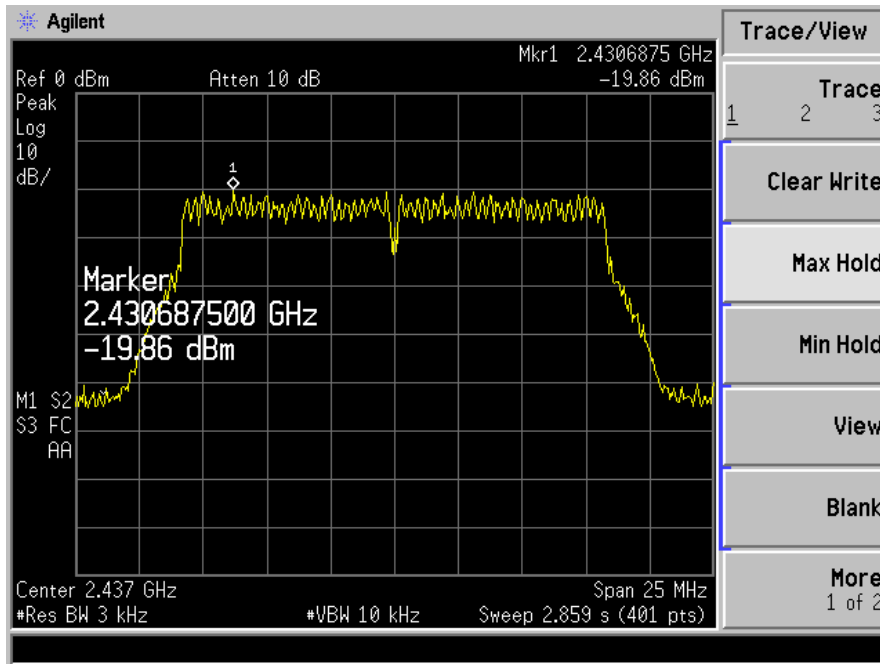

Spectrum Detector: PK Test Date : March 14, 2013
 Test By: Andy Temperature : 28°C
 Test Result: PASS Humidity : 65 %
 Operation Mode: 802.11 n HT20

Channel	Measurement Level (dBm)	Required Limit (dBm)	Result
1	-19.47	<8dBm	PASS
6	-19.24	<8dBm	PASS
11	-20.48	<8dBm	PASS

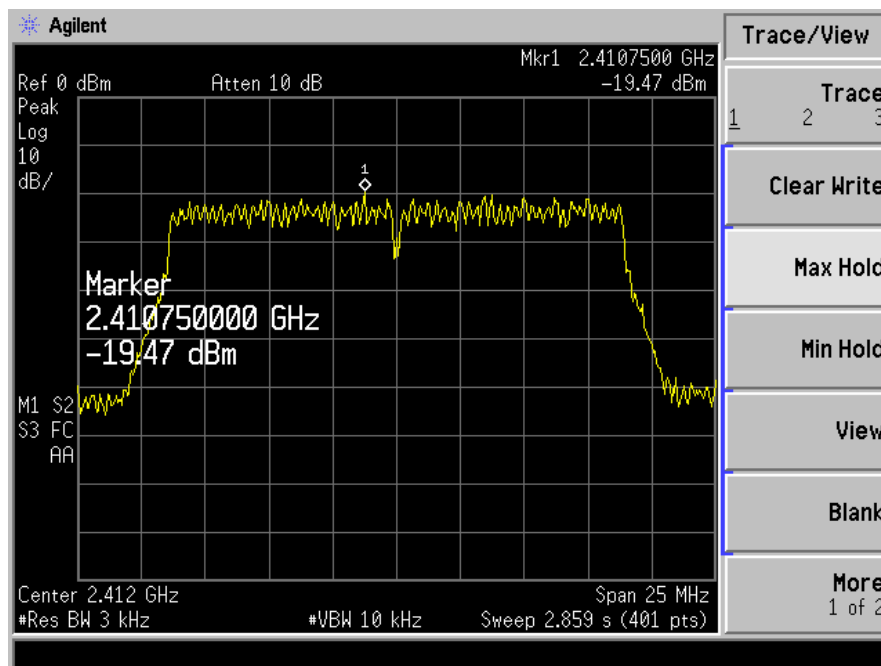

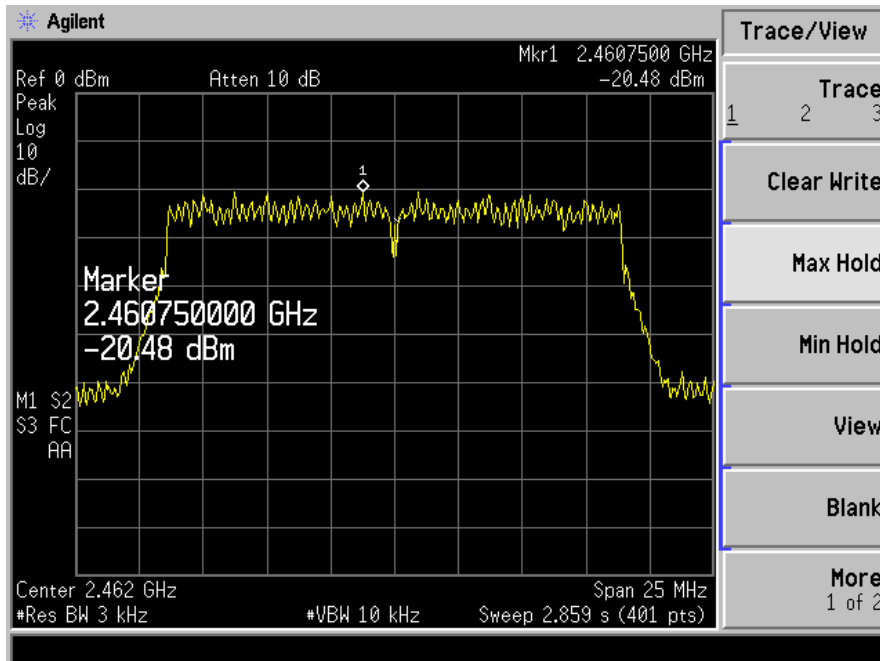
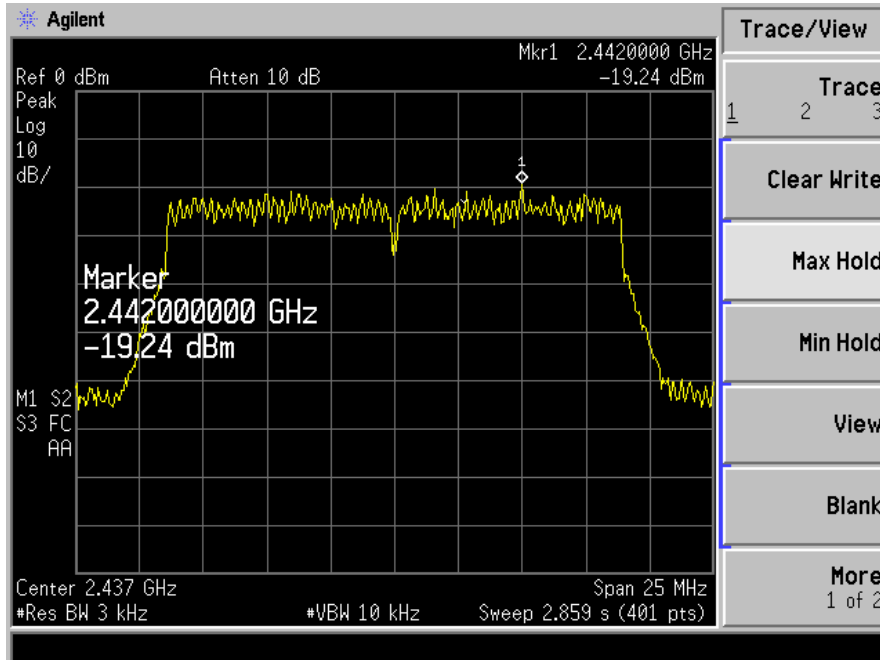

Spectrum Detector:	PK	Test Date :	March 14, 2013
Test By:	Andy	Temperature :	28°C
Test Result:	PASS	Humidity :	65 %
Operation Mode:	802.11 n HT40		

Channel	Measurement Level (dBm)	Required Limit (dBm)	Result
3	-22.62	<8dBm	PASS
6	-23.05	<8dBm	PASS
9	-23.27	<8dBm	PASS

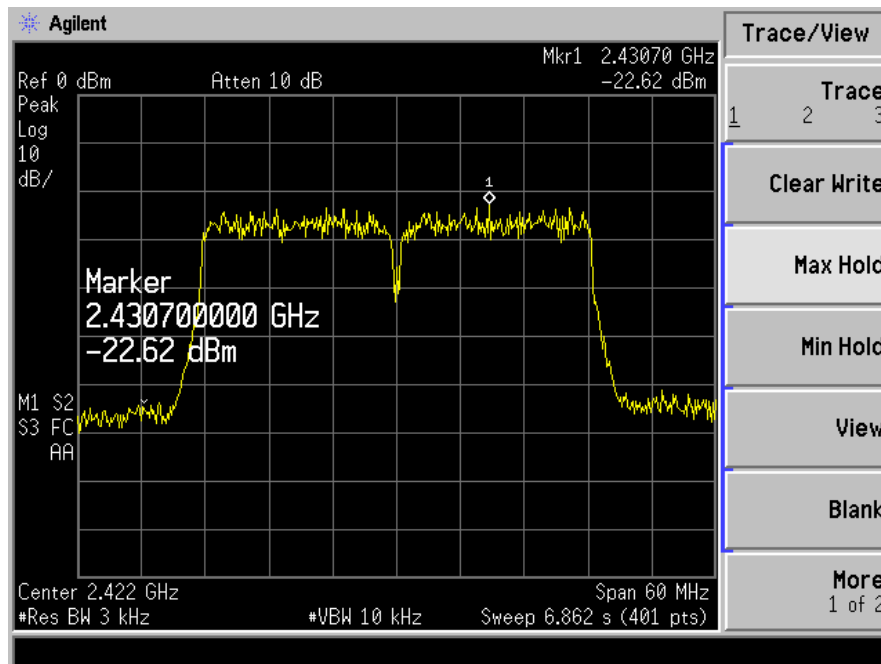

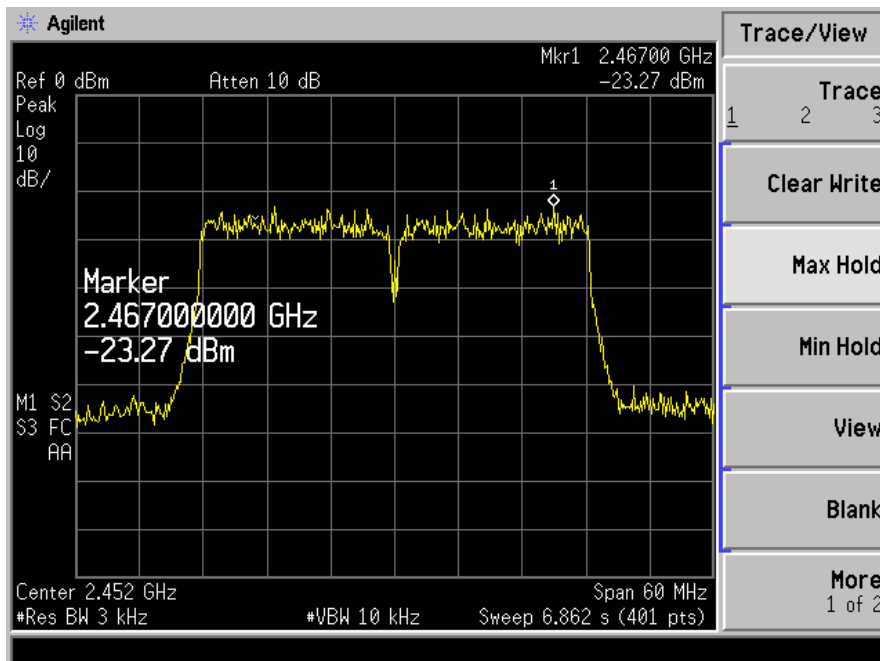
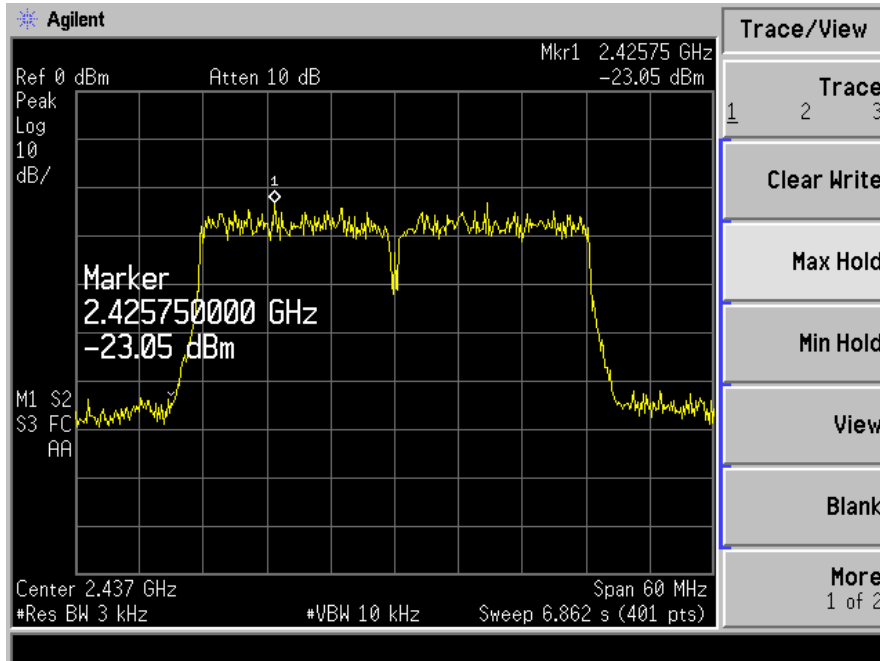

11. Antenna Port Emission

11.1 Test Equipment

EQUIPMENT TYPE	MFR	MODEL NUMBER	SERIAL NUMBER	LAST CAL.	CAL DUE.
Spectrum Analyzer	Agilent	E4407B	88156318	05/29/2012	05/28/2013

11.2 Measuring Instruments and Setting

The following table is the setting of spectrum analyzer.

Spectrum analyzer	Setting
Attenuation	Auto
RB	100kHz
VB	1MHz
Detector	Peak
Trace	Max hold

11.3 Test Procedures

The conducted spurious emissions were measured conducted using a spectrum analyzer at low, Middle, and high channels, the limit was determined by attenuation 20dB of the RF peak power output.

11.4 Block Diagram of Test setup

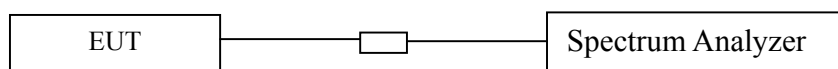

11.5 Test Result

PASS.

802.11b Low Channel 1

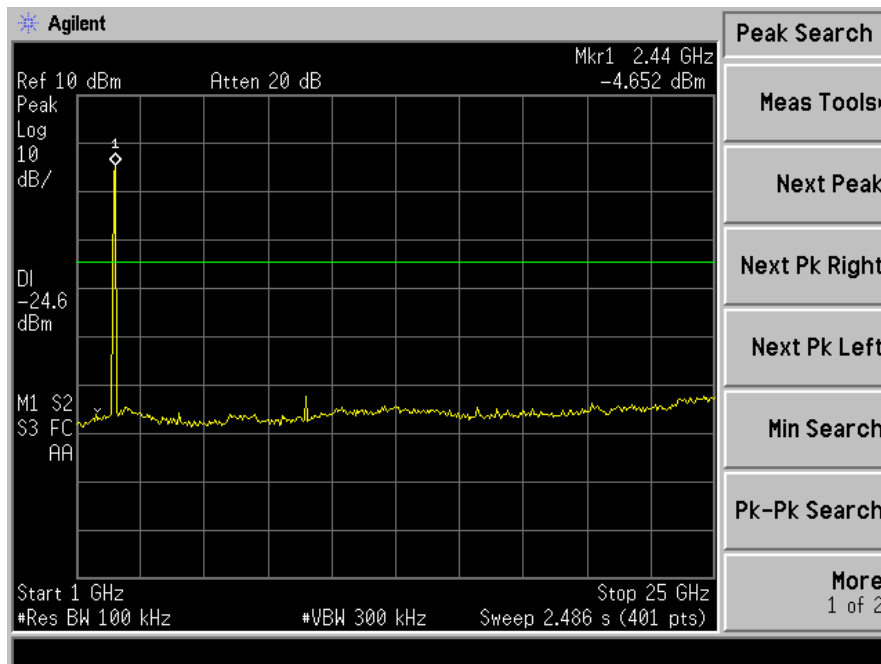
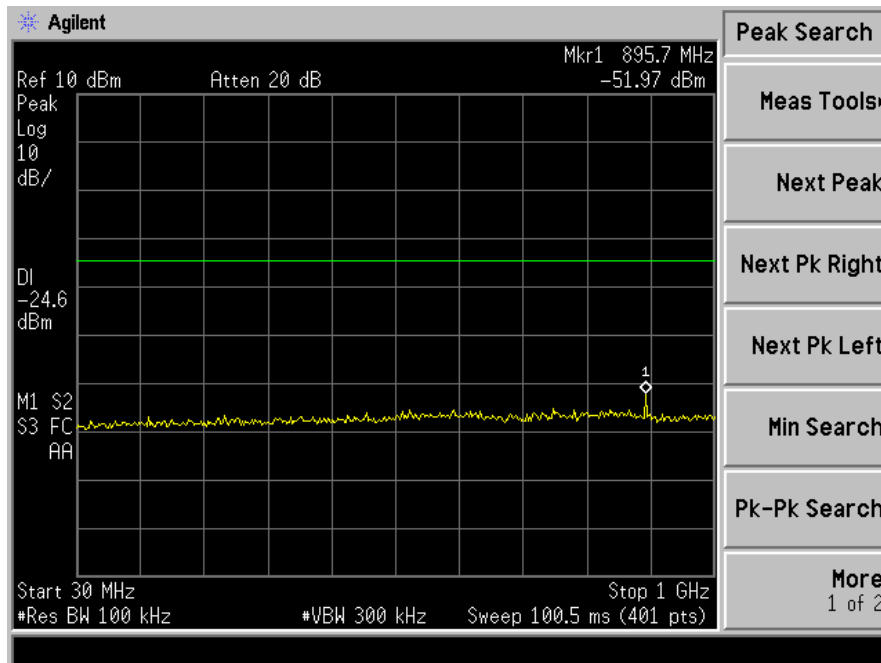

802.11b Mid Channel 6

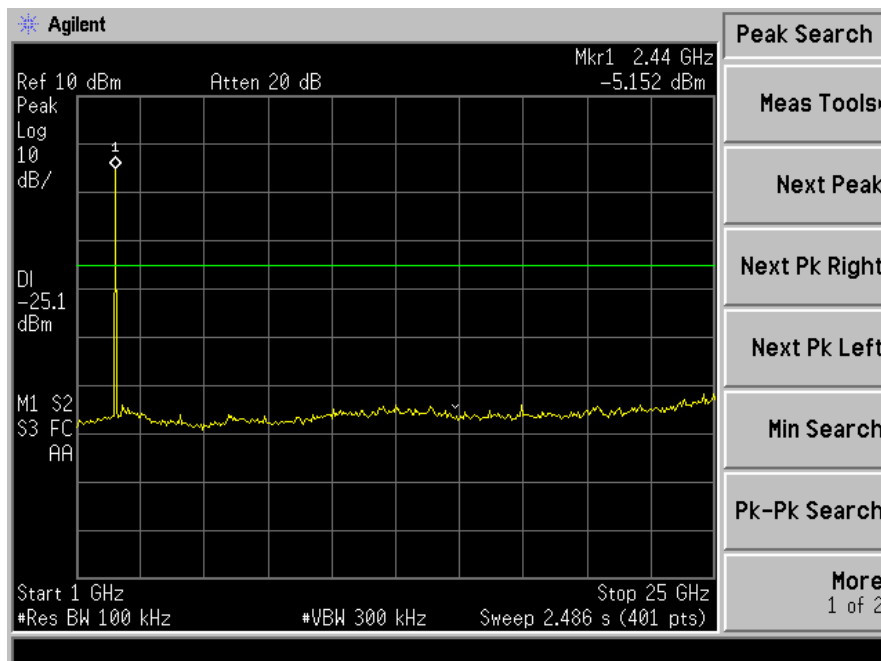
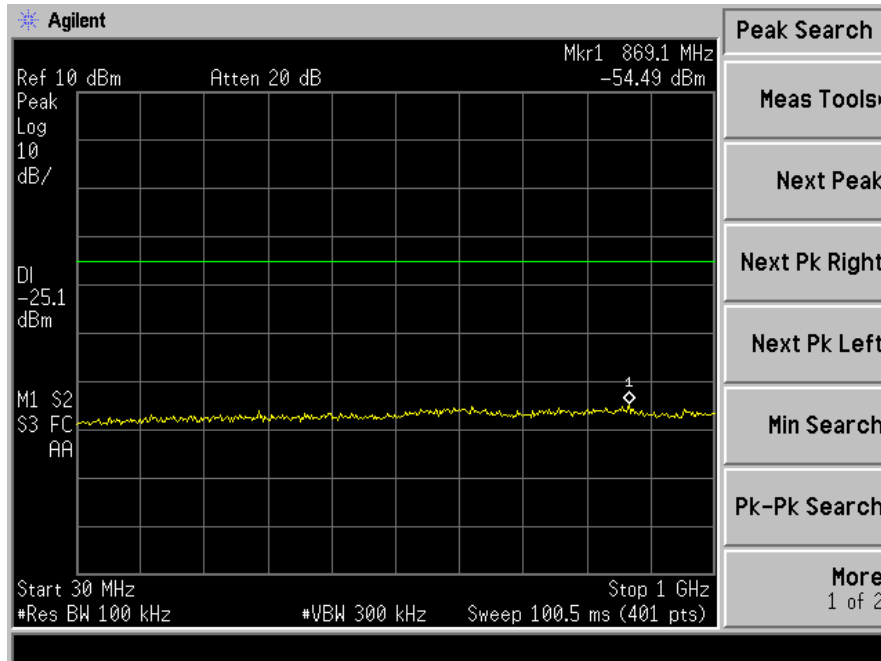

802.11b High Channel 11

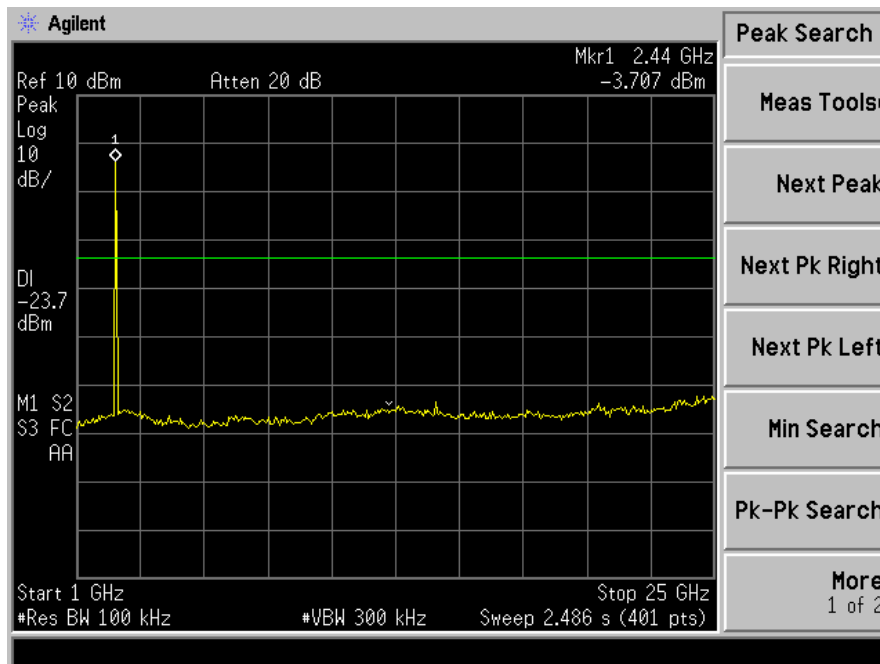
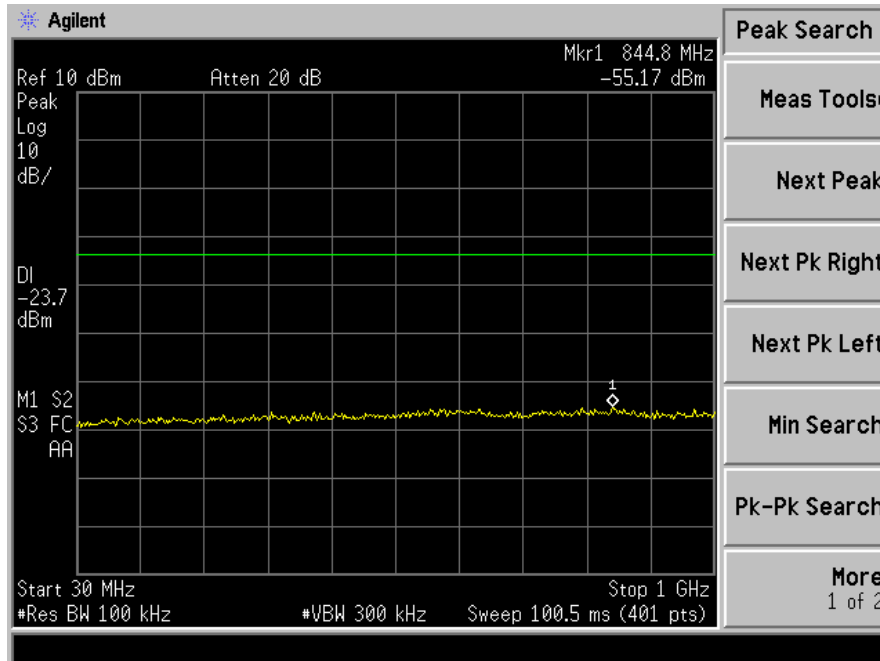

802.11g Low Channel 1

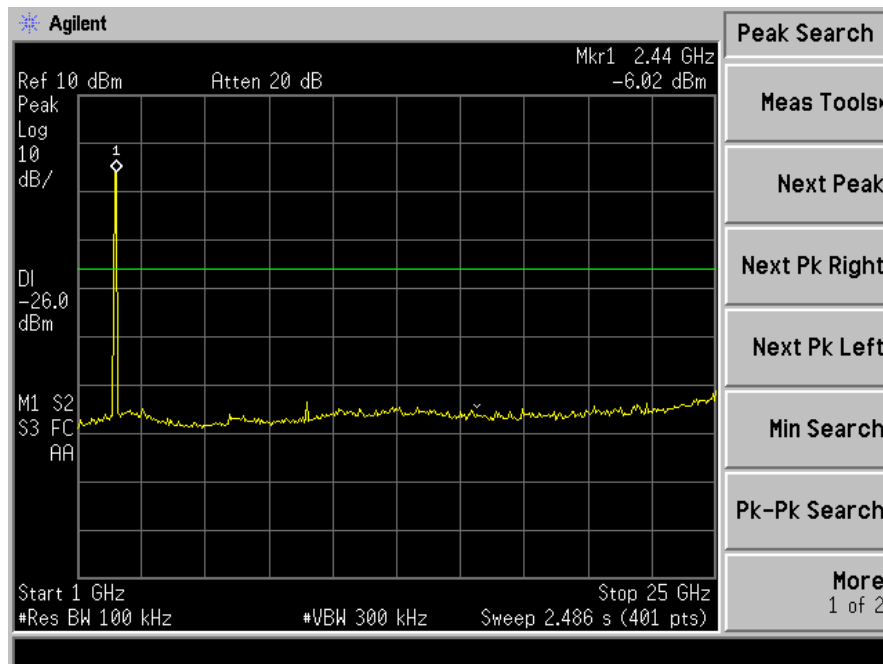
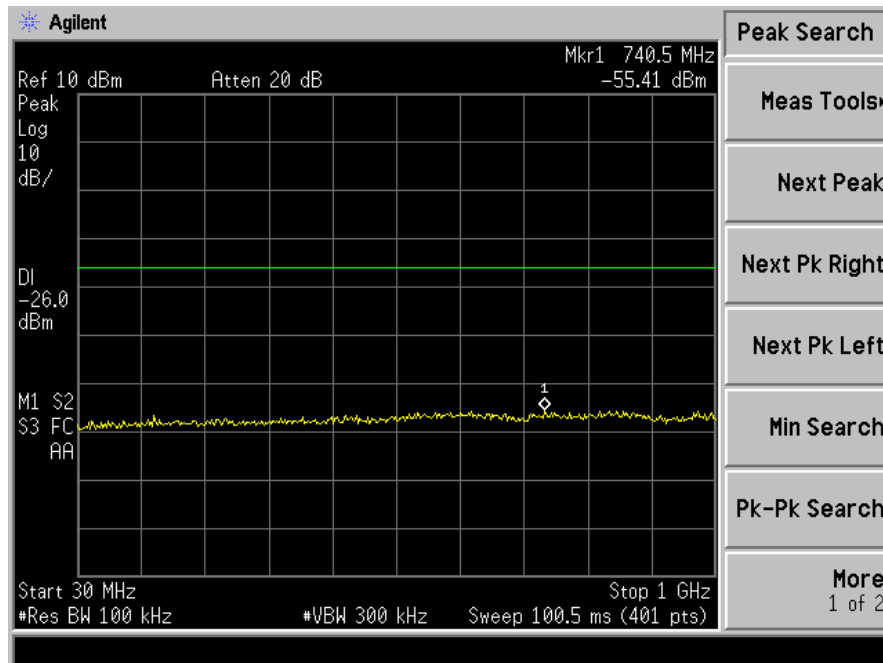

802.11g Mid Channel 6

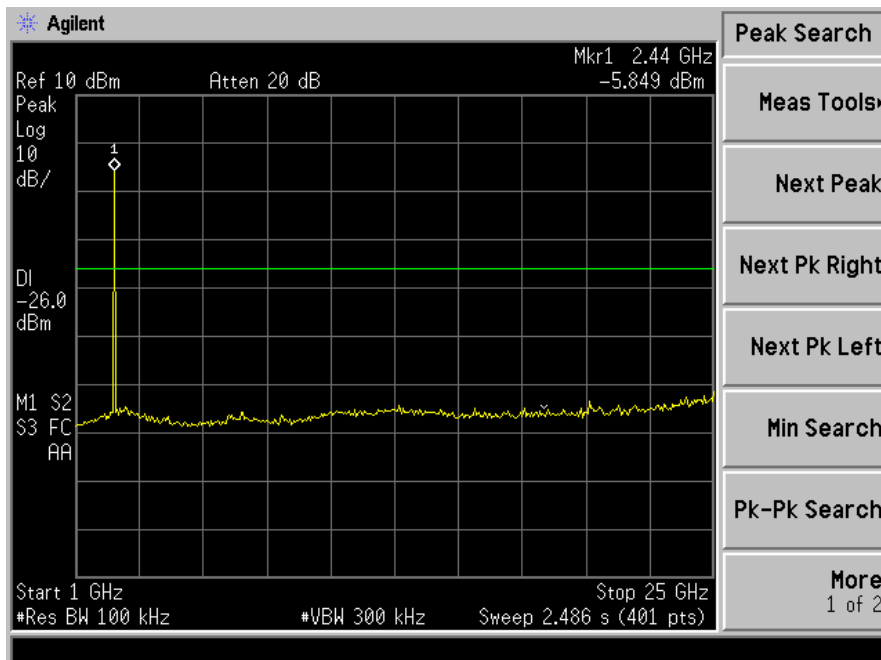
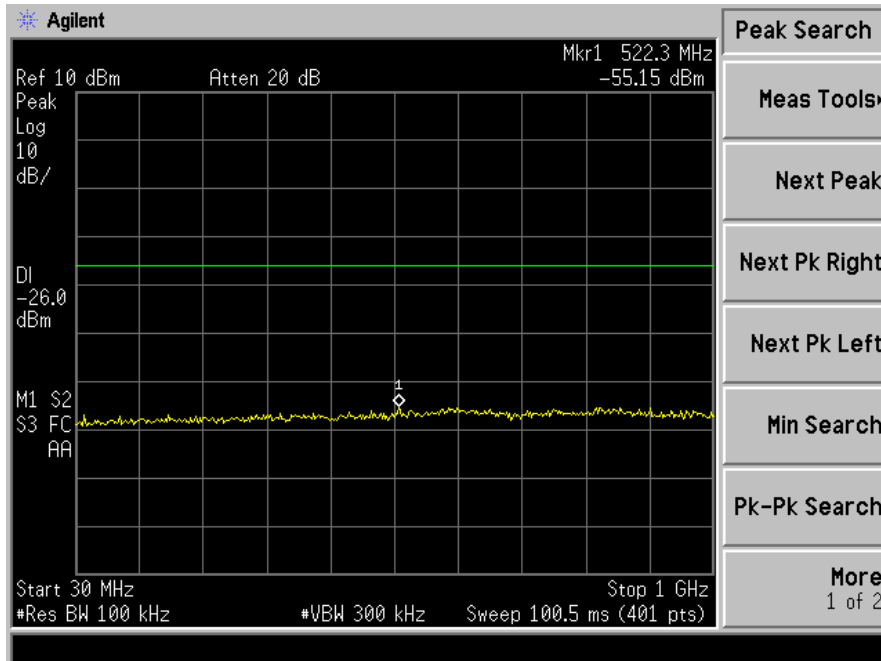

802.11g High Channel 11

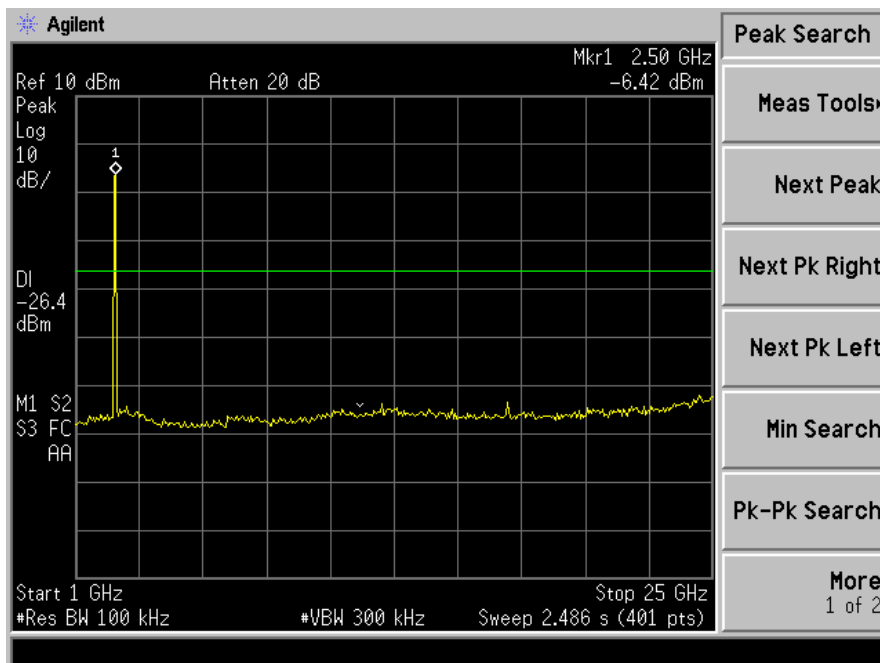
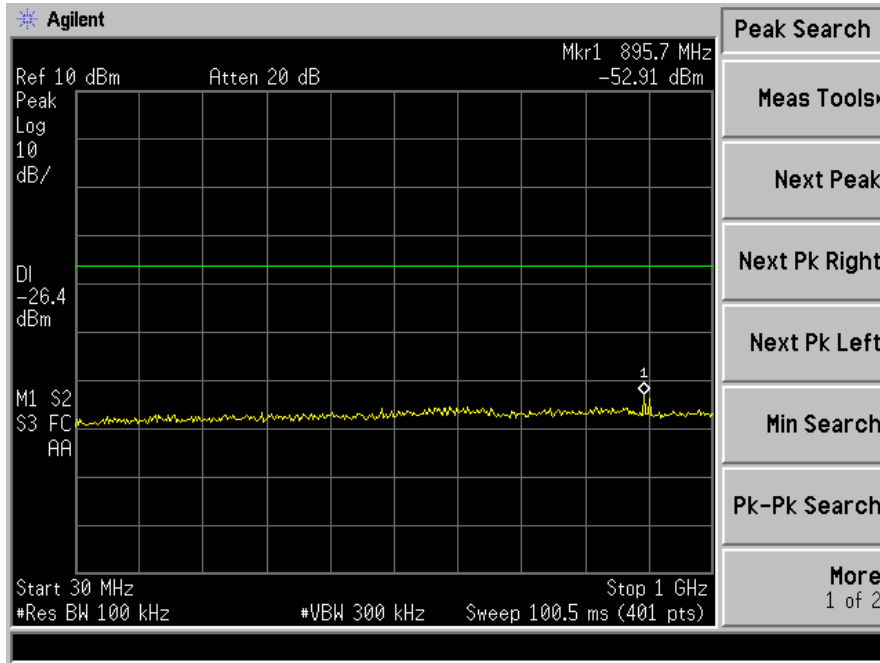

802.11n HT20 Low Channel 1

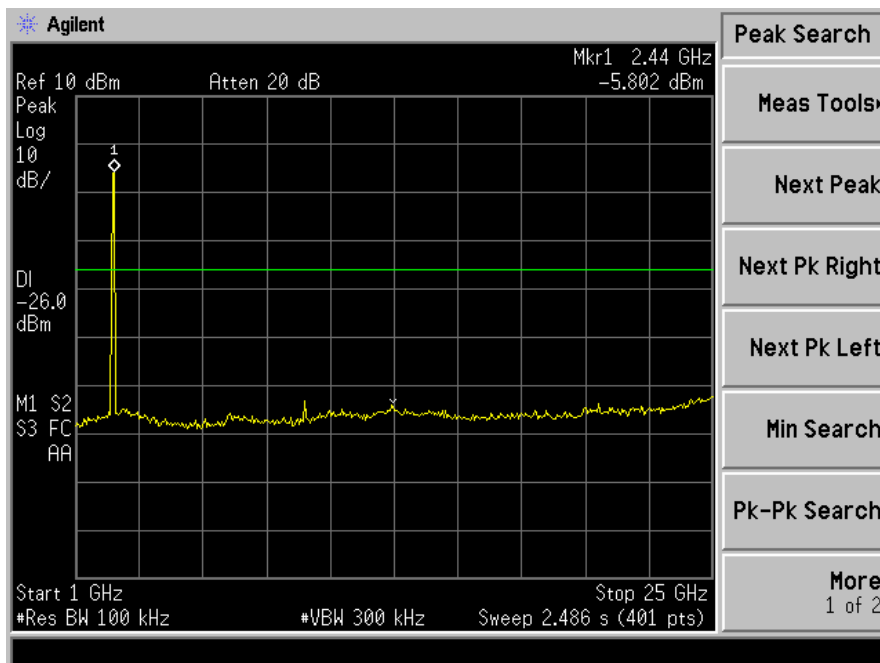
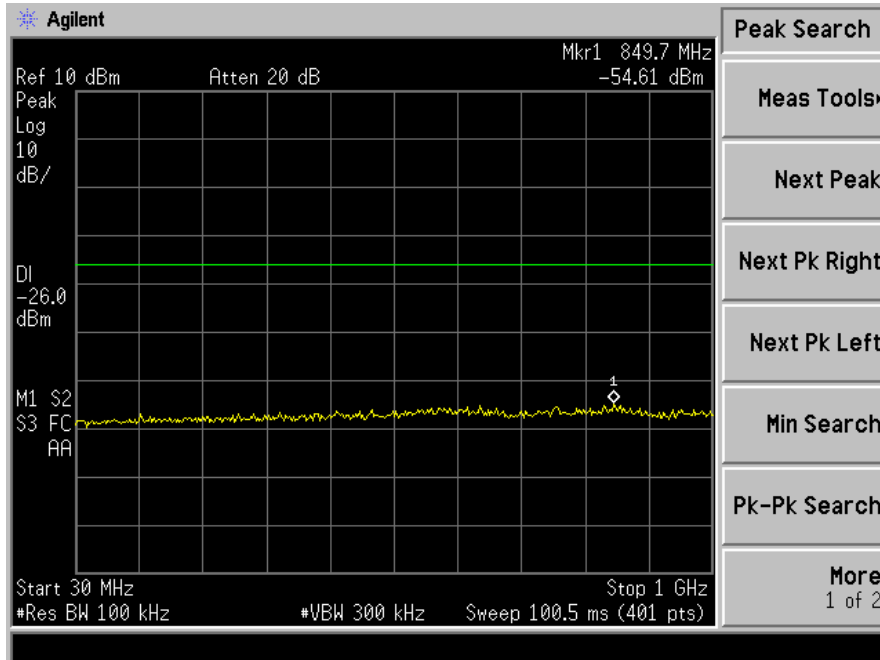

802.11n HT20 Mid Channel 6

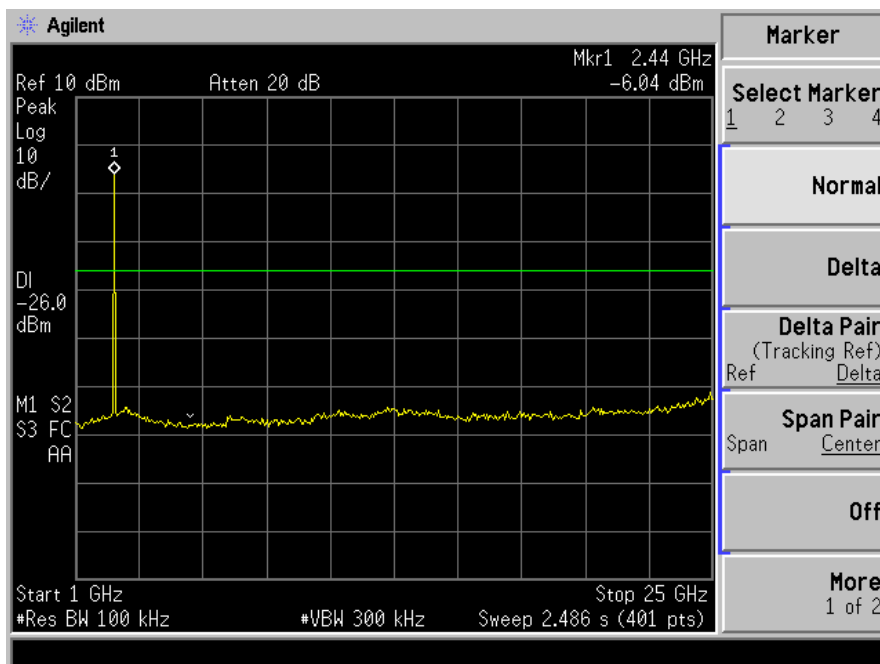
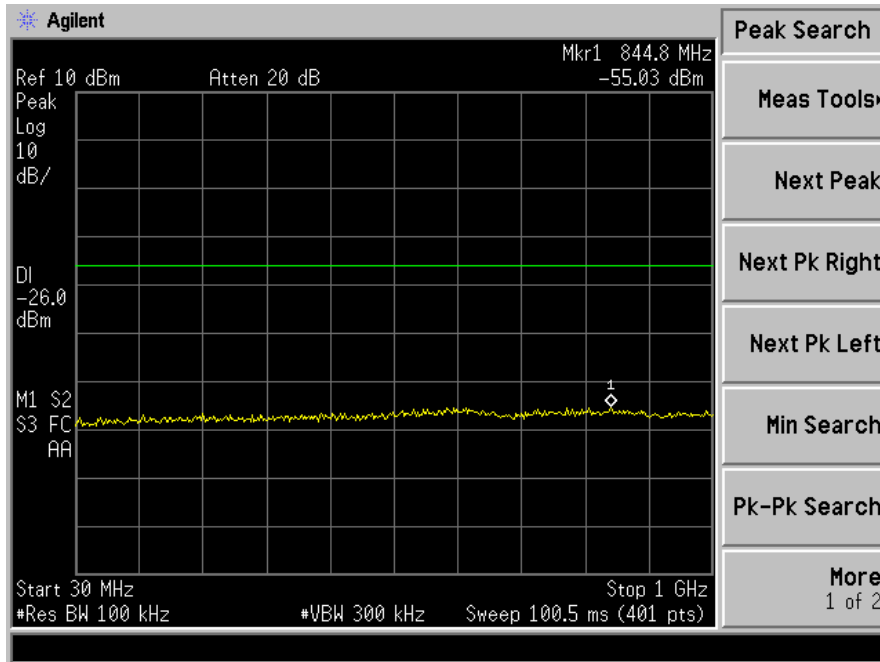

802.11n HT20 High Channel 11

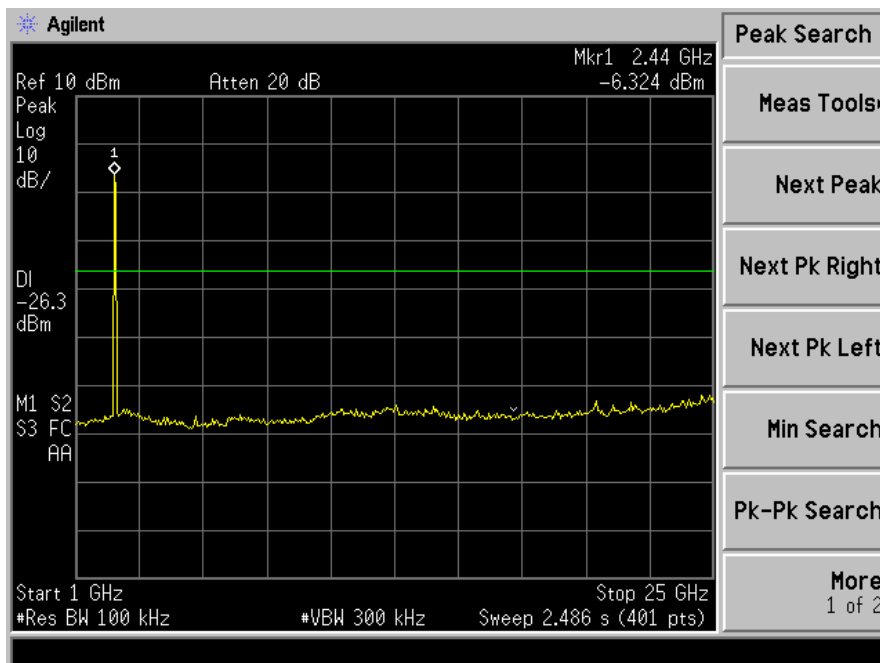
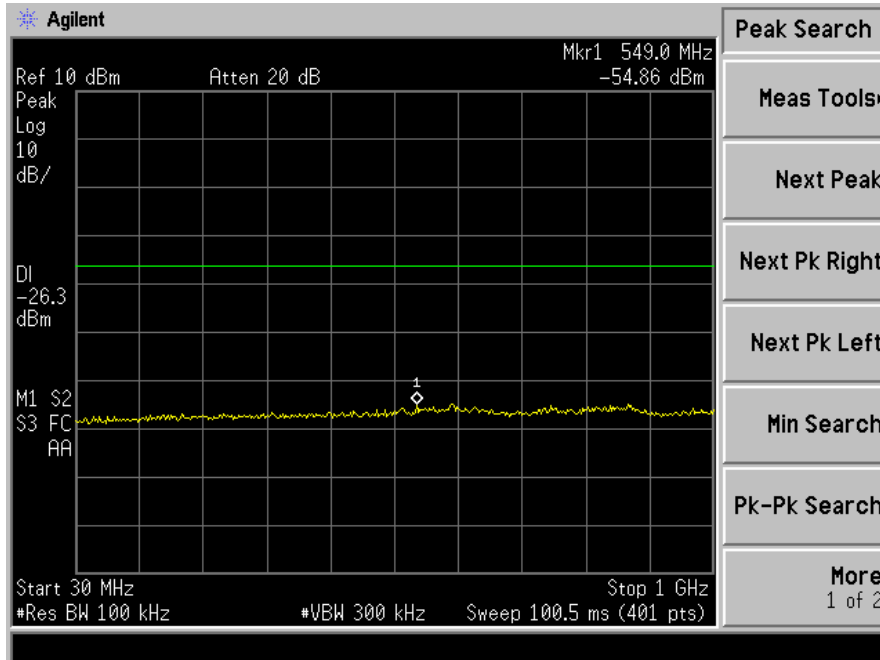

802.11n HT40 Low Channel 3

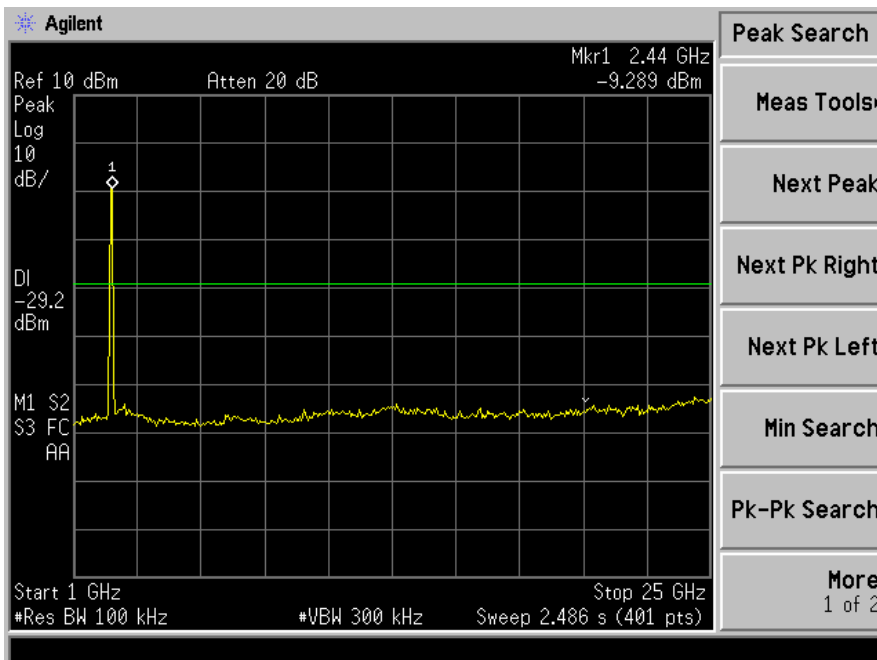
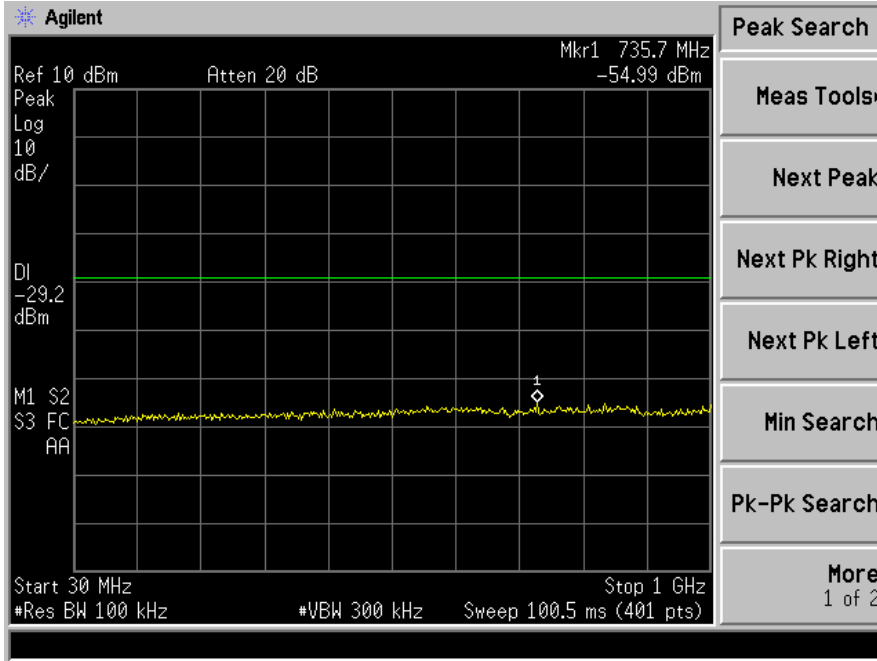

802.11n HT40 Mid Channel 6

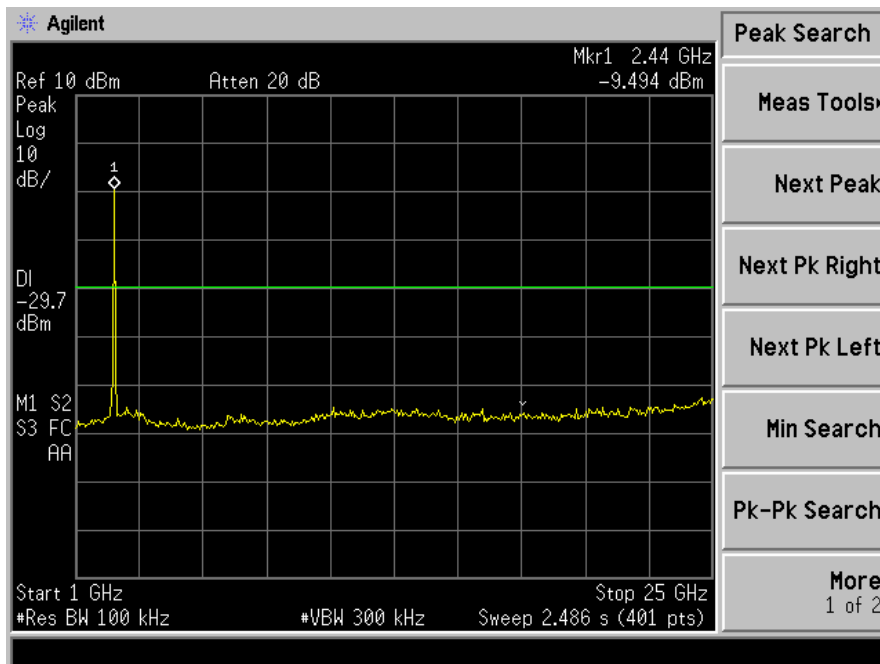
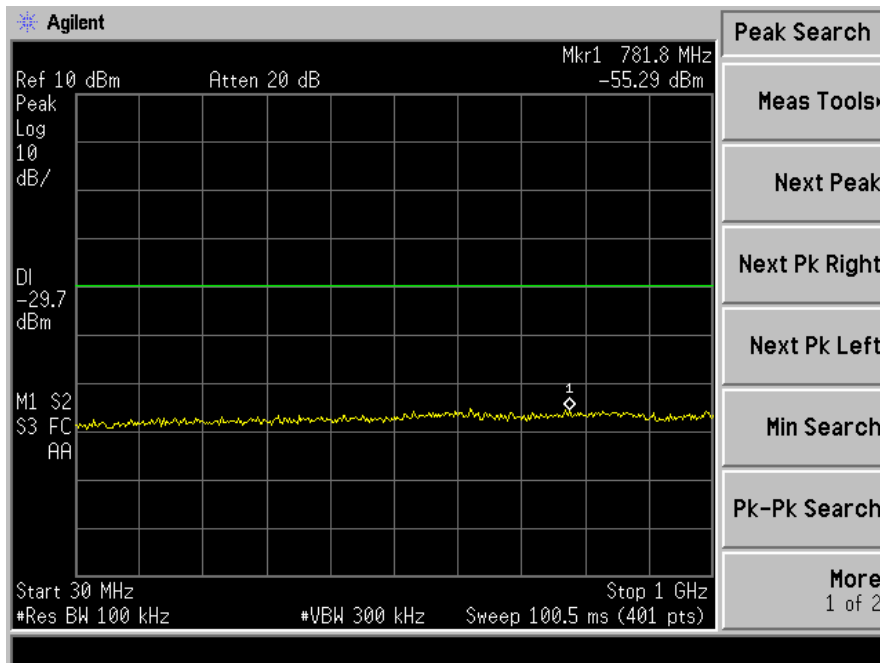

802.11n HT40 High Channel 9

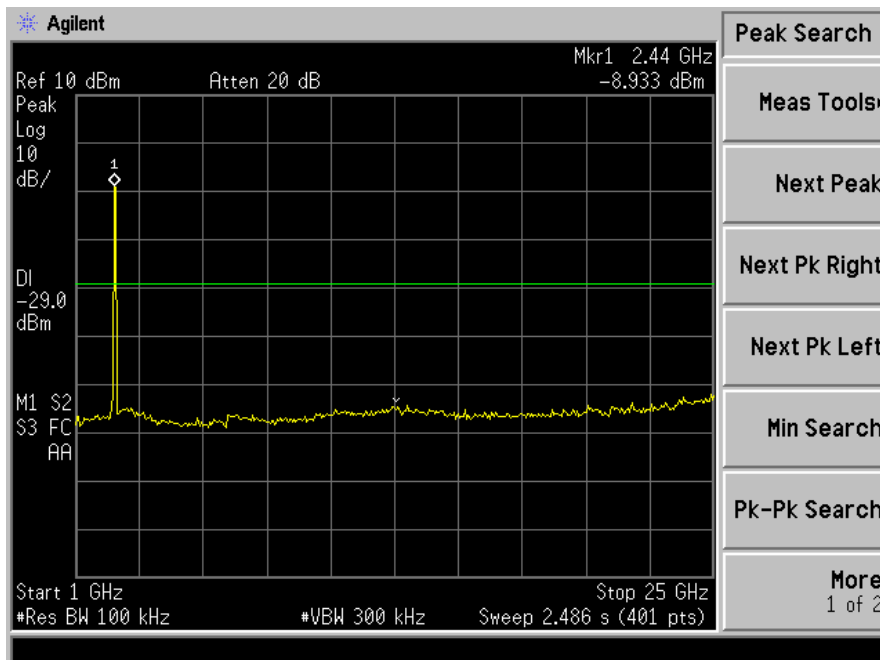
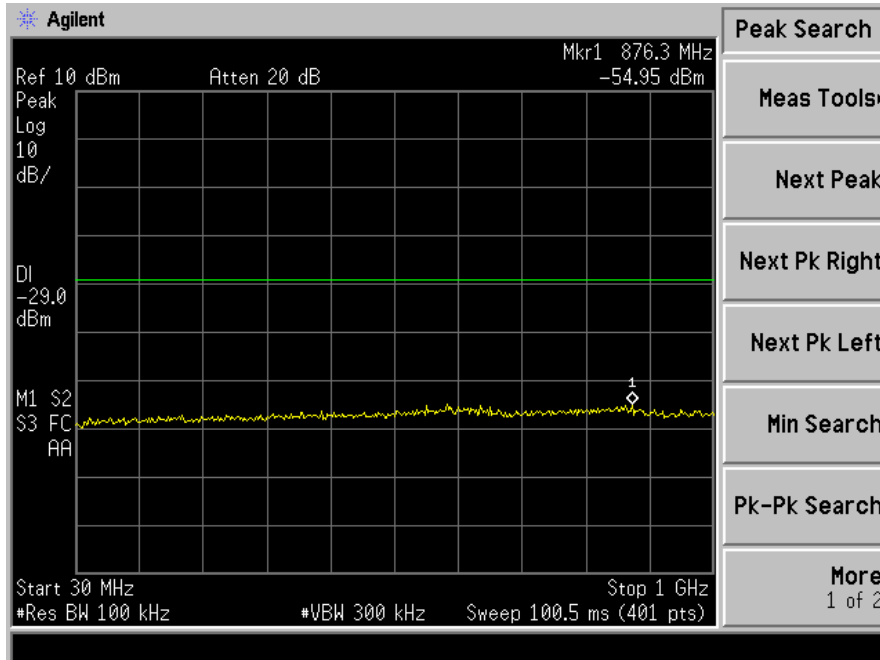

12. Antenna Application

12.1 Antenna Requirement

For intentional device, according to FCC 47 CFR Section 15.203, an intentional radiator shall be designed to ensure that no antenna other than that furnished by the responsible party shall be used with the device. And according to FCC 47 CFR Section 15.247 (b), if transmitting antennas of directional gain greater than 6dBi are used, the power shall be reduced by the amount in dB that the directional gain of the antenna exceeds 6dBi.

12.2 Result

The EUT'S antenna is PCB Antenna. The antenna's gain is 1dBi and meets the requirement.