

**ELECTROMAGNETIC EMISSIONS COMPLIANCE REPORT
INTENTIONAL RADIATOR CERTIFICATION TO
FCC PART 15 SUBPART C REQUIREMENT**

OF

nextbook, Android MID

MODEL No.: Next7S, NXM723HRF, M723HR, M723HC

FCC ID: S7JNEXT7S

REPORT NO: ES120305010F

ISSUE DATE: February 27, 2012

Prepared for

**SHENZHEN YIFANG DIGITAL TECHNOLOGY CO., LTD.
Building NO.22,23, Fifth Region, Baiwangxin Industrial Park, Songbai Rd.,
Nanshan, Shenzhen 518108, China**

Prepared by

SHENZHEN EMTEK CO., LTD.

**Bldg 69, Majialong Industry Zone, Nanshan District,
Shenzhen, Guangdong, China**

TEL: 86-755-26954280

FAX: 86-755-26954282

VERIFICATION OF COMPLIANCE

| | |
|----------------------|---|
| Applicant: | SHENZHEN YIFANG DIGITAL TECHNOLOGY CO., LTD. Building NO.22,23, Fifth Region, Baiwangxin Industrial Park, Songbai Rd., Nanshan, Shenzhen 518108, China |
| Manufacturer: | SHENZHEN YIFANG DIGITAL TECHNOLOGY CO., LTD. Building NO.22,23, Fifth Region, Baiwangxin Industrial Park, Songbai Rd., Nanshan, Shenzhen 518108, China |
| Product Description: | nextbook, Android MID |
| Model Number: | Next7S, NXM723HRF, M723HR, M723HC (Note: all the models are the same, except their model number and appearance. We take Next7S to test.) |
| File Number: | ES120305010F |
| Date of Test: | February 18, 2012 to February 25, 2012 |

We hereby certify that:

The above equipment was tested by SHENZHEN EMTEK CO., LTD. The test data, data evaluation, test procedures, and equipment configurations shown in this report were made in accordance with the procedures given in ANSI C63.4 (2009) and the energy emitted by the sample EUT tested as described in this report is in compliance with conducted and radiated emission limits of FCC Rules Part 15.247.

The test results of this report relate only to the tested sample identified in this report.

Date of Test : February 18, 2012 to February 25, 2012

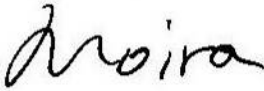
Prepared by : 
(Engineer)

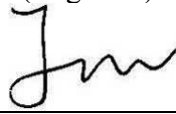
Reviewer : 
(Quality Manager)

Approve & Authorized Signer : 
(Manager)

Table of Contents

| | |
|---|-----------|
| 1. GENERAL INFORMATION..... | 5 |
| 1.1 PRODUCT DESCRIPTION..... | 5 |
| 1.2 RELATED SUBMITTAL(S) / GRANT(S)..... | 5 |
| 1.3 TEST METHODOLOGY..... | 6 |
| 1.4 SPECIAL ACCESSORIES | 6 |
| 1.5 EQUIPMENT MODIFICATIONS | 6 |
| 1.6 TEST FACILITY | 6 |
| 2. SYSTEM TEST CONFIGURATION..... | 7 |
| 2.1 EUT CONFIGURATION | 7 |
| 2.2 EUT EXERCISE..... | 7 |
| 2.3 TEST PROCEDURE..... | 7 |
| 2.4 CONFIGURATION OF TESTED SYSTEM..... | 7 |
| 3. DESCRIPTION OF TEST MODES..... | 9 |
| 4. SUMMARY OF TEST RESULTS | 10 |
| 5. CONDUCTED EMISSIONS TEST..... | 11 |
| 5.1 MEASUREMENT PROCEDURE..... | 11 |
| 5.2 TEST SET-UP (BLOCK DIAGRAM OF CONFIGURATION)..... | 11 |
| 5.3 MEASUREMENT EQUIPMENT USED..... | 11 |
| 5.4 CONDUCTED EMISSION LIMIT | 11 |
| 5.5 MEASUREMENT RESULT | 12 |
| 5.6 CONDUCTED MEASUREMENT PHOTO | 13 |
| 6. RADIATED EMISSION TEST..... | 14 |
| 6.1 MEASUREMENT PROCEDURE..... | 14 |
| 6.2 TEST SET-UP (BLOCK DIAGRAM OF CONFIGURATION)..... | 14 |
| 6.3 MEASUREMENT EQUIPMENT USED..... | 15 |
| 6.4 RADIATED EMISSION LIMIT | 15 |
| 6.5 MEASUREMENT RESULT | 17 |
| 6.6 RADIATED MEASUREMENT PHOTOS | 35 |
| 7. OCCUPIED BANDWIDTH TEST..... | 37 |
| 7.1 MEASUREMENT PROCEDURE..... | 37 |
| 7.2 TEST SET-UP (BLOCK DIAGRAM OF CONFIGURATION)..... | 37 |
| 7.3 MEASUREMENT EQUIPMENT USED..... | 37 |
| 7.4 MEASUREMENT RESULTS | 37 |
| 8. MAXIMUM PEAK OUTPUT POWER TEST | 44 |
| 8.1 MEASUREMENT PROCEDURE..... | 44 |
| 8.2 TEST SET-UP (BLOCK DIAGRAM OF CONFIGURATION)..... | 44 |
| 8.3 MEASUREMENT EQUIPMENT USED..... | 44 |
| 8.4 PEAK POWER OUTPUT LIMIT | 44 |
| 8.5 MEASUREMENT RESULTS | 44 |

| | |
|---|-----------|
| 9. BAND EDGE TEST | 46 |
| 9.1 MEASUREMENT PROCEDURE | 46 |
| 9.2 TEST SET-UP (BLOCK DIAGRAM OF CONFIGURATION)..... | 46 |
| 9.3 MEASUREMENT EQUIPMENT USED..... | 46 |
| 9.4 MEASUREMENT RESULTS | 46 |
| 10. POWER DENSITY | 48 |
| 10.1 TEST EQUIPMENT | 48 |
| 10.2 MEASURING INSTRUMENTS AND SETTING | 48 |
| 10.3 TEST PROCEDURES | 48 |
| 10.4 BLOCK DIAGRAM OF TEST SETUP | 48 |
| 10.5 LIMIT | 48 |
| 10.6 TEST RESULT | 49 |
| 11. ANTENNA PORT EMISSION..... | 55 |
| 11.1 TEST EQUIPMENT | 55 |
| 11.2 MEASURING INSTRUMENTS AND SETTING | 55 |
| 11.3 TEST PROCEDURES | 55 |
| 11.4 BLOCK DIAGRAM OF TEST SETUP | 55 |
| 11.5 TEST RESULT | 55 |
| 12. ANTENNA APPLICATION | 58 |
| 12.1 ANTENNA REQUIREMENT | 58 |
| 12.2 RESULT..... | 58 |

1. General Information

1.1 Product Description

A major technical descriptions of EUT is described as following:

- A). Standards: IEEE802.11b/g/n
- B). Operation Frequency: 802.11b/g/n: 2412-2462MHz;
- C). Modulation: OFDM with BPSK/QPSK/16QAM/64QAM for 802.11g/n,
DSSS with DBPSK/DQPSK/CCK for 802.11b
- D). Number of Channel: 802.11b/g/n(HT20): 11Channels;
- E). Support Data Rate: 1, 2, 5.5, 11, 6, 9, 12, 24, 36, 48, 54 Mbps
- F). Conducted Power: 12.62dBm(802.11b), 11.35dBm(802.11g), 10.77dBm(802.11n)
- G) Antenna Gain: 0dBi
- H). Antenna Type: PCB Antenna
- I). Power Supply: DC 5V with AC Adapter and DC 3.7V from Li-ion Battery
- J). Adapter: Input: AC 100-240V, 50/60Hz
Output: DC 5V, 2A

| Channel | Frequency (MHz) | Channel | Frequency (MHz) | Channel | Frequency (MHz) |
|---------|-----------------|---------|-----------------|---------|-----------------|
| 1 | 2412 | 5 | 2432 | 9 | 2452 |
| 2 | 2417 | 6 | 2437 | 10 | 2457 |
| 3 | 2422 | 7 | 2442 | 11 | 2462 |
| 4 | 2427 | 8 | 2447 | | |

Note:

1. This device is nextbook, Android MID included 802.11b, 802.11g and 802.11n 2.4GHz transceiver function.
2. Test of channel was included the lowest middle and highest frequency in lowest data rate and to perform the test, then record on this report.

1.2 Related Submittal(s) / Grant(s)

This submittal(s) (test report) is intended for FCC ID: S7JNEXT7S filing to comply with Section 15.247 of the FCC Part 15, Subpart C Rules. The EUT is compliance with Subpart B is authorized under a DOC procedure.

1.3 Test Methodology

Both conducted and radiated testing were performed according to the procedures in ANSI C63.4 (2009). Radiated testing was performed at an antenna to EUT distance 3 meters.

1.4 Special Accessories

Not available for this EUT intended for grant.

1.5 Equipment Modifications

Not available for this EUT intended for grant.

1.6 Test Facility

Site Description

EMC Lab.

: Accredited by CNAS, 2010.10.29
The certificate is valid until 2013.10.28
The Laboratory has been assessed and proved to be in compliance with CNAS/CL01: 2006(identical to ISO/IEC17025: 2005)
The Certificate Registration Number is L2291

Accredited by TUV Rheinland Shenzhen 2010.5.25
The Laboratory has been assessed according to the requirements ISO/IEC 17025

Accredited by FCC, October 28, 2010
The Certificate Registration Number is 406365.

Accredited by Industry Canada, March 05, 2010
The Certificate Registration Number is 46405-4480.

Name of Firm

: SHENZHEN EMTEK CO., LTD.

Site Location

: Bldg 69, Majialong Industry Zone,
Nanshan District, Shenzhen, Guangdong, China

2. System Test Configuration

2.1 EUT Configuration

The EUT configuration for testing is installed on RF field strength measurement to meet the Commissions requirement and operating in a manner which intends to maximize its emission characteristics in a continuous normal application.

2.2 EUT Exercise

The Transmitter was operated in the normal operating mode. the Tx frequency was fixed which was for the purpose of the measurements.

2.3 Test Procedure

2.3.1 Conducted Emissions

The EUT is a placed on as turn table which is 0.8 m above ground plane. According to the requirements in Section 13.1.4.1 of ANSI C63.4-2009 Conducted emissions from the EUT measured in the frequency range between 0.15 MHz and 30 MHz using CISPR Quasi-Peak and average detector mode.

2.3.2 Radiated Emissions

The EUT is a placed on as turn table which is 0.8 m above ground plane. The turn table shall rotate 360 degrees to determine the position of maximum emission level. EUT is set 3m away from the receiving antenna which varied from 1m to 4m to find out the highest emission. And also, each emission was to be maximized by changing the polarization of receiving antenna both horizontal and vertical. In order to find out the max. emission, the relative positions of this hand-held transmitter(EUT) was rotated through three orthogonal axes according to the requirements in Section 13.1.4.1 of ANSI C63.4-2009.

2.4 Configuration of Tested System

Fig. 2-1 Configuration of Tested System

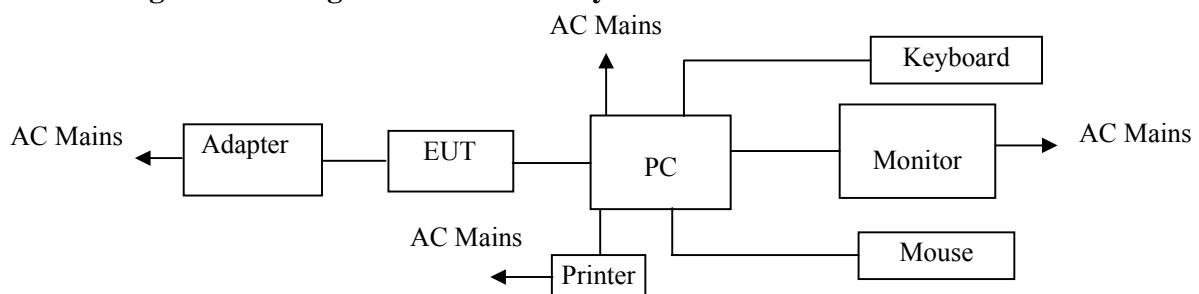

Table 2-1 Equipment Used in Tested System

| Item | Equipment | Mfr/Brand | Model/Type No. | FCC ID | Series No. | Note |
|------|--------------------------|-----------|----------------|-----------|-----------------|------|
| 1. | nextbook, Android MID | N/A | Next7S | S7JNEXT7S | N/A | EUT |
| 2. | Earphone | Yifang | N/A | N/A | N/A | |
| 3. | LCD Monitor | LENOVO | 9227-AE6 | N/A | 4M0293084302824 | |
| 4. | Keyboard | LENOVO | KU-0225 | N/A | 0585494 | |
| 5. | Mouse | LENOVO | MO28UOL | N/A | 44D2639 | |
| 6. | PC | LENOVO | 9702 | N/A | L3C4410 | |
| 7. | Printer | HP | C89520 | N/A | CN25S182N6 | |
| 8. | LED Monitor | PHILIPS | 224EL2 | N/A | DLAA1111431625 | |

Note:

- (1) Unless otherwise denoted as EUT in 『Remark』 column, device(s) used in tested system is a support equipment.

3. Description of Test Modes

The Transmitter of EUT is a nextbook, Android MID and powered by host equipment. This is Digital Transmission system(DTS) and have modulation OFDM, DSSS, DBPSK, DQPSK, CCK, 16QAM, 64QAM. According exploratory test, EUT will have maximum output power in those data rate(802.11b: 1 Mbps; 802.11g: 6 Mbps; 802.11n: MCS0), so those data rate were used for all test.

The equipment enables high-speed access without wires to network assets. This adapter uses the IEEE 802.11 protocol to enable wireless communications between the host and Wireless router.

For 802.11b/g/n:

1. For lowest channel : 2412MHz (Channel 1)
2. For middle channel : 2437MHz (Channel 6)
3. For highest channel: 2462MHz (Channel 11)

EUT operating conditions:

The EUT exercise program used during conducted testing was designed to exercise the EUT in a manner similar to typical use, the exercise sequence is listed as below:

1. Setup the EUT and simulators as shown on 2.4.
2. Turn on the power of all equipments.
3. The EUT Ping with the wireless router.
4. Repeat the above steps.

4. Summary of Test Results

| FCC Rules | Description Of Test | Result |
|---------------------|-----------------------------|---------------|
| §15.247(a)(2) | 6dB bandwidth | Compliant |
| §15.247(b)(3) | Max Peak output Power test | Compliant |
| §15.247(e) | Power density | Compliant |
| §15.247(d) | Band edge test | Compliant |
| §15.207 | AC Power Conducted Emission | Compliant |
| §15.247(d), §15.209 | Radiated Emission | Compliant |
| §15.247(d) | Antenna Port Emission | Compliant |
| §15.247(b)&§15.203 | Antenna Application | Compliant |

5. Conducted Emissions Test

5.1 Measurement Procedure

1. The EUT was placed on a table which is 0.8m above ground plane.
2. Maximum procedure was performed on the six highest emissions to ensure EUT compliance.
3. Repeat above procedures until all frequency measured were complete.

5.2 Test SET-UP (Block Diagram of Configuration)

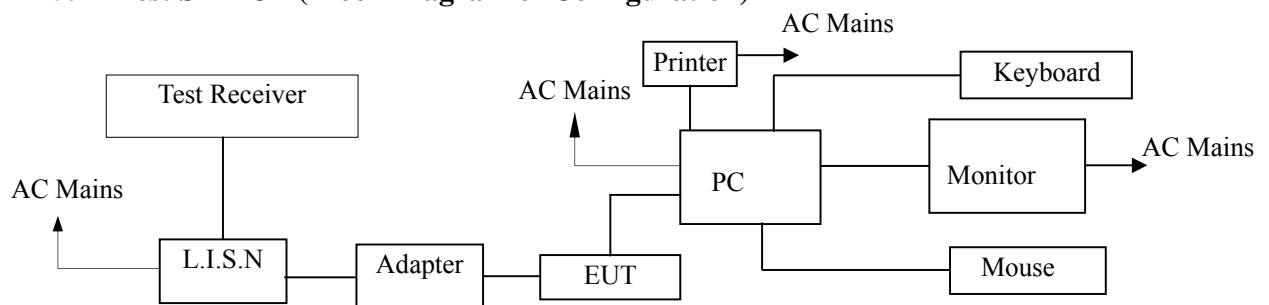

5.3 Measurement Equipment Used

| Conducted Emission Test Site | | | | | |
|------------------------------|-----------------|--------------|---------------|------------|------------|
| EQUIPMENT TYPE | MFR | MODEL NUMBER | SERIAL NUMBER | LAST CAL. | CAL DUE. |
| Test Receiver | Rohde & Schwarz | ESCS30 | 828985/018 | 05/29/2011 | 05/29/2012 |
| L.I.S.N. | Schwarzbeck | NNLK8129 | 8129203 | 05/29/2011 | 05/29/2012 |
| 50Ω Coaxial Switch | Anritsu | MP59B | M20531 | N/A | N/A |
| Pulse Limiter | Rohde & Schwarz | ESH3-Z2 | 100006 | 05/29/2011 | 05/29/2012 |
| Voltage Probe | Rohde & Schwarz | TK9416 | N/A | 05/29/2011 | 05/29/2012 |
| I.S.N | Rohde & Schwarz | ENY22 | 1109.9508.02 | 05/29/2011 | 05/29/2012 |

5.4 Conducted Emission Limit

| Conducted Emission Frequency(MHz) | Quasi-peak | Average |
|-----------------------------------|------------|---------|
| 0.15-0.5 | 66-56 | 56-46 |
| 0.5-5.0 | 56 | 46 |
| 5.0-30.0 | 60 | 50 |

- Note:**
1. The lower limit shall apply at the transition frequencies
 2. The limit decreases in line with the logarithm of the frequency in the range of 0.15 to 0.50MHz.

5.5 Measurement Result

Date of Test: February 23, 2012 Temperature: 22°C
 Frequency Detector: 0.15~30MHz Humidity: 50%
 Test Result: PASS Test Mode: WIFI Mode

| Test Line | Frequency MHz | Emission Level QP dB(μV) | Emission Level AV dB(μV) | Limits QP dB(μV) | Limits AV dB(μV) | Over QP dB(μV) | Over AV dB(μV) |
|-----------|---------------|--------------------------|--------------------------|------------------|------------------|----------------|----------------|
| Line | 0.160 | 50.330 | 34.450 | 65.460 | 55.46 | -15.13 | -21.01 |
| | 0.240 | 44.110 | 35.390 | 62.100 | 52.10 | -17.99 | -16.71 |
| | 0.280 | 44.830 | 33.680 | 60.820 | 50.82 | -15.99 | -17.14 |
| | 0.360 | 42.030 | 34.180 | 58.730 | 48.73 | -16.70 | -14.55 |
| | 0.480 | 41.280 | 32.880 | 56.340 | 46.34 | -15.06 | -13.46 |
| | 0.640 | 40.450 | 30.960 | 56.000 | 46.00 | -15.55 | -15.04 |
| Neutral | 0.280 | 43.310 | 36.890 | 60.820 | 50.82 | -17.51 | -13.93 |
| | 0.320 | 37.620 | 33.370 | 59.710 | 49.71 | -22.09 | -16.34 |
| | 0.400 | 39.560 | 31.430 | 57.850 | 47.85 | -18.29 | -16.42 |
| | 0.480 | 38.520 | 31.440 | 56.340 | 46.34 | -17.82 | -14.90 |
| | 0.520 | 38.790 | 30.070 | 56.000 | 46.00 | -17.21 | -15.93 |
| | 0.680 | 36.300 | 29.390 | 56.000 | 46.00 | -19.70 | -16.61 |

5.6 Conducted Measurement Photo



6. Radiated Emission Test

6.1 Measurement Procedure

1. The EUT was placed on a turn table which is 0.8m above ground plane.
2. Maximum procedure was performed on the six highest emissions to ensure EUT compliance.
3. And also, each emission was to be maximized by changing the polarization of receiving antenna both horizontal and vertical.
4. Repeat above procedures until all frequency measured were complete.

For emissions measurement set the bandwidth of the Spectrum's RBW at 1MHz above 1GHz and RBW 100KHz below 1GHz .

6.2 Test SET-UP (Block Diagram of Configuration)

(A) Radiated Emission Test Set-Up, Frequency Below 30MHz

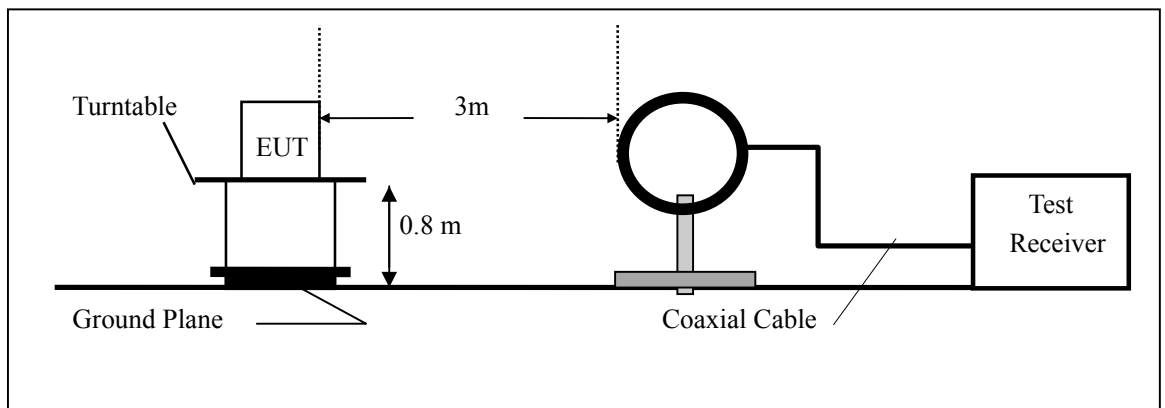

(B) Radiated Emission Test Set-Up, Frequency Below 1000MHz

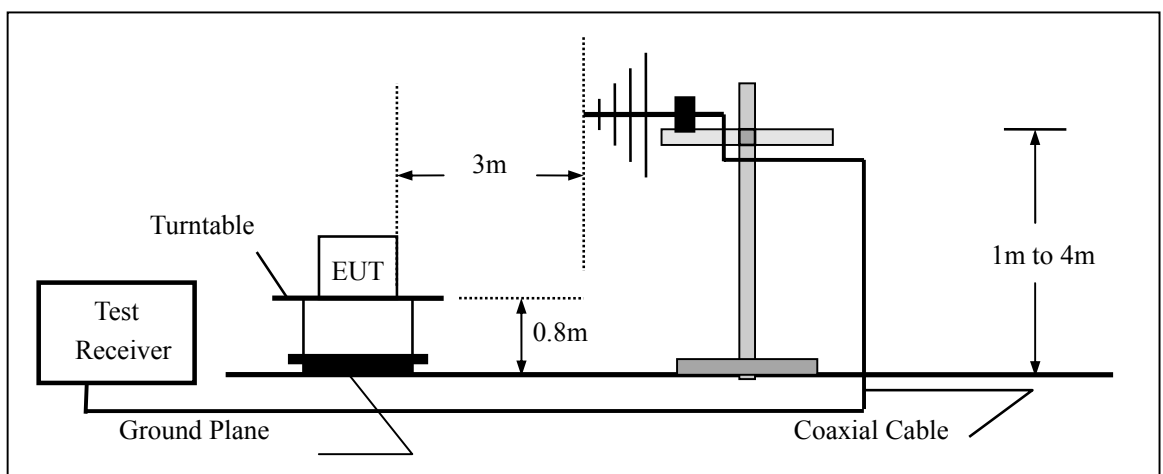

(C) Radiated Emission Test Set-Up, Frequency above 1000MHz

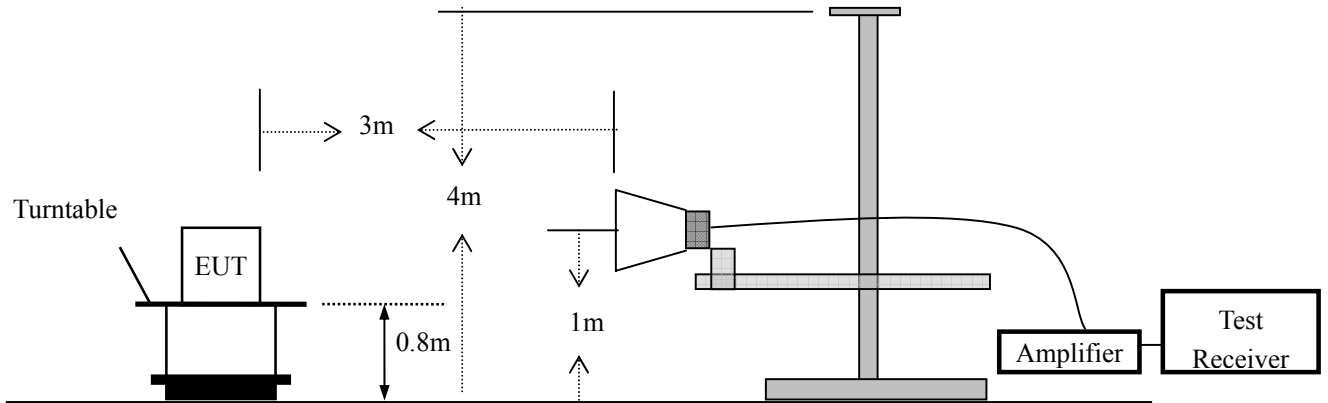

6.3 Measurement Equipment Used

| EQUIPMENT TYPE | MFR | MODEL NUMBER | SERIAL NUMBER | LAST CAL. | CAL DUE. |
|-------------------|-----------------|--------------|---------------|------------|------------|
| EMI Test Receiver | Rohde & Schwarz | ESU | 1302.6005.26 | 05/29/2011 | 05/29/2012 |
| Pre-Amplifier | HP | 8447D | 2944A07999 | 05/29/2011 | 05/29/2012 |
| Bilog Antenna | Schwarzbeck | VULB9163 | 142 | 05/29/2011 | 05/29/2012 |
| Loop Antenna | ARA | PLA-1030/B | 1029 | 05/29/2011 | 05/29/2012 |
| Horn Antenna | Schwarzbeck | BBHA 9170 | BBHA9170399 | 05/29/2011 | 05/29/2012 |
| Horn Antenna | Schwarzbeck | BBHA 9120 | D143 | 05/29/2011 | 05/29/2012 |
| Cable | Schwarzbeck | AK9513 | ACRX1 | 05/29/2011 | 05/29/2012 |
| Cable | Rosenberger | N/A | FP2RX2 | 05/29/2011 | 05/29/2012 |
| Cable | Schwarzbeck | AK9513 | CRPX1 | 05/29/2011 | 05/29/2012 |
| Cable | Schwarzbeck | AK9513 | CRRX2 | 05/29/2011 | 05/29/2012 |

6.4 Radiated Emission Limit

The emissions from an intentional radiator shall not exceed the field strength levels specified in the following table 15.209(a):

| Frequencies (MHz) | Field Strength (micorvolts/meter) | Measurement Distance (meters) |
|-------------------|-----------------------------------|-------------------------------|
| 0.009~0.490 | 2400/F(KHz) | 300 |
| 0.490~1.705 | 24000/F(KHz) | 30 |
| 1.705~30.0 | 30 | 30 |
| 30~88 | 100 | 3 |
| 88~216 | 150 | 3 |
| 216~960 | 200 | 3 |
| Above 960 | 500 | 3 |

15.205 Restricted bands of operation

| MHz | MHz | MHz | GHz |
|----------------------------|-----------------------|-----------------|------------------|
| 0.090 - 0.110 | 16.42 - 16.423 | 399.9 - 410 | 4.5 - 5.15 |
| ¹ 0.495 - 0.505 | 16.69475 - 16.69525 | 608 - 614 | 5.35 - 5.46 |
| 2.1735 - 2.1905 | 16.80425 - 16.80475 | 960 - 1240 | 7.25 - 7.75 |
| 4.125 - 4.128 | 25.5 - 25.67 | 1300 - 1427 | 8.025 - 8.5 |
| 4.17725 - 4.17775 | 37.5 - 38.25 | 1435 - 1626.5 | 9.0 - 9.2 |
| 4.20725 - 4.20775 | 73 - 74.6 | 1645.5 - 1646.5 | 9.3 - 9.5 |
| 6.215 - 6.218 | 74.8 - 75.2 | 1660 - 1710 | 10.6 - 12.7 |
| 6.26775 - 6.26825 | 108 - 121.94 | 1718.8 - 1722.2 | 13.25 - 13.4 |
| 6.31175 - 6.31225 | 123 - 138 | 2200 - 2300 | 14.47 - 14.5 |
| 8.291 - 8.294 | 149.9 - 150.05 | 2310 - 2390 | 15.35 - 16.2 |
| 8.362 - 8.366 | 156.52475 - 156.52525 | 2483.5 - 2500 | 17.7 - 21.4 |
| 8.37625 - 8.38675 | 156.7 - 156.9 | 2690 - 2900 | 22.01 - 23.12 |
| 8.41425 - 8.41475 | 162.0125 - 167.17 | 3260 - 3267 | 23.6 - 24.0 |
| 12.29 - 12.293 | 167.72 - 173.2 | 3332 - 3339 | 31.2 - 31.8 |
| 12.51975 - 12.52025 | 240 - 285 | 3345.8 - 3358 | 36.43 - 36.5 |
| 12.57675 - 12.57725 | 322 - 335.4 | 3600 - 4400 | (²) |

- Remark: 1. Emission level in dBuV/m=20 log (uV/m)
2. Measurement was performed at an antenna to the closed point of EUT distance of meters.
3. Only spurious frequency is permitted to locate within the Restricted Bands specified in provision of § 15.205, and the emissions located in restricted bands also comply with 15.209 limit.

6.5 Measurement Result

Operation Mode: TX Mode Test Date : February 23, 2012
 Frequency Range: 9KHz~30MHz Temperature : 28°C
 Test Result: PASS Humidity : 65 %
 Measured Distance: 3m Test By: WOLF

| Freq. (MHz) | Ant.Pol. H/V | Emission Level (dBuV/m) | Limit 3m (dBuV/m) | Over (dB) |
|-------------|--------------|-------------------------|-------------------|-----------|
| -- | -- | -- | -- | -- |

Note: the amplitude of spurious emission that is attenuated by more than 20dB below the permissible limit has no need to be reported.

Distance extrapolation factor = $40 \log(\text{Specific distance} / \text{test distance})$ (dB);

Limit line = Specific limits (dBuV) + distance extrapolation factor.

Operation Mode: 802.11b TX Channel 1 Test Date : February 23, 2012
 Frequency Range: 30~1000MHz Temperature : 28°C
 Test Result: PASS Humidity : 65 %
 Measured Distance: 3m Test By: WOLF

| Freq. (MHz) | Ant.Pol. H/V | Emission Level (dBuV) | Limit 3m (dBuV/m) | Over (dB) | Note |
|-------------|--------------|-----------------------|-------------------|-----------|------|
| 143.48 | V | 30.30 | 43.50 | -13.20 | PK |
| 288.04 | V | 30.32 | 46.00 | -15.68 | PK |
| 384.42 | V | 37.44 | 46.00 | -8.56 | PK |
| 575.63 | V | 33.76 | 46.00 | -12.24 | PK |
| 672.00 | V | 31.32 | 46.00 | -14.68 | PK |
| 961.14 | V | 39.52 | 54.00 | -14.48 | PK |
| 191.67 | H | 37.18 | 43.50 | -6.32 | PK |
| 288.05 | H | 38.79 | 46.00 | -7.21 | PK |
| 384.42 | H | 39.14 | 46.00 | -6.86 | PK |
| 480.80 | H | 32.63 | 46.00 | -13.37 | PK |
| 575.63 | H | 35.34 | 46.00 | -10.66 | PK |
| 961.14 | H | 37.77 | 54.00 | -16.23 | PK |

- Note:**
- (1) All Readings are Peak Value.
 - (2) Emission Level = Reading Level + Probe Factor + Cable Loss.
 - (3) The average measurement was not performed when the peak measured data under the limit of average detection.
 - (4) EUT lying on the table position is the worst case result in the report.

Operation Mode: 802.11b TX Channel 6 Test Date : February 23, 2012
 Frequency Range: 30~1000MHz Temperature : 28°C
 Test Result: PASS Humidity : 65 %
 Measured Distance: 3m Test By: WOLF

| Freq. (MHz) | Ant.Pol. H/V | Emission Level (dBuV) | Limit 3m (dBuV/m) | Over (dB) | Note |
|----------------|-----------------|--------------------------|----------------------|--------------|------|
| 143.84 | V | 29.63 | 43.50 | -13.87 | PK |
| 287.61 | V | 30.61 | 46.00 | -15.39 | PK |
| 385.09 | V | 37.23 | 46.00 | -8.77 | PK |
| 576.65 | V | 34.99 | 46.00 | -11.01 | PK |
| 670.89 | V | 31.77 | 46.00 | -14.23 | PK |
| 961.99 | V | 39.25 | 54.00 | -14.75 | PK |
| 193.03 | H | 36.70 | 43.50 | -6.80 | PK |
| 285.97 | H | 39.57 | 46.00 | -6.43 | PK |
| 384.69 | H | 37.87 | 46.00 | -8.13 | PK |
| 481.05 | H | 32.12 | 46.00 | -13.88 | PK |
| 576.61 | H | 35.13 | 46.00 | -10.87 | PK |
| 961.57 | H | 37.36 | 54.00 | -16.64 | PK |

- Note:**
- (1) All Readings are Peak Value.
 - (2) Emission Level= Reading Level+Probe Factor +Cable Loss.
 - (3) The average measurement was not performed when the peak measured data under the limit of average detection.
 - (4) EUT lying on the table position is the worst case result in the report.

Operation Mode: 802.11b TX Channel 11 Test Date : February 23, 2012
 Frequency Range: 30~1000MHz Temperature : 28°C
 Test Result: PASS Humidity : 65 %
 Measured Distance: 3m Test By: WOLF

| Freq. (MHz) | Ant.Pol. H/V | Emission Level (dBuV) | Limit 3m (dBuV/m) | Over (dB) | Note |
|----------------|-----------------|--------------------------|----------------------|--------------|------|
| 143.67 | V | 30.05 | 43.50 | -13.45 | PK |
| 288.87 | V | 29.57 | 46.00 | -16.43 | PK |
| 384.04 | V | 36.39 | 46.00 | -9.61 | PK |
| 574.58 | V | 32.45 | 46.00 | -13.55 | PK |
| 673.05 | V | 28.34 | 46.00 | -17.66 | PK |
| 962.40 | V | 35.81 | 54.00 | -18.19 | PK |
| 190.52 | H | 34.86 | 43.50 | -8.64 | PK |
| 289.18 | H | 38.10 | 46.00 | -7.90 | PK |
| 385.50 | H | 38.02 | 46.00 | -7.98 | PK |
| 478.75 | H | 31.49 | 46.00 | -14.51 | PK |
| 576.41 | H | 33.46 | 46.00 | -12.54 | PK |
| 961.99 | H | 36.98 | 54.00 | -17.02 | PK |

- Note:**
- (1) All Readings are Peak Value.
 - (2) Emission Level= Reading Level+Probe Factor +Cable Loss.
 - (3) The average measurement was not performed when the peak measured data under the limit of average detection.
 - (4) EUT lying on the table position is the worst case result in the report.

Operation Mode: 802.11g TX Channel 1 Test Date : February 23, 2012
 Frequency Range: 30~1000MHz Temperature : 28°C
 Test Result: PASS Humidity : 65 %
 Measured Distance: 3m Test By: WOLF

| Freq. (MHz) | Ant.Pol. H/V | Emission Level (dBuV) | Limit 3m (dBuV/m) | Over (dB) | Note |
|-------------|--------------|-----------------------|-------------------|-----------|------|
| 143.77 | V | 30.98 | 43.50 | -12.52 | PK |
| 288.40 | V | 29.93 | 46.00 | -16.07 | PK |
| 385.40 | V | 36.79 | 46.00 | -9.21 | PK |
| 576.82 | V | 33.44 | 46.00 | -12.56 | PK |
| 675.11 | V | 30.96 | 46.00 | -15.04 | PK |
| 958.06 | V | 39.74 | 54.00 | -14.26 | PK |
| 190.65 | H | 37.45 | 43.50 | -6.05 | PK |
| 288.78 | H | 39.17 | 46.00 | -6.83 | PK |
| 384.92 | H | 37.36 | 46.00 | -8.64 | PK |
| 483.85 | H | 31.85 | 46.00 | -14.15 | PK |
| 576.77 | H | 35.70 | 46.00 | -10.30 | PK |
| 962.59 | H | 37.36 | 54.00 | -16.64 | PK |

- Note:**
- (1) All Readings are Peak Value.
 - (2) Emission Level= Reading Level+Probe Factor +Cable Loss.
 - (3) The average measurement was not performed when the peak measured data under the limit of average detection.
 - (4) EUT lying on the table position is the worst case result in the report.

Operation Mode: 802.11g TX Channel 6 Test Date : February 23, 2012
 Frequency Range: 30~1000MHz Temperature : 28°C
 Test Result: PASS Humidity : 65%
 Measured Distance: 3m Test By: WOLF

| Freq. (MHz) | Ant.Pol. H/V | Emission Level (dBuV) | Limit 3m (dBuV/m) | Over (dB) | Note |
|-------------|--------------|-----------------------|-------------------|-----------|------|
| 142.56 | V | 29.96 | 43.50 | -13.54 | PK |
| 288.05 | V | 28.88 | 46.00 | -17.12 | PK |
| 388.91 | V | 36.58 | 46.00 | -9.42 | PK |
| 574.07 | V | 32.89 | 46.00 | -13.11 | PK |
| 672.65 | V | 31.08 | 46.00 | -14.92 | PK |
| 961.71 | V | 39.66 | 54.00 | -14.34 | PK |
| 191.70 | H | 37.02 | 43.50 | -6.48 | PK |
| 286.30 | H | 38.83 | 46.00 | -7.17 | PK |
| 385.93 | H | 37.13 | 46.00 | -8.87 | PK |
| 482.80 | H | 30.80 | 46.00 | -15.20 | PK |
| 577.82 | H | 35.85 | 46.00 | -10.15 | PK |
| 963.91 | H | 36.91 | 54.00 | -17.09 | PK |

- Note:**
- (1) All Readings are Peak Value.
 - (2) Emission Level= Reading Level+Probe Factor +Cable Loss.
 - (3) The average measurement was not performed when the peak measured data under the limit of average detection.
 - (4) EUT lying on the table position is the worst case result in the report.

Operation Mode: 802.11g TX Channel 11 Test Date : February 23, 2012
 Frequency Range: 30~1000MHz Temperature : 28°C
 Test Result: PASS Humidity : 65 %
 Measured Distance: 3m Test By: WOLF

| Freq. (MHz) | Ant.Pol. H/V | Emission Level (dBuV) | Limit 3m (dBuV/m) | Over (dB) | Note |
|-------------|--------------|-----------------------|-------------------|-----------|------|
| 142.99 | V | 30.67 | 43.50 | -12.83 | PK |
| 287.35 | V | 28.81 | 46.00 | -17.19 | PK |
| 383.28 | V | 34.74 | 46.00 | -11.26 | PK |
| 579.17 | V | 31.22 | 46.00 | -14.78 | PK |
| 674.99 | V | 32.33 | 46.00 | -13.67 | PK |
| 960.74 | V | 42.41 | 54.00 | -11.59 | PK |
| 192.01 | H | 34.79 | 43.50 | -8.71 | PK |
| 290.26 | H | 38.79 | 46.00 | -7.21 | PK |
| 382.40 | H | 34.31 | 46.00 | -11.69 | PK |
| 485.91 | H | 30.73 | 46.00 | -15.27 | PK |
| 577.48 | H | 34.34 | 46.00 | -11.66 | PK |
| 963.92 | H | 36.59 | 54.00 | -17.41 | PK |

- Note:**
- (1) All Readings are Peak Value.
 - (2) Emission Level= Reading Level+Probe Factor +Cable Loss.
 - (3) The average measurement was not performed when the peak measured data under the limit of average detection.
 - (4) EUT lying on the table position is the worst case result in the report.

| | | | |
|--------------------|-------------------------|---------------|-------------------|
| Operation Mode: | 802.11n TX Channel 1 | Test Date : | February 23, 2012 |
| Frequency Range: | 30~1000MHz | Temperature : | 28°C |
| Test Result: | PASS | Humidity : | 65 % |
| Measured Distance: | 3m | Test By: | WOLF |

| Freq. (MHz) | Ant.Pol. H/V | Emission Level (dBuV) | Limit 3m (dBuV/m) | Over (dB) | Note |
|-------------|--------------|-----------------------|-------------------|-----------|------|
| 142.69 | V | 29.84 | 43.50 | -13.66 | PK |
| 286.99 | V | 30.77 | 46.00 | -15.23 | PK |
| 384.21 | V | 37.19 | 46.00 | -8.81 | PK |
| 575.08 | V | 33.61 | 46.00 | -12.39 | PK |
| 673.06 | V | 30.97 | 46.00 | -15.03 | PK |
| 961.06 | V | 39.34 | 54.00 | -14.66 | PK |
| 191.02 | H | 37.07 | 43.50 | -6.43 | PK |
| 288.46 | H | 38.23 | 46.00 | -7.77 | PK |
| 385.44 | H | 38.10 | 46.00 | -7.90 | PK |
| 479.75 | H | 32.11 | 46.00 | -13.89 | PK |
| 576.73 | H | 35.79 | 46.00 | -10.21 | PK |

- Note:**
- (1) All Readings are Peak Value.
 - (2) Emission Level= Reading Level+Probe Factor +Cable Loss.
 - (3) The average measurement was not performed when the peak measured data under the limit of average detection.
 - (4) EUT lying on the table position is the worst case result in the report.

Operation Mode: 802.11n TX Channel 6 Test Date : February 23, 2012
 Frequency Range: 30~1000MHz Temperature : 28°C
 Test Result: PASS Humidity : 65 %
 Measured Distance: 3m Test By: WOLF

| Freq. (MHz) | Ant.Pol. H/V | Emission Level (dBuV) | Limit 3m (dBuV/m) | Over (dB) | Note |
|----------------|-----------------|--------------------------|----------------------|--------------|------|
| 145.05 | V | 29.30 | 43.50 | -14.20 | PK |
| 285.94 | V | 29.60 | 46.00 | -16.40 | PK |
| 386.24 | V | 37.01 | 46.00 | -8.99 | PK |
| 571.63 | V | 33.05 | 46.00 | -12.95 | PK |
| 670.95 | V | 30.61 | 46.00 | -15.39 | PK |
| 962.31 | V | 39.12 | 54.00 | -14.88 | PK |
| 192.07 | H | 35.71 | 43.50 | -7.79 | PK |
| 291.09 | H | 38.85 | 46.00 | -7.15 | PK |
| 386.88 | H | 39.11 | 46.00 | -6.89 | PK |
| 477.74 | H | 31.55 | 46.00 | -14.45 | PK |
| 573.48 | H | 36.15 | 46.00 | -9.85 | PK |
| 961.04 | H | 38.41 | 54.00 | -15.59 | PK |

- Note:**
- (1) All Readings are Peak Value.
 - (2) Emission Level= Reading Level+Probe Factor +Cable Loss.
 - (3) The average measurement was not performed when the peak measured data under the limit of average detection.
 - (4) EUT lying on the table position is the worst case result in the report.

| | | | |
|--------------------|--------------------------|---------------|-------------------|
| Operation Mode: | 802.11n TX Channel 11 | Test Date : | February 23, 2012 |
| Frequency Range: | 30~1000MHz | Temperature : | 28°C |
| Test Result: | PASS | Humidity : | 65 % |
| Measured Distance: | 3m | Test By: | WOLF |

| Freq. (MHz) | Ant.Pol. H/V | Emission Level (dBuV) | Limit 3m (dBuV/m) | Over (dB) | Note |
|----------------|-----------------|--------------------------|----------------------|--------------|------|
| 143.67 | V | 29.19 | 43.50 | -14.31 | PK |
| 285.94 | V | 29.52 | 46.00 | -16.48 | PK |
| 381.85 | V | 36.17 | 46.00 | -9.83 | PK |
| 577.43 | V | 32.56 | 46.00 | -13.44 | PK |
| 672.94 | V | 31.99 | 46.00 | -14.01 | PK |
| 963.41 | V | 38.22 | 54.00 | -15.78 | PK |
| 192.38 | H | 36.39 | 43.50 | -7.11 | PK |
| 289.94 | H | 38.01 | 46.00 | -7.99 | PK |
| 381.71 | H | 35.97 | 46.00 | -10.03 | PK |
| 481.81 | H | 30.33 | 46.00 | -15.67 | PK |
| 577.48 | H | 34.25 | 46.00 | -11.75 | PK |
| 963.36 | H | 37.77 | 54.00 | -16.23 | PK |

- Note:**
- (1) All Readings are Peak Value.
 - (2) Emission Level= Reading Level+Probe Factor +Cable Loss.
 - (3) The average measurement was not performed when the peak measured data under the limit of average detection.
 - (4) EUT lying on the table position is the worst case result in the report.

Operation Mode: 802.11b TX Channel 1 Test Date : February 23, 2012
 Frequency Range: Above 1GHz Temperature : 28°C
 Test Result: PASS Humidity : 65 %
 Measured Distance: 3m Test By: WOLF

| Freq. (MHz) | Ant.Pol. H/V | Emission Level(dBuV) | | Limit 3m(dBuV/m) | | Over(dB) | |
|----------------|-----------------|----------------------|-------|------------------|-------|----------|--------|
| | | PK | AV | PK | AV | PK | AV |
| 4826.18 | V | 57.36 | 42.35 | 74.00 | 54.00 | -16.64 | -11.65 |
| 7235.35 | V | 55.51 | 41.27 | 74.00 | 54.00 | -18.49 | -12.73 |
| 9647.23 | V | 53.39 | 40.05 | 74.00 | 54.00 | -20.61 | -13.95 |
| -- | V | -- | -- | -- | -- | -- | -- |
| -- | V | -- | -- | -- | -- | -- | -- |
| -- | V | -- | -- | -- | -- | -- | -- |
| 4826.25 | H | 55.93 | 41.02 | 74.00 | 54.00 | -18.07 | -12.98 |
| 7235.19 | H | 53.27 | 40.64 | 74.00 | 54.00 | -20.73 | -13.36 |
| 9646.33 | H | 54.11 | 40.97 | 74.00 | 54.00 | -19.89 | -13.03 |

All emissions not reported were more than 20dB below the specified limit or in the noise floor.

- Note:**
- (1) All Readings are Peak Value and AV.
 - (2) Emission Level= Reading Level+Probe Factor +Cable Loss.
 - (3) Data of measurement within this frequency range shown “ -- ” in the table above means the reading of emissions are attenuated more than 20dB below the permissible limits or the field strength is too small to be measured.

Operation Mode: 802.11b TX Channel 6 Test Date : February 23, 2012
 Frequency Range: Above 1GHz Temperature : 28°C
 Test Result: PASS Humidity : 65 %
 Measured Distance: 3m Test By: WOLF

| Freq. (MHz) | Ant.Pol. H/V | Emission Level(dBuV) | | Limit 3m(dBuV/m) | | Over(dB) | |
|----------------|-----------------|----------------------|-------|------------------|-------|----------|--------|
| | | PK | AV | PK | AV | PK | AV |
| 4883.16 | V | 57.71 | 42.01 | 74.00 | 54.00 | -16.29 | -11.99 |
| 7325.70 | V | 55.16 | 40.54 | 74.00 | 54.00 | -18.84 | -13.46 |
| 9763.16 | V | 54.49 | 40.83 | 74.00 | 54.00 | -19.51 | -13.17 |
| -- | V | -- | -- | -- | -- | -- | -- |
| -- | V | -- | -- | -- | -- | -- | -- |
| -- | V | -- | -- | -- | -- | -- | -- |
| 4876.46 | H | 55.48 | 40.75 | 74.00 | 54.00 | -18.52 | -13.25 |
| 7330.80 | H | 52.59 | 40.32 | 74.00 | 54.00 | -21.41 | -13.68 |
| 9767.50 | H | 52.88 | 40.04 | 74.00 | 54.00 | -21.12 | -13.96 |

All emissions not reported were more than 20dB below the specified limit or in the noise floor.

- Note:**
- (1) All Readings are Peak Value and AV.
 - (2) Emission Level= Reading Level+Probe Factor +Cable Loss.
 - (3) Data of measurement within this frequency range shown “ -- ” in the table above means the reading of emissions are attenuated more than 20dB below the permissible limits or the field strength is too small to be measured.

Operation Mode: 802.11b TX (Channel 11) Test Date : February 23, 2012
 Frequency Range: Above 1GHz Temperature : 28°C
 Test Result: PASS Humidity : 65 %
 Measured Distance: 3m Test By: WOLF

| Freq. (MHz) | Ant.Pol. H/V | Emission Level(dBuV) | | Limit 3m(dBuV/m) | | Over(dB) | |
|----------------|-----------------|----------------------|-------|------------------|-------|----------|--------|
| | | PK | AV | PK | AV | PK | AV |
| 4926.20 | V | 56.45 | 41.46 | 74.00 | 54.00 | -17.55 | -12.54 |
| 7413.42 | V | 54.46 | 40.59 | 74.00 | 54.00 | -19.54 | -13.41 |
| 9868.49 | V | 53.76 | 39.69 | 74.00 | 54.00 | -20.24 | -14.31 |
| -- | V | -- | -- | -- | -- | -- | -- |
| -- | V | -- | -- | -- | -- | -- | -- |
| -- | V | -- | -- | -- | -- | -- | -- |
| 4924.78 | H | 56.88 | 41.31 | 74.00 | 54.00 | -17.12 | -12.69 |
| 7394.46 | H | 54.35 | 41.47 | 74.00 | 54.00 | -19.65 | -12.53 |
| 9877.68 | H | 53.26 | 40.41 | 74.00 | 54.00 | -20.74 | -13.59 |

No others harmonics emissions are higher than 20dB below the limits of 47 CFR Part 15.247.

- Note:**
- (1) All Readings are Peak Value and AV.
 - (2) Emission Level= Reading Level+Probe Factor +Cable Loss.
 - (3) Data of measurement within this frequency range shown “ -- ” in the table above means the reading of emissions are attenuated more than 20dB below the permissible limits or the field strength is too small to be measured.

Operation Mode: 802.11g TX Channel 1 Test Date : February 23, 2012
 Frequency Range: Above 1GHz Temperature : 28°C
 Test Result: PASS Humidity : 65 %
 Measured Distance: 3m Test By: WOLF

| Freq. (MHz) | Ant.Pol. H/V | Emission Level(dBuV) | | Limit 3m(dBuV/m) | | Over(dB) | |
|----------------|-----------------|----------------------|-------|------------------|-------|----------|--------|
| | | PK | AV | PK | AV | PK | AV |
| 4825.55 | V | 56.82 | 43.16 | 74.00 | 54.00 | -17.18 | -10.84 |
| 7236.40 | V | 55.16 | 41.83 | 74.00 | 54.00 | -18.84 | -12.17 |
| 9647.11 | V | 54.44 | 39.03 | 74.00 | 54.00 | -19.56 | -14.97 |
| -- | V | -- | -- | -- | -- | -- | -- |
| -- | V | -- | -- | -- | -- | -- | -- |
| -- | V | -- | -- | -- | -- | -- | -- |
| 4824.90 | H | 56.55 | 41.46 | 74.00 | 54.00 | -17.45 | -12.54 |
| 7236.15 | H | 54.35 | 41.66 | 74.00 | 54.00 | -19.65 | -12.34 |
| 9645.28 | H | 54.21 | 41.41 | 74.00 | 54.00 | -19.79 | -12.59 |

All emissions not reported were more than 20dB below the specified limit or in the noise floor.

- Note:**
- (1) All Readings are Peak Value and AV.
 - (2) Emission Level= Reading Level +Probe Factor +Cable Loss.
 - (3) Data of measurement within this frequency range shown “ -- ” in the table above means the reading of emissions are attenuated more than 20dB below the permissible limits or the field strength is too small to be measured.

Operation Mode: 802.11g TX (Channel 6) Test Date : February 23, 2012
 Frequency Range: Above 1GHz Temperature : 28°C
 Test Result: PASS Humidity : 65 %
 Measured Distance: 3m Test By: WOLF

| Freq. (MHz) | Ant.Pol. H/V | Emission Level(dBuV) | | Limit 3m(dBuV/m) | | Over(dB) | |
|----------------|-----------------|----------------------|-------|------------------|-------|----------|--------|
| | | PK | AV | PK | AV | PK | AV |
| 4883.78 | V | 55.37 | 42.26 | 74.00 | 54.00 | -18.63 | -11.74 |
| 7327.17 | V | 57.28 | 42.50 | 74.00 | 54.00 | -16.72 | -11.50 |
| 9762.18 | V | 55.77 | 40.24 | 74.00 | 54.00 | -18.23 | -13.76 |
| -- | V | -- | -- | -- | -- | -- | -- |
| -- | V | -- | -- | -- | -- | -- | -- |
| -- | V | -- | -- | -- | -- | -- | -- |
| 4874.12 | H | 58.16 | 42.30 | 74.00 | 54.00 | -15.84 | -11.70 |
| 7331.78 | H | 55.10 | 41.31 | 74.00 | 54.00 | -18.90 | -12.69 |
| 9767.05 | H | 55.42 | 41.53 | 74.00 | 54.00 | -18.58 | -12.47 |

All emissions not reported were more than 20dB below the specified limit or in the noise floor.

- Note:**
- (1) All Readings are Peak Value and AV.
 - (2) Emission Level= Reading Level+Probe Factor +Cable Loss.
 - (3) Data of measurement within this frequency range shown “ -- ” in the table above means the reading of emissions are attenuated more than 20dB below the permissible limits or the field strength is too small to be measured.

Operation Mode: 802.11g TX (Channel 11) Test Date : February 23, 2012
 Frequency Range: Above 1GHz Temperature : 28°C
 Test Result: PASS Humidity : 65 %
 Measured Distance: 3m Test By: WOLF

| Freq. (MHz) | Ant.Pol. H/V | Emission Level(dBuV) | | Limit 3m(dBuV/m) | | Over(dB) | |
|----------------|-----------------|----------------------|-------|------------------|-------|----------|--------|
| | | PK | AV | PK | AV | PK | AV |
| 4926.99 | V | 55.68 | 41.11 | 74.00 | 54.00 | -18.32 | -12.89 |
| 7409.57 | V | 54.75 | 39.99 | 74.00 | 54.00 | -19.25 | -14.01 |
| 9866.44 | V | 56.77 | 39.60 | 74.00 | 54.00 | -17.23 | -14.40 |
| -- | V | -- | -- | -- | -- | -- | -- |
| -- | V | -- | -- | -- | -- | -- | -- |
| -- | V | -- | -- | -- | -- | -- | -- |
| 4922.44 | H | 57.76 | 42.55 | 74.00 | 54.00 | -16.24 | -11.45 |
| 7395.44 | H | 54.66 | 41.71 | 74.00 | 54.00 | -19.34 | -12.29 |
| 9876.70 | H | 52.96 | 40.43 | 74.00 | 54.00 | -21.04 | -13.57 |

No others harmonics emissions are higher than 20dB below the limits of 47 CFR Part 15.247.

- Note:**
- (1) All Readings are Peak Value and AV.
 - (2) Emission Level= Reading Level+Probe Factor +Cable Loss.
 - (3) Data of measurement within this frequency range shown “ -- ” in the table above means the reading of emissions are attenuated more than 20dB below the permissible limits or the field strength is too small to be measured.

Operation Mode: 802.11n TX Channel 1 Test Date : February 23, 2012
 Frequency Range: Above 1GHz Temperature : 28°C
 Test Result: PASS Humidity : 65 %
 Measured Distance: 3m Test By: WOLF

| Freq. (MHz) | Ant.Pol. H/V | Emission Level(dBuV) | | Limit 3m(dBuV/m) | | Over(dB) | |
|----------------|-----------------|----------------------|-------|------------------|-------|----------|--------|
| | | PK | AV | PK | AV | PK | AV |
| 4826.53 | V | 58.27 | 42.80 | 74.00 | 54.00 | -15.73 | -11.20 |
| 7236.56 | V | 55.92 | 41.56 | 74.00 | 54.00 | -18.08 | -12.44 |
| 9647.91 | V | 54.41 | 40.93 | 74.00 | 54.00 | -19.59 | -13.07 |
| -- | V | -- | -- | -- | -- | -- | -- |
| -- | V | -- | -- | -- | -- | -- | -- |
| -- | V | -- | -- | -- | -- | -- | -- |
| 4824.61 | H | 57.16 | 39.77 | 74.00 | 54.00 | -16.84 | -14.23 |
| 7234.20 | H | 51.91 | 39.68 | 74.00 | 54.00 | -22.09 | -14.32 |
| 9646.90 | H | 52.06 | 39.92 | 74.00 | 54.00 | -21.94 | -14.08 |

All emissions not reported were more than 20dB below the specified limit or in the noise floor.

- Note:**
- (1) All Readings are Peak Value and AV.
 - (2) Emission Level= Reading Level+Probe Factor +Cable Loss.
 - (3) Data of measurement within this frequency range shown “ -- ” in the table above means the reading of emissions are attenuated more than 20dB below the permissible limits or the field strength is too small to be measured.

Operation Mode: 802.11n TX (Channel 6) Test Date : February 23, 2012
 Frequency Range: Above 1GHz Temperature : 28°C
 Test Result: PASS Humidity : 65 %
 Measured Distance: 3m Test By: WOLF

| Freq. (MHz) | Ant.Pol. H/V | Emission Level(dBuV) | | Limit 3m(dBuV/m) | | Over(dB) | |
|----------------|-----------------|----------------------|-------|------------------|-------|----------|--------|
| | | PK | AV | PK | AV | PK | AV |
| 4883.79 | V | 58.50 | 42.15 | 74.00 | 54.00 | -15.50 | -11.85 |
| 7327.03 | V | 57.17 | 42.45 | 74.00 | 54.00 | -16.83 | -11.55 |
| 9761.98 | V | 55.39 | 41.29 | 74.00 | 54.00 | -18.61 | -12.71 |
| -- | V | -- | -- | -- | -- | -- | -- |
| -- | V | -- | -- | -- | -- | -- | -- |
| -- | V | -- | -- | -- | -- | -- | -- |
| 4871.22 | H | 58.47 | 40.72 | 74.00 | 54.00 | -15.53 | -13.28 |
| 7329.82 | H | 52.62 | 38.65 | 74.00 | 54.00 | -21.38 | -15.35 |
| 9766.57 | H | 53.16 | 39.27 | 74.00 | 54.00 | -20.84 | -14.73 |

All emissions not reported were more than 20dB below the specified limit or in the noise floor.

- Note:**
- (1) All Readings are Peak Value and AV.
 - (2) Emission Level= Reading Level+Probe Factor +Cable Loss.
 - (3) Data of measurement within this frequency range shown “ -- ” in the table above means the reading of emissions are attenuated more than 20dB below the permissible limits or the field strength is too small to be measured.

Operation Mode: 802.11n TX (Channel 11) Test Date : February 23, 2012
 Frequency Range: Above 1GHz Temperature : 28°C
 Test Result: PASS Humidity : 65 %
 Measured Distance: 3m Test By: WOLF

| Freq. (MHz) | Ant.Pol. H/V | Emission Level(dBuV) | | Limit 3m(dBuV/m) | | Over(dB) | |
|----------------|-----------------|----------------------|-------|------------------|-------|----------|--------|
| | | PK | AV | PK | AV | PK | AV |
| 4925.84 | V | 59.41 | 43.71 | 74.00 | 54.00 | -14.59 | -10.29 |
| 7411.37 | V | 55.28 | 41.19 | 74.00 | 54.00 | -18.72 | -12.81 |
| 9866.66 | V | 56.27 | 41.72 | 74.00 | 54.00 | -17.73 | -12.28 |
| -- | V | -- | -- | -- | -- | -- | -- |
| -- | V | -- | -- | -- | -- | -- | -- |
| -- | V | -- | -- | -- | -- | -- | -- |
| 4925.12 | H | 58.21 | 40.75 | 74.00 | 54.00 | -15.79 | -13.25 |
| 7395.13 | H | 53.00 | 40.41 | 74.00 | 54.00 | -21.00 | -13.59 |
| 9876.37 | H | 53.31 | 40.55 | 74.00 | 54.00 | -20.69 | -13.45 |

No others harmonics emissions are higher than 20dB below the limits of 47 CFR Part 15.247.

- Note:**
- (1) All Readings are Peak Value and AV.
 - (2) Emission Level= Reading Level+Probe Factor +Cable Loss.
 - (3) Data of measurement within this frequency range shown “ -- ” in the table above means the reading of emissions are attenuated more than 20dB below the permissible limits or the field strength is too small to be measured.

6.6 Radiated Measurement Photos



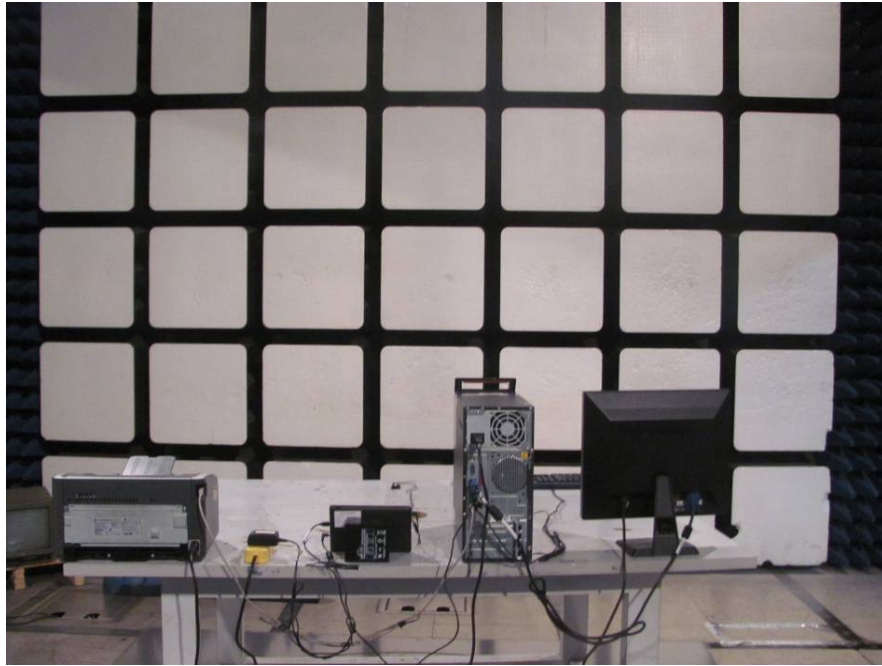

7. Occupied Bandwidth Test

7.1 Measurement Procedure

The EUT was operating in IEEE 802.11b/g/n mode or could be controlled its channel. Printed out the test result from the spectrum by hard copy function.

7.2 Test SET-UP (Block Diagram of Configuration)

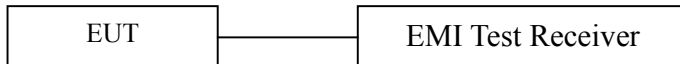

7.3 Measurement Equipment Used

| EQUIPMENT TYPE | MFR | MODEL NUMBER | SERIAL NUMBER | LAST CAL. | CAL DUE. |
|-------------------|-----------------|--------------|---------------|------------|------------|
| EMI Test Receiver | Rohde & Schwarz | ESCI | 101045 | 05/29/2011 | 05/29/2012 |

7.4 Measurement Results

6 Bandwidth Test Data Chart:
Refer to attached data chart.

Spectrum Detector: PK Test Date : February 23, 2012
 Test By: Andy Temperature : 28°C
 Test Result: PASS Humidity : 65 %
 Operation Mode: 802.11b

| Channel number | Channel frequency (MHz) | Measurement level (MHz) | Required Limit (kHz) |
|----------------|-------------------------|-------------------------|----------------------|
| 1 | 2412 | 9.5 | >500 |
| 6 | 2437 | 9.5 | >500 |
| 11 | 2462 | 9.5 | >500 |

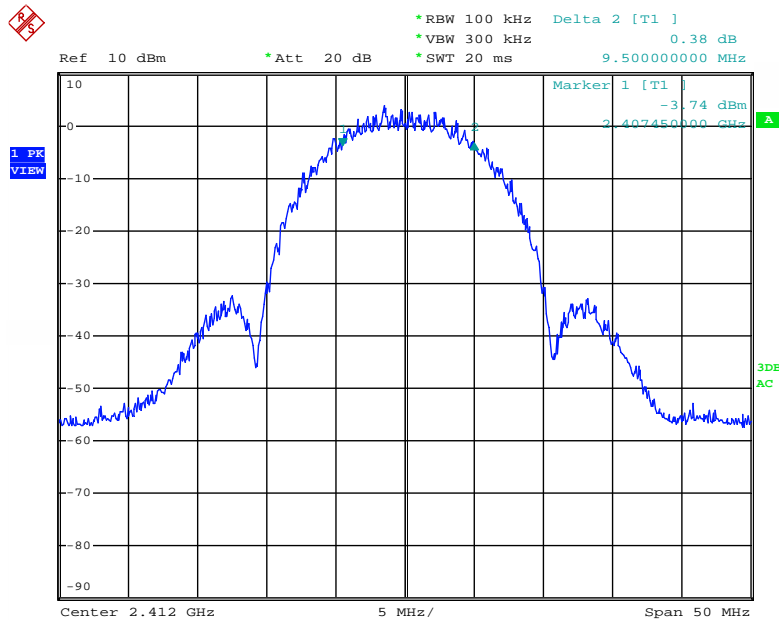

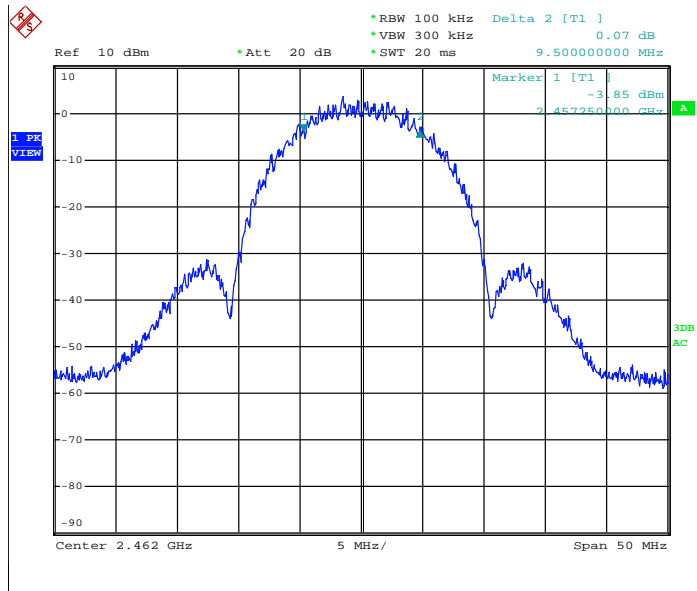
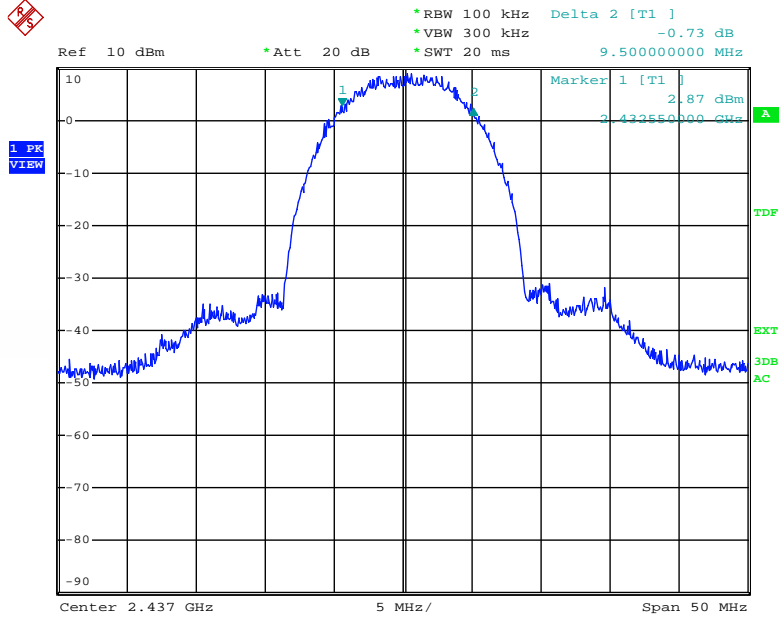

Spectrum Detector: PK Test Date : February 23, 2012
 Test By: Andy Temperature : 28°C
 Test Result: PASS Humidity : 65 %
 Operation Mode: 802.11 g

| Channel number | Channel frequency (MHz) | Measurement level (MHz) | Required Limit (kHz) |
|----------------|-------------------------|-------------------------|----------------------|
| 1 | 2412 | 15.8 | >500 |
| 6 | 2437 | 15.9 | >500 |
| 11 | 2462 | 15.8 | >500 |

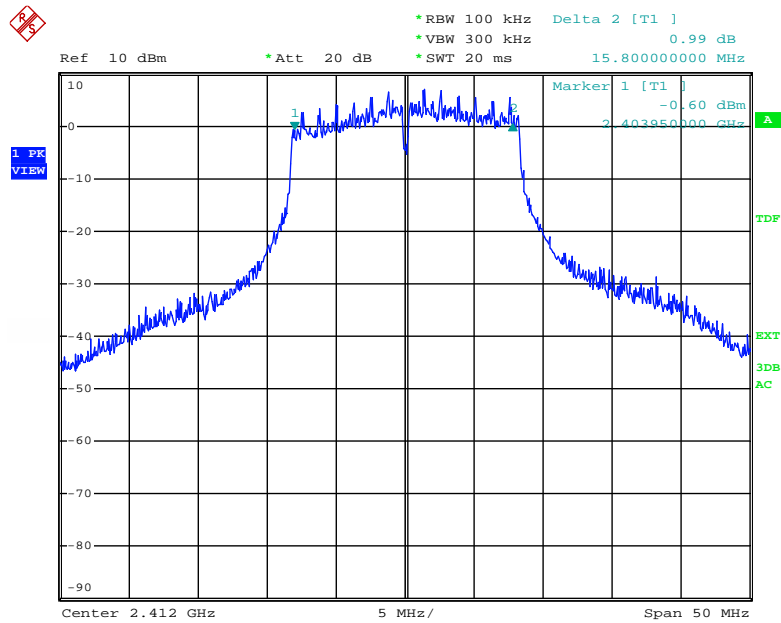

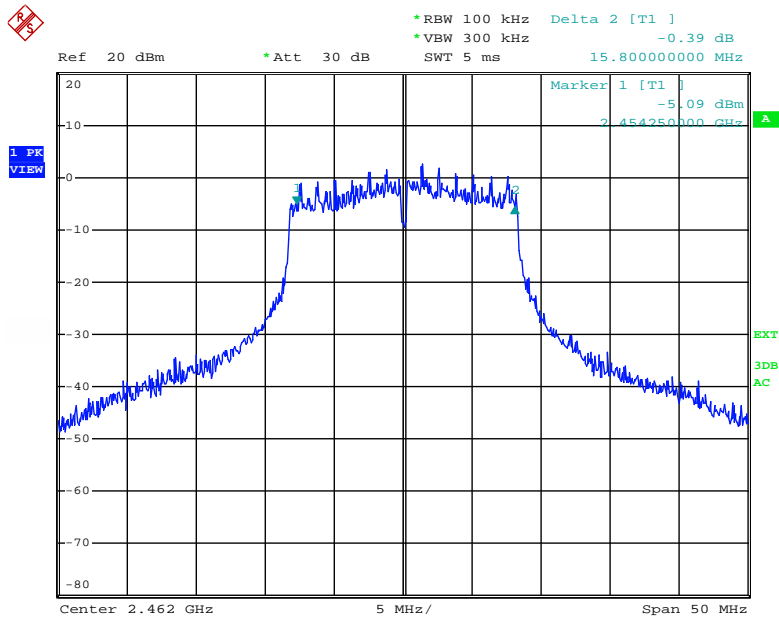
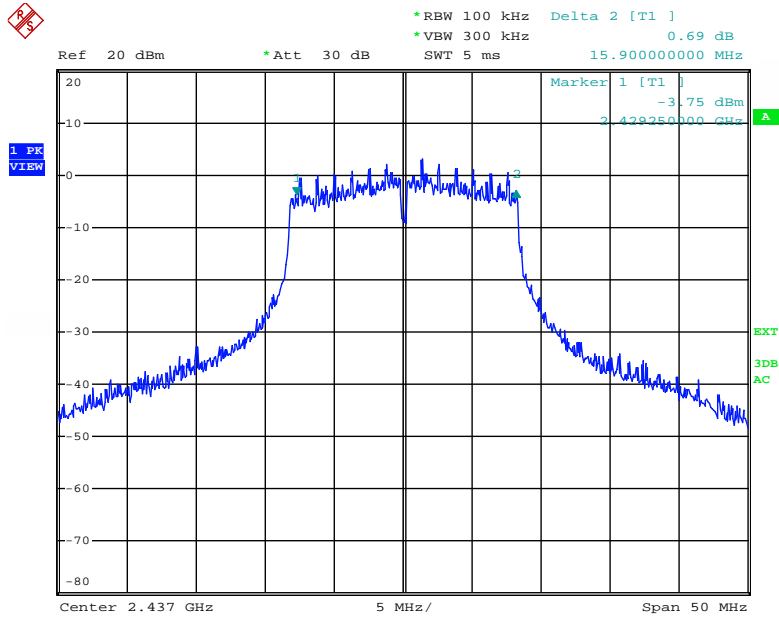

Spectrum Detector: PK Test Date : February 23, 2012
 Test By: Andy Temperature : 28°C
 Test Result: PASS Humidity : 65 %
 Operation Mode: 802.11 n

| Channel number | Channel frequency (MHz) | Measurement level (MHz) | Required Limit (kHz) |
|----------------|-------------------------|-------------------------|----------------------|
| 1 | 2412 | 17.8 | >500 |
| 6 | 2437 | 17.7 | >500 |
| 11 | 2462 | 17.7 | >500 |

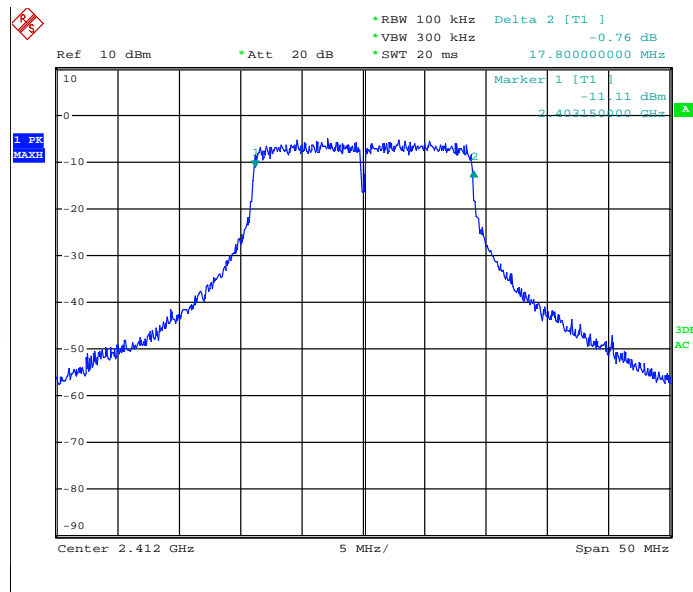

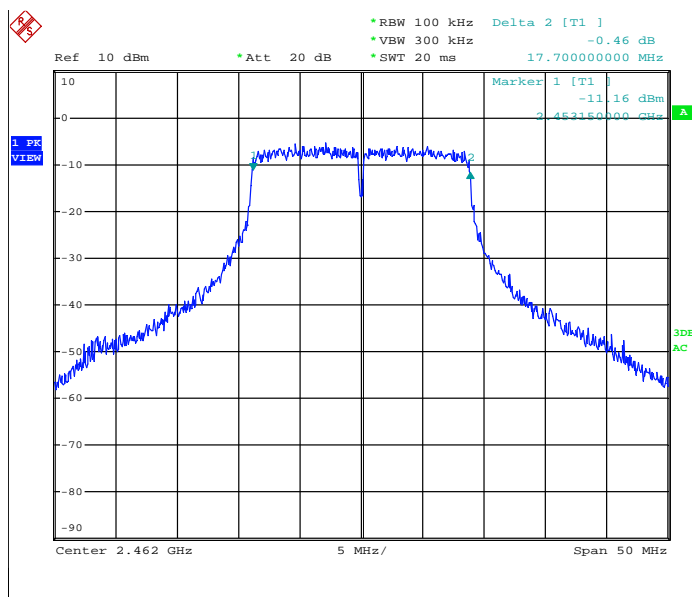
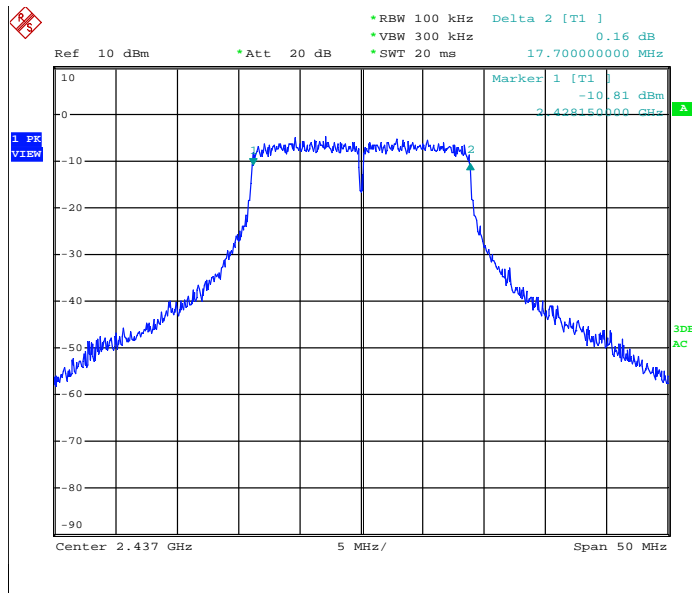

8. Maximum Peak Output Power Test

8.1 Measurement Procedure

- The Transmitter output (antenna port) was connected to the power meter.
- Turn on the EUT and power meter and then record the peak power value.
- Repeat above procedures on all channels needed to be tested.

8.2 Test SET-UP (Block Diagram of Configuration)

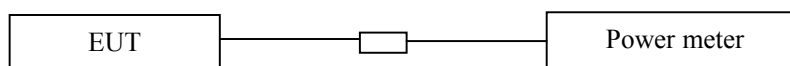

8.3 Measurement Equipment Used

| EQUIPMENT TYPE | MFR | MODEL NUMBER | SERIAL NUMBER | LAST CAL. | CAL DUE. |
|----------------|---------|--------------|---------------|------------|------------|
| Power meter | Boonton | 4232A | 29001 | 05/29/2011 | 05/29/2012 |
| Power sensor | Boonton | 51011-EMC | 31184 | 05/29/2011 | 05/29/2012 |

8.4 Peak Power output limit

The maximum peak power shall be less 1Watt.

8.5 Measurement Results

Spectrum Detector: PK Test Date : February 23, 2012
 Test By: Andy Temperature : 28°C
 Test Result: PASS Humidity : 65 %
 Operation Mode: 802.11b

| Channel number | Channel Frequency(MHz) | Peak Power output(dBm) | Peak Power Limit(W) | Pass/Fail |
|----------------|------------------------|------------------------|---------------------|-----------|
| 1 | 2412 | 12.49 | 1W(30dBm) | PASS |
| 6 | 2437 | 12.62 | 1W(30dBm) | PASS |
| 11 | 2462 | 12.58 | 1W(30dBm) | PASS |

Spectrum Detector: PK Test Date : February 23, 2012
Test By: Andy Temperature : 28°C
Test Result: PASS Humidity : 65 %
Operation Mode: 802.11g

| Channel number | Channel Frequency (MHz) | Peak Power output(dBm) | Peak Power Limit(W) | Pass/Fail |
|----------------|-------------------------|------------------------|---------------------|-----------|
| 1 | 2412.00 | 11.31 | 1W(30dBm) | PASS |
| 6 | 2437.00 | 11.29 | 1W(30dBm) | PASS |
| 11 | 2462.00 | 11.35 | 1W(30dBm) | PASS |

Spectrum Detector: PK Test Date : February 23, 2012
Test By: Andy Temperature : 28°C
Test Result: PASS Humidity : 65 %
Operation Mode: 802.11n

| Channel number | Channel Frequency (MHz) | Peak Power output(dBm) | Peak Power Limit(W) | Pass/Fail |
|----------------|-------------------------|------------------------|---------------------|-----------|
| 1 | 2412.00 | 10.56 | 1W(30dBm) | PASS |
| 6 | 2437.00 | 10.63 | 1W(30dBm) | PASS |
| 11 | 2462.00 | 10.77 | 1W(30dBm) | PASS |

9. Band Edge Test

9.1 Measurement Procedure

1. The EUT was Operating in hopping mode or could be controlled its channel. Printed out test result from the spectrum by hard copy function.
2. The EUT was placed on a turn table which is 0.8m above ground plane.
3. Maximum procedure was performed on the six highest emissions to ensure EUT compliance.
4. And also, each emission was to be maximized by changing the polarization of receiving antenna both horizontal and vertical.
5. Repeat above procedures until all frequency measured were complete.

9.2 Test SET-UP (Block Diagram of Configuration)

As 6.2 Test set up (B) and (C)

9.3 Measurement Equipment Used

Same as 6.3 Radiated Emission Measurement.

9.4 Measurement Results

Test mode: 802.11b

Spectrum Detector: PK/AV Test Date : February 23, 2012
 Test By: Andy Temperature : 28 °C
 Test channel: 01 Humidity : 65 %

| Frequency (MHz) | Polarity | Level (dBuV/m) | | Limited (dBuV/m) | |
|-----------------|----------|----------------|-------|------------------|----|
| | | PK | AV | PK | AV |
| 2486.29 | H | 45.49 | 34.04 | 74 | 54 |
| 2486.70 | V | 43.38 | 31.83 | 74 | 54 |

Spectrum Detector: PK/AV Test Date : February 23, 2012
 Test By: Andy Temperature : 28 °C
 Test channel: 11 Humidity : 65 %

| Frequency (MHz) | Polarity | Level (dBuV/m) | | Limited (dBuV/m) | |
|-----------------|----------|----------------|-------|------------------|----|
| | | PK | AV | PK | AV |
| 2485.27 | H | 44.51 | 33.29 | 74 | 54 |
| 2486.35 | V | 44.36 | 32.15 | 74 | 54 |

Test mode: 802.11g

Spectrum Detector: PK/AV Test Date : February 23, 2012
 Test By: Andy Temperature : 28 °C
 Test channel: 01 Humidity : 65 %

| Frequency (MHz) | Polarity | Level (dBuV/m) | | Limited (dBuV/m) | |
|-----------------|----------|----------------|-------|------------------|----|
| | | PK | AV | PK | AV |
| 2395.76 | H | 45.04 | 32.73 | 74 | 54 |
| 2394.77 | V | 45.11 | 32.62 | 74 | 54 |

Spectrum Detector: PK/AV Test Date : February 23, 2012
 Test By: Andy Temperature : 28 °C
 Test channel: 11 Humidity : 65 %

| Frequency (MHz) | Polarity | Level (dBuV/m) | | Limited (dBuV/m) | |
|-----------------|----------|----------------|-------|------------------|----|
| | | PK | AV | PK | AV |
| 2485.72 | H | 45.16 | 33.53 | 74 | 54 |
| 2487.03 | V | 43.43 | 31.3 | 74 | 54 |

Test mode: 802.11n

Spectrum Detector: PK/AV Test Date : February 23, 2012
 Test By: Andy Temperature : 28 °C
 Test channel: 01 Humidity : 65 %

| Frequency (MHz) | Polarity | Level (dBuV/m) | | Limited (dBuV/m) | |
|-----------------|----------|----------------|------|------------------|----|
| | | PK | AV | PK | AV |
| 2396.02 | H | 44.94 | 32.5 | 74 | 54 |
| 2394.71 | V | 45.23 | 33.7 | 74 | 54 |

Spectrum Detector: PK/AV Test Date : February 23, 2012
 Test By: Andy Temperature : 28 °C
 Test channel: 11 Humidity : 65 %

| Frequency (MHz) | Polarity | Level (dBuV/m) | | Limited (dBuV/m) | |
|-----------------|----------|----------------|-------|------------------|----|
| | | PK | AV | PK | AV |
| 2486.29 | H | 45.49 | 34.04 | 74 | 54 |
| 2486.7 | V | 43.38 | 31.83 | 74 | 54 |

10. Power Density

10.1 Test Equipment

| EQUIPMENT TYPE | MFR | MODEL NUMBER | SERIAL NUMBER | LAST CAL. | CAL DUE. |
|-------------------|-----------------|--------------|---------------|------------|------------|
| EMI Test Receiver | Rohde & Schwarz | ESCI | 101045 | 05/29/2011 | 05/29/2012 |

10.2 Measuring Instruments and Setting

The following table is the setting of spectrum analyzer.

| Spectrum analyzer | Setting |
|-------------------|----------|
| Attenuation | Auto |
| Span Frequency | 300kHz |
| RB | 3kHz |
| VB | 30kHz |
| Detector | Peak |
| Trace | Max hold |
| Sweep Time | 100s |

10.3 Test Procedures

- The transmitter output (antenna port) was connected to the spectrum analyzer.
- Set RBW of spectrum analyzer to 3 kHz and VBW to 30 kHz, Set Detector to Peak, Trace to Max Hold.
- Mark the frequency with maximum peak power as the center of the display of the spectrum.
- Set the span to 300 kHz and the sweep time to 100s and record the maximum peak value.

10.4 Block Diagram of Test Setup

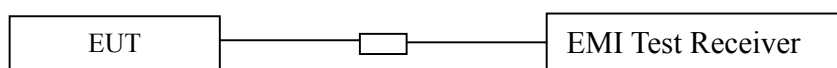

10.5 Limit

The transmitted power density averaged over any 1 second interval shall not be greater +8dBm in any 3 kHz bandwidth.

10.6 Test Result

| | | | |
|--------------------|----------|---------------|-------------------|
| Spectrum Detector: | PK | Test Date : | February 23, 2012 |
| Test By: | Andy | Temperature : | 28°C |
| Test Result: | PASS | Humidity : | 65 % |
| Operation Mode: | 802.11 b | | |

| Channel | Measurement Level (dBm) | Required Limit (dBm) | Result |
|---------|-------------------------|----------------------|--------|
| 1 | -11.40 | <8dBm | PASS |
| 6 | -11.08 | <8dBm | PASS |
| 11 | -11.43 | <8dBm | PASS |

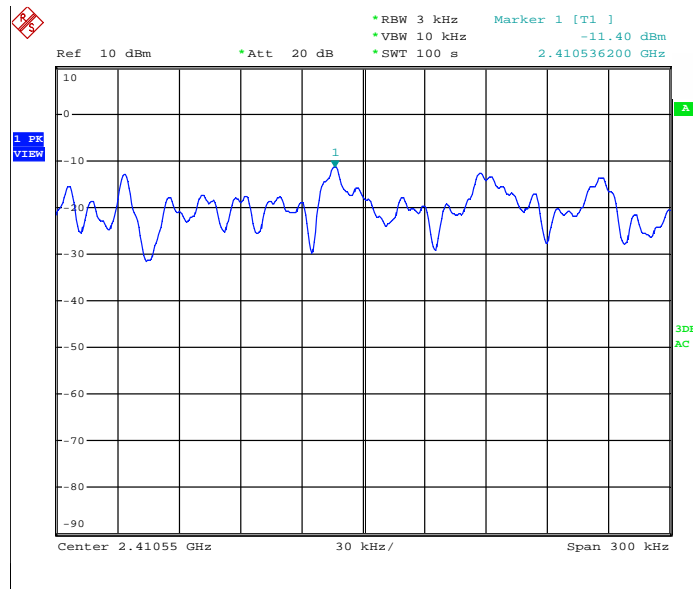

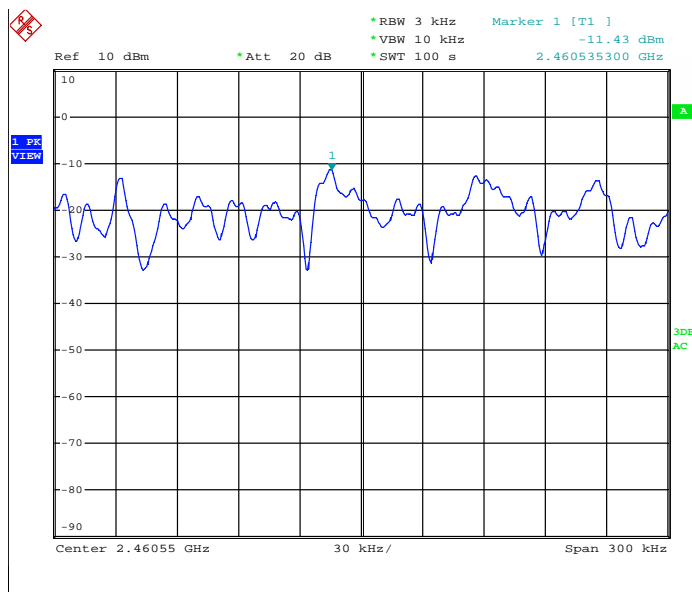
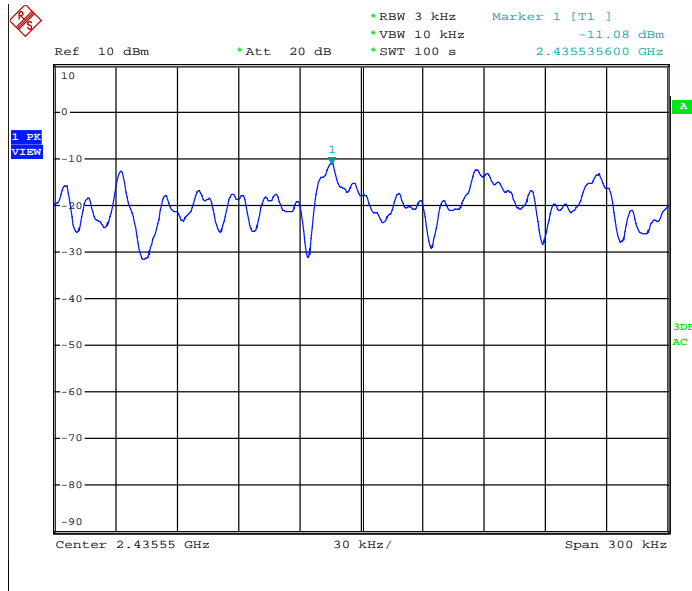

| | | | |
|--------------------|----------|---------------|-------------------|
| Spectrum Detector: | PK | Test Date : | February 23, 2012 |
| Test By: | Andy | Temperature : | 28°C |
| Test Result: | PASS | Humidity : | 65 % |
| Operation Mode: | 802.11 g | | |

| Channel | Measurement Level (dBm) | Required Limit (dBm) | Result |
|---------|-------------------------|----------------------|--------|
| 1 | -17.69 | <8dBm | PASS |
| 6 | -15.93 | <8dBm | PASS |
| 11 | -17.74 | <8dBm | PASS |

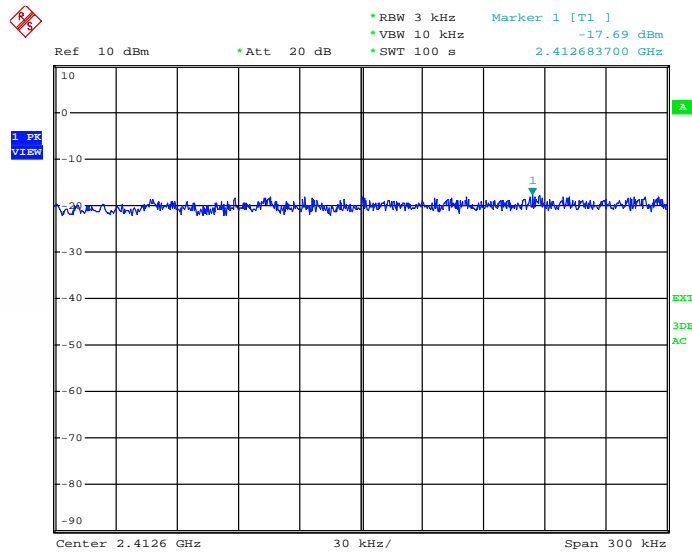

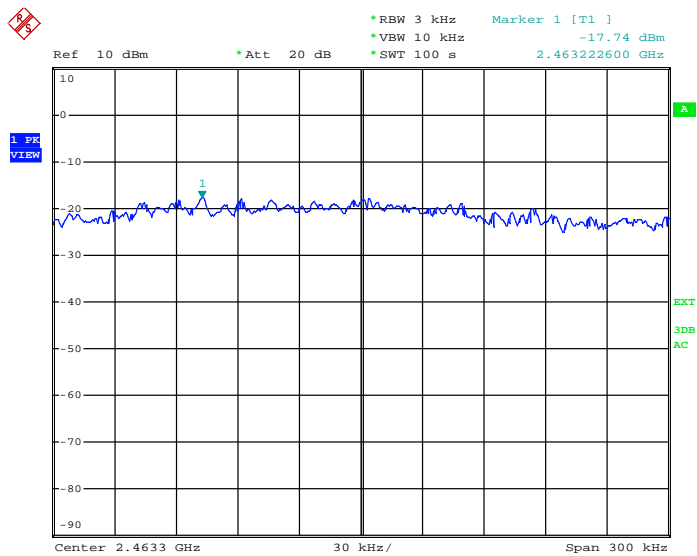
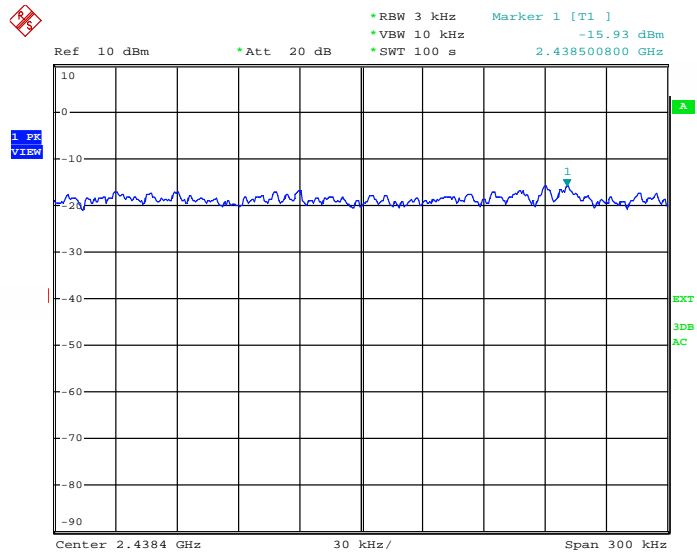

Spectrum Detector: PK Test Date : February 23, 2012
 Test By: Andy Temperature : 28°C
 Test Result: PASS Humidity : 65 %
 Operation Mode: 802.11 n

| Channel | Measurement Level (dBm) | Required Limit (dBm) | Result |
|---------|-------------------------|----------------------|--------|
| 1 | -19.23 | <8dBm | PASS |
| 6 | -19.08 | <8dBm | PASS |
| 11 | -19.25 | <8dBm | PASS |

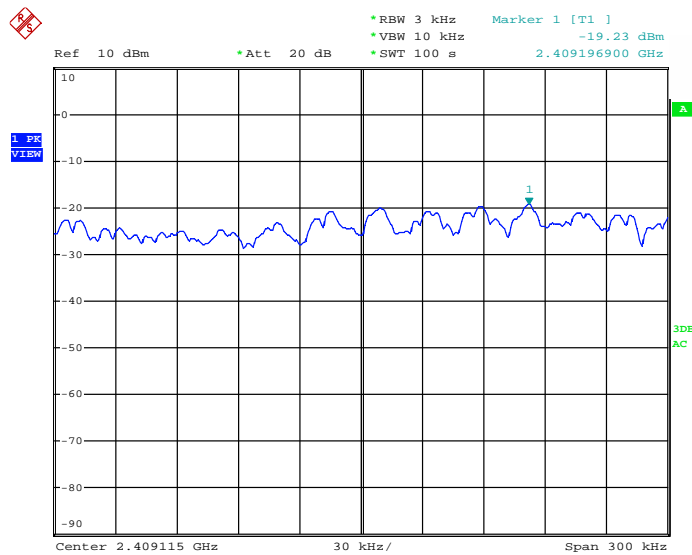

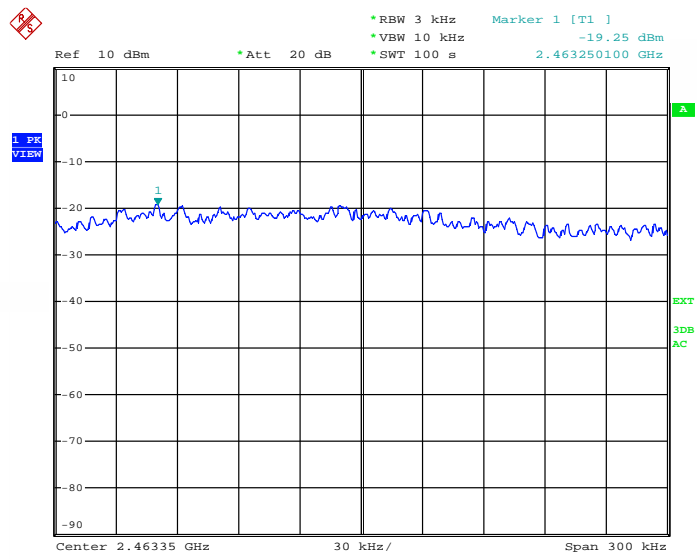
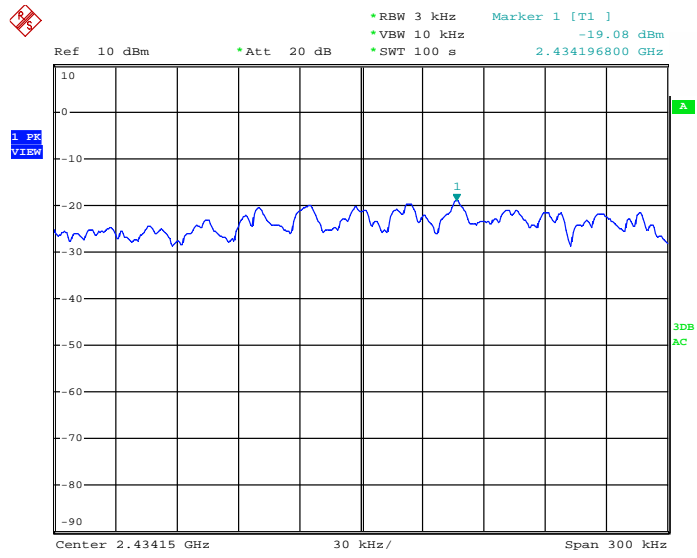

11. Antenna Port Emission

11.1 Test Equipment

| EQUIPMENT TYPE | MFR | MODEL NUMBER | SERIAL NUMBER | LAST CAL. | CAL DUE. |
|-------------------|-----------------|--------------|---------------|------------|------------|
| EMI Test Receiver | Rohde & Schwarz | ESU | 1302.6005.26 | 05/29/2011 | 05/29/2012 |

11.2 Measuring Instruments and Setting

The following table is the setting of spectrum analyzer.

| Spectrum analyzer | Setting |
|-------------------|----------|
| Attenuation | Auto |
| RB | 100kHz |
| VB | 300kHz |
| Detector | Peak |
| Trace | Max hold |

11.3 Test Procedures

The conducted spurious emissions were measured conducted using a spectrum analyzer at low, Middle, and high channels, The limit was determined by attenuation 20dB of the RF peak power output.

11.4 Block Diagram of Test setup

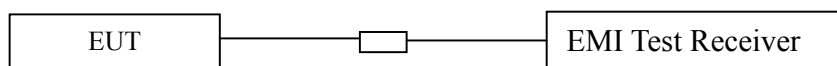

11.5 Test Result

PASS.

All the modes 802.11b/g/n have been tested, the worst result 802.11b was recorded in the following pages.

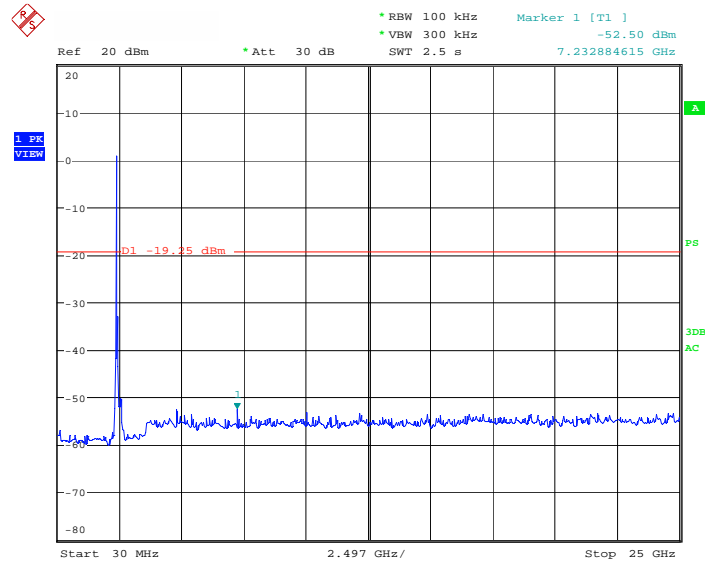

802.11b Channel 6

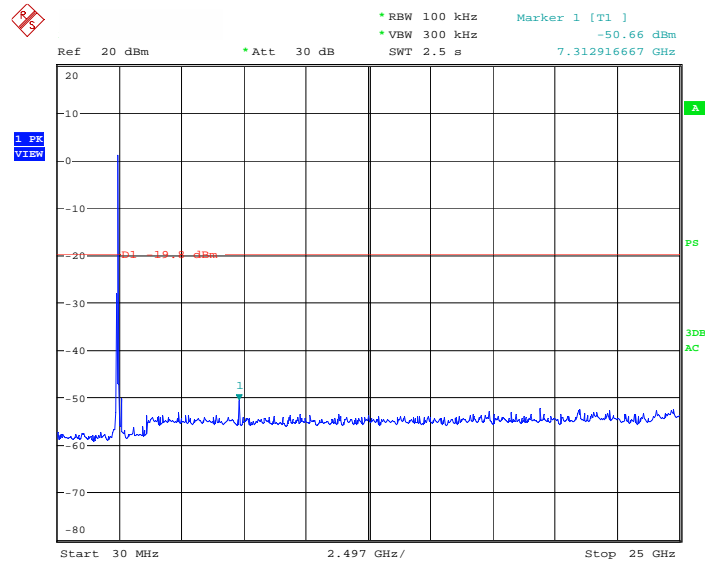

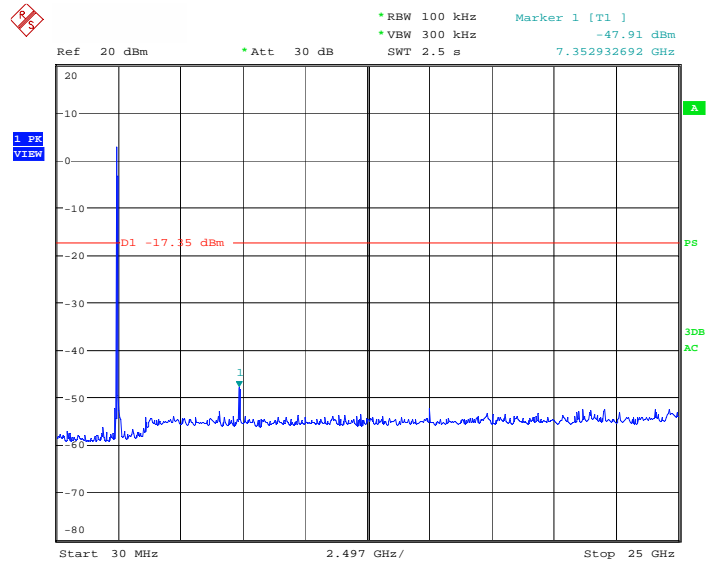

12. Antenna Application

12.1 Antenna Requirement

For intentional device, according to FCC 47 CFR Section 15.203, an intentional radiator shall be designed to ensure that no antenna other than that furnished by the responsible party shall be used with the device. And according to FCC 47 CFR Section 15.247 (b), if transmitting antennas of directional gain greater than 6dBi are used, the power shall be reduced by the amount in dB that the directional gain of the antenna exceeds 6dBi.

12.2 Result

The EUT'S antenna is PCB Antenna. The antenna's gain is 0dBi and meets the requirement.