

**ELECTROMAGNETIC EMISSIONS COMPLIANCE REPORT
INTENTIONAL RADIATOR CERTIFICATION TO
FCC PART 15 SUBPART C REQUIREMENT**

OF

Android EBOOK

MODEL No.: NEXT3, M901

FCC ID: S7JNEXT3

REPORT NO: ES101012026F

ISSUE DATE: October 22, 2010

Prepared for

**SHENZHEN YIFANG DIGITAL TECHNOLOGY CO., LTD.
Building NO.22, 23, Fifth Region, Baiwangxin Industrial Park, Songbai Rd.,
Nanshan, Shenzhen 518108, China**

Prepared by

SHENZHEN EMTEK CO., LTD

**Bldg 69, Majialong Industry Zone, Nanshan District,
Shenzhen, Guangdong, China
TEL: 86-755-26954280
FAX: 86-755-26954282**

VERIFICATION OF COMPLIANCE

Applicant:	SHENZHEN YIFANG DIGITAL TECHNOLOGY CO., LTD. Building NO.22, 23, Fifth Region, Baiwangxin Industrial Park, Songbai Rd., Nanshan, Shenzhen 518108, China
Manufacturer:	SHENZHEN YIFANG DIGITAL TECHNOLOGY CO., LTD. Building NO. 22, 23, Fifth Region, Baiwangxin Industrial Park, Songbai Rd., Nanshan, Shenzhen 518108, China
Product Description:	Android EBOOK
Brand Name:	N/A
Model Number:	NEXT3, M901 (Note: The samples are the same, except model number are the different. We prepare NEXT3 for FCC test.)
Serial Number:	N/A
File Number:	ES101012026F
Date of Test:	October 12, 2010 to October 20, 2010

We hereby certify that:

The above equipment was tested by SHENZHEN EMTEK CO., LTD. The test data, data evaluation, test procedures, and equipment configurations shown in this report were made in accordance with the procedures given in ANSI C63.4 (2009) and the energy emitted by the sample EUT tested as described in this report is in compliance with conducted and radiated emission limits of FCC Rules Part 15.247.

The test results of this report relate only to the tested sample identified in this report.

Approved By



David Lee / Q.A. Manager
SHENZHEN EMTEK CO., LTD.

Table of Contents

1. GENERAL INFORMATION	4
1.1 PRODUCT DESCRIPTION.....	4
1.2 RELATED SUBMITTAL(S) / GRANT (S)	4
1.3 TEST METHODOLOGY	4
1.4 SPECIAL ACCESSORIES	4
1.5 EQUIPMENT MODIFICATIONS	4
1.6 TEST FACILITY	4
2. SYSTEM TEST CONFIGURATION	4
2.1 EUT CONFIGURATION.....	4
2.2 EUT EXERCISE	4
2.3 TEST PROCEDURE	4
2.4 CONFIGURATION OF TESTED SYSTEM.....	4
3. DESCRIPTION OF TEST MODES.....	4
4. CONDUCTED EMISSIONS TEST	4
4.1 MEASUREMENT PROCEDURE:.....	4
4.2 TEST SET-UP (BLOCK DIAGRAM OF CONFIGURATION)	4
4.3 MEASUREMENT EQUIPMENT USED:	4
4.4 CONDUCTED EMISSION LIMIT	4
4.5 MEASUREMENT RESULT:.....	4
4.6 CONDUCTED MEASUREMENT PHOTOS:	4
5. RADIATED EMISSION TEST	4
5.1 MEASUREMENT PROCEDURE.....	4
5.2 TEST SET-UP (BLOCK DIAGRAM OF CONFIGURATION)	4
5.3 MEASUREMENT EQUIPMENT USED:	4
5.4 RADIATED EMISSION LIMIT.....	4
5.5 MEASUREMENT RESULT	4
5.6 RADIATED MEASUREMENT PHOTOS:	4
6. OCCUPIED BANDWIDTH TEST.....	4
6.1 MEASUREMENT PROCEDURE.....	4
6.2 TEST SET-UP (BLOCK DIAGRAM OF CONFIGURATION)	4
6.3 MEASUREMENT EQUIPMENT USED:	4
6.4 LIMIT	4
6.5 MEASUREMENT RESULTS:.....	4
7. MAXIMUM PEAK OUTPUT POWER TEST	4
7.1 MEASUREMENT PROCEDURE.....	4
7.2 TEST SET-UP (BLOCK DIAGRAM OF CONFIGURATION)	4
7.3 MEASUREMENT EQUIPMENT USED:	4

7.4 PEAK POWER OUTPUT LIMIT..... 4
7.5 MEASUREMENT RESULTS: 4
8. BAND EDGE TEST 4
8.1 MEASUREMENT PROCEDURE..... 4
8.2 TEST SET-UP (BLOCK DIAGRAM OF CONFIGURATION) 4
8.3 MEASUREMENT EQUIPMENT USED: 4
8.4 MEASUREMENT RESULTS: 4
9. POWER DENSITY 4
9.1 TEST EQUIPMENT..... 4
9.2 MEASURING INSTRUMENTS AND SETTING..... 4
9.3 TEST PROCEDURES 4
9.4 BLOCK DIAGRAM OF TEST SETUP..... 4
9.5 LIMIT 4
9.6. TEST RESULT 4
10. ANTENNA PORT EMISSION 4
10.1 TEST EQUIPMENT..... 4
10.2 MEASURING INSTRUMENTS AND SETTING..... 4
10.3 TEST PROCEDURES 4
10.4 BLOCK DIAGRAM OF TEST SETUP..... 4
10.6. TEST RESULT 4
11. ANTENNA APPLICATION 4
11.1 ANTENNA REQUIREMENT 4
11.2 RESULT 4

1. GENERAL INFORMATION

1.1 Product Description

A major technical descriptions of EUT is described as following:

- A). Standards: IEEE802.11b/g
- B). Operation Frequency: 2400-2483.5MHz
- C). Modulation: OFDM with BPSK, QPSK, 16QAM, 64QAM(11g), BPSK, QPSK, CCK (11b)
- D). Number of Channel: 11
- E). Max Data Rate: 11Mbps(802.11b), 54Mbps(802.11g)
- F). Conducted Power: 15.56dBm(802.11b),13.81 (802.11g),
- G).PCB Gain: 0dBi
- H).Antenna Type: PCB Antenna
- I). Power Supply: DC5V with AC Adapter and DC 3.7V from Li-ion Battery
- J). Adapter: M/N: EA100UG0
Input: 100-240V~50-60Hz, 0.4A
Output: DC5V/2A

Channel	Frequency (MHz)	Channel	Frequency (MHz)	Channel	Frequency (MHz)
1	2412	5	2432	9	2452
2	2417	6	2437	10	2457
3	2422	7	2442	11	2462
4	2427	8	2447		

Note:

1. This device is a 2.4GHz **Android EBOOK** included 802.11b and 802.11g 2.4GHz transceiver function.
2. Test of channel was included the lowest middle and highest frequency in highest data rate and to perform the test, then record on this report.

1.2 Related Submittal(s) / Grant (s)

This submittal(s) (test report) is intended for FCC ID: S7JNEXT3 filing to comply with Section 15.247 of the FCC Part 15, Subpart C Rules. The composite system (receiver) is compliance with Subpart B is authorized under a DOC procedure.

1.3 Test Methodology

Both conducted and radiated testing were performed according to the procedures in ANSI C63.4 (2009). Radiated testing was performed at an antenna to EUT distance 3 meters.

1.4 Special Accessories

Not available for this EUT intended for grant.

1.5 Equipment Modifications

Not available for this EUT intended for grant.

1.6 Test Facility

Site Description

EMC Lab.

: Accredited by CNAS, 2005.11.02
The certificate is valid until 2010.11
The Laboratory has been assessed and proved to be in compliance
with CNAS/CL01:2006(identical to ISO/IEC17025: 2005)
The Certificate Registration Number is L2291

Accredited by TUV Rheinland Shenzhen 2010.5.25
The Laboratory has been assessed according to the requirements
ISO/IEC 17025

Accredited by FCC, March 18, 2008
The Certificate Registration Number is 709623.

Accredited by Industry Canada, March 05, 2010
The Certificate Registration Number is 46405-4480.

Name of Firm

Site Location

: SHENZHEN EMTEK CO., LTD
: Bldg 69, Majialong Industry Zone,
Nanshan District, Shenzhen, Guangdong, China

2. System Test Configuration

2.1 EUT Configuration

The EUT configuration for testing is installed on RF field strength measurement to meet the Commissions requirement and operating in a manner which intends to maximize its emission characteristics in a continuous normal application.

2.2 EUT Exercise

The Transmitter was operated in the normal operating mode. the Tx frequency was fixed which was for the purpose of the measurements.

2.3 Test Procedure

2.3.1 Conducted Emissions

The EUT is a placed on as turn table which is 0.8 m above ground plane. According to the requirements in Section 13.1.4.1 of ANSI C63.4-2009. Conducted emissions from the EUT measured in the frequency range between 0.15 MHz and 30MHz using CISPR Quasi-Peak and average detector mode.

2.3.2 Radiated Emissions

The EUT is a placed on as turn table which is 0.8 m above ground plane. The turn table shall rotate 360 degrees to determine the position of maximum emission level. EUT is set 3m away from the receiving antenna which varied from 1m to 4m to find out the highest emission. And also, each emission was to be maximized by changing the polarization of receiving antenna both horizontal and vertical. In order to find out the max. emission, the relative positions of this hand-held transmitter(EUT) was rotated through three orthogonal axes according to the requirements in Section 13.1.4.1 of ANSI C63.4-2009.

2.4 Configuration of Tested System

Fig. 2-1 Configuration of Tested System



Table 2-1 Equipment Used in Tested System

Item	Equipment	Mfr/Brand	Model/Type No.	FCC ID	Series No.	Note
1.	Android EBOOK	N/A	NEXT3	S7JNEXT3	N/A	EUT
2.	Laptop computer	ACER	20020	FCC DOC	EB16076441	
3.	PC	Lenovo	ThinkCentre 8701	FCC DOC	701A53L3BC108	

Note:

- (1) Unless otherwise denoted as EUT in 'Remark' column , device(s) used in tested system is a support equipment.

3. Description of test modes

The Transmitter of EUT is a Android EBOOK and powered by host equipment. This is Digital Transmission system(DTS) and have four type of modulation DBPSK DQPSK CCK&OFDM. The data rates are 54Mbps.

The equipment enables high-speed access without wires to network assets. This adapter uses the IEEE 802.11b/g protocol to enable wireless communications between the host Android EBOOK and Android EBOOKs, in the same way that the Android EBOOK would use an Ethernet adapter.

1. For lowest channel : 2412MHz(Channel 1)
2. For middle channel : 2437MHz(Channel 6)
3. For highest channel: 2462MHz(Channel 11)

EUT operating conditions:

The EUT exercise program used during conducted testing was designed to exercise the EUT in a manner similar to typical use, The exercise sequence is listed as below:

1. Setup the EUT and simulators as shown on 2.4.
2. Turn on the power of all equipments.
3. The EUT Ping with the wireless router.
4. Repeat the above steps.

4. Conducted Emissions Test

4.1 Measurement Procedure:

1. The EUT was placed on a table which is 0.8m above ground plane.
2. Maximum procedure was performed on the six highest emissions to ensure EUT compliance.
3. Repeat above procedures until all frequency measured were complete.

4.2 Test SET-UP (Block Diagram of Configuration)

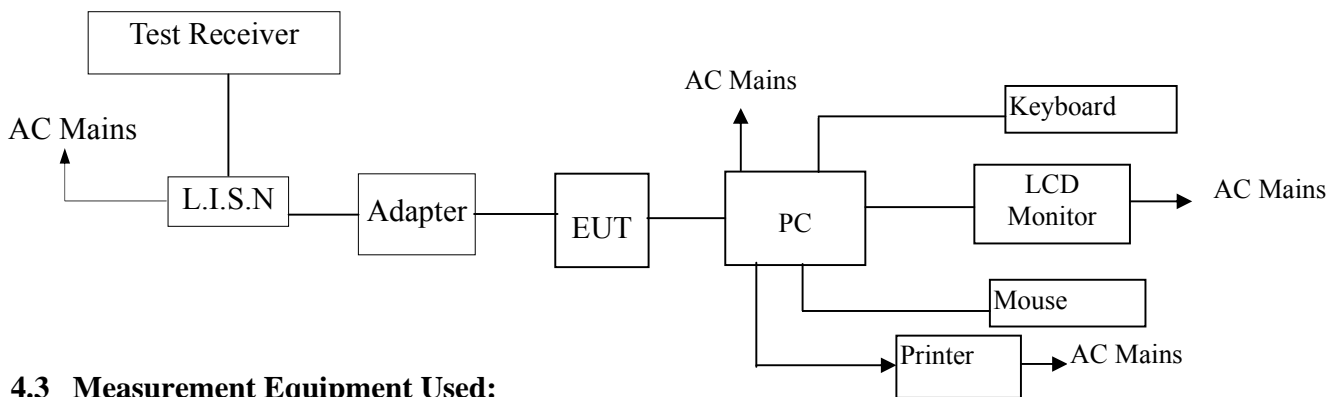

4.3 Measurement Equipment Used:

Conducted Emission Test Site # 4					
EQUIPMENT TYPE	MFR	MODEL NUMBER	SERIAL NUMBER	LAST CAL.	CAL DUE.
Test Receiver	Rohde & Schwarz	ESCS30	828985/018	05/29/2010	05/29/2011
L.I.S.N	Rohde & Schwarz	ESH2-Z5	834549/005	05/29/2010	05/29/2011
L.I.S.N	Rohde & Schwarz	ESH2-Z5	834549/005	05/29/2010	05/29/2011
50ΩCoaxial Switch	Anritsu	MP59B	M20531	05/29/2010	05/29/2011

4.4 Conducted Emission Limit

(7) Conducted Emission

Frequency(MHz)	Quasi-peak	Average
0.15-0.5	66-56	56-46
0.5-5.0	56	46
5.0-30.0	60	50

Note:

1. The lower limit shall apply at the transition frequencies
2. The limit decreases in line with the logarithm of the frequency in the range of 0.15 to 0.50MHz.

4.5 Measurement Result:

Date of Test: October 16, 2010 Temperature: 22
 Frequency Detector: 0.15~30MHz Humidity: 50%
 Test Result: PASS Test Mode: WIFI Mode

Test Line	Frequency MHz	Emission Level QP dB(μV)	Emission Level AV dB(μV)	Limits QP dB(μV)	Limits AV dB(μV)	Margin QP dB(μV)	Margin AV dB(μV)
Neutral	0.185	59.68	49.89	64.26	54.26	-4.58	-4.37
	0.28	55.31	44.88	60.82	50.82	-5.51	-5.94
	0.37	54.66	40.24	58.5	48.5	-3.84	-8.26
	0.47	51.98	33.71	56.51	46.51	-4.53	-12.8
	0.84	47.55	28.7	56	46	-8.45	-17.3
	17	52.95	40.34	60	50	-7.05	-9.66
Line	0.185	60.2	49.43	64.26	54.26	-4.06	-4.83
	0.285	56.86	45.39	60.67	50.67	-3.81	-5.28
	0.38	53.48	41.92	58.28	48.28	-4.8	-6.36
	0.48	52.45	32.22	56.34	46.34	-3.89	-14.12
	0.64	49.39	29.62	56	46	-6.61	-16.38
	16.92	54.34	43.69	60	50	-5.66	-6.31

4.6 Conducted Measurement Photos:



5. Radiated Emission Test

5.1 Measurement Procedure

1. The EUT was placed on a turn table which is 0.8m above ground plane.
2. Maximum procedure was performed on the six highest emissions to ensure EUT compliance.
3. And also, each emission was to be maximized by changing the polarization of receiving antenna both horizontal and vertical.
4. Repeat above procedures until all frequency measured were complete.

5.2 Test SET-UP (Block Diagram of Configuration)

(A) Radiated Emission Test Set-Up, Frequency Below 30MHz

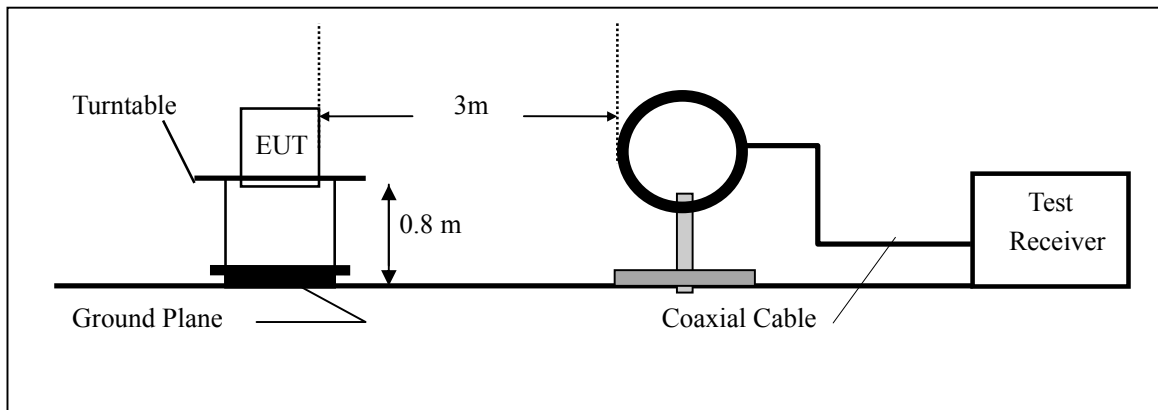

(B) Radiated Emission Test Set-Up, Frequency Below 1000MHz

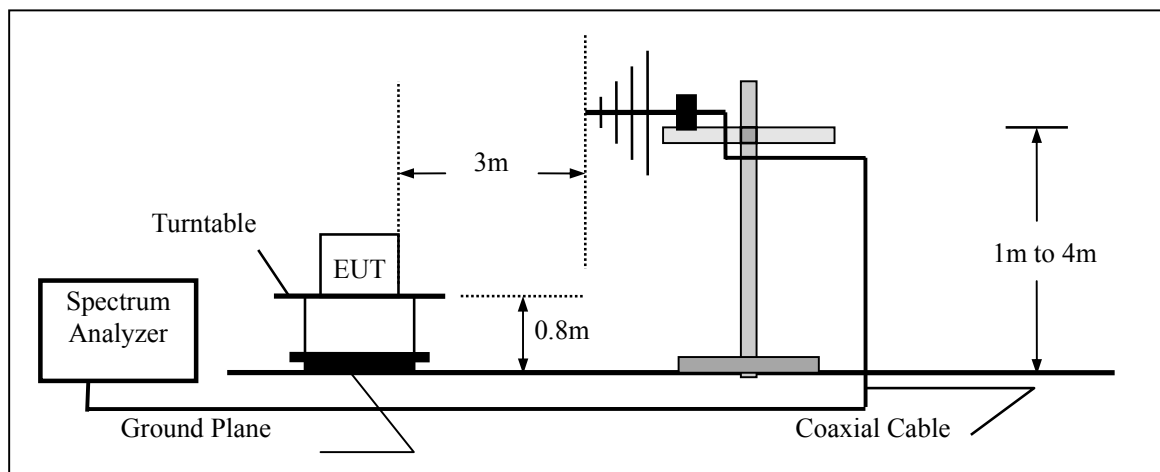

(C) Radiated Emission Test Set-Up, Frequency above 1000MHz

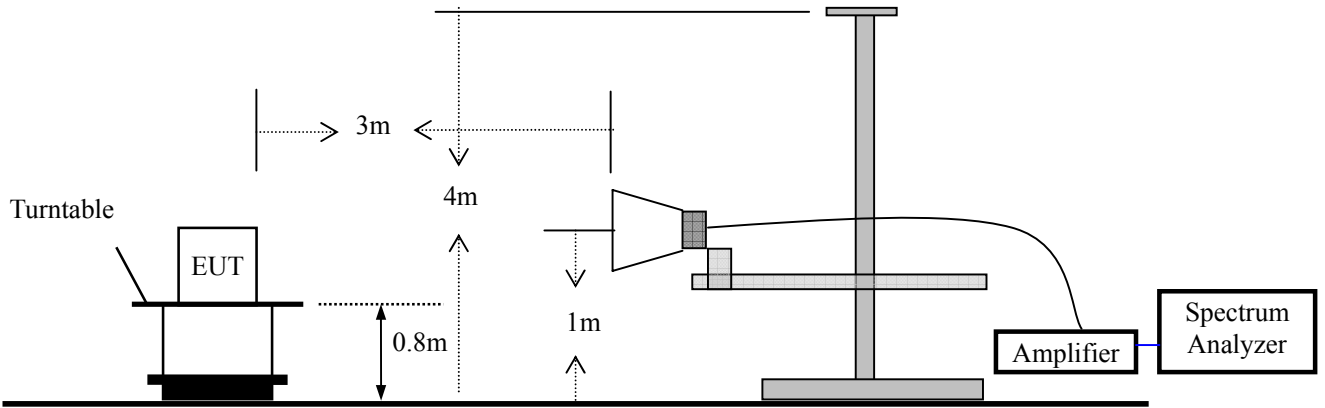

5.3 Measurement Equipment Used:

EQUIPMENT TYPE	MFR	MODEL NUMBER	SERIAL NUMBER	LAST CAL.	CAL DUE.
Spectrum Analyzer	Rohde & Schwarz	FSP7	839511/010	05/29/2010	05/29/2011
Spectrum Analyzer	HP	E4407B	839840481	05/29/2010	05/29/2011
EMI Test Receiver	Rohde & Schwarz	ESCS30	828985/018	05/29/2010	05/29/2011
Pre-Amplifier	HP	8447D	2944A07999	05/29/2010	05/29/2011
Bilog Antenna	Schwarzbeck	VULB9163	142	05/29/2010	05/29/2011
Loop Antenna	ARA	PLA-1030/B	1029	05/29/2010	05/29/2011
Horn Antenna	Electro-Metrics	EM-6961	103314	05/29/2010	05/29/2011
Horn Antenna	Schwarzbeck	BBHA 9120	D143	05/29/2010	05/29/2011

5.4 Radiated emission limit

FCC Class B Limit at 3m

Frequency MHz	Distance Meter	Field Strength uV/m	Field Strength dBuV/m
30~88	3	100	40.0
88~216	3	150	43.5
216~960	3	200	46.0
Above 960	3	500	54.0

Note: The frequencies above 1000MHz, as measured using instrumentation with a peak detector function was corresponding to 20dB above maximum permitted average limit.

5.5 Measurement Result

Operation Mode: 802.11b TX Channel 1 Test Date : 10/17/2010
 Frequency Range: 30~1000MHz Temperature : 28
 Test Result: PASS Humidity : 65 %
 Measured Distance: 3m Test By: KL

Freq. (MHz)	Ant.Pol. H/V	Emission Level (dBuV)	Limit 3m (dBuV/m)	Over (dB)	Note
207.2	V	41.29	43.5	-2.21	PK
371.98	V	42.08	46	-3.92	PK
390.64	V	44.66	46	-1.34	PK
423.28	V	41.13	46	-4.87	PK
494.79	V	43.79	46	-2.21	PK
598.94	V	42.45	46	-3.55	PK
168.34	H	42.17	43.5	-1.33	PK
260.06	H	44.25	46	-1.75	PK
284.93	H	43.17	46	-2.83	PK
371.98	H	43.61	46	-2.39	PK
441.93	H	44.89	46	-1.11	PK
703.09	H	44.98	46	-1.02	PK

- Note:**
- (1) All Readings are Peak Value.
 - (2) Emission Level= Reading Level+Probe Factor +Cable Loss
 - (3) The average measurement was not performed when the peak measured data under the limit of average detection.

Operation Mode: 802.11b TX Channel 6 Test Date : 10/17/2010
Frequency Range: 30~1000MHz Temperature : 28
Test Result: PASS Humidity : 65 %
Measured Distance: 3m Test By: WOLF

Freq. (MHz)	Ant.Pol. H/V	Emission Level (dBuV)	Limit 3m (dBuV/m)	Margin (dB)	Note
207.2	V	41.35	43.5	-2.15	PK
371.98	V	42.01	46	-3.99	PK
390.67	V	44.62	46	-1.38	PK
423.28	V	40.13	46	-5.87	PK
495.08	V	43.7	46	-2.3	PK
598.94	V	42.55	46	-3.45	PK
165.23	H	42.31	43.5	-1.19	PK
260.05	H	44.25	46	-1.75	PK
284.93	H	43.28	46	-2.72	PK
371.98	H	43.61	46	-2.39	PK
441.93	H	44.89	46	-1.11	PK
704.01	H	44.08	46	-1.92	PK

Note: (1) All Readings are Peak Value and AV.
(2) Emission Level= Reading Level+Probe Factor +Cable Loss
(3) The average measurement was not performed when the peak measured data under the limit of average detection.

Operation Mode: 802.11b TX Channel 11 Test Date : 10/17/2010
Frequency Range: 30~1000MHz Temperature : 28
Test Result: PASS Humidity : 65 %
Measured Distance: 3m Test By: WOLF

Freq. (MHz)	Ant.Pol. H/V	Emission Level (dBUV)	Limit 3m (dBUV/m)	Margin (dB)	Note
206.24	V	41.35	43.5	-2.15	PK
371.08	V	42.05	46	-3.95	PK
390.62	V	44.37	46	-1.63	PK
424.13	V	41.07	46	-4.93	PK
495.08	V	43.86	46	-2.14	PK
597.24	V	42.55	46	-3.45	PK
165.21	H	41.39	43.5	-2.11	PK
261.26	H	44.25	46	-1.75	PK
284.93	H	43.79	46	-2.21	PK
371.33	H	43.61	46	-2.39	PK
442.56	H	44.38	46	-1.62	PK
703.45	H	43.88	46	-2.12	PK

- Note:**
- (1) All Readings are Peak Value and AV.
 - (2) Emission Level= Reading Level+Probe Factor +Cable Loss
 - (3) The average measurement was not performed when the peak measured data under the limit of average detection.

Operation Mode: 802.11g TX Channel 1 Test Date : 10/17/2010
Frequency Range: 30~1000MHz Temperature : 28
Test Result: PASS Humidity : 65 %
Measured Distance: 3m Test By: WOLF

Freq. (MHz)	Ant.Pol. H/V	Emission Level (dBuV)	Limit 3m (dBuV/m)	Margin (dB)	Note
168.34	V	41.31	43.5	-2.19	PK
265.87	V	43.11	46	-2.89	PK
390.62	V	43.65	46	-2.35	PK
425.26	V	40.21	46	-5.79	PK
495.08	V	43.86	46	-2.14	PK
701.23	V	42.55	46	-3.45	PK
165.21	H	41.39	43.5	-2.11	PK
266.34	H	44.25	46	-1.75	PK
284.87	H	43.87	46	-2.13	PK
371.3	H	42.59	46	-3.41	PK
443.65	H	44.01	46	-1.99	PK
703.45	H	42.67	46	-3.33	PK

- Note:**
- (1) All Readings are Peak Value.
 - (2) Emission Level= Reading Level+Probe Factor +Cable Loss
 - (3) The average measurement was not performed when the peak measured data under the limit of average detection.

Operation Mode: 802.11g TX Channel 6 Test Date : 10/17/2010
 Frequency Range: 30~1000MHz Temperature : 28
 Test Result: PASS Humidity : 65%
 Measured Distance: 3m Test By: WOLF

Freq. (MHz)	Ant.Pol. H/V	Emission Level (dBUV)	Limit 3m (dBUV/m)	Margin (dB)	Note
165.2	V	41.31	43.5	-2.19	PK
264.17	V	43.18	46	-2.82	PK
390.58	V	43.65	46	-2.35	PK
425.26	V	40.36	46	-5.64	PK
495.67	V	42.05	46	-3.95	PK
703.44	V	42.89	46	-3.11	PK
164.09	H	41.39	43.5	-2.11	PK
266.28	H	44.08	46	-1.92	PK
283.66	H	41.99	46	-4.01	PK
370.35	H	43.07	46	-2.93	PK
443.57	H	43.67	46	-2.33	PK
703.17	H	42.61	46	-3.39	PK

- Note:**
- (1) All Readings are Peak Value and AV.
 - (2) Emission Level= Reading Level+Probe Factor +Cable Loss
 - (3) The average measurement was not performed when the peak measured data under the limit of average detection.

Operation Mode: 802.11g TX Channel 11 Test Date : 10/17/2010
 Frequency Range: 30~1000MHz Temperature : 28
 Test Result: PASS Humidity : 65 %
 Measured Distance: 3m Test By: WOLF

Freq. (MHz)	Ant.Pol. H/V	Emission Level (dBuV)	Limit 3m (dBuV/m)	Margin (dB)	Note
165.07	V	41.01	43.5	-2.49	PK
265.538	V	43.25	46	-2.75	PK
390.88	V	43.78	46	-2.22	PK
425.26	V	41.78	46	-4.22	PK
495.67	V	42.05	46	-3.95	PK
703.44	V	42.8	46	-3.2	PK
164.55	H	42.18	43.5	-1.32	PK
278.14	H	44.22	46	-1.78	PK
284.26	H	41.93	46	-4.07	PK
370.55	H	43.28	46	-2.72	PK
443.51	H	43.67	46	-2.33	PK
696.38	H	42.61	46	-3.39	PK

- Note:**
- (1) All Readings are Peak Value and AV.
 - (2) Emission Level= Reading Level+Probe Factor +Cable Loss
 - (3) The average measurement was not performed when the peak measured data under the limit of average detection.

Operation Mode: 802.11b TX Channel 1 Test Date : 10/17/2010
 Frequency Range: Above 1GHz Temperature : 28
 Test Result: PASS Humidity : 65 %
 Measured Distance: 3m Test By: WOLF

Freq. (MHz)	Ant.Pol. H/V	Emission Level(dBuV)		Limit 3m(dBuV/m)		Margin(dB)	
		PK	AV	PK	AV	PK	AV
7826.92	V	51.4	39.42	74	54	-22.6	-14.58
9250	V	54.04	42.41	74	54	-19.96	-11.59
11019.23	V	56.6	44.84	74	54	-17.4	-9.16
--	V	--	--	--	--	--	--
--	V	--	--	--	--	--	--
--	V	--	--	--	--	--	--
9057.69	H	52.6	40.61	74	54	-21.4	-13.39
10923.07	H	55.65	44.57	74	54	-18.35	-9.43
12923.07	H	54.36	11.07	74	54	-19.64	-42.93
--	H	--	--	--	--	--	--
--	H	--	--	--	--	--	--
--	H	--	--	--	--	--	--

All emissions not reported were more than 20dB below the specified limit or in the noise floor.

- Note:**
- (1) All Readings are Peak Value and AV.
 - (2) Emission Level= Reading Level+Probe Factor +Cable Loss
 - (3) Data of measurement within this frequency range shown “ -- ” in the table above means the reading of emissions are attenuated more than 20dB below the permissible limits or the field strength is too small to be measured.

Operation Mode: 802.11b(Channel 6) Test Date : 10/17/2010
 Frequency Range: Above 1GHz Temperature : 28
 Test Result: PASS Humidity : 65 %
 Measured Distance: 3m Test By: WOLF

Freq. (MHz)	Ant.Pol. H/V	Emission Level(dBuV)		Limit 3m(dBuV/m)		Margin(dB)	
		PK	AV	PK	AV	PK	AV
7423.07	V	50.62	38	74	54	-23.38	-16
9769.23	V	54.45	43.06	74	54	-19.55	-10.94
11000	V	55.28	44.31	74	54	-18.72	-9.69
--	V	--	--	--	--	--	--
--	V	--	--	--	--	--	--
--	V	--	--	--	--	--	--
9596.15	H	53.23	42.51	74	54	-20.77	-11.49
10134.16	H	54.42	43.44	74	54	-19.58	-10.56
11442.3	H	53.9	42.89	74	54	-20.1	-11.11
--	H	--	--	--	--	--	--
--	H	--	--	--	--	--	--
--	H	--	--	--	--	--	--

All emissions not reported were more than 20dB below the specified limit or in the noise floor.

- Note:**
- (1) All Readings are Peak Value and AV.
 - (2) Emission Level= Reading Level+Probe Factor +Cable Loss
 - (3) Data of measurement within this frequency range shown “ -- ” in the table above means the reading of emissions are attenuated more than 20dB below the permissible limits or the field strength is too small to be measured.

Operation Mode: 802.11b(Channel 11) Test Date : 10/17/2010
 Frequency Range: Above 1GHz Temperature : 28
 Test Result: PASS Humidity : 65 %
 Measured Distance: 3m Test By: WOLF

Freq. (MHz)	Ant.Pol. H/V	Emission Level(dBuV)		Limit 3m(dBuV/m)		Margin(dB)	
		PK	AV	PK	AV	PK	AV
9730.76	V	54.27	42.94	74	54	-19.73	-11.06
11192.3	V	54.95	43.2	74	54	-19.05	-10.8
12807.69	V	55.77	43.33	74	54	-18.23	-10.67
--	V	--	--	--	--	--	--
--	V	--	--	--	--	--	--
--	V	--	--	--	--	--	--
7442.3	H	49.7	38.13	74	54	-24.3	-15.87
8019.23	H	50.04	39.13	74	54	-23.96	-14.87
9134.61	V	52.68	41.14	74	54	-21.32	-12.86
--	H	--	--	--	--	--	--
--	H	--	--	--	--	--	--
--	H	--	--	--	--	--	--

No others harmonics emissions are higher than 20dB below the limits of 47 CFR Part 15.247.

- Note:**
- (1) All Readings are Peak Value and AV.
 - (2) Emission Level= Reading Level+Probe Factor +Cable Loss
 - (3) Data of measurement within this frequency range shown “ -- ” in the table above means the reading of emissions are attenuated more than 20dB below the permissible limits or the field strength is too small to be measured.

Operation Mode: 802.11g TX Channel 1 Test Date : 10/17/2010
 Frequency Range: Above 1GHz Temperature : 28
 Test Result: PASS Humidity : 65 %
 Measured Distance: 3m Test By: WOLF

Freq. (MHz)	Ant.Pol. H/V	Emission Level(dBuV)		Limit 3m(dBuV/m)		Margin(dB)	
		PK	AV	PK	AV	PK	AV
9365.38	V	54.91	42.27	74	54	-19.09	-11.73
11019.23	V	57.12	44.33	74	54	-16.88	-9.67
12461.53	V	56.16	43.12	74	54	-17.84	-10.88
--	V	--	--	--	--	--	--
--	V	--	--	--	--	--	--
--	V	--	--	--	--	--	--
7673.07	H	48.97	37.88	74	54	-25.03	-16.12
9480.76	H	53.09	41.74	74	54	-20.91	-12.26
11250	H	55.05	42.66	74	54	-18.95	-11.34
--	H	--	--	--	--	--	--
--	H	--	--	--	--	--	--
--	H	--	--	--	--	--	--

All emissions not reported were more than 20dB below the specified limit or in the noise floor.

- Note:**
- (1) All Readings are Peak Value and AV.
 - (2) Emission Level= Reading Level+Probe Factor +Cable Loss
 - (3) Data of measurement within this frequency range shown “ -- ” in the table above means the reading of emissions are attenuated more than 20dB below the permissible limits or the field strength is too small to be measured.

Operation Mode: 802.11g(Channel 6) Test Date : 10/17/2010
 Frequency Range: Above 1GHz Temperature : 28
 Test Result: PASS Humidity : 65 %
 Measured Distance: 3m Test By: Andy

Freq. (MHz)	Ant.Pol. H/V	Emission Level(dBuV)		Limit 3m(dBuV/m)		Margin(dB)	
		PK	AV	PK	AV	PK	AV
7788.46	V	50	38.72	74	54	-24	-15.28
9846.15	V	54.74	43.7	74	54	-19.26	-10.3
11461.53	V	54.75	42.98	74	54	-19.25	-11.02
--	V	--	--	--	--	--	--
--	V	--	--	--	--	--	--
--	V	--	--	--	--	--	--
7442.3	H	51.45	39	74	54	-22.55	-15
9942	H	55.47	43.96	74	54	-18.53	-10.04
10846.15	H	56.91	44.28	74	54	-17.09	-9.72
--	H	--	--	74	54	--	--
--	H	--	--	74	54	--	--
--	H	--	--	74	54	--	--

All emissions not reported were more than 20dB below the specified limit or in the noise floor.

- Note:**
- (1) All Readings are Peak Value and AV.
 - (2) Emission Level= Reading Level+Probe Factor +Cable Loss
 - (3) Data of measurement within this frequency range shown “ -- ” in the table above means the reading of emissions are attenuated more than 20dB below the permissible limits or the field strength is too small to be measured.

Operation Mode: 802.11g(Channel 11) Test Date : 10/17/2010
 Frequency Range: Above 1GHz Temperature : 28
 Test Result: PASS Humidity : 65 %
 Measured Distance: 3m Test By: Andy

Freq. (MHz)	Ant.Pol. H/V	Emission Level(dBuV)		Limit 3m(dBuV/m)		Margin(dB)	
		PK	AV	PK	AV	PK	AV
7250	V	49.37	38.51	74	54	-24.63	-15.49
9980	V	55	44.12	74	54	-19	-9.88
11000	V	55.29	44.28	74	54	-18.71	-9.72
--	V	--	--	--	--	--	--
--	V	--	--	--	--	--	--
--	V	--	--	--	--	--	--
6096.15	H	45.03	34.24	74	54	-28.97	-19.76
7826.92	H	51.14	38.52	74	54	-22.86	-15.48
9865.38	H	54.63	43.33	74	54	-19.37	-10.67
--	H	--	--	--	--	--	--
--	H	--	--	--	--	--	--
--	H	--	--	--	--	--	--

No others harmonics emissions are higher than 20dB below the limits of 47 CFR Part 15.247.

- Note:**
- (1) All Readings are Peak Value and AV.
 - (2) Emission Level= Reading Level+Probe Factor +Cable Loss
 - (3) Data of measurement within this frequency range shown “ -- ” in the table above means the reading of emissions are attenuated more than 20dB below the permissible limits or the field strength is too small to be measured.

5.6 Radiated Measurement Photos:

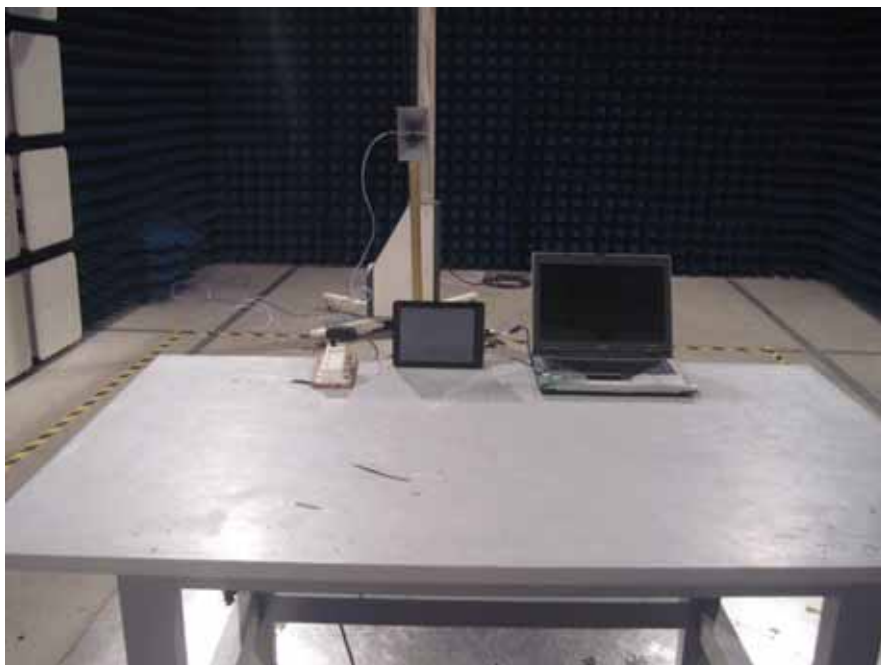

6. Occupied Bandwidth test

6.1 Measurement Procedure

The EUT was operating in IEEE 802.11b/g mode or could be controlled its channel. Printed out the test result from the spectrum by hard copy function.

6.2 Test SET-UP (Block Diagram of Configuration)

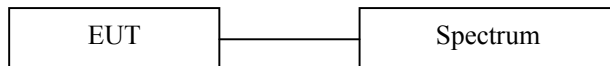

6.3 Measurement Equipment Used:

Same as 4.3 Radiated Emission Measurement.

6.4 Limit

The minimum 6dB bandwidth shall be at least 500kHz.

6.5 Measurement Results:

Refer to attached data chart.

Spectrum Detector:	PK	Test Date :	10/14/2010
Test By:	Andy	Temperature :	28
Test Result:	PASS	Humidity :	65 %
Operation Mode:	802.11b		

Channel number	Channel frequency (MHz)	Measurement level (MHz)	Required Limit (KHz)
1	2412	10.25	>500
6	2437	10.30	>500
11	2462	10.50	>500

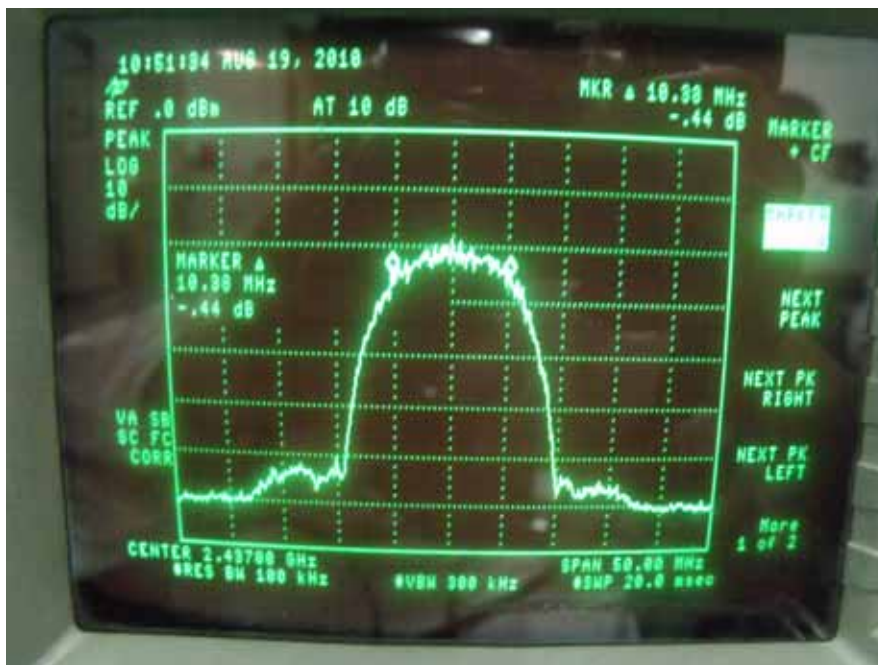
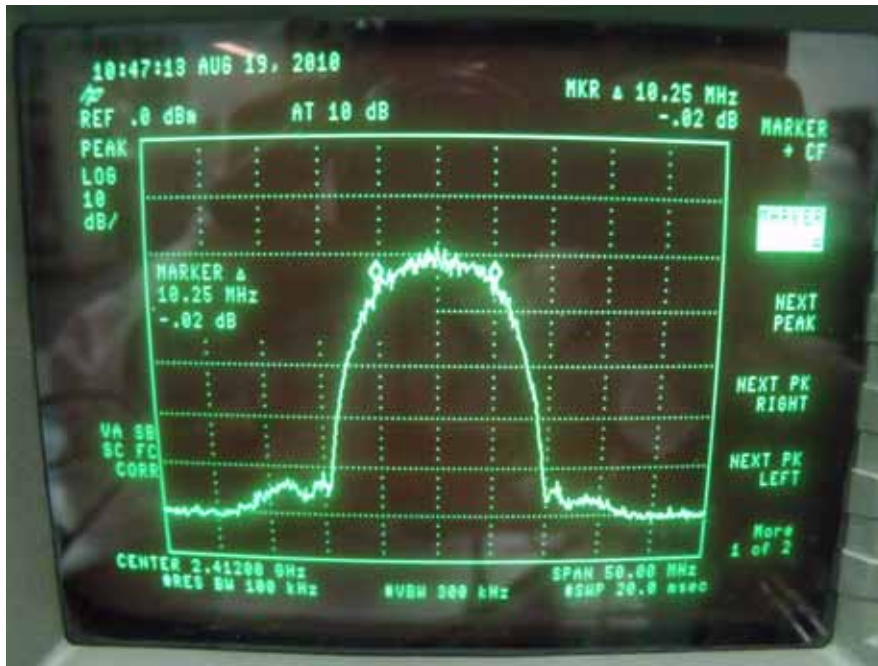

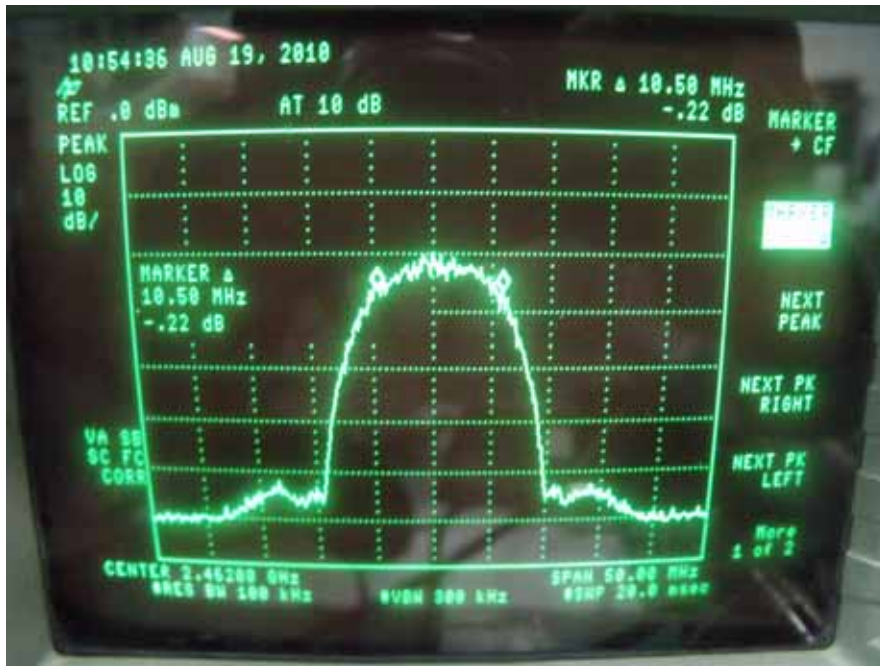

Spectrum Detector: PK Test Date : 10/14/2010
 Test By: Andy Temperature : 28
 Test Result: PASS Humidity : 65 %
 Operation Mode: 802.11 g

Channel number	Channel frequency (MHz)	Measurement level (MHz)	Required Limit (KHz)
1	2412	16.63	>500
6	2437	16.38	>500
11	2462	16.25	>500

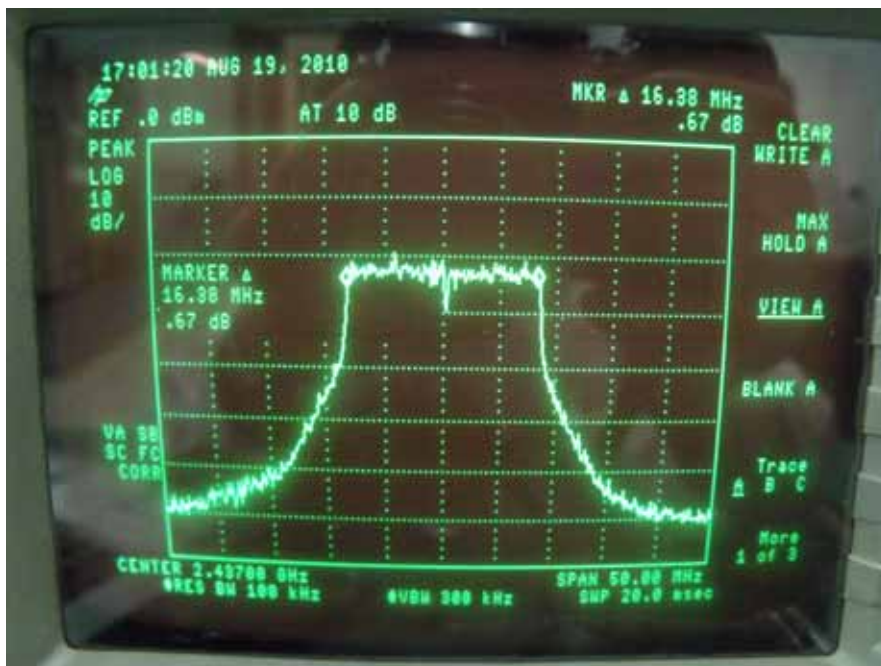
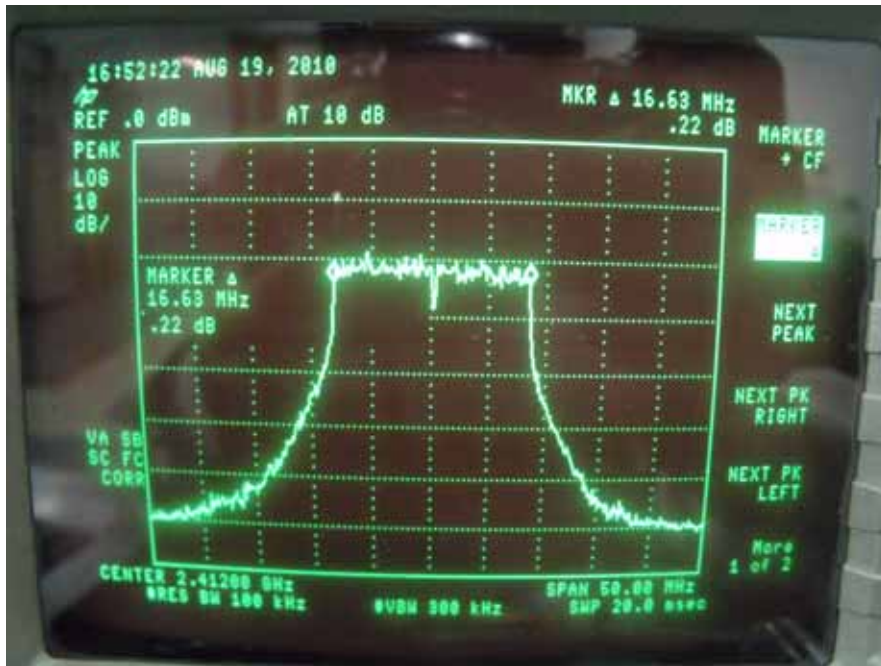

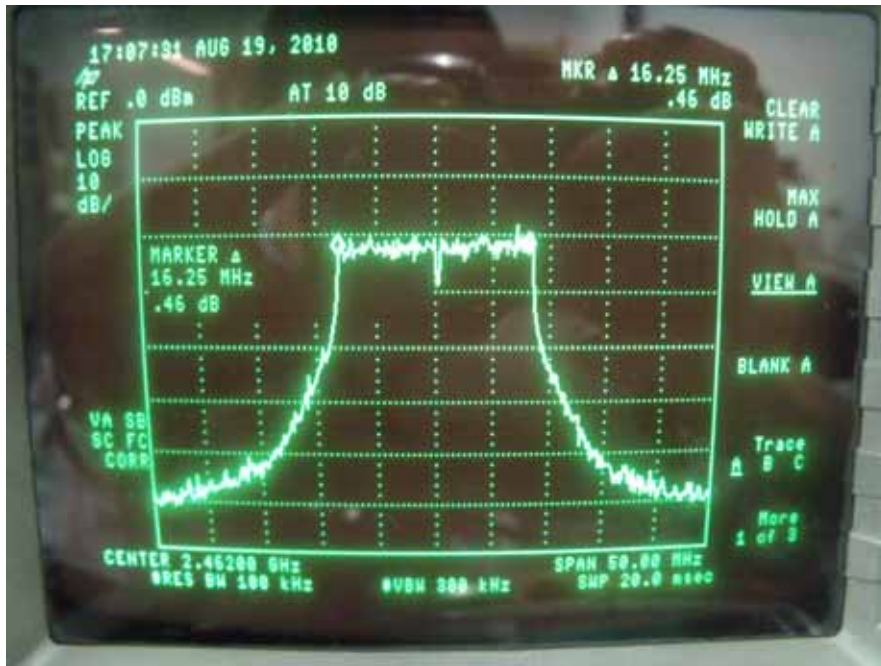

7. MAXIMUM PEAK OUTPUT POWER TEST

7.1 Measurement Procedure

- a. The Transmitter output (antenna port) was connected to the power meter.
- b. Turn on the EUT and power meter and then record the peak power value.
- c. Repeat above procedures on all channels needed to be tested.

7.2 Test SET-UP (Block Diagram of Configuration)

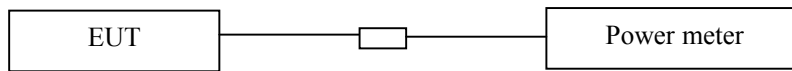

7.3 Measurement Equipment Used:

EQUIPMENT TYPE	MFR	MODEL NUMBER	SERIAL NUMBER	LAST CAL.	CAL DUE.
Power meter	Boonton	4232A	29001	05/29/2010	05/29/2011
Power sensor	Boonton	51011-EMC	31184	05/29/2010	05/29/2011

7.4 Peak Power output limit

The maximum peak power shall be less 1Watt.

7.5 Measurement Results:

Spectrum Detector: PK Test Date : 10/17/2010
 Test By: Andy Temperature : 28
 Test Result: PASS Humidity : 65 %
 Operation Mode: 802.11b

Channel number	Channel Frequency (MHz)	Peak Power output(dBm)	Peak Power Limit(W)	Pass/Fail
1	2412.00	15.56	1W(30dBm)	PASS
6	2437.00	15.35	1W(30dBm)	PASS
11	2462.00	15.44	1W(30dBm)	PASS

Spectrum Detector: PK Test Date : 10/17/2010
Test By: Andy Temperature : 28
Test Result: PASS Humidity : 65 %
Operation Mode: 802.11g

Channel number	Channel Frequency (MHz)	Peak Power output(dBm)	Peak Power Limit(W)	Pass/Fail
1	2412.00	13.76	1W(30dBm)	PASS
6	2437.00	13.53	1W(30dBm)	PASS
11	2462.00	13.81	1W(30dBm)	PASS

8. Band EDGE test

8.1 Measurement Procedure

1. The EUT was Operating in hopping mode or could be controlled its channel. Printed out test result from the spectrum by hard copy function.
2. The EUT was placed on a turn table which is 0.8m above ground plane.
3. Maximum procedure was performed on the six highest emissions to ensure EUT compliance.
4. And also, each emission was to be maximized by changing the polarization of receiving antenna both horizontal and vertical.
5. Repeat above procedures until all frequency measured were complete.

8.2 Test SET-UP (Block Diagram of Configuration)

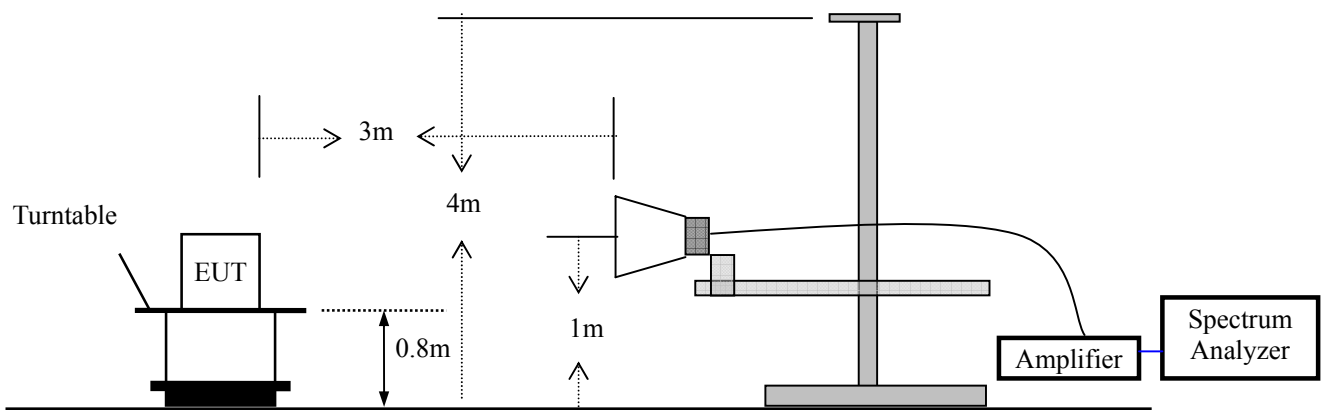

8.3 Measurement Equipment Used:

Same as 4.3 Radiated Emission Measurement.

8.4 Measurement Results:

Refer to attached data chart.

Spectrum Detector: PK Test Date : 10/14/2010
 Test By: Andy Temperature : 28
 Test Result: PASS Humidity : 65 %
 Operation Mode: 802.11b

1. Conducted Test

Frequency (MHz)	Peak Power Output(dBm)	Emission read Value(dBm)	Result of Band edge(dBc)	Band edge Limit(dBc)
<2400	-21.02	-68.51	47.49	>20dBc
>2483.5	-25.93	-70.75	44.82	>20dBc

2. Radiated emission test

Frequency (MHz)	Antenna polarization (H/V)	Emission (dBuV/m)		Band edge Limit (dBuV/m)	
		PK	AV	PK	AV
<2400	H	56.37	44.86	74.00	54.00
>2483.5	H	53.23	42.51	74.00	54.00





Spectrum Detector: PK Test Date : 10/14/2010
 Test By: Andy Temperature : 28
 Test Result: PASS Humidity : 65 %
 Operation Mode: 802.11g

1. Conducted Test

Frequency (MHz)	Peak Power Output(dBm)	Emission read Value(dBm)	Result of Band edge(dBc)	Band edge Limit(dBc)
<2400	-33.01	-68.24	35.23	>20dBc
>2483.5	-39.62	-70.31	30.69	>20dBc

2. Radiated emission test

Frequency (MHz)	Antenna polarization (H/V)	Emission (dBuV/m)		Band edge Limit (dBuV/m)	
		PK	AV	PK	AV
<2400	H	54.37	43.86	74.00	54.00
>2483.5	H	52.23	41.51	74.00	54.00

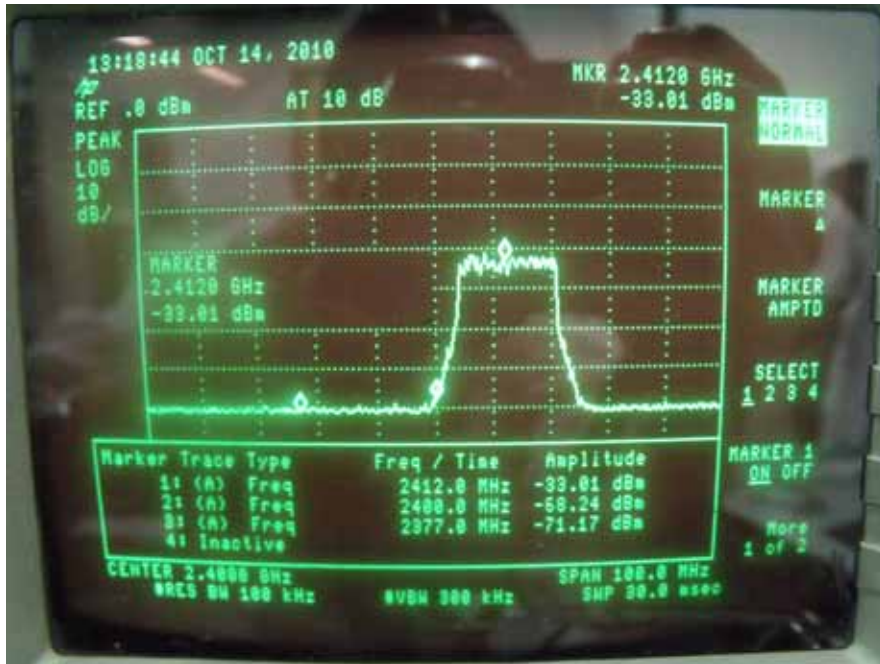

9. Power density

9.1 Test Equipment

EQUIPMENT TYPE	MFR	MODEL NUMBER	SERIAL NUMBER	LAST CAL.	CAL DUE.
Spectrum Analyzer	HP	8594E	88156318	05/29/2010	05/29/2011

9.2 Measuring Instruments and setting

The following table is the setting of spectrum analyzer.

Spectrum analyzer	Setting
Attenuation	Auto
Span Frequency	300kHz
RB	3kHz
VB	30kHz
Detector	Peak
Trace	Max hold
Sweep Time	100s

9.3 Test Procedures

- The transmitter output (antenna port) was connected to the spectrum analyzer.
- Set RBW of spectrum analyzer to 3kHz and VBW to 30kHz, Set Detector to Peak, Trace to Max Hold.
- Mark the frequency with maximum peak power as the center of the display of the spectrum.
- Set the span to 300kHz and the sweep time to 100s and record the maximum peak value.

9.4 Block Diagram of Test setup

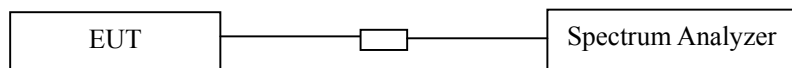

9.5 Limit

The transmitted power density averaged over any 1 second interval shall not be greater +8dBm in any 3KHz bandwidth.

9.6. Test Result

Spectrum Detector: PK Test Date : 10/14/2010
 Test By: Andy Temperature : 28
 Test Result: PASS Humidity : 65 %
 Operation Mode: 802.11 b

Frequency (MHz)	Measurement Level (dBm)	Required limit (dBm)	Result
2411.00	-19.77	<8dBm	PASS
2436.00	-19.88	<8dBm	PASS
2461.00	-20.48	<8dBm	PASS

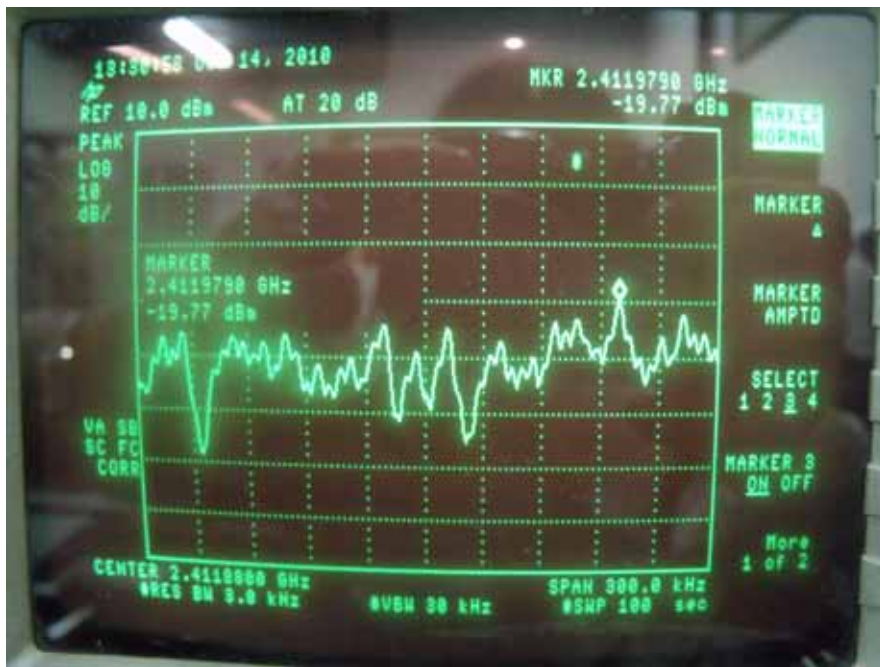

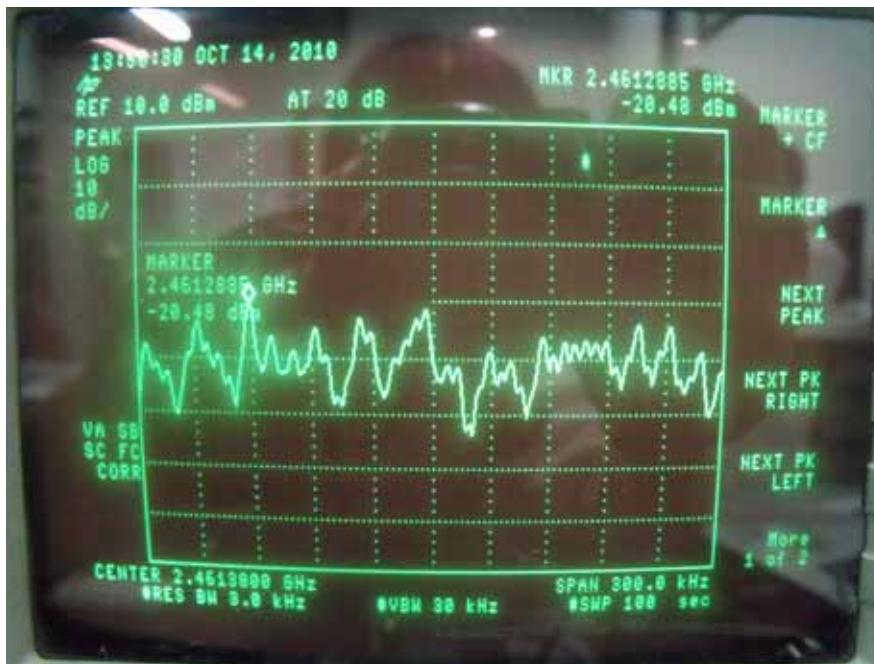
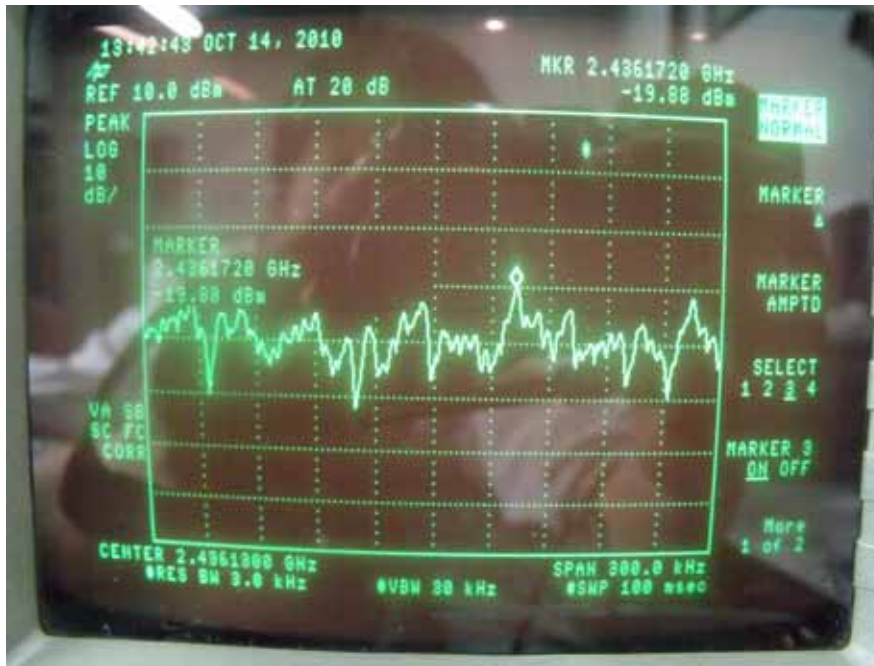

Spectrum Detector: PK Test Date : 10/14/2010
 Test By: Andy Temperature : 28
 Test Result: PASS Humidity : 65 %
 Operation Mode: 802.11 g

Frequency (MHz)	Measurement Level (dBm)	Required limit (dBm)	Result
2416.00	-28.01	<8dBm	PASS
2435.00	-28.28	<8dBm	PASS
2457.00	-28.96	<8dBm	PASS

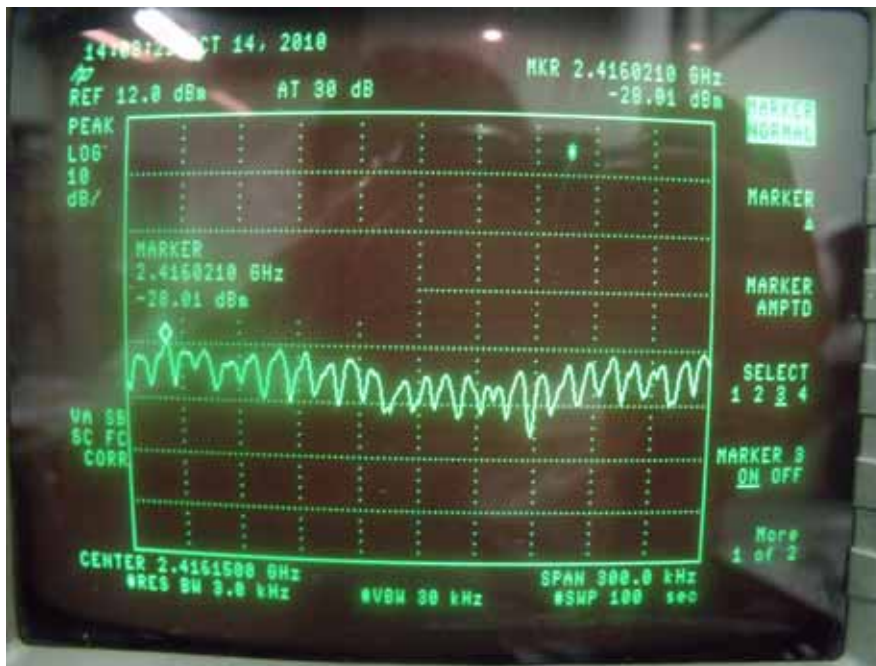

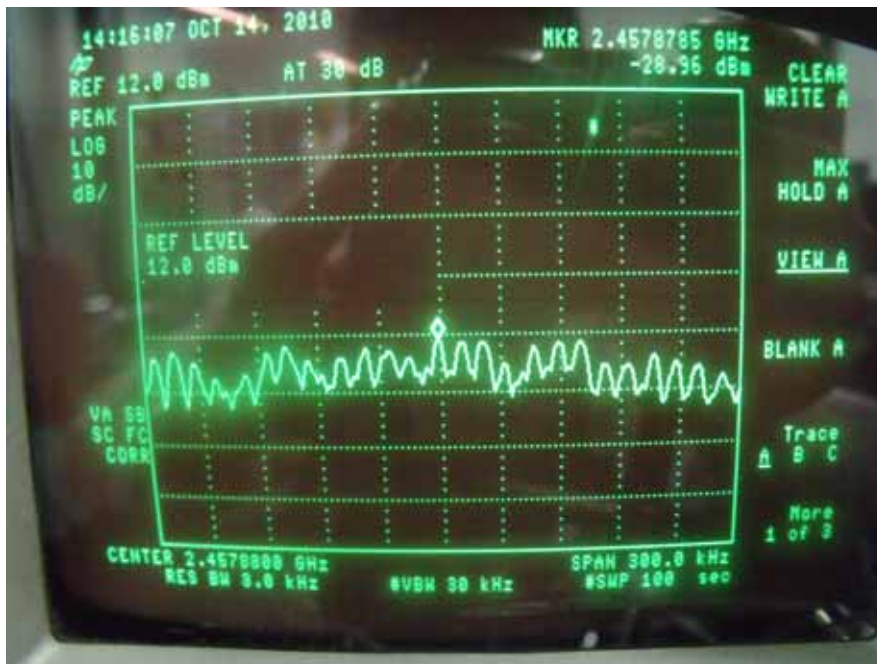
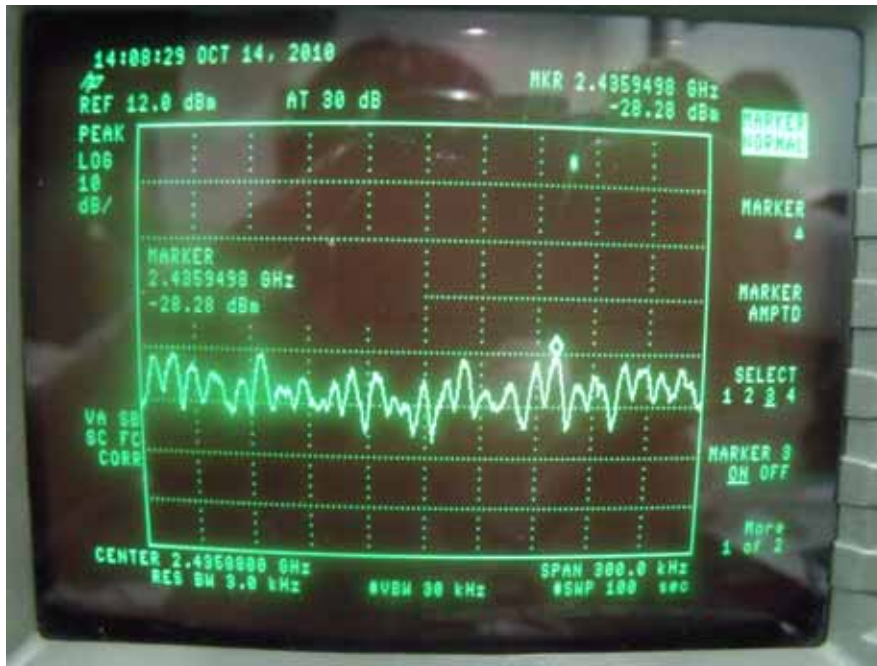

10. Antenna Port Emission

10.1 Test Equipment

EQUIPMENT TYPE	MFR	MODEL NUMBER	SERIAL NUMBER	LAST CAL.	CAL DUE.
EMI Test Receiver	Rohde & Schwarz	ESU	1302.6005.26	05/29/2010	05/29/2011

10.2 Measuring Instruments and setting

The following table is the setting of spectrum analyzer.

Spectrum analyzer	Setting
Attenuation	Auto
RB	100kHz
VB	300kHz
Detector	Peak
Trace	Max hold

10.3 Test Procedures

The conducted spurious emissions were measured conducted using a spectrum analyzer at low, mid, and hi channels, The limit was determined by attenuation 20dB of the RF peak power output.

10.4 Block Diagram of Test setup

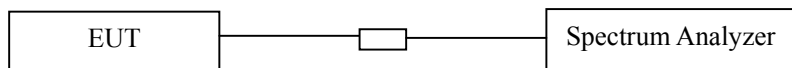

10.6. Test Result

PASS.

802.11b Low Channel 1



802.11b Mid Channel 6

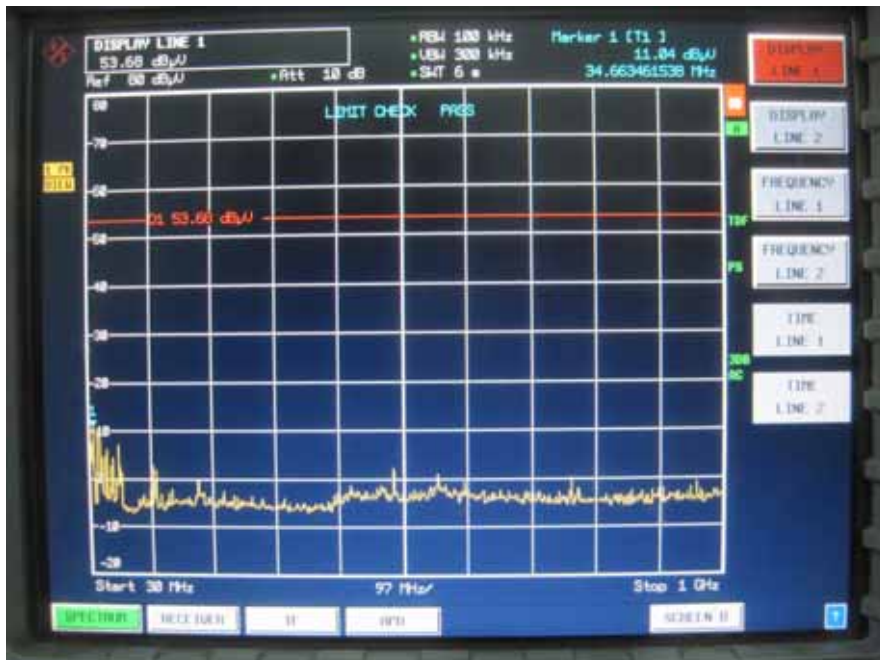
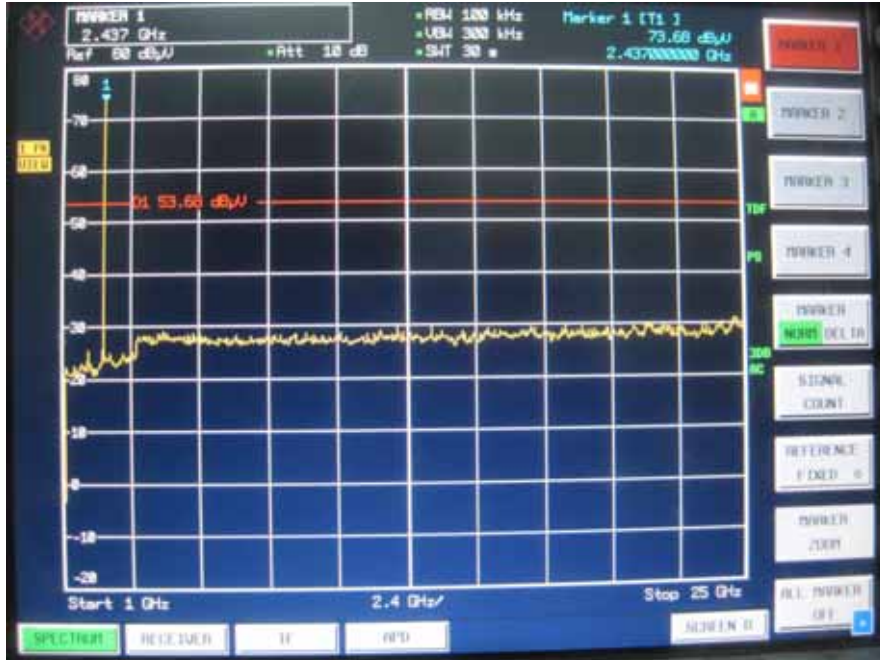

802.11b Hi Channel 11

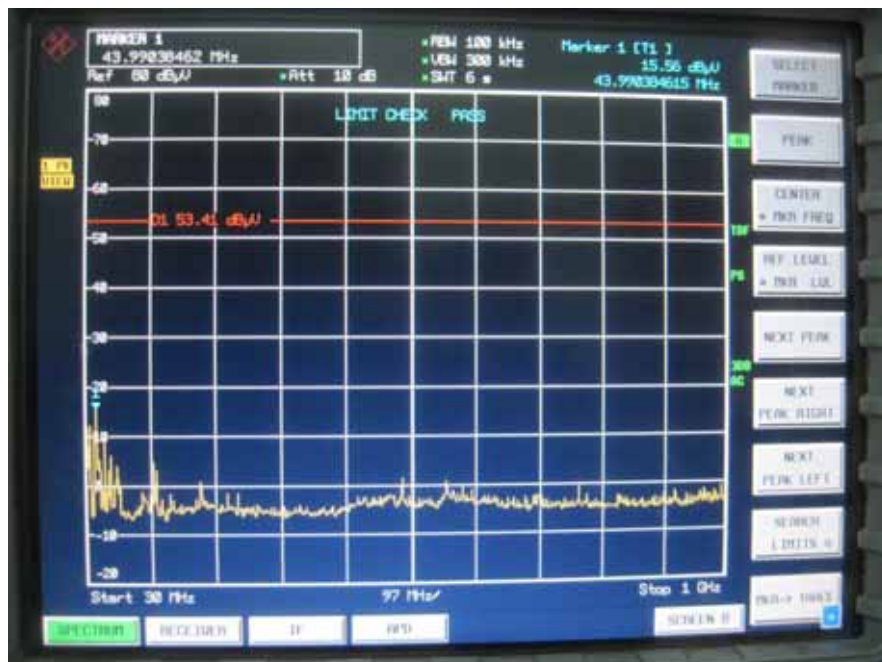
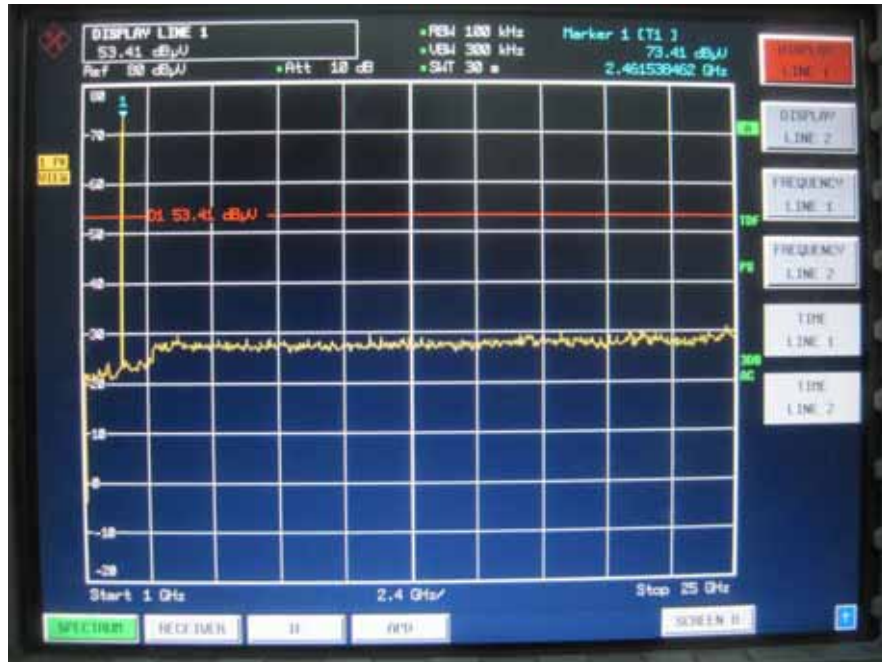

802.11g Low Channel 1

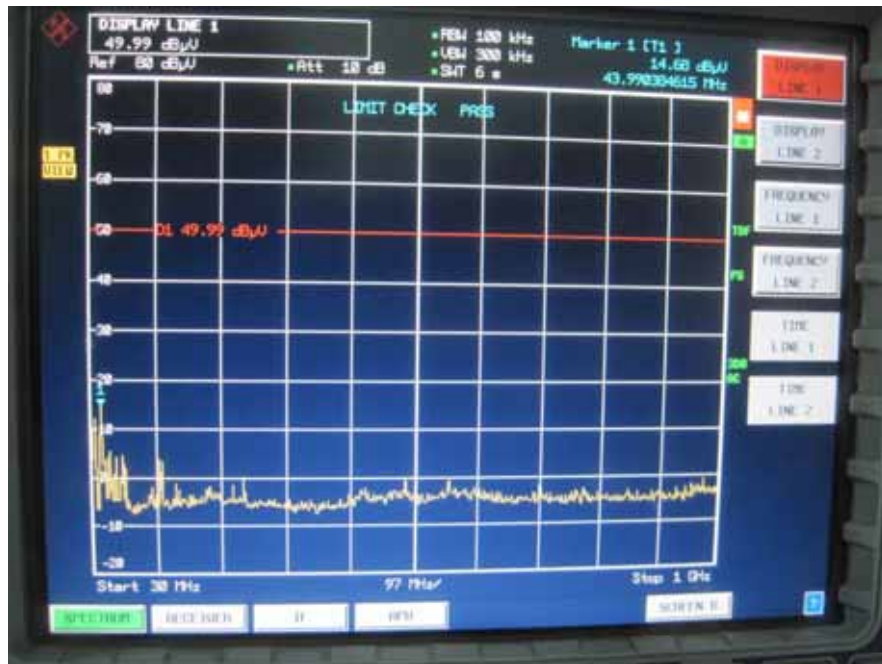
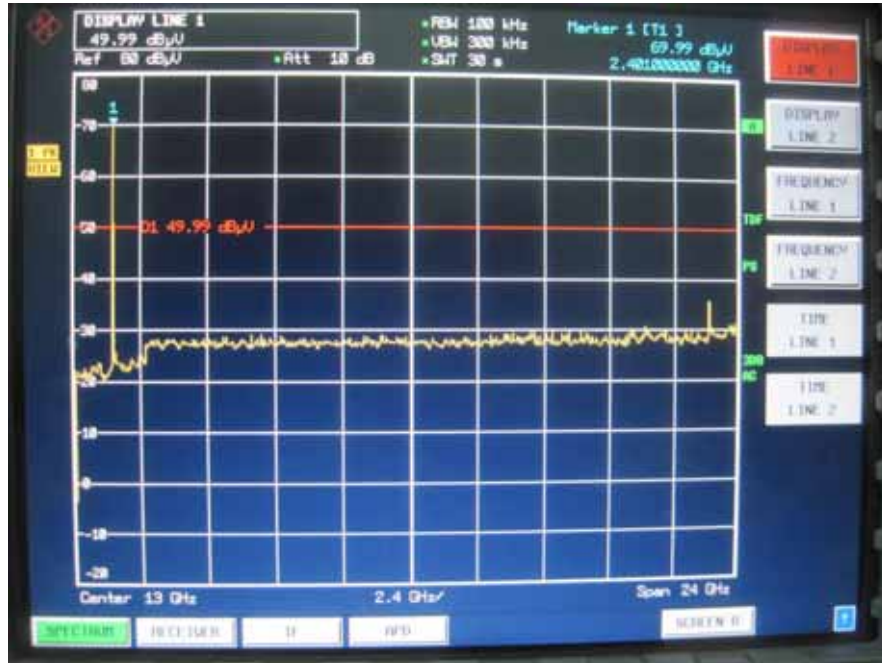

802.11g Mid Channel 6

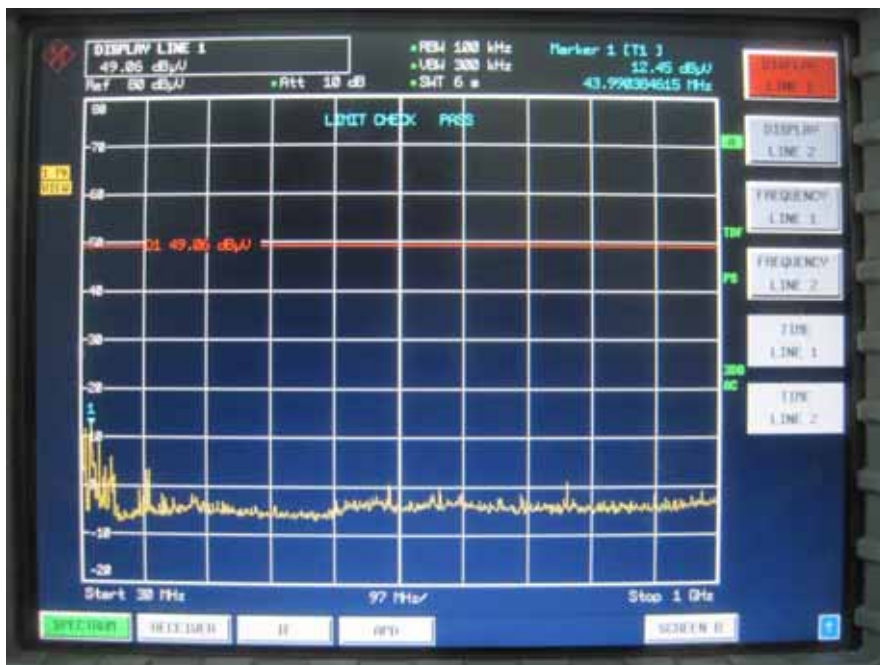
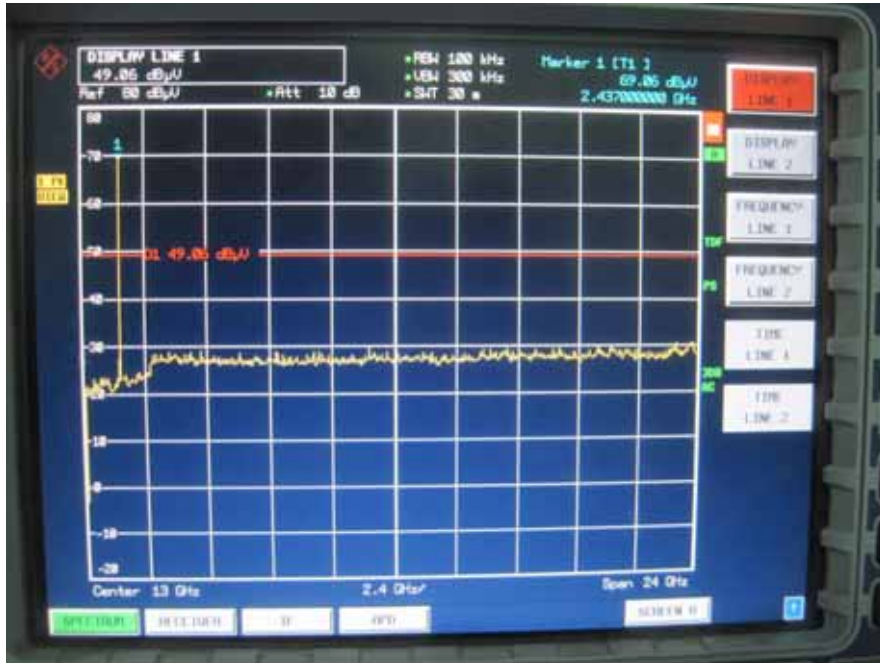

802.11b Hi Channel 11

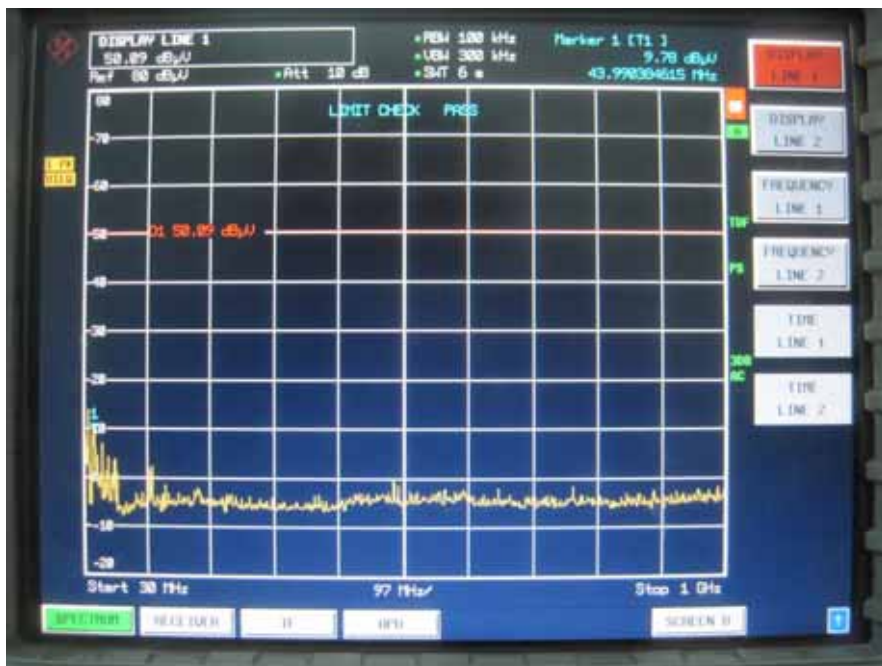
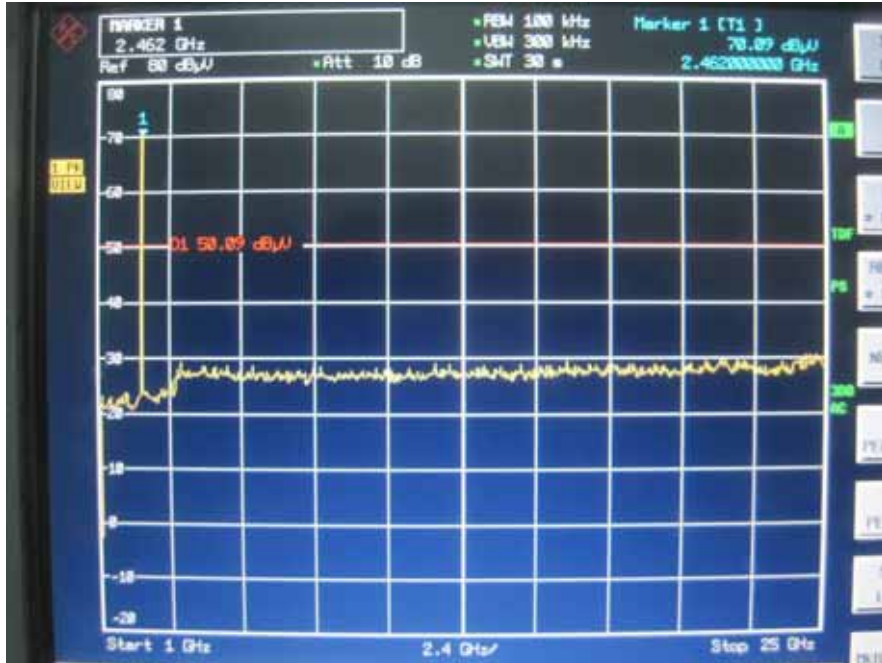

11. Antenna Application

11.1 Antenna requirement

The EUT'S antenna is met the requirement of FCC part 15C section 15.203.

11.2 Result

The EUT'S antenna is Chip antenna on PCB. The antenna's gain is 0dBi and meets the requirement.