

# TEST REPORT

## FCC RULES Part 15 Subpart C

Report File No. : STROR-06-048  
Date of Issue : 2006-06-05  
Kind of Product : Bluetooth Serial Adaptor  
Model Name : Promi SD205-OA  
FCC ID : S7APROMISD205OA  
Manufacturer : SENA Technologies, Inc.  
Serial No. :           -            
Test Result : Complied

---

This report details the results of the testing carried out on one sample, the results contained in this test report do not relate to other samples of the same product. The manufacturer should ensure that all products in series production are in conformity with the product sample detailed in this report. This report may only be reproduced and distributed in full. If the product in this report is used in any configuration other than that detailed in the report, the manufacturer must ensure the new system complies with all relevant standards. Any mention of SGS Testing Korea Co., Ltd. or testing done by SGS Testing Korea Co., Ltd. in connection with distribution or use of the product described in this report must be approved by SGS Testing Korea Co., Ltd. in writing.

---

*The results shown in this test report refer only to the sample(s) tested unless otherwise stated. This test report cannot be reproduced, except in full, without prior written permission of the Company.*

## VERIFICATION OF COMPLIANCE

**Applicant :** SENA Technologies, Inc.  
**Kind of Product :** Bluetooth Serial Adaptor  
**Brand Name :** -  
**Model Name :** Promi SD205-OA  
**Model Difference :** -  
**Report File No. :** STROR-06-048  
**Date of test :** May 10, 2006 ~ June 01, 2006  
**Receiver EUT :** -

APPLICABLE STANDARDS	
STANDARD	TEST RESULT
Part 15, Subpart B and Subpart C §15.247	Complied

The above equipment was tested by SGS Testing Korea Co., Ltd. for compliance with the requirements set forth in the FCC RULES Part 15, Subpart B and Subpart C §15.247. The results of testing in this report apply to the product system that was tested only. Other similar equipment will not necessarily produce the same results due to production tolerance and measurement uncertainties.

*Tested By:*



*Date*

**June 05, 2006**

\_\_\_\_\_  
*Feel Jeong*

*Approved By*



*Date*

**June 05, 2006**

\_\_\_\_\_  
*Albert Lim*

*The results shown in this test report refer only to the sample(s) tested unless otherwise stated. This test report cannot be reproduced, except in full, without prior written permission of the Company.*

# INDEX

<b>CONTENTS</b>	<b>Page</b>
<b>1. GENERAL INFORMATION</b>	<b>4</b>
<b>2. CONDUCTED POWERLINE TEST</b>	<b>6</b>
<b>3. SPURIOUS EMISSION, BAND EDGE, AND RESTRICTED BAND TEST</b>	<b>12</b>
<b>4. 20 dB BANDWIDTH MEASUREMENT</b>	<b>24</b>
<b>5. MAXIMUM PEAK OUTPUT POWER MEASUREMENT</b>	<b>27</b>
<b>6. FREQUENCY SEPARATION</b>	<b>30</b>
<b>7. NUMBER OF HOPPING FREQUENCY</b>	<b>32</b>
<b>8. TIME OF OCCUPANCY (DWELL TIME)</b>	<b>34</b>
<b>9. POWER SPECTRAL DENSITY MEASUREMENT</b>	<b>42</b>
<b>10. ANTENNA REQUIREMENT</b>	<b>45</b>
<b>11. Attachment A – Photos of the Test Set up</b>	<b>46</b>
<b>12. Attachment B – Photos of the EUT</b>	<b>48</b>

*The results shown in this test report refer only to the sample(s) tested unless otherwise stated. This test report cannot be reproduced, except in full, without prior written permission of the Company.*

## 1. GENERAL INFORMATION

### 1.1 General Description of EUT & Power

<b>Kind of Product</b>	Bluetooth Serial Adaptor
<b>Model Name</b>	Promi SD205-OA
<b>Power Supply</b>	DC 5 V AC adapter(100 ~240 Vac)
<b>Frequency Range</b>	2402~2480 MHz(FHSS)
<b>Transmit Power</b>	12.65 dBm (FHSS)
<b>Modulation Technique</b>	FHSS
<b>Number of Channels</b>	79 CH (FHSS)
<b>Test Modulation</b>	Continuous RF
<b>Operating Conditions</b>	-20 °C ~ + 70 °C
<b>Antenna Type</b>	Helical Antenna(left-handed SMA Type)
<b>Antenna Gain</b>	2 dBi

*The results shown in this test report refer only to the sample(s) tested unless otherwise stated. This test report cannot be reproduced, except in full, without prior written permission of the Company.*

## 1.2 Summary of Test Results

The EUT has been tested according to the following specifications:

<b>APPLIED STANDARD:FCC 47 C.F.R. Part15, Subpart B and Subpart C</b>		
<b>Standard Section</b>	<b>Test Item</b>	<b>Result</b>
15.107 15.207	AC Power Conducted Emission	PASS
15.247(a)(1)	20 dB Bandwidth	PASS
15.247(b)(1)	Maximum Peak Output Power	PASS
15.205(a) 15.209(a) 15.247(d)	Spurious Emission, Band Edge, and Restricted Bands	PASS
15.247(a)(1)	Frequency Separation	PASS
15.247(a)(1)(iii)	Number of Hopping Frequency	PASS
15.247(a)(1)(iii)	Time of Occupancy (Dwell Time)	PASS
15.247(e)	Power Spectral Density	PASS

*The results shown in this test report refer only to the sample(s) tested unless otherwise stated. This test report cannot be reproduced, except in full, without prior written permission of the Company.*

## 2. CONDUCTED POWERLINE TEST

### 2.1 Test Setup

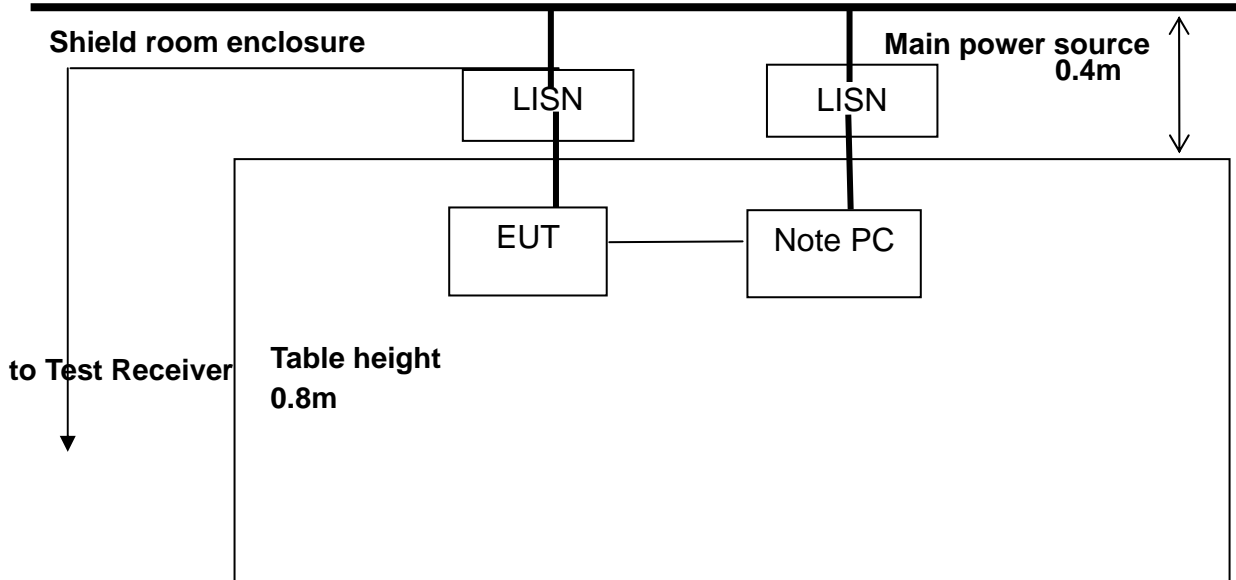

*The results shown in this test report refer only to the sample(s) tested unless otherwise stated. This test report cannot be reproduced, except in full, without prior written permission of the Company.*

## 2.2 Limit

According to §15.107(a) for an intentional radiator that is designed to be connected to the public utility (AC) power line, the radio frequency voltage that is conducted back onto the AC power line on any frequency or frequencies, within the band 150 kHz to 30 MHz, shall not exceed the limits in the following table, as measured using a 50 uH/50ohm line impedance stabilization network(LISN).

Compliance with the provision of this paragraph shall on the measurement of the radio frequency voltage between each power line and ground at the power terminal. The lower applies at the boundary between the frequency ranges.

Frequency of Emission (MHz)	Conducted limit (dB $\mu$ V)	
	Qausi-peak	Average
0.15 – 0.50	66-56*	56-46*
0.50 – 5.00	56	46
5.00 – 30.0	60	50

\* Decreases with the logarithm of the frequency.

## 2.3 Test Procedure

1. A preliminary scan with a spectrum monitor is performed to identify the frequency of emission that has the highest amplitude relative to the limit by operating the EUT in selected modes of operation, typical cable positions, and with a typical system configuration.
2. Record the 6 or 8 highest emissions relative to the limit.
3. Measure each frequency obtained from step 3 by a test receiver set on quasi peak detector function, and then record the accuracy frequency and emission level. If all emissions measured in the specified band are attenuated more than 20 dB from the limit, this step would be ignored, and the peak detector function would be used.
4. Confirm the highest three emissions with variation of the EUT cable configuration and record the final data.
5. Repeat all above procedures on measuring each operation mode of EUT.

*The results shown in this test report refer only to the sample(s) tested unless otherwise stated. This test report cannot be reproduced, except in full, without prior written permission of the Company.*

## 2.4 Test Result

The following table shows the highest levels of conducted emissions on both phase of Hot and Neutral line.

Humidity Level	50 %	Temperature	21 °C
----------------	------	-------------	-------

Frequency range : 0.15 MHz – 30 MHz

Measured Bandwidth : 9 kHz

FREQ. (MHz)	LEVEL(dB $\mu$ V)		LINE	LIMIT(dB $\mu$ V)		MARGIN(dB)	
	Q-Peak	Average		Q-Peak	Average	Q-Peak	Average
0.150	43.3	19.5	H	66.0	56.0	22.70	36.50
0.190	37.5	16.8	H	64.0	54.0	26.54	37.24
0.215	38.8	22.1	H	63.0	53.0	24.21	30.91
0.375	25.5	19.5	H	58.4	48.4	32.89	28.89
2.045	24.0	17.8	H	44.3	34.3	20.30	16.50
27.000	32.2	29.9	H	60.0	50.0	27.80	20.10
0.155	42.5	20.1	N	65.7	55.7	19.9	35.63
0.180	40.3	18.1	N	64.5	54.5	17.9	36.39
0.205	36.3	20.5	N	63.4	53.4	20.3	32.91
0.355	25.8	17.5	N	58.8	48.8	17.1	31.34
0.465	28.7	25.8	N	56.6	46.6	25.3	20.80
27.000	18.3	15.1	N	60.0	50.0	68.3	34.90

### REMARKS :

- Note : • Line ( H ) :Hot , • Line ( N ) :Neutral

*The results shown in this test report refer only to the sample(s) tested unless otherwise stated. This test report cannot be reproduced, except in full, without prior written permission of the Company.*



## Plot of Conducted Power line

Test mode: (Hot)

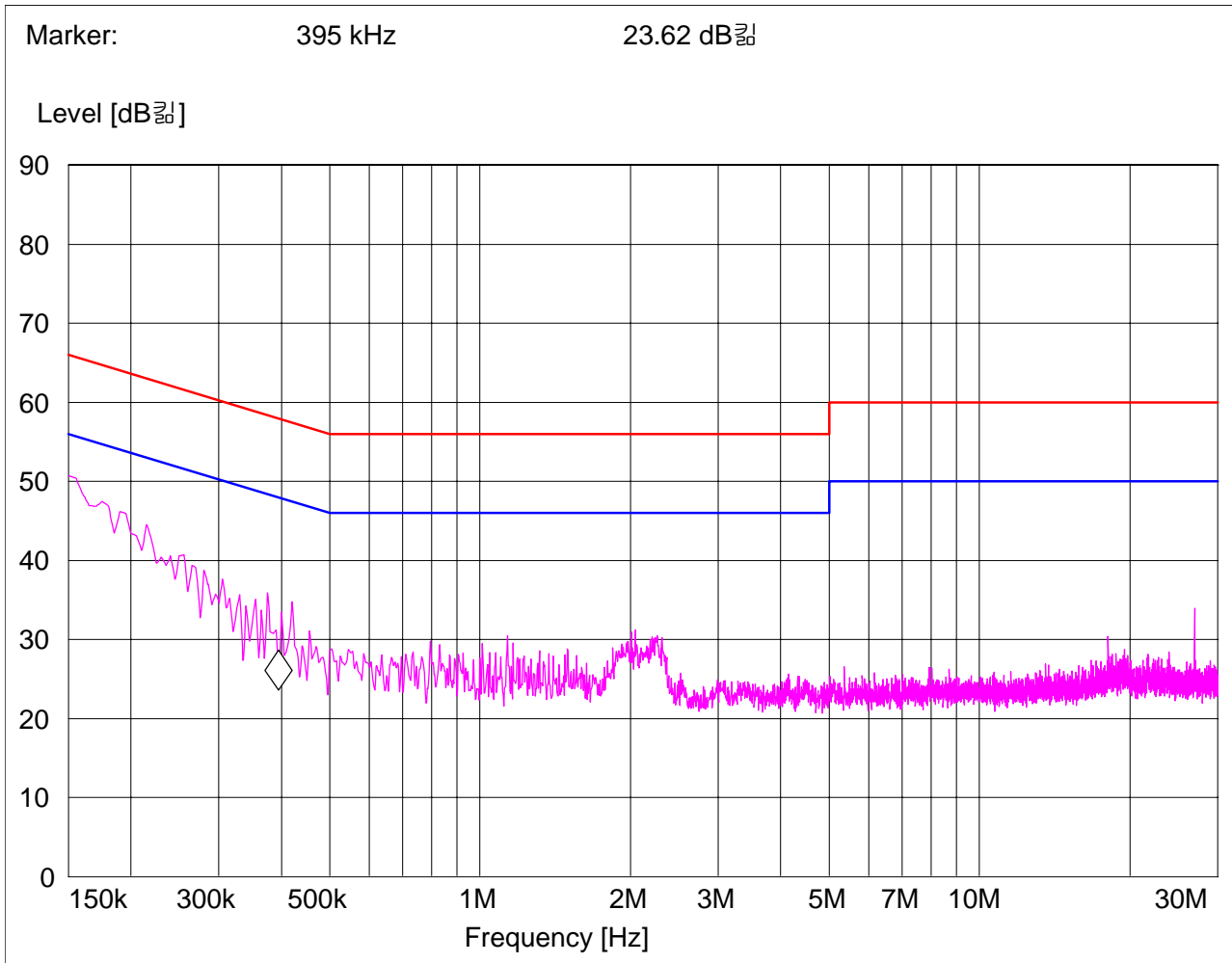

The results shown in this test report refer only to the sample(s) tested unless otherwise stated. This test report cannot be reproduced, except in full, without prior written permission of the Company.

Test mode: (Neutral)

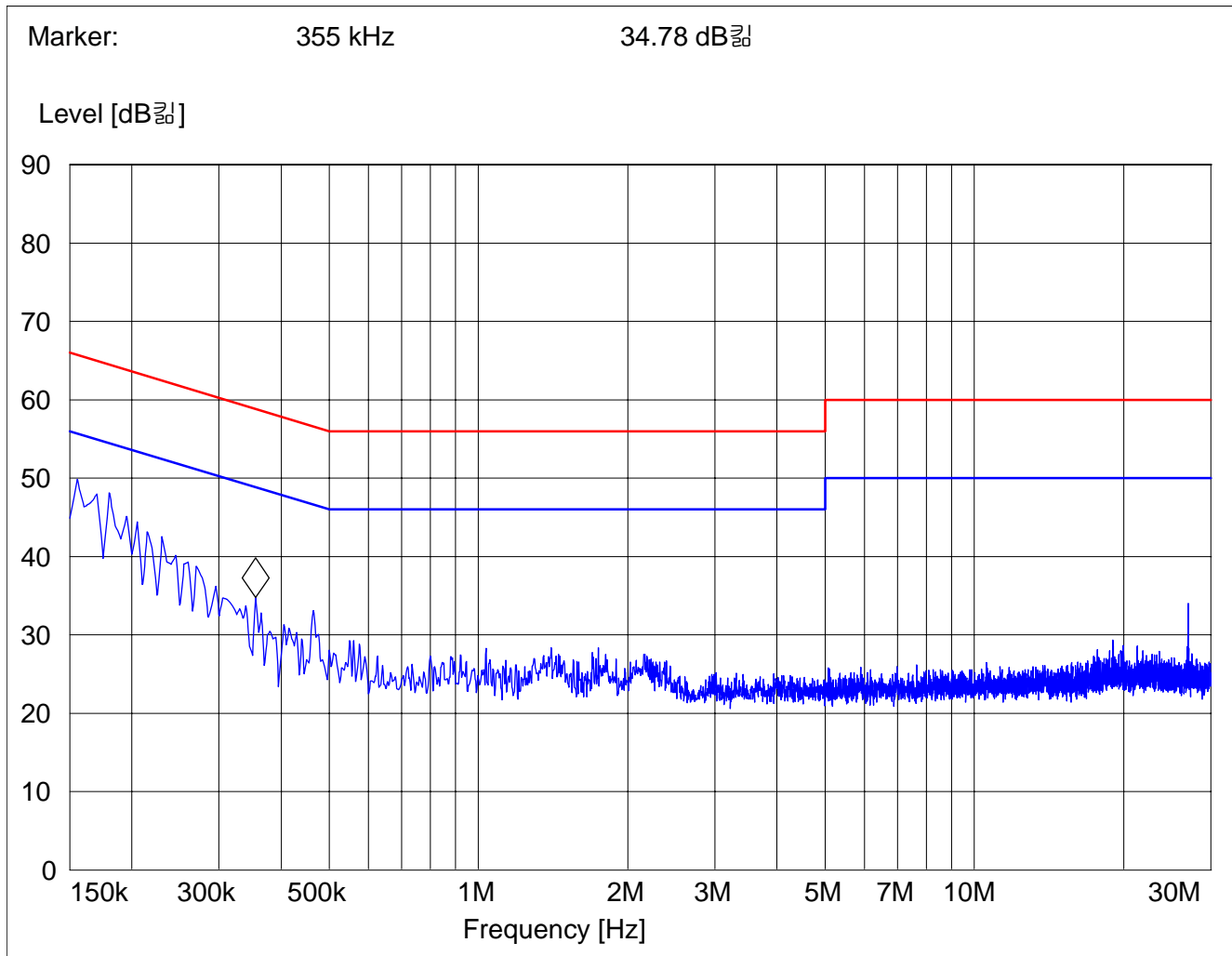

The results shown in this test report refer only to the sample(s) tested unless otherwise stated. This test report cannot be reproduced, except in full, without prior written permission of the Company.

**Test Equipment Used**

<b>EQUIPMENT</b>	<b>MANUFACTURER</b>	<b>MODEL</b>	<b>CAL DUE.</b>
Two-Line V-Network	Rohde & Schwarz	ENV216	Dec.2006
Two-Line V-Network	NNB 41	Schaffner	Sep. 2006
Shielded Room	N/A	-	-
Test Receiver	Rohde & Schwarz	ESHS 10	Sep. 2006

*The results shown in this test report refer only to the sample(s) tested unless otherwise stated. This test report cannot be reproduced, except in full, without prior written permission of the Company.*

### 3. SPURIOUS EMISSION, BAND EDGE, and RESTRICTED BANDS TEST

#### 3.1 Test Setup

##### 1) Spurious Radiated Emissions

The diagram below shows the test setup that is utilized to make the measurements for emission from 30 MHz to 40 GHz.

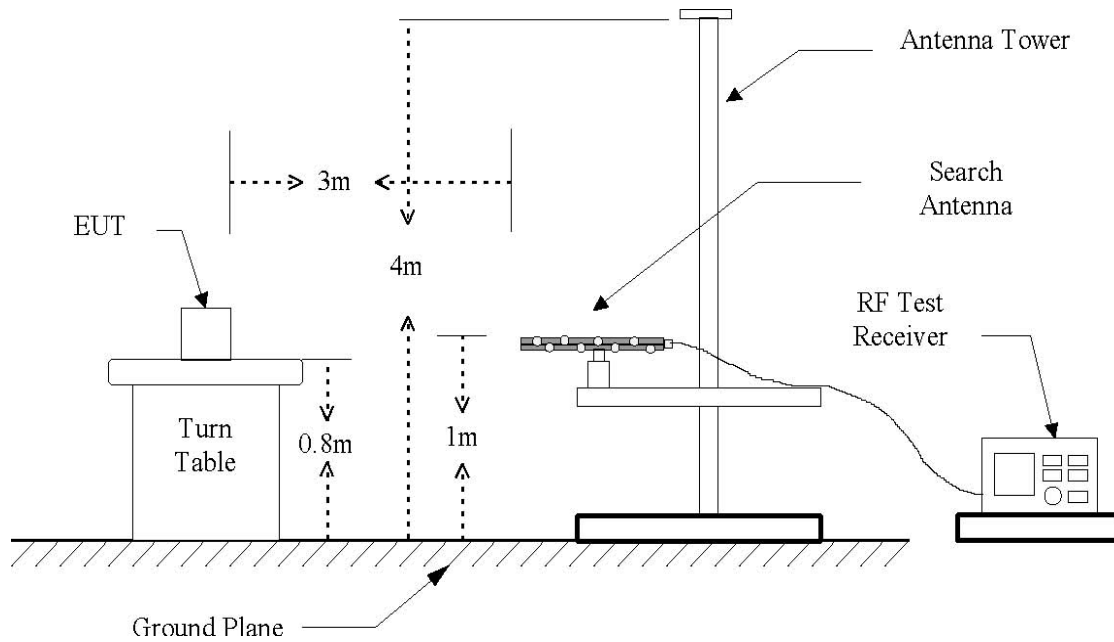

Figure 1 : Frequencies measured below 1 GHz configuration

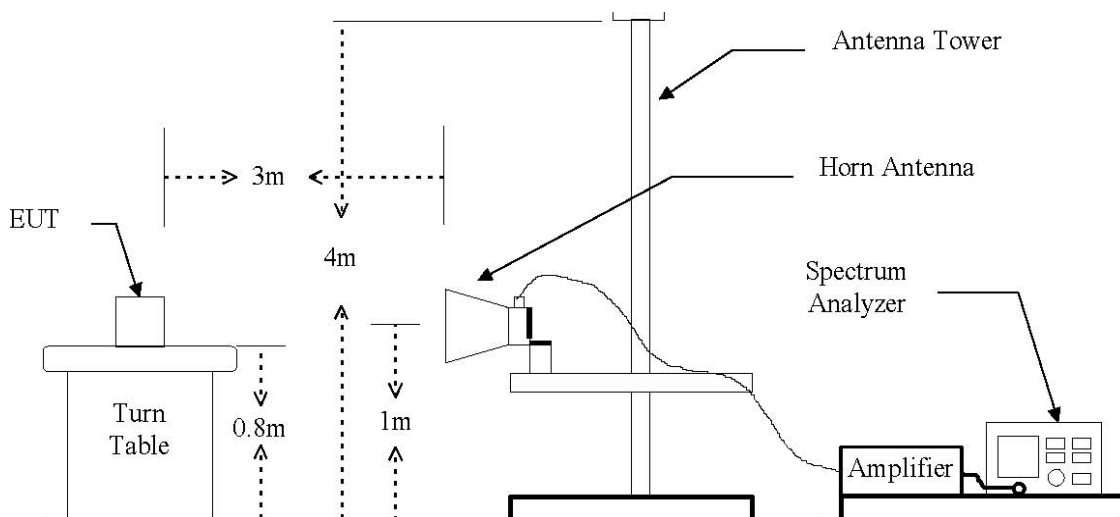
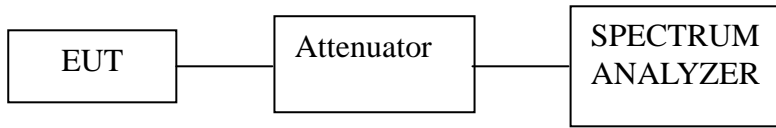

Figure 2 : Frequencies measured above 1 GHz configuration

The results shown in this test report refer only to the sample(s) tested unless otherwise stated. This test report cannot be reproduced, except in full, without prior written permission of the Company.

## 2) Spurious RF Conducted Emissions



*The results shown in this test report refer only to the sample(s) tested unless otherwise stated. This test report cannot be reproduced, except in full, without prior written permission of the Company.*

### 3.2 Limit

According to §15.247(d), in any 100 kHz bandwidth outside the frequency band in which the spread spectrum or digitally modulated intentional radiator is operating, the radio frequency power that is produced by the intentional radiator shall be at least 20 dB below that in the 100 kHz bandwidth within the band that contains the highest level of the desired power, based on either an RF conducted or a radiated measurement , provided the transmitter demonstrates compliance with the peak conducted power limits. If the transmitter complies with the conducted power limits based on the use of RMS averaging over a time interval , as permitted under paragraph(b)(3) of this section , the attenuation required under this paragraph shall be 30 dB instead of 20 dB. Attenuation below the general limits specified in section §15.209(a) is not required. In addition, radiated emission which in the restricted band, as define in section §15.205(a), must also comply the radiated emission limits specified in section §15.209(a) (see section §15.205(c))

According to § 15.209(a), for an intentional radiator devices, the general required of field strength of radiated emissions from unintentional radiators at a distance of 3 meters shall not exceed the following values :

Frequency (MHz)	Distance (Meters)	Radiated (dB $\mu$ V/m)	Radiated ( $\mu$ V/m)
30 - 88	3	40.0	100
88 – 216	3	43.5	150
216 – 960	3	46.0	200
Above 960	3	54.0	500

According to §15.109(a), for an unintentional device, except for Class A digital devices, the field strength of radiated emission from unintentional radiators at a distance of 3 meters shall not exceed the above table.

*The results shown in this test report refer only to the sample(s) tested unless otherwise stated. This test report cannot be reproduced, except in full, without prior written permission of the Company.*

### 3.3 Test Procedures

#### 1) Spurious Radiated Emissions

1. The EUT was placed on the top of a rotating table 0.8 meters above the ground at a 10meter open area test site. The table was rotated 360 degrees to determine the position of the highest radiation.
2. During performing radiated emission below 1 GHz, the EUT was set 3 meters away from the interference-receiving antenna, which was mounted on the top of a variable-height antenna tower. During performing radiated emission above 1 GHz, the EUT was set 1 meter away from the interference-receiving antenna.
3. The antenna is a broadband antenna, and its height is varied from one meter to four meters above the ground to determine the maximum value of the field strength. Both horizontal and vertical polarization of the antenna are set to make the measurement.
4. For each suspected emission, the EUT was arranged to its worst case and then the antenna was tuned to heights from 1 meter to 4 meters and the table was turned from 0 degrees to 360 degrees to find the maximum reading.
5. The test-receiver system was set to Peak Detect Function and Specified Bandwidth with Maximum Hold Mode. If the emission level of the EUT in peak mode was 10 dB lower than the limit specified, then testing could be stopped and the peak values of the EUT would be reported. Otherwise the emissions that did not have 10 dB margin would be re-tested one by one using peak, quasi-peak or average method as specified and then reported in a data sheet.

#### NOTE :

1. The resolution bandwidth and video bandwidth of test receiver/spectrum analyzer is 120 kHz for Peak detection (PK) and Quasi-peak detection (QP) at frequency below 1 GHz.
2. The resolution bandwidth and video bandwidth of test receiver/spectrum analyzer is 1MHz for Peak detection and frequency above 1 GHz.
3. The resolution bandwidth of test receiver/spectrum analyzer is 1 MHz and the video bandwidth is 10 Hz for Average detection (AV) at frequency above 1 GHz.

*The results shown in this test report refer only to the sample(s) tested unless otherwise stated. This test report cannot be reproduced, except in full, without prior written permission of the Company.*

## 2) Spurious RF Conducted Emissions

The transmitter output was connected to the spectrum analyzer via a low loss cable. Set both RBW and VBW of spectrum analyzer with suitable frequency span including 100 kHz bandwidth from band edge. The band edges was measured and recorded.

*The results shown in this test report refer only to the sample(s) tested unless otherwise stated. This test report cannot be reproduced, except in full, without prior written permission of the Company.*



### 3.4 Test Result

#### 1) Spurious Radiated Emissions

The frequency spectrum from 30 MHz to 1000 MHz was investigated. All emissions are not reported much lower than the prescribed limits. All reading values are quasi-peak values.

Humidity Level	50 %	Temperature	23 °C
----------------	------	-------------	-------

#### Radiated Spurious Emission 30 MHz ~1000 MHz Test Data (Worst-Case Configuration)

Radiated Emissions			Ant	Correction Factors		Total	FCC Limit	
Frequency (MHz)	Reading (dBuV)	Detect Mode	Pol.	Ant. (dB/m)	Cable (dB)	Actual (dBuV/m)	Limit (dBuV/m)	Margin (dB)
269.400	12.0	Q.P.	V	17.68	1.72	31.40	46.00	14.60
399.838	18.0	Q.P.	H	16.65	2.06	36.71	46.00	9.29
597.018	10.4	Q.P.	V	20.99	2.52	33.91	46.00	12.09
N/A								

#### REMARKS :

1. All spurious emission at channels are almost the same below 1 GHz, so that the channel was chosen at representative in final test
2. "\*" means the restricted band.
3. Actual = Reading + AF + CL.

*The results shown in this test report refer only to the sample(s) tested unless otherwise stated. This test report cannot be reproduced, except in full, without prior written permission of the Company.*

The frequency spectrum above 1000 MHz was investigated. All emissions are not reported much lower than the prescribed limits. Reading values are both peak and average values.

Humidity Level	50%	Temperature	23°C
----------------	-----	-------------	------

**Radiated Emission Test Data (Above 1 GHz)**

## 1. Low Channel (2402 MHz)

Radiated Emissions			Ant	Correction Factors		Total	FCC Limit	
Frequency (MHz)	Reading (dBuV)	Detect Mode	Pol.	AF/CL (dB/m)/(dB)	Amp Gain (dB)	Actual (dBuV/m)	Limit (dBuV/m)	Margin (dB)
*2385.92	59.00	Peak	V	28.05/5.56	36.56	56.05	74.00	17.95
*2385.92	43.83	Average	V	28.05/5.56	36.56	40.88	54.00	13.12
4804.00	57.00	Peak	V	32.90/8.27	36.37	61.80	74.00	12.20
4804.00	39.67	Average	V	32.90/8.27	36.37	44.47	54.00	9.53
7206.00	49.17	Peak	H	36.70/11.22	36.47	60.62	74.00	13.38
7206.00	35.50	Average	H	36.70/11.22	36.47	46.95	54.00	7.05
9608.00	48.33	Peak	H	37.72/12.90	36.73	62.22	74.00	11.78
9608.00	35.00	Average	H	37.72/12.90	36.73	48.89	54.00	5.11
N/A								

## 2. Middle Channel (2441 MHz)

Radiated Emissions			Ant	Correction Factors		Total	FCC Limit	
Frequency (MHz)	Reading (dBuV)	Detect Mode	Pol.	AF/CL (dB/m)/(dB)	Amp Gain (dB)	Actual (dBuV/m)	Limit (dBuV/m)	Margin (dB)
4882.00	53.00	Peak	V	32.93/8.30	36.35	57.88	74.00	16.12
4882.00	39.17	Average	V	32.93/8.30	36.35	44.05	54.00	9.95
7323.00	48.50	Peak	H	35.85/11.63	36.50	59.48	74.00	14.52
7323.00	35.17	Average	H	35.85/11.63	36.50	46.15	54.00	7.85
9764.00	48.11	Peak	H	37.80/11.82	36.74	60.99	74.00	13.01
9764.00	34.71	Average	H	37.80/11.82	36.74	47.59	54.00	6.41
N/A								

The results shown in this test report refer only to the sample(s) tested unless otherwise stated. This test report cannot be reproduced, except in full, without prior written permission of the Company.

**3. High Channel (2480 MHz)**

Radiated Emissions			Ant	Correction Factors		Total	FCC Limit	
Frequency (MHz)	Reading (dBuV)	Detect Mode	Pol.	AF/CL (dB/m)/(dB)	Amp Gain (dB)	Actual (dBuV/m)	Limit (dBuV/m)	Margin (dB)
*2483.50	53.33	Peak	V	28.34/5.30	36.57	50.40	74.00	23.60
*2483.50	37.83	Average	V	28.34/5.30	36.57	34.90	54.00	19.10
4960.00	51.83	Peak	V	32.97/8.32	36.34	56.78	74.00	17.22
4960.00	37.83	Average	V	32.97/8.32	36.34	42.78	54.00	11.22
7440.00	47.50	Peak	H	36.01/12.55	36.52	59.54	74.00	14.46
7440.00	34.33	Average	H	36.01/12.55	36.52	46.37	54.00	7.63
9920.00	48.00	Peak	H	37.89/12.10	36.76	61.23	74.00	12.77
9920.00	35.21	Average	H	37.89/12.10	36.76	48.44	54.00	5.56
N/A								

**REMARKS :**

- Measuring frequencies from 1 GHz to the 10<sup>th</sup> harmonic of highest fundamental Frequency
- Measurements above only up to 6 maximum emission noted, or would be lesser if No specific emission from the EUT are recorded (ie: margin>25 dB from the applicable limit) and considered that's already beyond the background noise floor.
- Radiated emission measured in frequency above 1000 MHz were made with an Instrument using Peak detector mode and average detector mode of the emission Shown in Actual FS column.
- Spectrum setting:
  - Peak Setting 1 GHz to 10<sup>th</sup> harmonics of fundamental, RBW=1 MHz, VBW=1 MHz, Sweep time : Auto
  - Average Setting 1 GHz to 10<sup>th</sup> harmonics of fundamental, RBW=1 MHz, VBW=10 Hz, Sweep time : Auto
- “\*” means the restricted band.

**Test Equipment Used**

EQUIPMENT	MANUFACTURER	MODEL	CAL DUE.
Test Receiver	Rohde & Schwarz	ESIB 26	Mar. 2007
Preamplifier	Agilent	8449B	May 2007
Log-periodic	Rohde & Schwarz	UHALP9107	Jan. 2007
Biconical Antenna	Schwarzbeck	VHA9103	Mar. 2007
Horn Antenna	Electro-Metrics	RGA-60	Apr. 2007

The results shown in this test report refer only to the sample(s) tested unless otherwise stated. This test report cannot be reproduced, except in full, without prior written permission of the Company.

## 2) Spurious RF Conducted Emissions : Plot of Spurious RF Conducted Emissions

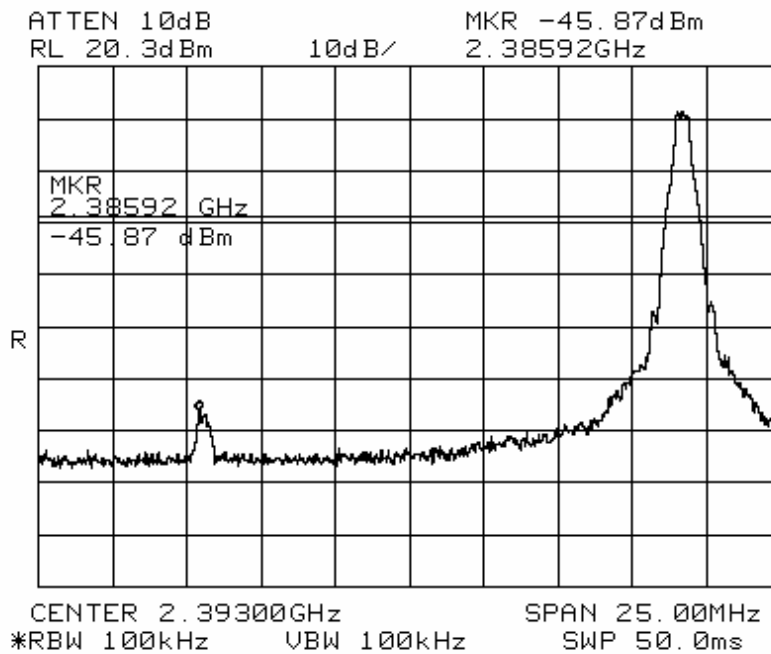

Low Channel

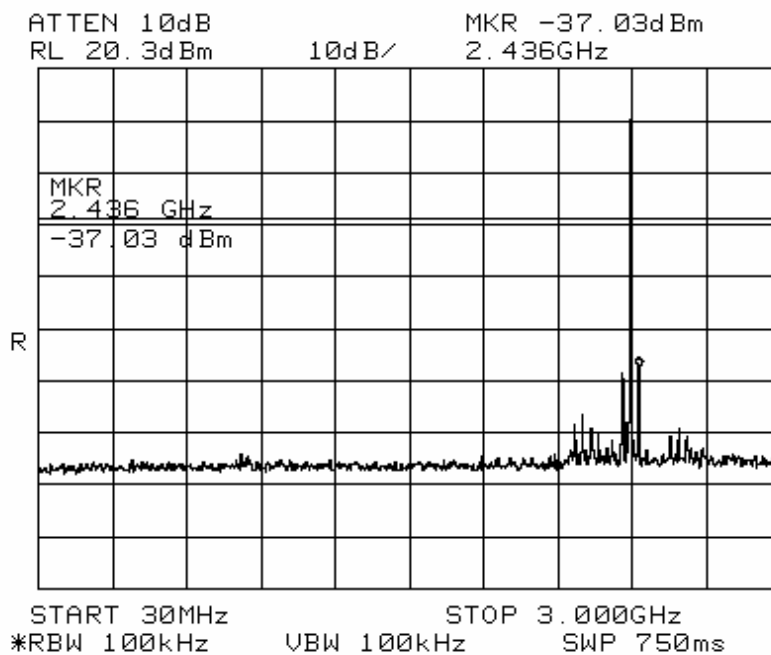

Low Channel

The results shown in this test report refer only to the sample(s) tested unless otherwise stated. This test report cannot be reproduced, except in full, without prior written permission of the Company.

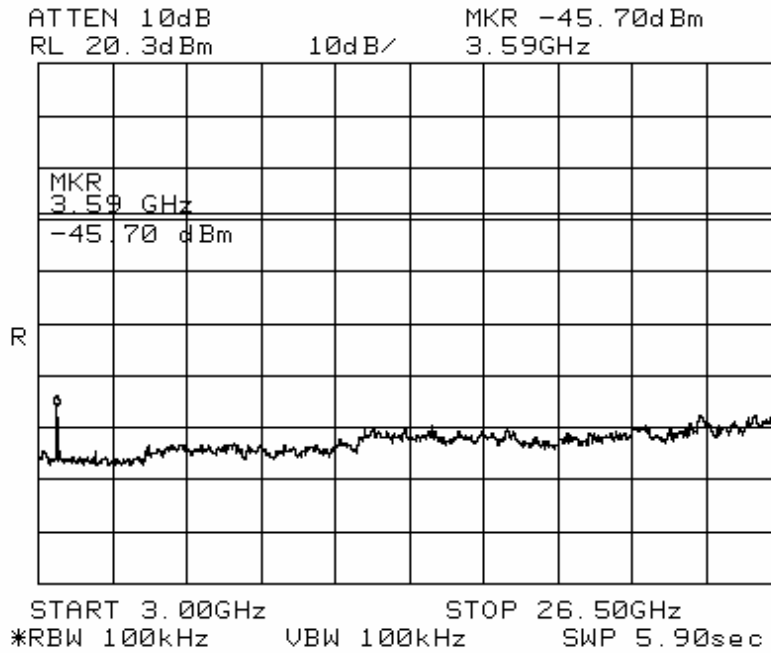

Low Channel

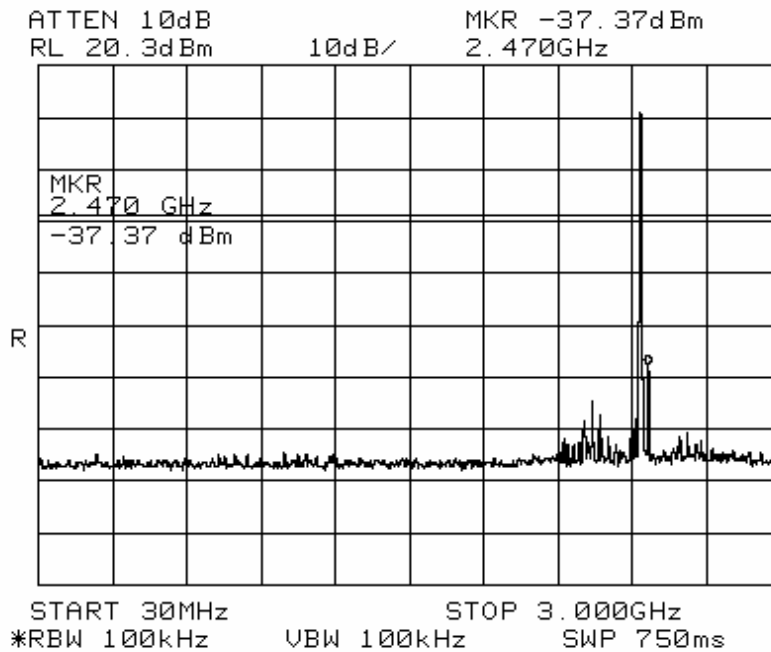

Middle Channel

The results shown in this test report refer only to the sample(s) tested unless otherwise stated. This test report cannot be reproduced, except in full, without prior written permission of the Company.

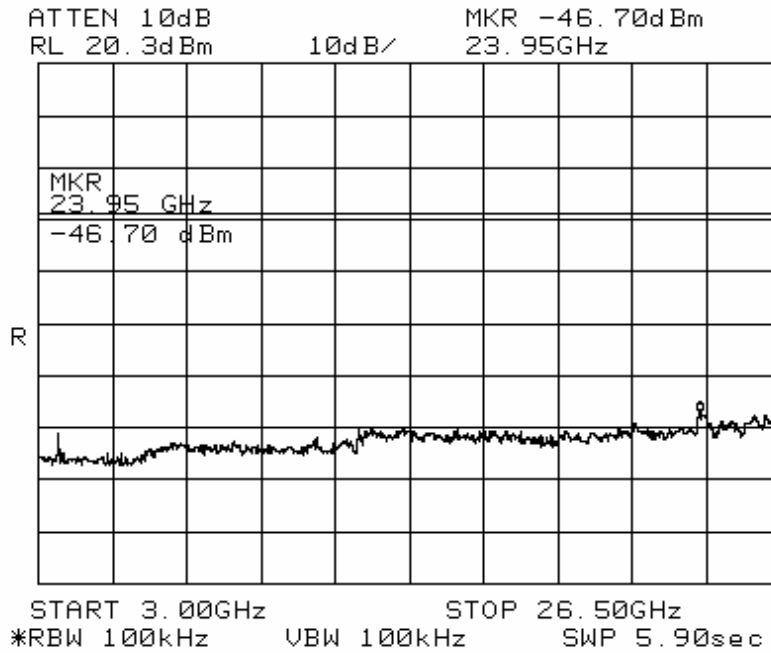

Middle Channel

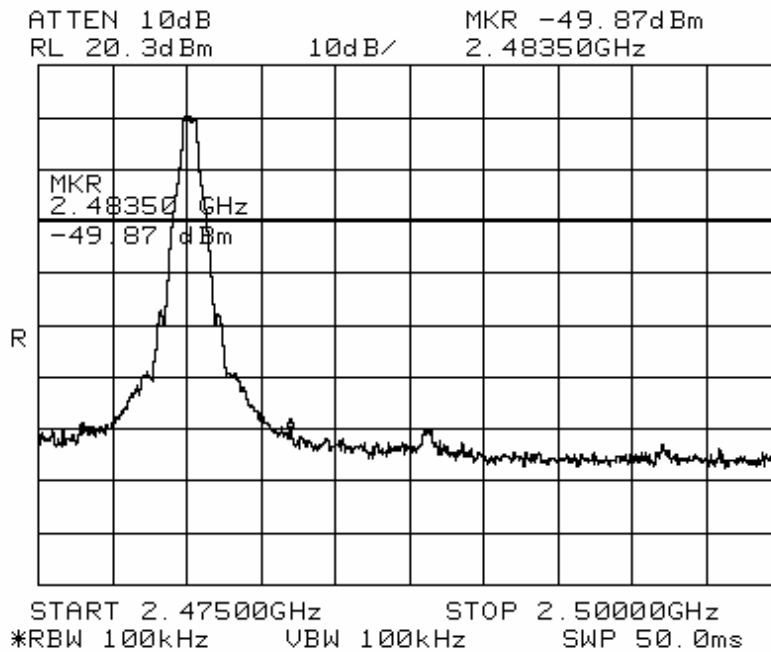

High Channel

The results shown in this test report refer only to the sample(s) tested unless otherwise stated. This test report cannot be reproduced, except in full, without prior written permission of the Company.

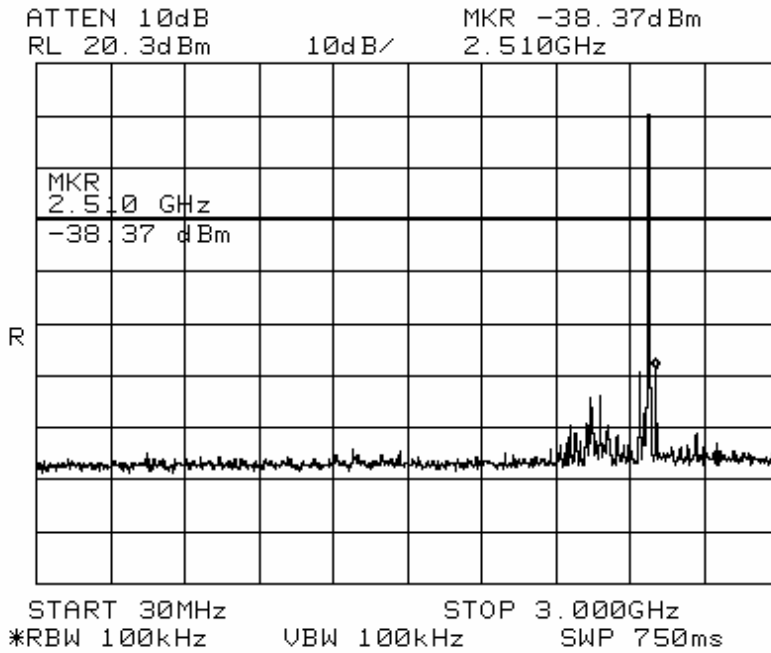

High Channel

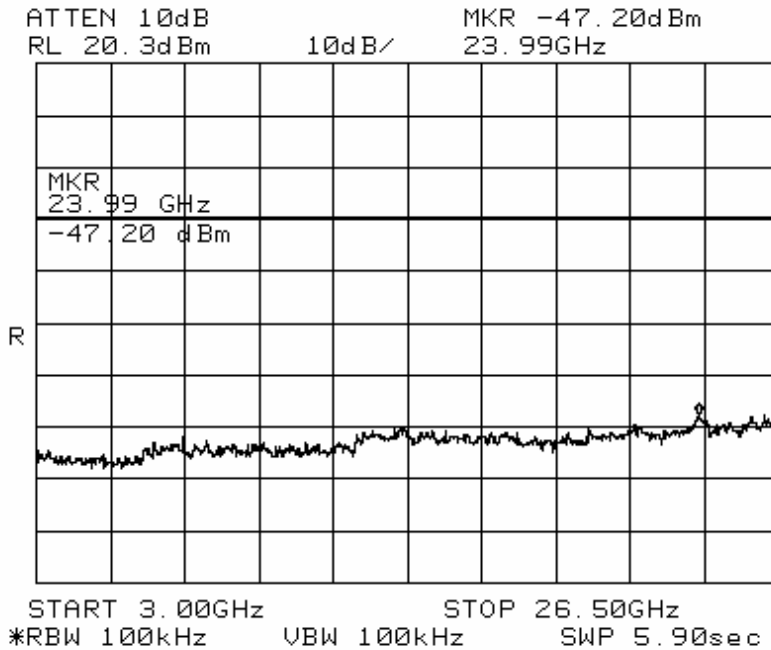

High Channel

**Test Equipment Used**

EQUIPMENT	MANUFACTURER	MODEL	CAL DUE.
Spectrum analyzer	H/P	8563E	Dec. 2006
Attenuator	Lucas Weinschel	33-20-33	Dec.2006

The results shown in this test report refer only to the sample(s) tested unless otherwise stated. This test report cannot be reproduced, except in full, without prior written permission of the Company.

## 4. 20 dB BANDWIDTH MEASUREMENT

### 4.1 Test Setup

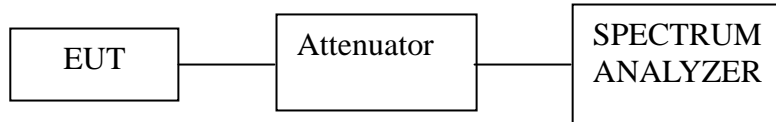

### 4.2 Limits

According to §15.247(a)(1), frequency hopping systems shall have hopping channel carrier frequency separated by a minimum of 25 kHz or the 20 dB bandwidth of the hopping channel, whichever is greater.

### 4.3 Test Procedure

1. The transmitter output was connected to the spectrum analyzer through an attenuator.
2. The bandwidth of the fundamental frequency was measured by spectrum analyzer with RBW=10 kHz and VBW=10 kHz.
3. The 20 dB bandwidth is defined as the total spectrum the power of which is higher than peak power minus 20 dB.

### 4.4 Test Result

Humidity Level	50 %	Temperature	23 °C
----------------	------	-------------	-------

Channel	Channel Frequency (MHz)	20 dB Bandwidth (MHz)
Low	2402	0.817
Middle	2441	0.797
High	2480	0.783

*The results shown in this test report refer only to the sample(s) tested unless otherwise stated. This test report cannot be reproduced, except in full, without prior written permission of the Company.*



## Plot of 20dB Bandwidth

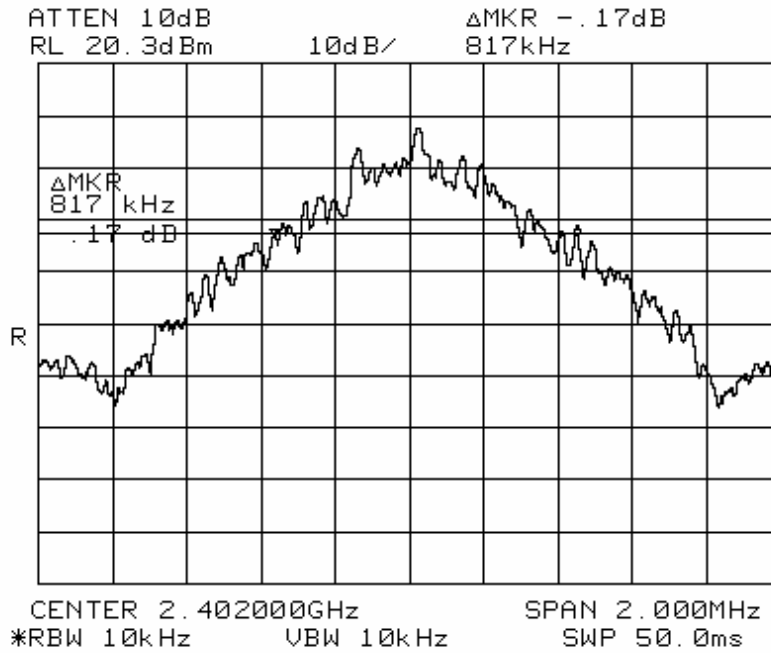

### Low Channel

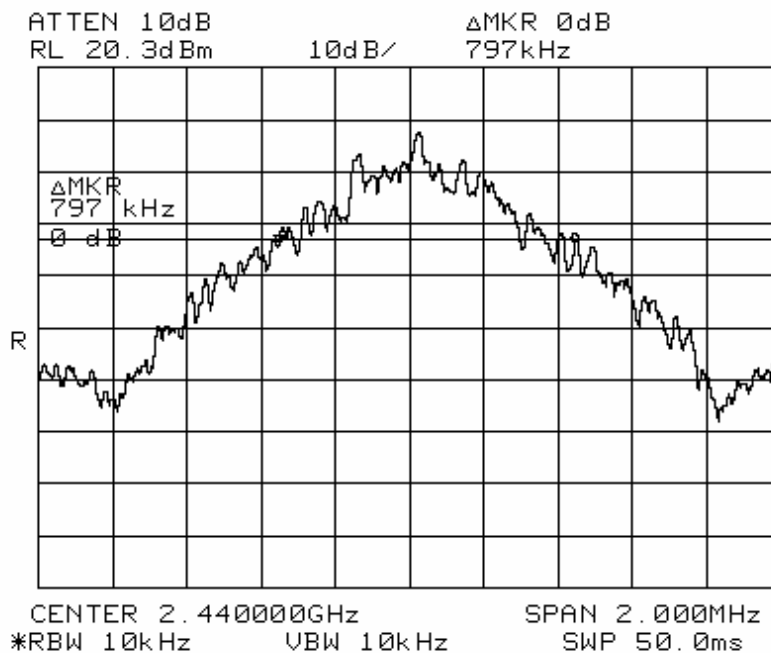

### Middle Channel

The results shown in this test report refer only to the sample(s) tested unless otherwise stated. This test report cannot be reproduced, except in full, without prior written permission of the Company.

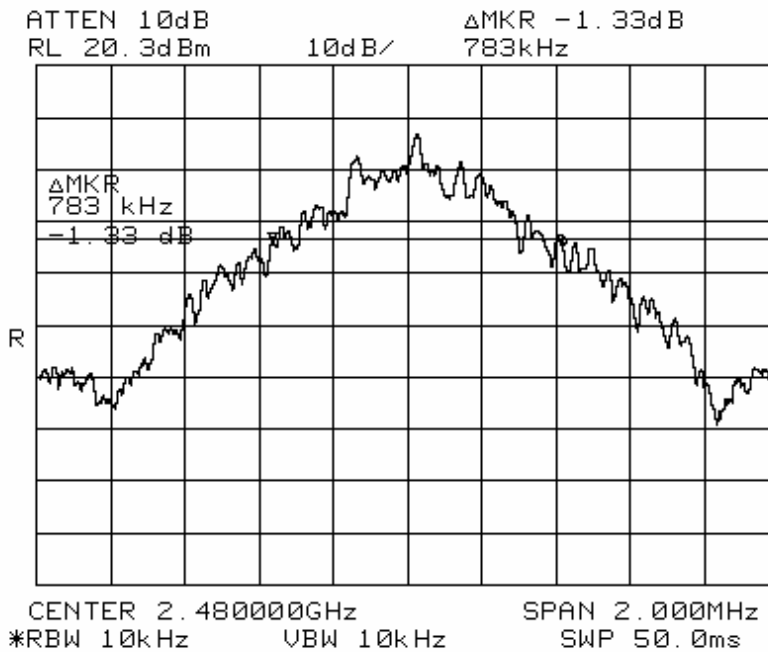

High Channel

**Test Equipment Used**

EQUIPMENT	MANUFACTURER	MODEL	CAL DUE.
Spectrum analyzer	H/P	8563E	Dec. 2006
Attenuator	Lucas Weinschel	33-20-33	Dec.2006

The results shown in this test report refer only to the sample(s) tested unless otherwise stated. This test report cannot be reproduced, except in full, without prior written permission of the Company.

## 5. MAXIMUM PEAK OUTPUT POWER MEASUREMENT

### 5.1 Test Setup

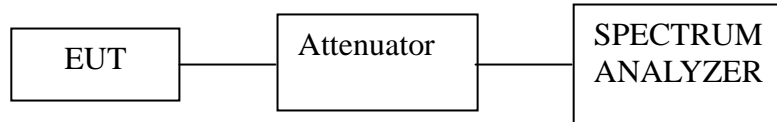

### 5.2 Limit

According to §15.247(b)(1), for frequency hopping systems operating in the 2400-2483.5 MHz band employing at least 75 hopping channels, and all frequency hopping systems in the 5725-5850 MHz band: 1 watt. For all other frequency hopping systems in the 2400-2483.5 MHz band: 0.125 watts.

### 5.3 Test Procedure

1. Check the calibration of the measuring instrument using either an internal calibrator or a known signal from an external generator.
2. Position the EUT as shown in figure 4 without connection to measurement instrument. Turn on the EUT and connect its antenna terminal to measurement instrument via a low loss cable. Then set it to any one measured frequency within its operating range and make sure the instrument is operated in its linear range.
3. Use the following spectrum analyzer settings:  
 Span = approximately 5 times the 20 dB bandwidth, centered on a hopping channel  
 RBW > the 20 dB bandwidth of the emission being measured  
 VBW ≥ RBW  
 Sweep = auto  
 Detector function = peak  
 Trace = max hold
4. Allow the trace to stabilize. Use the marker-to-peak function to set the marker to the peak of the emission. The indicated level is the peak output power. Plot the result on the screen of spectrum analyzer.
5. Repeat above procedures until all frequencies measured were complete.

### 5.4 Test Result

Humidity Level	51 %	Temperature	23 °C
----------------	------	-------------	-------

Channel	Channel Frequency (MHz)	Reading Power (dBm)	Cable+ATT Loss (dB)	Output Power (mW)	Limit (W)
Low	2402	12.51	21.1	17.82	1
Middle	2441	12.65	21.1	18.40	1
High	2480	12.46	21.1	17.62	1

\*Cable+ATT Loss offset the spectrum Analyzer.

The results shown in this test report refer only to the sample(s) tested unless otherwise stated. This test report cannot be reproduced, except in full, without prior written permission of the Company.

## Plot of Maximum Peak Output Power

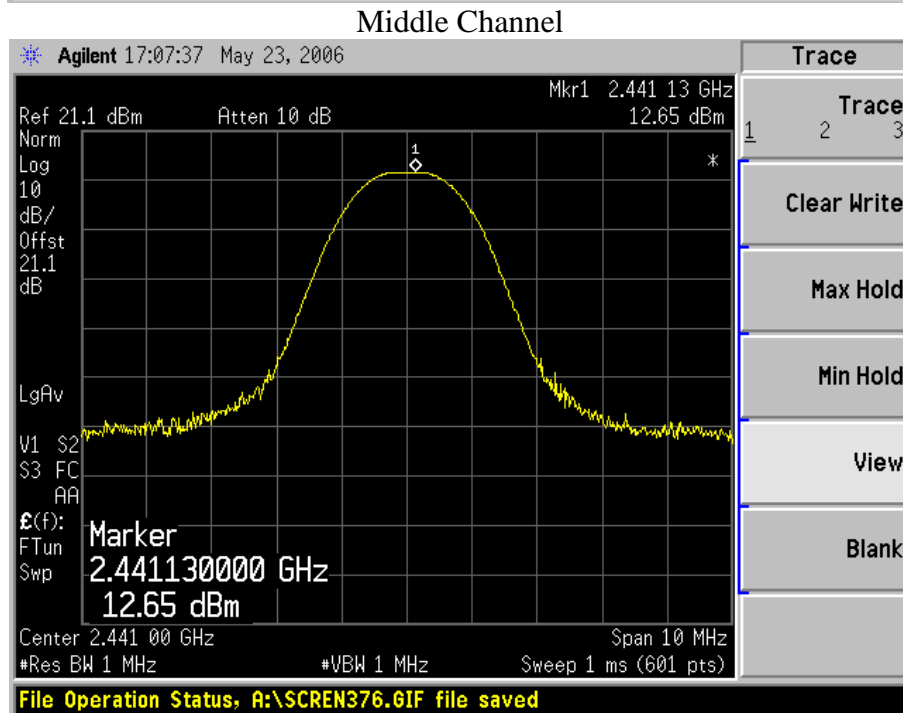
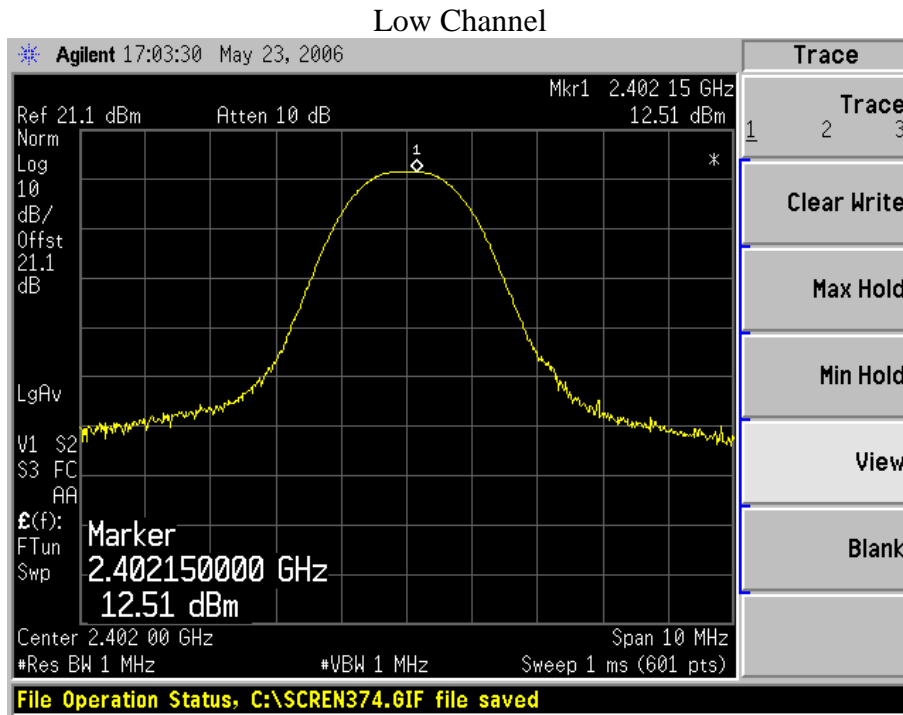

The results shown in this test report refer only to the sample(s) tested unless otherwise stated. This test report cannot be reproduced, except in full, without prior written permission of the Company.

### High Channel

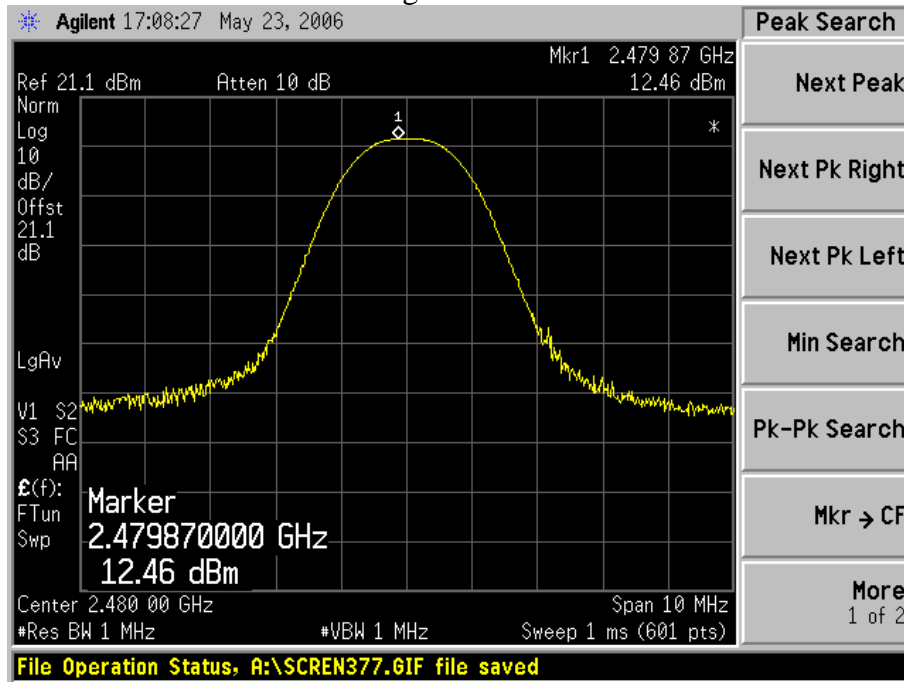

### Test Equipment Used

EQUIPMENT	MANUFACTURER	MODEL	CAL DUE.
Attenuator	Lucas Weinschel	33-20-33	Dec.2006
Spectrum analyzer	Agilent	E4440A	May 2007

The results shown in this test report refer only to the sample(s) tested unless otherwise stated. This test report cannot be reproduced, except in full, without prior written permission of the Company.

## 6. FREQUENCY SEPARATION

### 6.1 Test Setup

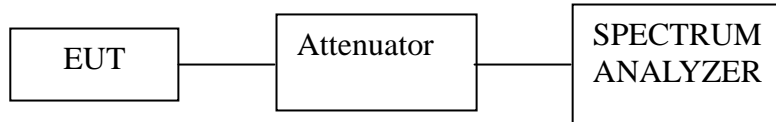

### 6.2 Limits

According to §15.247(a)(1), frequency hopping systems shall have hopping channel carrier frequency separated by a minimum of 25 kHz or the 20 dB bandwidth of the hopping channel, whichever is greater. Alternatively, frequency hopping systems operating in the 2400 ~ 2483.5 MHz band may have channel Carrier frequencies that are separated by 25 kHz or two-thirds of the of the 20 dB bandwidth of the hopping channel, whichever is greater, provided the systems operate with an output power no greater than 125 mW.

### 6.3 Test Procedure

1. Place the EUT on the table and set it in transmitting mode.
2. Remove the antenna from the EUT and then connect a low loss RF cable from the antenna port to the spectrum analyzer.
3. Set center frequency of spectrum analyzer = middle of hopping channel .
4. Set the spectrum analyzer as  
RBW,VBW=100 kHz, Adjust Span to 5 MHz, Sweep = auto.
5. Max hold. Mark 3 Peaks of hopping channel and record the 3 peaks frequency.

### 6.4 Test Result

Humidity Level	50 %	Temperature	23 °C
----------------	------	-------------	-------

Channel Separation (MHz)	Limit (kHz)	Result
1	$\geq 25$ kHz/20 dB Bandwidth	Pass

The results shown in this test report refer only to the sample(s) tested unless otherwise stated. This test report cannot be reproduced, except in full, without prior written permission of the Company.

## Plot of Frequency Separation

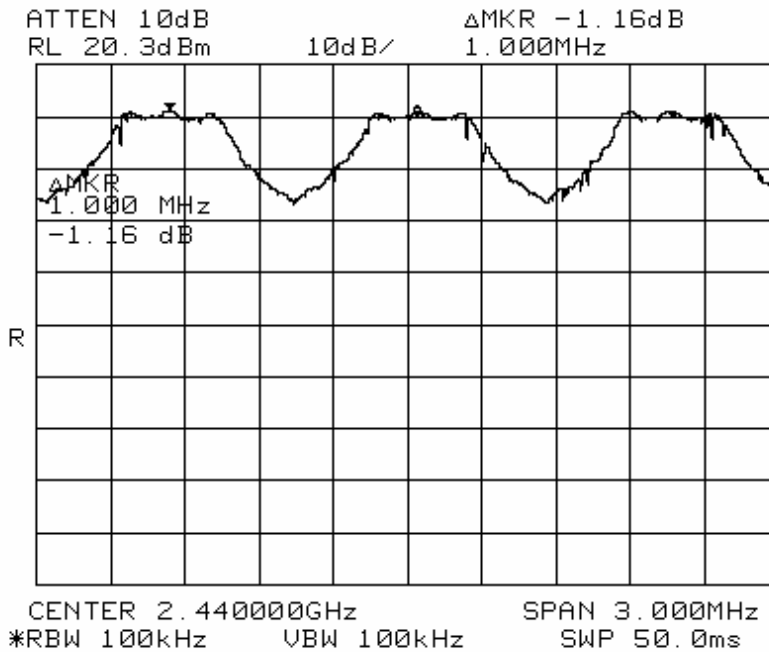

## Test Equipment Used

EQUIPMENT	MANUFACTURER	MODEL	CAL DUE.
Spectrum analyzer	H/P	8563E	Dec. 2006
Attenuator	Lucas Weinschel	33-20-33	Dec.2006

The results shown in this test report refer only to the sample(s) tested unless otherwise stated. This test report cannot be reproduced, except in full, without prior written permission of the Company.

## 7. NUMBER OF HOPPING FREQUENCY

### 7.1 Test Set up

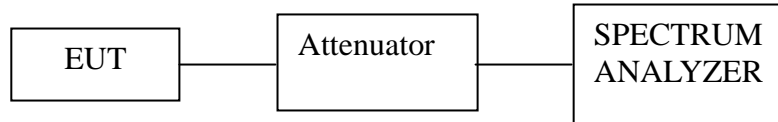

### 7.2 Limit

According to §15.247(a)(1)(iii), Frequency hopping systems in the 2400-2483.5 MHz band shall use at least 15 channels.

### 7.3 Test Procedure

1. Place the EUT on the table and set it in transmitting mode.
2. Remove the antenna from the EUT and then connect a low RF cable from antenna port to the spectrum analyzer.
3. Set the spectrum analyzer as  
 Start=2400 MHz, Stop=2483.5 MHz  
 RBW, VBW=100 kHz, Sweep = auto
4. Max hold, view and count how many channel in the band.

### 7.4 Test Result

Humidity Level	50 %	Temperature	23 °C
----------------	------	-------------	-------

Result(No. of CH)	Limit (No. of CH)	Result
79	>= 15	Pass

*The results shown in this test report refer only to the sample(s) tested unless otherwise stated. This test report cannot be reproduced, except in full, without prior written permission of the Company.*



### Plot of Number of hopping Frequency

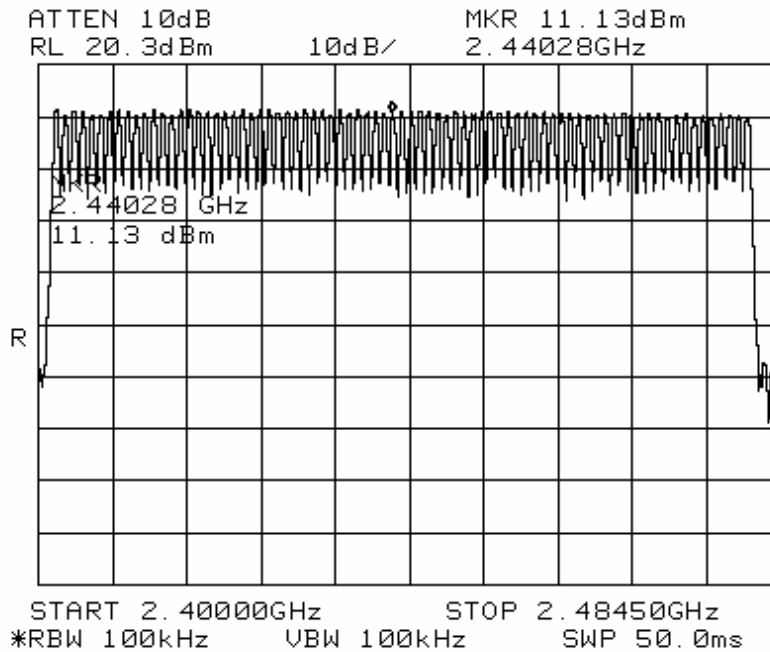

### Test Equipment Used

EQUIPMENT	MANUFACTURER	MODEL	CAL DUE.
Spectrum analyzer	H/P	8563E	Dec. 2006
Attenuator	Lucas Weinschel	33-20-33	Dec.2006

The results shown in this test report refer only to the sample(s) tested unless otherwise stated. This test report cannot be reproduced, except in full, without prior written permission of the Company.

## 8. TIME OF OCCUPANCY (DWELL TIME)

### 8.1 Test Set up

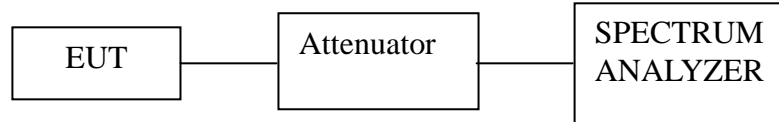

### 8.2 Limit

According to §15.247(a)(1)(iii), Frequency hopping systems operating in the 2400-2483.5 MHz, the average time of occupancy on any frequency shall not greater than 0.4 s within period of 0.4seconds multiplied by the number of hopping channel employed.

### 8.3 Test Procedure

1. Place the EUT on the table and set it in transmitting mode.
2. Remove the antenna from the EUT and then connect a low RF cable from antenna port to the spectrum analyzer.
3. Set center frequency of the spectrum analyzer= operating frequency  
RBW, VBW=1 MHz, Span=0 Hz, Sweep = auto
4. Repeat above procedures until all frequency were measured complete.

### 8.4 Test Result

Humidity Level	50 %	Temperature	25 °C
----------------	------	-------------	-------

A period time=0.4(s)\*79=31.6(s)

### DH1

Low Channel :0.413 (ms)\*(1600/(2\*79))\*31.6(s)=132.16(ms)

Middle Channel : 0.413 (ms)\*(1600/(2\*79))\*31.6(s)=132.16(ms)

High Channel :0.413 (ms)\*(1600/(2\*79))\*31.6(s)=132.16(ms)

Channel	Pulse Time (ms)	Total of Dwell (ms)	Period Time (s)	Limit (ms)	Result
Low	0.413	132.16	31.6	400	PASS
Middle	0.413	132.16	31.6	400	PASS
High	0.413	132.16	31.6	400	PASS

The results shown in this test report refer only to the sample(s) tested unless otherwise stated. This test report cannot be reproduced, except in full, without prior written permission of the Company.

**DH3**

Low Channel :  $1.667 \text{ (ms)} \times (1600 / (4 \times 79)) \times 31.6 \text{ (s)} = 266.72 \text{ (ms)}$

Middle Channel :  $1.667 \text{ (ms)} \times (1600 / (4 \times 79)) \times 31.6 \text{ (s)} = 266.72 \text{ (ms)}$

High Channel :  $1.667 \text{ (ms)} \times (1600 / (4 \times 79)) \times 31.6 \text{ (s)} = 266.72 \text{ (ms)}$

Channel	Pulse Time (ms)	Total of Dwell (ms)	Period Time (s)	Limit (ms)	Result
Low	1.667	266.72	31.6	400	PASS
Middle	1.667	266.72	31.6	400	PASS
High	1.667	266.72	31.6	400	PASS

**DH5**

Low Channel :  $2.907 \text{ (ms)} \times (1600 / (6 \times 79)) \times 31.6 \text{ (s)} = 310.08 \text{ (ms)}$

Middle Channel :  $2.907 \text{ (ms)} \times (1600 / (6 \times 79)) \times 31.6 \text{ (s)} = 310.08 \text{ (ms)}$

High Channel :  $2.907 \text{ (ms)} \times (1600 / (6 \times 79)) \times 31.6 \text{ (s)} = 310.08 \text{ (ms)}$

Channel	Pulse Time (ms)	Total of Dwell (ms)	Period Time (s)	Limit (ms)	Result
Low	2.907	310.08	31.6	400	PASS
Middle	2.907	310.08	31.6	400	PASS
High	2.907	310.08	31.6	400	PASS

*The results shown in this test report refer only to the sample(s) tested unless otherwise stated. This test report cannot be reproduced, except in full, without prior written permission of the Company.*

## Plot of Time of Occupancy (Dwell Time)

### DH1

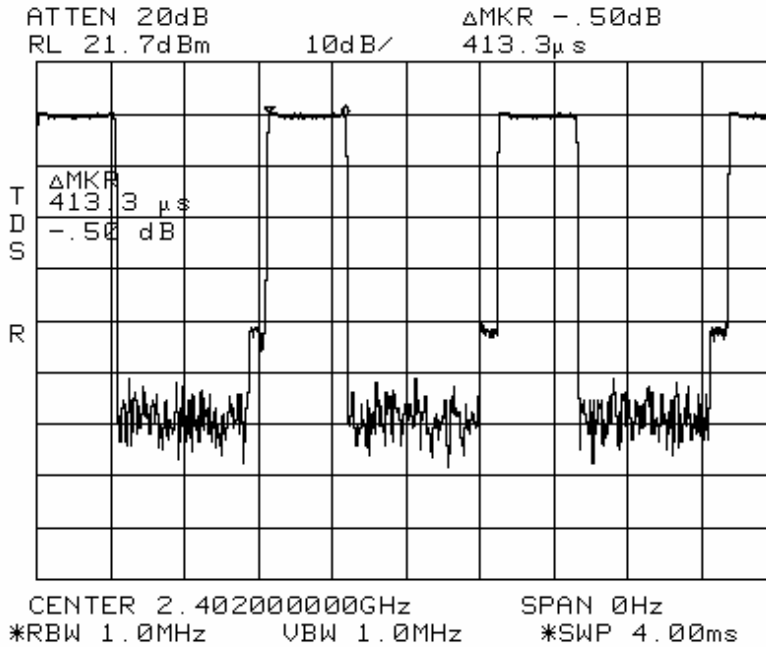

Low Channel

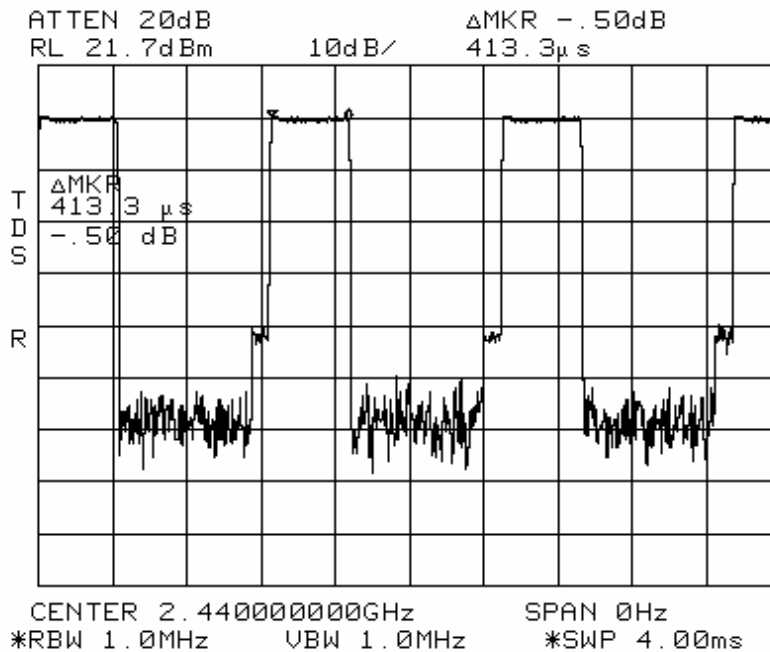

Middle Channel

The results shown in this test report refer only to the sample(s) tested unless otherwise stated. This test report cannot be reproduced, except in full, without prior written permission of the Company.

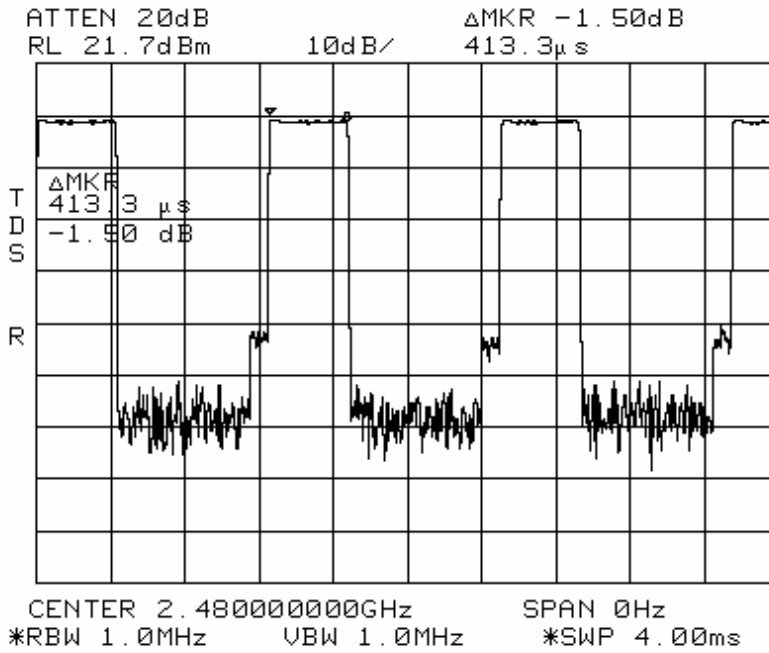

High Channel

*The results shown in this test report refer only to the sample(s) tested unless otherwise stated. This test report cannot be reproduced, except in full, without prior written permission of the Company.*

**DH3**

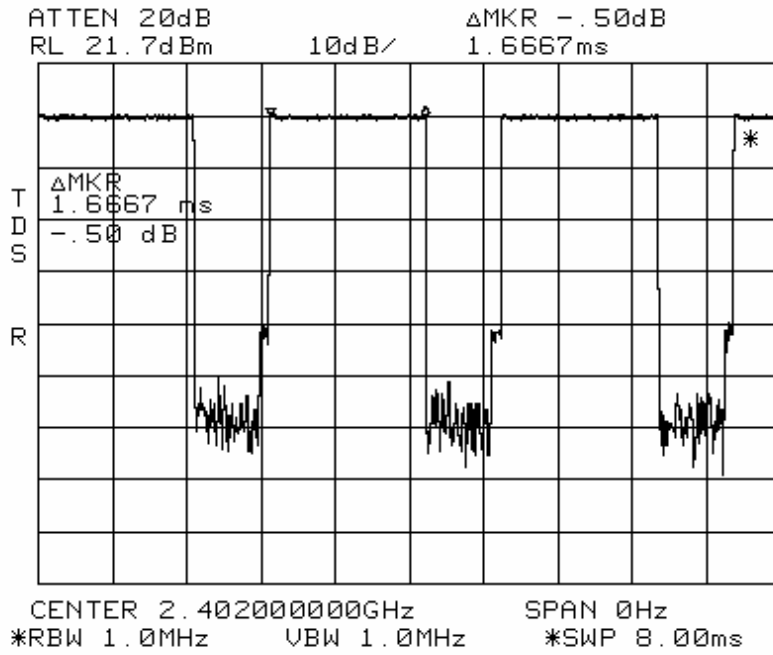

Low Channel

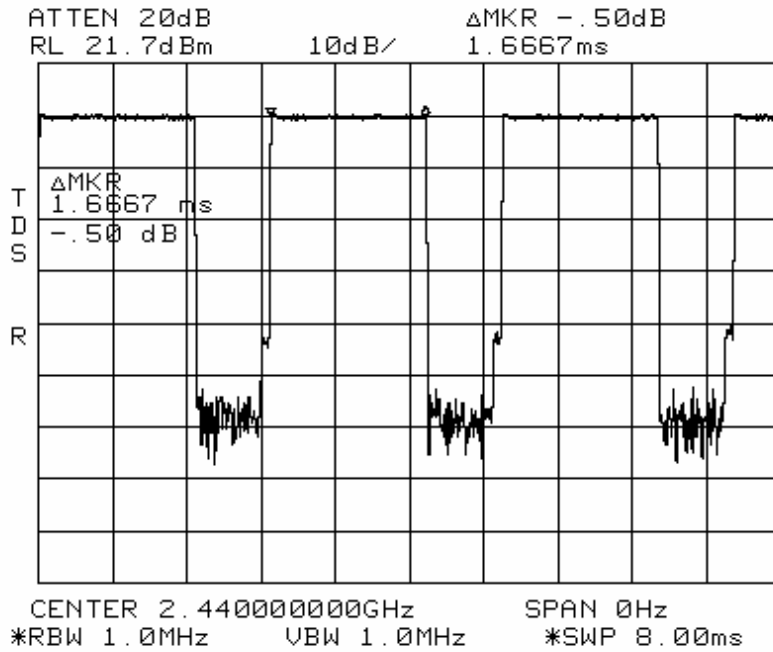

Middle Channel

The results shown in this test report refer only to the sample(s) tested unless otherwise stated. This test report cannot be reproduced, except in full, without prior written permission of the Company.

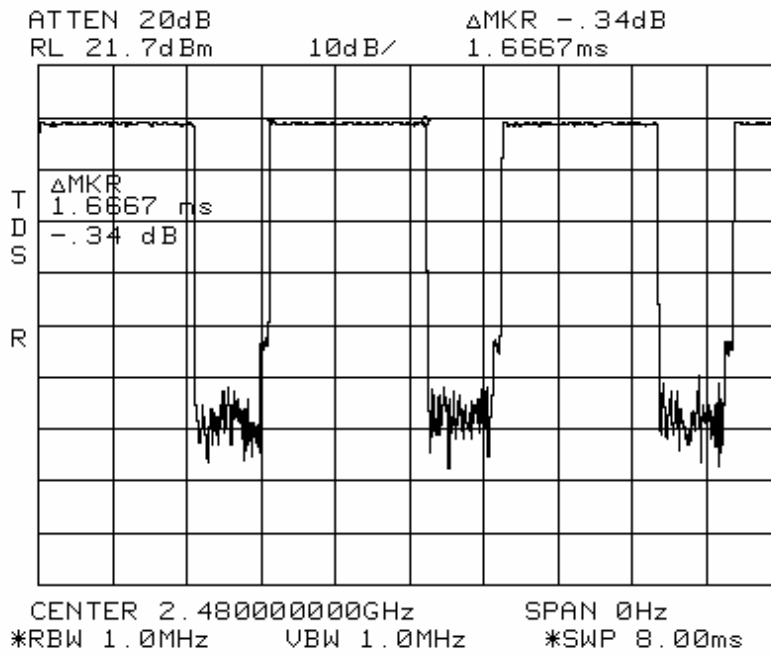

High Channel

The results shown in this test report refer only to the sample(s) tested unless otherwise stated. This test report cannot be reproduced, except in full, without prior written permission of the Company.

## DH5

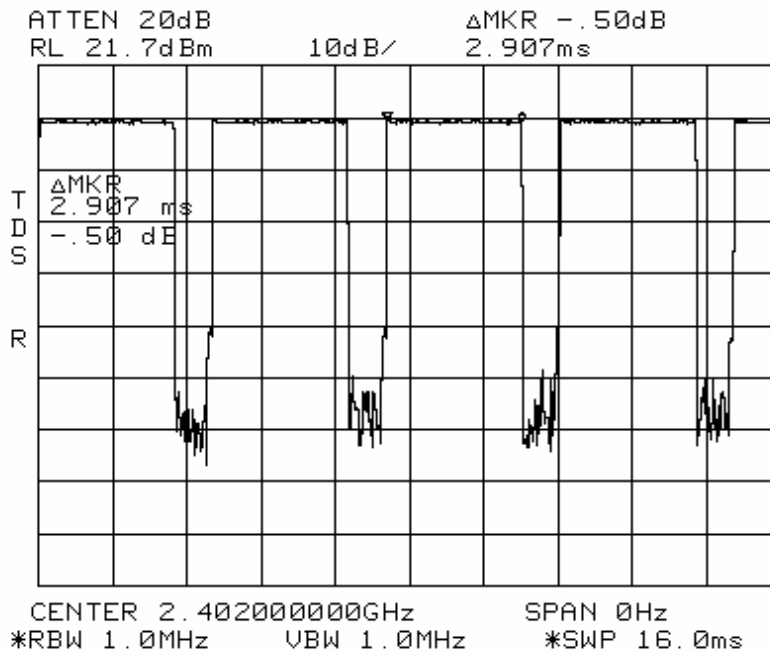

Low Channel

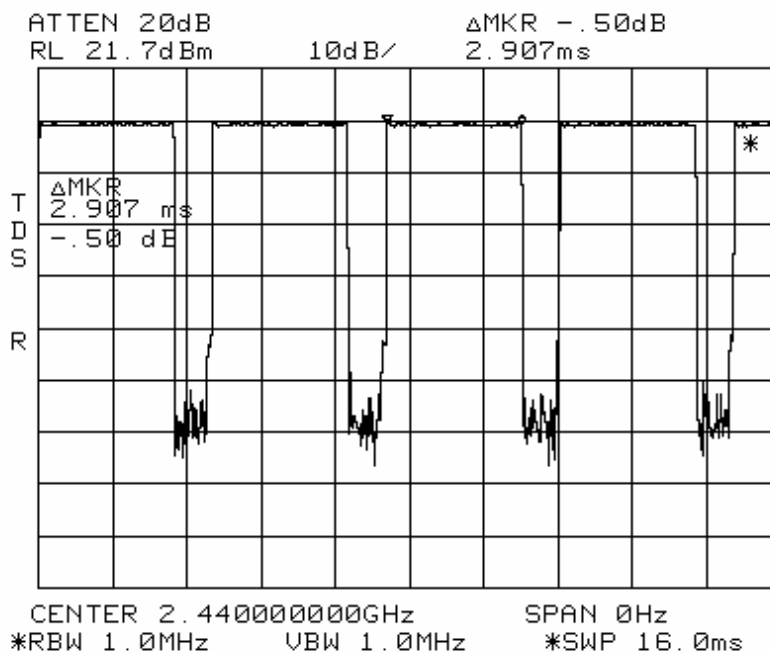

Middle Channel

The results shown in this test report refer only to the sample(s) tested unless otherwise stated. This test report cannot be reproduced, except in full, without prior written permission of the Company.



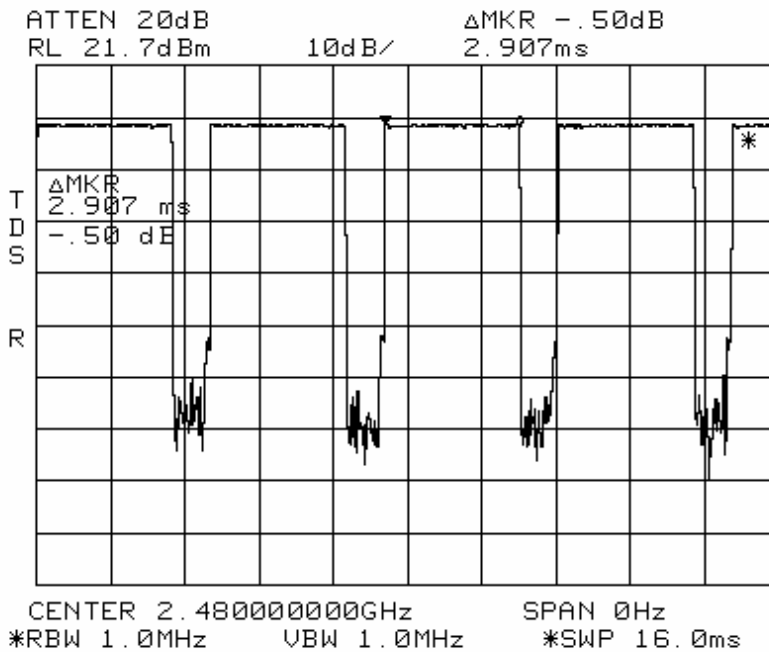

High Channel

**Test Equipment Used**

EQUIPMENT	MANUFACTURER	MODEL	CAL DUE.
Spectrum analyzer	H/P	8563E	Dec. 2006
Attenuator	Lucas Weinschel	33-20-33	Dec. 2006

The results shown in this test report refer only to the sample(s) tested unless otherwise stated. This test report cannot be reproduced, except in full, without prior written permission of the Company.

## 9. POWER SPECTRAL DENSITY MEASUREMENT

### 9.1 Test Setup

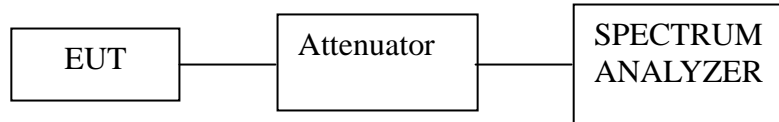

### 9.2 Limit

According to §15.247(e), For digitally modulated system, the power spectral density conducted from the intentional radiator to the antenna shall not be greater than 8 dBm in any 3 kHz band any time interval of continuous transmission. This power spectral density shall be determined in accordance with the provisions of paragraph(b) of this section. The same method of determining the conducted output power shall be used to determine the power spectral density

### 9.3 Test Procedure

1. Place the EUT on the table and set it in transmitting mode.
2. Remove the antenna from the EUT and then connect a low RF cable from the antenna port to the spectrum analyzer
3. Set the spectrum analyzer as RBW=3 kHz, VBW=10 kHz, Span=300 kHz, Sweep=100s
4. Record the max. reading
5. Repeat above procedures until all frequency measured were complete.

### 9.4 Test Result

Humidity Level	50 %	Temperature	24 °C
----------------	------	-------------	-------

Channel	Channel Frequency (MHz)	Final RF Power Level in 3 kHz BW (dBm)	Maximum Limit (dBm)	Margin (dB)
Low	2402	0.47	8	7.53
Middle	2441	0.80	8	7.20
High	2480	0.80	8	7.20

The results shown in this test report refer only to the sample(s) tested unless otherwise stated. This test report cannot be reproduced, except in full, without prior written permission of the Company.

### Plot of Power Spectral Density

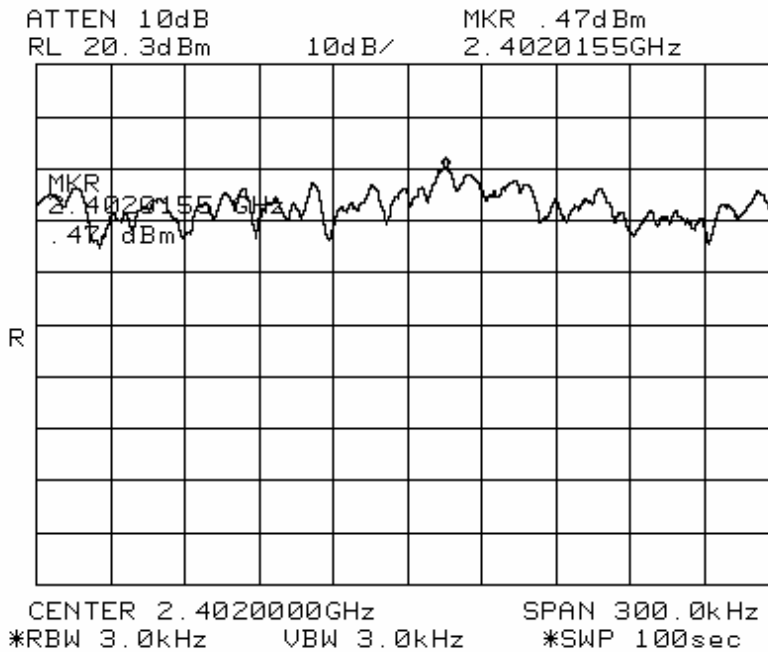

Low Channel

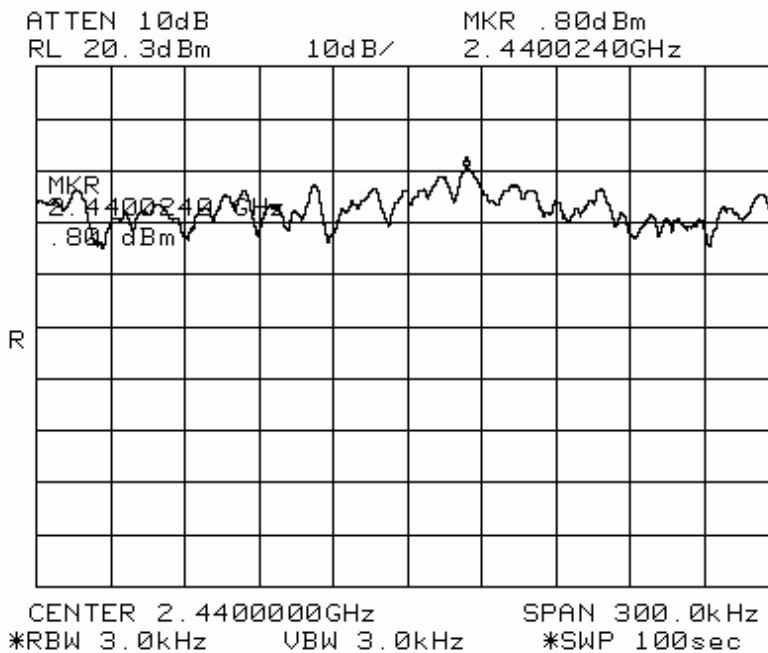

Middle Channel

The results shown in this test report refer only to the sample(s) tested unless otherwise stated. This test report cannot be reproduced, except in full, without prior written permission of the Company.

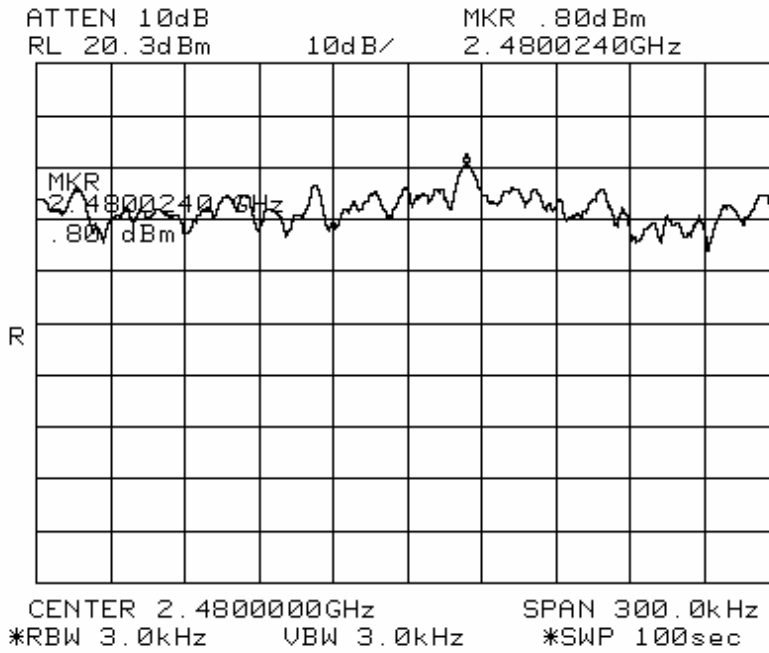

High Channel

**Test Equipment Used**

EQUIPMENT	MANUFACTURER	MODEL	CAL DUE.
Spectrum analyzer	H/P	8563E	Dec. 2006
Attenuator	Lucas Weinschel	33-20-33	Dec.2006

*The results shown in this test report refer only to the sample(s) tested unless otherwise stated. This test report cannot be reproduced, except in full, without prior written permission of the Company.*

## 10. ANTENNA REQUIREMENT

### 10.1 Standard Applicable

For intentional device, according to FCC 47 CFR Section §15.203, an intentional radiator shall be designed to ensure that no antenna other than that furnished by the responsible party shall be used with the device. And according to FCC 47 CFR Section § 15.247 (b), if transmitting antennas of directional gain greater than 6dBi are used, the power shall be reduced by the amount in dB that the gain of the antenna exceeds 6dBi.

### 10.2 Antenna Connected Construction

Antenna used in this product is connected with Helical antenna gain of 2.0 dBi

*The results shown in this test report refer only to the sample(s) tested unless otherwise stated. This test report cannot be reproduced, except in full, without prior written permission of the Company.*

## 11. Attachment A-1 Photos of the test set up



*The results shown in this test report refer only to the sample(s) tested unless otherwise stated. This test report cannot be reproduced, except in full, without prior written permission of the Company.*

## Attachment A-2 Photos of the test set up

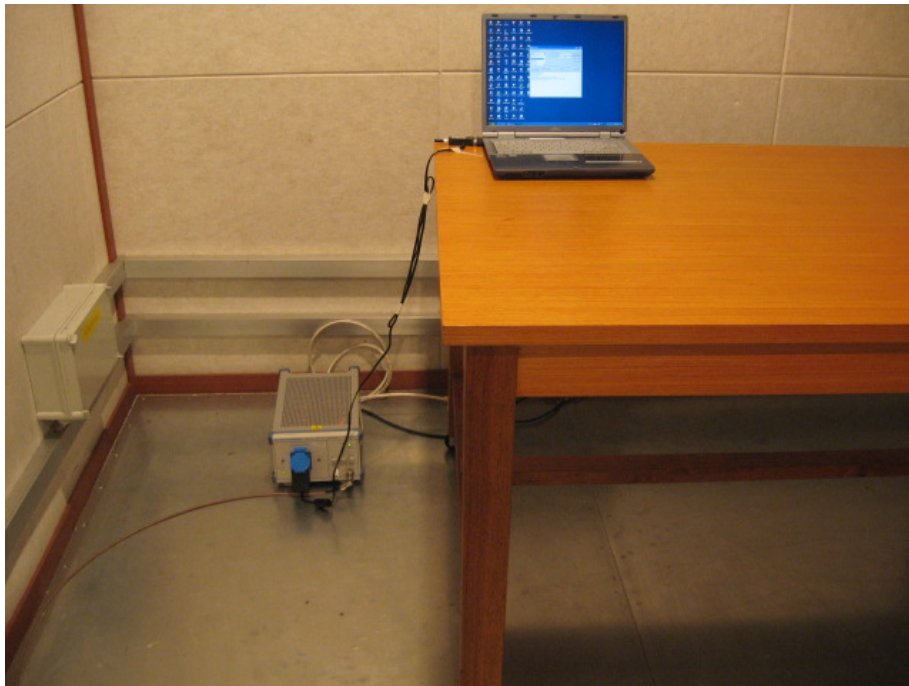

*The results shown in this test report refer only to the sample(s) tested unless otherwise stated. This test report cannot be reproduced, except in full, without prior written permission of the Company.*