

TEST REPORT

FCC RULES :Part 15 Subpart B Subpart C

FCC ID : S7ALS100W

Report File No. : STROR-05-041
Date of Issue : Aug. 10, 2005
Kind of Product : Wireless serial device server(AP)
Model Name : LS100W
Manufacturer : SENA Technologies Inc.
Serial No. : _____
Test Result : Complied

The results shown in this report refer only to the sample(s) tested unless otherwise stated. This test report cannot be reproduced, except in full, without prior written permission of company.

VERIFICATION OF COMPLIANCE

Applicant : SENA Technologies Inc.
 Kind of Product : Wireless serial device server(AP)
 Brand Name : HelloDevice
 Model Name : LS100W
 Model Difference : -
 Report File No. : STROR-05-0041
 Date of test : Jul. 29, 2005 ~ Aug. 10, 2005
 Receiver EUT : -

APPLICABLE STANDARDS	
STANDARD	TEST RESULT
Part 15 Subpart B, Subpart C	Complied

The above equipment was tested by SGS Testing Korea Co., Ltd. for compliance with the requirements set forth in the FCC RULES Part 15 Subpart B, Subpart C. The results of testing in this report apply to the product system that was tested only. Other similar equipment will not necessarily produce the same results due to production tolerance and measurement uncertainties.

Tested By:



Date

Aug. 10, 2005

Feel Jeong

Approved By



Date

Aug. 10, 2005

Albert Lim

INDEX

<u>CONTENTS</u>	<u>Page</u>
1. GENERAL INFORMATION	4
2. CONDUCTED POWERLINE TEST	6
3. SPURIOUS EMISSION, BAND EDGE, AND, RESTRICTED BANDS TEST	12
4. 6dB BANDWIDTH MEASUREMENT	23
5. MAXIMIM PEAK OUTPUT POWER MEASUREMENT	27
6. POWER SPECTRAL DENSITY MEASUREMENT	29
7.ANTENNA REQUIREMENT	33
8. RF EXPOSURE EVALUATION	34
9. Attachment A – Photos of the test set up	36
10. Attachment B – Photos of the EUT	38

1. GENERAL INFORMATION

1.1 General Description of EUT & Power

Product Name	Wireless serial device server
Model Number	LS100W
Frequency Range	2412 MHz ~ 2462 MHz
Channel Number	11
Channel Spacing	5 MHz
Air Data Rate	11 Mbps(802.11b Mode)
Type of Modulation	802.11b : DSSS(CCK,DQPSK,DBPSK)
Frequency Selection	By software/firmware
EUT Description	2.4 GHz(Direct Sequence Spread Spectrum) Data Transceiver for WLAN application
Antenna Type	External Antenna
Input Power(System)	120V _{ac} , 60 Hz

1.2 Summary of Test Results

The EUT has been tested according to the following specifications:

APPLIED STANDARD:FCC 47 C.F.R. Part15,Subpart B and Subpart C		
Standard Section	Test Item	Result
15.107 15.207	AC Power Conducted Emission	PASS
15.247(a)(2)	6 dB Bandwidth	PASS
15.247(b)	Maximum Peak Output Power	PASS
15.205(a) 15.209(a) 15.247(d)	Spurious Emission, Band Edge, and Restricted Bands	PASS
15.247(d)	Power Spectral Density	PASS
15.247(i) 1.1307(b)(1)	RF Exposure	PASS

2. CONDUCTED POWERLINE TEST

2.1 Test Setup

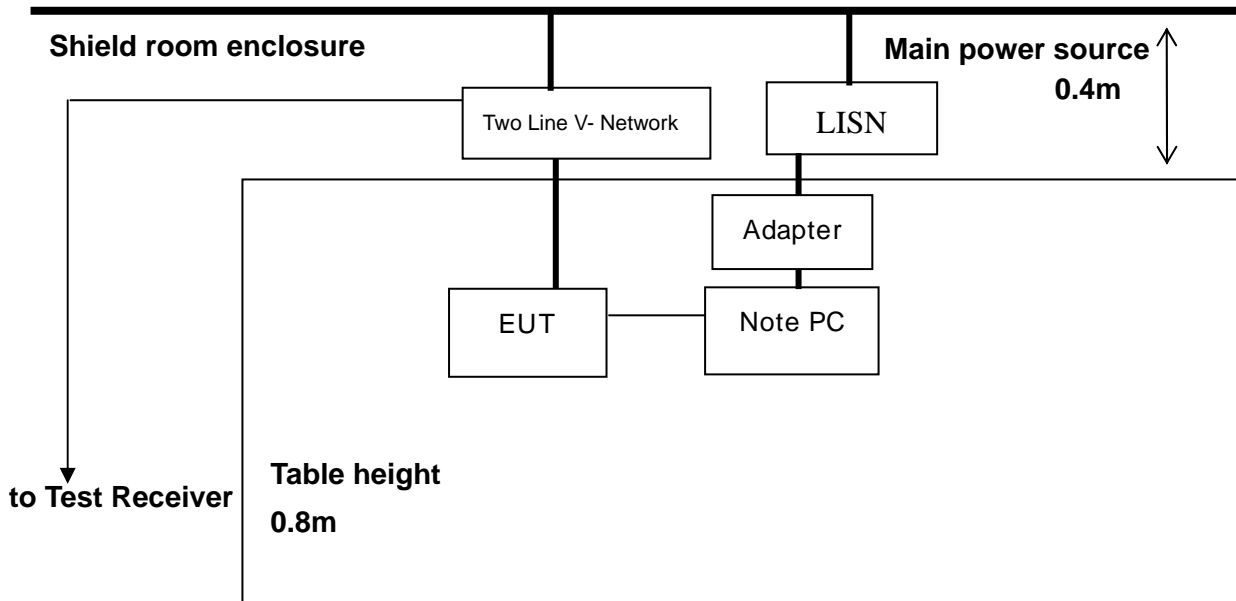

2.2 Limit

According to §15.107(a) for an intentional radiator that is designed to be connected to the public utility (AC) power line, the radio frequency voltage that is conducted back onto the AC power line on any frequency or frequencies, within the band 150 kHz to 30 MHz, shall not exceed the limits in the following table, as measured using a 50 uH/50ohm line impedance stabilization network(LISN). Compliance with the provision of this paragraph shall on the measurement of the radio frequency voltage between each power line and ground at the power terminal. The lower applies at the boundary between the frequency ranges.

Frequency of Emission (MHz)	Conducted limit (dBµ V)	
	Qausi-peak	Average
0.15 – 0.50	66 - 56*	56 - 46*
0.50 – 5.00	56	46
5.00 – 30.0	60	50

* Decreases with the logarithm of the frequency.

2.4 Test Procedure

The test procedure is performed in a 12ft×12ft×8ft(L×W×H) shielded room. The EUT along with its peripherals were placed on a 1.0m(W)× 1.5m(L) and 0.8m in height wooden table and the EUT was adjusted to maintain a 0.4 meter space from a vertical reference plane. The EUT was connected to power mains through a line impedance stabilization network (LISN) which provides 50 ohm coupling impedance for measuring instrument and the chasis ground was bounded to the horizontal ground plane of shielded room. All peripherals were connected to the second LISN and the chasis ground also bounded to the horizontal ground plane of shielded room.

The excess power cable between the EUT and the LISN was bundled. The power cables of peripherals were unbundled. All connecting cables of EUT and peripherals were moved to find the maximum emission.

2.5 Test Result

The following table shows the highest levels of conducted emissions on both phase of Hot and Neutral line.

Humidity Level	40 %	Temperature	24
----------------	------	-------------	----

Frequency range : 0.15 MHz – 30 MHz

Measured Bandwidth : 9 kHz

Test mode :802. 11b

FREQ. (MHz)	LEVEL(dB μ V)		LINE	LIMIT(dB μ V)		MARGIN(dB μ V)	
	Q-Peak	Average		Q-Peak	Average	Q-Peak	Average
0.19	49.1	39.8	H	64.0	54.0	14.9	14.3
0.29	41.9	32.2	H	60.7	50.7	18.8	18.5
0.49	41.4	22.4	H	56.3	46.3	14.9	23.9
0.53	37.9	23.9	H	56.0	46.0	18.1	22.1
0.58	31.8	22.5	H	56.0	46.0	24.2	23.5
2.21	31.1	18.6	H	56.0	46.0	25.0	27.4
0.19	48.8	39.6	N	64.0	54.0	15.2	14.4
0.29	41.7	32.8	N	60.7	50.7	19.0	17.8
0.49	35.8	26.7	N	56.3	46.3	20.4	19.5
0.53	39.0	24.6	N	56.0	46.0	17.0	21.4
0.58	32.4	21.2	N	56.0	46.0	23.6	24.8
2.21	31.1	18.3	N	56.0	46.0	24.9	27.7

REMARKS :

1. Note : • Line (H) :Hot , • Line (N) :Neutral

Plot of Conducted Powerline

Test mode:802.11b

Line (H) :Hot

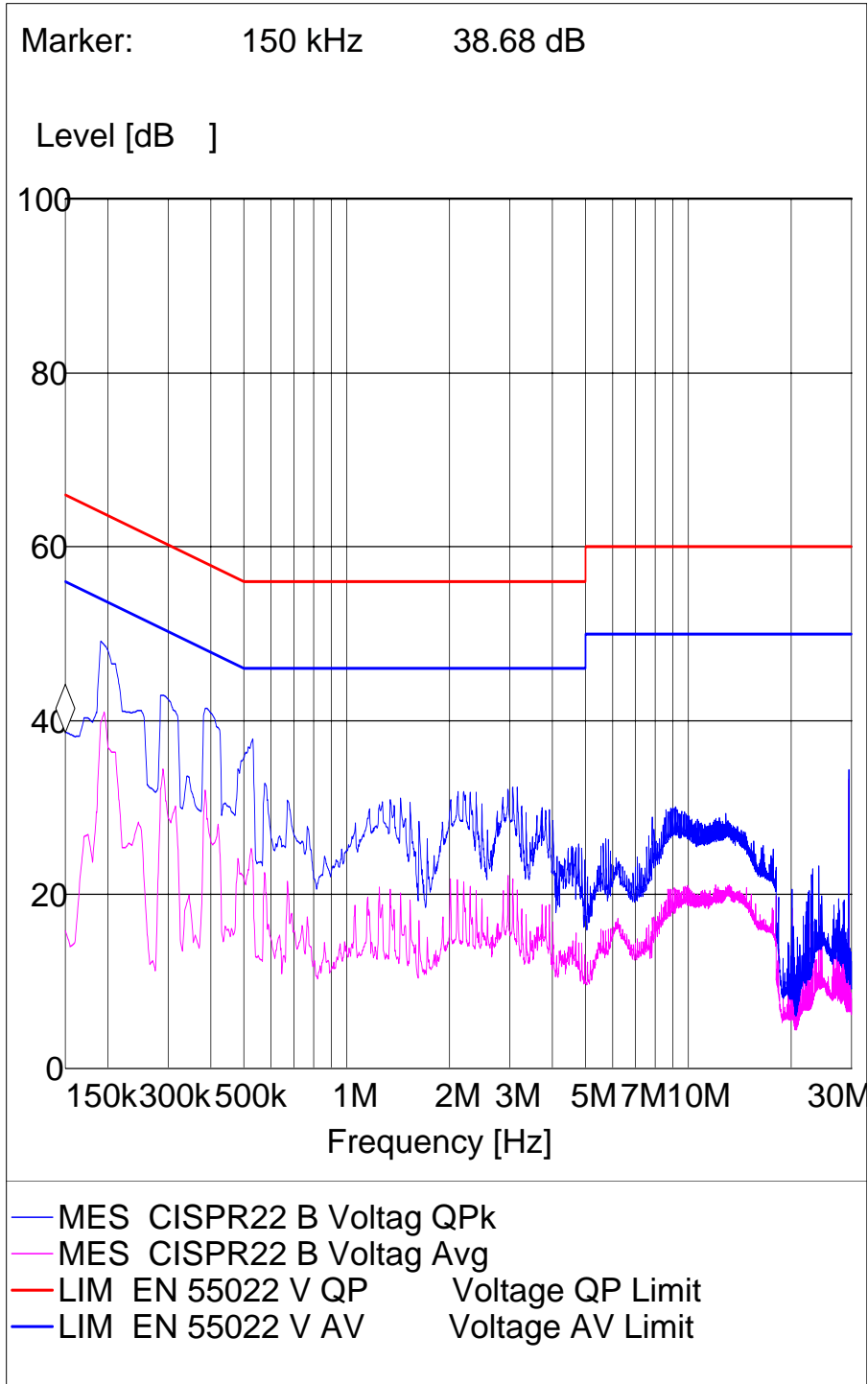

Plot of Conducted Powerline

Test mode:802.11b

Line (N) :Neutral

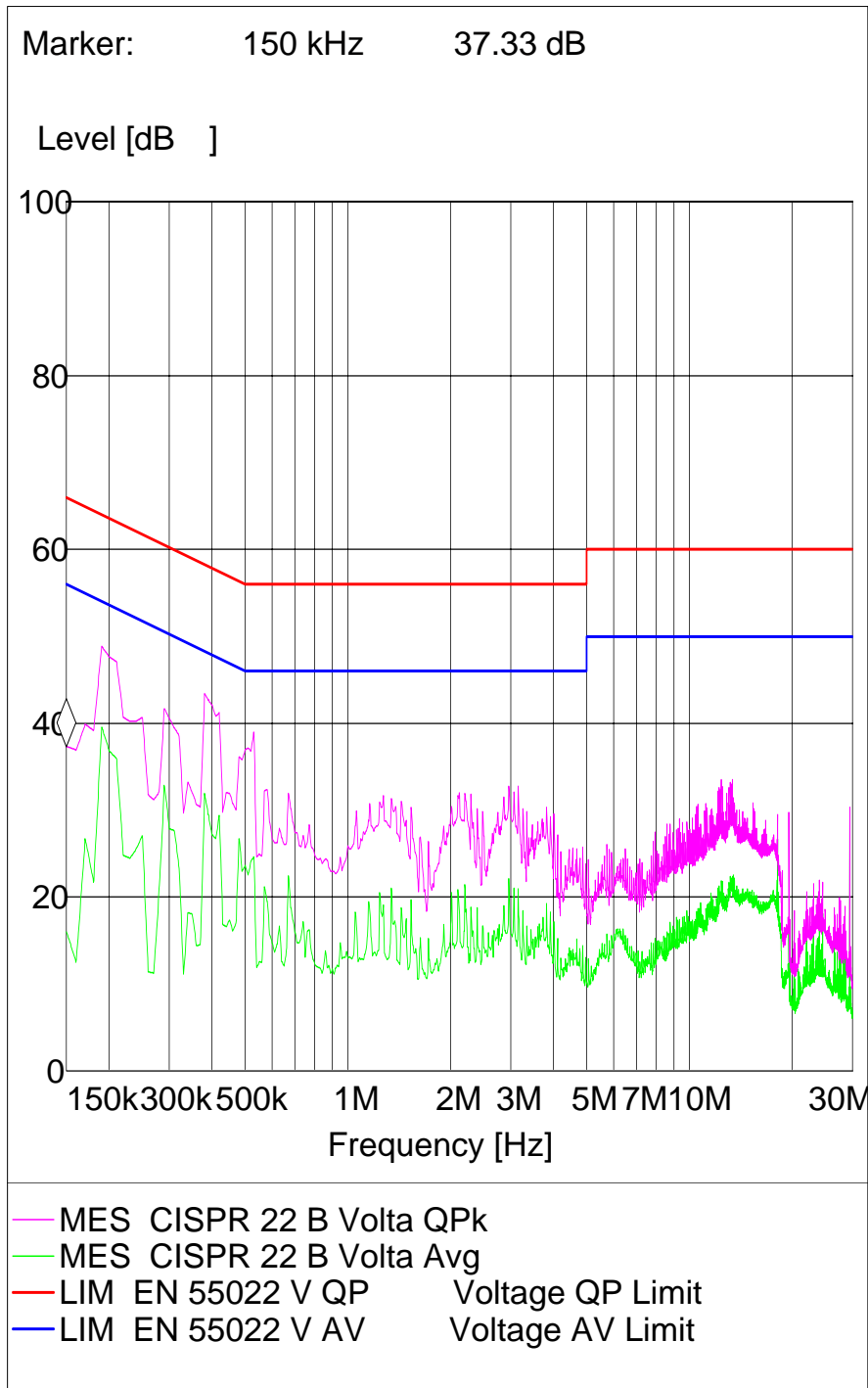

Test Equipment Used

EQUIPMENT	MANUFACTURER	MODEL	CAL DUE.
LISN	EMCO	3825/2	Dec. 2005
Two-Line V-Network	Schaffner	NNB41	Sep. 2005
Shielded Room	N/A	-	-
Test Receiver	ESHS10	R/S	Aug. 2005

3. SPURIOUS EMISSION, BAND EDGE, AND, RESTRICTED BANDS TEST

3.1 Test Setup

1) Spurious Radiated Emissions

The diagram below shows the test setup that is utilized to make the measurements for emission from 30 MHz to 18 GHz.

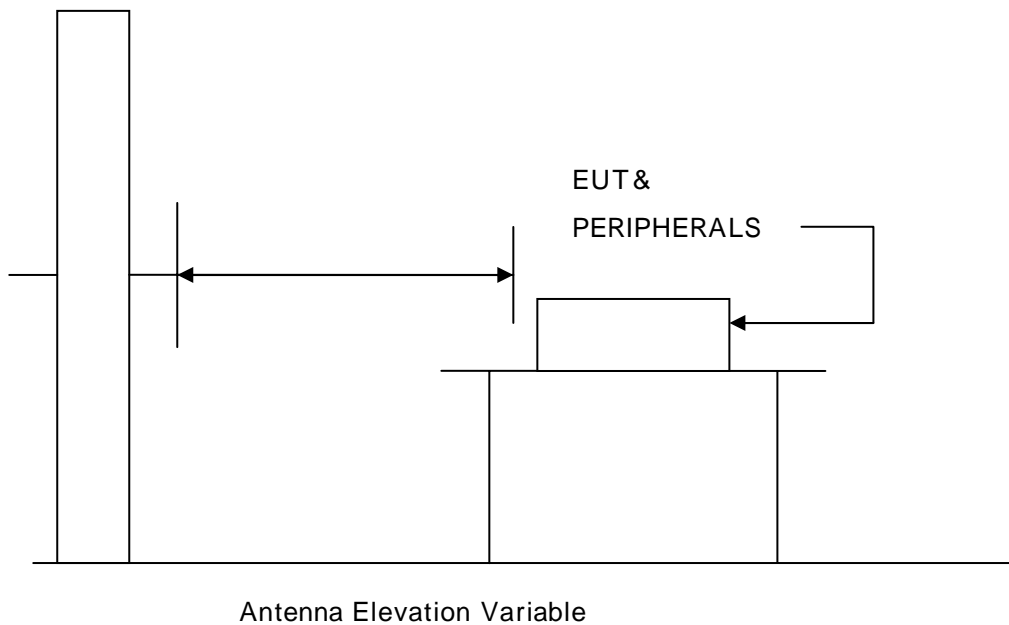

2) Spurious RF Conducted Emissions

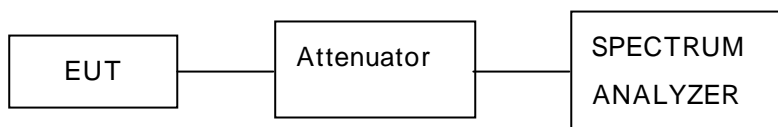

3.3 Limit

According to §15.247(d), in any 100 kHz bandwidth outside the frequency band in which the spread spectrum or digitally modulated intentional radiator is operating, the radio frequency power that is produced by the intentional radiator shall be at least 20 dB below that in the 100 kHz bandwidth within the band that contains the highest level of the desired power, based on either an RF conducted or a radiated measurement , provided the transmitter demonstrates compliance with the peak conducted power limits. If the transmitter complies with the conducted power limits based on the use of RMS averaging over a time interval , as permitted under paragraph(b)(3) of this section , the attenuation required under this paragraph shall be 30 dB instead of 20 dB. Attenuation below the general limits specified in section §15.209(a) is not required. In addition , radiated emission which in the restricted band, as define in section §15.205(a), must also comply the radiated emission limits specified in section §15.209(a) (see section §15.205(c))

According to § 15.109(a), for an intentional radiator devices, the general required of field strength of radiated emissions from unintentional radiators at a distance of 3 meters shall not exceed the following values :

Frequency (MHz)	Distance (Meters)	Radiated (dB μ V/m)	Radiated (μ V/m)
30 - 88	3	40.0	100
88 - 216	3	43.5	150
216 - 960	3	46.0	200
Above960	3	54.0	500

According to §15.109(a), for an unintentional device, except for Class A digital devices, the field strength of radiated emission from unintentional radiators at a distance of 3 meters shall not exceed the above table.

3.4 Test Procedures

1) Spurious Radiated Emissions

- a. The EUT was placed on the top of a rotating table 0.8 meters above the ground at a 10meter open area test site. The table was rotated 360 degrees to determine the position of the highest radiation.
- b. During performing radiated emission below 1 GHz, the EUT was set 3 meters away from the interference-receiving antenna, which was mounted on the top of a variable-height antenna tower. During performing radiated emission above 1 GHz, the EUT was set 1 meter away from the interference-receiving antenna.
- c. The antenna is a broadband antenna, and its height is varied from one meter to four meters above the ground to determine the maximum value of the field strength. Both horizontal and vertical polarization of the antenna are set to make the measurement.
- d. For each suspected emission, the EUT was arranged to its worst case and then the antenna was tuned to heights from 1 meter to 4 meters and the table was turned from 0 degree to 360 degrees to find the maximum reading.
- e. The test-receiver system was set to Peak Detect Function and Specified Bandwidth with Maximum Hold Mode.
- f. If the emission level of the EUT in peak mode was 10 dB lower than the limit specified, then testing could be stopped and the peak values of the EUT would be reported. Otherwise the emissions that did not have 10 dB margin would be re-tested one by one using peak, quasi-peak or average method as specified and then reported in a data sheet.

NOTE :

1. The resolution bandwidth and video bandwidth of test receiver/spectrum analyzer is 120 kHz for Peak detection (PK) and Quasi-peak detection (QP) at frequency below 1 GHz.
2. The resolution bandwidth and video bandwidth of test receiver/spectrum analyzer is 1MHz for Peak detection and frequency above 1 GHz.
3. The resolution bandwidth of test receiver/spectrum analyzer is 1 MHz and the video bandwidth is 10 Hz for Average detection (AV) at frequency above 1 GHz.

2) Spurious RF Conducted Emissions

The transmitter output was connected to the spectrum analyzer via a low lose cable. Set both RBW and VBW of spectrum analyzer with suitable frequency span including 100 kHz bandwidth from band edge. The band edges was measured and recorded.

3.5 Test Result

1) Spurious Radiated Emissions

The frequency spectrum from 30 MHz to 1000 MHz was investigated. All emission not reported are much lower than the prescribed limits. All readings are quasi-peak values.

Humidity Level	45 %	Temperature	23
----------------	------	-------------	----

Radiated Spurious Emission 30 MHz ~1000 MHz Test Data (Worst-Case Configuration)

Radiated Emissions			Ant	Correction Factors		Total	FCC Limit	
Carrier Freq. (MHz)	Reading (dBuV)	Detect Mode	Pol.	Ant. (dB/m)	Cable (dB)	Actual (dBuV/m)	Limit (dBuV/m)	Margin (dB)
80.12	14.8	Q.P.	H	8.18	0.94	23.92	40.00	16.08
220.48	3.4	Q.P.	H	16.42	1.54	21.36	46.00	26.64
222.12	7.2	Q.P.	V	16.45	1.54	25.19	46.00	20.81
572.04	14.4	Q.P.	V	20.98	2.47	37.85	46.00	8.15
616.05	11.0	Q.P.	V	21.41	2.58	32.41	46.00	13.59

REMARKS :

1. All spurious emission at channel 1,6,11 are almost the same below 1 GHz, so that the channel 6 was chosen at representative in final test
2. “*” means the restricted band.
3. Actual = Reading + AF + CL

The frequency spectrum above 1000 MHz was investigated. All emission not reported are much lower than the prescribed limits. Readings are both peak and average values.

Humidity Level	45%	Temperature	25
----------------	-----	-------------	----

Radiated Emission Test Data (Above 1 GHz)

1. 802. 11b Low Channel (2412 MHz)

Radiated Emissions			Ant	Correction Factors		Total	FCC Limit	
Carrier Freq. (MHz)	Reading (dBuV)	Detect Mode	Pol.	AF/CL (dB/m)/(dB)	Amp Gain (dB)	Actual (dBuV/m)	Limit (dBuV/m)	Margin (dB)
*2390	52.48	Peak	V	24.69/8.06	36.54	48.69	74.00	25.31
*2390	41.94	Average	V	24.69/8.06	36.54	38.15	54.00	15.85
*4824	55.04	Peak	V	32.17/10.00	36.33	60.88	74.00	13.12
*4824	39.20	Average	V	32.17/10.00	36.33	45.04	54.00	8.96
7236	41.12	Peak	V	37.37/13.58	36.43	55.64	74.00	18.36
7236	34.17	Average	V	37.37/13.58	36.43	48.69	54.00	5.31

2. 802. 11b Middle Channel (2437 MHz)

Radiated Emissions			Ant	Correction Factors		Total	FCC Limit	
Carrier Freq. (MHz)	Reading (dBuV)	Detect Mode	Pol.	AF/CL (dB/m)/(dB)	Amp Gain (dB)	Actual (dBuV/m)	Limit (dBuV/m)	Margin (dB)
2181	43.61	Peak	V	26.44/8.06	36.51	41.60	74.00	32.40
2181	33.81	Average	V	26.44/8.06	36.51	31.80	54.00	22.20
*4874	56.12	Peak	V	32.28/10.00	36.33	62.07	74.00	11.93
*4874	45.02	Average	V	32.28/10.00	36.33	50.97	54.00	3.03
*7311	44.82	Peak	V	37.44/13.58	36.43	59.41	74.00	14.59
*7311	35.99	Average	V	37.44/13.58	36.43	50.58	54.00	3.42

3. 802. 11b High Channel (2462 MHz)

Radiated Emissions			Ant	Correction Factors		Total	FCC Limit	
Carrier Freq. (MHz)	Reading (dBuV)	Detect Mode	Pol.	AF/CL (dB/m)/(dB)	Amp Gain (dB)	Actual (dBuV/m)	Limit (dBuV/m)	Margin (dB)
*2483.5	54.32	Peak	V	27.35/8.06	36.54	53.19	74.00	20.81
*2483.5	44.16	Average	V	27.35/8.06	36.54	25.57	54.00	28.43
*4924	55.82	Peak	V	32.38/10.00	36.33	61.87	74.00	12.13
*4924	43.00	Average	V	32.38/10.00	36.33	49.05	54.00	4.95
*7386	46.02	Peak	V	37.52/13.58	36.43	60.69	74.00	13.31
*7386	35.40	Average	V	37.52/13.58	36.43	50.07	54.00	3.93

REMARKS :

1. "*" means the Restricted band.
2. Actual = Reading + AF + CL - Amp Gain

Test Equipment Used

EQUIPMENT	MANUFACTURER	MODEL	CAL DUE.
Spectrum analyzer	H/P	8593E	Aug. 2005
Test Receiver	Rohde & Schwarz	ESVS 10	Jun. 2006
Preamplifier	Agilent	8449B	May 2006
Biconical Antenna	Schwarzbeck	VHA9103	Mar.2006
Log-periodic	Rohde & Schwarz	UHALP9107	Jan. 2006
Horn Antenna	Schwarzbeck	BBHA 9120D	Jul. 2006

2) Spurious RF Conducted Emissions : Plot of Spurious RF Conducted Emissions
 802.11b Mode :

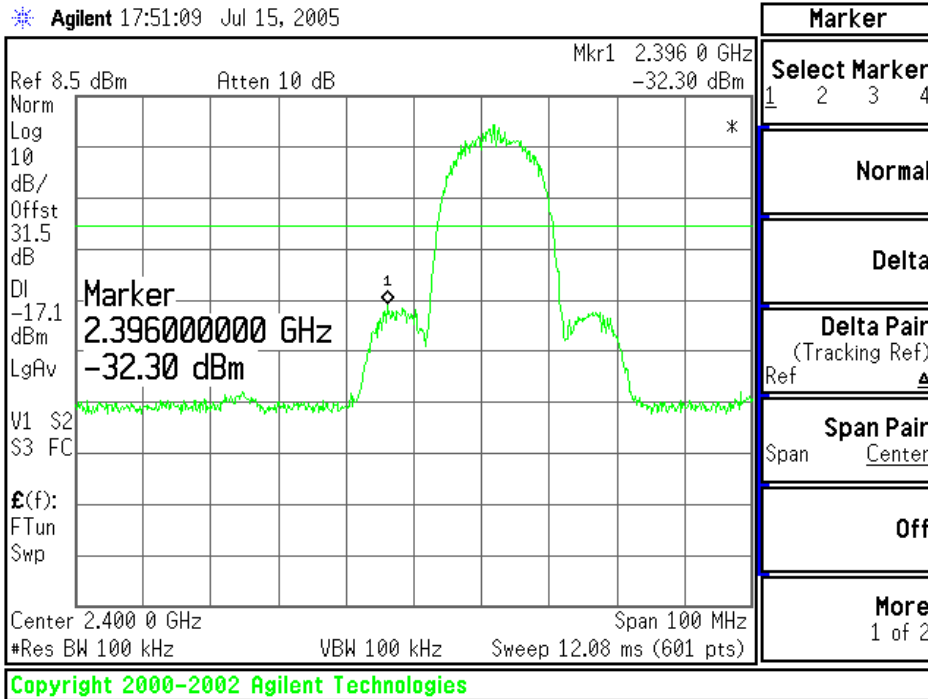

Channel 1

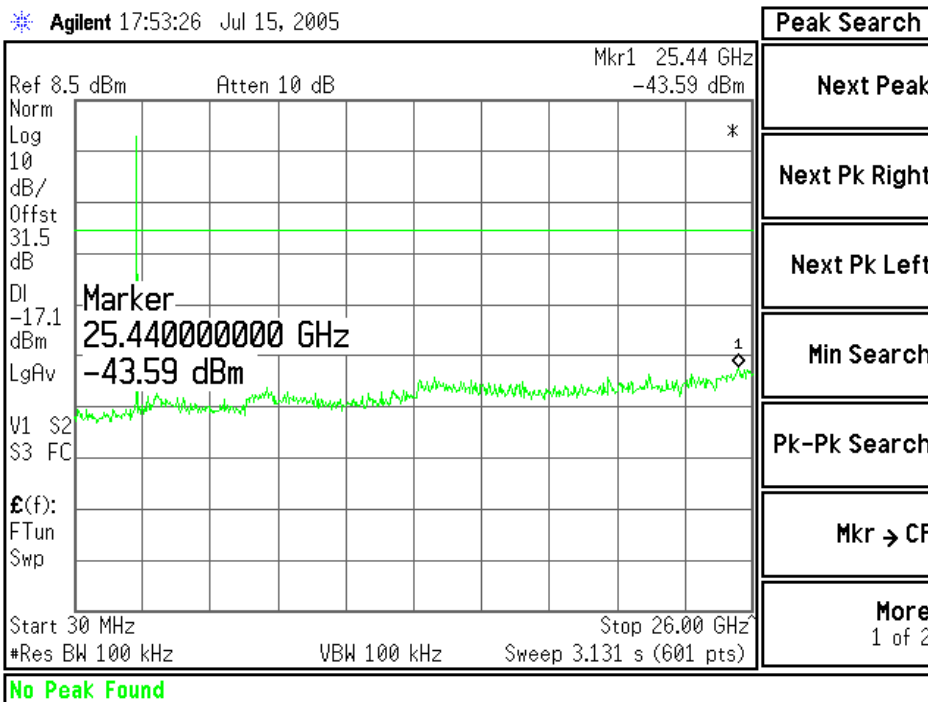

Channel 1

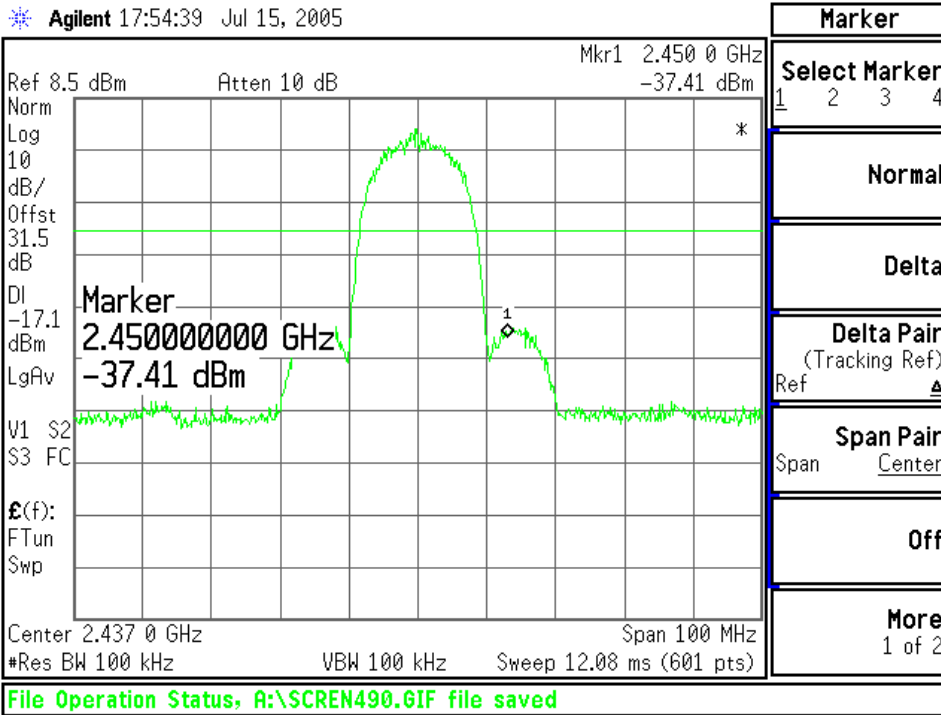

Channel 6

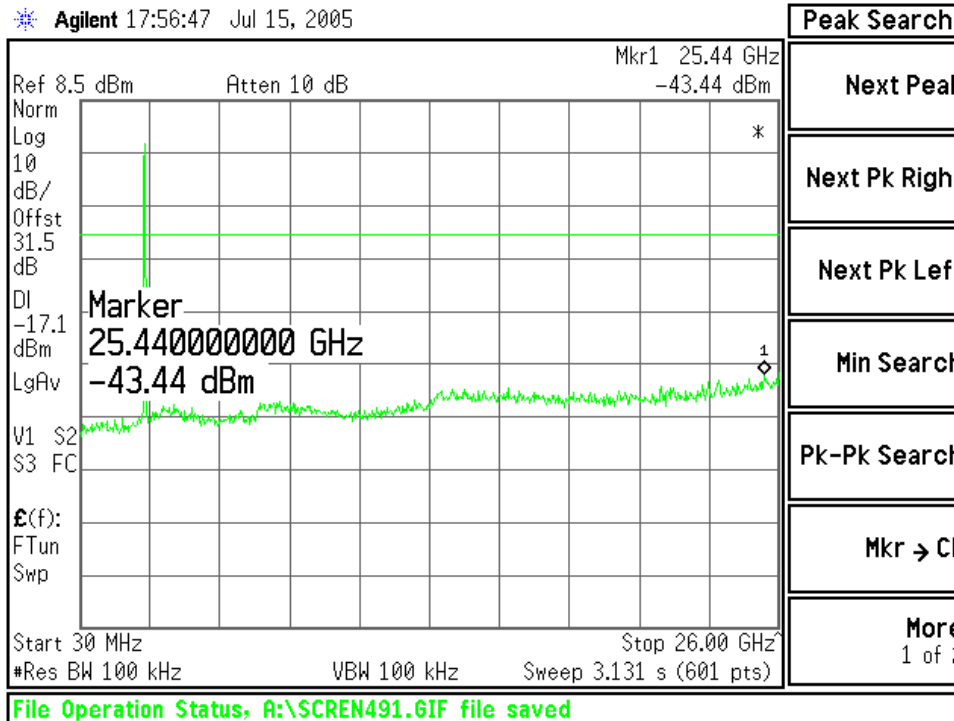

Channel 6

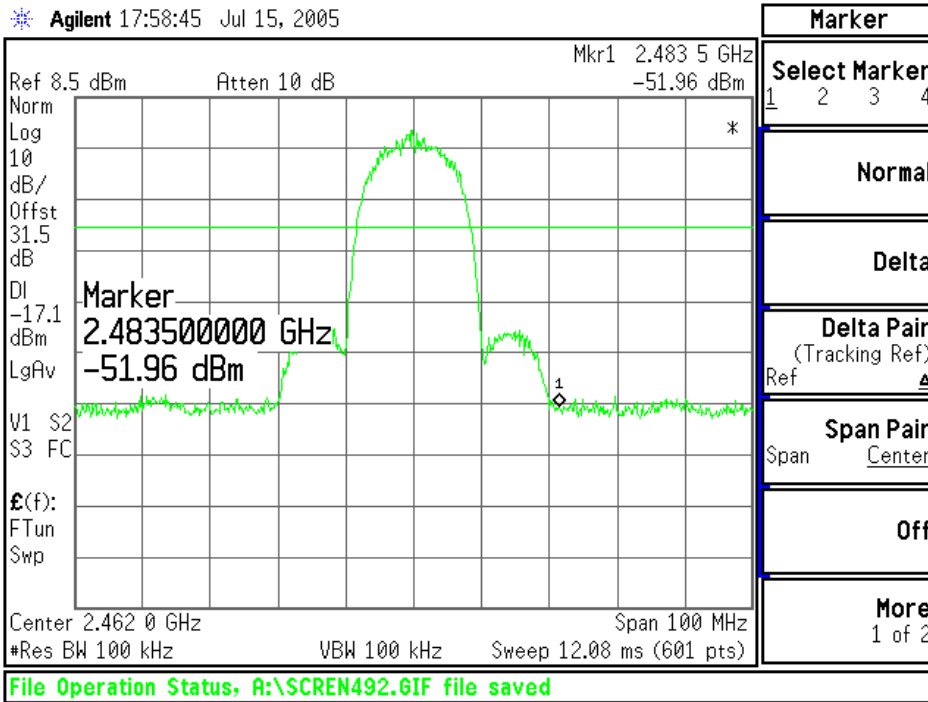

Channel 11

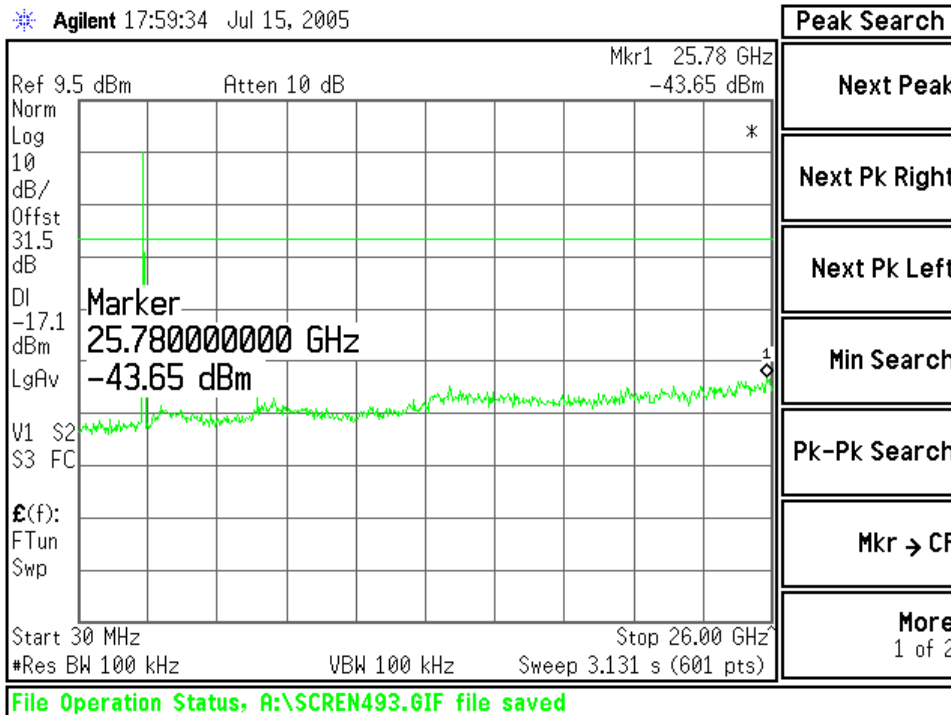

Channel 11

Test Equipment Used

EQUIPMENT	MANUFACTURER	MODEL	CAL DUE.
Attenuator	Agilent	8498A	May 2006
Spectrum analyzer	Agilent	E4440A	May 2006

4. 6dB BANDWIDTH MEASUREMENT

4.1 Test Setup

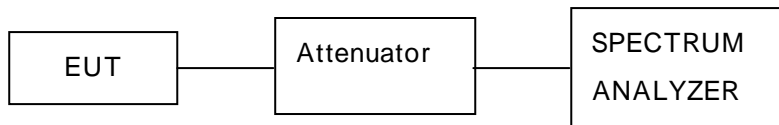

4.2 Limits

According to §15.247(a)(2), systems using digital modulation techniques may operate in the 902 ~ 928 MHz , 2400 ~ 2483.5 MHz, and 5725 ~ 5825 MHz bands. The minimum of 6dB Bandwidth shall be at least 500 kHz

4.3 Test Procedure

The transmitter output was connected to the spectrum analyzer through an attenuator. The bandwidth of the fundamental frequency was measured by spectrum analyzer with RBW=100 kHz and VBW=100 kHz. The 6dB bandwidth is defined as the total spectrum the power of which is higher than peak power minus 6dB.

4.4 Test Result

Humidity Level	45%	Temperature	25
----------------	-----	-------------	----

Channel	Channel Frequency (MHz)	6dB Bandwidth (MHz)	Minimum Limit (MHz)
Low	2412	11.10	0.5
Middle	2437	11.03	0.5
High	2462	11.07	0.5

Note:

:1. For 802.11b mode.

2. At final test to get the worst-case emission at 11 Mbps.

Plot of 6dB Bandwidth

802.11b Mode :

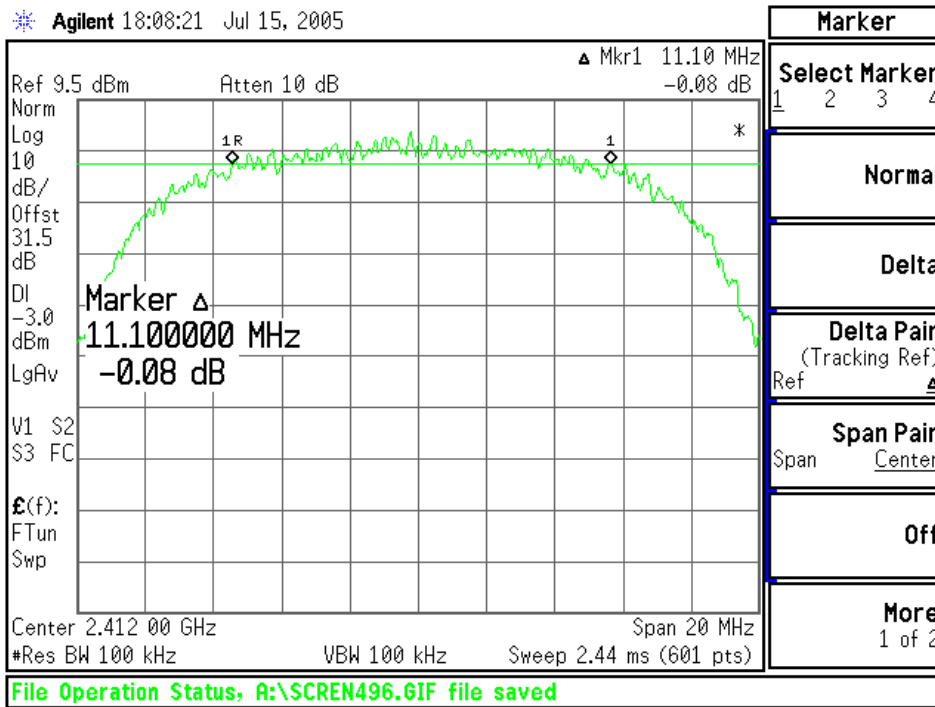

Channel 1

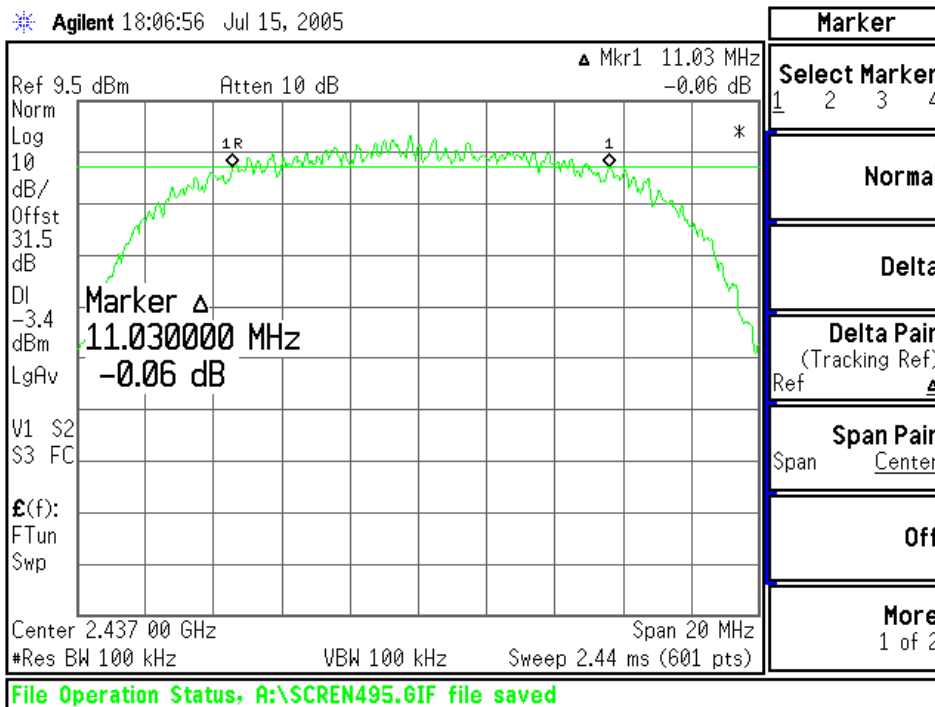

Channel 6

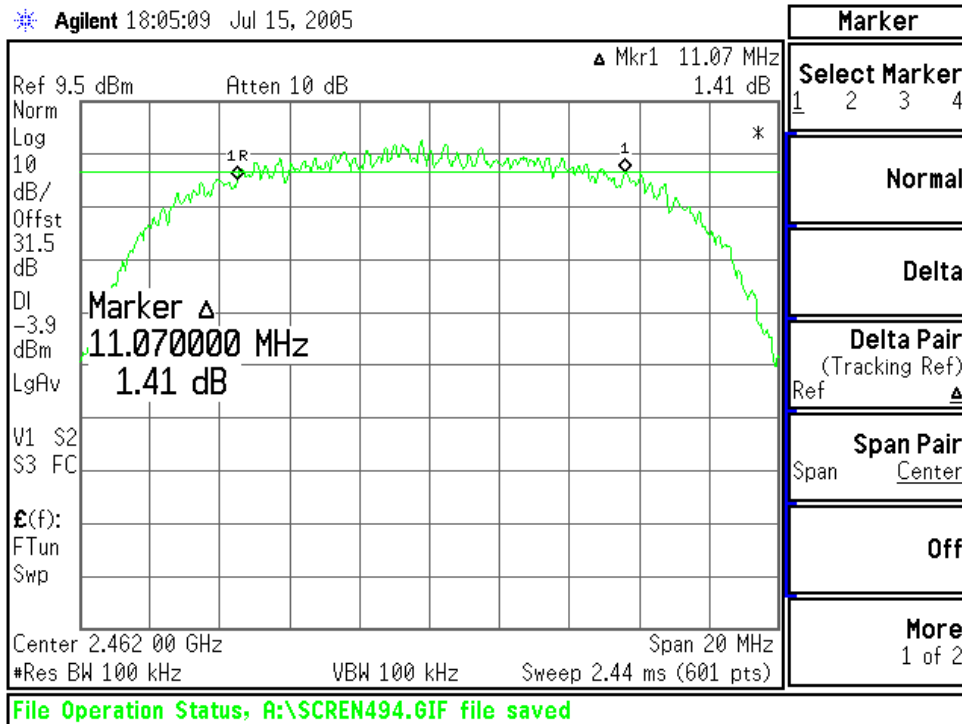

Channel 11

Test Equipment Used

EQUIPMENT	MANUFACTURER	MODEL	CAL DUE.
Attenuator	Agilent	8498A	May 2006
Spectrum analyzer	Agilent	E4440A	May 2006

5. MAXIMIM PEAK OUTPUT POWER MEASUREMENT

5.1 Test Setup

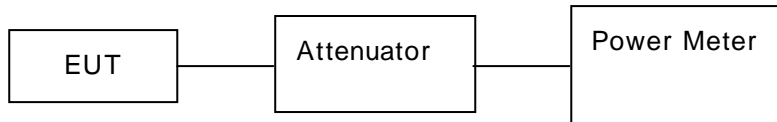

5.2 Limit

According to §15.247(b)(3), for systems using digital modulation in the 902 ~ 928 MHz, 2400 ~ 2483.5 MHz, and 5725 ~ 5850 MHz band: 1 Watt. As an alternative to a peak power measurement, Compliance with the one Watt limit can be based on a measurement of the maximum conducted output power. Maximum Conducted Output Power is defined as the total transmit power delivered to all antennas and antenna elements averaged across all symbols in the signaling alphabet when the transmitter is operating at its maximum power control level. Power must be summed across all antenna elements. The average must not include any intervals during which the transmitter is off or is transmitting at a reduced power level. If multiple modes of operation are possible (e.g., alternative modulation methods), the maximum conducted output power is the highest total transmit power occurring in any mode.

According to §15.247(b)(4), the conducted output power limit specified in paragraph(b) of this section is based on the use of antenna with directional gains that do not exceed 6 dBi. Except as shown in paragraph(c) of this section, if transmitting antenna of directional gain greater than 6 dBi are used, the conducted output power from the intentional radiator shall be reduced below the stated values in paragraph(b)(1), (b)(2), and (b)(3) of this section , as appropriate, by the amount in dB that the directional gain of the antenna exceeds 6 dBi

5.4 Test Procedure

The RF power output was measured with a Power meter connected to the Antenna connector (conducted measurement)while EUT was operating in transmit mode at the appropriate center frequency.

5.5 Test Result

Humidity Level	45%	Temperature	25
----------------	-----	-------------	----

Channel	Channel Frequency (MHz)	Average Power Output (dBm)	Peak Power Output (dBm)	Peak Power Limit (dBm)	Margin (dB)
Low	2412	12.05	13.27	30	16.73
Middle	2437	11.61	12.74	30	17.26
High	2462	11.16	12.34	30	17.66

Note:

- :1. For 802.11b mode.
 2. At final test to get the worst-case emission at 11 Mbps.
 3. Cable loss = 1.5dB, Attenuator = 30dB.
 4. The results are calculated as the following equation :
- Peak Power Output = Peak Power Reading + Cable loss + Attenuator

Test Equipment Used

EQUIPMENT	MANUFACTURER	MODEL	CAL DUE.
Attenuator	Agilent	8498A	May 2006
Power Sensor	Agilent	E9327A	May 2006
Power Meter	Agilent	E4416A	May 2006

6. POWER SPECTRAL DENSITY MEASUREMENT

6.1 Test Setup

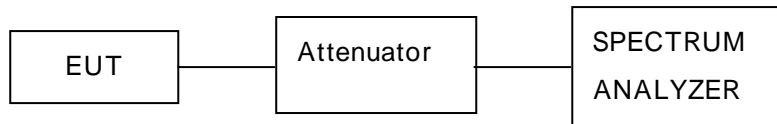

6.2 Limit

According to §15.247(e), For digitally modulated system, the power spectral density conducted from the intentional radiator to the antenna shall not be greater than 8 dBm in any 3 kHz band any time interval of continuous transmission. This power spectral density shall be determined in accordance with the provisions of paragraph(b) of this section. The same method of determining the conducted output power shall be used to determine the power spectral density

6.3 Test Procedure

The transmitter output was connected to the spectrum analyzer through an attenuator, the bandwidth of the fundamental frequency was measured with the spectrum analyzer using RBW=3 kHz and VBW>=3 kHz, set sweep time=span / 3 kHz.

The power spectral density was measured and recorded.

The sweep time is allowed to be longer than span / 3 kHz for a full response of the mixer in the spectrum analyzer.

3.6 Test Result

Humidity Level	45%	Temperature	25
----------------	-----	-------------	----

Channel	Channel Frequency (MHz)	Final RF Power Level in 3 kHz BW (dBm)	Maximum Limit (dBm)	Margin (dB)
Low	2412	-11.94	8	19.94
Middle	2437	-12.32	8	20.32
High	2462	-13.06	8	21.06

Note :

For 11 Mbps (802.11b mode) at final test to get the worst-case emission at 11 Mbps.

Plot of Power Spectral Density

802.11b Mode :

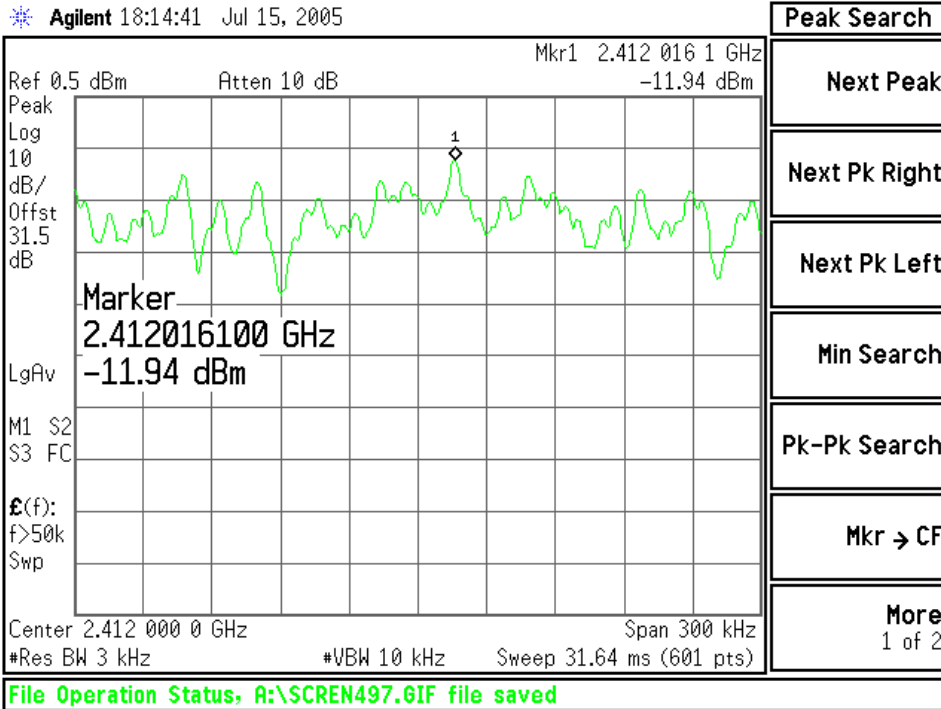

Channel 1

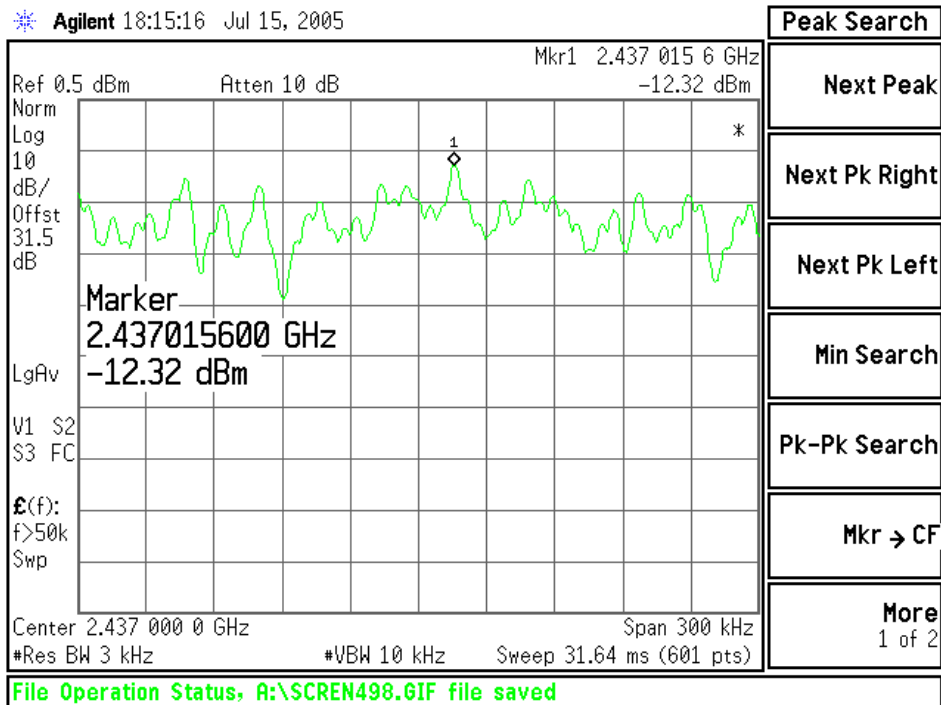

Channel 6

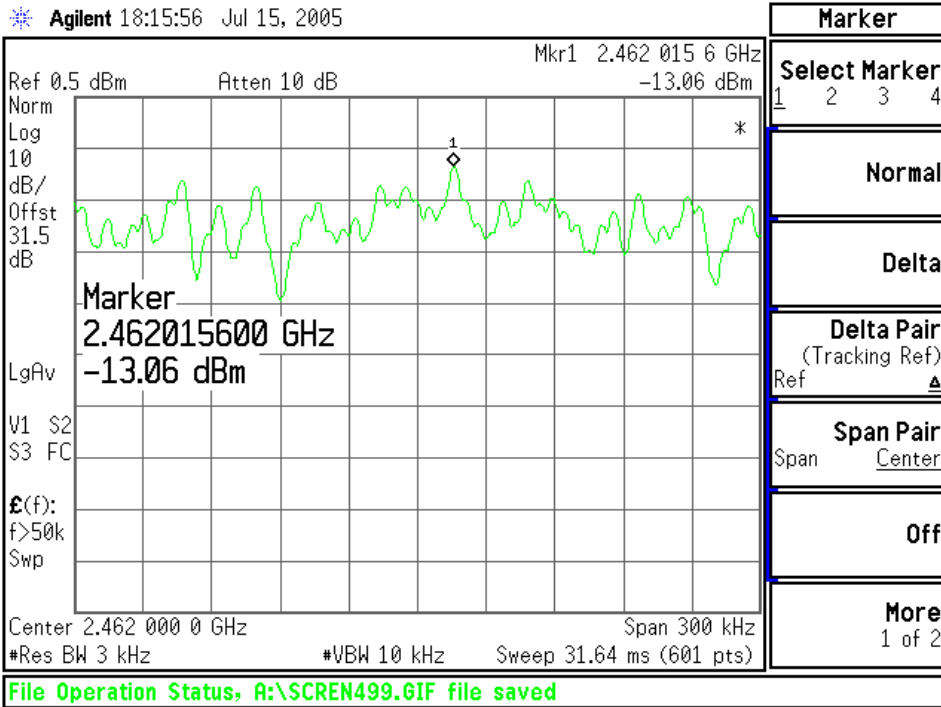

Channel 11

Test Equipment Used

EQUIPMENT	MANUFACTURER	MODEL	CAL DUE.
Attenuator	Agilent	8498A	May 2006
Spectrum analyzer	Agilent	E4440A	May 2006

7.ANTENNA REQUIREMENT

7.1 Standard Applicable

For intentional device, according to FCC 47 CFR Section §15.203, an intentional radiator shall be designed to ensure that no antenna other than that furnished by the responsible party shall be used with the device. And according to FCC 47 CFR Section § 15.247 (b), if transmitting antennas of directional gain greater than 6dBi are used, the power shall be reduced by the amount in dB that the gain of the antenna exceeds 6dBi.

7.2 Antenna Connected Construction

Antenna used in this product is connected External antenna gain of 4.26dBi

8. RF EXPOSURE EVALUATION

According to FCC 1.1310 : The criteria listed in the following table shall be used to evaluate the environment impact of human exposure to radio frequency (RF) radiation as specified in § 1.1307(b)

LIMITS FOR MAXIMUM PERMISSIBLE EXPOSURE (MPE)

Frequency Range (MHz)	Electric Field Strength(V/m)	Magnetic Field Strength (A/m)	Power Density (mW/cm ²)	Average Time
(A) Limits for Occupational /Control Exposures				
300 – 1500	--	--	F/300	6
1500 - 100000	--	--	5	6
(B) Limits for General Population/Uncontrol Exposures				
300 – 1500	--	--	F/1500	6
1500 - 100000	--	--	1	30

8.1 Friis transmission formula : $P_d = (P_{out} * G) / (4 * \pi * R^2)$

Where

P_d = power density in mW/cm²

P_{out} = output power to antenna in mW

G = gain of antenna in linear scale

π = 3.1416

R = distance between observation point and center of the radiator in cm

P_d the limit of MPE, 1 mW/ cm². If we know the maximum gain of the antenna and the total power input to the antenna, through the calculation, we will know the distance where the MPE limit is reached.

8.2 EUT Operating Condition

A software provided by client enabled the EUT to transmit and receive data at low, middle and high channel individually.

8.3 Test Result of RF Exposure Evaluation

Test Item : RF Exposure Evaluation Data

Test Mode : Normal Operation

8.3.1 Output Power into Antenna & RF Exposure Evaluation Distance

External Antenna gain : 4.26dBi

Channel	Channel Frequency (MHz)	Output Peak Power to Antenna (dBm)	Antenna Gain (dBi)	Power Density at 20 cm (mW/cm ²)	LIMITS (mW/cm ²)
Low	2412	13.27	4.26	0.01128	1
Middle	2437	12.74	4.26	0.00998	1
High	2462	12.34	4.26	0.00910	1

Note :

1. For 802.11b mode (11Mbps).
2. The power density Pd (4th column) at a distance of 20cm calculated from the friis transmission formula is far below the limit of 1 mW/ cm².

9. Attachment A-1 Photos of the test set up



Attachment A-2 Photos of the test set up



10. Attachment B – Photos of the EUT

View of EUT



Rear View of EUT



Front View of Main-board



Rear View of Main-board



Front View of RF module Part



Rear View of RF module Part

