











Basic model

SMH5-FM(SMH5)
Model: SP96-A
FCC ID: S7A-SP96
IC: 8154A-SP96
KC: R-C-PA2-SP96
5V $\overline{=}$, 0.5A
Sena Technologies
Made in China



Family model

SMH5-FM(SMH5)
Model: SP96-A
FCC ID: S7A-SP96
IC: 8154A-SP96
KC: R-C-PA2-SP96
5V $\overline{=}$, 0.5A
Sena Technologies
Made in China



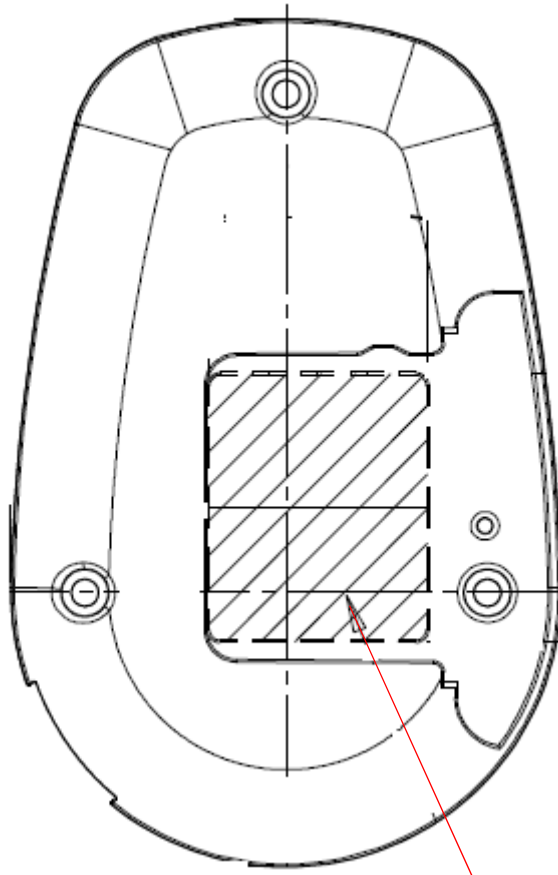

Label