

7.4.2. Conducted Spurious Emissions

Low Band-edge

Lowest Channel & Modulation : GFSK

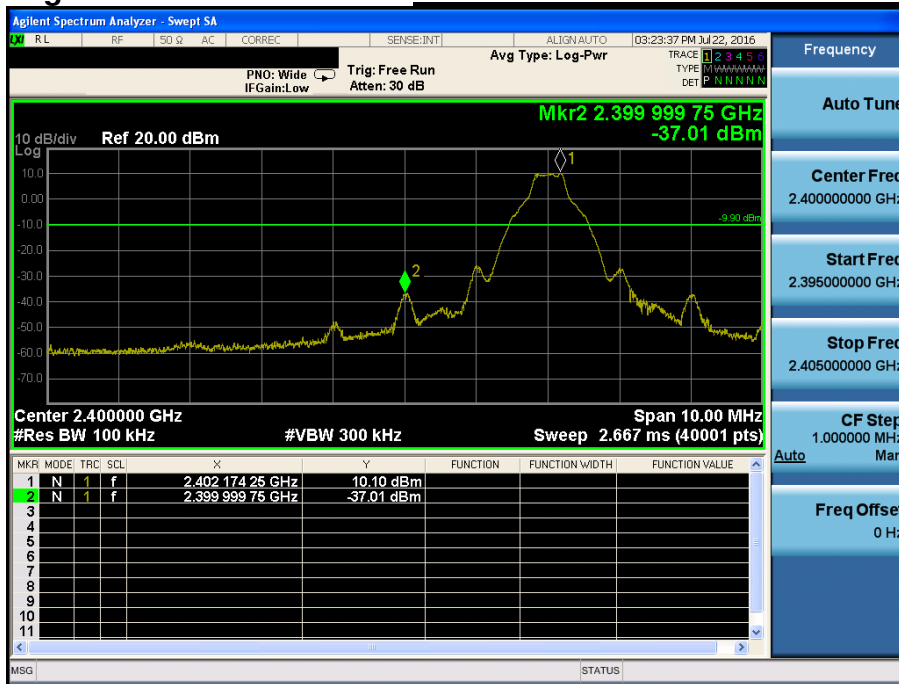

Low Band-edge

Hopping mode & Modulation : GFSK

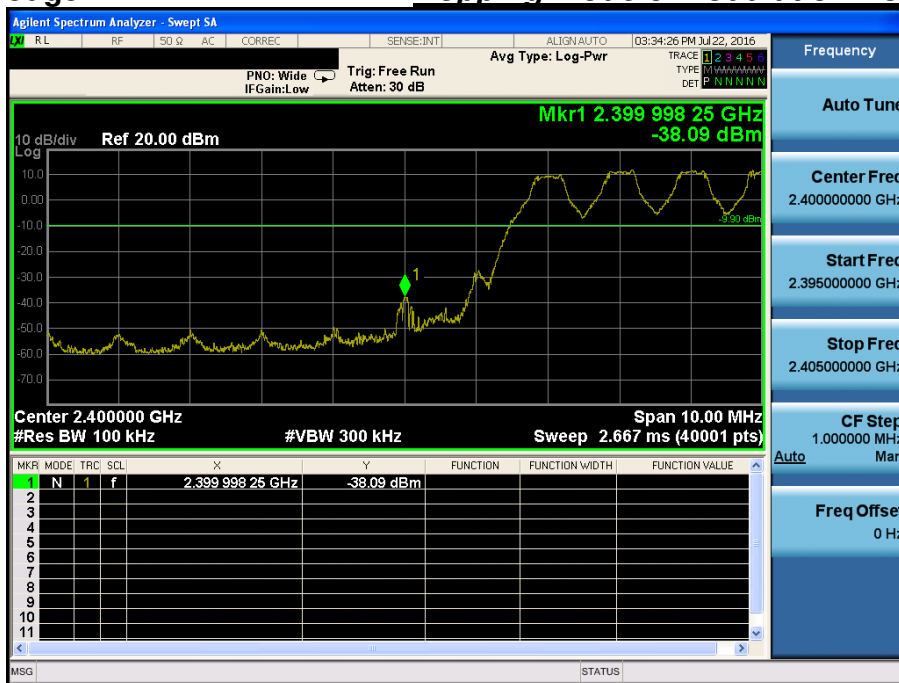

Conducted Spurious Emissions **Lowest Channel & Modulation : GFSK**

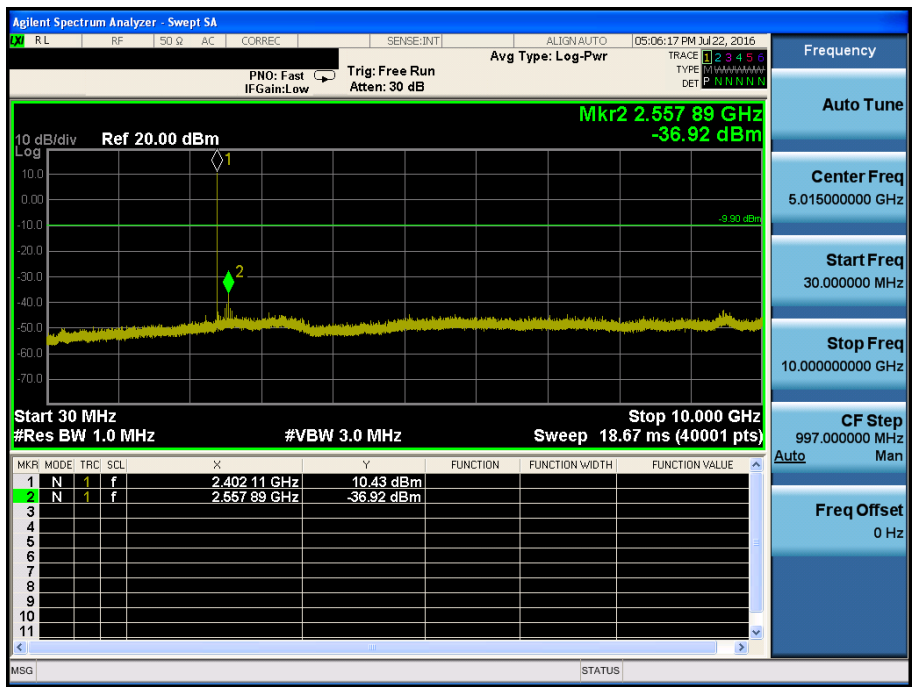
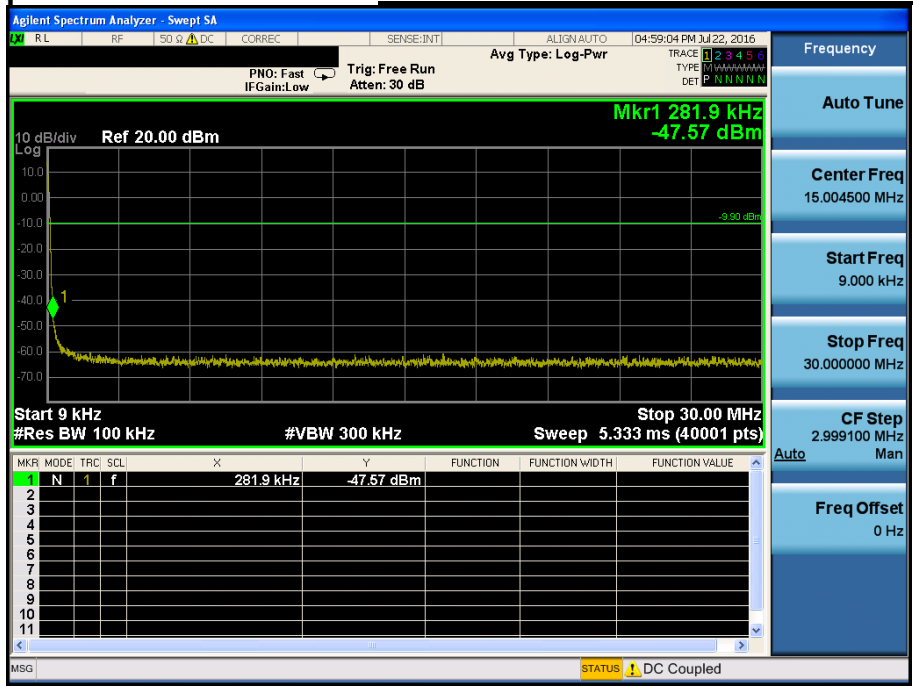

Conducted Spurious Emissions *Lowest Channel & Modulation : GFSK*

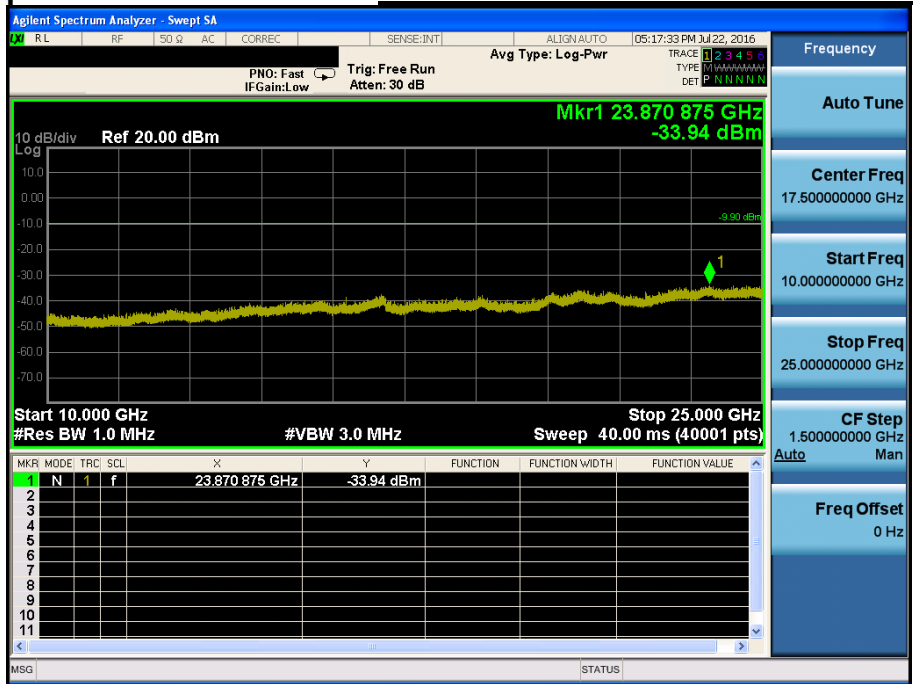

Reference for limit

Middle Channel & Modulation : GFSK

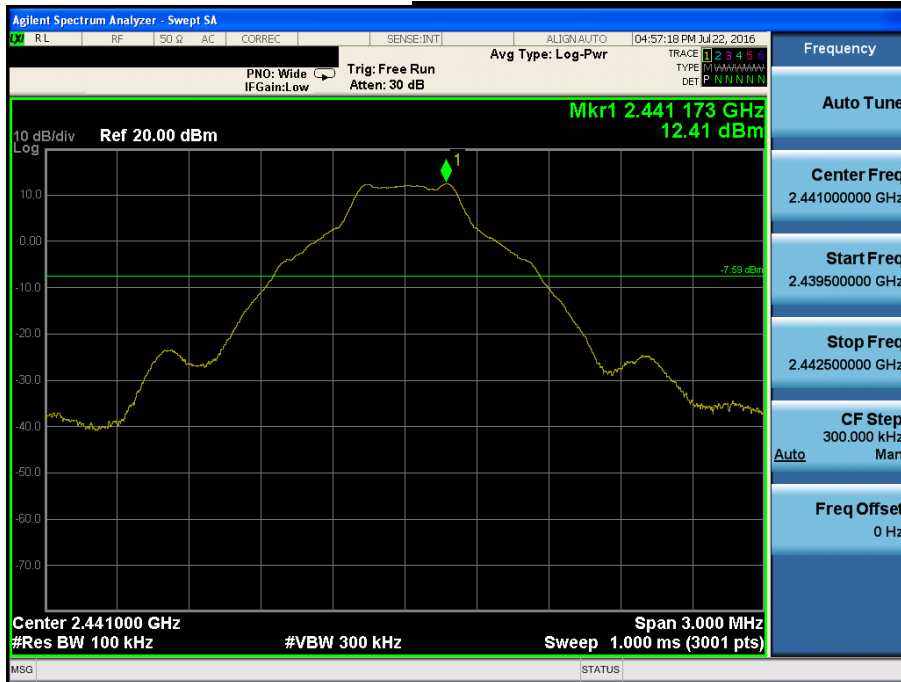

Conducted Spurious Emissions

Middle Channel & Modulation : GFSK

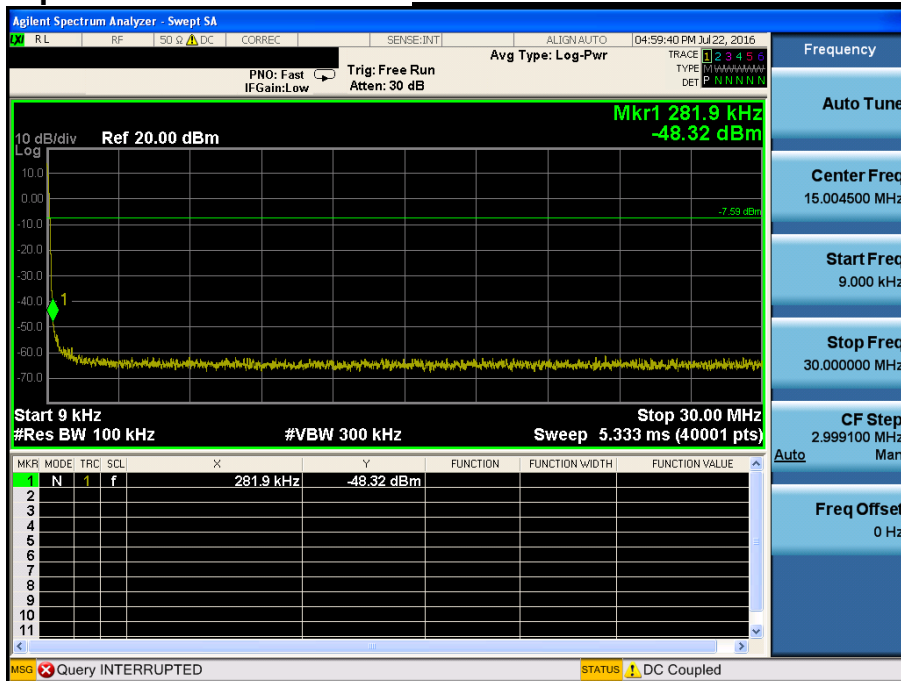

Conducted Spurious Emissions *Middle Channel & Modulation : GFSK*

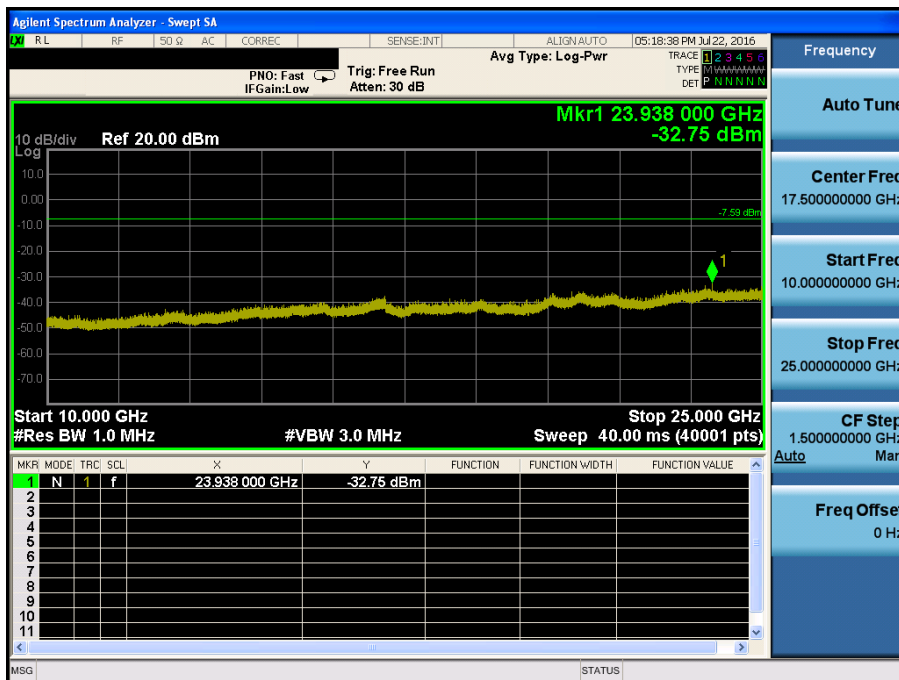
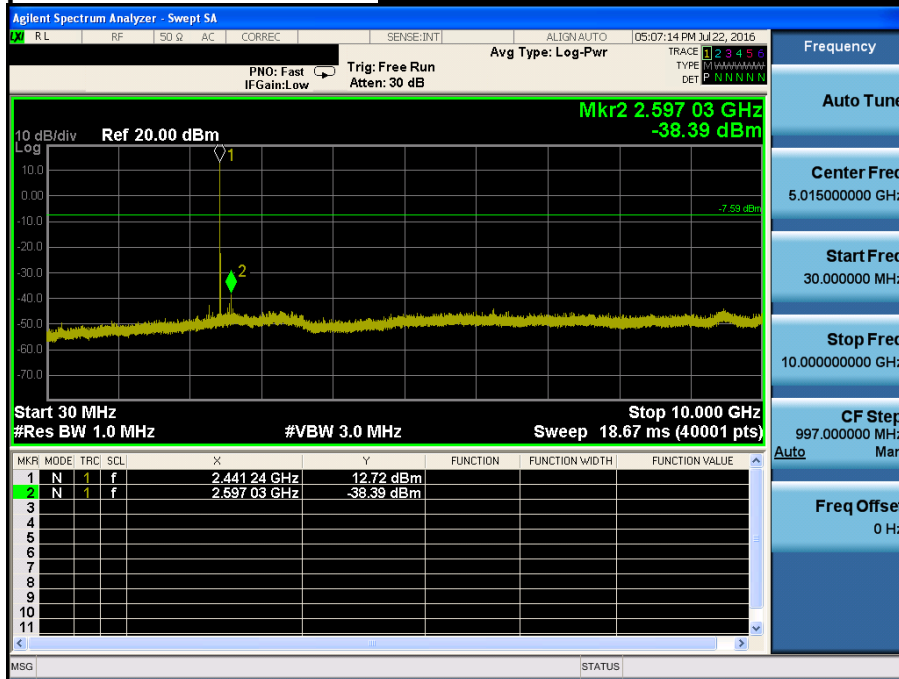

High Band-edge

Highest Channel & Modulation : GFSK

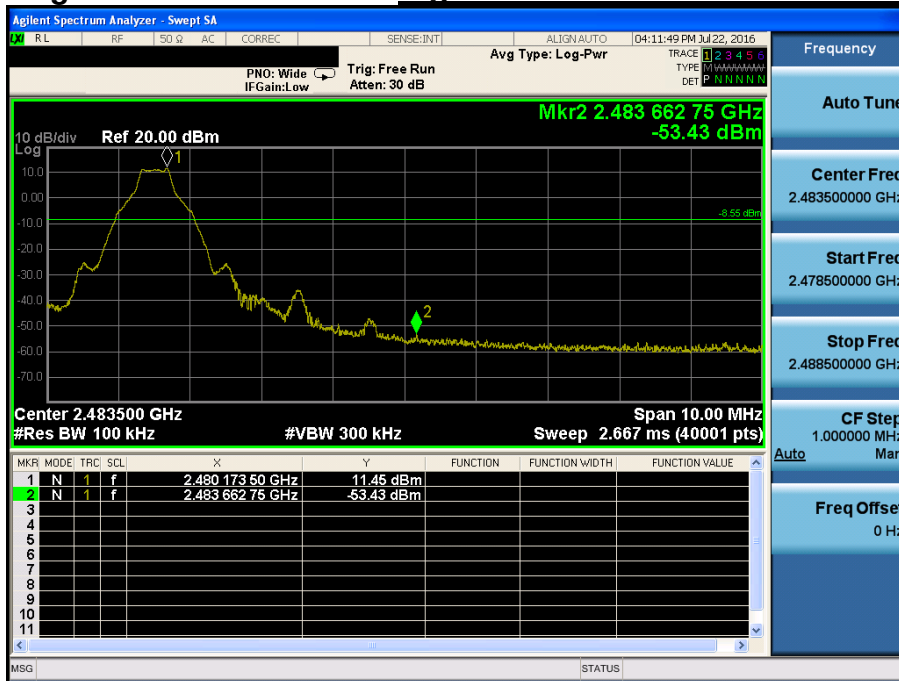

High Band-edge

Hopping mode & Modulation : GFSK



Conducted Spurious Emissions *Highest Channel & Modulation : GFSK*

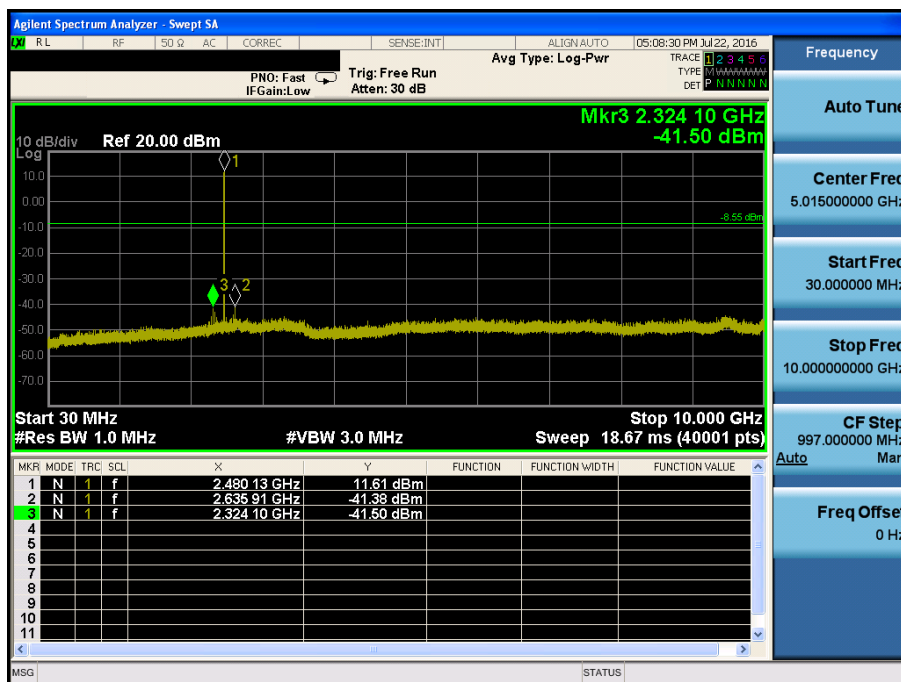
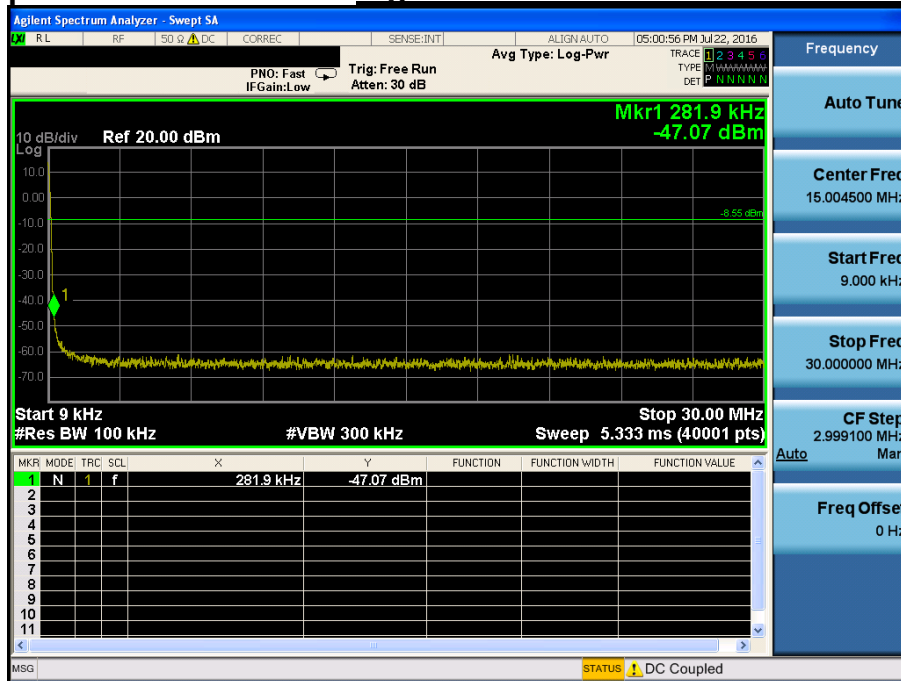

Conducted Spurious Emissions *Highest Channel & Modulation : GFSK*

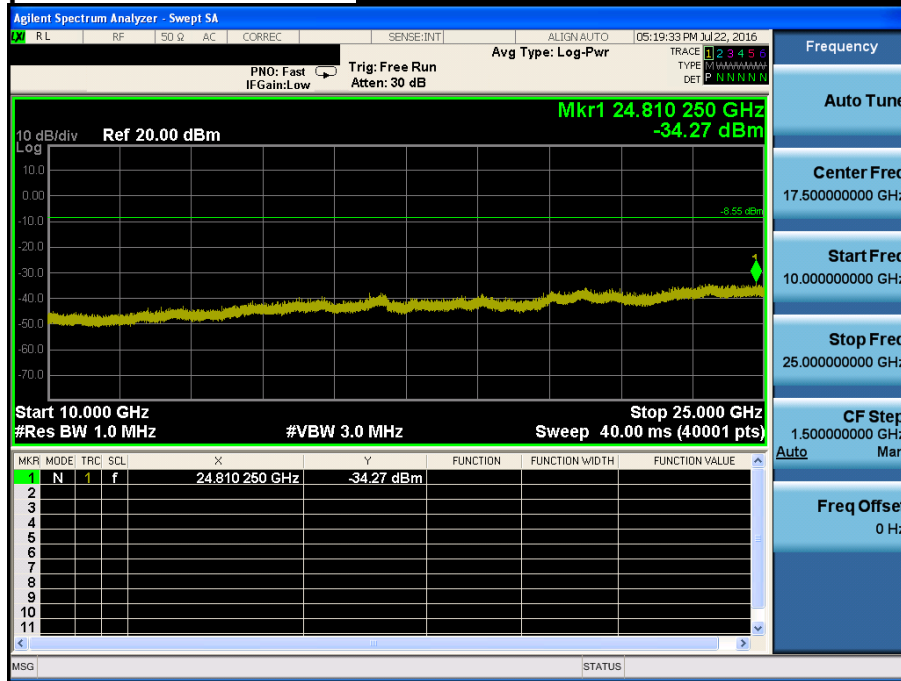

Low Band-edge

Lowest Channel & Modulation : $\pi/4$ DQPSK



Low Band-edge

Hopping mode & Modulation : $\pi/4$ DQPSK

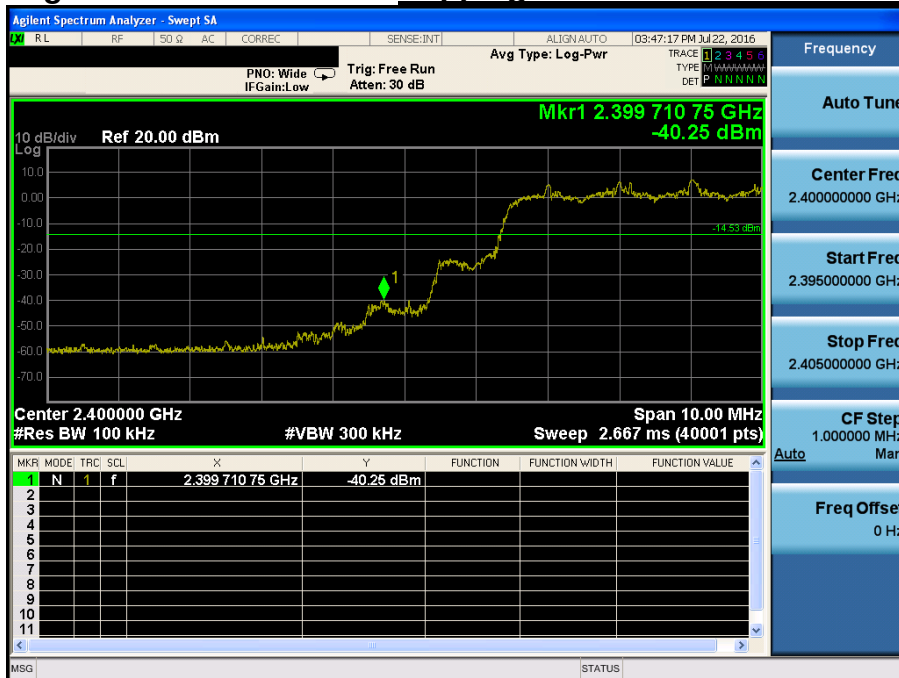

Conducted Spurious Emissions ***Lowest Channel & Modulation : $\pi/4$ DQPSK***

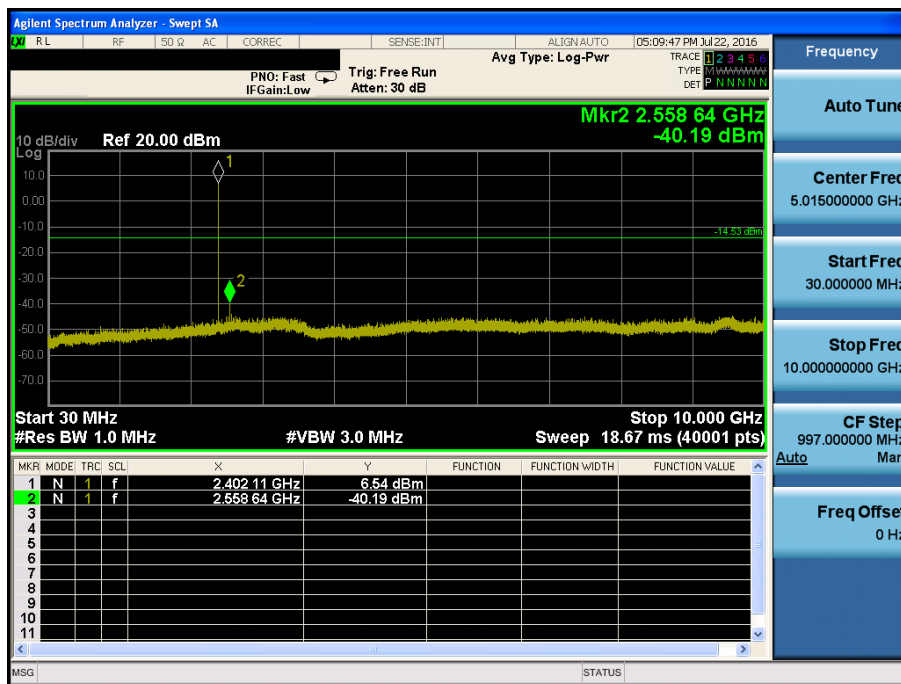
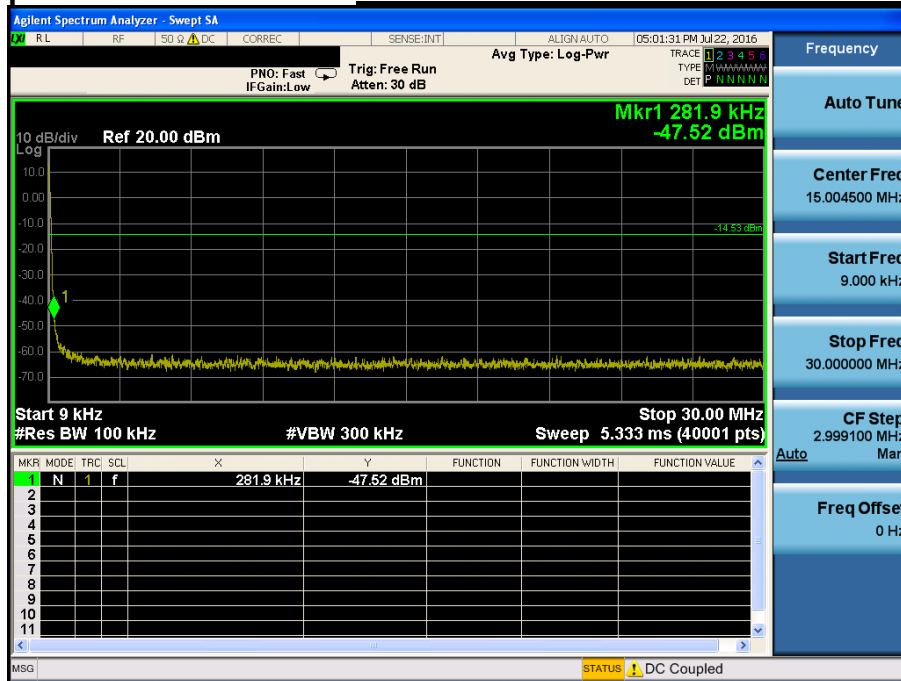

Reference for limit

Middle Channel & Modulation : $\pi/4$ DQPSK

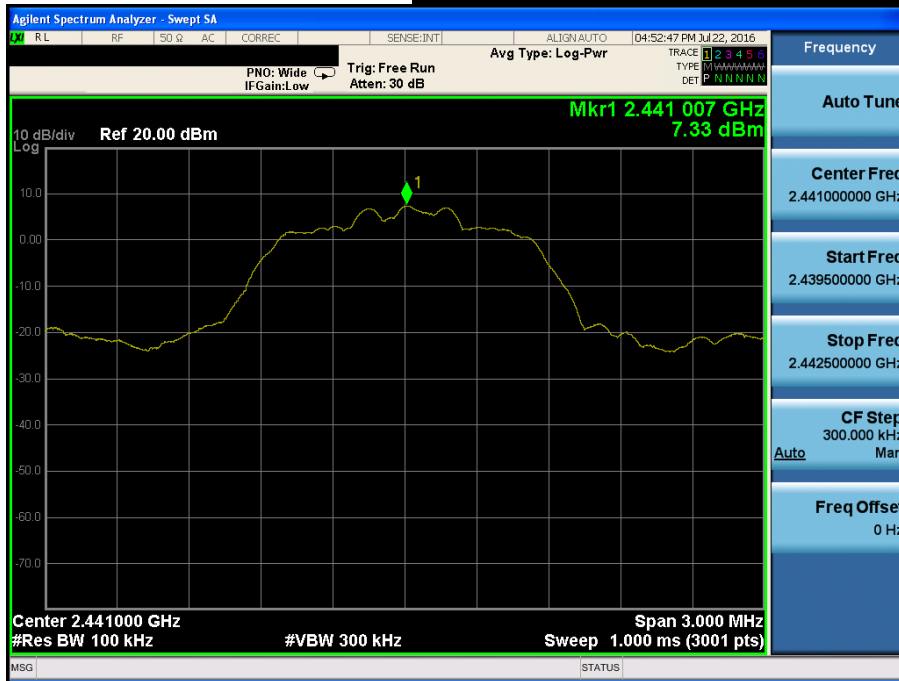

Conducted Spurious Emissions

Middle Channel & Modulation : $\pi/4$ DQPSK

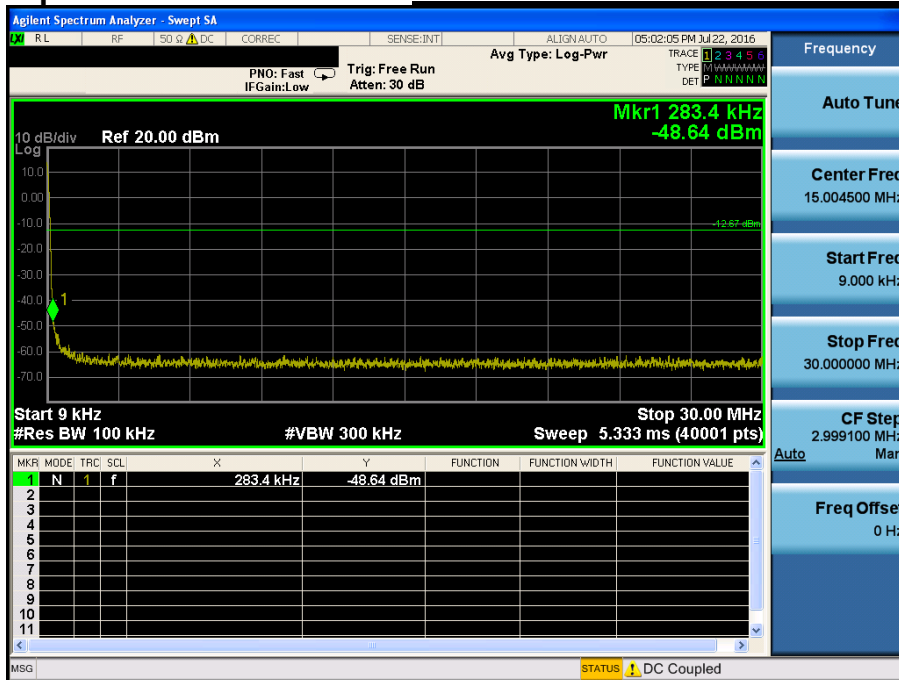

Conducted Spurious Emissions *Middle Channel & Modulation : $\pi/4$ DQPSK*

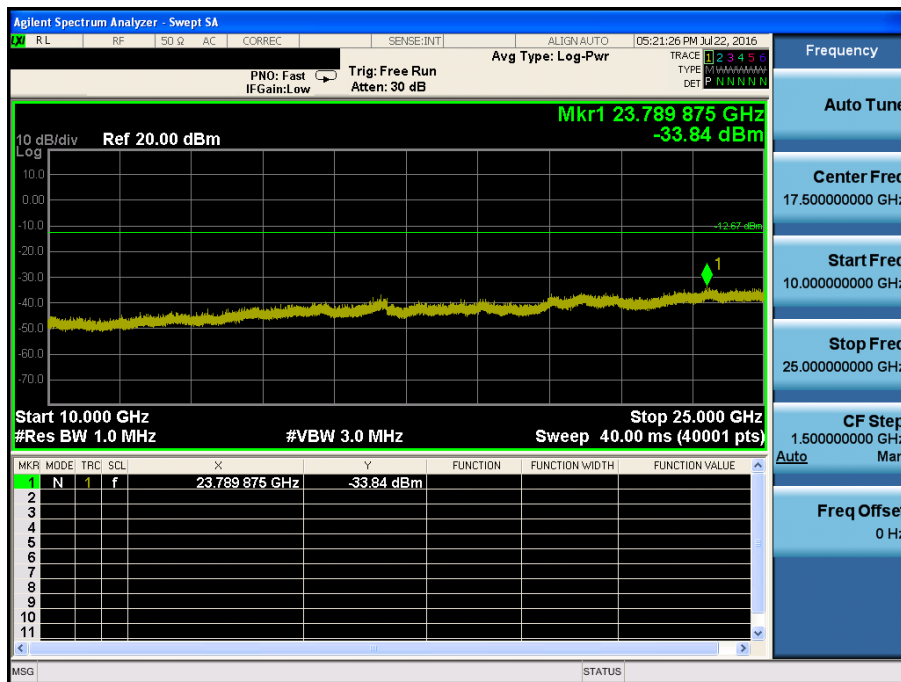
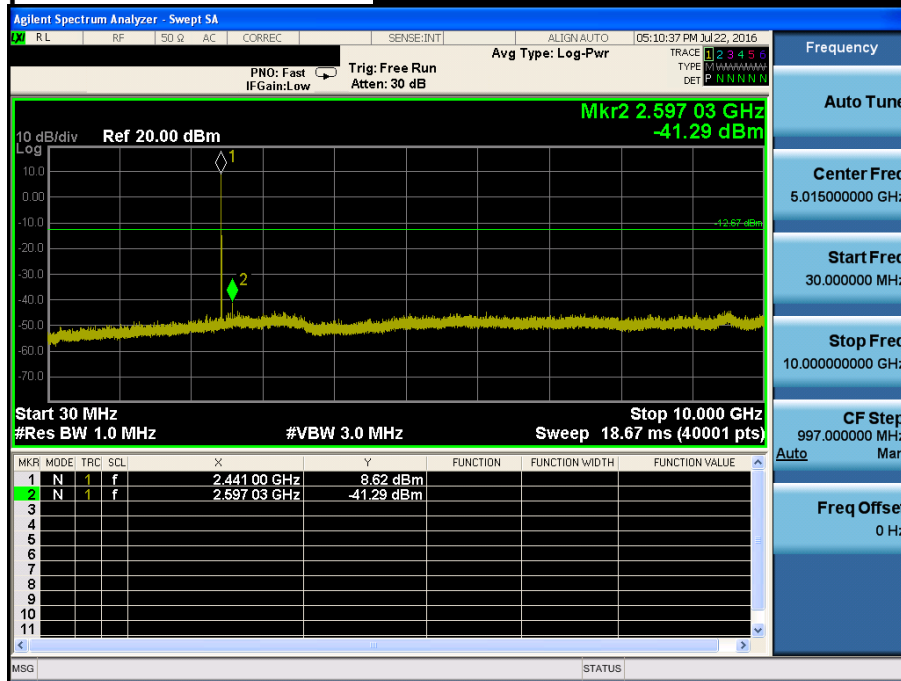

High Band-edge

Highest Channel & Modulation : $\pi/4$ DQPSK



High Band-edge

Hopping mode & Modulation : $\pi/4$ DQPSK



Conducted Spurious Emissions *Highest Channel & Modulation : $\pi/4$ DQPSK*

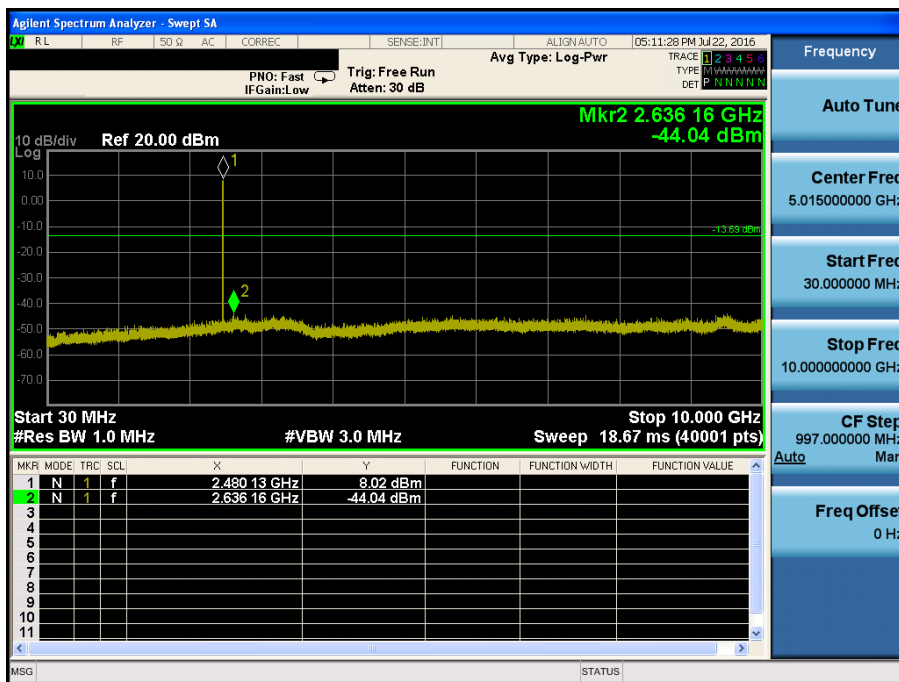
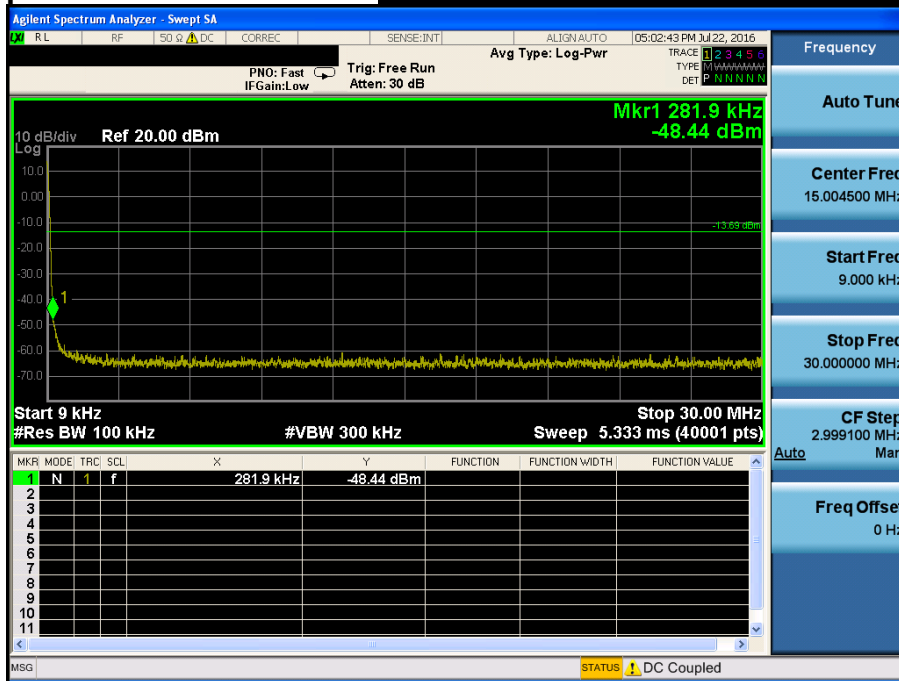

Conducted Spurious Emissions *Highest Channel & Modulation : $\pi/4$ DQPSK*

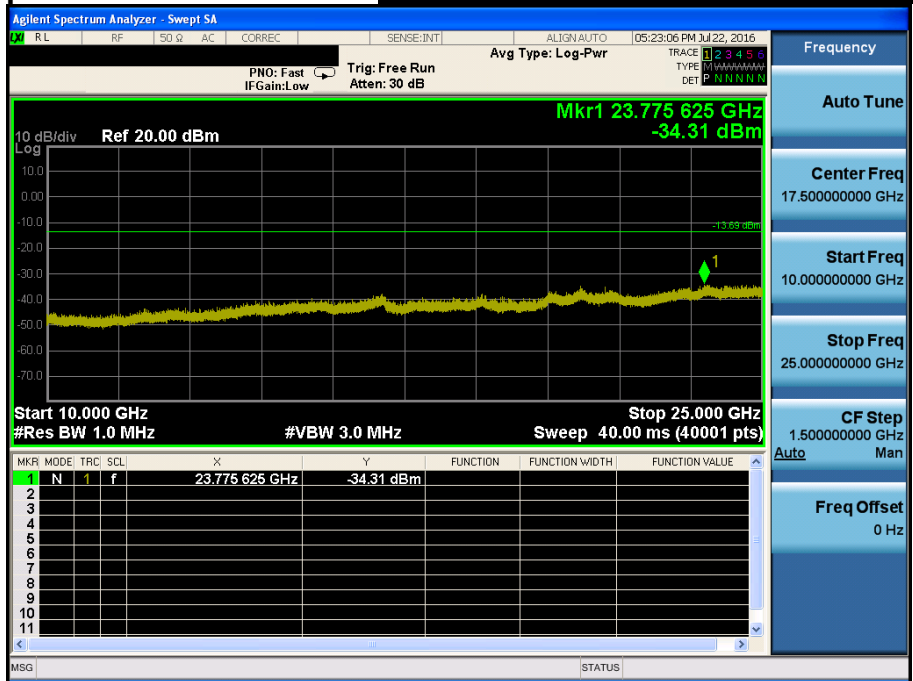

Low Band-edge

Lowest Channel & Modulation : 8DPSK



Low Band-edge

Hopping mode & Modulation : 8DPSK



Conducted Spurious Emissions **Lowest Channel & Modulation : 8DPSK**

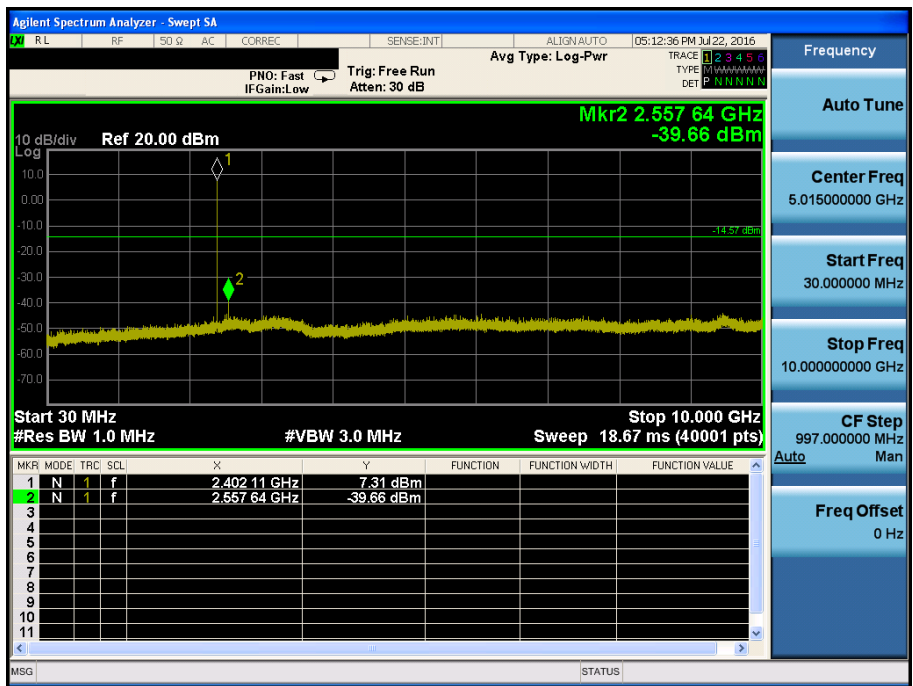
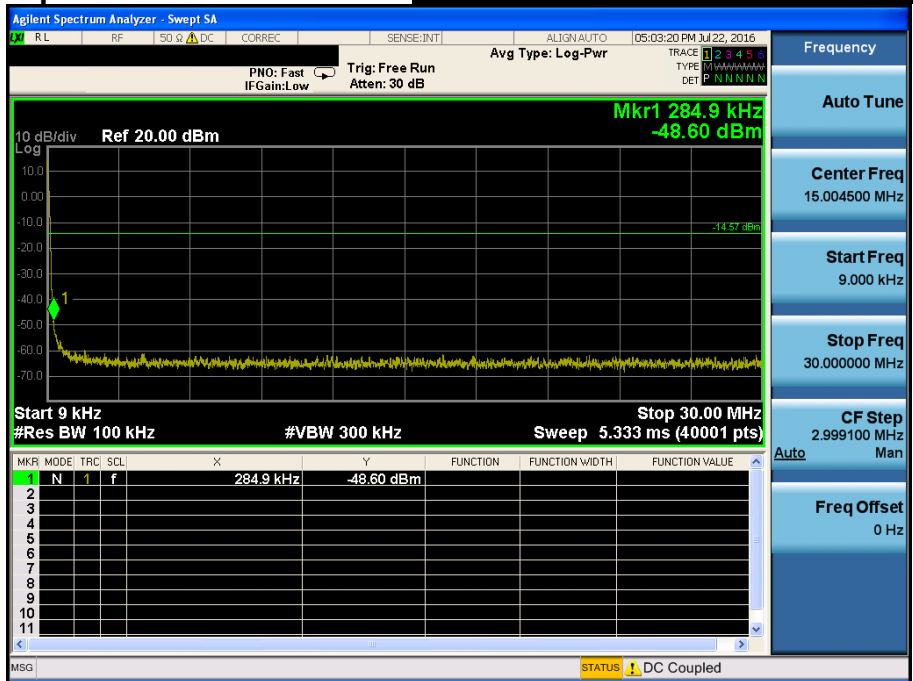

Conducted Spurious Emissions **Lowest Channel & Modulation : 8DPSK**

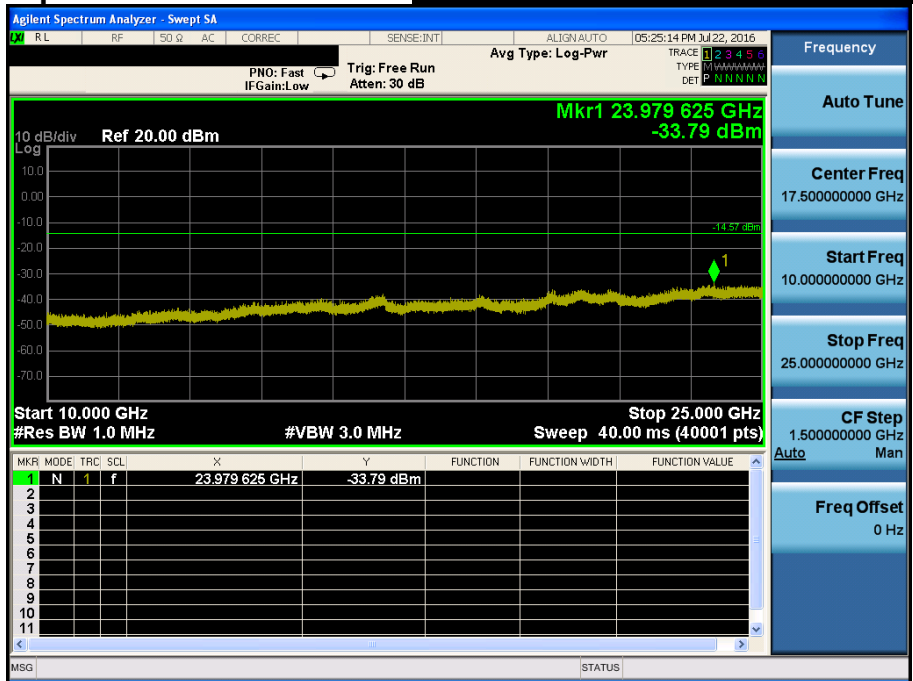

Reference for limit

Middle Channel & Modulation : 8DPSK



Conducted Spurious Emissions

Middle Channel & Modulation : 8DPSK

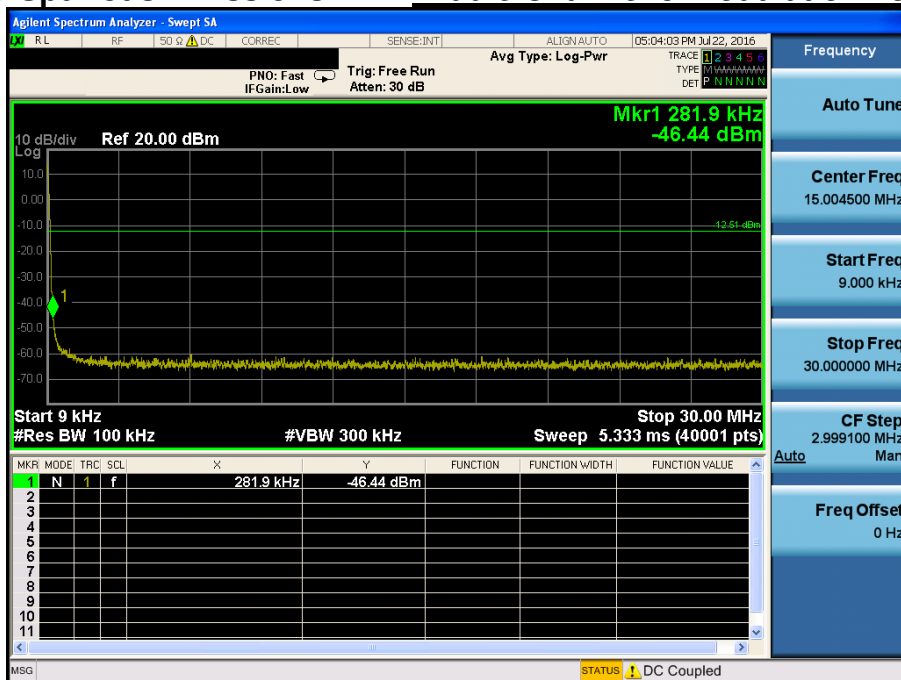

Conducted Spurious Emissions Middle Channel & Modulation : 8DPSK

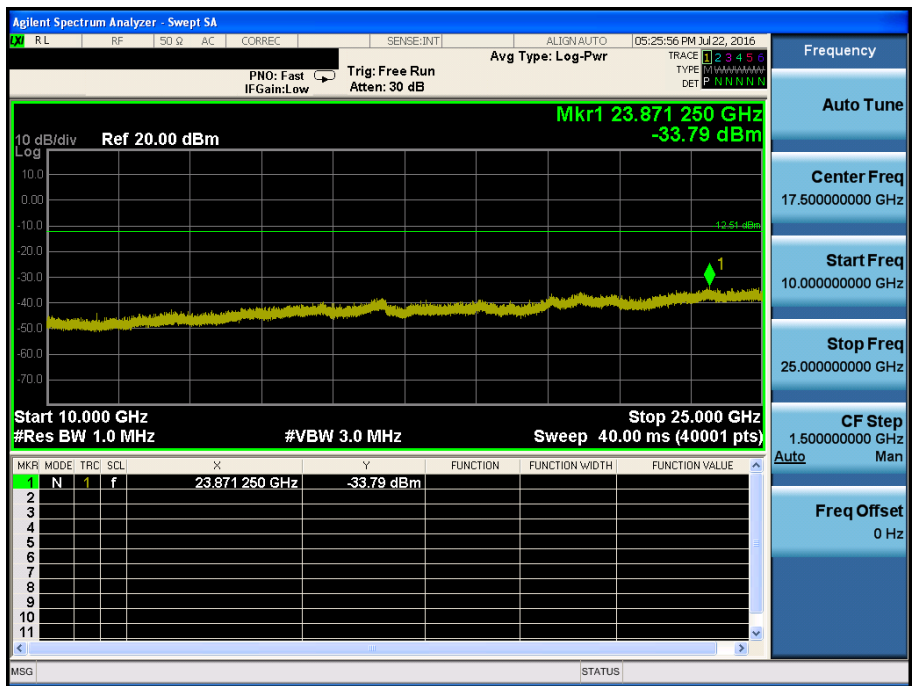
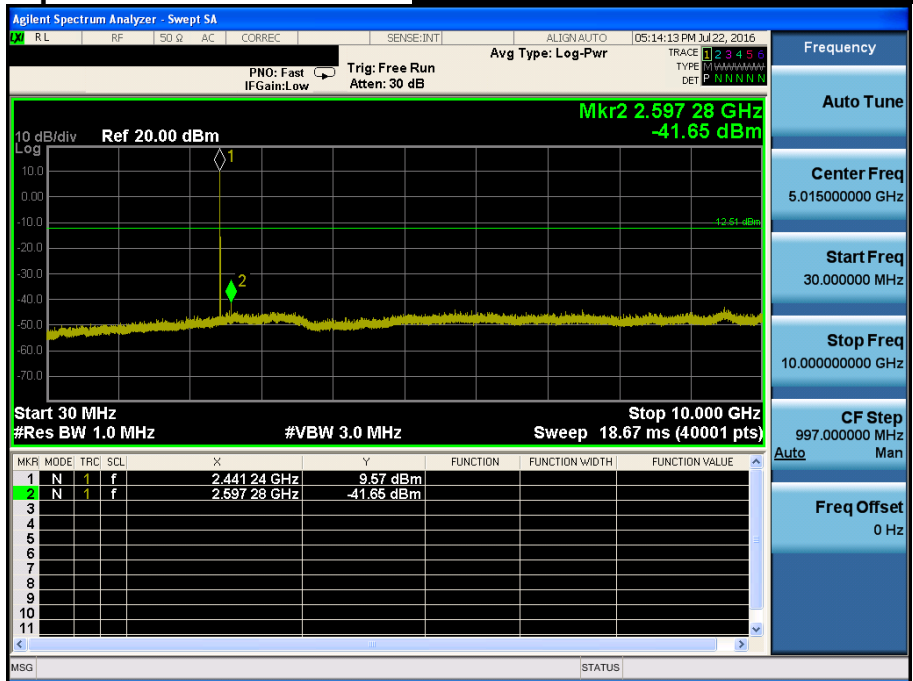

High Band-edge

Highest Channel & Modulation : 8DPSK



High Band-edge

Hopping mode & Modulation : 8DPSK



Conducted Spurious Emissions **Highest Channel & Modulation : 8DPSK**

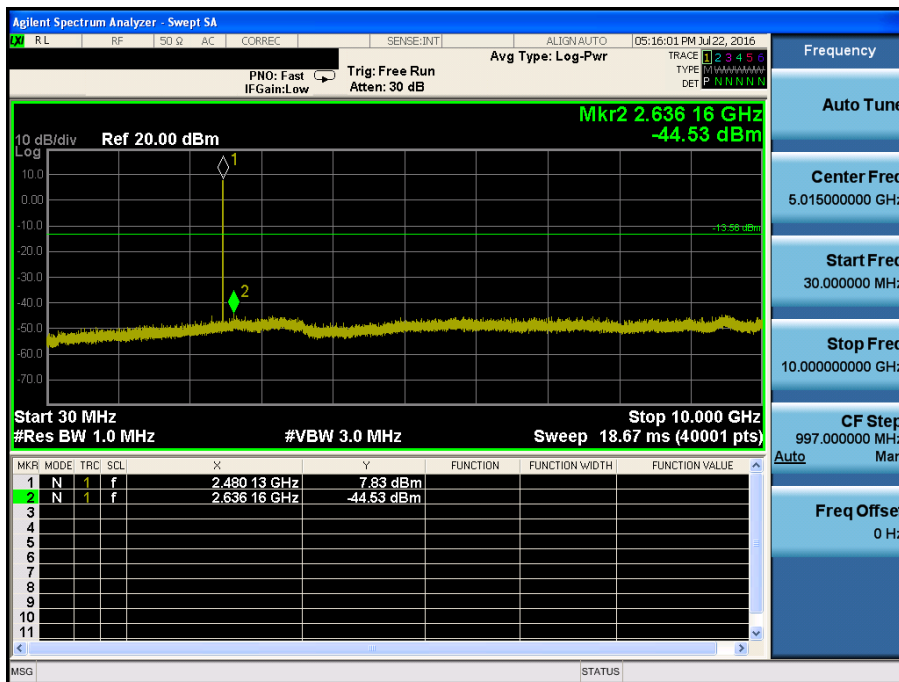
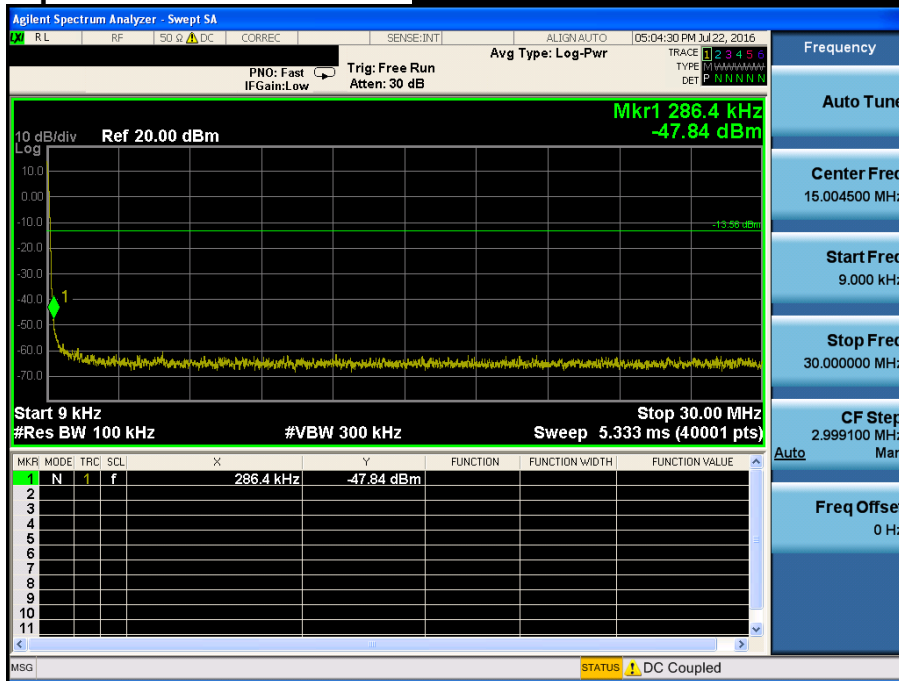

Conducted Spurious Emissions **Highest Channel & Modulation : 8DPSK**

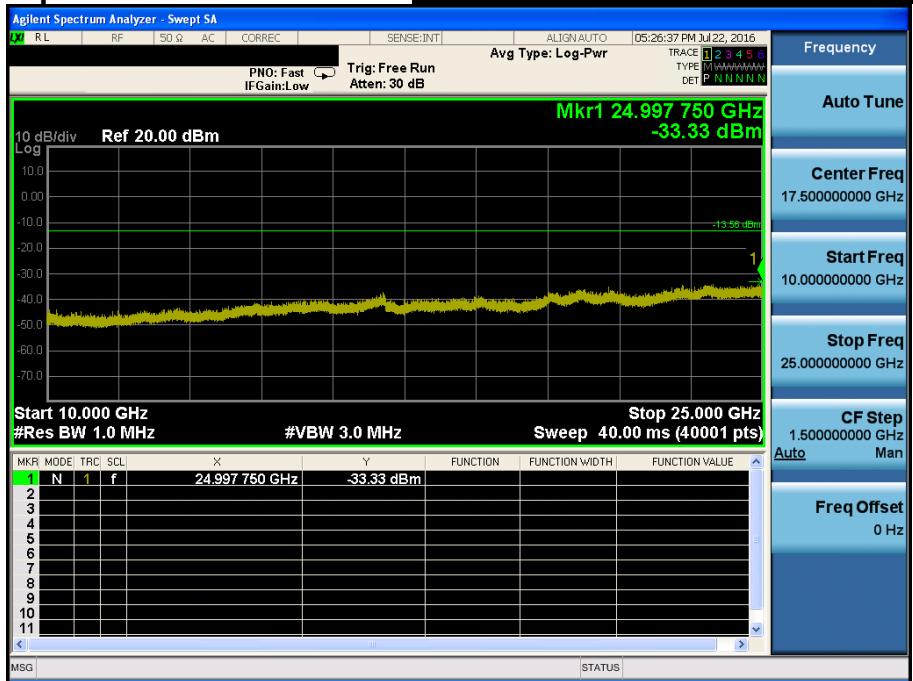

8. Transmitter AC Power Line Conducted Emission

8.1 Test Setup

Refer to test setup photo.

8.2 Limit

According to §15.207(a) for an intentional radiator that is designed to be connected to the public utility (AC) power line, the radio frequency voltage that is conducted back onto the AC power line on any frequency or frequencies, within the band 150 kHz to 30 MHz, shall not exceed the limits in the following table, as measured using a 50 uH/50 ohm line impedance stabilization network (LISN).

Compliance with the provision of this paragraph shall on the measurement of the radio frequency voltage between each power line and ground at the power terminal. The lower applies at the boundary between the frequency ranges.

Frequency Range (MHz)	Conducted Limit (dBuV)	
	Quasi-Peak	Average
0.15 ~ 0.5	66 to 56 *	56 to 46 *
0.5 ~ 5	56	46
5 ~ 30	60	50

* Decreases with the logarithm of the frequency

8.3 Test Procedures

Conducted emissions from the EUT were measured according to the ANSI C63.10.

1. The test procedure is performed in a 6.5 m × 3.5 m × 3.5 m (L × W × H) shielded room. The EUT along with its peripherals were placed on a 1.0 m (W) × 1.5 m (L) and 0.8 m in height wooden table and the EUT was adjusted to maintain a 0.4 meter space from a vertical reference plane.
2. The EUT was connected to power mains through a line impedance stabilization network (LISN) which provides 50 ohm coupling impedance for measuring instrument and the chassis ground was bounded to the horizontal ground plane of shielded room.
3. All peripherals were connected to the second LISN and the chassis ground also bounded to the horizontal ground plane of shielded room.
4. The excess power cable between the EUT and the LISN was bundled. The power cables of peripherals were unbundled. All connecting cables of EUT and peripherals were moved to find the maximum emission.

8.4. Test Results

AC Line Conducted Emissions (Graph) = Modulation : GFSK

Results of Conducted Emission

DT&C		Date : 2016-07-27
Order No.	:	Reference No.
Model No.	: Freewire	Power Supply
Serial No.	:	: 120 V 60 Hz
Test Condition	:	Temp/Humi.
		: 22 'C 43 % R.H.
		Operator
		: I.H.BAE
Memo	: BT 1Mbps	
LIMIT : FCC P15.207 QP		
FCC P15.207 AV		

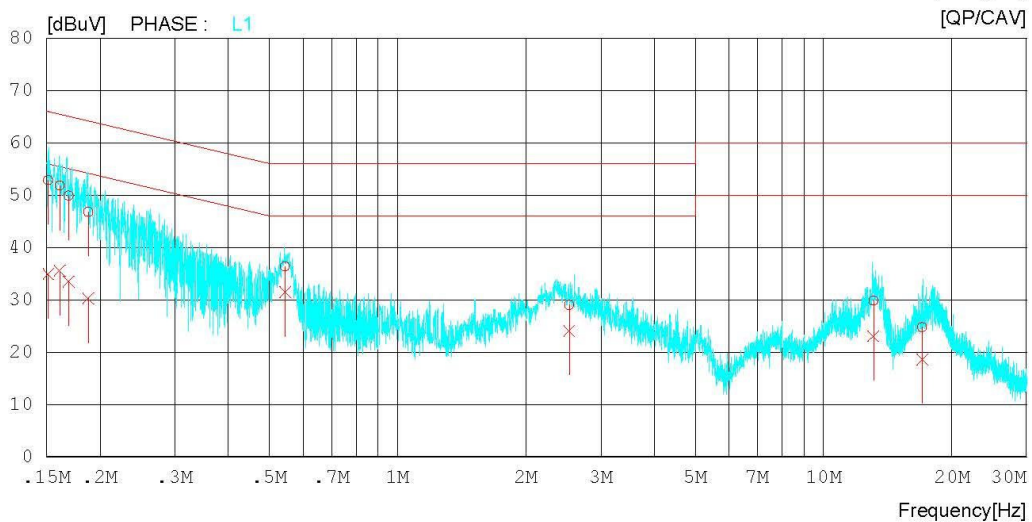
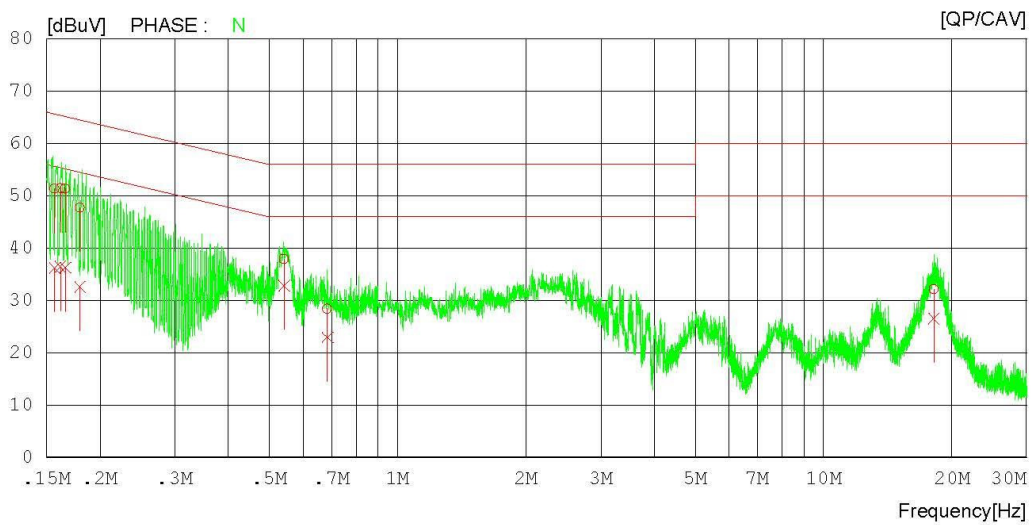



AC Line Conducted Emissions (List) = Modulation : GFSK

Results of Conducted Emission

DT&C

Date : 2016-07-27

Order No.	:		Reference No.	:	
Model No.	:	Freewire	Power Supply	:	120 V 60 Hz
Serial No.	:		Temp/Humi.	:	22 'C 43 % R.H.
Test Condition	:		Operator	:	I.H.BAE

Memo : BT 1Mbps

LIMIT : FCC P15.207 QP
 FCC P15.207 AV

NO	FREQ [MHz]	READING		C.FACTOR [dB]	RESULT		LIMIT		MARGIN		PHASE
		QP [dBuV]	CAV [dBuV]		QP [dBuV]	CAV [dBuV]	QP [dBuV]	CAV [dBuV]	QP [dBuV]	CAV [dBuV]	
1	0.15663	48.15	33.02	3.15	51.30	36.17	65.64	55.64	14.34	19.47	N
2	0.16154	48.45	33.44	2.98	51.43	36.42	65.38	55.38	13.95	18.96	N
3	0.16588	48.51	33.43	2.83	51.34	36.26	65.16	55.16	13.82	18.90	N
4	0.17956	45.21	30.12	2.49	47.70	32.61	64.51	54.51	16.81	21.90	N
5	0.54150	37.19	32.14	0.68	37.87	32.82	56.00	46.00	18.13	13.18	N
6	0.68407	27.85	22.36	0.56	28.41	22.92	56.00	46.00	27.59	23.08	N
7	18.14600	31.63	26.02	0.51	32.14	26.53	60.00	50.00	27.86	23.47	N
8	0.15126	49.46	31.52	3.37	52.83	34.89	65.93	55.93	13.10	21.04	L1
9	0.16104	48.71	32.43	3.03	51.74	35.46	65.41	55.41	13.67	19.95	L1
10	0.16904	47.15	30.69	2.76	49.91	33.45	65.01	55.01	15.10	21.56	L1
11	0.18769	44.37	27.83	2.36	46.73	30.19	64.14	54.14	17.41	23.95	L1
12	0.54423	35.59	30.69	0.70	36.29	31.39	56.00	46.00	19.71	14.61	L1
13	2.52800	28.53	23.58	0.41	28.94	23.99	56.00	46.00	27.06	22.01	L1
14	13.08720	29.32	22.51	0.48	29.80	22.99	60.00	50.00	30.20	27.01	L1
15	17.05920	24.19	18.07	0.53	24.72	18.60	60.00	50.00	35.28	31.40	L1

9. Antenna Requirement

Describe how the EUT complies with the requirement that either its antenna is permanently attached, or that it employs a unique antenna connector, for every antenna proposed for use with the EUT.

Conclusion: Comply

The antenna is permanently attached on PCB. (Refer to Internal photo file.)

- Minimum Standard :

An intentional radiator shall be designed to ensure that no antenna other than that furnished by the responsible party shall be used with the device. The use of a permanently attached antenna or of an antenna that uses a unique coupling to the intentional radiator shall be considered sufficient to comply with the provisions.

10. Occupied Bandwidth (99 %)

10.1 Test Setup

Refer to the APPENDIX I.

10.2 Limit

Limit : Not Applicable

10.3 Test Procedure

The 99 % power bandwidth was measured with a calibrated spectrum analyzer.

The resolution bandwidth (RBW) shall be in the range of 1 % to 5 % of the occupied bandwidth (OBW) and video bandwidth (VBW) shall be approximately $3 \times$ RBW.

Spectrum analyzer plots are included on the following pages.

10.4 Test Results

Test Mode	Tested Channel	Test Results (MHz)
<u>GFSK</u>	Lowest	0.877
	Middle	0.875
	Highest	0.872
<u>$\pi/4$DQPSK</u>	Lowest	1.198
	Middle	1.205
	Highest	1.213
<u>8DPSK</u>	Lowest	1.183
	Middle	1.184
	Highest	1.177

Occupied Bandwidth (99 %)

Lowest Frequency & GFSK

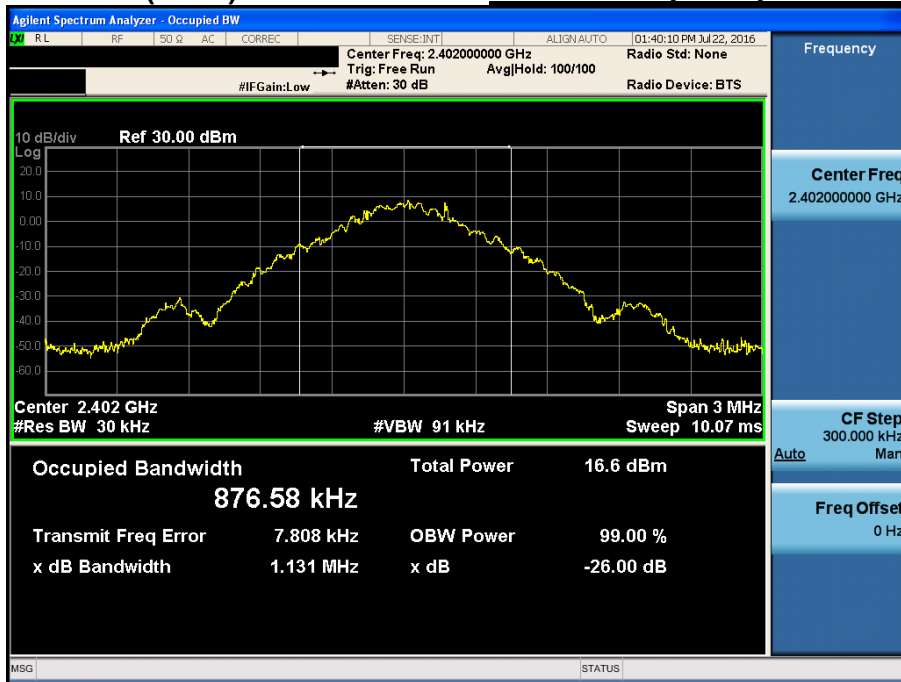

Occupied Bandwidth (99 %)

Middle Frequency & GFSK



Occupied Bandwidth (99 %)

Highest Frequency & GFSK

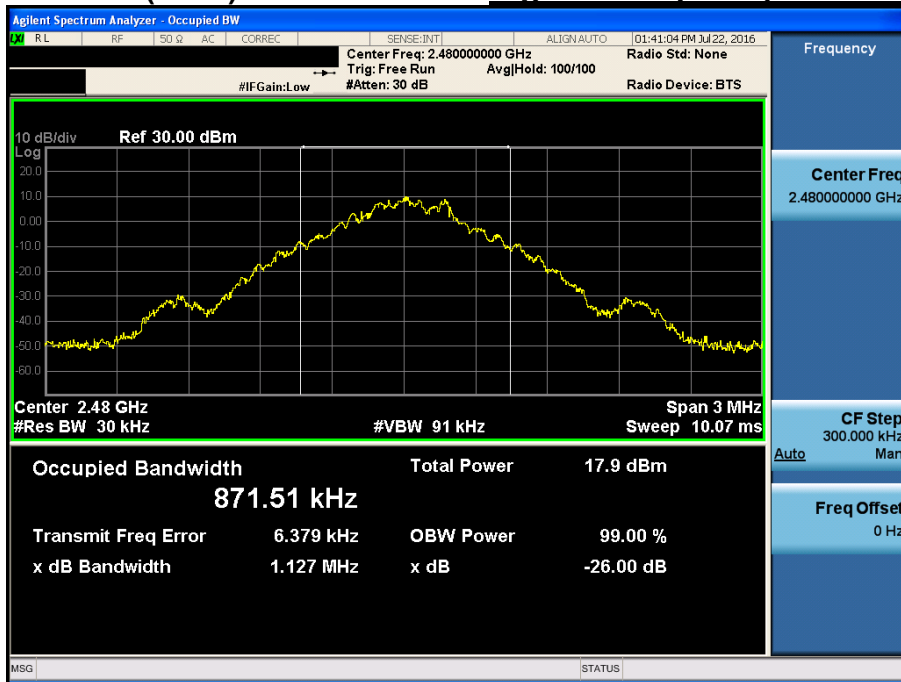

Occupied Bandwidth (99 %)

Lowest Frequency & $\pi/4$ DQPSK

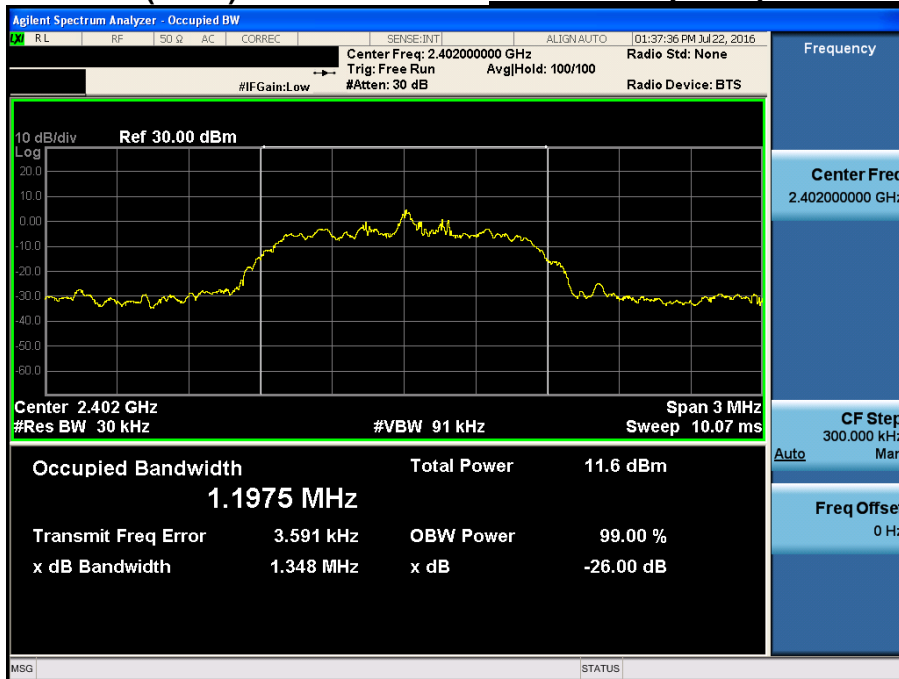

Occupied Bandwidth (99 %)

Middle Frequency & $\pi/4$ DQPSK

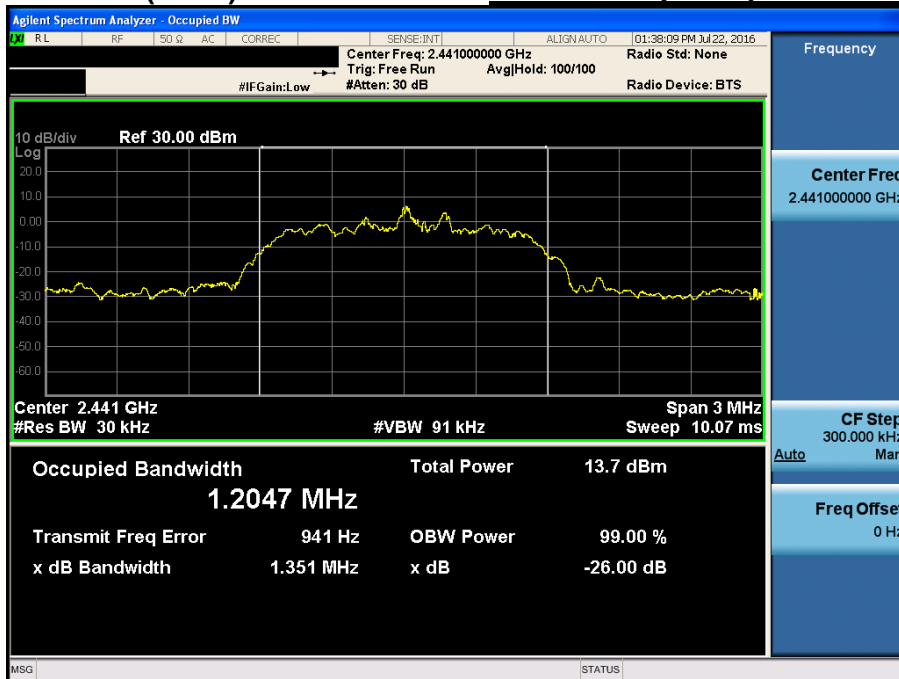

Occupied Bandwidth (99 %)

Highest Frequency & $\pi/4$ DQPSK



Occupied Bandwidth (99 %)

Lowest Frequency & 8DPSK

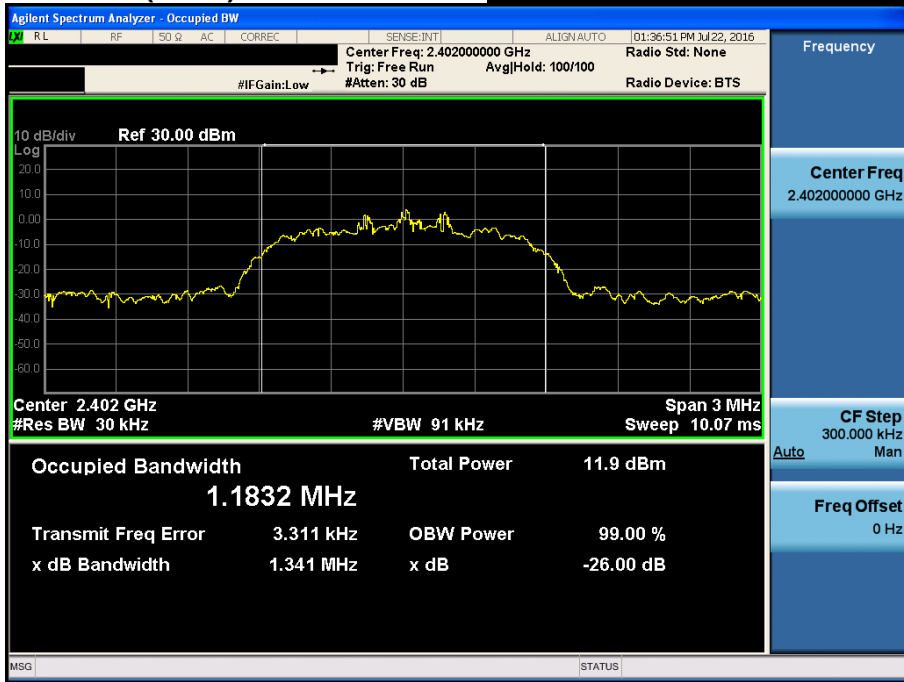

Occupied Bandwidth (99 %)

Middle Frequency & 8DPSK

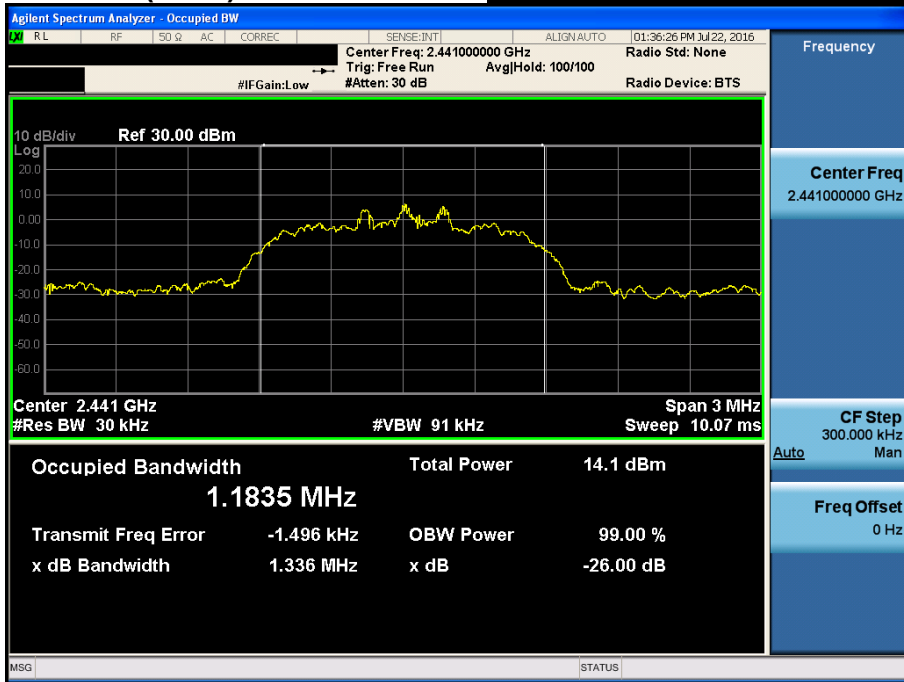

Occupied Bandwidth (99 %)

Highest Frequency & 8DPSK

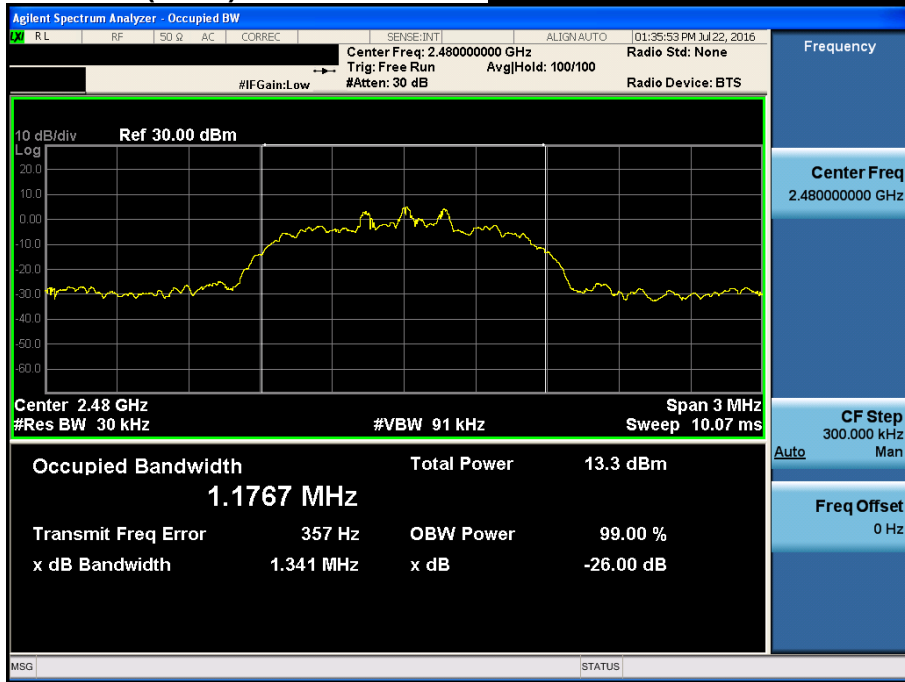

APPENDIX I

Test set up diagrams

▪ Radiated Measurement

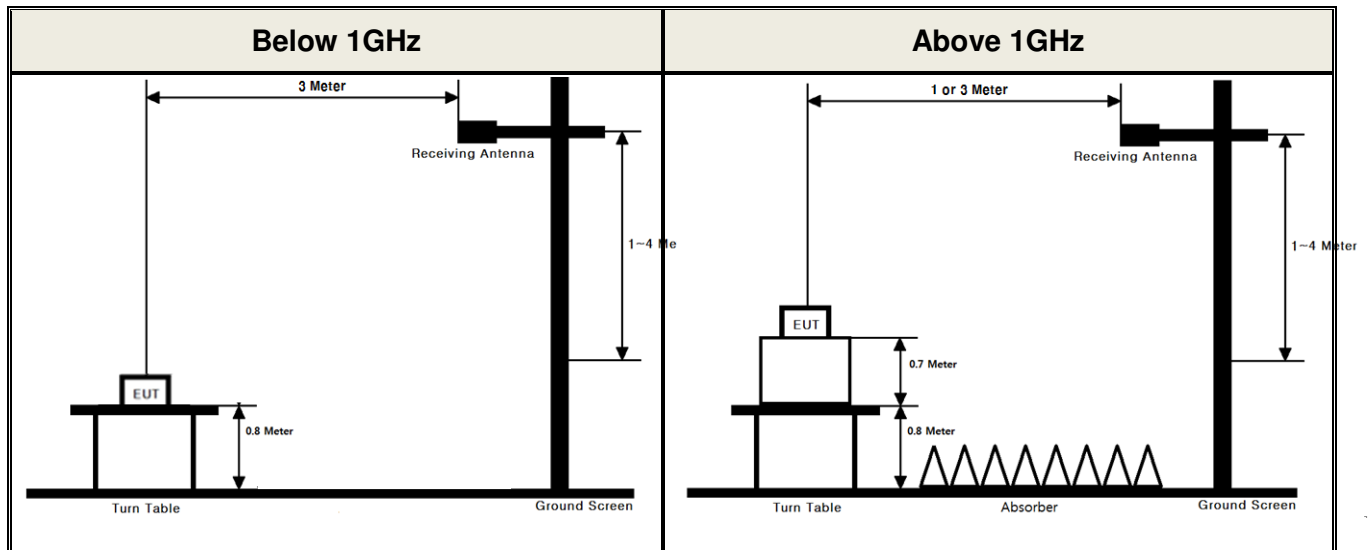

▪ Conducted Measurement

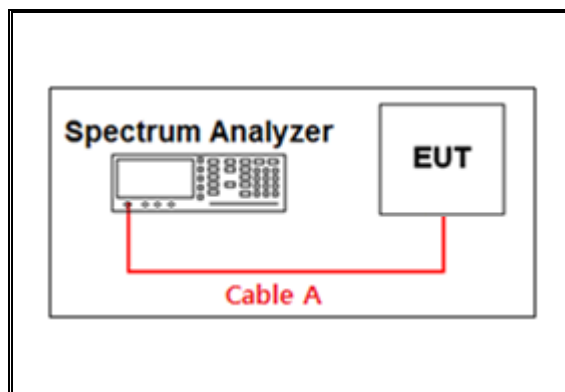

Path loss information

Frequency (GHz)	Path Loss (dB)	Frequency (GHz)	Path Loss (dB)
0.03	0.22	15	4.85
1	1.15	20	5.18
2402 & 2441 & 2480	1.93	25	6.54
5	2.59	-	-
10	3.93	-	-

Note 1 : The path loss from EUT to Spectrum analyzer were measured and used for test.

Path loss (S/A's Correction factor) = Cable A + Power splitter

APPENDIX II

Unwanted Emissions (Radiated) Test Plot

GFSK & Lowest & X & Hor

Detector Mode : PK

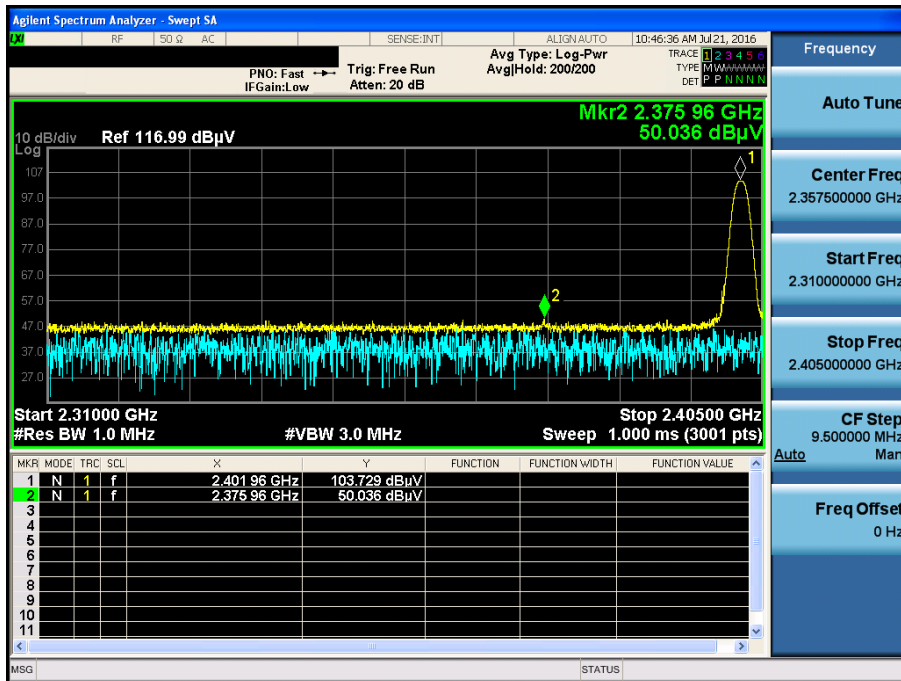

GFSK & Lowest & X & Hor

Detector Mode : AV

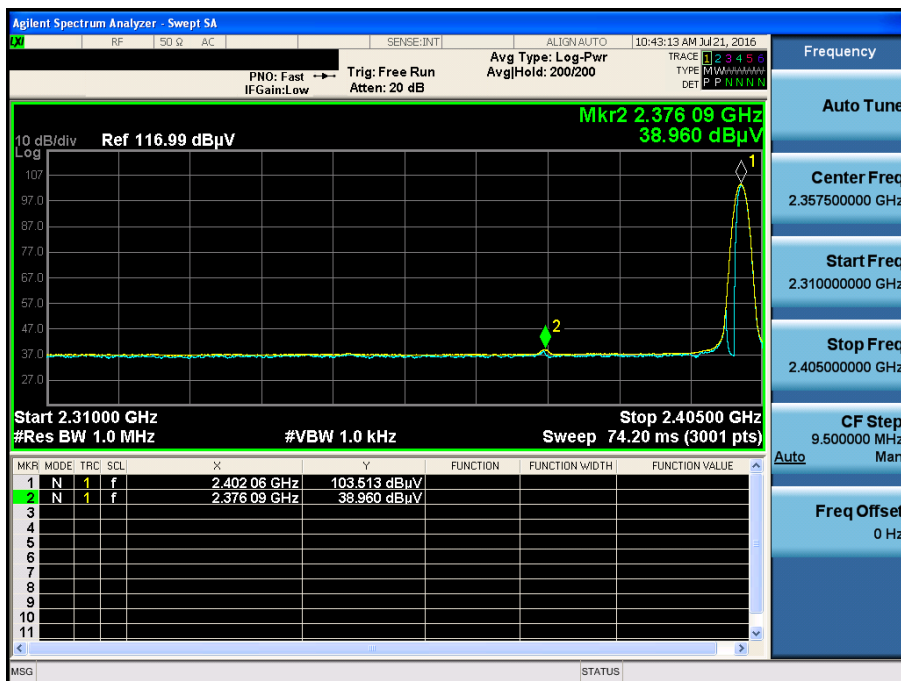

GFSK & Highest & X & Hor

Detector Mode : PK

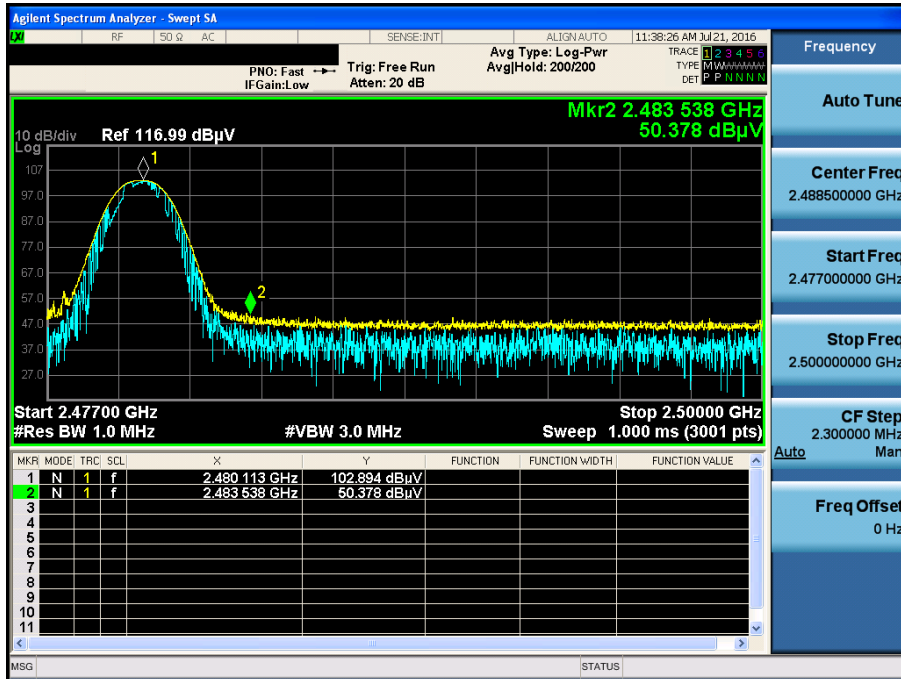

GFSK & Highest & X & Hor

Detector Mode : AV

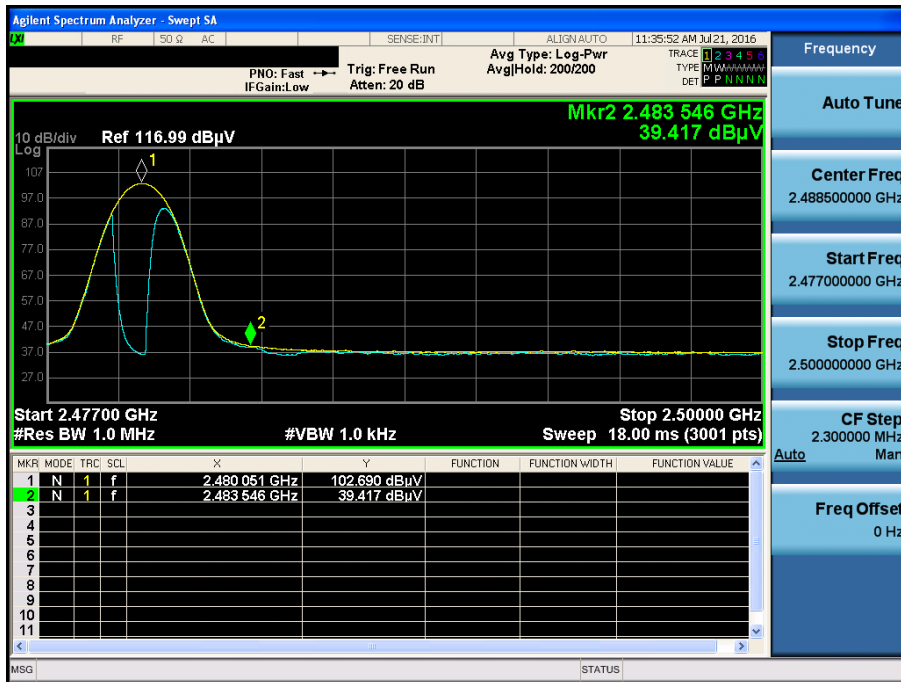

π /4DQPSK & Lowest & X & Hor

Detector Mode : PK

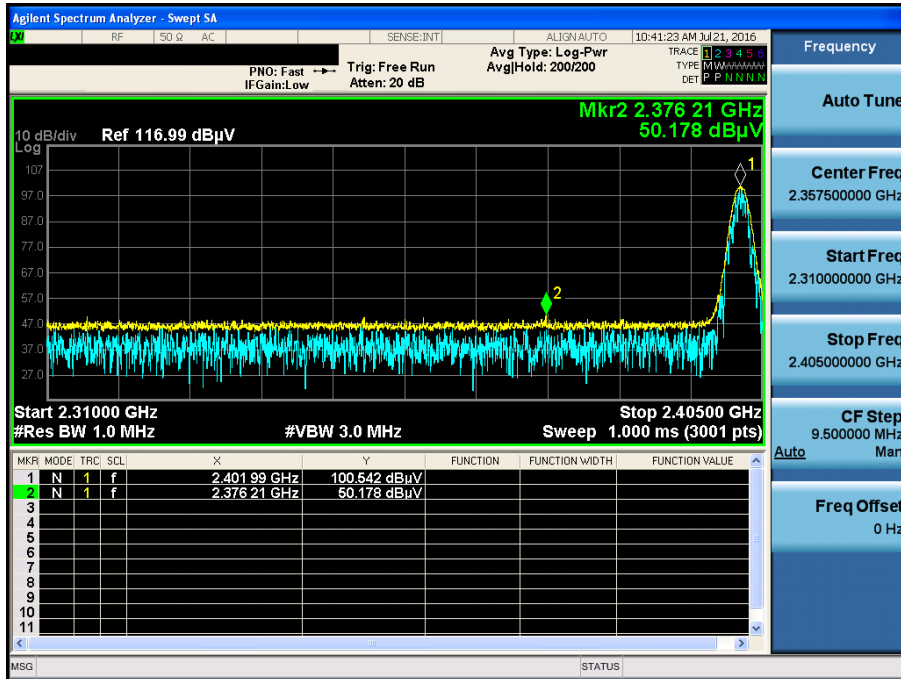

π /4DQPSK & Lowest & X & Hor

Detector Mode : AV

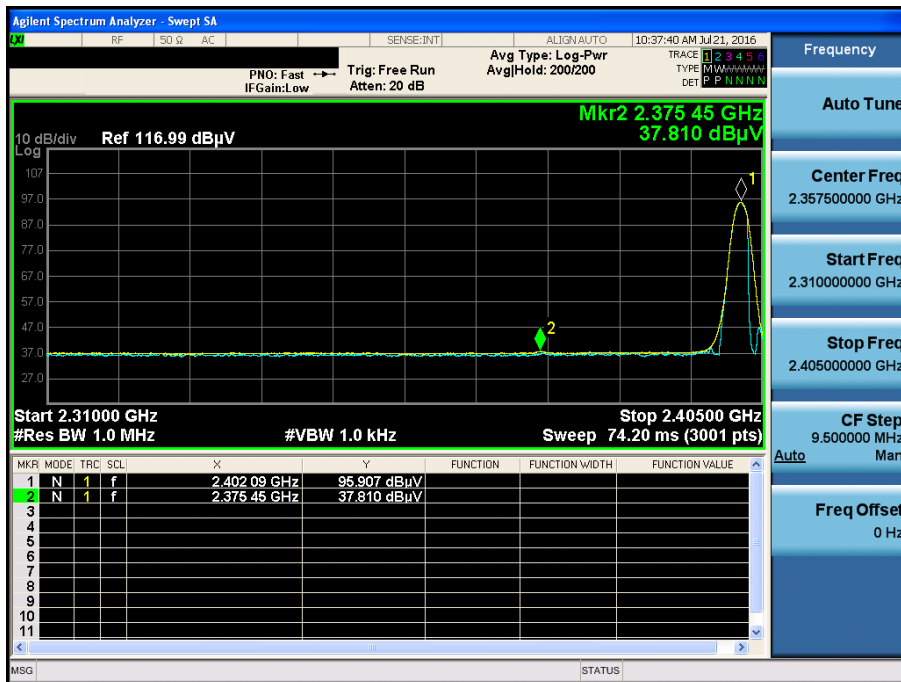

π /4DQPSK & Highest & X & Hor

Detector Mode : PK

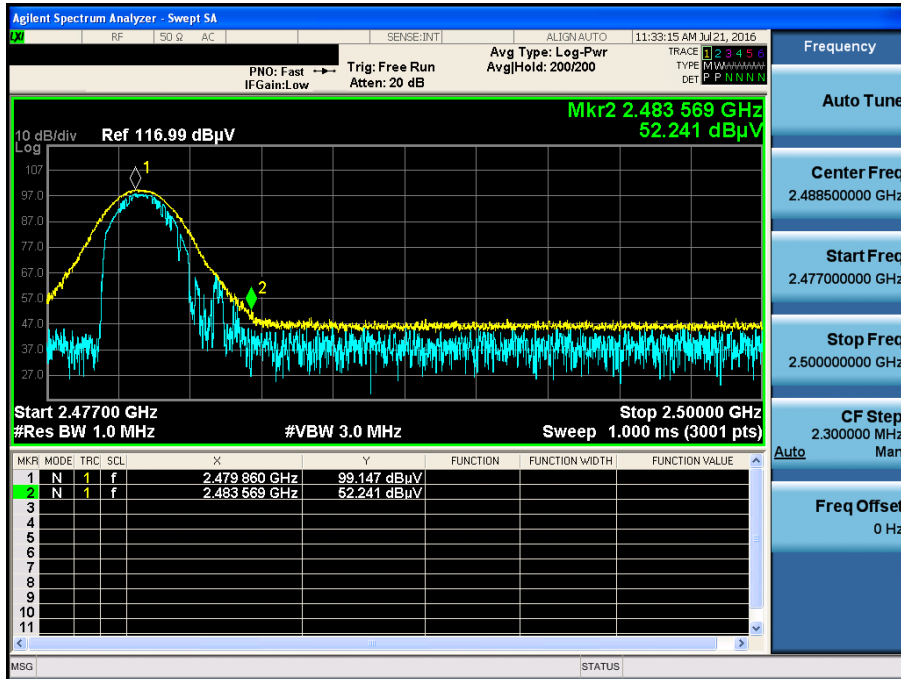

π /4DQPSK & Highest & X & Hor

Detector Mode : AV



8DPSK & Lowest & X & Hor

Detector Mode : PK

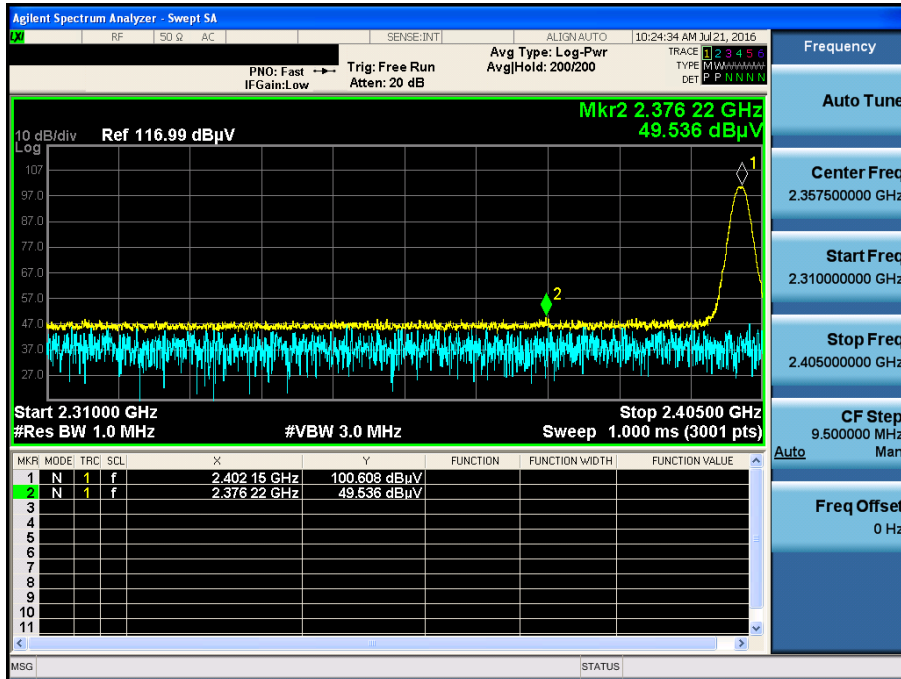

8DPSK & Lowest & X & Hor

Detector Mode : AV

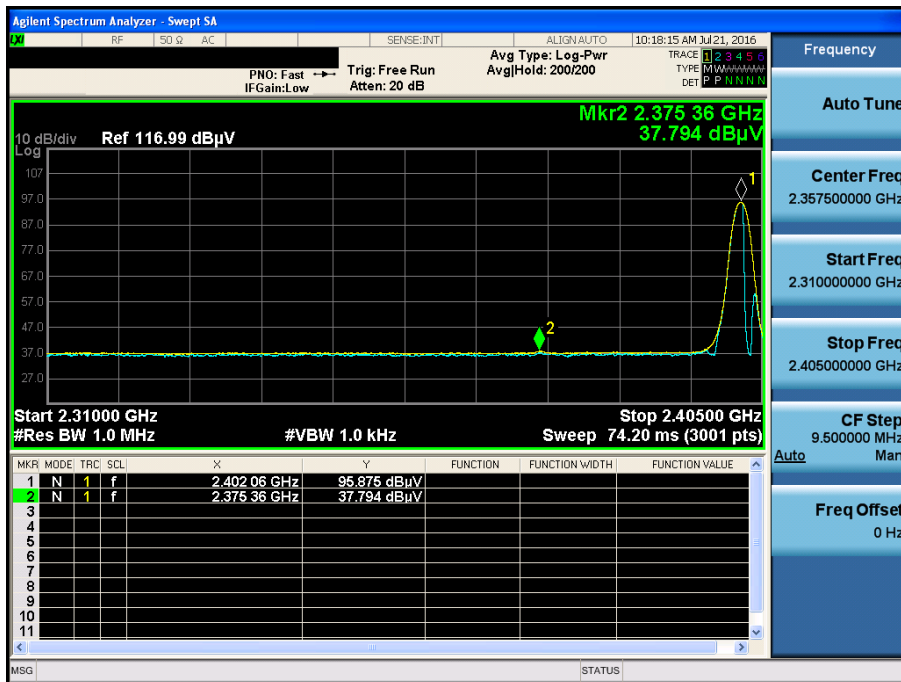

8DPSK & Highest & X & Hor

Detector Mode : PK

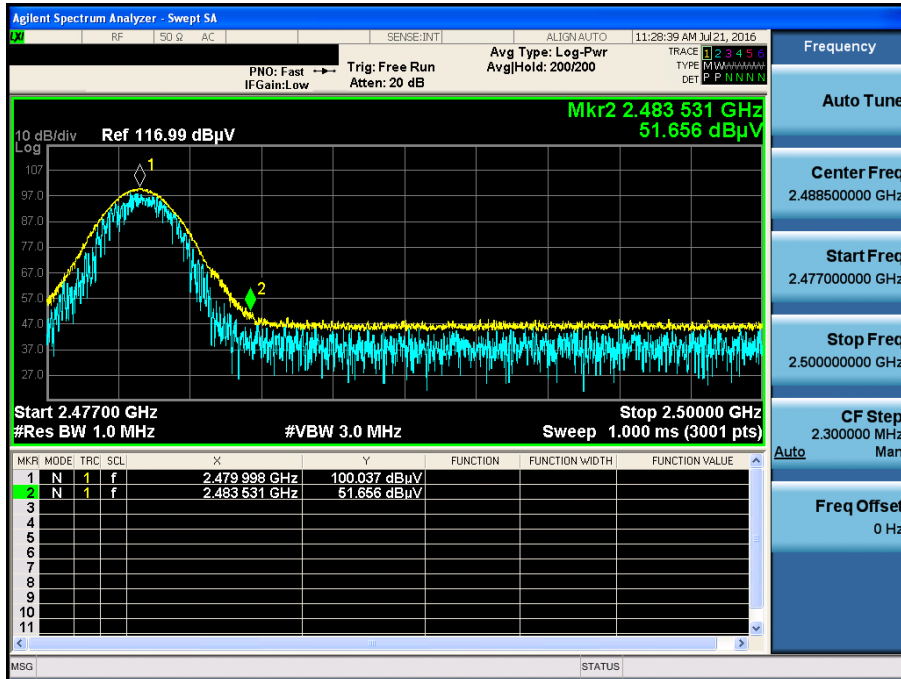

8DPSK & Highest & X & Hor

Detector Mode : AV

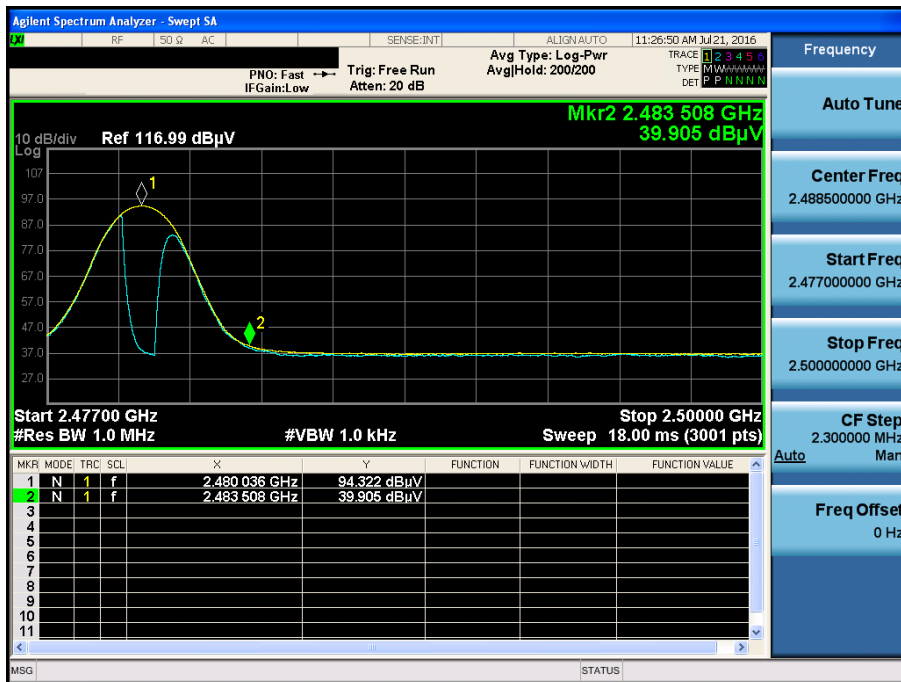

$\pi/4$ DQPSK & Middle & X & Ver

Detector Mode : PK

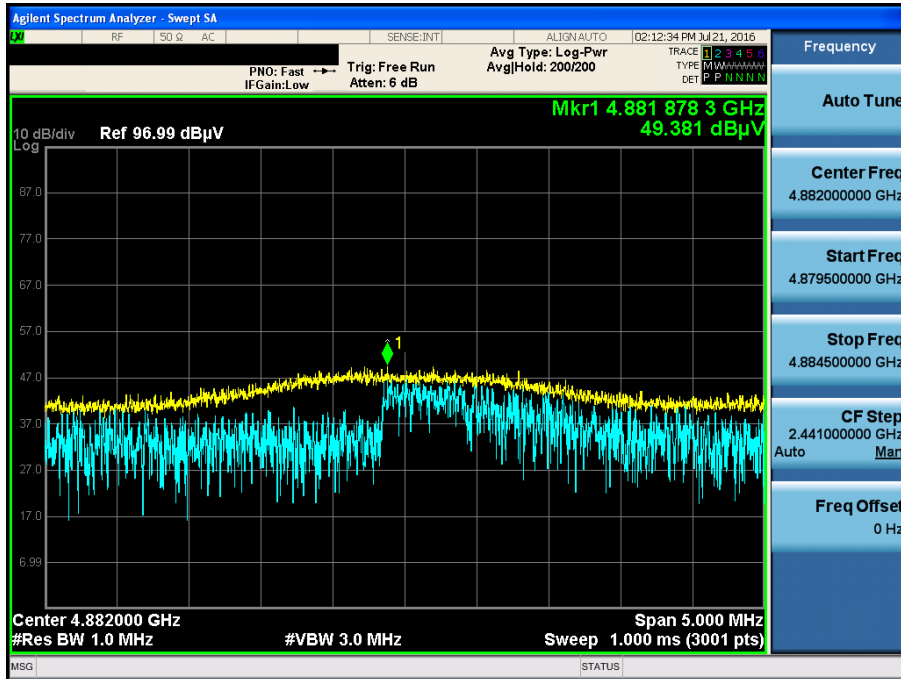

8DPSK & Middle & X & Ver

Detector Mode : PK

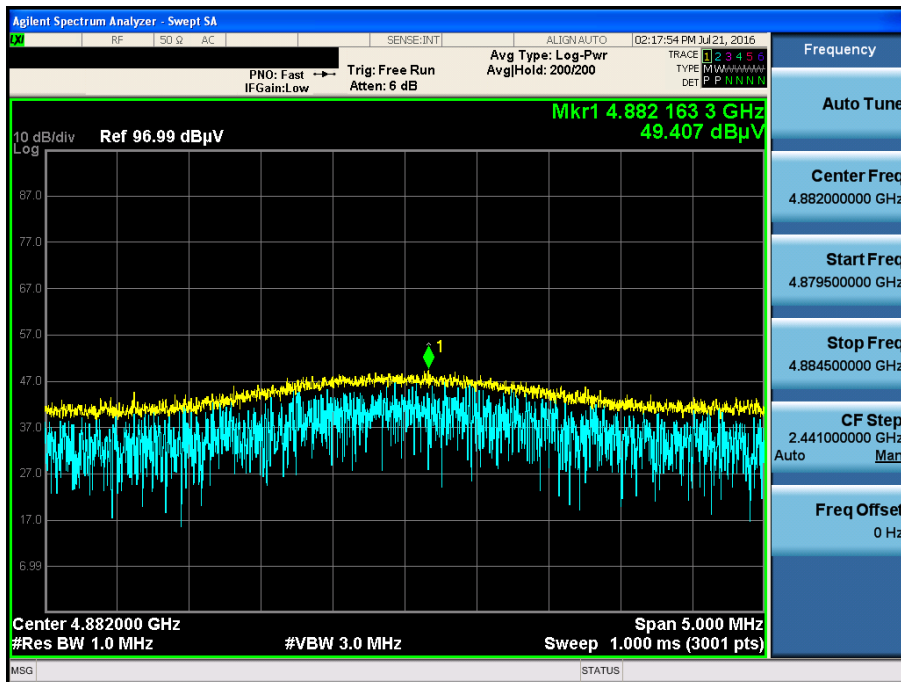

GFSK & Hopping mode & X & Hor

Detector Mode : PK

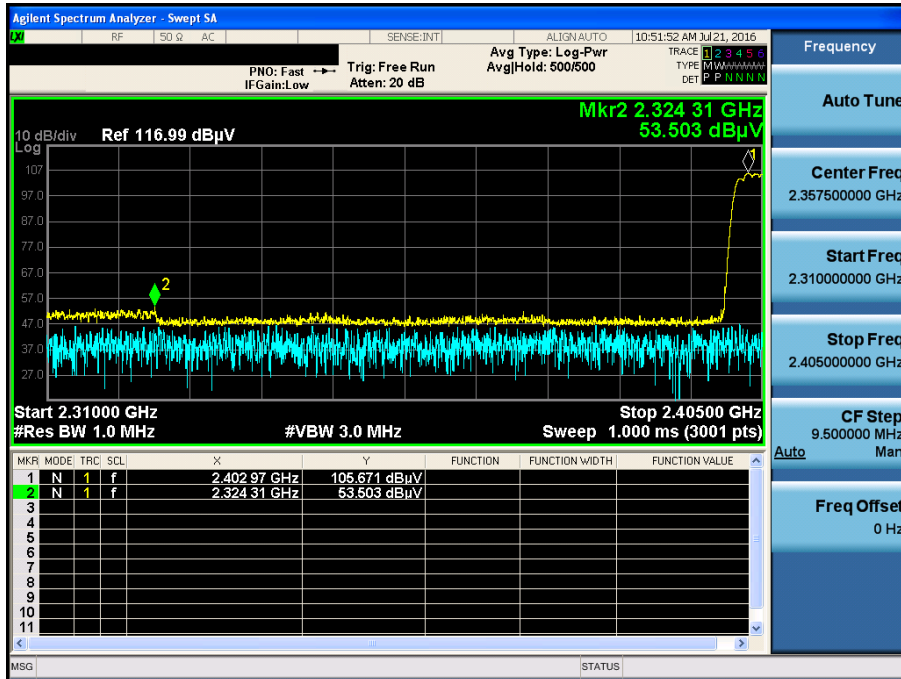

GFSK & Hopping mode & X & Hor

Detector Mode : AV

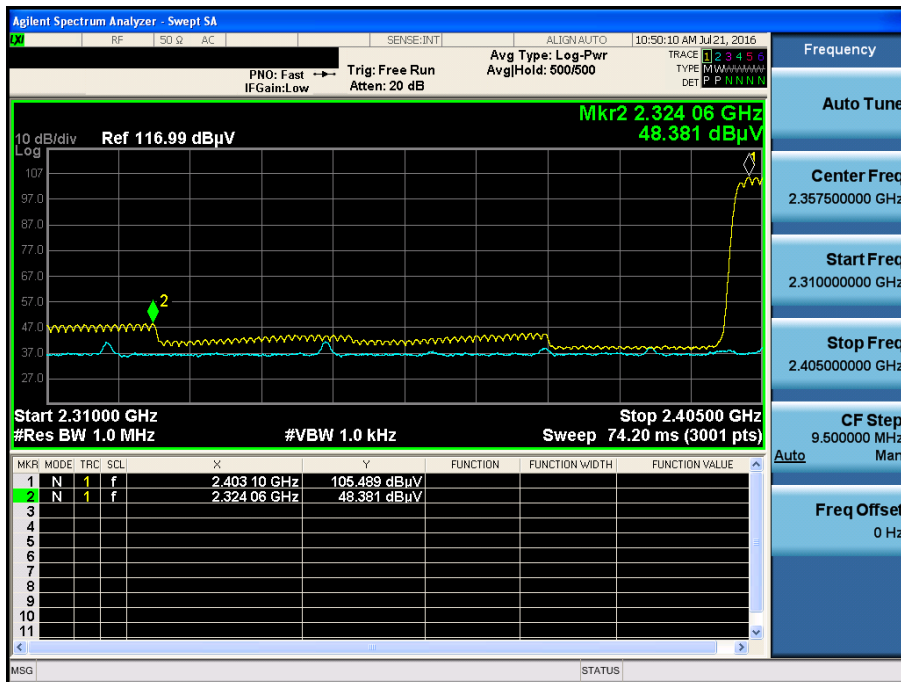

GFSK & Hopping mode & X & Hor

Detector Mode : PK

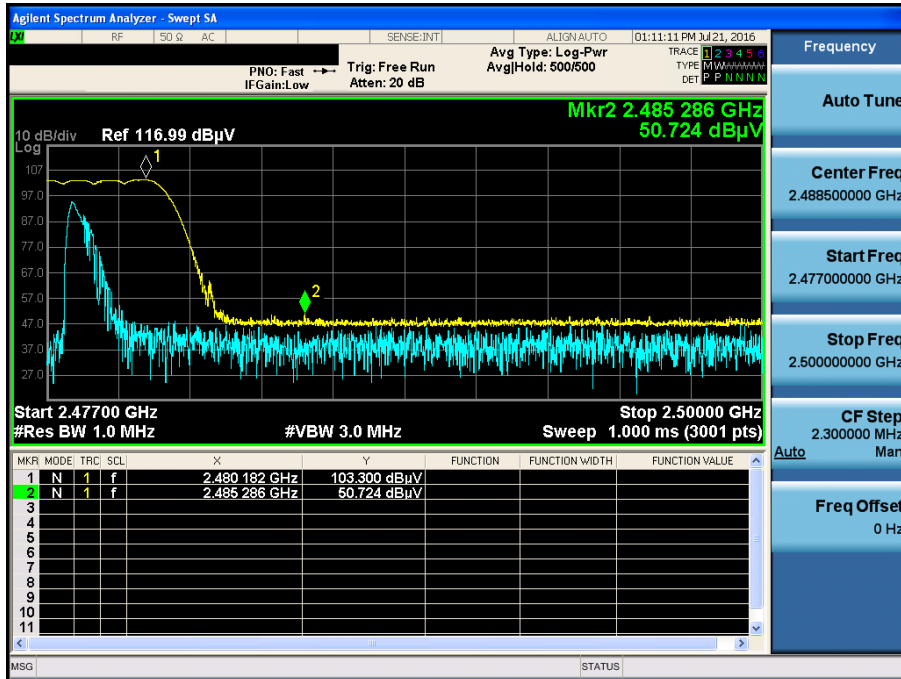

GFSK & Hopping mode & X & Hor

Detector Mode : AV

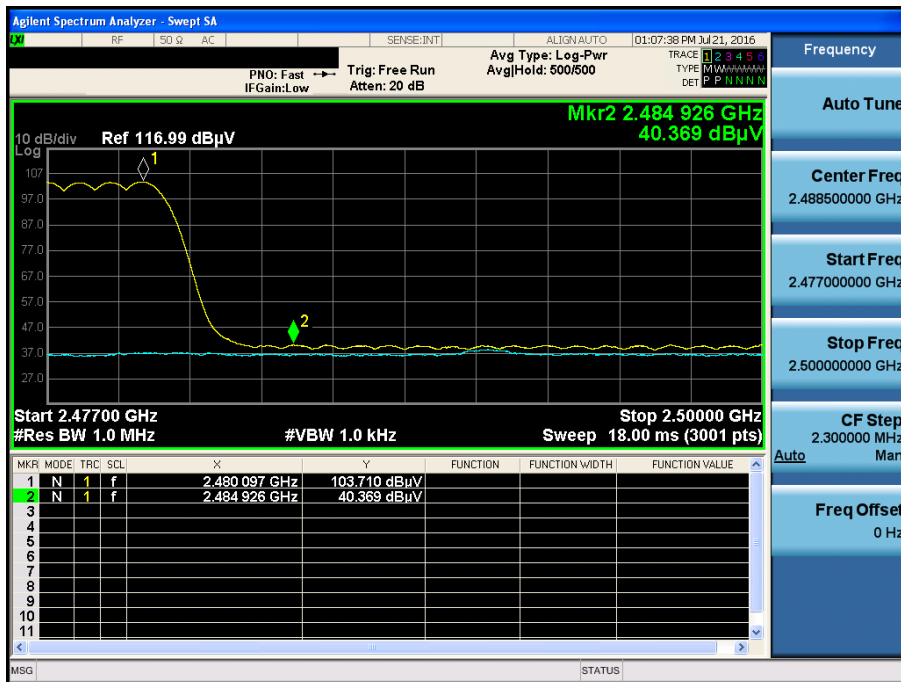

π /4DQPSK & Hopping mode & X & Hor

Detector Mode : PK

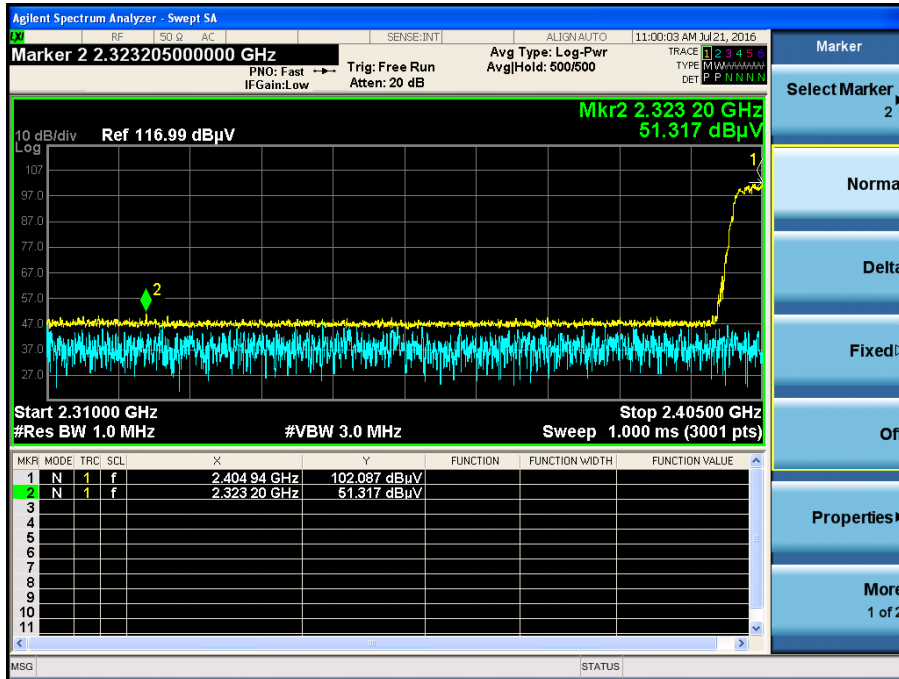

π /4DQPSK & Hopping mode & X & Hor

Detector Mode : AV

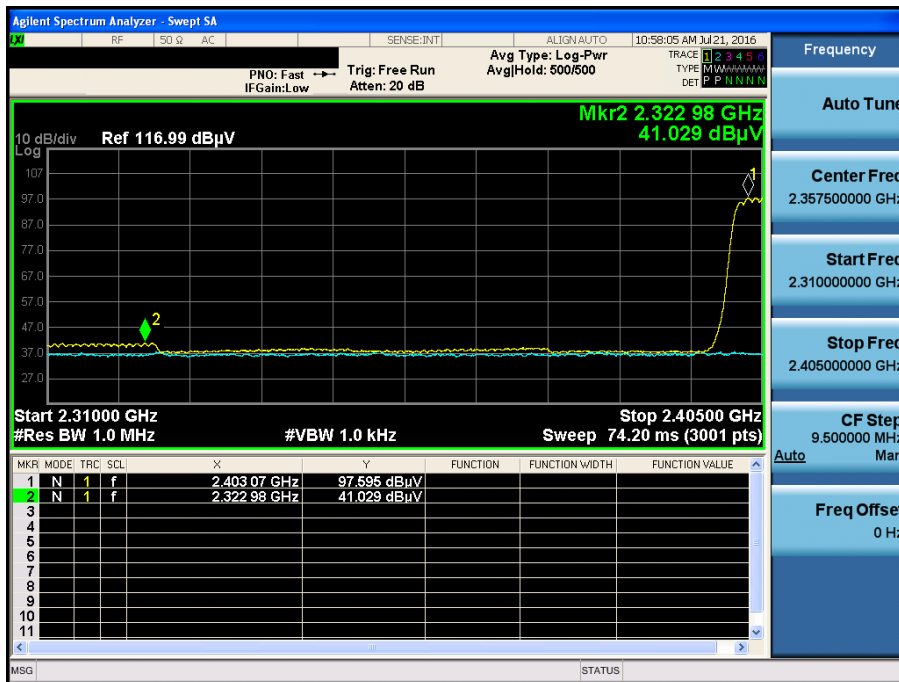

π /4DQPSK & Hopping mode & X & Hor

Detector Mode : PK

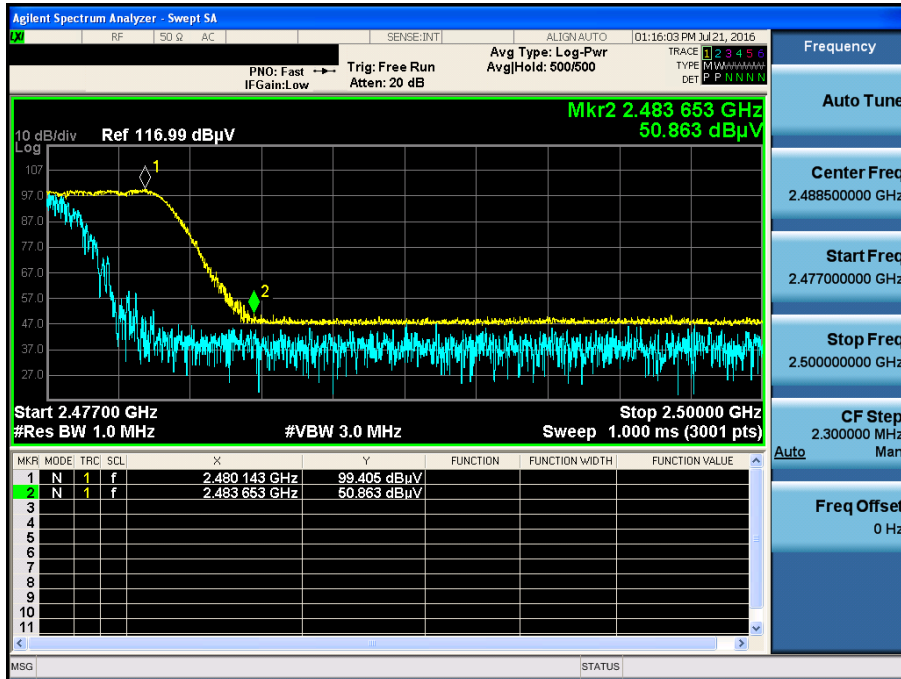

π /4DQPSK & Hopping mode & X & Hor

Detector Mode : AV



8DPSK & Hopping mode & X & Hor

Detector Mode : PK

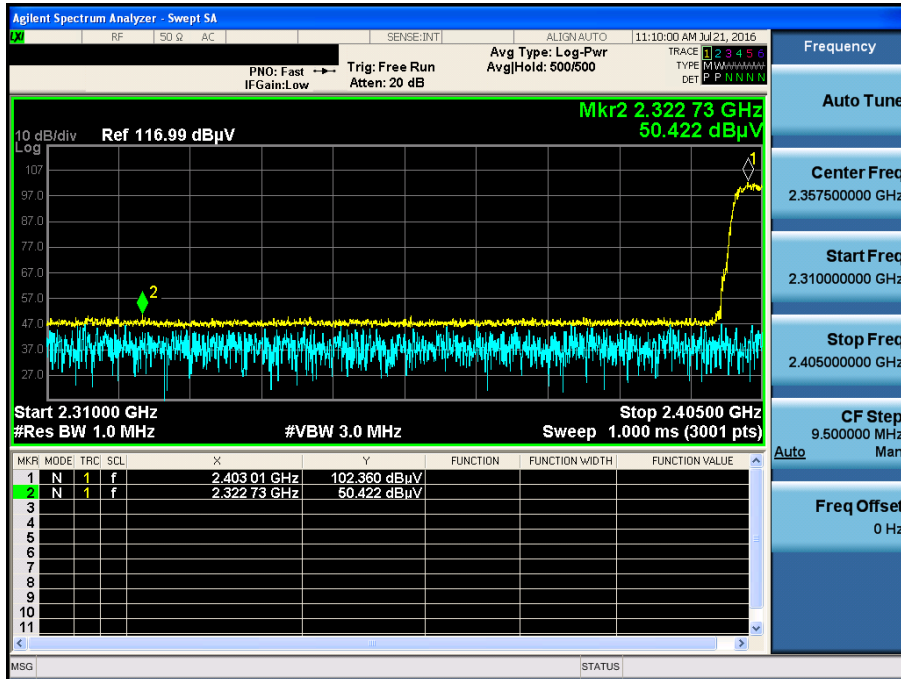

8DPSK & Hopping mode & X & Hor

Detector Mode : AV

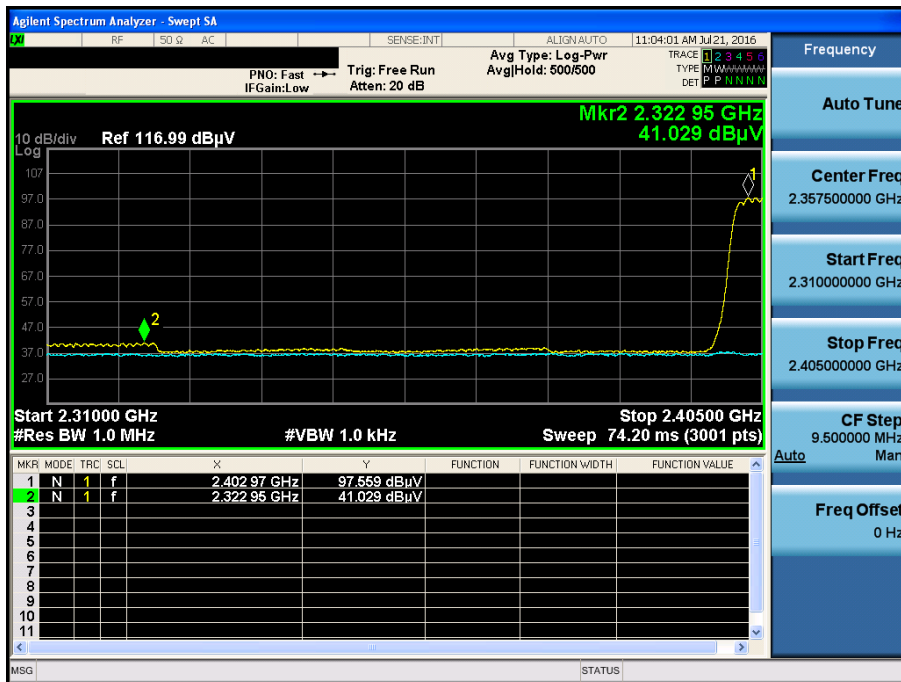

8DPSK & Hopping mode & X & Hor

Detector Mode : PK

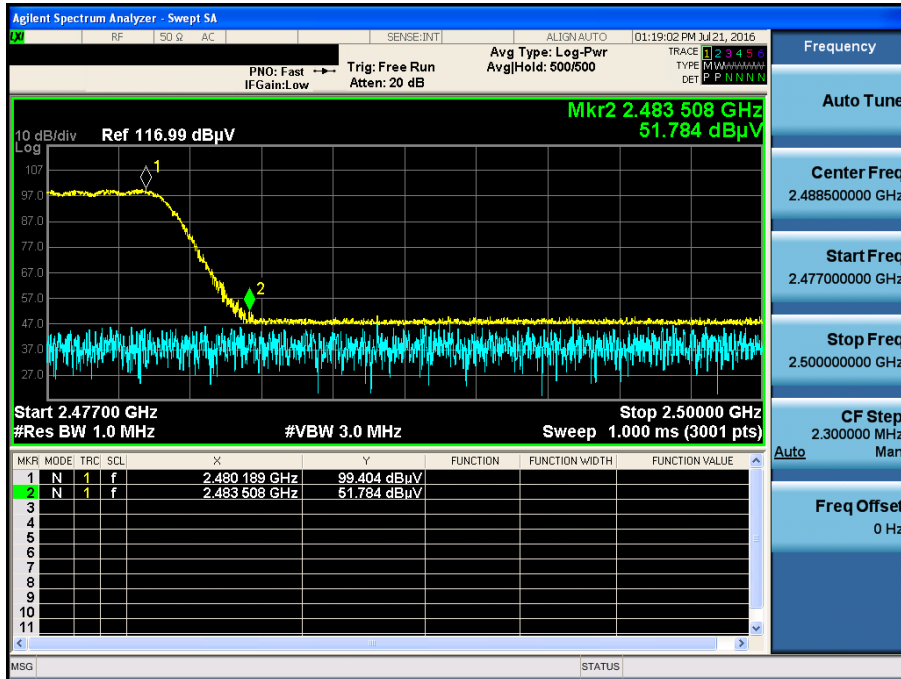

8DPSK & Hopping mode & X & Hor

Detector Mode : AV

