



243 Jubug-Ri, Yangji-Myeon, Yongin-Si, Gyeonggi-Do, Korea 449-822
 Tel: +82-31-323-6008 Fax: +82-31-323-6010
<http://www.ltalab.com>

SENA

Dates of Tests: November 5 ~ 14, 2014
 Test Report S/N: LR500111411C
 Test Site : LTA CO., LTD.

CERTIFICATION OF COMPLIANCE

FCC ID
 IC
 APPLICANT

S7A-SP18
8154A-SP18
Sena Technologies, Inc.

Equipment Class : **Part 15 Spread Spectrum Transmitter (DSS)**
Manufacturing Description : **BLUETOOTH STEREO SNOW HEADSET**
Manufacturer : **Sena Technologies, Inc.**
Model name : **Snowtalk**
Test Device Serial No.: : **Identical prototype**
Rule Part(s) : **FCC Part 15.247 Subpart C; ANSI C-63.4-2009**
RSS-210 and ISSUE No. :8 Date :2010
Frequency Range : **2402 ~ 2480MHz**
RF power : **Max 9.07 dBm – Conducted**
Data of issue : **November 14, 2014**

This test report is issued under the authority of:

Jae-Ho Lee, Manager

The test was supervised by:

Ha-Ram Lee, Test Engineer

This test result only responds to the tested sample. It is not allowed to copy this report even partly without the allowance of the test laboratory. The report must not be used by the client to claim product certification, approval, or endorsement by NVLAP, NIST, or any agency of the Federal Government.



NVLAP LAB Code.: 200723-0

TABLE OF CONTENTS

| | |
|--|----|
| 1. GENERAL INFORMATION | 3 |
| 2. INFORMATION ABOUT TEST ITEM | 4 |
| 3. TEST REPORT | 5 |
| 3.1 SUMMARY OF TESTS | 5 |
| 3.2 FREQUENCY HOPPING SYSTEM REQUIREMENTS..... | 6 |
| 3.3 TECHNICAL CHARACTERISTICS TEST | 8 |
| 3.3.1 CARRIER FREQUENCY SEPARATION | 8 |
| 3.3.2 NUMBER OF HOPPING FREQUENCIES | 10 |
| 3.3.3 20 dB BANDWIDTH | 12 |
| 3.3.4 TIME OF OCCUPANCY (Dwell Time) | 19 |
| 3.3.5 TRANSMITTER OUTPUT POWER | 24 |
| 3.3.6 BAND EDGE | 28 |
| 3.3.7 CONDUCTED SPURIOUS EMISSIONS | 32 |
| 3.3.8 RADIATED SPURIOUS EMISSIONS | 35 |
| 3.3.9 CONDUCTED & RADIATED SPURIOUS EMISSIONS – Receiver | 39 |
| 3.3.10 AC CONDUCTED EMISSIONS | 43 |
| | |
| APPENDIX | |
| APPENDIX TEST EQUIPMENT USED FOR TESTS | 47 |

1. General information

1-1 Test Performed

Company name : LTA Co., Ltd.
 Address : 243, Jubug-ri, Yangji-Myeon, Youngin-Si, Kyunggi-Do, Korea. 449-822
 Web site : <http://www.ltalab.com>
 E-mail : chahn@ltalab.com
 Telephone : +82-31-323-6008
 Facsimile : +82-31-323-6010

Quality control in the testing laboratory is implemented as per ISO/IEC 17025 which is the “General requirements for the competents of calibration and testing laboratory”.

1-2 Accredited agencies

LTA Co., Ltd. is approved to perform EMC testing by the following agencies:

| Agency | Country | Accreditation No. | Validity | Reference |
|--------|---------|--------------------|------------|-----------------------|
| NVLAP | U.S.A | 200723-0 | 2015-09-30 | ECT accredited Lab. |
| RRA | KOREA | KR0049 | 2015-03-06 | EMC accredited Lab. |
| FCC | U.S.A | 610755 | 2017-04-21 | FCC filing |
| FCC | U.S.A | 649054 | 2015-04-17 | FCC CAB |
| VCCI | JAPAN | R2133(10 m), C2307 | 2017-06-21 | VCCI registration |
| VCCI | JAPAN | T-2009 | 2016-12-23 | VCCI registration |
| VCCI | JAPAN | G-563 | 2015-05-28 | VCCI registration |
| IC | CANADA | 5799A-1 | 2015-06-21 | IC filing |
| KOLAS | KOREA | NO.551 | 2017-01-08 | KOLAS accredited Lab. |

2. Information about test item

2-1 Client & Manufacturer

Company name : Sena Technologies, Inc.
 Address : 210 Yangjae-dong Seocho-gu Seoul 137-130 Korea
 Telephone / Facsimile : Tel : +82-2-573-7772 / Fax : +82-2-573-7710

2-2 Equipment Under Test (EUT)

Trade name : SENA
 Model name : Snowtalk
 Serial number : Identical prototype
 Date of receipt : November 5, 2014
 EUT condition : Pre-production, not damaged
 Antenna type : Chip antenna (M/N:SENA_009) Max Gain -0.1 dBi
 Frequency Range : 2402 ~ 2480 MHz
 RF output power : Max. 9.07 dBm – Conducted
 Number of channels : 79
 Duty cycle : 78.85 %
 Channel spacing : 1MHz
 Channel Access Protocol : Frequency Hopping Spread Spectrum (FHSS)
 Type of Modulation : Basic Mode(GFSK), EDR Mode(Pi/4 DQPSK, 8DPSK)
 Power Source : DC 3.7V by battery
 Firmware Version : V1.0.0

2-3 Tested frequency

| Bluetooth | LOW | MID | HIGH |
|-----------------|------|------|------|
| Frequency (MHz) | 2402 | 2441 | 2480 |

2-4 Ancillary Equipment

| Equipment | Model No. | Serial No. | Manufacturer |
|-----------|-----------|------------|--------------|
| - | - | - | - |

3. Test Report

3.1 Summary of tests

| FCC Part Section(s) | Parameter | Limit | Test Condition | Status (note 1) |
|---------------------|----------------------------------|---|----------------|-----------------|
| 15.247(a) | Carrier Frequency Separation | $\geq 2/3$ of 20dB BW | Conducted | C |
| 15.247(a) | Number of Hopping Frequencies | ≥ 15 channels | | C |
| 15.247(a) | 20 dB Bandwidth 99% Bandwidth | – | | C |
| 15.247(a) | Dwell Time | ≤ 0.4 seconds | | C |
| 15.247(b) | Transmitter Output Power | ≤ 1 W for 1Mbps ≤ 125 mW for 2,3Mbps | | C |
| 15.247(d) | Conducted Spurious emission | > 20 dBc | | C |
| 15.247(d) | Band Edge | > 20 dBc | | C |
| 15.249 / 15.209 | Field Strength of Harmonics | < 54 dBuV (at 3m) | Radiated | C |
| 15.109 | Field Strength | – | | C |
| 15.207 / 15.107 | AC Conducted Emissions | EN 55022 | Line Conducted | C |
| 15.203 | Antenna requirement | – | – | C |

Note 1: C=Complies NC=Not Complies NT=Not Tested NA=Not Applicable

Note 2: The data in this test report are traceable to the national or international standards.

Note 1: Antenna Requirement

→ The **Sena Technologies, Inc.**, FCC ID: **S7A-SP18** unit complies with the requirement of §15.203.
The antenna type is chip antenna.

Note 2: The sample was tested according to the following specification:

FCC Parts 15.247; ANSI C-63.4-2009
RSS-210 and ISSUE No.:8 Date:2010

Note3: TEST METHODOLOGY

The measurement procedure described in the American National Standard for Testing Unlicensed Wireless Devices(ANSI C63.10-2009) and FCC Public Notice DA 00-705 dated March 30, 2000 entitled “**Filing and Measurement Guidelines for Frequency Hopping Spread Spectrum Systems**” were used in the measurement of the **Sena Technologies, Inc.**, FCC ID: **S7A-SP18**

3.2 Frequency Hopping System Requirements

3.2.1 Standard Applicable

According to FCC Part 15.247(a)(1), The system shall hop to channel frequencies that are selected at the system hopping rate from a pseudo randomly ordered list of hopping frequencies. Each frequency must be used equally on the average by each transmitter. The system receivers shall have input bandwidths that match the hopping channel bandwidths of their corresponding transmitters and shall shift frequencies in synchronization with the transmitted signals.

(g) Frequency hopping spread spectrum systems are not required to employ all available hopping channels during each transmission. However, the system, consisting of both the transmitter and the receiver, must be designed to comply with all of the regulations in this section should the transmitter be presented with a continuous data (or information) stream. In addition, a system employing short transmission bursts must comply with the definition of a frequency hopping system and must distribute its transmissions over the minimum number of hopping channels specified in this section.

(h) The incorporation of intelligence within a frequency hopping spread spectrum system that permits the system to recognize other users within the spectrum band so that it individually and independently chooses and adapts its hopsets to avoid hopping on occupied channels is permitted. The coordination of frequency hopping systems in any other manner for the express purpose of avoiding the simultaneous occupancy of individual hopping frequencies by multiple transmitters is not permitted.

3.2.2 EUT Pseudorandom Frequency Hopping Sequence

The pseudorandom sequence may be generated in a nine-stage shift register whose 5th and 9th stage outputs are added in a modulo-two addition stage, and the result is fed back to the input of the first stage. The sequence begins with the first ONE of 9 consecutive ONES; i.e. the shift register is initialized with nine ones. Number of shift register stages: 9
 Length of pseudo-random sequence: $2^9 - 1 = 511$ bits
 Longest sequence of zeros: 8 (non-inverted signal)

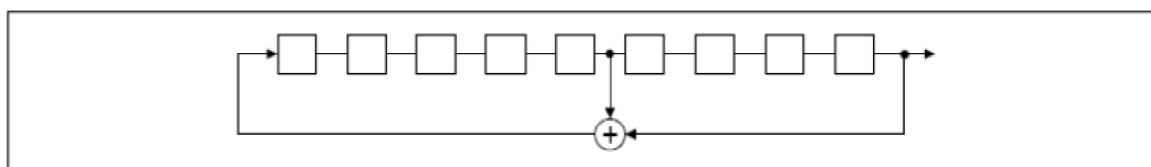

Linear Feedback Shift Register for Generation of the PRBS sequence

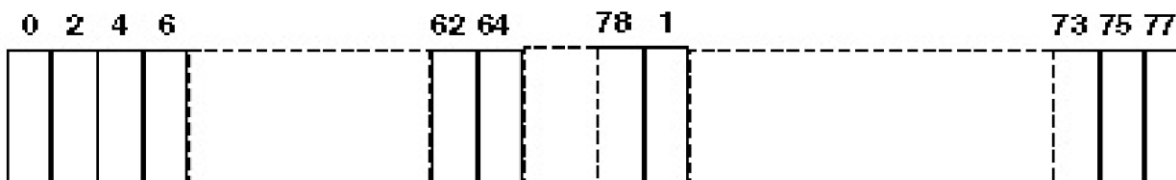

Each frequency used equally on the average by each transmitter.
 The system receiver have input bandwidths that match the hopping channel bandwidths of their corresponding transmitters and shift frequencies in synchronization with the transmitted signals.

3.2.3 Frequency Hopping System

This transmitter device is frequency hopping device, and complies with FCC part 15.247 rule.

This device uses Bluetooth radio which operates in 2400-2483.5 MHz band. Bluetooth uses a radio technology called frequency-hopping spread spectrum, which chops up the data being sent and transmits chunks of it on up to 79 bands (1 MHz each; centred from 2402 to 2480 MHz) in the range 2,400-2,483.5 MHz. The transmitter switches hop frequencies 1,600 times per second to assure a high degree of data security. All Bluetooth devices participating in a given piconet are synchronized to the frequency-hopping channel for the piconet. The frequency hopping sequence is determined by the master's device address and the phase of the hopping sequence (the frequency to hop at a specific time) is determined by the master's internal clock. Therefore, all slaves in a piconet must know the master's device address and must synchronize their clocks with the master's clock.

Adaptive Frequency Hopping (AFH) was introduced in the Bluetooth specification to provide an effective way for a Bluetooth radio to counteract normal interference. AFH identifies "bad" channels, where either other wireless devices are interfering with the Bluetooth signal or the Bluetooth signal is interfering with another device. The AFH-enabled Bluetooth device will then communicate with other devices within its piconet to share details of any identified bad channels. The devices will then switch to alternative available "good" channels, away from the areas of interference, thus having no impact on the bandwidth used.

*Example for a Bluetooth device using channel numbers would be : Chan 44, 35, 78, 03, 15, 21, 76, 40, 56, 13, 02, 19, 67, 39, 78, 20, 21, 64, 75 etc.

3.3 TECHNICAL CHARACTERISTIC TEST

3.3.1 Carrier Frequency Separation

Procedure:

The test follows DA00-705. The carrier frequency separation was measured with a spectrum analyzer connected to the antenna terminal, while EUT had its hopping function enabled.

After the trace being stable, the reading value between the peaks of the adjacent channels using the marker-delta function was recorded as the measurement results.

The spectrum analyzer is set to:

Span = 2~ 3 MHz (wide enough to capture the peaks of two adjacent channels)

RBW = 10 kHz (1% of the span or more) Sweep = auto

VBW = 10 kHz Detector function = peak

Trace = max hold

Measurement Data:

| Test Results | |
|------------------------------------|----------|
| Carrier Frequency Separation (MHz) | Result |
| 1.0014 | Complies |

- See next pages for actual measured spectrum plots.

Minimum Standard:

The EUT shall have hopping channel carrier frequencies separated by a minimum of 25kHz or two-thirds of 20dB bandwidth of the hopping channel, whichever is greater.

Measurement Setup

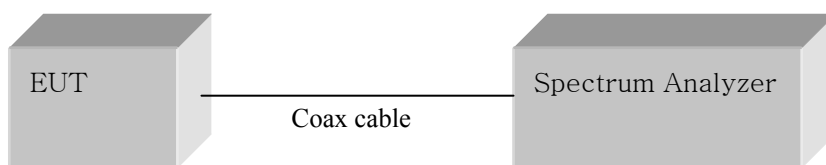
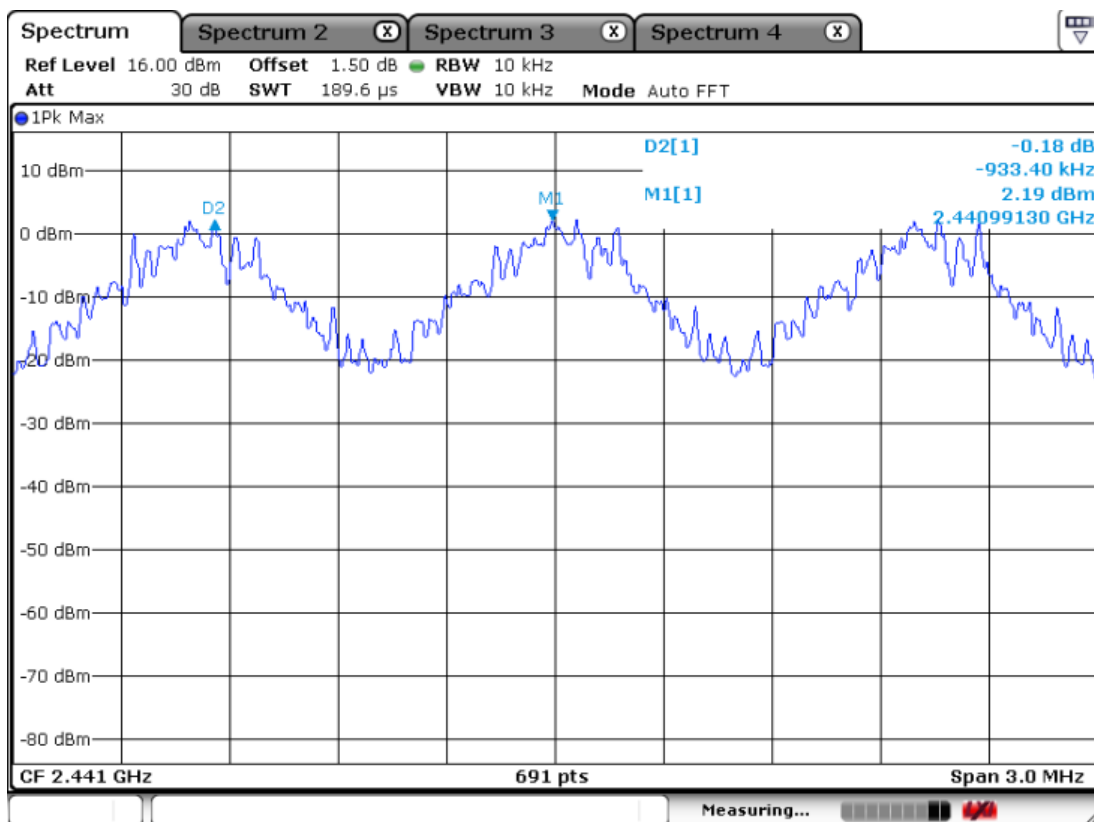

Figure 1: Measurement setup for the carrier frequency separation

Carrier Frequency Separation

Basic Mode



EDR Mode

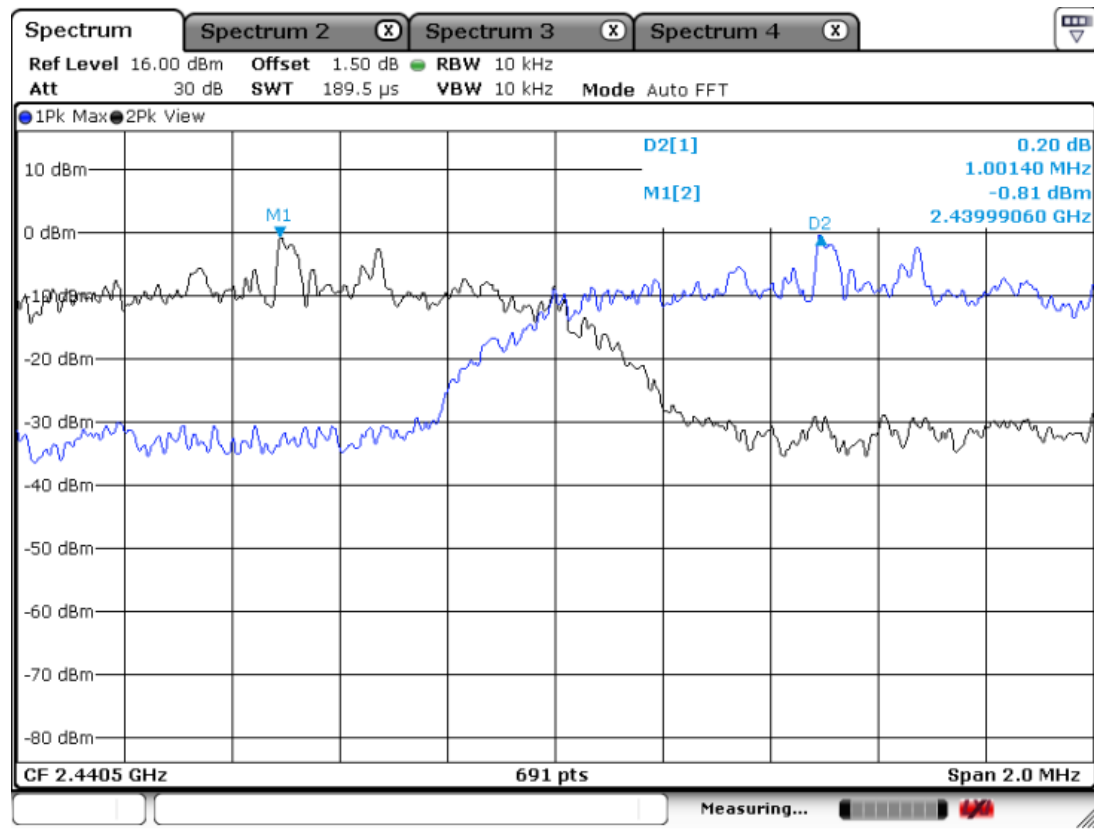

3.3.2 Number of Hopping Frequencies

Procedure:

The test follows DA00-705. The number of hopping frequencies was measured with a spectrum analyzer connected to the antenna terminal, while EUT had its hopping function enabled.

To get higher resolution, four frequency ranges within the 2400 ~ 2483.5 MHz FH band were examined.

The spectrum analyzer is set to (Bluetooth):

Frequency range Start = 2400.0MHz, Stop = 2483.5 MHz

RBW = 100 kHz (1% of the span or more) Sweep = auto

VBW = 100 kHz (VBW ≥ RBW) Detector function = peak

Trace = max hold Span > 40MHz

Measurement Data : Complies

| | |
|---|----|
| Total number of Hopping Channels | 79 |
|---|----|

- See next pages for actual measured spectrum plots.

Minimum Standard:

At least 15 channels

Measurement Setup

Same as the Chapter 3.3.1 (Figure 1)

Number of Hopping Frequencies

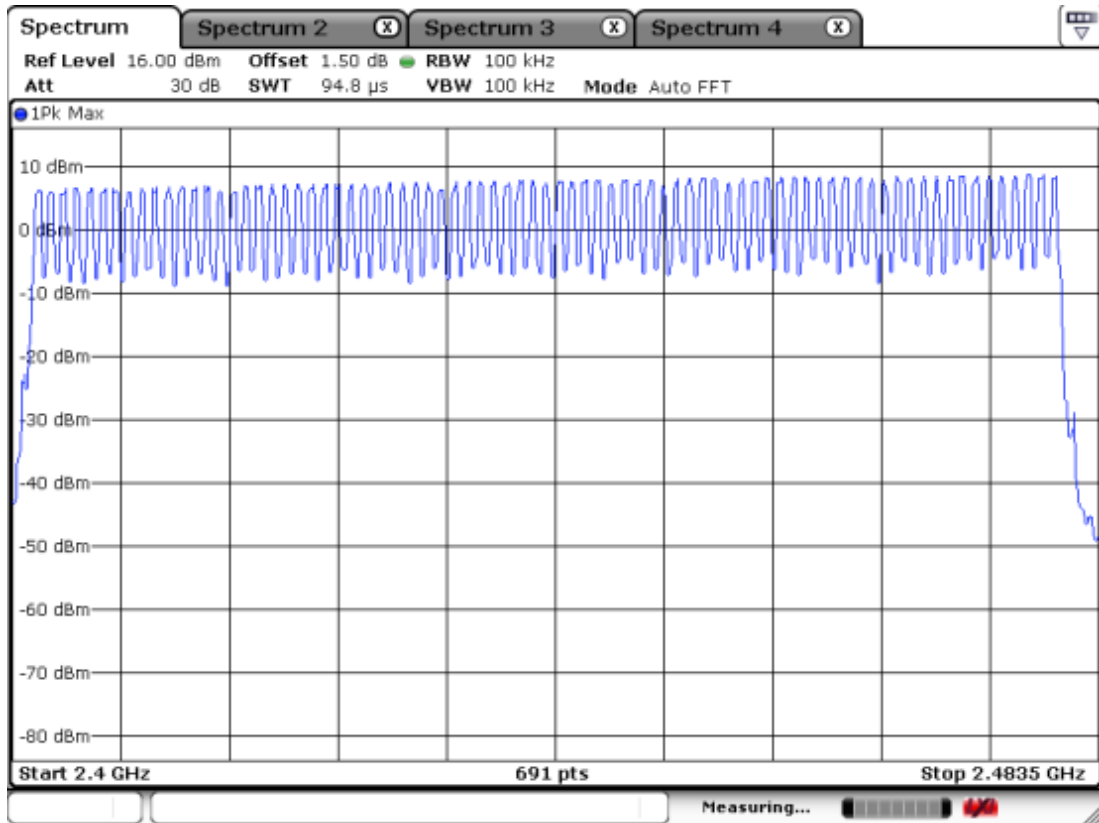

3.3.3 20 dB Bandwidth

Procedure:

The bandwidth at 20 dB below the highest inband spectral density was measured with a spectrum analyzer connected to the antenna terminal, while EUT had its hopping function disabled at the highest, middle and the lowest available channels..

After the trace being stable, Use the marker-to-peak function to set the marker to the peak of the emission. Use the marker-delta function to measure 20dB down one side of the emission. Reset the marker-delta function, and move the marker to the other side of the emission, until it is (as close as possible to) even with the reference marker level. The marker-delta reading at this point is the 20 dB bandwidth of the emission.

The spectrum analyzer is set to (Bluetooth):

Center frequency = the highest, middle and the lowest channels

Span = 3 MHz (approximately 2 or 3 times of the 20 dB bandwidth)

RBW = 30 kHz

Sweep = auto

VBW = 30 kHz (VBW \geq RBW)

Detector function = peak

Trace = max hold

Measurement Data: Basic Mode

| Frequency (MHz) | Channel No. | Test Results(MHz) | |
|-----------------|-------------|-------------------|---------------|
| | | 20dB Bandwidth | 99% Bandwidth |
| 2402 | 0 | 0.821 | 0.890 |
| 2441 | 39 | 0.821 | 0.877 |
| 2480 | 78 | 0.821 | 0.886 |

Measurement Data: EDR Mode

| Frequency (MHz) | Channel No. | Test Results(MHz) | |
|-----------------|-------------|-------------------|---------------|
| | | 20dB Bandwidth | 99% Bandwidth |
| 2402 | 0 | 1.316 | 1.294 |
| 2441 | 39 | 1.311 | 1.298 |
| 2480 | 78 | 1.311 | 1.298 |

- See next pages for actual measured spectrum plots.

Minimum Standard:

N/A

Measurement Setup

Same as the Chapter 3.3.1 (Figure 1)

Channel 1 of basic mode

20 dB Bandwidth

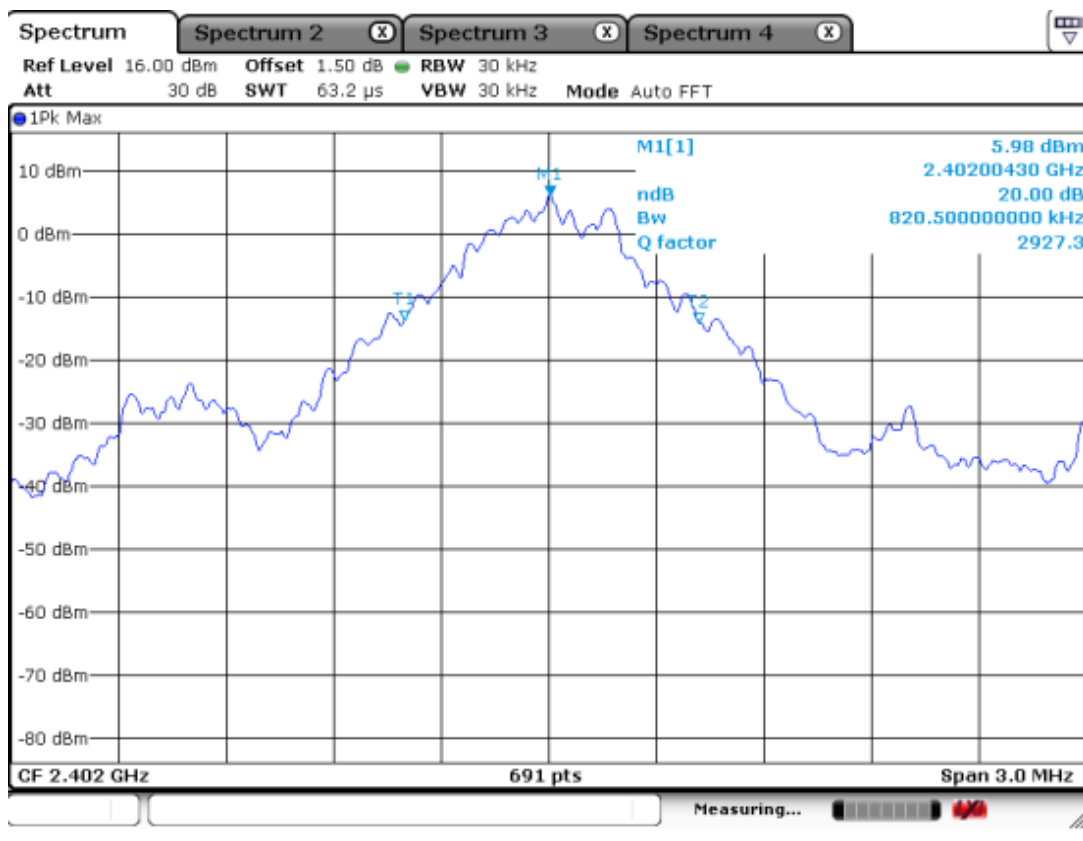

99% Bandwidth

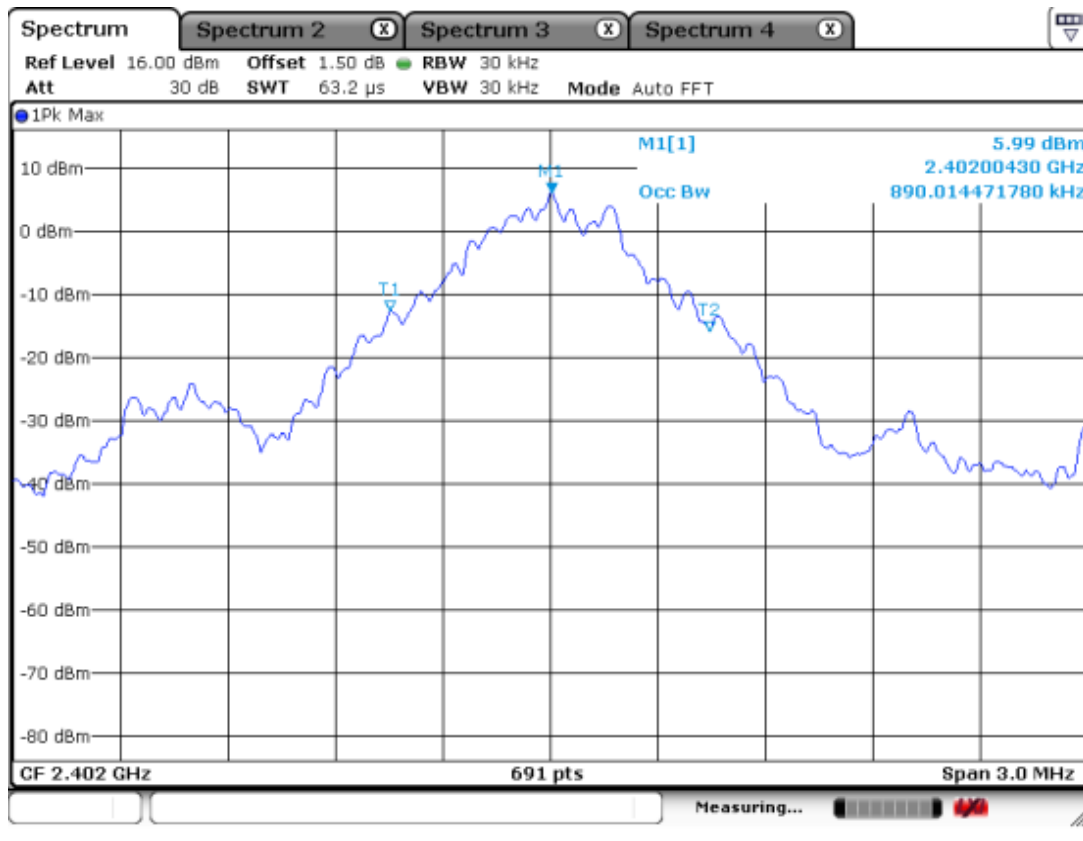

Channel 2 of basic mode

20 dB Bandwidth

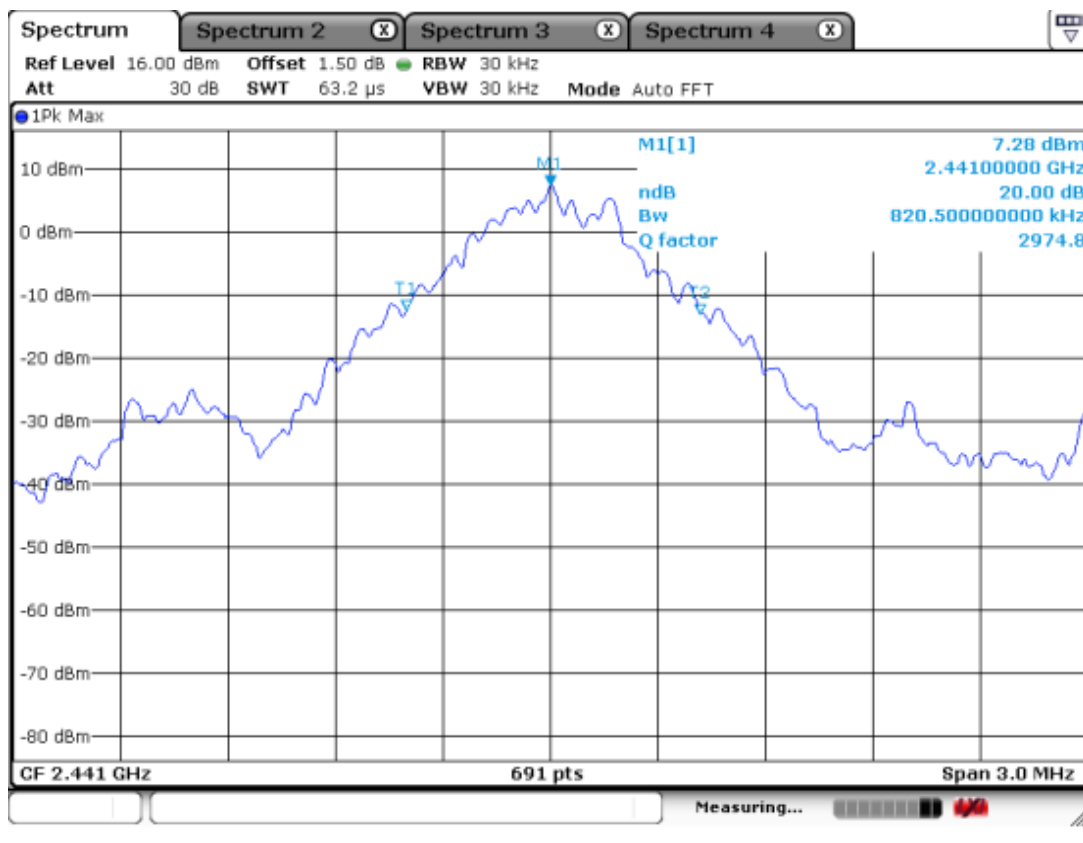

99% Bandwidth

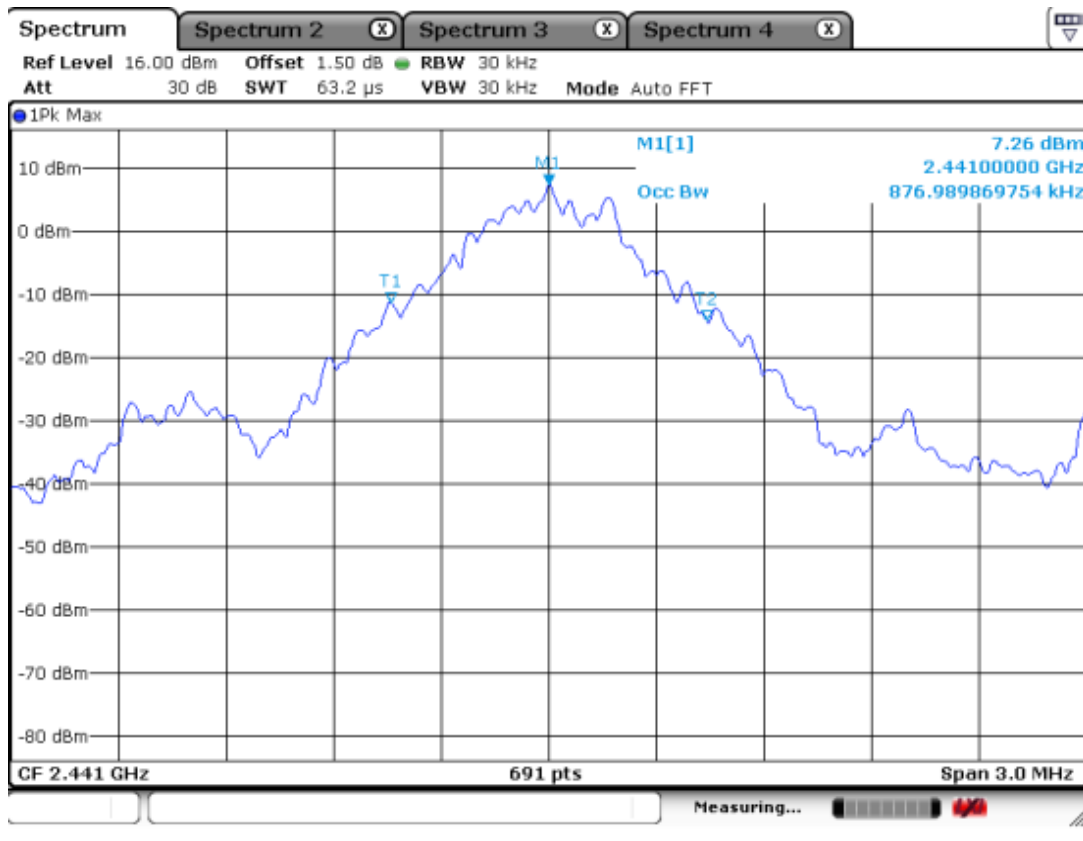

Channel 3 of basic mode

20 dB Bandwidth

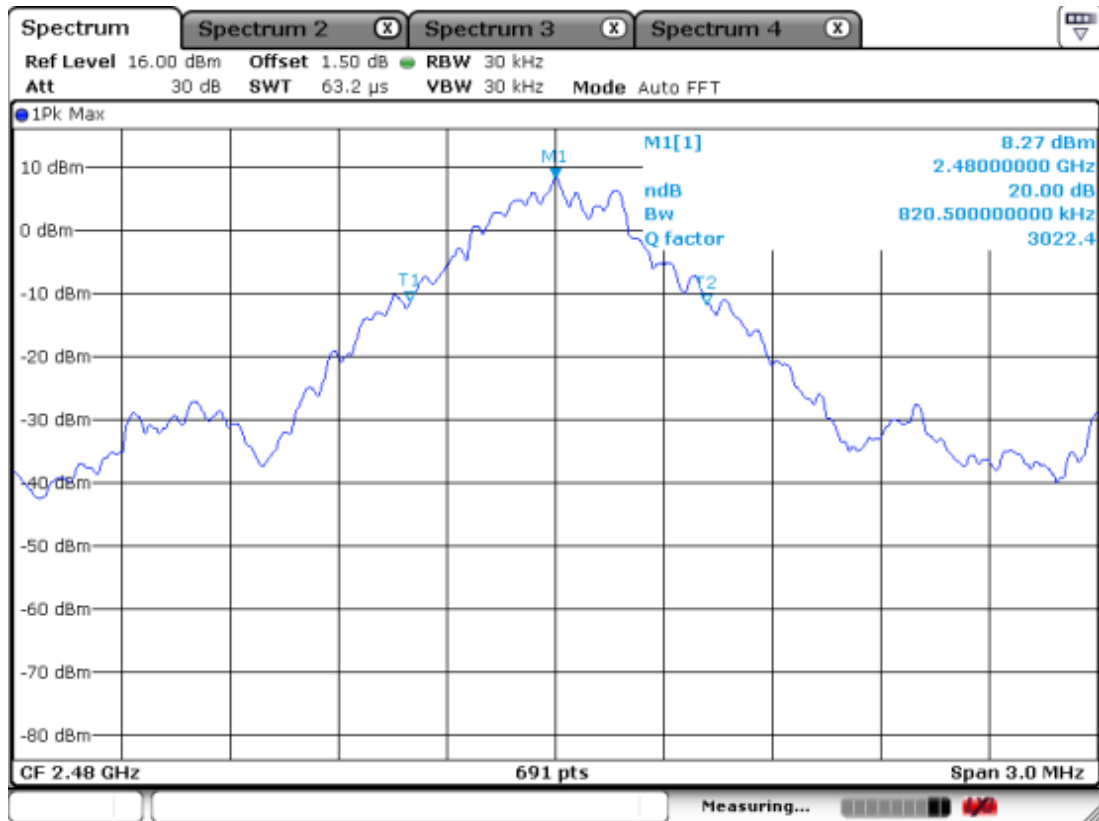

99% Bandwidth

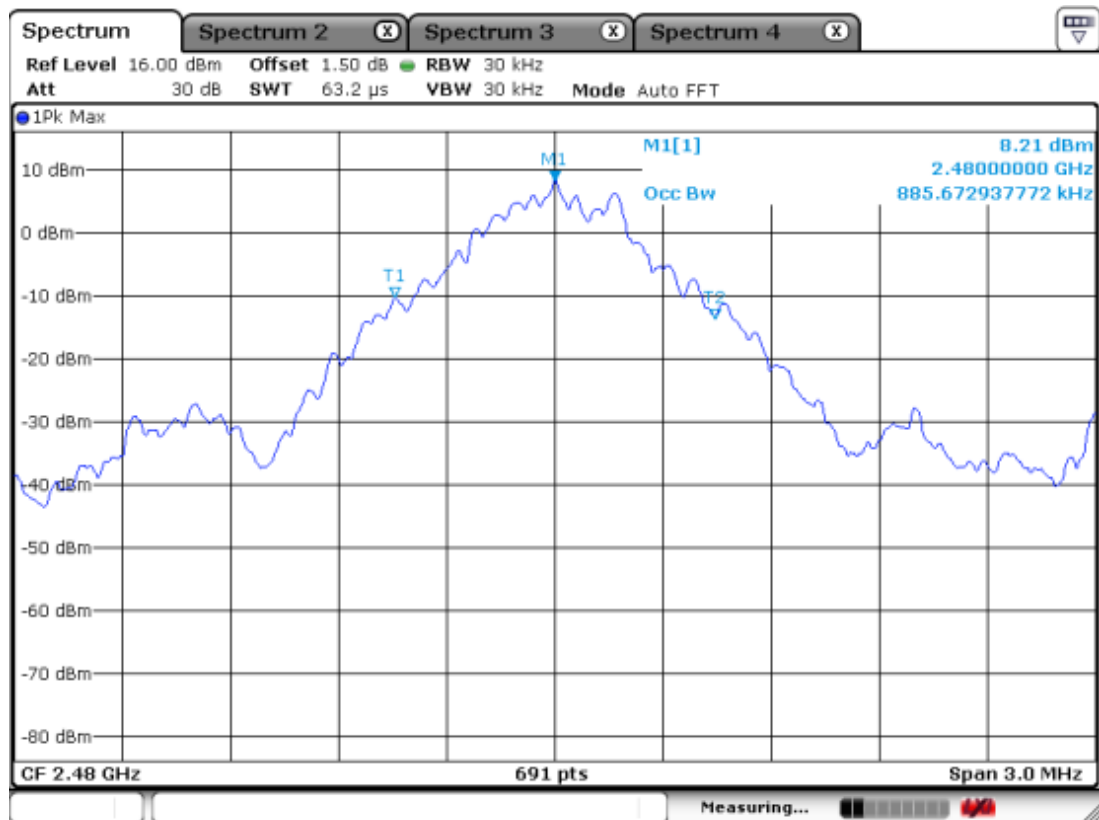

Channel 1 at EDR mode

20 dB Bandwidth

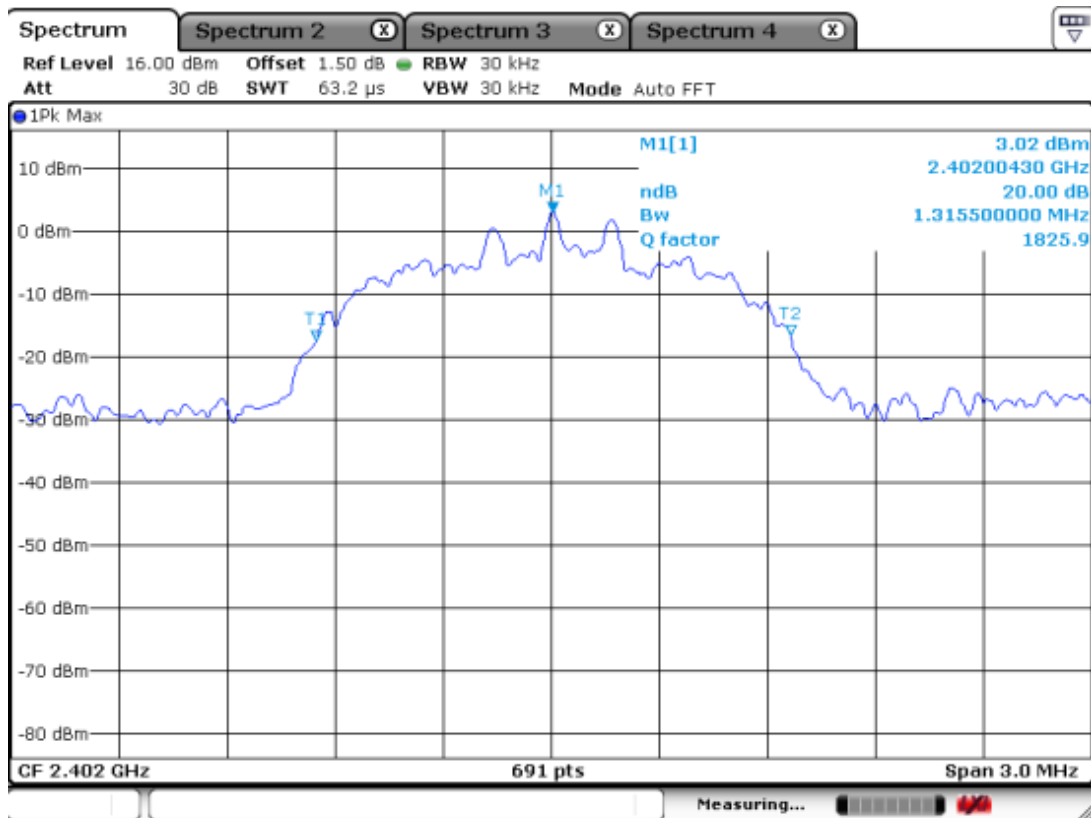

99% Bandwidth

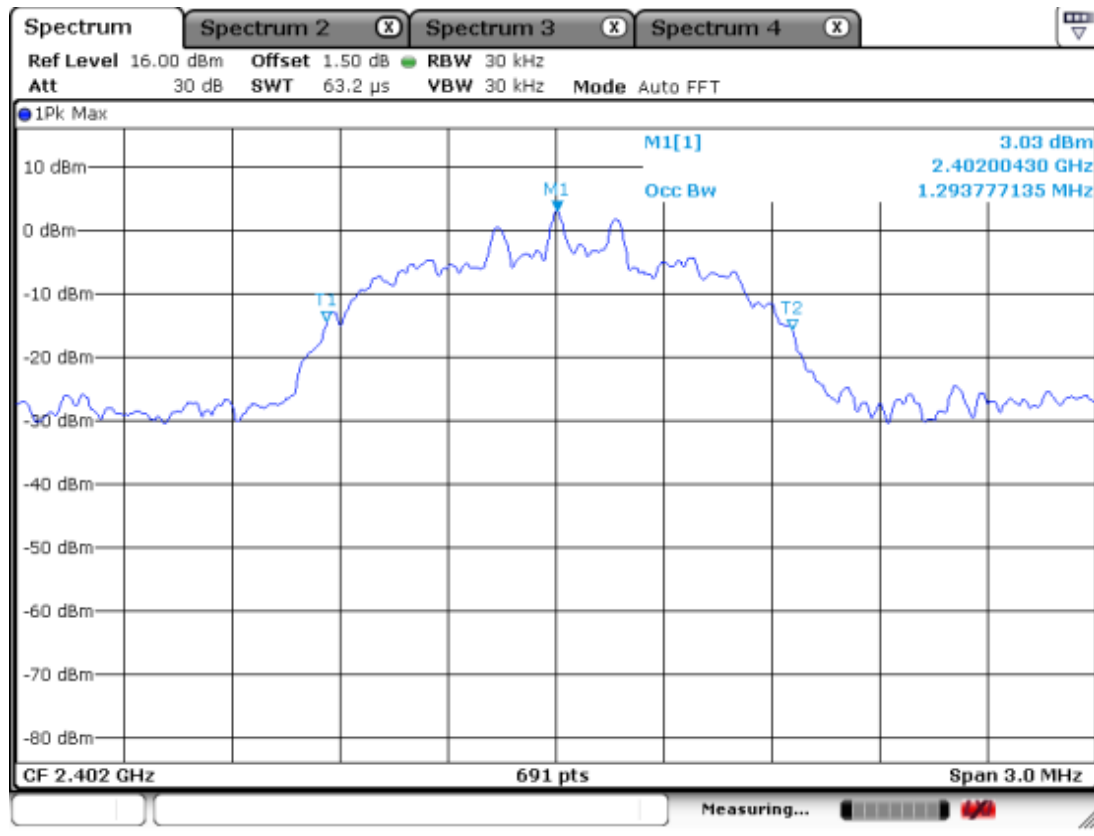

Channel 2 at EDR mode

20 dB Bandwidth

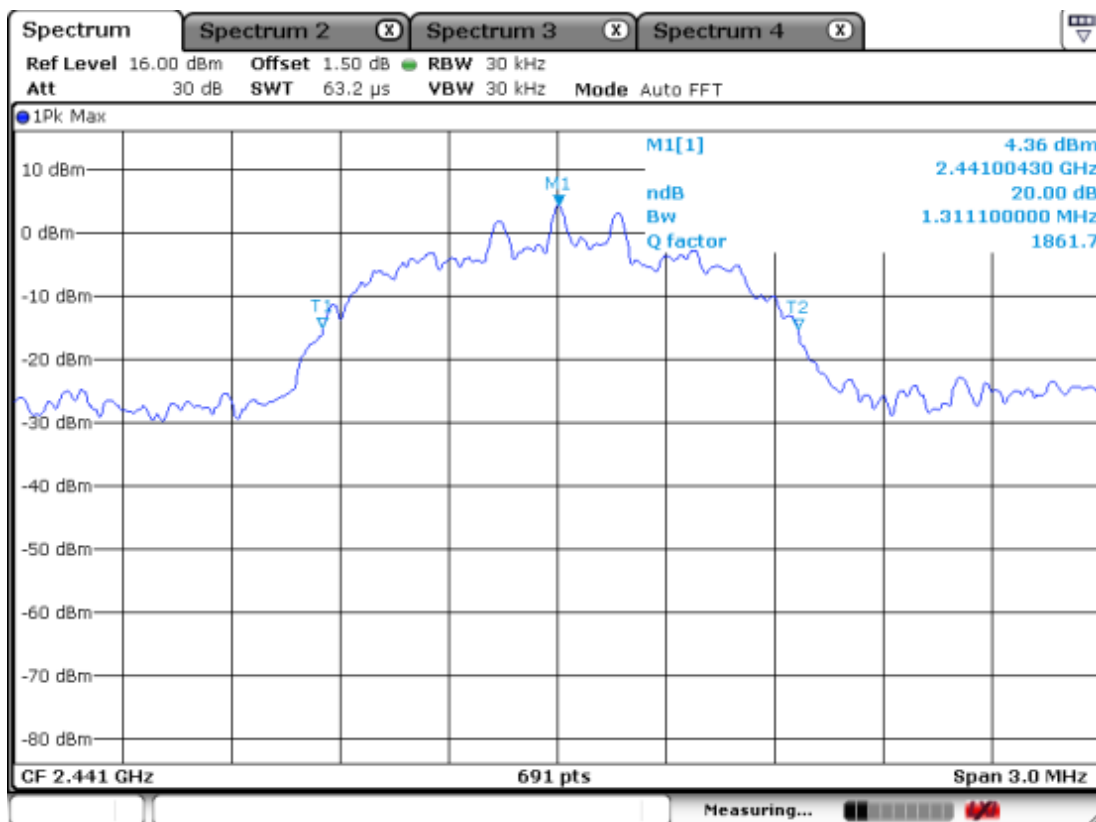

99% Bandwidth

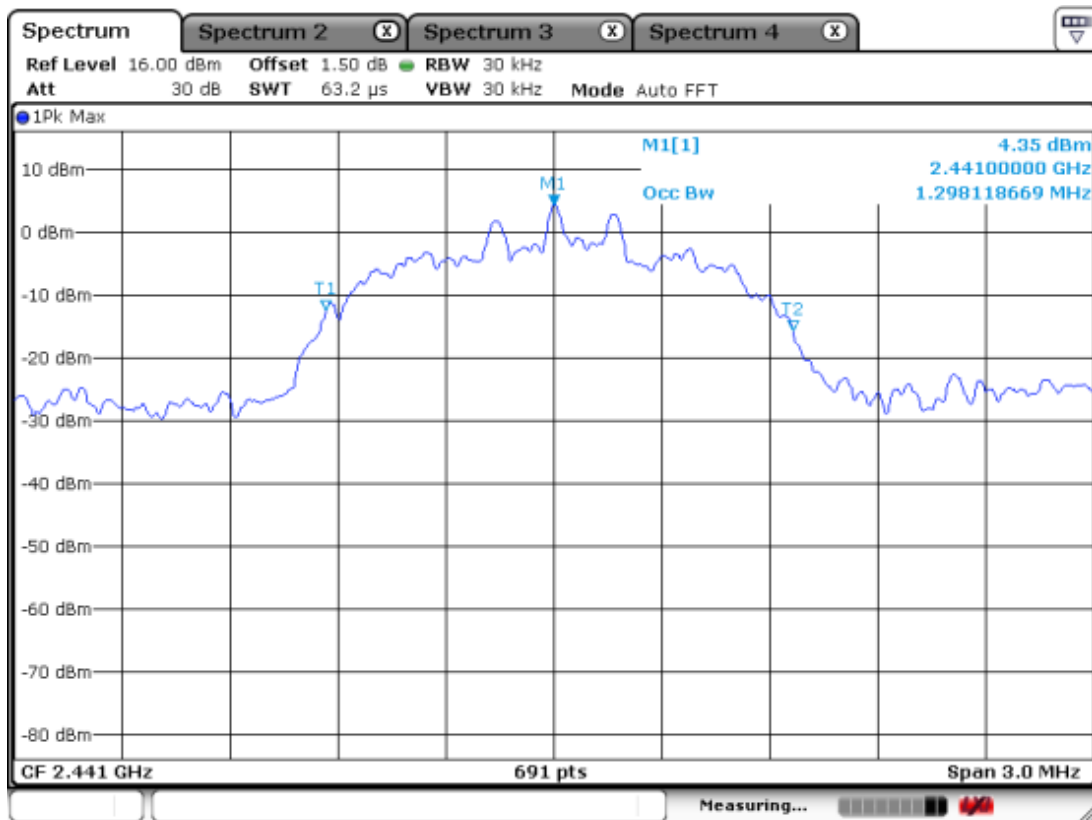

Channel 3 at EDR mode

20 dB Bandwidth

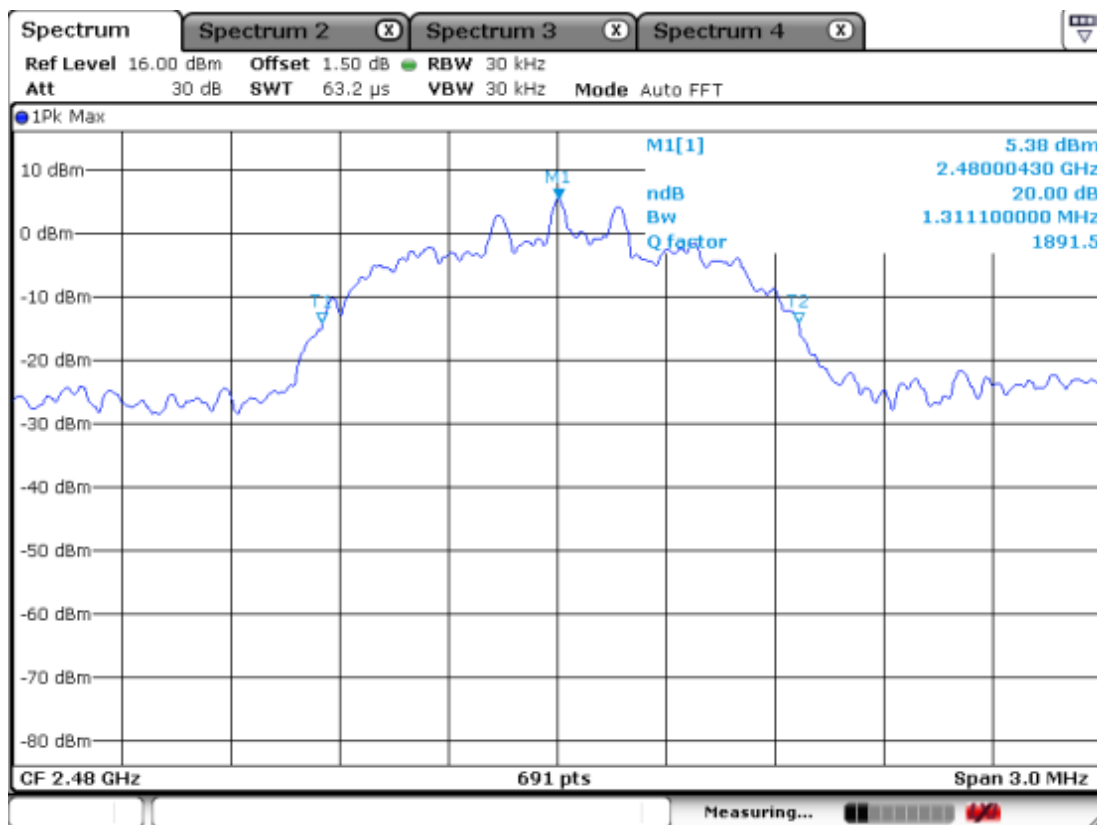

99% Bandwidth

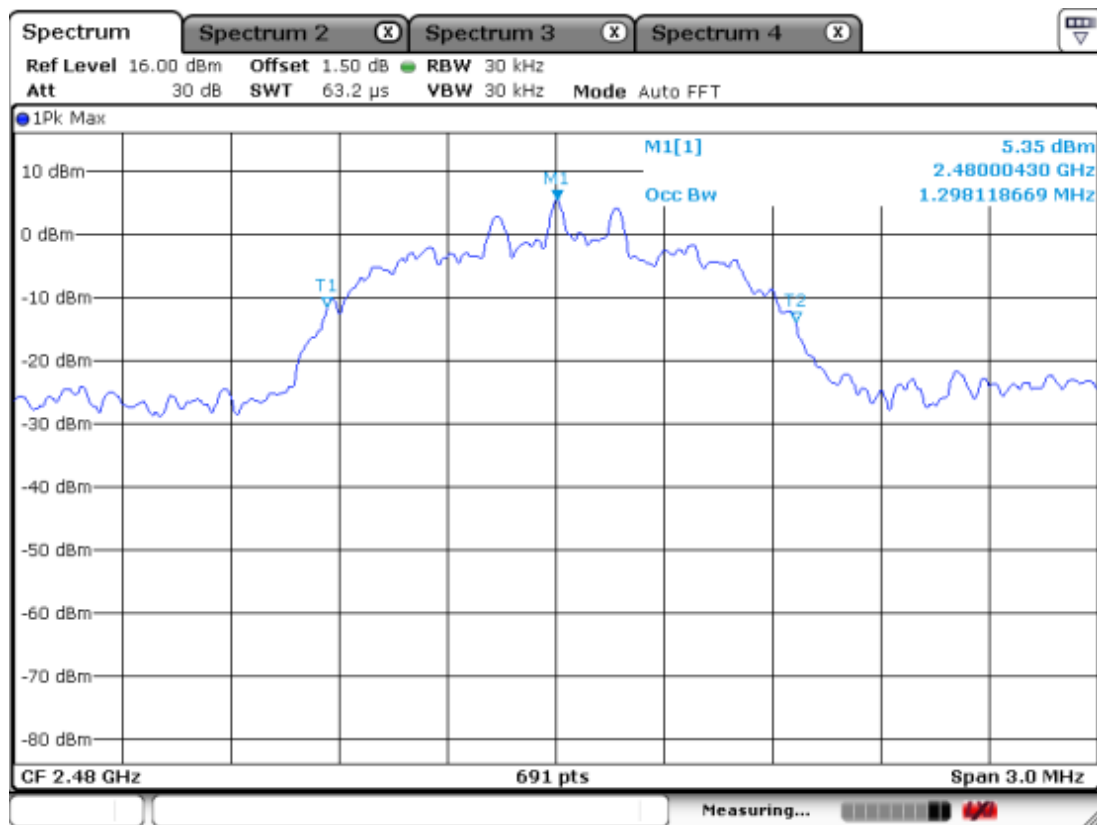

3.3.4 Time of Occupancy (Dwell Time)

Procedure:

The test follows DA00-705. The dwell time was measured with a spectrum analyzer connected to the antenna terminal, while EUT had its hopping function enabled.

The spectrum analyzer is set to :

Center frequency = 2441 MHz

Span = zero

RBW = 1 MHz

VBW = 1 MHz (VBW \geq RBW)

Trace = max hold

Detector function = peak

Measurement Data (Bluetooth):

| Mode | Number of transmission in a 31.6s (79Hopping*0.4) | Length of Transmission Time (msec) | Result (msec) | Limit (msec) |
|---------------|---|---------------------------------------|------------------|-----------------|
| DH1 | 30(Times / 3sec) *10.533 = 315.99 | 0.464 | 146.62 | 400 |
| DH3 | 15(Times / 3sec) *10.533 = 158.00 | 1.717 | 271.29 | 400 |
| DH5 | 10(Times / 3sec) *10.533 = 105.33 | 2.978 | 313.67 | 400 |
| EDR 3Mbps DH5 | 10(Times / 3sec) *10.533 = 105.33 | 3.080 | 324.42 | 400 |

- See next pages for actual measured spectrum plots.
- dwell time = {(number of hopping per second / number of slot) x duration time per channel} x 0.4 ms

Minimum Standard:

0.4 seconds within a period of 0.4 seconds multiplied by the number of hopping channels employed

Measurement Setup

Same as the Chapter 3.3.1 (Figure 1)

DH1 at basic mode

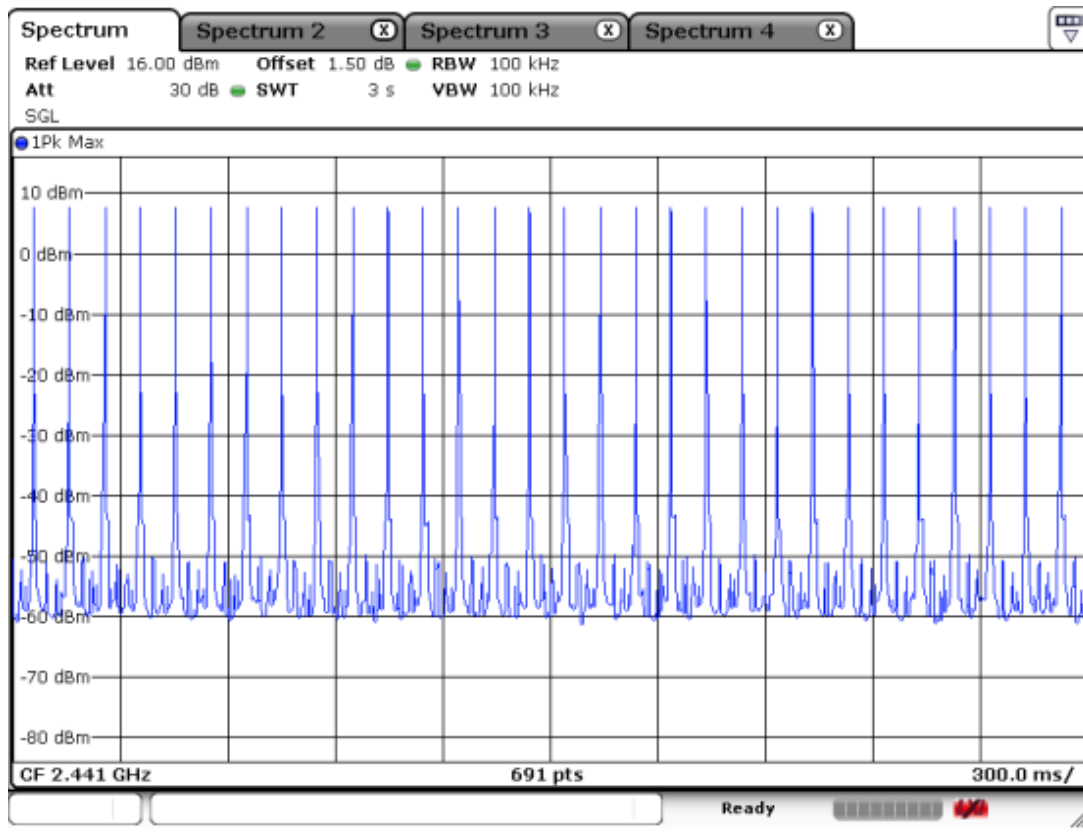
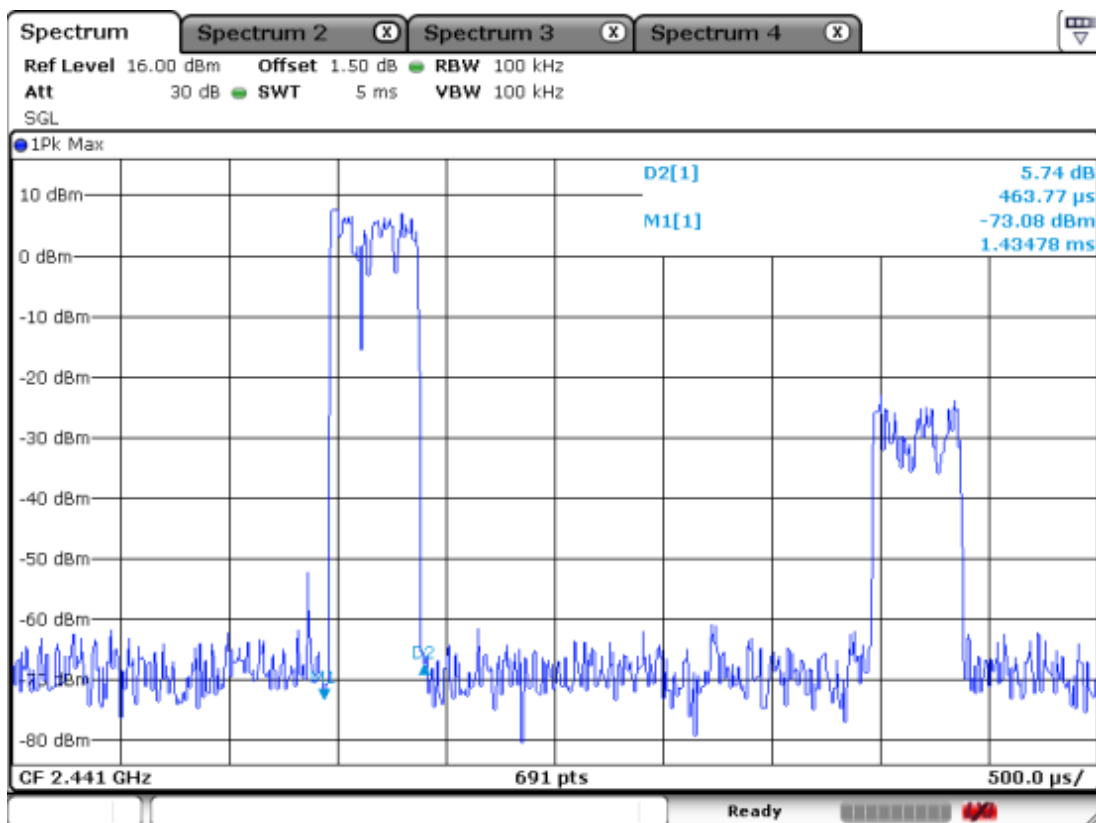

DH3 at basic mode

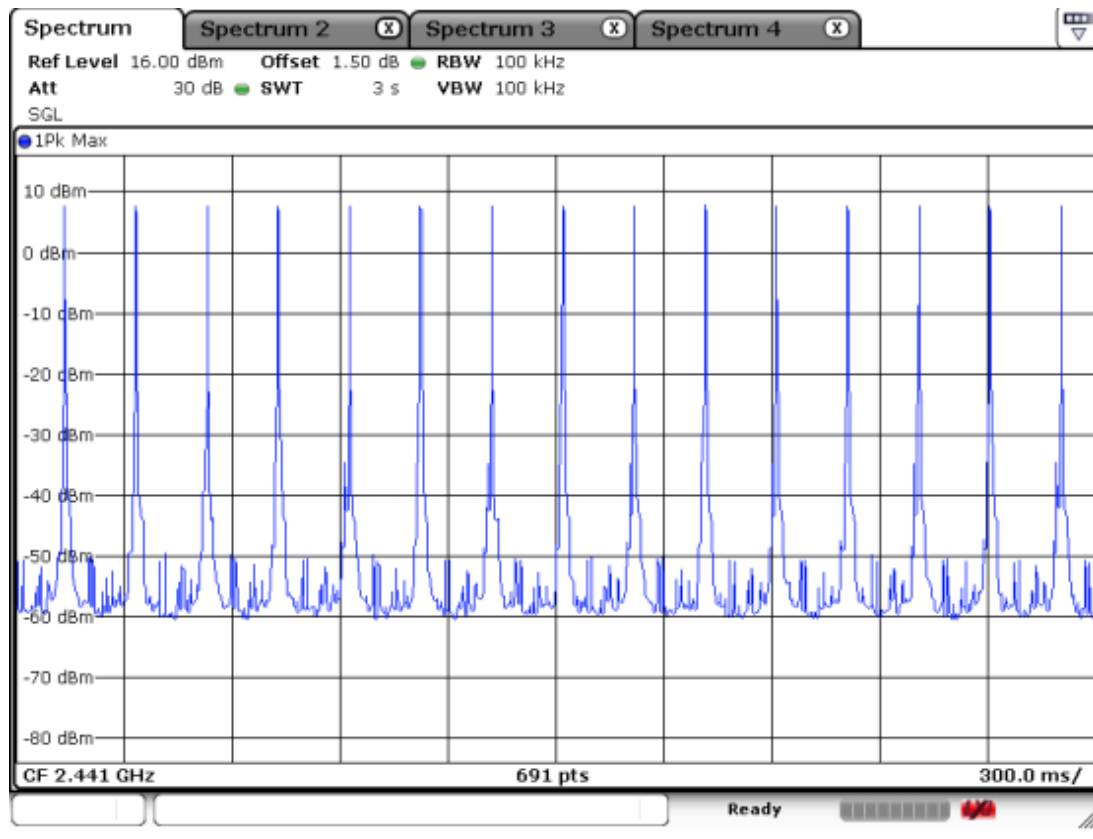
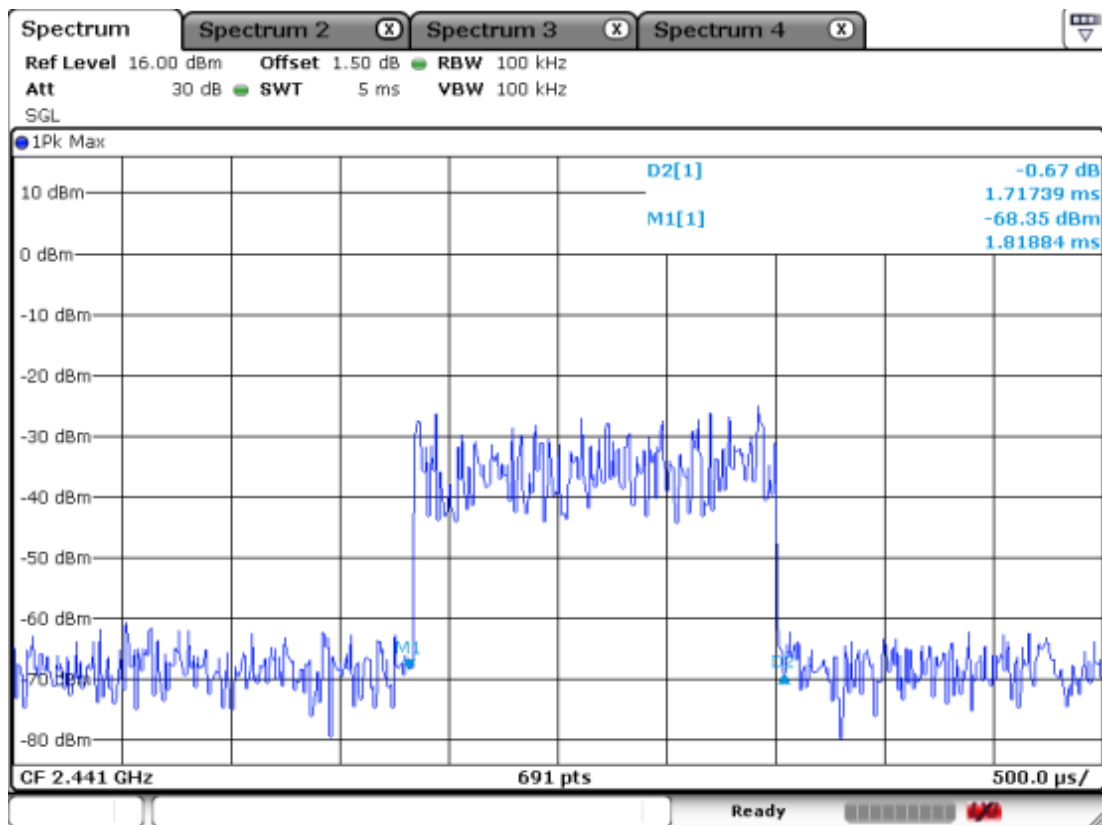

DH3 at basic mode

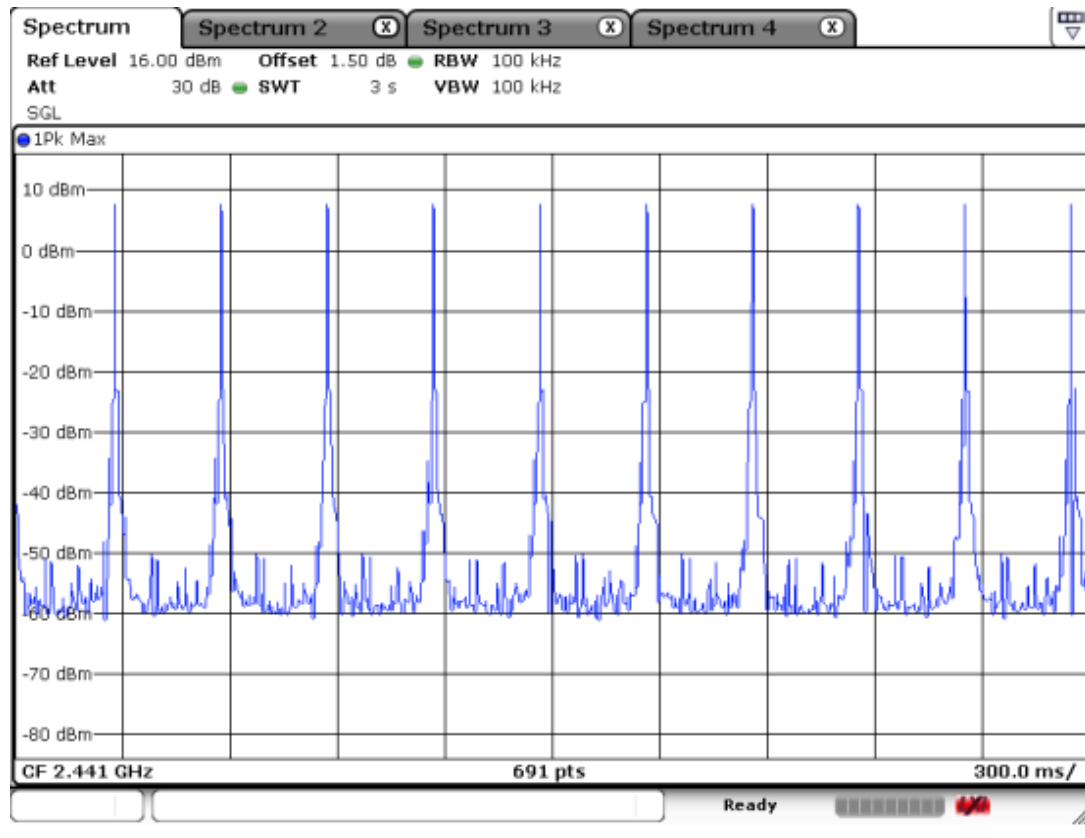
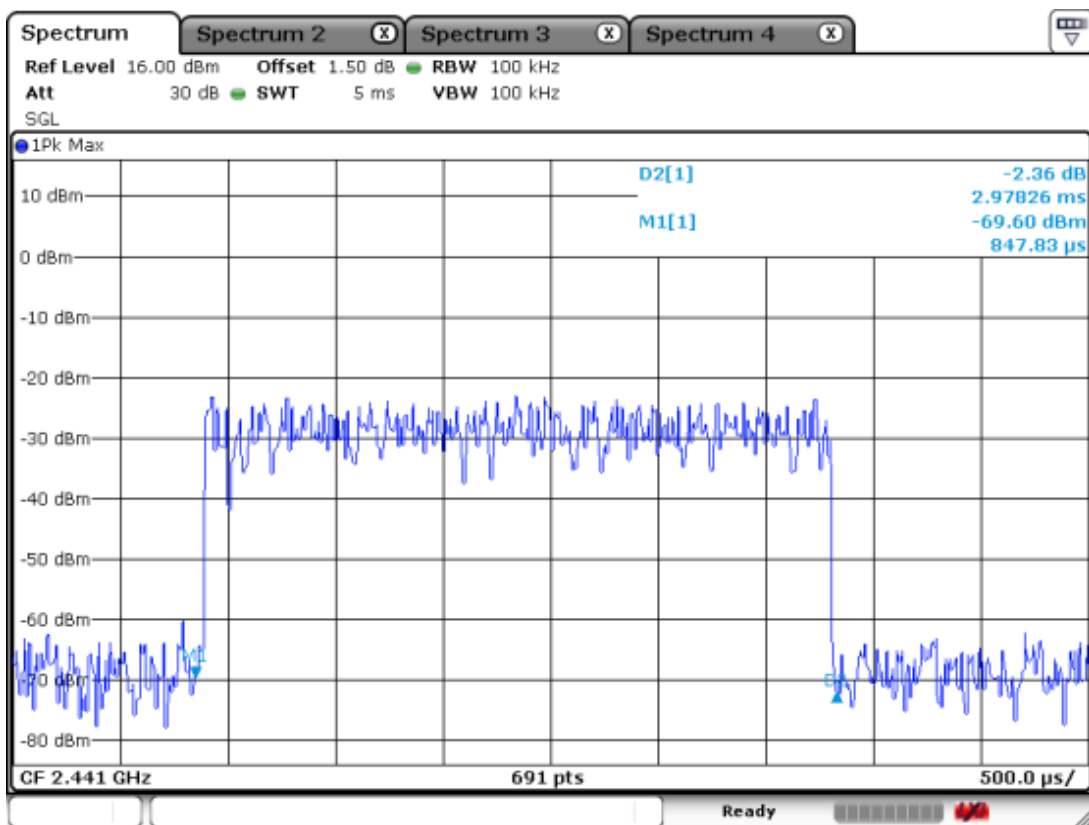

DH5 at EDR mode with 3Mbps

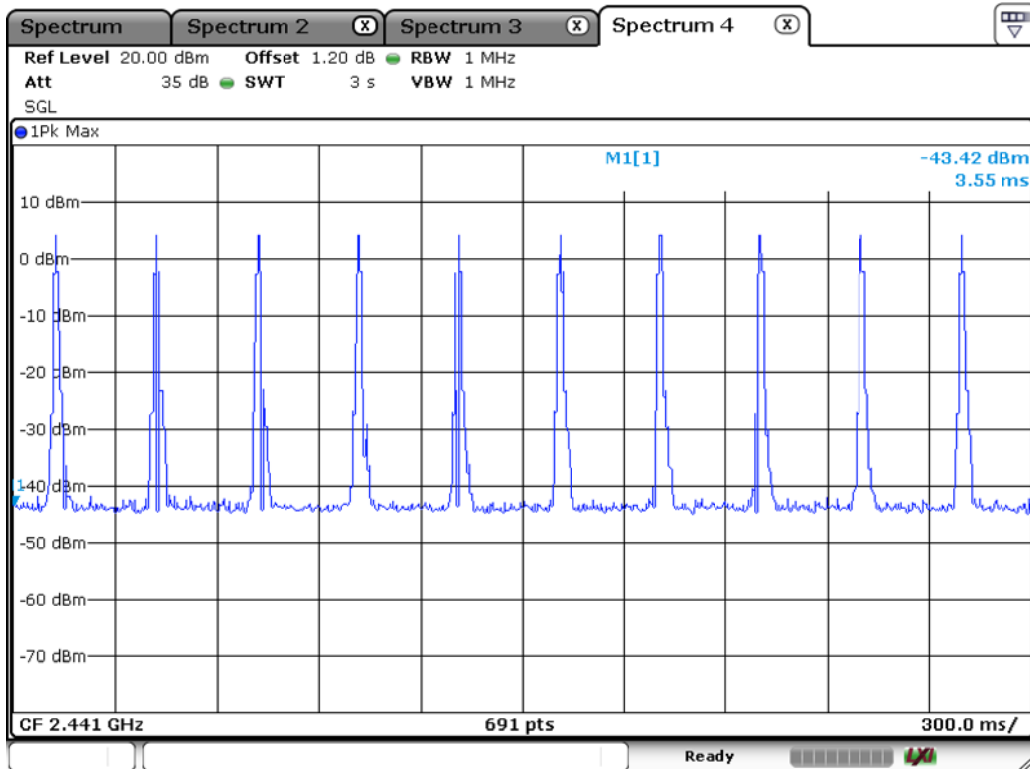
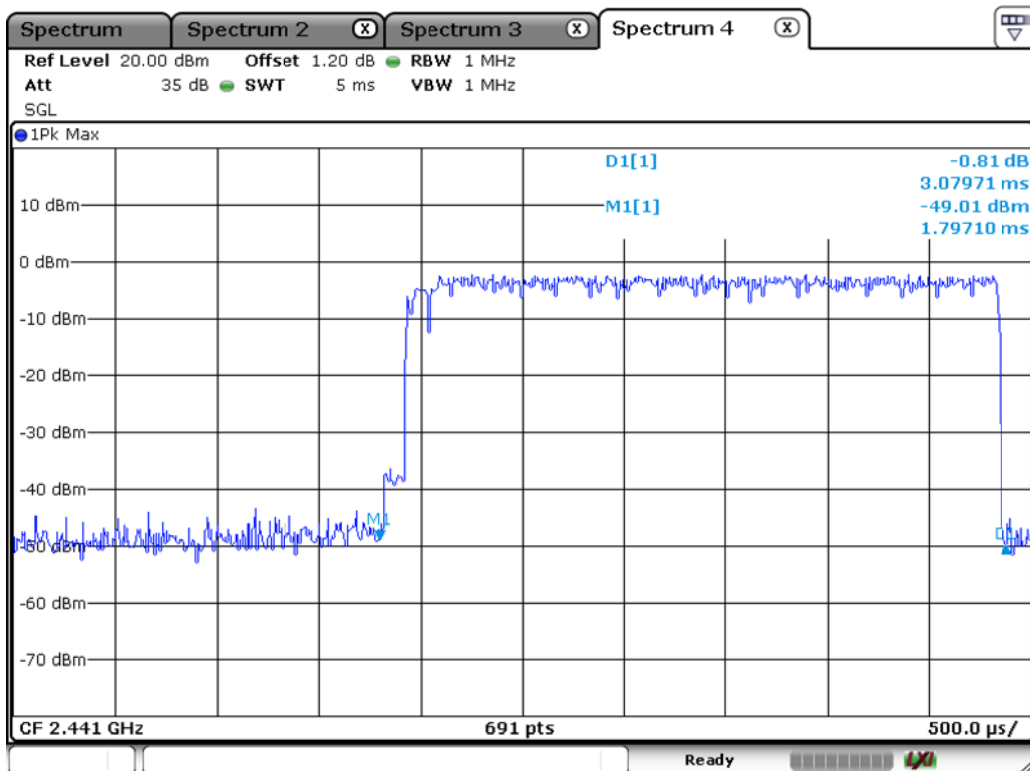

3.3.5 Transmitter Output Power

Procedure:

The test follows DA00-705. The peak output power was measured with a spectrum analyzer connected to the antenna terminal, while EUT had its hopping function disabled at the highest, middle and the lowest available channels..

After the trace being stable, Use the marker-to-peak function to set the marker to the peak of the emission. The indicated level is the peak output power.

The spectrum analyzer is set to :

Center frequency = the highest, middle and the lowest channels

Span = 10 MHz (approximately 5 times of the 20 dB bandwidth)

RBW = 3 MHz (greater than the 20dB bandwidth of the emission being measured)

VBW = 3 MHz (VBW \geq RBW)

Detector function = peak

Trace = max hold

Sweep = auto

Measurement Data : Basic Mode

| Frequency (MHz) | Ch. | Test Results | | |
|-----------------|-----|--------------|-------------|----------|
| | | dBm | mW | Result |
| 2402 | 0 | 6.69 | 4.67 | Complies |
| 2441 | 39 | 8.09 | 6.44 | Complies |
| 2480 | 78 | 9.07 | 8.07 | Complies |

Measurement Data : EDR Mode

| Frequency (MHz) | Ch. | Test Results | | |
|-----------------|-----|--------------|-------------|----------|
| | | dBm | mW | Result |
| 2402 | 0 | 5.73 | 3.74 | Complies |
| 2441 | 39 | 7.23 | 5.28 | Complies |
| 2480 | 78 | 8.57 | 7.19 | Complies |

- See next pages for actual measured spectrum plots.

| | |
|--------------------------|---|
| Minimum Standard: | For frequency hopping systems with at least 75 non-overlapping hopping channels: 1 watt. For all other frequency hopping systems: 0.125W. |
|--------------------------|---|

Measurement Setup

Same as the Chapter 3.3.1 (Figure 1)

Channel 1 Basic mode

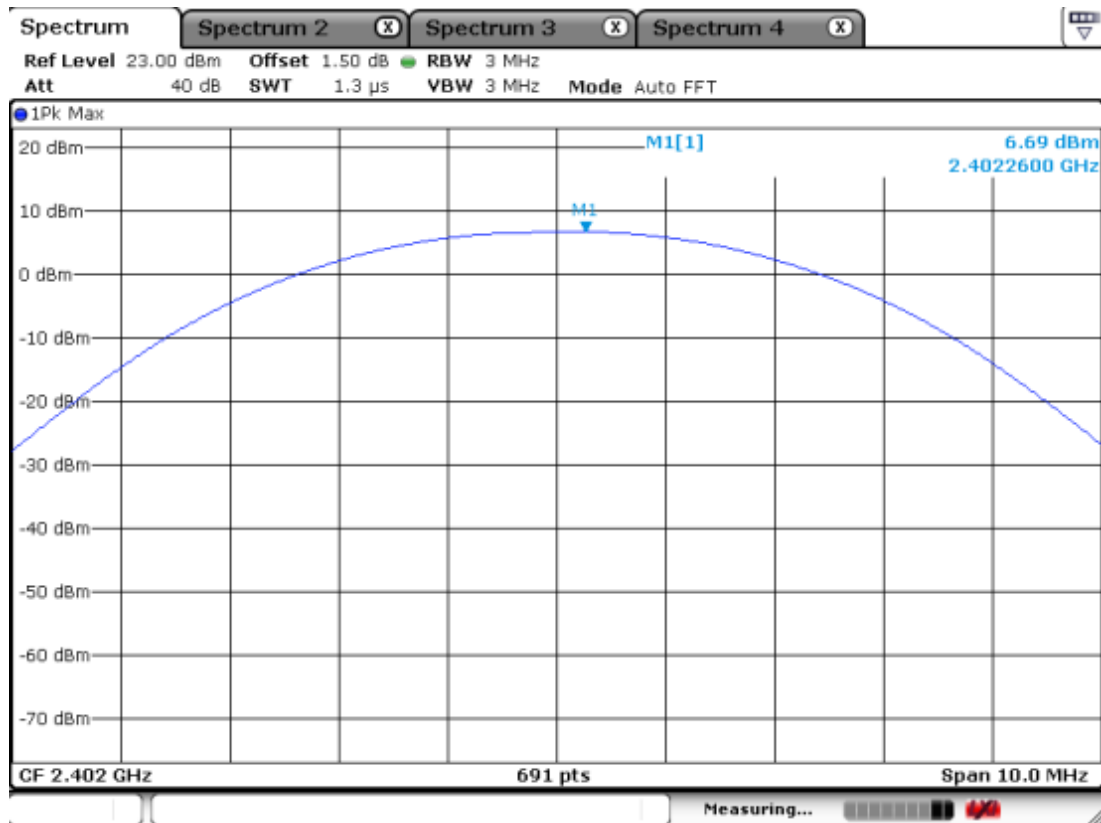

EDR mode

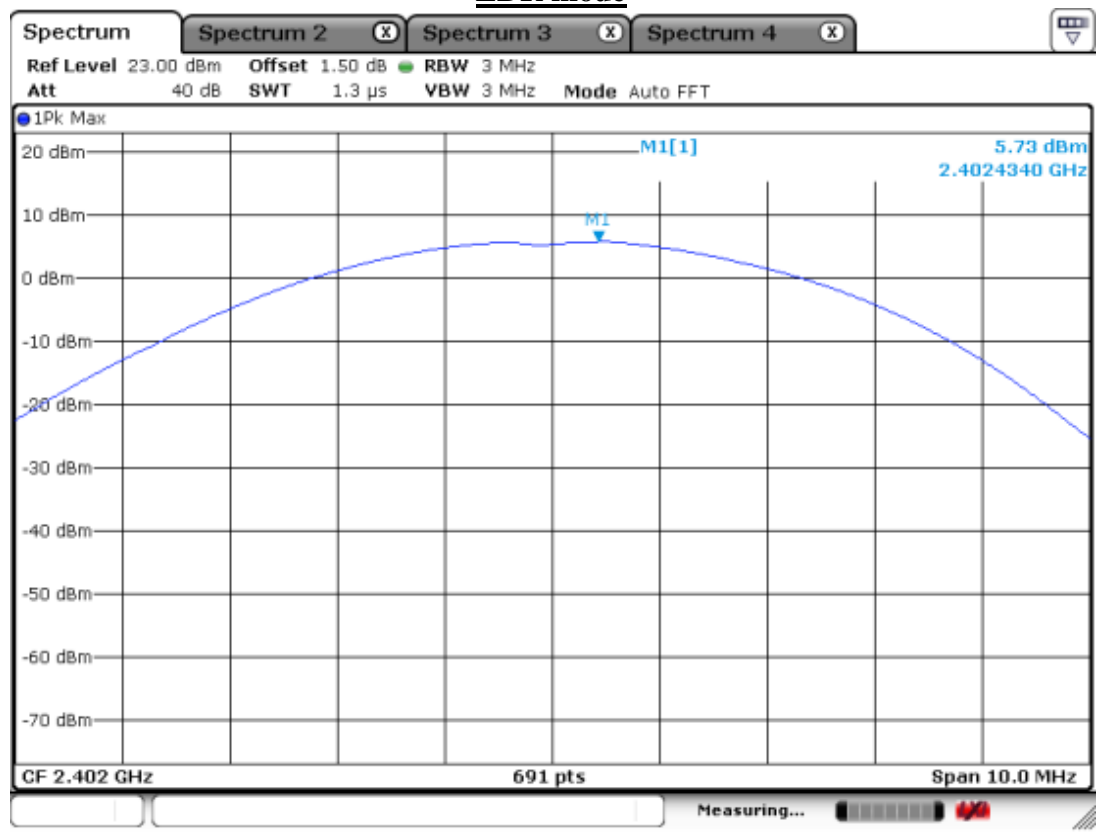

Channel 2 Basic mode

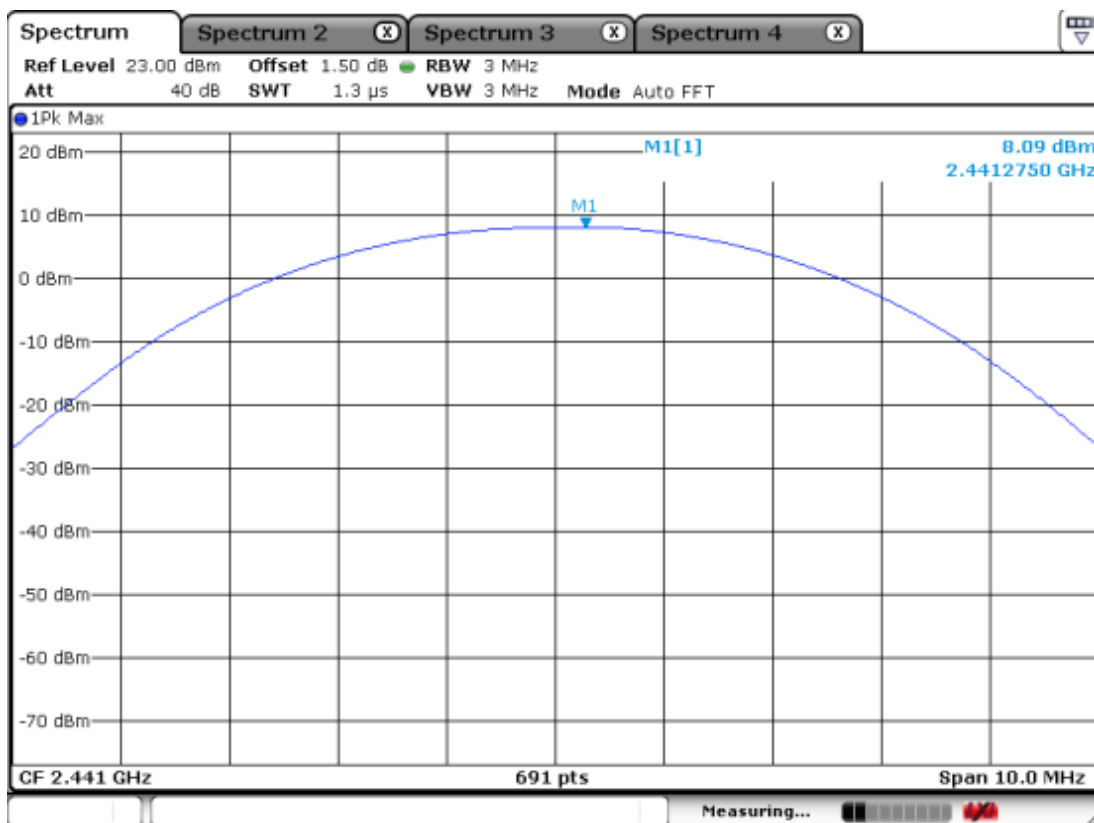

EDR mode

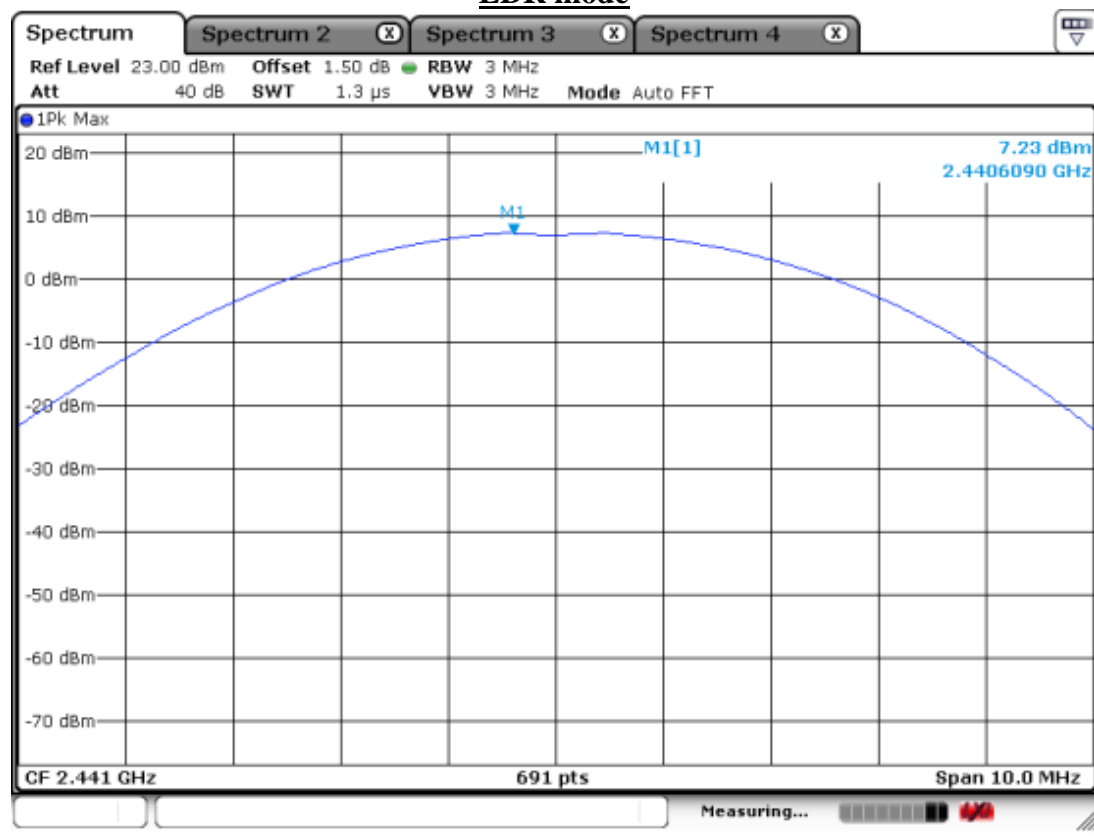

Channel 3 Basic mode

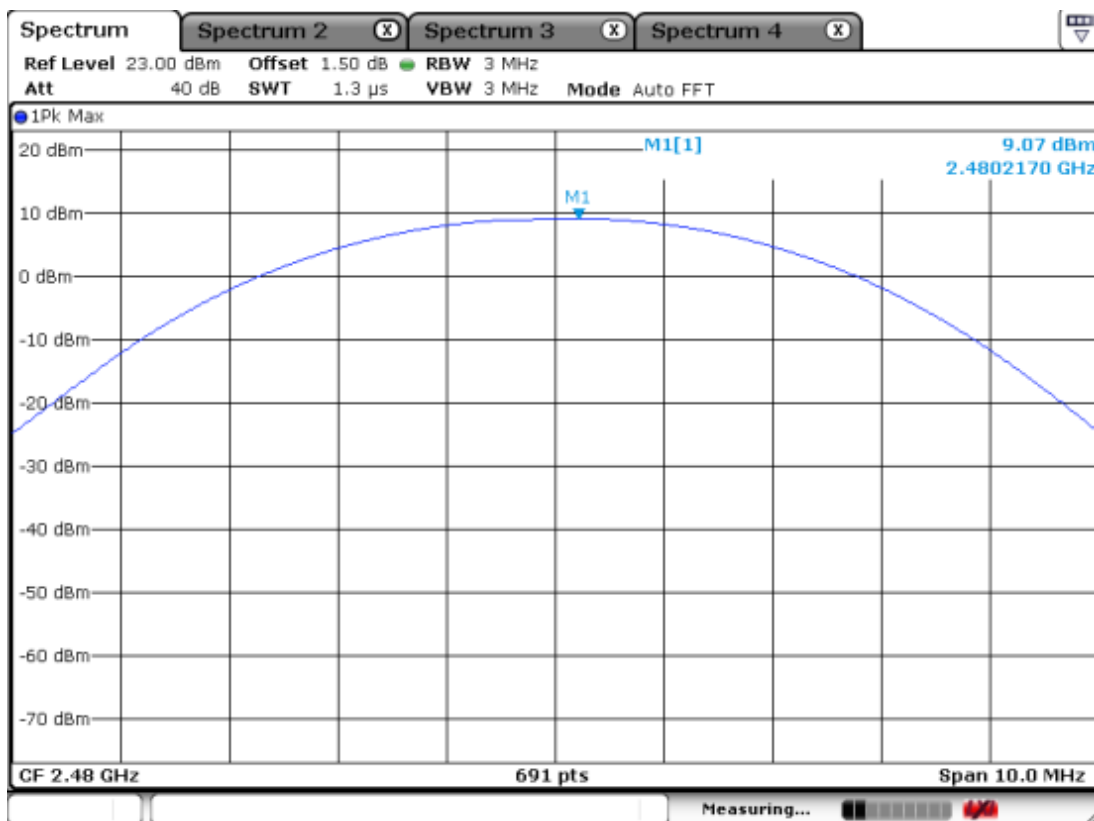

EDR mode

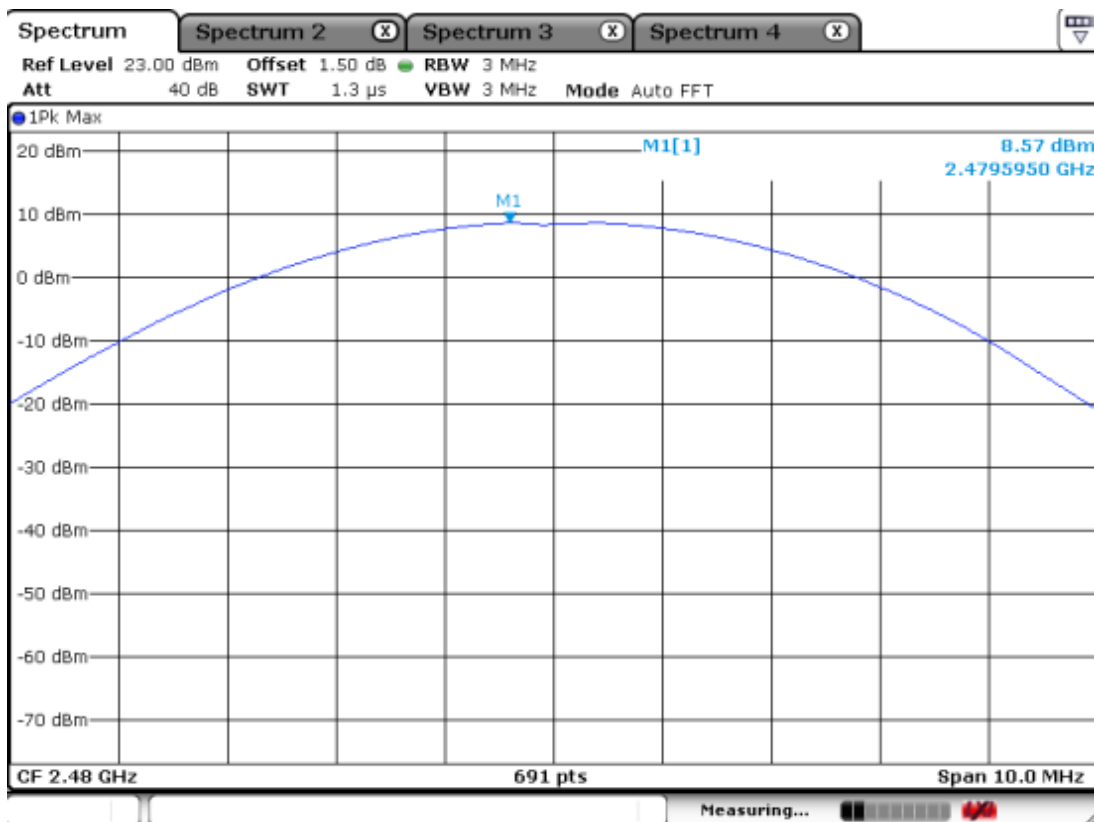

3.3.6 Band Edge

Procedure:

The bandwidth at 20dB down from the highest inband spectral density is measured with a spectrum analyzer connected to the antenna terminal, while EUT had its hopping function disabled at the highest, middle and the lowest available channels.

After the trace being stable, Use the marker-to-peak function to measure 20 dB down both sides of the intentional emission.

The spectrum analyzer is set to:

Center frequency = the highest, middle and the lowest channels

RBW = 100 kHz

VBW = 100 kHz

Span = 10~30 MHz

Detector function = peak

Trace = max hold

Sweep = auto

Measurement Data: Complies

- All conducted emission in any 100kHz bandwidth outside of the spread spectrum band was at least 20dB lower than the highest inband spectral density. Therefore the applying equipment meets the requirement.
- See next pages for actual measured spectrum plots.

| | |
|--------------------------|----------|
| Minimum Standard: | > 20 dBc |
|--------------------------|----------|

Measurement Setup

Same as the Chapter 3.3.1 (Figure 1)

Band Edge

Lower edge

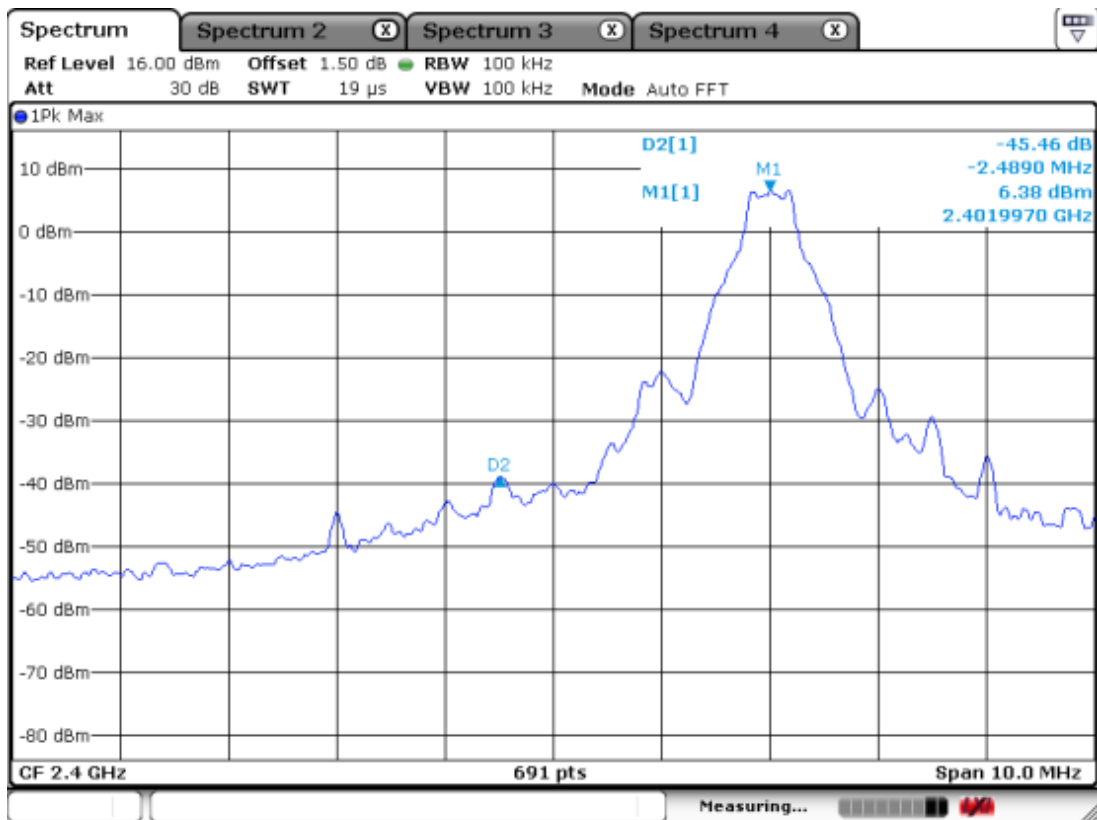

Upper edge

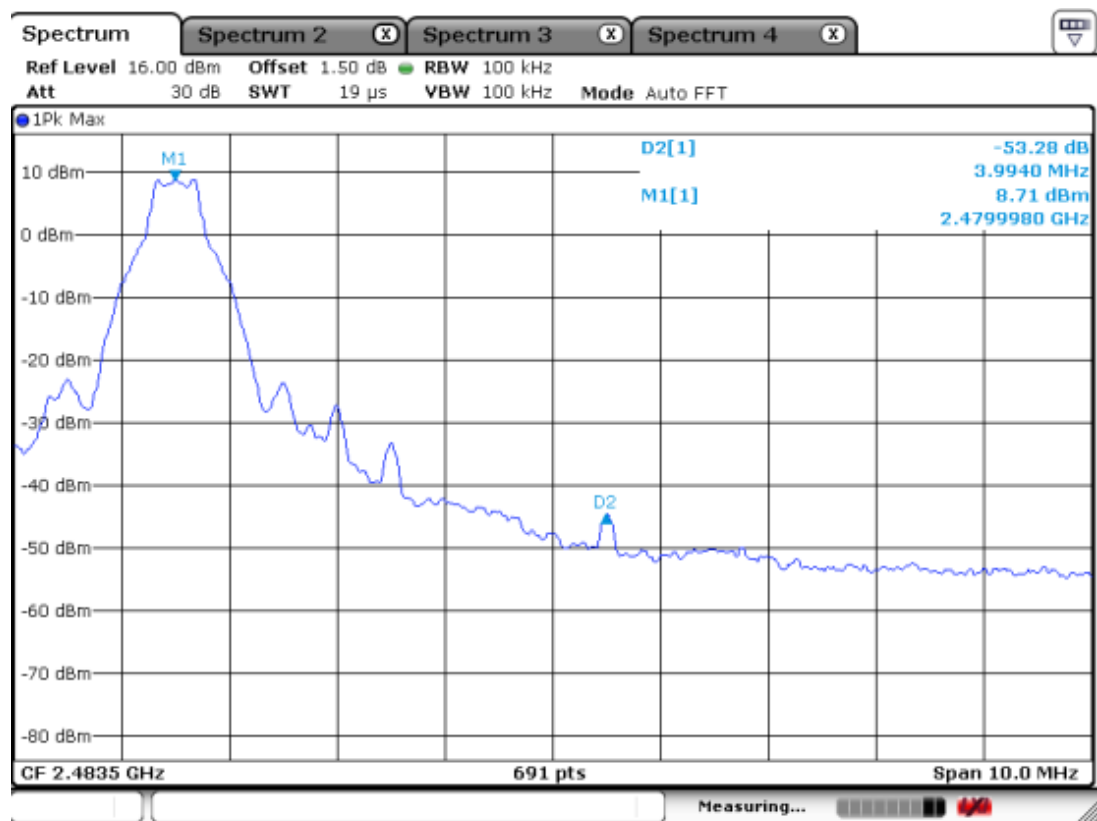

Band Edge- Hopping

Lower edge

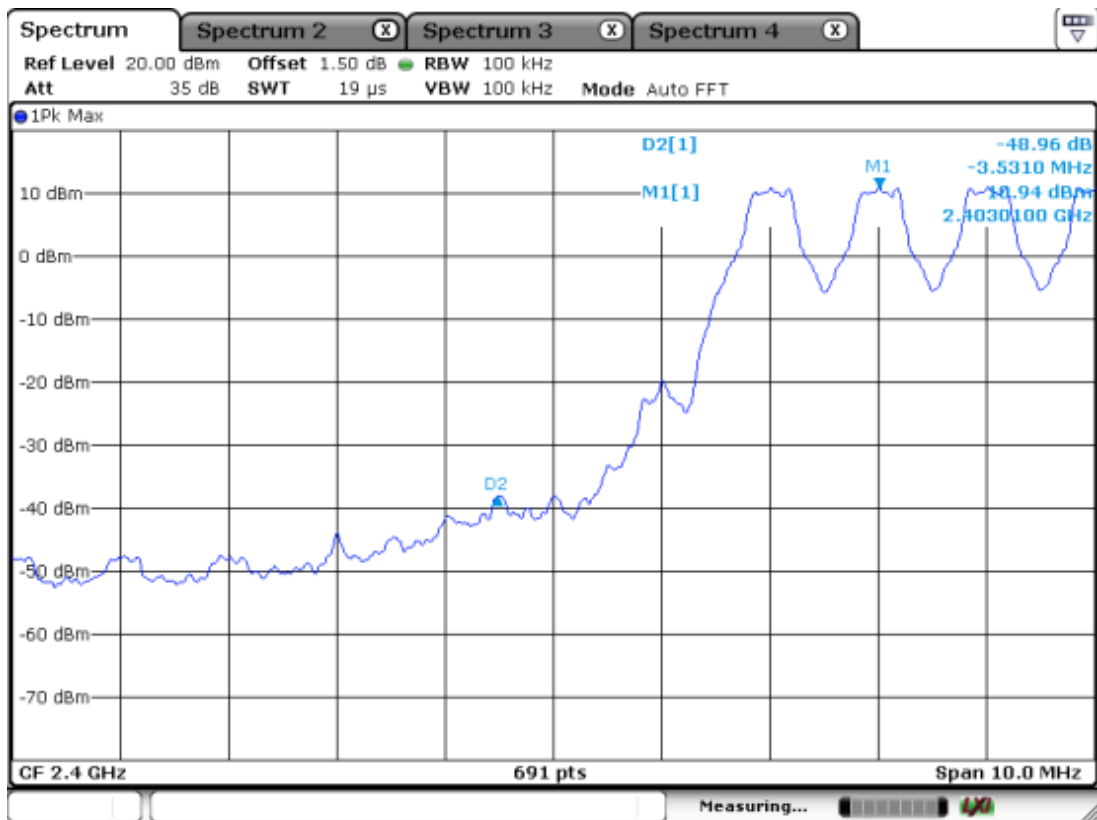

Upper edge

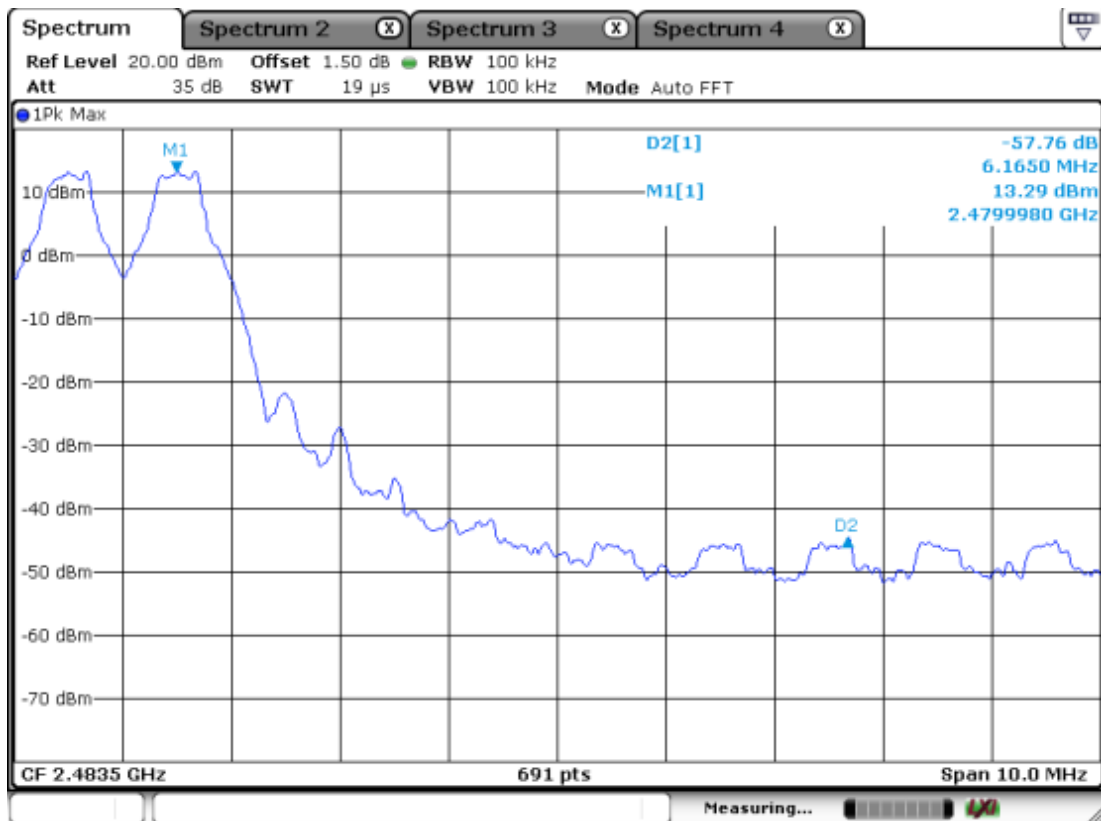

Radiated Band edges in the restricted band 2310-2390 MHz measurement

| Frequency [MHz] | Reading [dBuV/m] | | Pol. | Correction Factor | | Limits [dBuV/m] | | Result [dBuV/m] | | Margin [dB] | |
|--------------------|---------------------|------|------|----------------------|---------------------|--------------------|------|--------------------|------|----------------|------|
| | AV / Peak | | | Antenna | Amp. Gain+CableLoss | AV / Peak | | AV / Peak | | AV / Peak | |
| | | | | | | | | | | | |
| 2354.8 | 31.5 | 45.7 | V | 27.6 | 25.9 | 54.0 | 74.0 | 33.2 | 47.4 | 20.8 | 26.6 |

Radiated Band edges in the restricted band 2483.5-2500 MHz measurement

| Frequency [MHz] | Reading [dBuV/m] | | Pol. | Correction Factor | | Limits [dBuV/m] | | Result [dBuV/m] | | Margin [dB] | |
|--------------------|---------------------|------|------|----------------------|---------------------|--------------------|------|--------------------|------|----------------|------|
| | AV / Peak | | | Antenna | Amp. Gain+CableLoss | AV / Peak | | AV / Peak | | [MHz] | |
| | | | | | | | | | | | |
| 2483.5 | 33.2 | 48.6 | V | 27.5 | 26.0 | 54.0 | 74.0 | 34.7 | 50.1 | 19.3 | 23.9 |

Note : This EUT was tested in 3 orthogonal positions and the worst-case data was presented.

3.3.7 Conducted Spurious Emissions

Procedure:

The test follows DA00-705. The conducted spurious emissions were measured with a spectrum analyzer connected to the antenna terminal, while EUT had its hopping function disabled at the highest, middle and the lowest available channels..

After the trace being stable, set the marker on the peak of any spurious emission recorded.

The spectrum analyzer is set to:

Span = wide enough to capture the peak level of the in-band emission and all spurious emissions

RBW = 100 kHz

Sweep = auto

VBW = 100 kHz

Detector function = peak

Trace = max hold

Measurement Data: **Complies**

- All conducted emission in any 100kHz bandwidth outside of the spread spectrum band was at least 20dB lower than the highest inband spectral density. Therefore the applying equipment meets the requirement.
- See next pages for actual measured spectrum plots.

| | |
|--------------------------|----------|
| Minimum Standard: | > 20 dBc |
|--------------------------|----------|

Measurement Setup

Same as the Chapter 3.3.1 (Figure 1)

Unwanted Emission – Low channel
Frequency Range = 30 MHz ~ 26.5 GHz

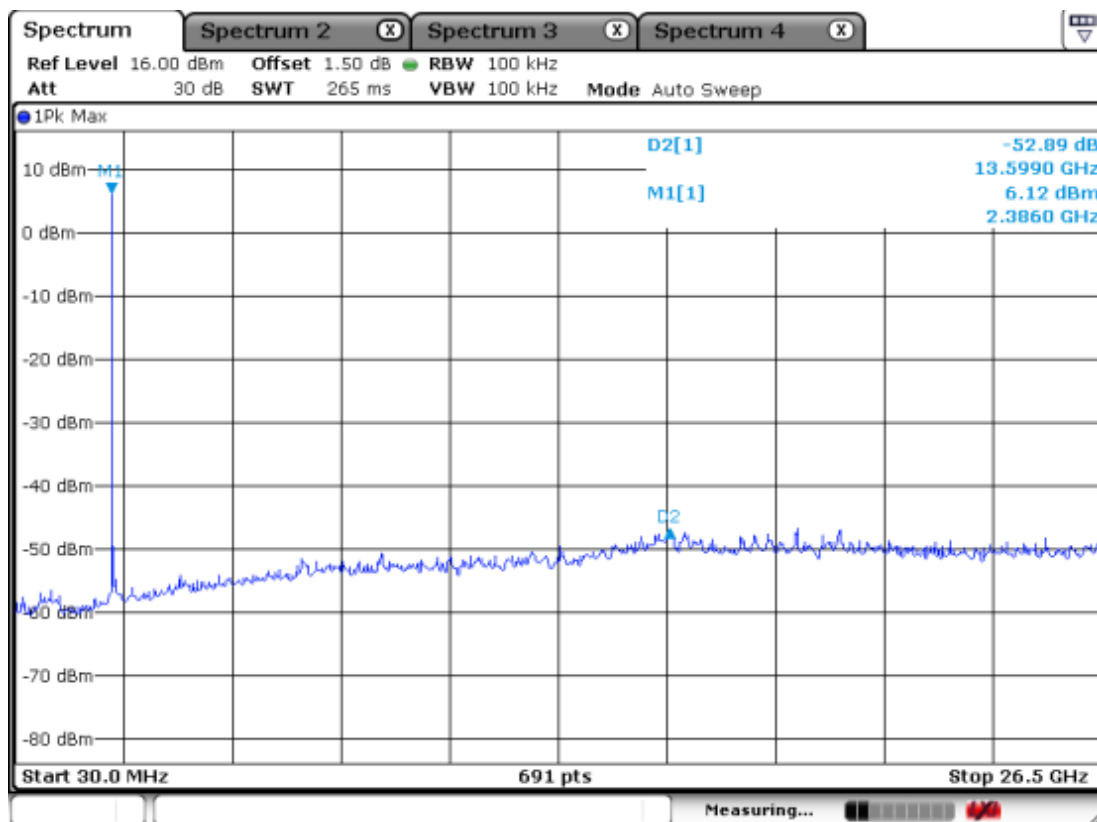

Unwanted Emission – Middle channel
Frequency Range = 30 MHz ~ 26.5 GHz

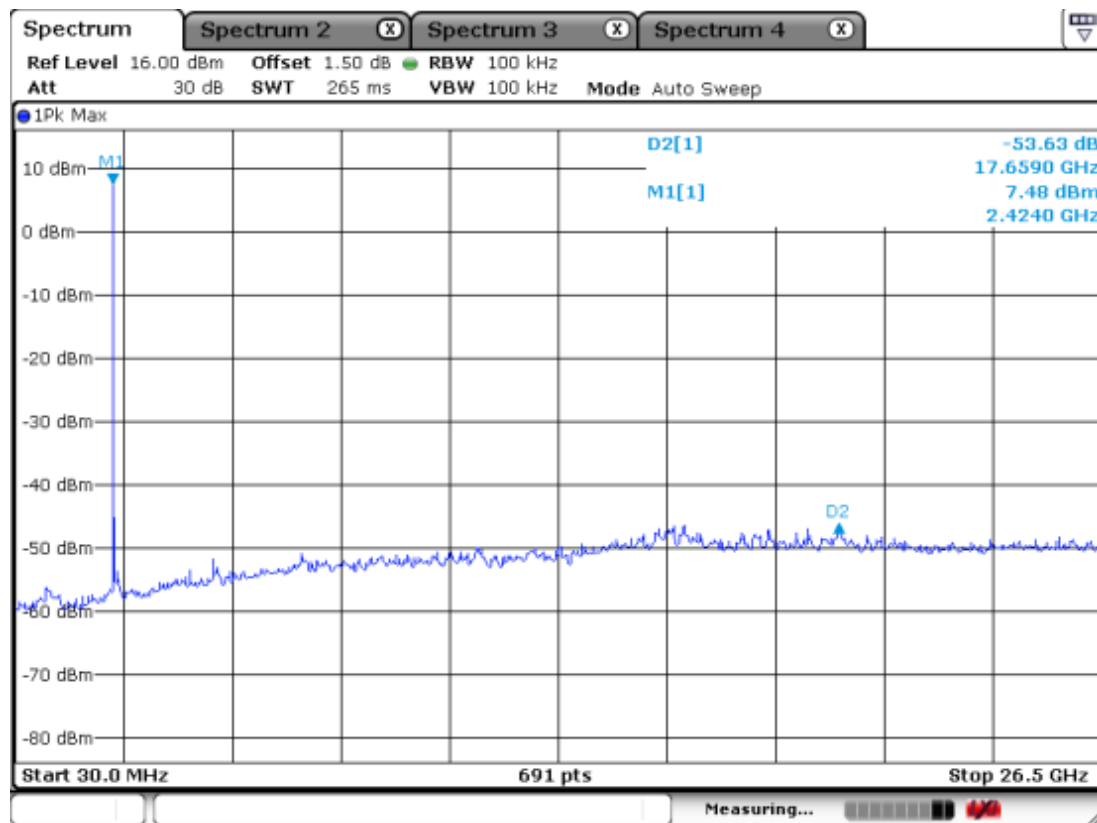

Unwanted Emission – High channel
Frequency Range = 30 MHz ~ 26.5 GHz

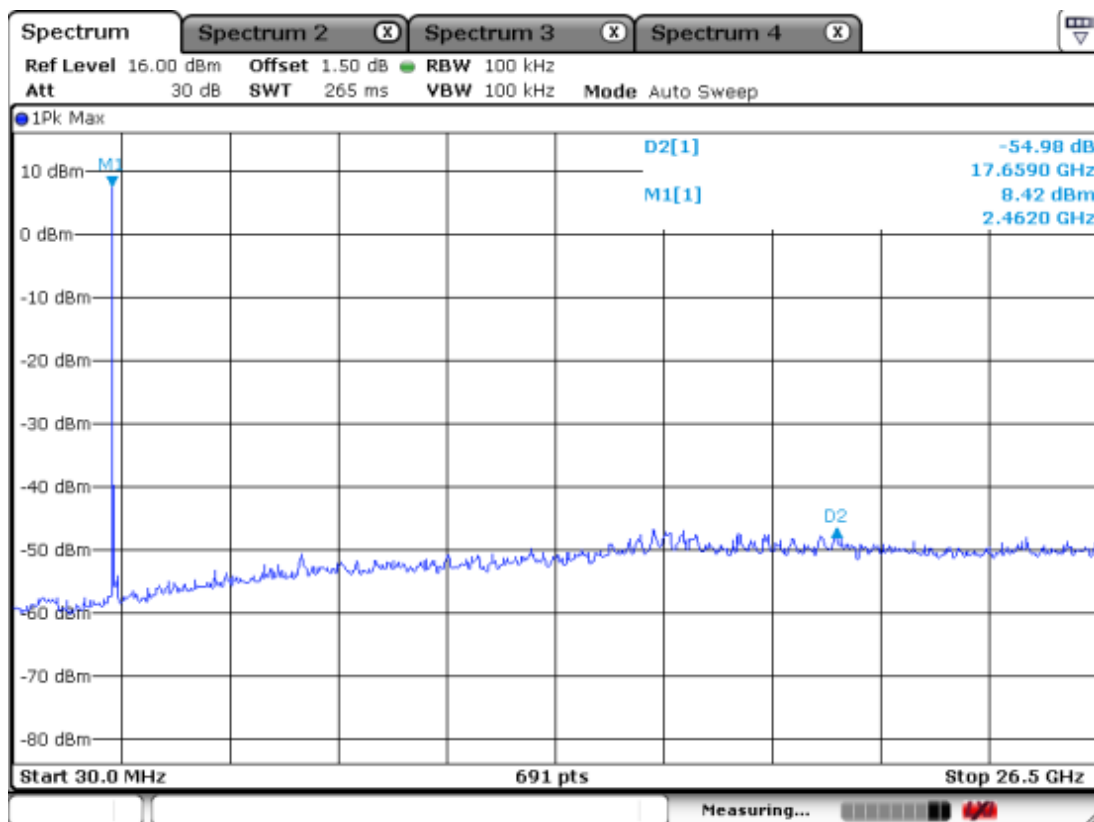

3.3.8 Radiated Spurious Emissions

Procedure:

Radiated emissions from the EUT were measured according to the dictates of DA00-705. The EUT was placed on a 0.8m high wooden table inside a shielded enclosure. An antenna was placed near the EUT and measurements of frequencies and amplitudes of field strengths were recorded for reference during final measurements. For final radiated testing, measurements were performed in OATS. Measurements were performed with the EUT oriented in 3 orthogonal axis and rotated 360 degrees to determine worst-case orientation for maximum emissions.

- (a) In the frequency range of 9kHz to 30 MHz, magnetic field is measured with Loop Test Antenna. The Test Antenna is positioned with its plane vertical at 3m distance from the EUT. The center of the Loop Test Antenna is 1m above the ground. During the measurement the Loop Test Antenna rotates about its vertical axis for maximum response at each azimuth about the EUT.
- (b) In the frequency range above 30MHz, Bi-Log Test Antenna (30MHz to 1GHz) and Horn Test Antenna (above 1GHz) are used. Test Antenna is 3m away from the EUT. Test Antenna height is carried from 1m to 4m above the ground to determine the maximum value of the field strength. The emission levels at both horizontal and vertical polarizations should be tested.

The spectrum analyzer is set to:

Center frequency = the worst channel

Frequency Range = 9 kHz ~ 10th harmonic.

RBW = 120 kHz (30MHz ~ 1 GHz)

= 1 MHz (1 GHz ~ 10th harmonic)

Span = 100 MHz

Trace = max hold

VBW \geq RBW

Detector function = peak

Sweep = auto

below 30MHz

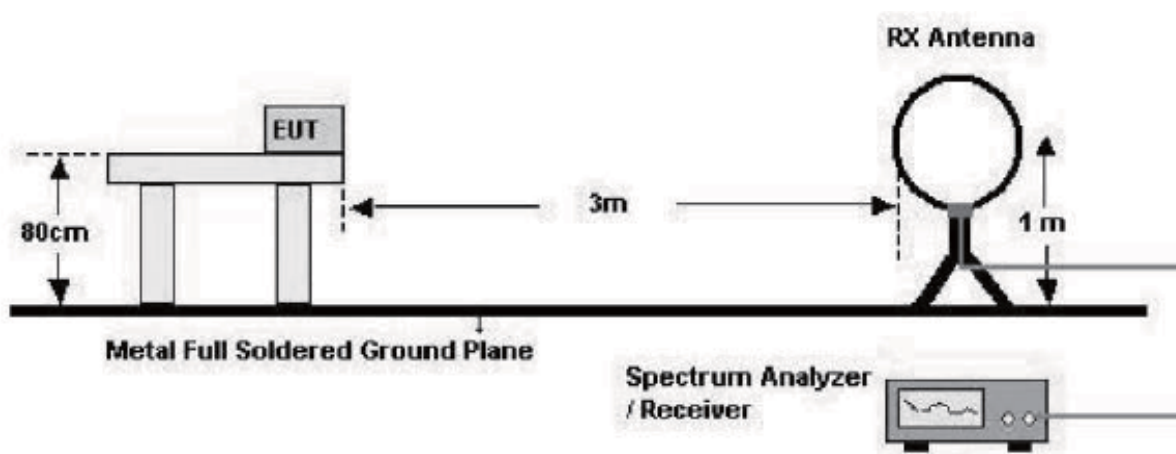

below 1GHz (30MHz to 1GHz)

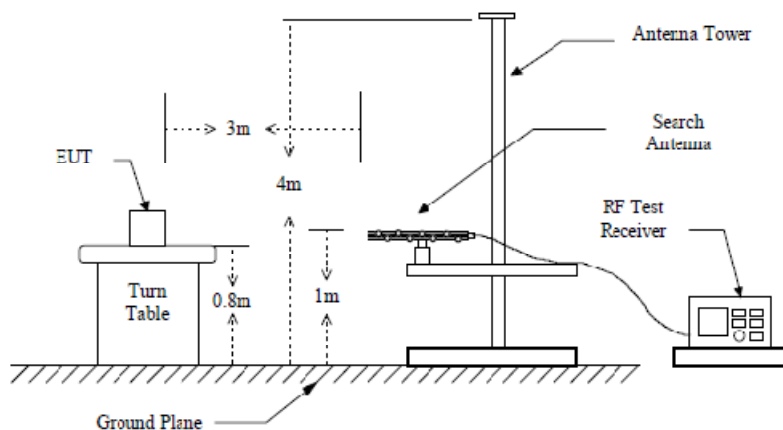

above 1GHz

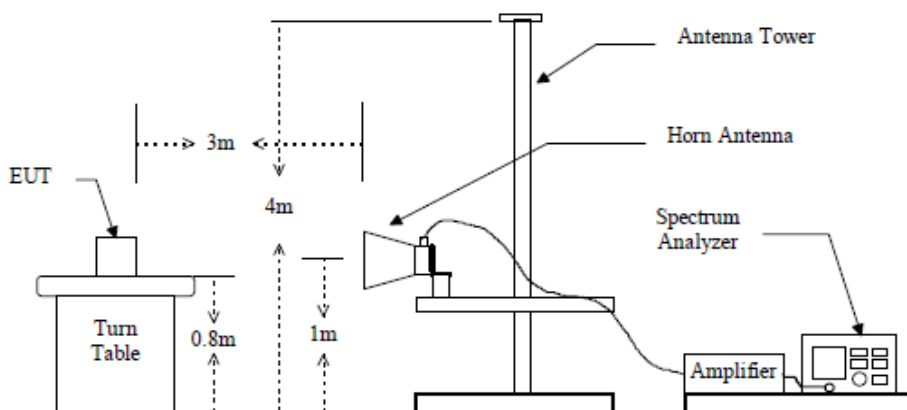

Measurement Data: **Complies**

- See next pages for actual measured data.
- No other emissions were detected at a level greater than 20dB below limit include from 9KHz to 30MHz.

Minimum Standard: FCC Part 15.209(a)

| Frequency (MHz) | Limit (uV/m) @ 3m |
|-----------------|----------------------|
| 0.009 ~ 0.490 | 2400/F(kHz) (@ 300m) |
| 0.490 ~ 1.705 | 24000/F(kHz) (@ 30m) |
| 1.705 ~ 30 | 30(@ 30m) |
| 30 ~ 88 | 100 ** |
| 88 ~ 216 | 150 ** |
| 216 ~ 960 | 200 ** |
| Above 960 | 500 |

** Except as provided in 15.209(g), fundamental emissions from intentional radiators operating under this Section shall not be located in the frequency bands 54-72 MHz, 76-88MHz, 174-216MHz or 470-806MHz. However, operation within these frequency bands is permitted under other sections of this Part, e.g. 15.231 and 15.241.

Measurement Data :

| Frequency [MHz] | Reading [dBuV/m] | | Pol. | Correction Factor | | D.C.F | Limits [dBuV/m] | | Result [dBuV/m] | | Margin [dB] | |
|--------------------|---------------------|------|------|----------------------|----------------|--------|--------------------|------|--------------------|------|----------------|------|
| | AV / Peak | | | Antenna | Amp.Gain+Cable | | AV/Peak | | AV/Peak | | AV / Peak | |
| | | | | | | | | | | | | |
| 2719 | 32.0 | 45.3 | V | 29.2 | 24.5 | -30.23 | 54.0 | 74.0 | 6.5 | 19.8 | 47.5 | 54.2 |
| - | - | - | - | - | - | - | - | - | - | - | - | - |
| - | - | - | - | - | - | - | - | - | - | - | - | - |
| - | - | - | - | - | - | - | - | - | - | - | - | - |
| Frequency [MHz] | Reading [dBuV/m] | | Pol. | Correction Factor | | D.C.F | Limits [dBuV/m] | | Result [dBuV/m] | | Margin [dB] | |
| | AV / Peak | | | Antenna | Amp.Gain+Cable | | AV/Peak | | AV/Peak | | AV / Peak | |
| | | | | | | | | | | | | |
| 2545 | 34.8 | 47.1 | V | 27.7 | 25.3 | -30.23 | 54.0 | 74.0 | 7.0 | 19.3 | 47.0 | 54.7 |
| - | - | - | - | - | - | - | - | - | - | - | - | - |
| - | - | - | - | - | - | - | - | - | - | - | - | - |
| - | - | - | - | - | - | - | - | - | - | - | - | - |
| Frequency [MHz] | Reading [dBuV/m] | | Pol. | Correction Factor | | D.C.F | Limits [dBuV/m] | | Result [dBuV/m] | | Margin [dB] | |
| | AV / Peak | | | Antenna | Amp.Gain+Cable | | AV/Peak | | AV/Peak | | AV / Peak | |
| | | | | | | | | | | | | |
| 2506 | 35.3 | 48.5 | V | 27.7 | 25.3 | -30.23 | 54.0 | 74.0 | 7.5 | 20.7 | 46.5 | 53.3 |
| - | - | - | - | - | - | - | - | - | - | - | - | - |
| - | - | - | - | - | - | - | - | - | - | - | - | - |
| - | - | - | - | - | - | - | - | - | - | - | - | - |

- No other emissions were detected at a level greater than 20dB below limit.

- D.C.F (Duty Cycle Correction Factor) = $20\log(\text{The worst Case DWELL Time}/100\text{ms})$

$$= 20\log(3.080\text{ms}/100\text{ms}) = -30.23$$

Radiated Emissions – Bluetooth mode



4, Songjuro236Beon-gil, Yangji-myeon,
Cheoin-gu, Youngin-si, Gyeonggi-do,
449-822 Korea
Tel :+82-31-3236008,9
Fax:+82-31-3236010

EUT/Model No.: Snowtalk TEST MODE: Bluetooth mode
Temp Humi : 23 / 27 Tested by: SIN J H

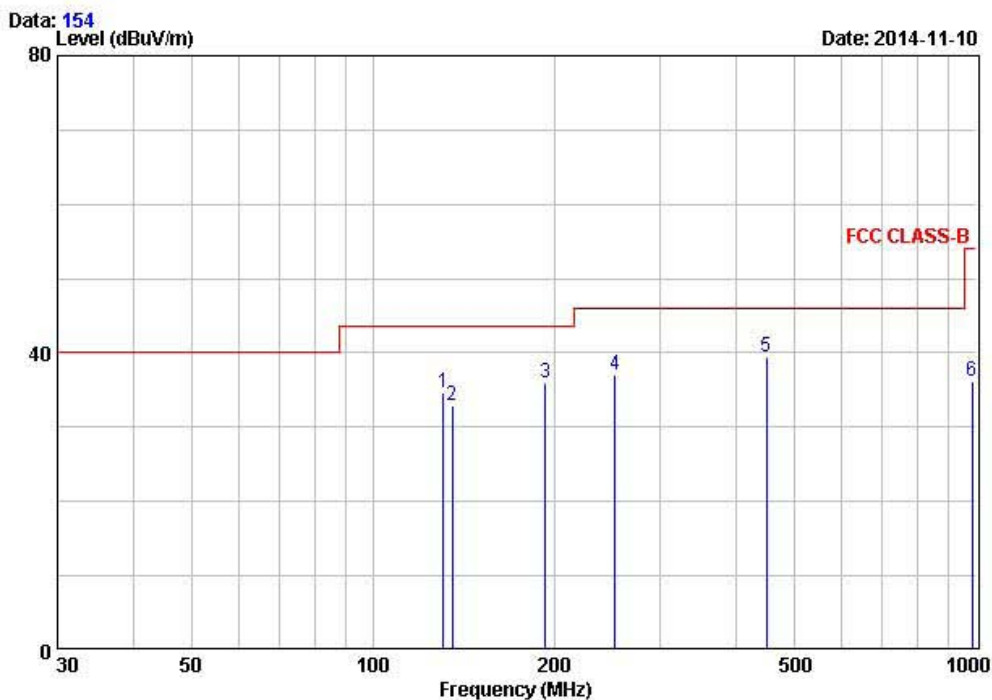

| Peak | Freq MHz | Reading dBuV/m | C.F dB/m | Result dBuV/m | Limit QP dBuV/m | Margin dB | Height cm | Angle deg | Polarity |
|------|-------------|-------------------|-------------|------------------|-----------------------|--------------|--------------|--------------|------------|
| 1 | 130.76 | 50.20 | -15.63 | 34.57 | 43.50 | 8.93 | 170 | 253 | HORIZONTAL |
| 2 | 135.62 | 48.20 | -15.30 | 32.90 | 43.50 | 10.60 | 143 | 132 | HORIZONTAL |
| 3 | 193.54 | 53.20 | -17.19 | 36.01 | 43.50 | 7.49 | 152 | 174 | HORIZONTAL |
| 4 | 252.42 | 53.30 | -16.30 | 37.00 | 46.00 | 9.00 | 100 | 21 | VERTICAL |
| 5 | 449.62 | 48.20 | -8.70 | 39.50 | 46.00 | 6.50 | 153 | 214 | HORIZONTAL |
| 6 | 985.26 | 34.20 | 2.05 | 36.25 | 54.00 | 17.75 | 100 | 174 | HORIZONTAL |

Remarks: C.F (Correction Factor) = Antenna factor + Cable loss - Preamp gain

3.3.9 Conducted & Radiated Spurious Emissions – Receivers

Definition:

The field strength of emissions from intentional radiators was measured. In case of the air temperature of the test site is out of the range is 10 to 40°C before the testing proceeds the warm-up time of EUT maintain adequately

| | |
|---------------------|--|
| Test method | : FCC Part 15.209 |
| Frequency Range | : 30 MHz ~ 10 th harmonic. |
| Bandwidth | : 100 kHz (F < 1GHz) 1 MHz (F > 1GHz) |
| Distance of antenna | : 3 meters |
| Test mode | : BT Rx mode |
| Result | : Complies |

Measurement Data:

- Refer to the next page.
- No other emissions were detected at a level greater than 20dB below limit
- It gave the worse case emissions.

Field Strength Limit

Part 15.209 LIMIT:

| Frequency (MHz) | Limit (uV/m) @ 3m |
|-----------------|-------------------|
| 0.009 ~ 0.490 | 2400/F(kHz) |
| 0.490 ~ 1.705 | 24000/F(kHz) |
| 1.705 ~ 30 | 30 |
| 30 ~ 88 | 100 ** |
| 88 ~ 216 | 150 ** |
| 216 ~ 960 | 200 ** |
| Above 960 | 500 |

** Except as provided in 15.209(g), fundamental emissions from intentional radiators operating under this Section shall not be located in the frequency bands 54-72 MHz, 76-88MHz, 174-216MHz or 470-806MHz. However, operation within these frequency bands is permitted under other sections of this Part, e.g. 15.231 and 15.241.

Conducted Emission – Low channel
Frequency Range = 30 MHz ~ 26.5 GHz

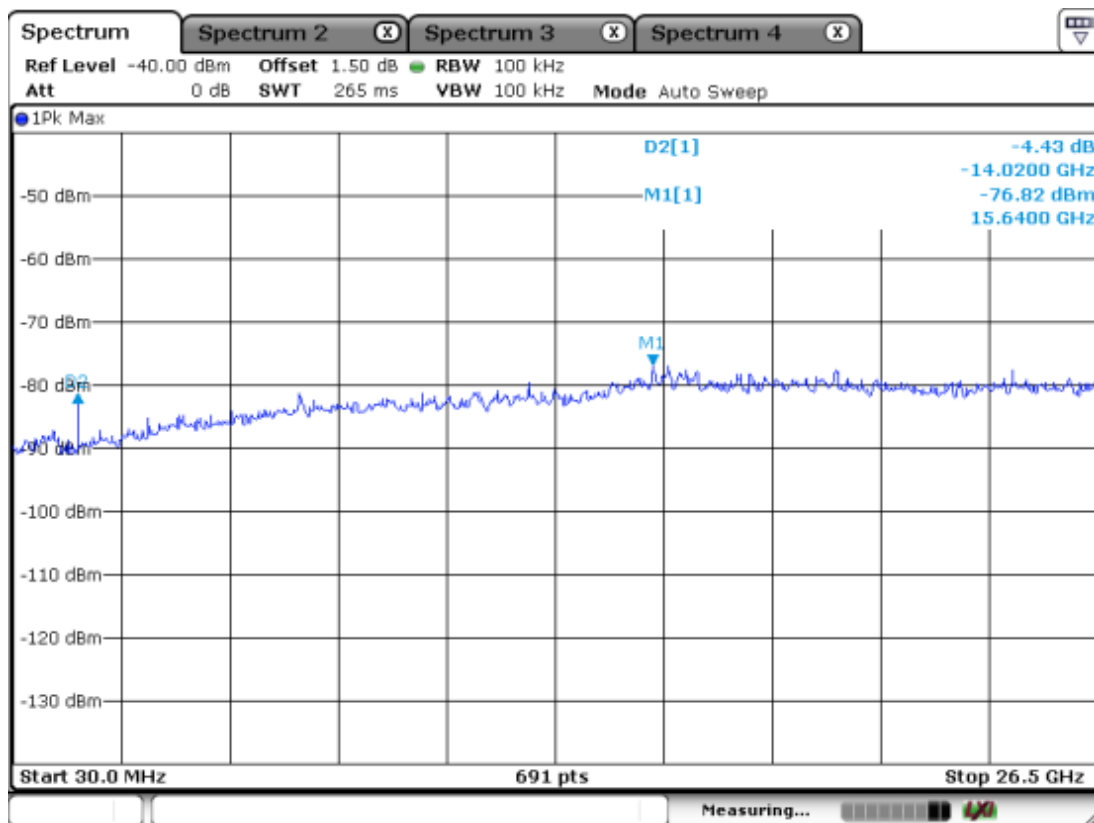

Conduceted Emission – Middle channel
Frequency Range = 30 MHz ~ 26.5 GHz

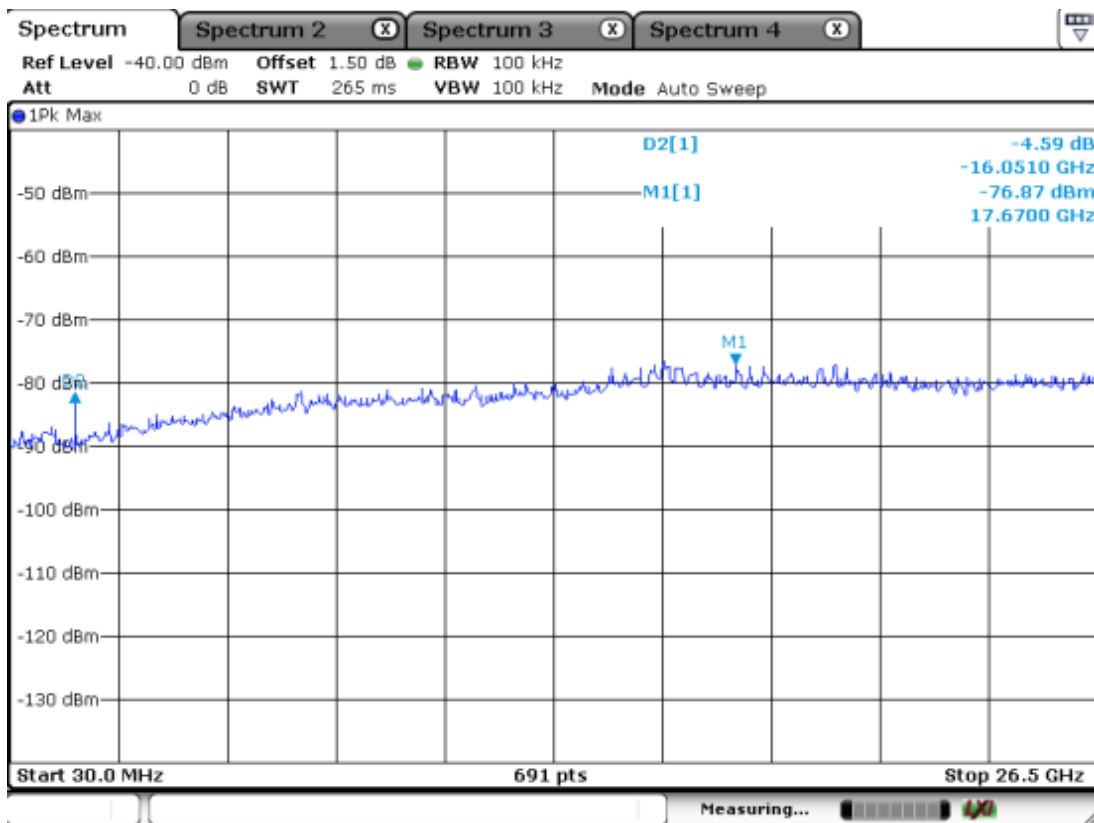

Conducted Emission – High channel
Frequency Range = 30 MHz ~ 26.5 GHz

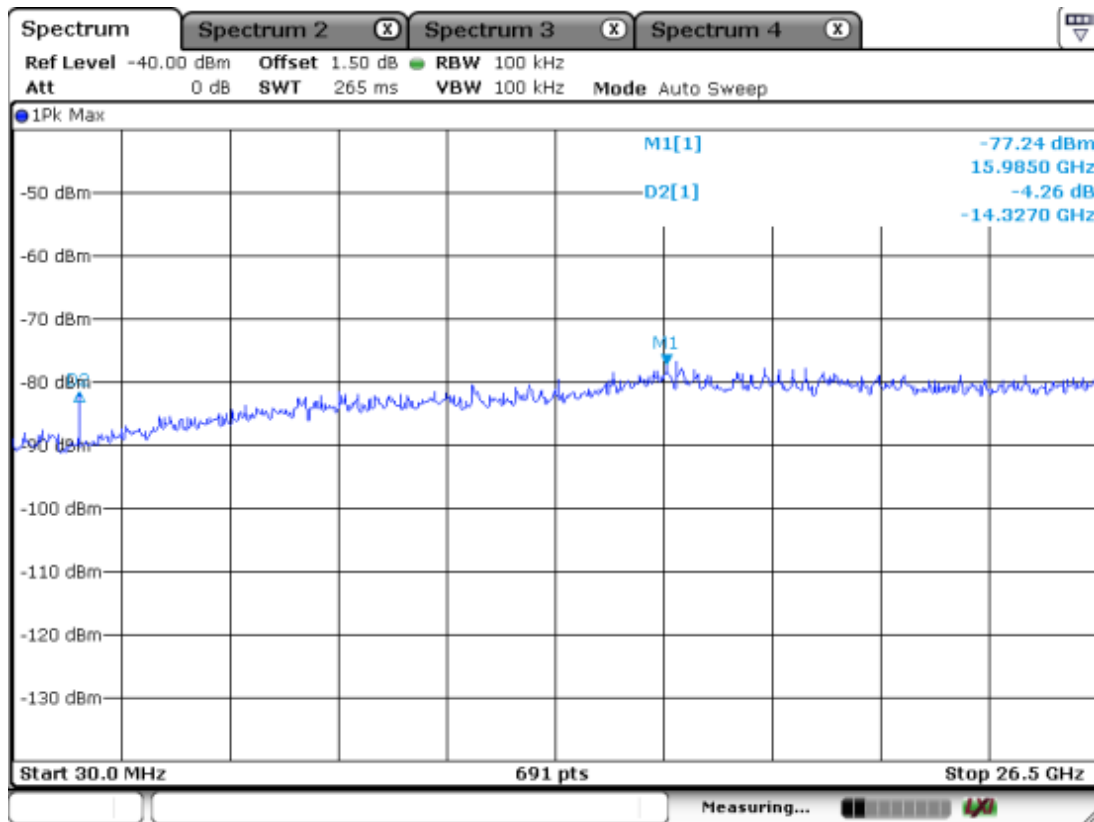

Measurement Data: BT mode

| Frequency [MHz] | Reading [dBuV/m] | | Pol. | Correction Factor | | Limits [dBuV/m] | | Result [dBuV/m] | | Margin [dB] | |
|---|---------------------|---|------|----------------------|---------------------|--------------------|---|--------------------|---|----------------|---|
| | AV / Peak | | | Antenna | Amp. Gain +Cable | AV / Peak | | AV / Peak | | AV / Peak | |
| - | - | - | - | - | - | - | - | - | - | - | - |
| No emissions were detected at a level greater than 20 dB below limit. | | | | | | | | | | | |
| - | - | - | - | - | - | - | - | - | - | - | - |
| - | - | - | - | - | - | - | - | - | - | - | - |
| Frequency [MHz] | Reading [dBuV/m] | | Pol. | Correction Factor | | Limits [dBuV/m] | | Result [dBuV/m] | | Margin [dB] | |
| | AV / Peak | | | Antenna | Amp. Gain +Cable | AV / Peak | | AV / Peak | | AV / Peak | |
| - | - | - | - | - | - | - | - | - | - | - | - |
| No emissions were detected at a level greater than 20 dB below limit. | | | | | | | | | | | |
| - | - | - | - | - | - | - | - | - | - | - | - |
| - | - | - | - | - | - | - | - | - | - | - | - |
| Frequency [MHz] | Reading [dBuV/m] | | Pol. | Correction Factor | | Limits [dBuV/m] | | Result [dBuV/m] | | Margin [dB] | |
| | AV / Peak | | | Antenna | Amp. Gain +Cable | AV / Peak | | AV / Peak | | AV / Peak | |
| - | - | - | - | - | - | - | - | - | - | - | - |
| No emissions were detected at a level greater than 20 dB below limit. | | | | | | | | | | | |
| - | - | - | - | - | - | - | - | - | - | - | - |
| - | - | - | - | - | - | - | - | - | - | - | - |

No other emissions were detected at a level greater than 20dB below limit.

3.3.9 AC Conducted Emissions

Procedure:

AC power line conducted emissions from the EUT were measured according to the dictates of ANSI C63.4:2003.

The conducted emissions are measured in the shielded room with a spectrum analyzer in peak hold. While the measurement, EUT had its hopping function disabled at the middle channels in line with Section 15.31(m). Emissions closest to the limit are measured in the quasi-peak mode (QP) with the tuned receiver using a bandwidth of 9 kHz. The emissions are maximized further by cable manipulation and Exerciser operation. The highest emissions relative to the limit are listed.

Measurement Data: Complies

- Refer to the next page.
- No other emissions were detected at a level greater than 20dB below limit
- It gave the worse case emissions

Minimum Standard: FCC Part 15.207(a)/EN 55022

| Frequency Range (MHz) | Conducted Limit (dBuV) | |
|--------------------------|------------------------|------------|
| | Quasi-Peak | Average |
| 0.15 ~ 0.5 | 66 to 56 * | 56 to 46 * |
| 0.5 ~ 5 | 56 | 46 |
| 5 ~ 30 | 60 | 50 |

* Note: The limits will decrease with the frequency logarithmically within 0.15MHz to 0.5MHz

Conducted Emissions – Bluetooth mode – LINE



4, Songjuro236Beon-gil, Yangji-myeon
Cheoin-gu, Youngin-si, Gyeonggi-do
449-822 Korea
Tel :+82-31-3236008,9
Fax:+82-31-3236010

RUT / Model No. : Snowtalk Phase : LINE
 Test Mode : Bluetooth mode Test Power : 120 / 60
 Temp./Humi. : 25 / 40 Test Engineer : SIN J H

Data: 186 File: C:\Conducted Data\2014\LTA_Conduction_1411-1.EMI (228) Date: 11-10-2014

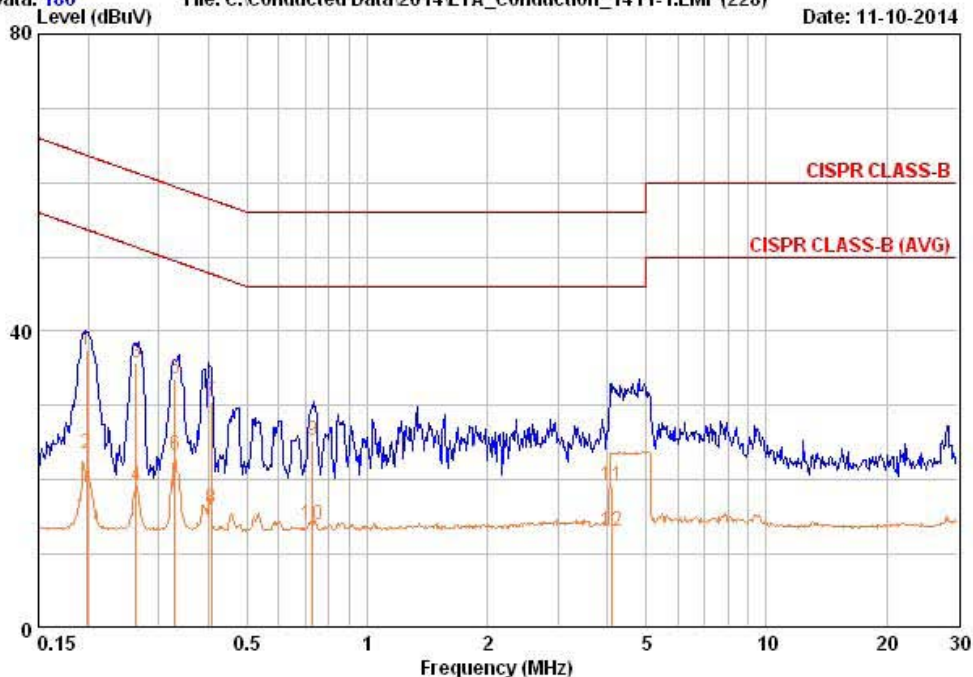

| Freq MHz | RD | | C.F dB | Result | | Limit | | Margin | |
|-------------|------------|------------|-----------|------------|------------|------------|------------|----------|----------|
| | QP dBuV | AV dBuV | | QP dBuV | AV dBuV | QP dBuV | AV dBuV | QP dB | AV dB |
| 0.198 | 27.85 | 13.85 | 9.73 | 37.58 | 23.58 | 63.69 | 53.69 | 26.12 | 30.12 |
| 0.264 | 26.16 | 9.46 | 9.68 | 35.84 | 19.14 | 61.30 | 51.30 | 25.46 | 32.16 |
| 0.330 | 23.86 | 13.76 | 9.64 | 33.50 | 23.40 | 59.45 | 49.45 | 25.95 | 26.05 |
| 0.406 | 20.85 | 6.45 | 9.60 | 30.45 | 16.05 | 57.73 | 47.73 | 27.28 | 31.68 |
| 0.730 | 15.56 | 4.36 | 9.66 | 25.22 | 14.02 | 56.00 | 46.00 | 30.78 | 31.98 |
| 4.114 | 9.40 | 3.40 | 9.68 | 19.08 | 13.08 | 56.00 | 46.00 | 36.92 | 32.92 |

Remarks: C.F (Correction Factor) = Insertion loss + Cable loss

Conducted Emissions Bluetooth mode – NEUTRAL



4, Songjuro236Beon-gil, Yangji-myeon
Cheoin-gu, Youngin-si, Gyeonggi-do
449-822 Korea
Tel :+82-31-3236008,9
Fax:+82-31-3236010

RUT / Model No. : Snowtalk Phase : NEUTRAL
 Test Mode : Bluetooth mode Test Power : 120 / 60
 Temp./Humi. : 25 / 40 Test Engineer : SIN J H

Data: 188 File: C:\Conducted Data\2014\LTA_Conduction_1411-1.EMI (228) Date: 11-10-2014

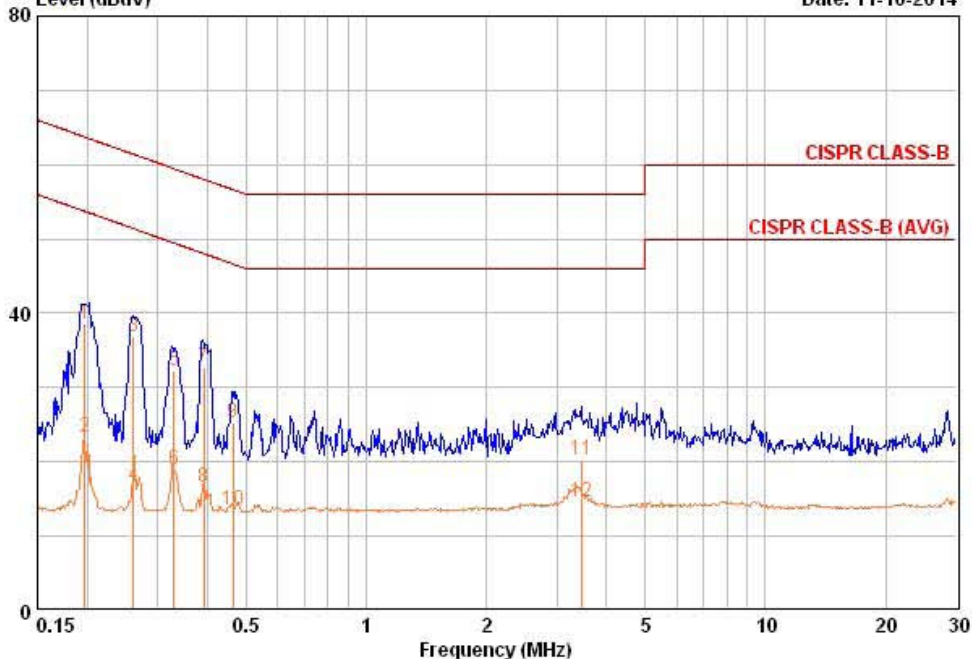

| Freq MHz | RD | | C.F | Result | | Limit | | Margin | |
|-------------|------------|------------|------|------------|------------|------------|------------|----------|----------|
| | QP dBuV | AV dBuV | | QP dBuV | AV dBuV | QP dBuV | AV dBuV | QP dB | AV dB |
| 0.197 | 28.95 | 13.65 | 9.73 | 38.68 | 23.38 | 63.74 | 53.74 | 25.05 | 30.35 |
| 0.261 | 27.26 | 7.06 | 9.69 | 36.94 | 16.74 | 61.40 | 51.40 | 24.46 | 34.66 |
| 0.329 | 22.66 | 9.36 | 9.65 | 32.31 | 19.01 | 59.48 | 49.48 | 27.17 | 30.47 |
| 0.391 | 23.15 | 6.85 | 9.62 | 32.77 | 16.47 | 58.04 | 48.04 | 25.27 | 31.57 |
| 0.463 | 15.64 | 3.84 | 9.59 | 25.24 | 13.44 | 56.64 | 46.64 | 31.40 | 33.20 |
| 3.471 | 10.49 | 4.89 | 9.69 | 20.18 | 14.58 | 56.00 | 46.00 | 35.82 | 31.42 |

Remarks: C.F (Correction Factor) = Insertion loss + Cable loss

APPENDIX

TEST EQUIPMENT USED FOR TESTS

| | Description | Model No. | Serial No. | Manufacturer | Interval | Last Cal. Date |
|----|--------------------------------------|------------------|-------------|------------------------|----------|----------------|
| 1 | Signal Analyzer (9kHz~30GHz) | FSV-30 | 100757 | R&S | 1 year | 2014-01-16 |
| 2 | Signal Generator (~3.2GHz) | 8648C | 3623A02597 | HP | 1 year | 2014-03-25 |
| 3 | SYNTHESIZED CW GENERATOR | 83711B | US34490456 | HP | 1 year | 2014-03-25 |
| 4 | Attenuator (3dB) | 8491A | 37822 | HP | 1 year | 2014-09-16 |
| 5 | Attenuator (10dB) | 8491A | 63196 | HP | 1 year | 2014-09-16 |
| 6 | Test Receiver (~30MHz) | ESHS10 | 828404/009 | R&S | 1 year | 2014-03-25 |
| 7 | EMI Test Receiver (~7GHz) | ESCI7 | 100722 | R&S | 1 year | 2014-09-15 |
| 8 | RF Amplifier (~1.3GHz) | 8447D OPT 010 | 2944A07684 | HP | 1 year | 2014-09-16 |
| 9 | RF Amplifier (1~26.5GHz) | 8449B | 3008A02126 | HP | 1 year | 2014-03-25 |
| 10 | Horn Antenna (1~18GHz) | 3115 | 00114105 | ETS | 2 year | 2013-05-13 |
| 11 | DRG Horn (Small) | 3116B | 81109 | ETS-Lindgren | 2 year | 2014-02-26 |
| 12 | DRG Horn (Small) | 3116B | 133350 | ETS-Lindgren | 2 year | 2014-02-26 |
| 13 | TRILOG Antenna | VULB 9160 | 9160-3237 | SCHWARZBECK | 2 year | 2013-05-14 |
| 14 | Temp.Humidity Data Logger | SK-L200TH II A | 00801 | SATO | 1 year | 2014-04-03 |
| 15 | Splitter (SMA) | ZFSC-2-2500 | SF617800326 | Mini-Circuits | - | - |
| 16 | Power Divider | 11636A | 06243 | HP | 1 year | 2014-09-16 |
| 17 | DC Power Supply | 6674A | 3637A01657 | Agilent | - | - |
| 18 | Frequency Counter | 5342A | 2826A12411 | HP | 1 year | 2014-03-25 |
| 19 | Power Meter | EPM-441A | GB32481702 | HP | 1 year | 2014-03-25 |
| 20 | Power Sensor | 8481A | 3318A99464 | HP | 1 year | 2014-01-17 |
| 21 | Audio Analyzer | 8903B | 3729A18901 | HP | 1 year | 2014-09-15 |
| 22 | Modulation Analyzer | 8901B | 3749A05878 | HP | 1 year | 2014-09-15 |
| 23 | TEMP & HUMIDITY Chamber | YJ-500 | LTAS06041 | JinYoung Tech | 1 year | 2014-09-16 |
| 24 | Stop Watch | HS-3 | 812Q08R | CASIO | 2 year | 2014-04-03 |
| 25 | LISN | KNW-407 | 8-1430-1 | Kyoritsu | 1 year | 2014-09-15 |
| 26 | Two-Lime V-Network | ESH3-Z5 | 893045/017 | R&S | 1 year | 2014-03-26 |
| 27 | UNIVERSAL RADIO COMMUNICATION TESTER | CMU200 | 106243 | R&S | 1 year | 2014-07-11 |
| 28 | Highpass Filter | WHKX1.5/15G-10SS | 74 | Wainwright Instruments | - | - |
| 29 | Highpass Filter | WHKX3.0/18G-10SS | 118 | Wainwright Instruments | - | - |
| 30 | Active Loop Antenna | FMZB1519 | 1519-031 | SCHWARZBECK | 1 year | 2014-01-07 |
| 31 | OSP120 BASE UNIT | OSP120 | 101230 | R&S | 1 year | 2014-08-20 |
| 32 | Signal Generator(100kHz~40GHz) | SMB100A03 | 177621 | R&S | 1 year | 2014-08-20 |
| 33 | Signal Analyzer (10Hz~40GHz) | FSV40 | 101367 | R&S | 1 year | 2014-08-20 |