

AC Line Conducted Emissions (Graph) = Modulation : GFSK model : IW05-DC

Results of Conducted Emission

DT&C
Date : 2016-10-20

Order No.	: DTNC1609-05603	Power Supply	: 120V 60Hz
Serial No.	: Identical prototype	Temp/Humi/Atm	: 23 °C 44 % R.H.
Model No.	: IW05-DC	Operator	: J.W.Kim
Test Condition	: Bluetooth_1Mbps		

memo : chip antenna

LIMIT : CISPR32_B QP
CISPR32_B AV

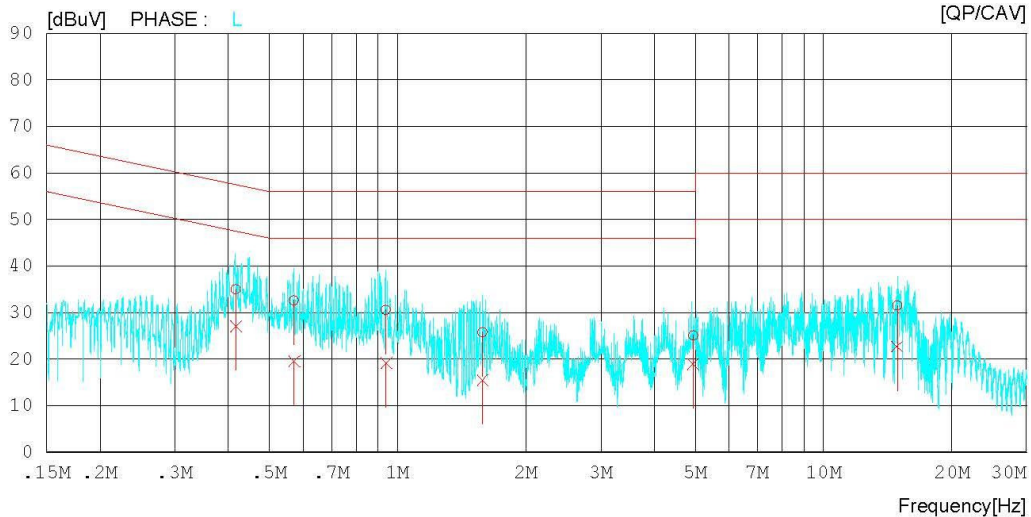
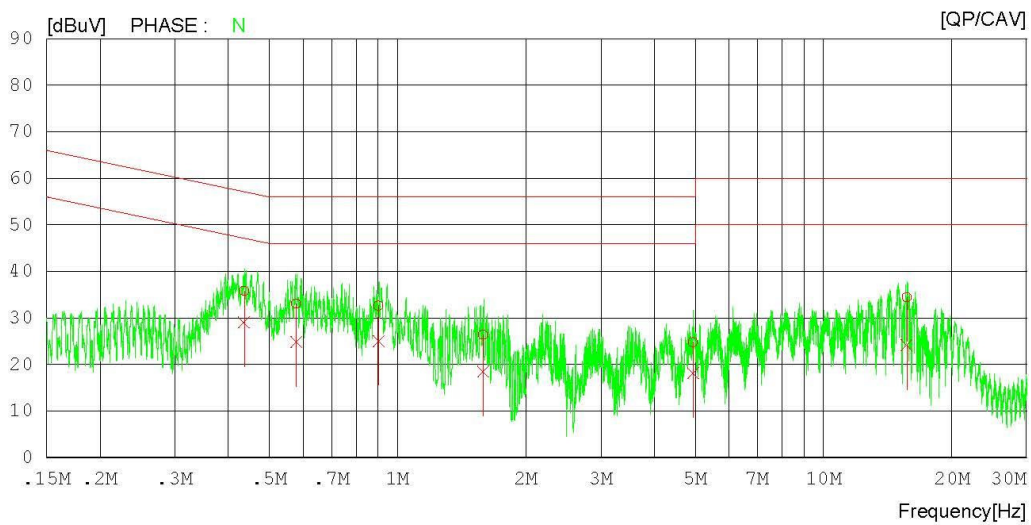

AC Line Conducted Emissions (List) = Modulation : GFSK model : IW05-DC

Results of Conducted Emission

 DT&C
 Date : 2016-10-20

Order No. : DTNC1609-05603	Power Supply : 120V 60Hz
Serial No. : Identical prototype	Temp/Humi/Atm : 23°C 44 % R.H.
Model No. : IW05-DC	Operator : J.W.Kim
Test Condition : Bluetooth_1Mbps	

memo : chip antenna

 LIMIT : CISPR32_B QP
 CISPR32_B AV

NO	FREQ [MHz]	READING		C.FACTOR [dB]	RESULT		LIMIT		MARGIN		PHASE
		QP [dBuV]	CAV [dBuV]		QP [dBuV]	CAV [dBuV]	QP [dBuV]	CAV [dBuV]	QP [dBuV]	CAV [dBuV]	
1	0.43584	34.99	28.24	0.81	35.80	29.05	57.14	47.14	21.34	18.09	N
2	0.57773	32.50	24.21	0.60	33.10	24.81	56.00	46.00	22.90	21.19	N
3	0.90184	32.21	24.62	0.43	32.64	25.05	56.00	46.00	23.36	20.95	N
4	1.58600	26.00	18.14	0.35	26.35	18.49	56.00	46.00	29.65	27.51	N
5	4.93960	24.49	17.78	0.34	24.83	18.12	56.00	46.00	31.17	27.88	N
6	15.66480	33.95	23.67	0.49	34.44	24.16	60.00	50.00	25.56	25.84	N
7	0.41732	34.13	26.17	0.87	35.00	27.04	57.50	47.50	22.50	20.46	L
8	0.57124	31.94	18.86	0.63	32.57	19.49	56.00	46.00	23.43	26.51	L
9	0.93918	30.10	18.63	0.45	30.55	19.08	56.00	46.00	25.45	26.92	L
10	1.58320	25.31	15.06	0.38	25.69	15.44	56.00	46.00	30.31	30.56	L
11	4.94240	24.64	18.47	0.38	25.02	18.85	56.00	46.00	30.98	27.15	L
12	14.88300	30.90	22.21	0.47	31.37	22.68	60.00	50.00	28.63	27.32	L

AC Line Conducted Emissions (Graph) = Modulation : GFSK model : IW05-DU

Results of Conducted Emission

DT&C
Date : 2016-10-20

Order No.	: DTNC1609-05603	Power Supply	: 120V 60Hz
Serial No.	: Identical prototype	Temp/Humi/Atm	: 23°C 44 % R.H.
Model No.	: IW05-DU	Operator	: J.W.Kim
Test Condition	: Bluetooth_1Mbps		

memo : UFL type

LIMIT : CISPR32_B QP
CISPR32_B AV

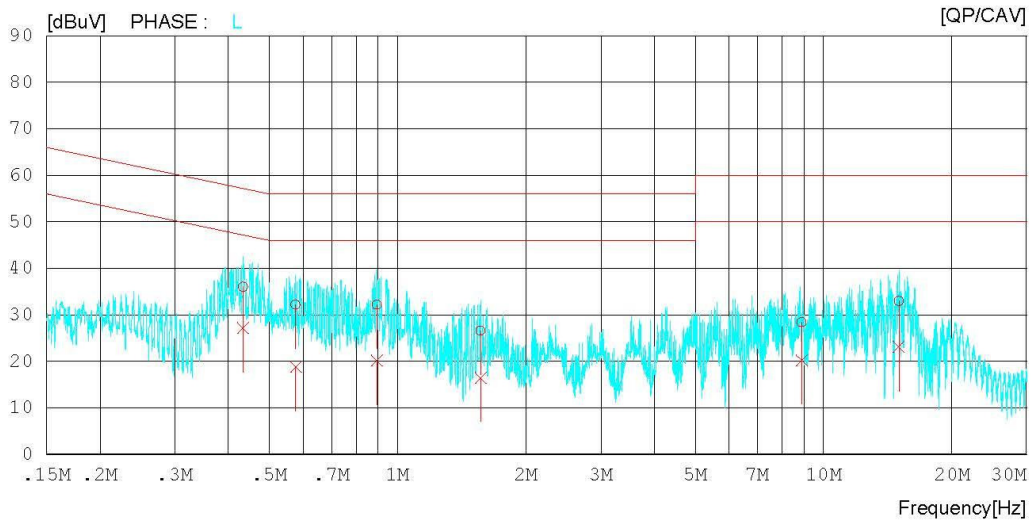
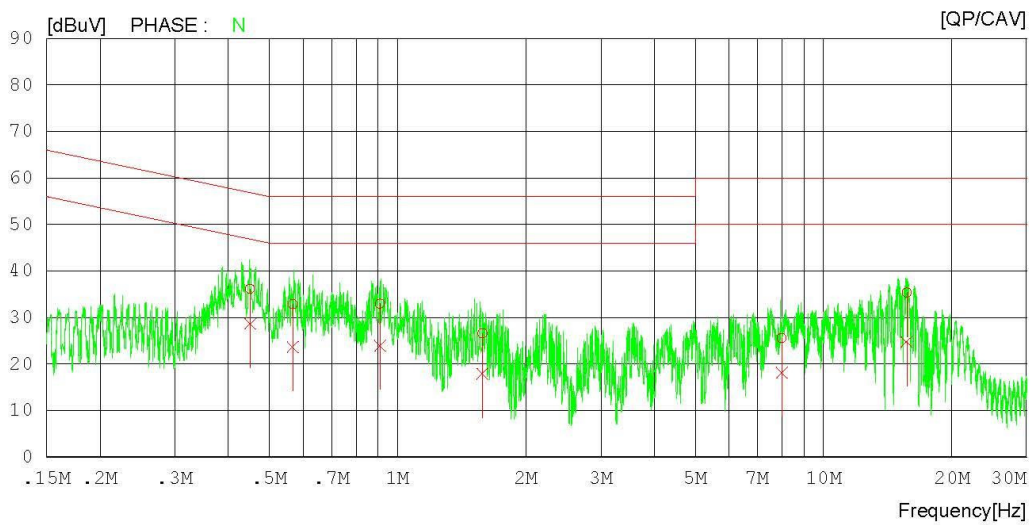

AC Line Conducted Emissions (List) = Modulation : GFSK model : IW05-DU

Results of Conducted Emission

 DT&C
 Date : 2016-10-20

Order No. : DTNC1609-05603	Power Supply : 120V 60Hz
Serial No. : Identical prototype	Temp/Humi/Atm : 23°C 44 % R.H.
Model No. : IW05-DU	Operator : J.W.Kim
Test Condition : Bluetooth_1Mbps	

memo : UFL type

 LIMIT : CISPR32_B QP
 CISPR32_B AV

NO	FREQ [MHz]	READING		C. FACTOR [dB]	RESULT		LIMIT		MARGIN		PHASE
		QP [dBuV]	CAV [dBuV]		QP [dBuV]	CAV [dBuV]	QP [dBuV]	CAV [dBuV]	QP [dBuV]	CAV [dBuV]	
1	0.45086	35.39	27.86	0.78	36.17	28.64	56.86	46.86	20.69	18.22	N
2	0.56761	32.19	23.06	0.62	32.81	23.68	56.00	46.00	23.19	22.32	N
3	0.90995	32.59	23.53	0.43	33.02	23.96	56.00	46.00	22.98	22.04	N
4	1.58220	26.26	17.54	0.35	26.61	17.89	56.00	46.00	29.39	28.11	N
5	7.98140	25.25	17.80	0.37	25.62	18.17	60.00	50.00	34.38	31.83	N
6	15.66760	34.83	24.28	0.49	35.32	24.77	60.00	50.00	24.68	25.23	N
7	0.43358	35.17	26.31	0.84	36.01	27.15	57.18	47.18	21.17	20.03	L
8	0.57634	31.52	18.12	0.63	32.15	18.75	56.00	46.00	23.85	27.25	L
9	0.89288	31.70	19.70	0.45	32.15	20.15	56.00	46.00	23.85	25.85	L
10	1.56720	26.20	16.04	0.38	26.58	16.42	56.00	46.00	29.42	29.58	L
11	8.88980	28.00	19.76	0.42	28.42	20.18	60.00	50.00	31.58	29.82	L
12	15.01460	32.45	22.64	0.47	32.92	23.11	60.00	50.00	27.08	26.89	L

9. Antenna Requirement

Describe how the EUT complies with the requirement that either its antenna is permanently attached, or that it employs a unique antenna connector, for every antenna proposed for use with the EUT.

Conclusion: Comply

Module Type 1, 3

The External antenna employs a unique antenna connector.

Module Type 2

The antenna is permanently attached.(Refer to Internal Photo file.)

- Minimum Standard :

An intentional radiator shall be designed to ensure that no antenna other than that furnished by the responsible party shall be used with the device. The use of a permanently attached antenna or of an antenna that uses a unique coupling to the intentional radiator shall be considered sufficient to comply with the provisions.

10. Occupied Bandwidth (99 %)

10.1 Test Setup

Refer to the APPENDIX I.

10.2 Limit

Limit : Not Applicable

10.3 Test Procedure

The 99 % power bandwidth was measured with a calibrated spectrum analyzer.

The resolution bandwidth (RBW) shall be in the range of 1 % to 5 % of the occupied bandwidth (OBW) and video bandwidth (VBW) shall be approximately $3 \times$ RBW.

Spectrum analyzer plots are included on the following pages.

10.4 Test Results

Test Mode	Tested Channel	Test Results (MHz)
<u>GFSK</u>	Lowest	0.896
	Middle	0.895
	Highest	0.899
<u>$\pi/4$DQPSK</u>	Lowest	1.194
	Middle	1.188
	Highest	1.182
<u>8DPSK</u>	Lowest	1.196
	Middle	1.180
	Highest	1.178

Occupied Bandwidth (99 %)

Lowest Frequency & GFSK

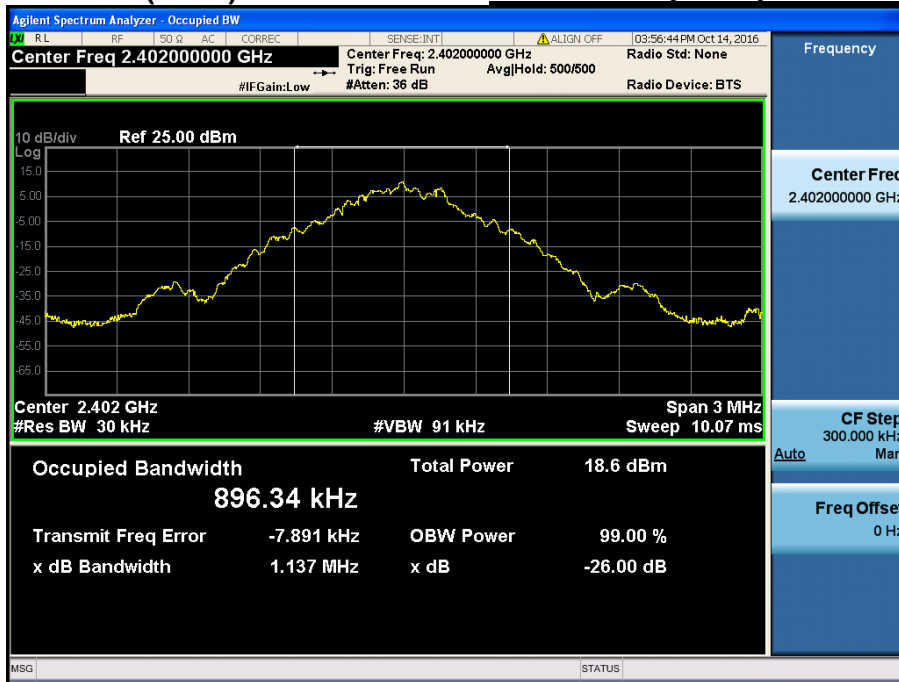

Occupied Bandwidth (99 %)

Middle Frequency & GFSK

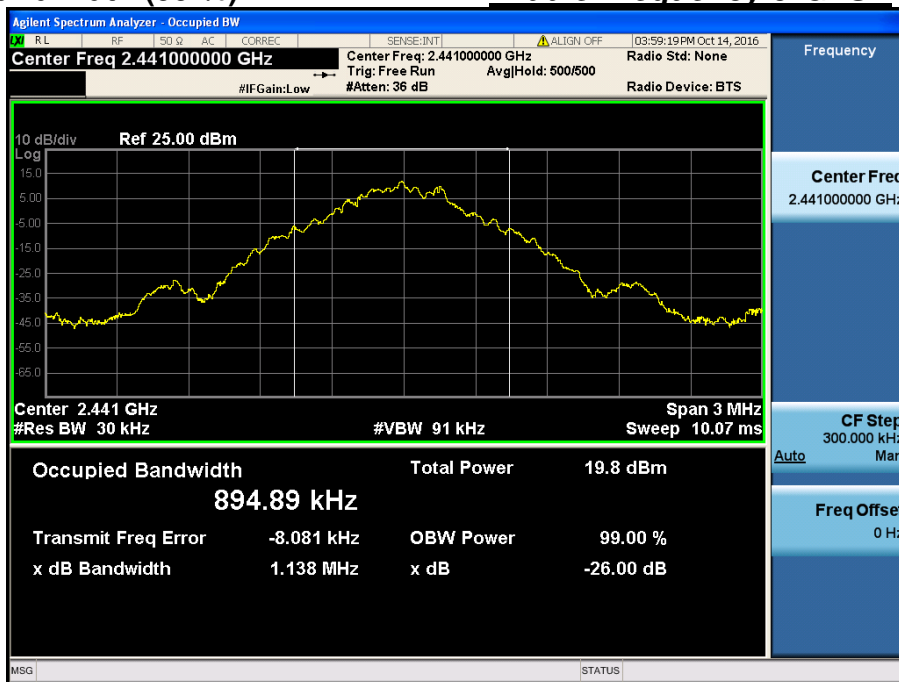

Occupied Bandwidth (99 %)

Highest Frequency & GFSK

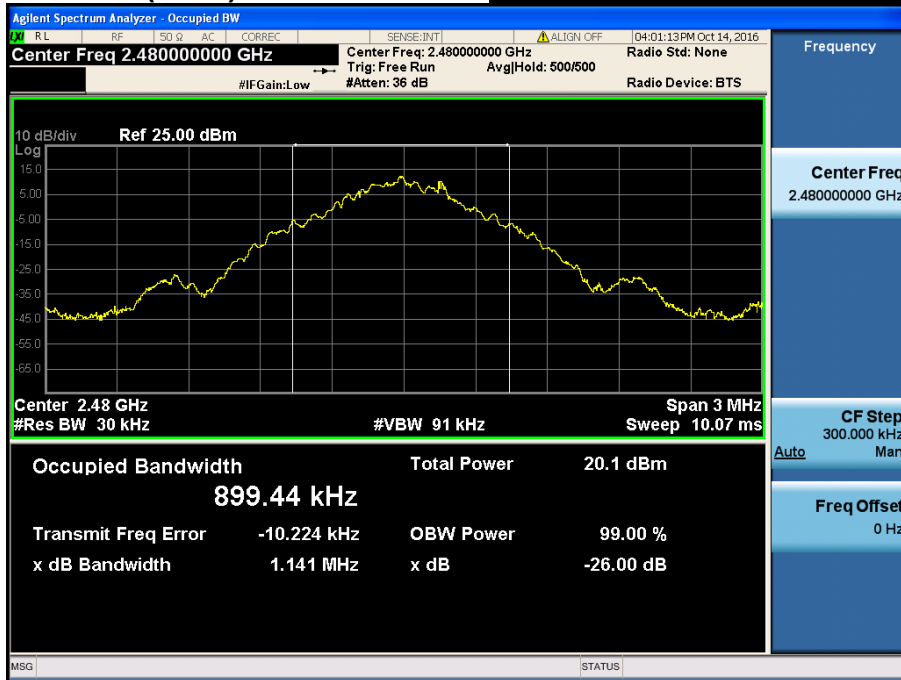

Occupied Bandwidth (99 %)

Lowest Frequency & $\pi/4$ DQPSK

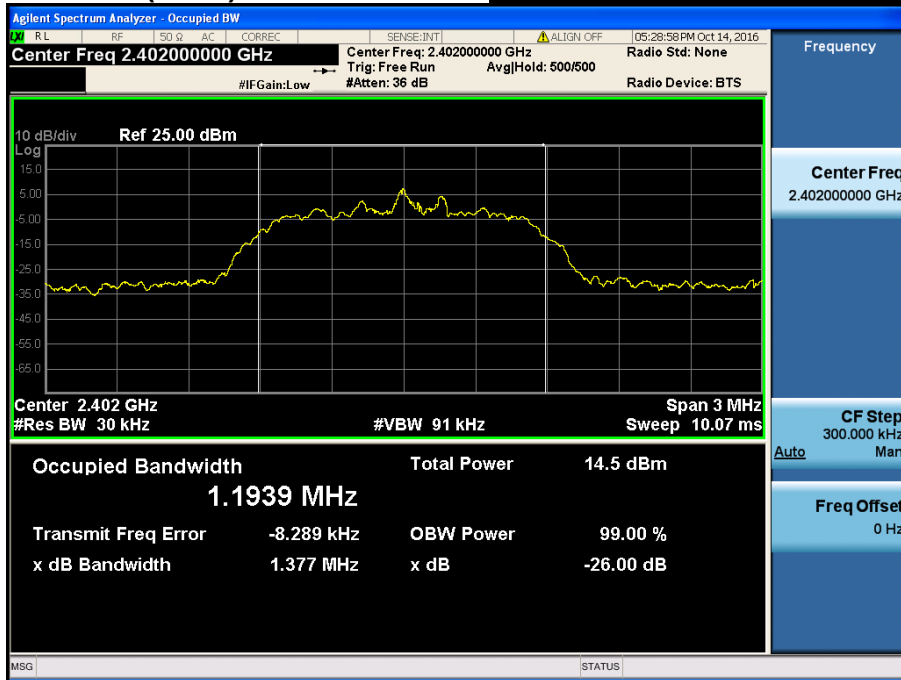

Occupied Bandwidth (99 %)

Middle Frequency & $\pi/4$ DQPSK

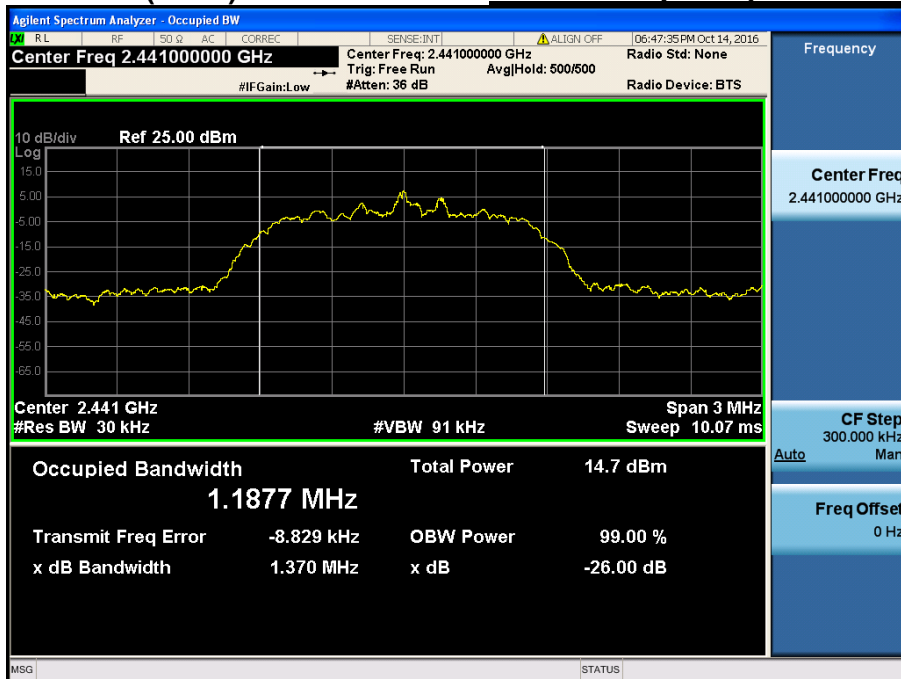

Occupied Bandwidth (99 %)

Highest Frequency & $\pi/4$ DQPSK

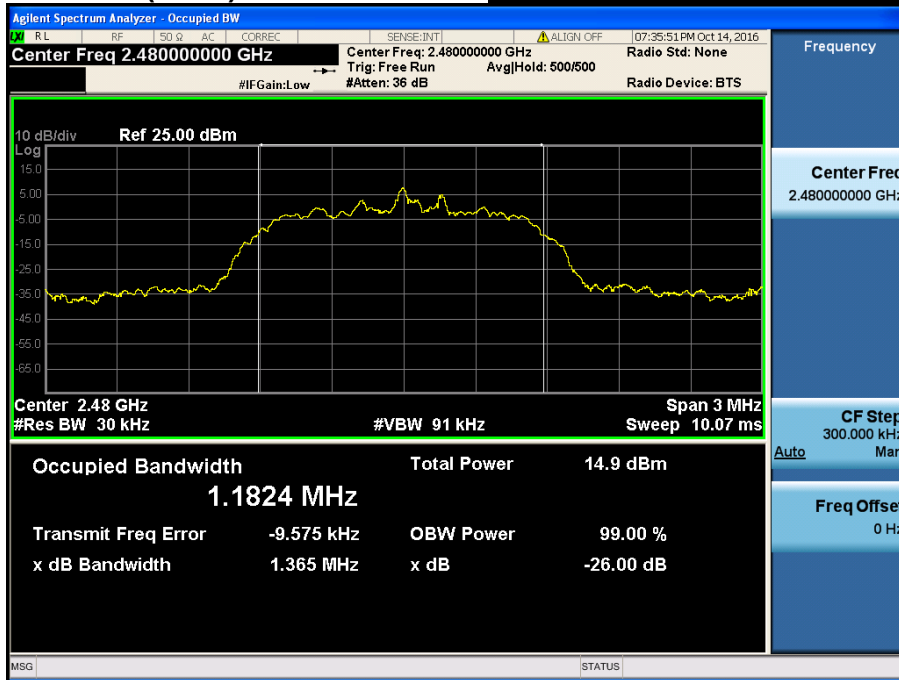

Occupied Bandwidth (99 %)

Lowest Frequency & 8DPSK

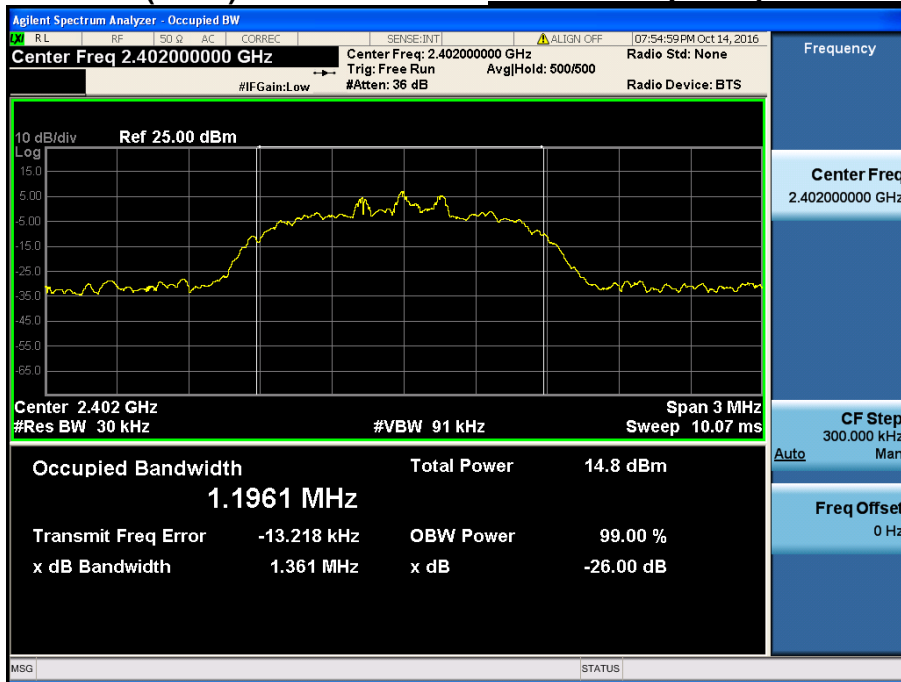

Occupied Bandwidth (99 %)

Middle Frequency & 8DPSK



Occupied Bandwidth (99 %)

Highest Frequency & 8DPSK

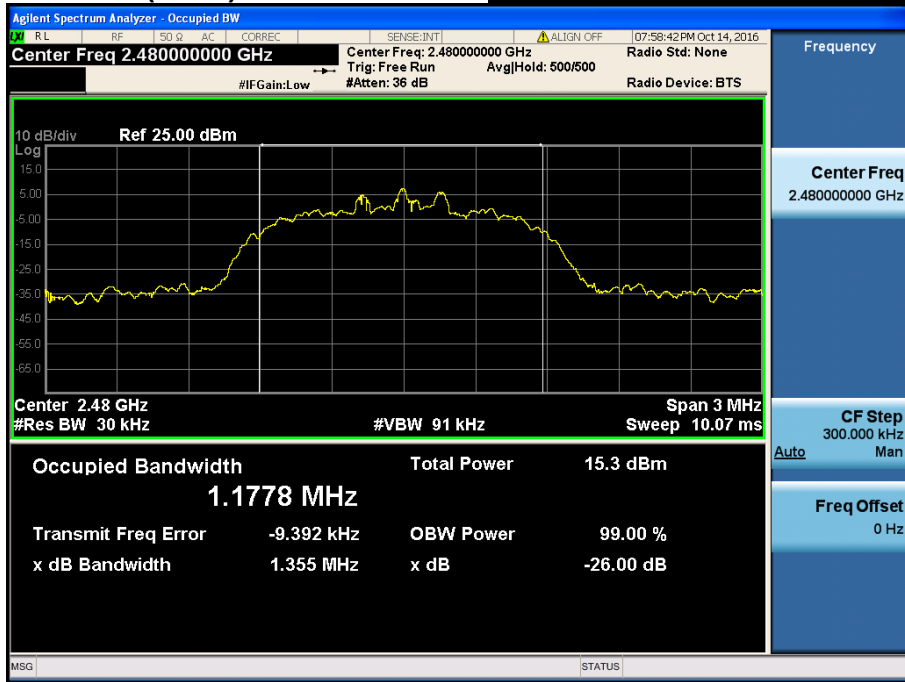

APPENDIX I

Test set up diagrams

▪ Radiated Measurement

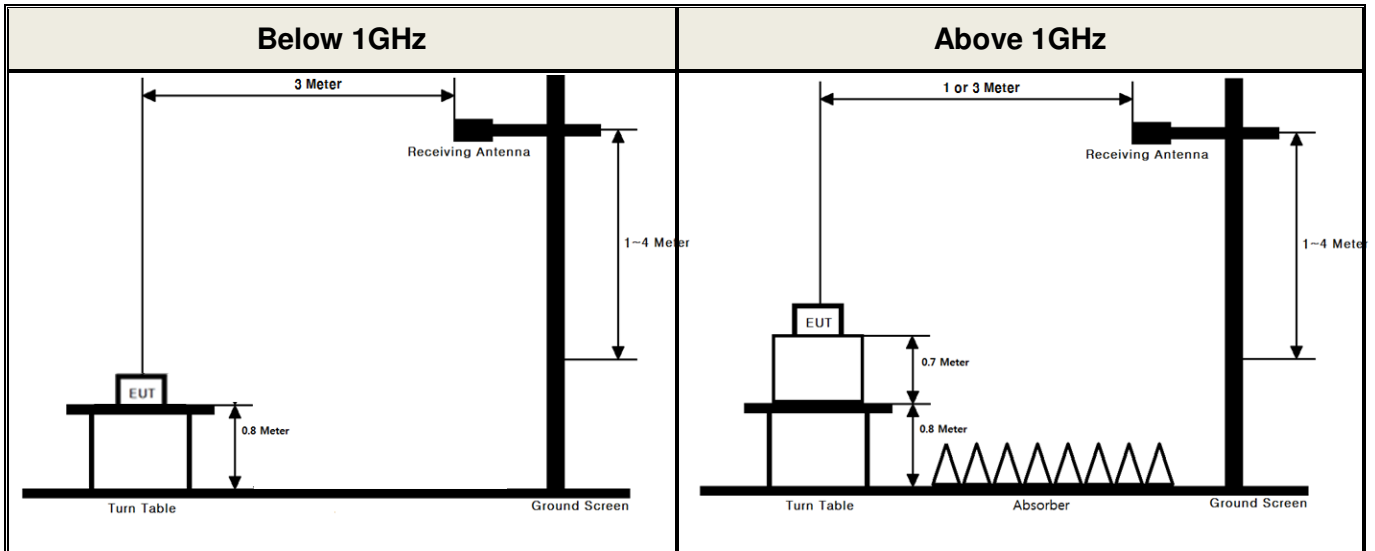

▪ Conducted Measurement

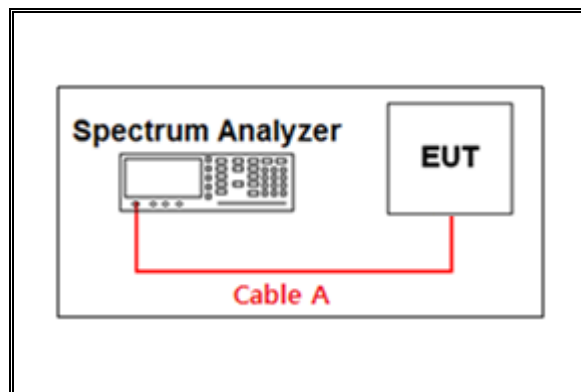

Path loss information

Frequency (GHz)	Path Loss (dB)	Frequency (GHz)	Path Loss (dB)
0.03	0.12	15	1.60
1	0.22	20	1.92
2402 & 2441 & 2480	0.35	25	2.23
5	0.59	-	-
10	1.26	-	-

Note 1 : The path loss from EUT to Spectrum analyzer were measured and used for test.

Path loss (S/A's Correction factor) = Cable A + Power splitter

APPENDIX II

Unwanted Emissions (Radiated) Test Plot

MODEL : IW05_Module Type 1

GFSK & Lowest & X & Hor

Detector Mode : PK

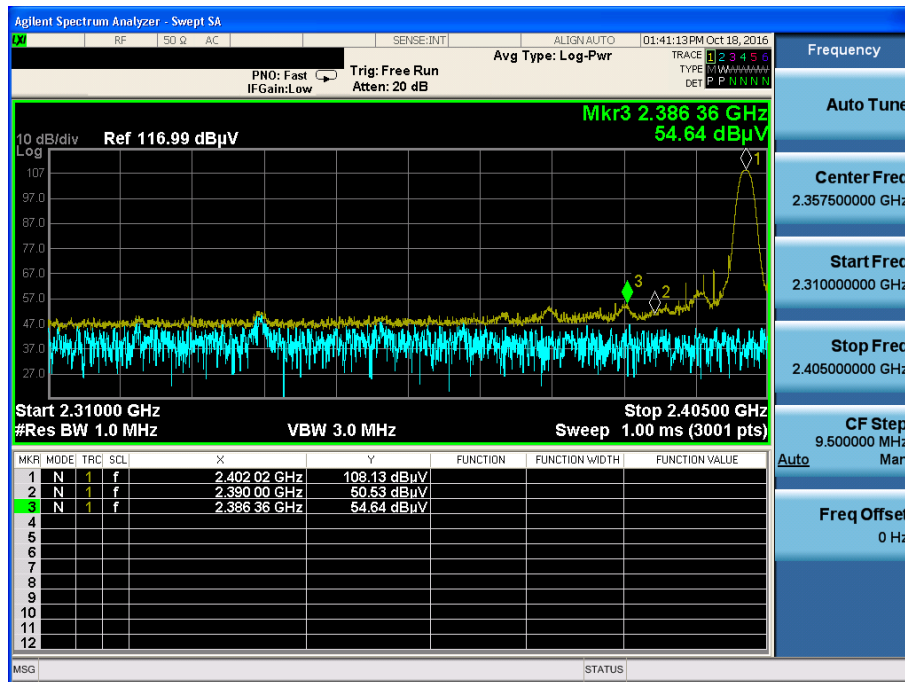

GFSK & Lowest & X & Hor

Detector Mode : AV

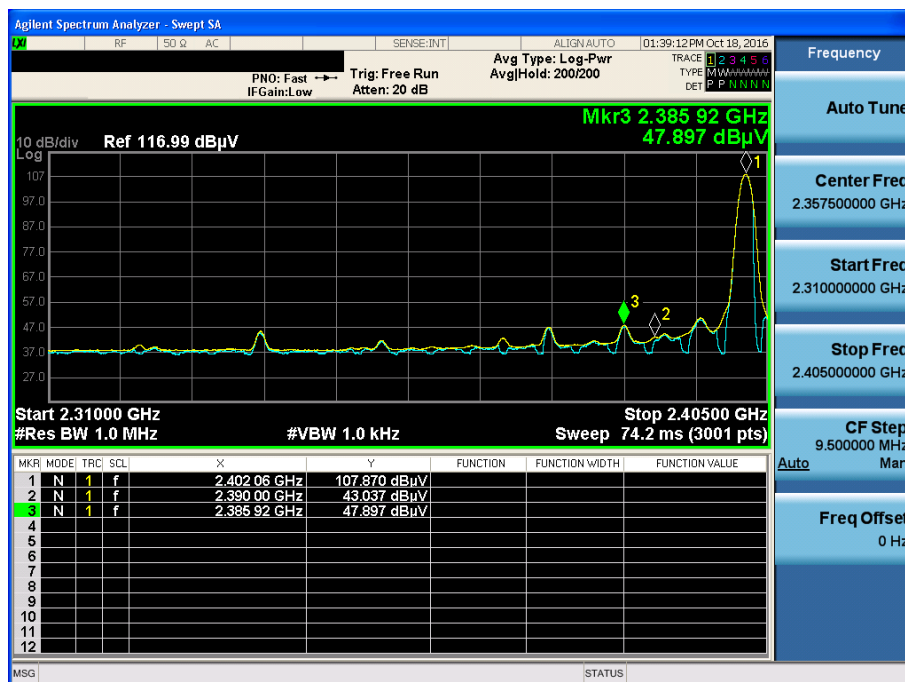

GFSK & Highest & X & Hor

Detector Mode : PK

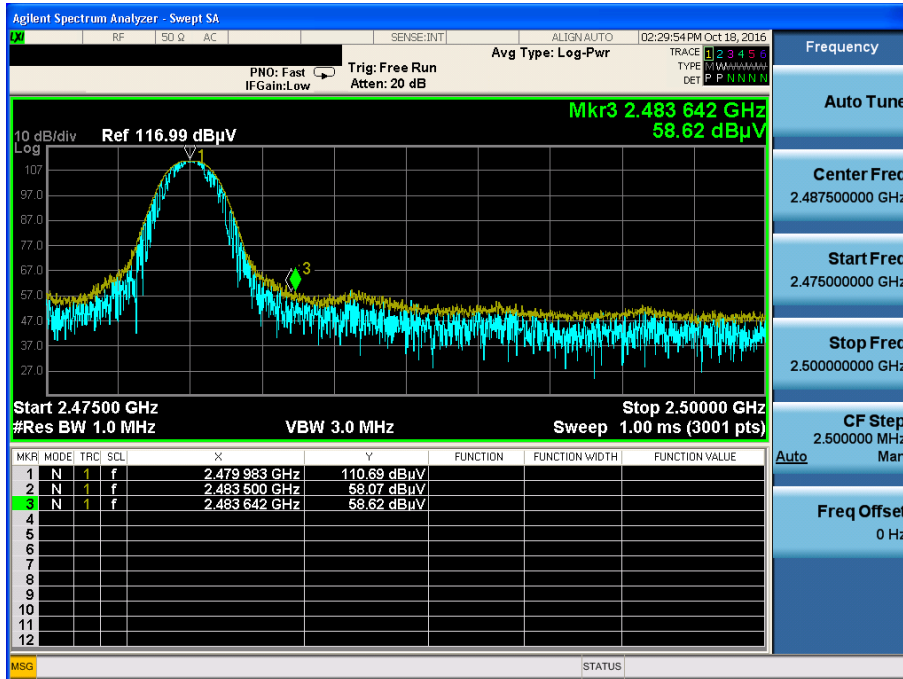

GFSK & Highest & X & Hor

Detector Mode : AV



π /4DQPSK & Lowest & X & Hor

Detector Mode : PK

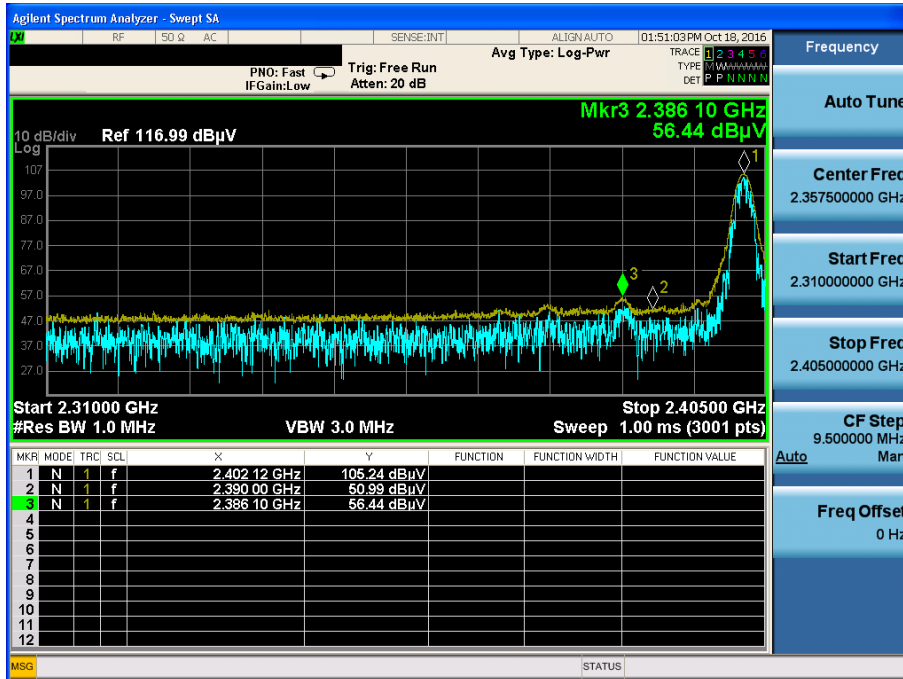

π /4DQPSK & Lowest & X & Hor

Detector Mode : AV

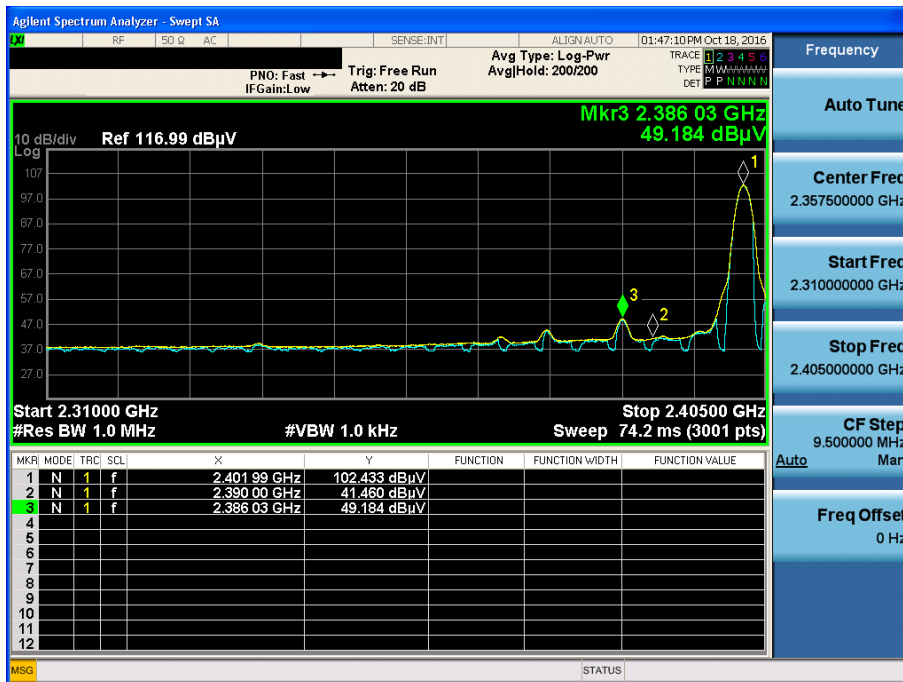

π /4DQPSK & Highest & X & Hor

Detector Mode : PK

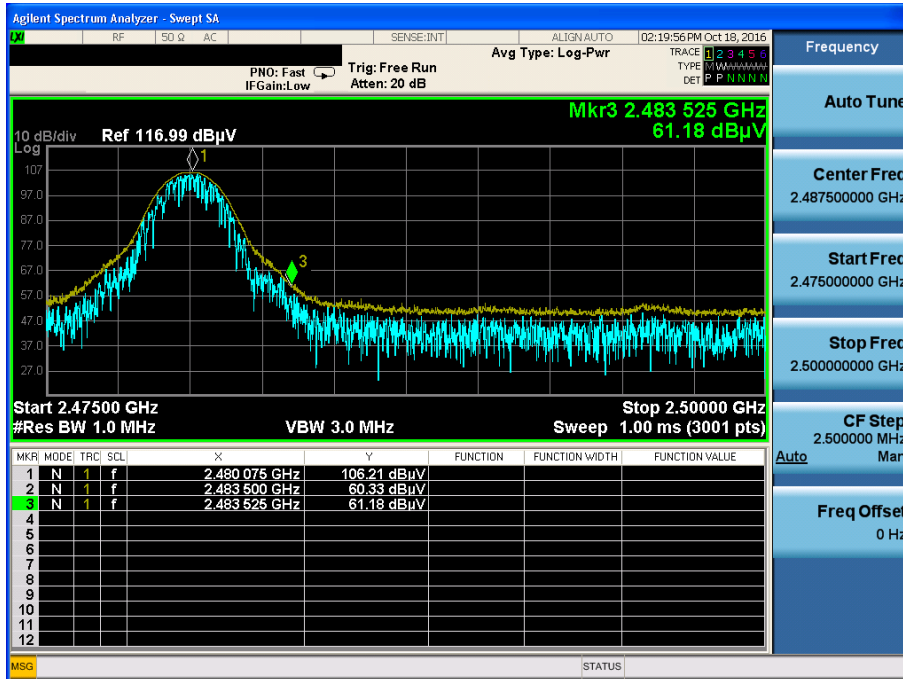

π /4DQPSK & Highest & X & Hor

Detector Mode : AV

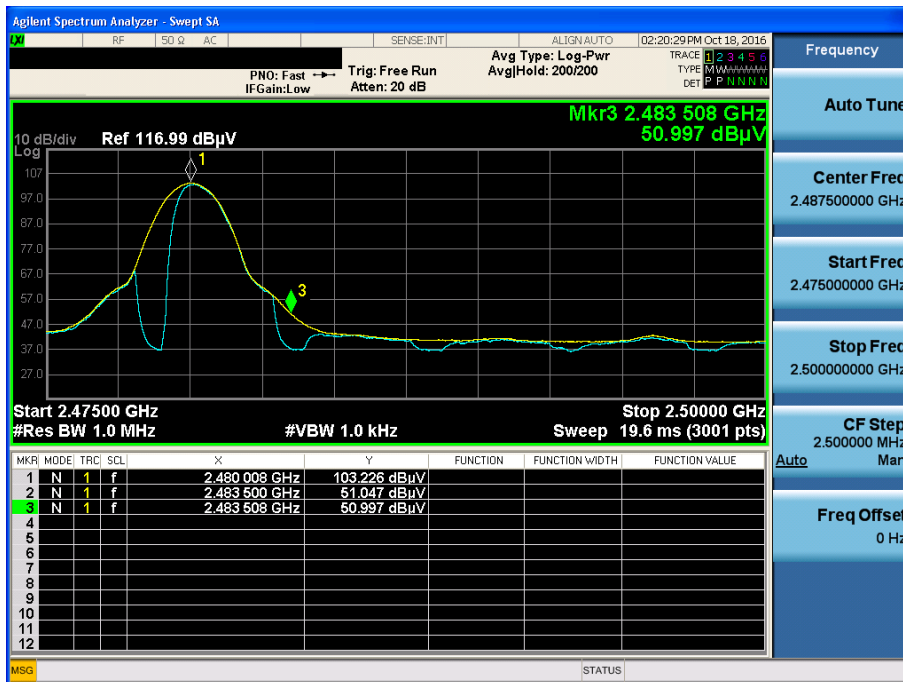

8DPSK & Lowest & X & Hor

Detector Mode : PK

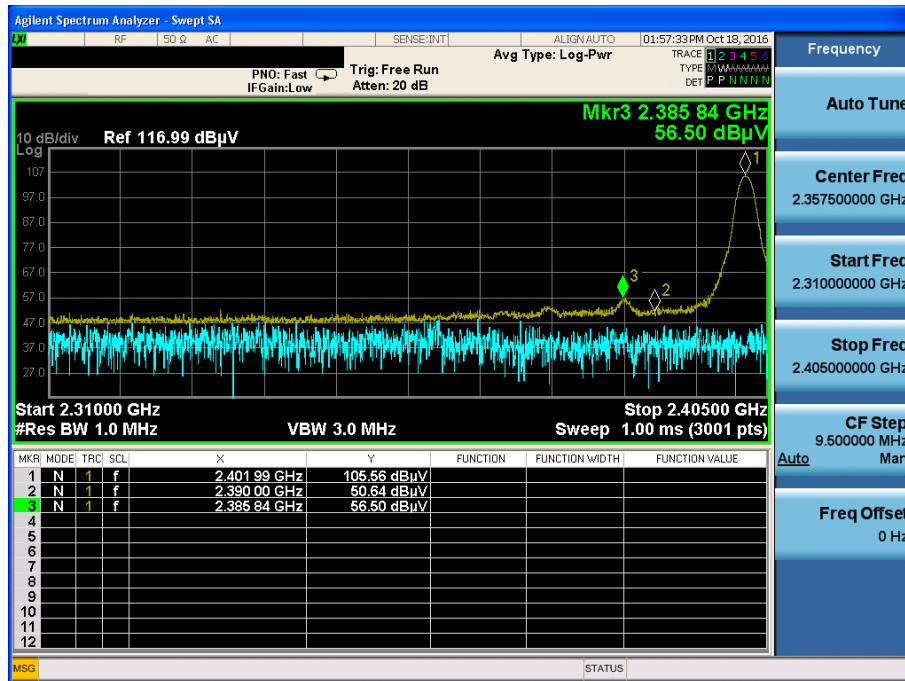

8DPSK & Lowest & X & Hor

Detector Mode : AV

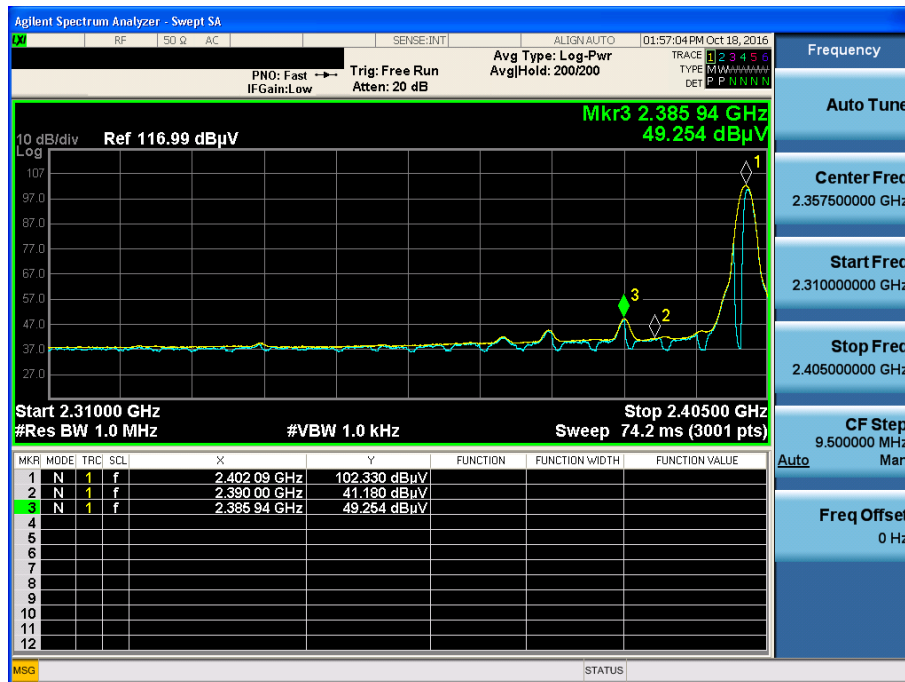

8DPSK & Highest & X & Hor

Detector Mode : PK

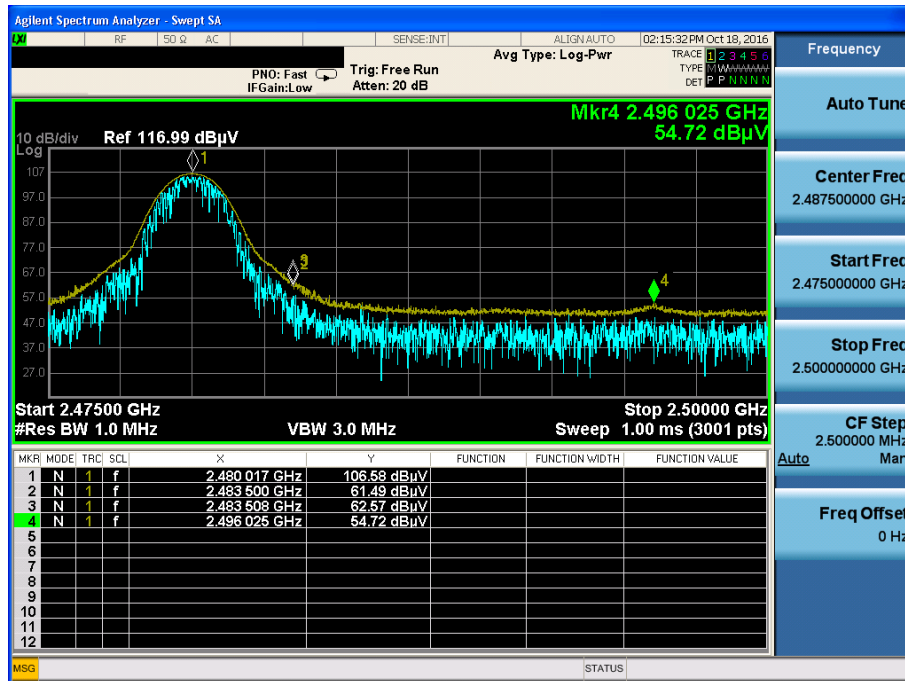

8DPSK & Highest & X & Hor

Detector Mode : AV

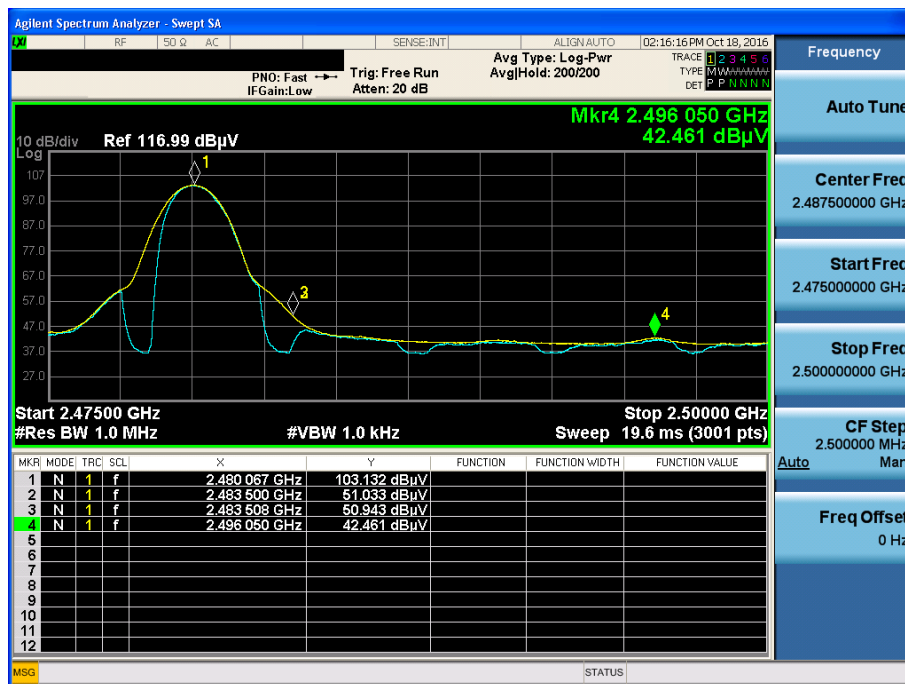

GFSK & Highest & Z & Hor

Detector Mode : PK

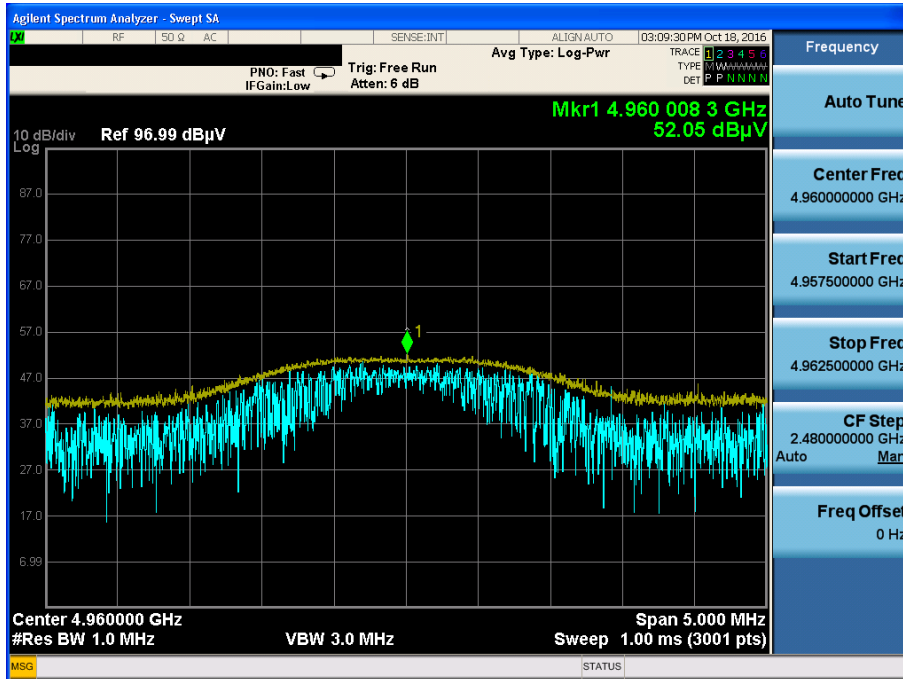

π /4DQPSK & Highest & Z & Hor

Detector Mode : PK

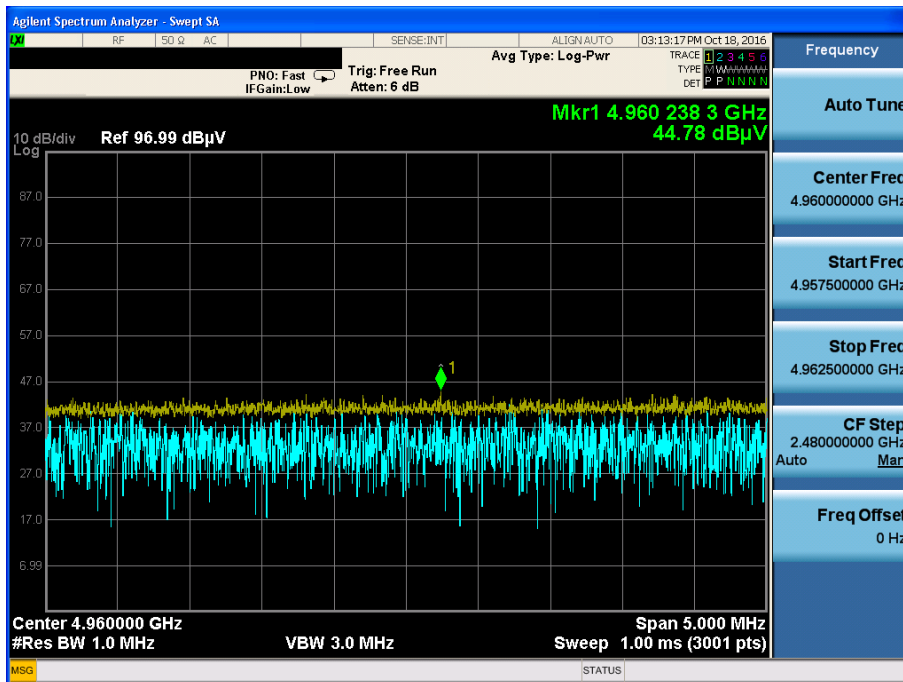

8DPSK & Highest & Z & Hor

Detector Mode : PK

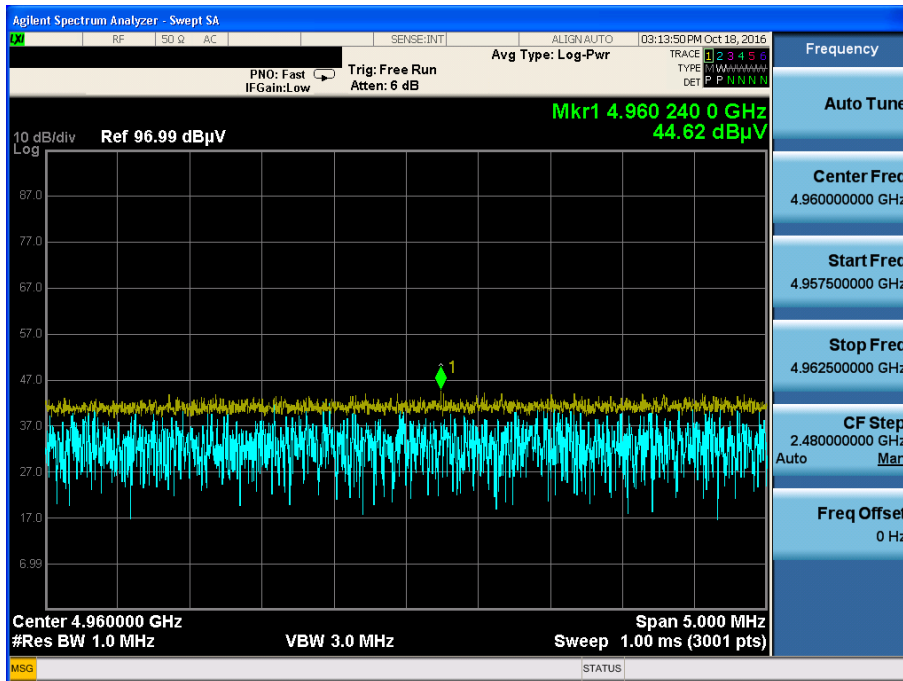

GFSK & Hopping mode & X & Hor

Detector Mode : PK

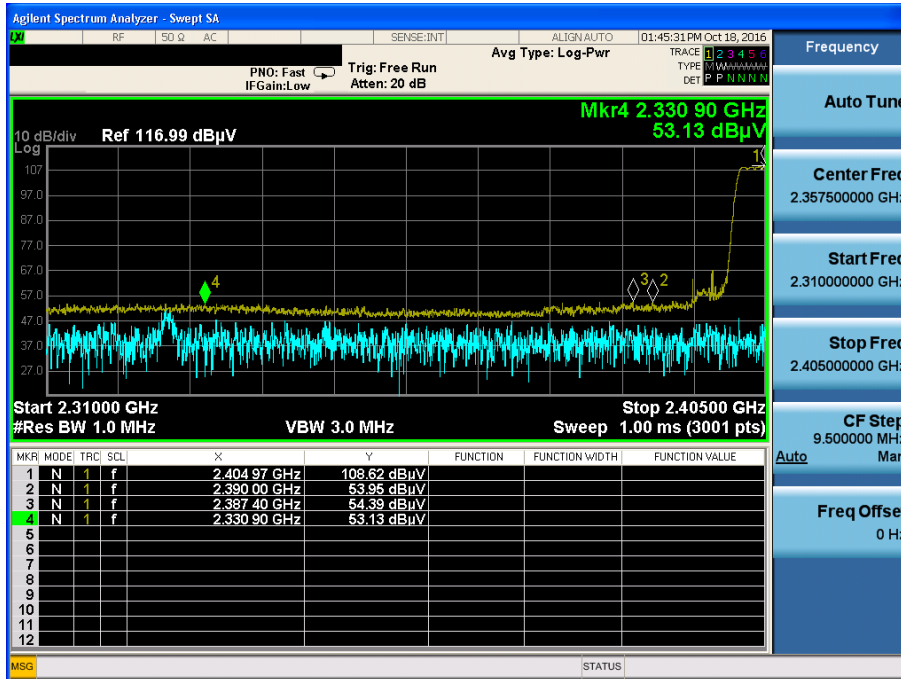

GFSK & Hopping mode & X & Hor

Detector Mode : AV

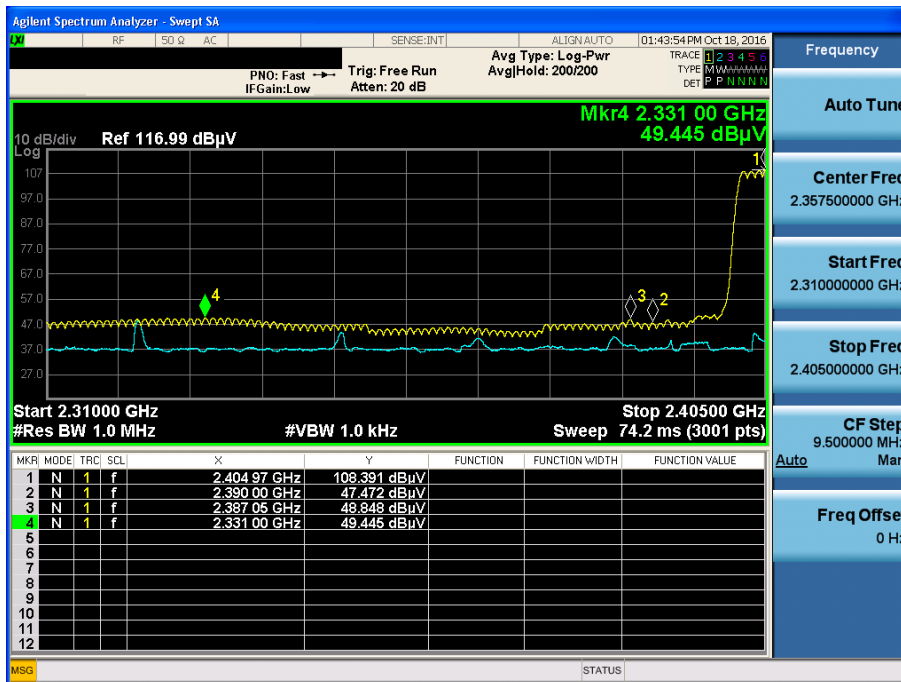

GFSK & Hopping mode & X & Hor

Detector Mode : PK

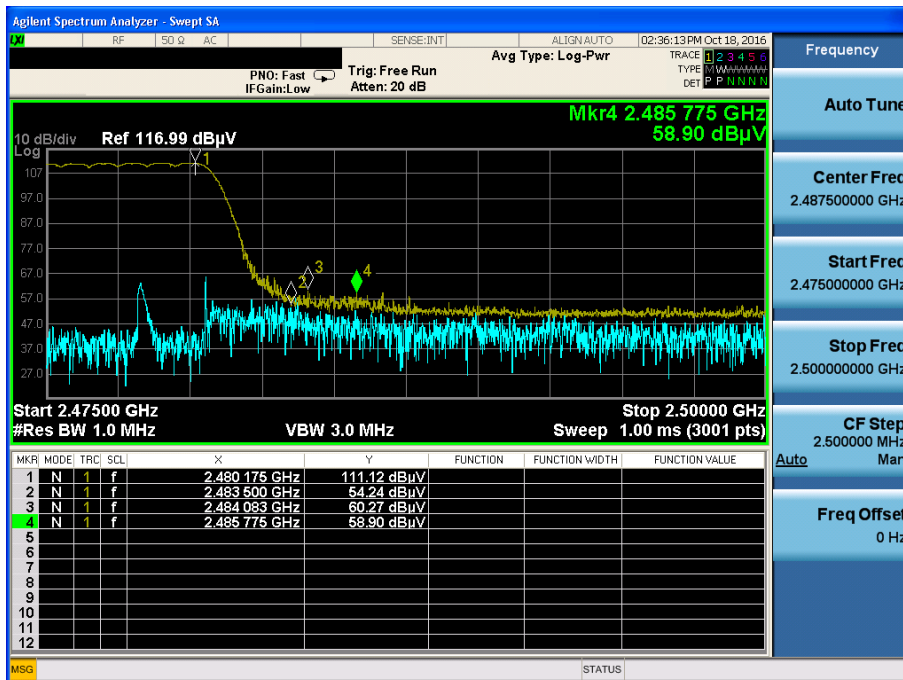

GFSK & Hopping mode & X & Hor

Detector Mode : AV

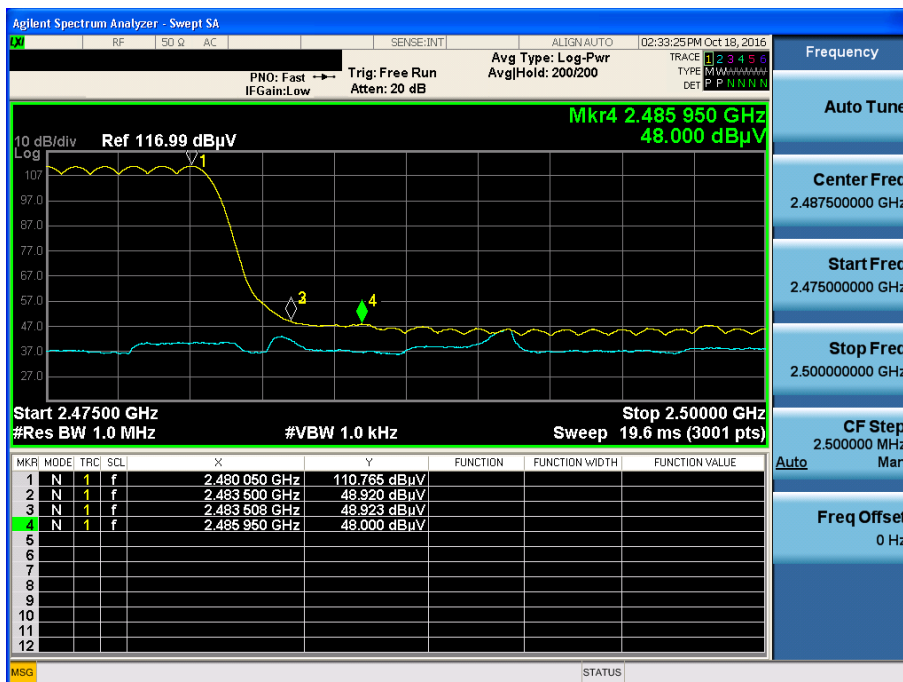

π /4DQPSK & Hopping mode & X & Hor

Detector Mode : PK

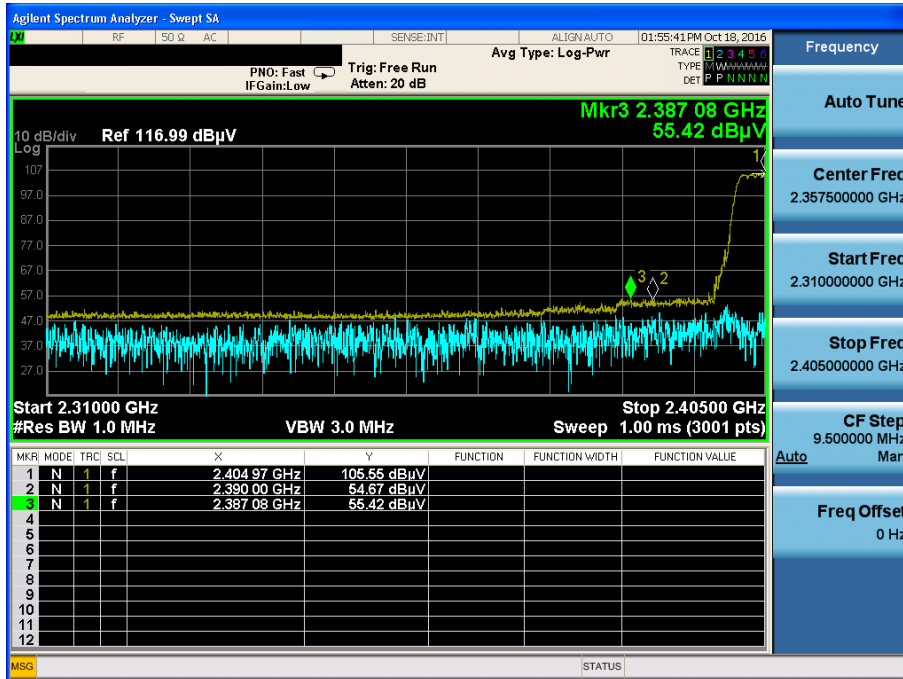

π /4DQPSK & Hopping mode & X & Hor

Detector Mode : AV



π /4DQPSK & Hopping mode & X & Hor

Detector Mode : PK

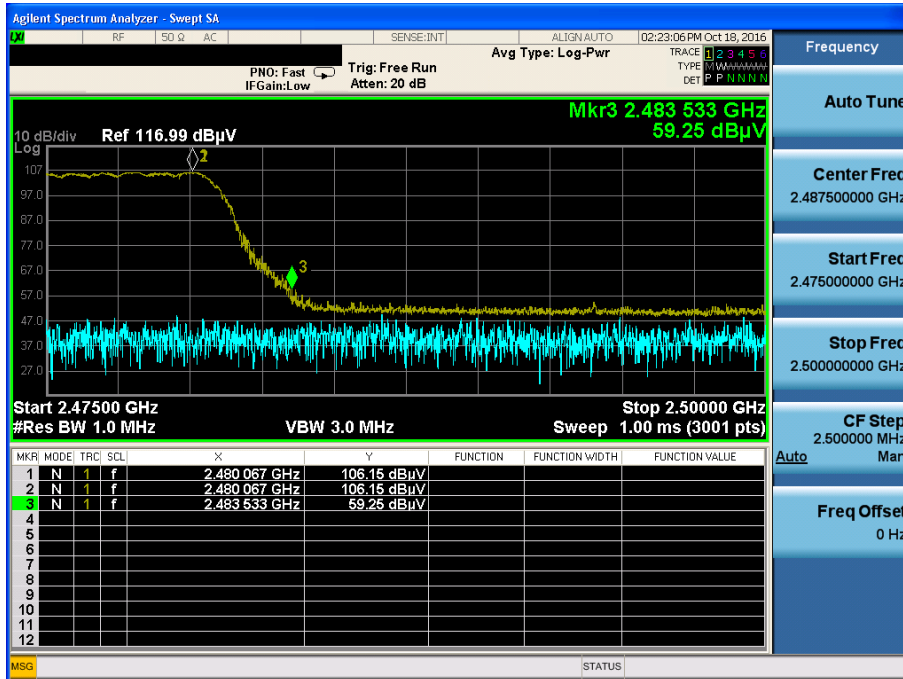

π /4DQPSK & Hopping mode & X & Hor

Detector Mode : AV

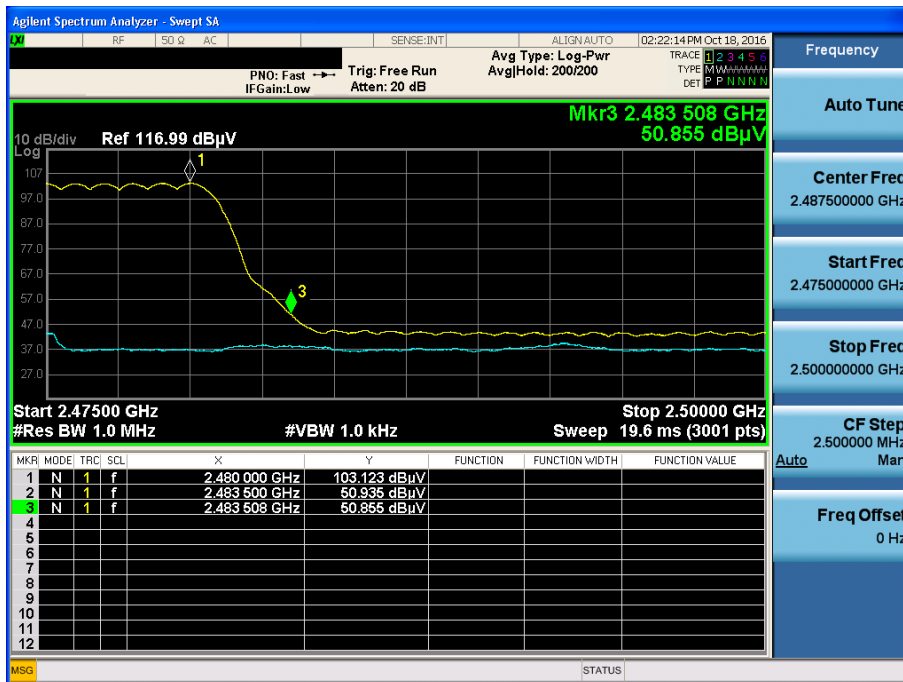

8DPSK & Hopping mode & X & Hor

Detector Mode : PK

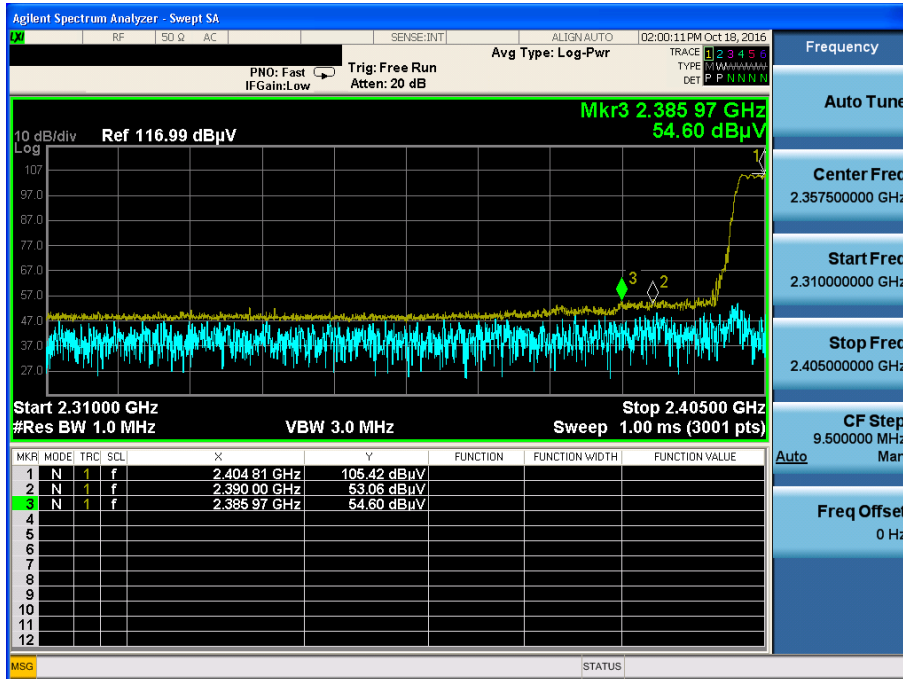

8DPSK & Hopping mode & X & Hor

Detector Mode : AV

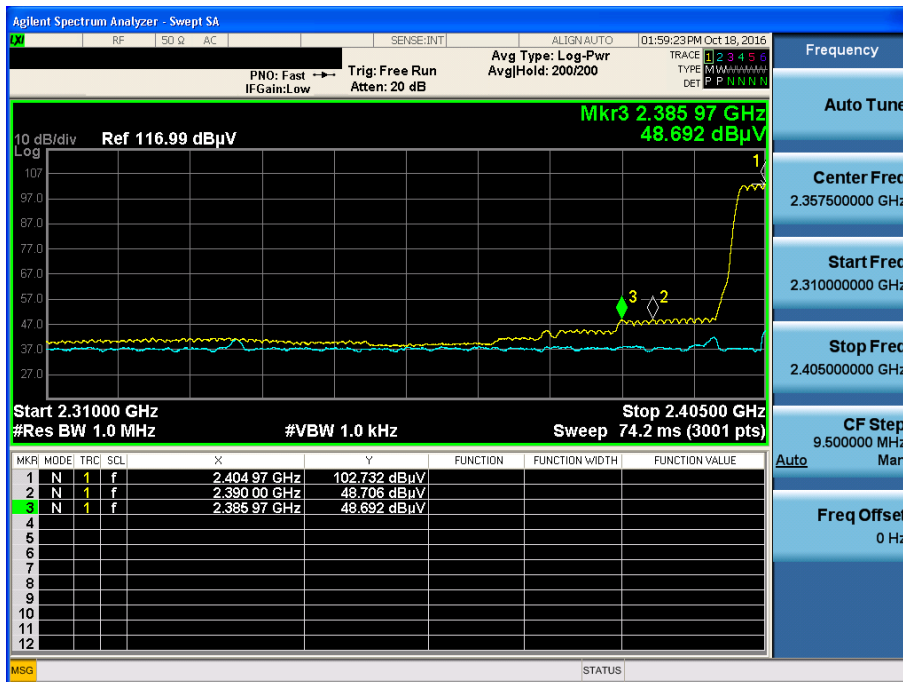

8DPSK & Hopping mode & X & Hor

Detector Mode : PK

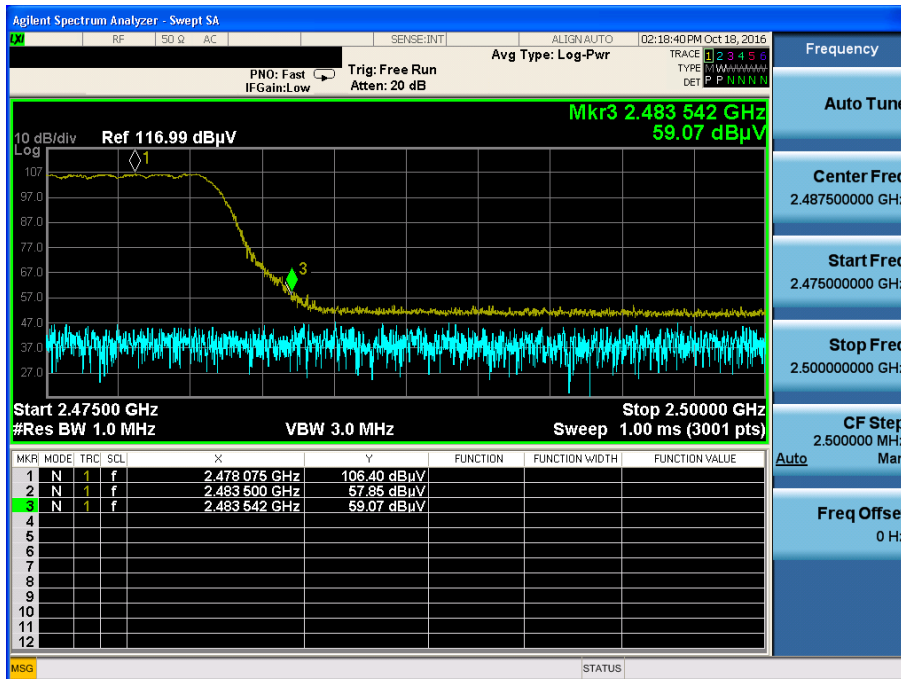

8DPSK & Hopping mode & X & Hor

Detector Mode : AV



MODEL : IW05-DC_Module Type 2

GFSK & Lowest & X & Hor

Detector Mode : PK

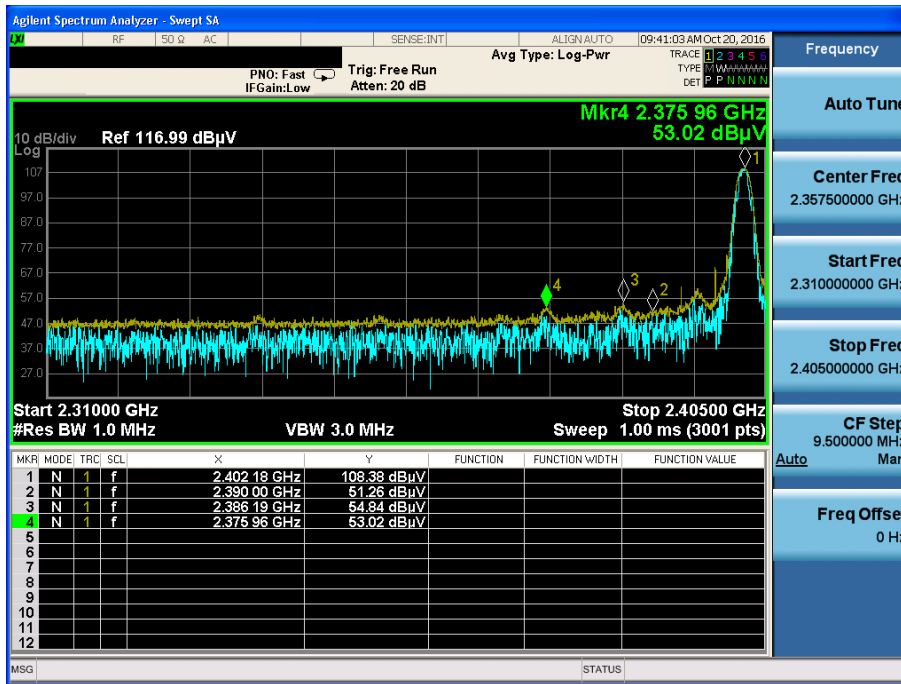

GFSK & Lowest & X & Hor

Detector Mode : AV

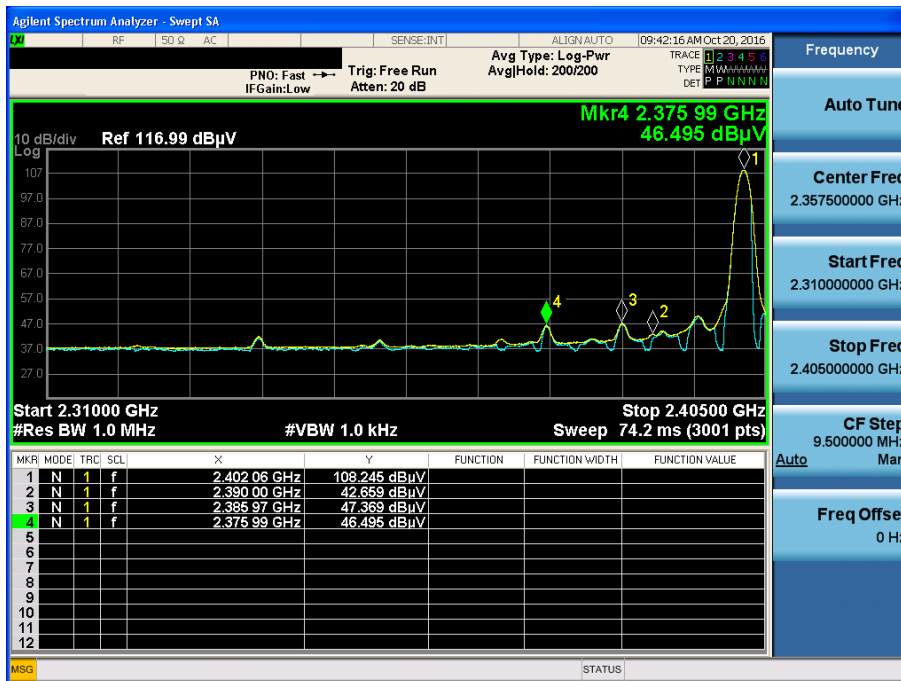

GFSK & Highest & X & Hor

Detector Mode : PK

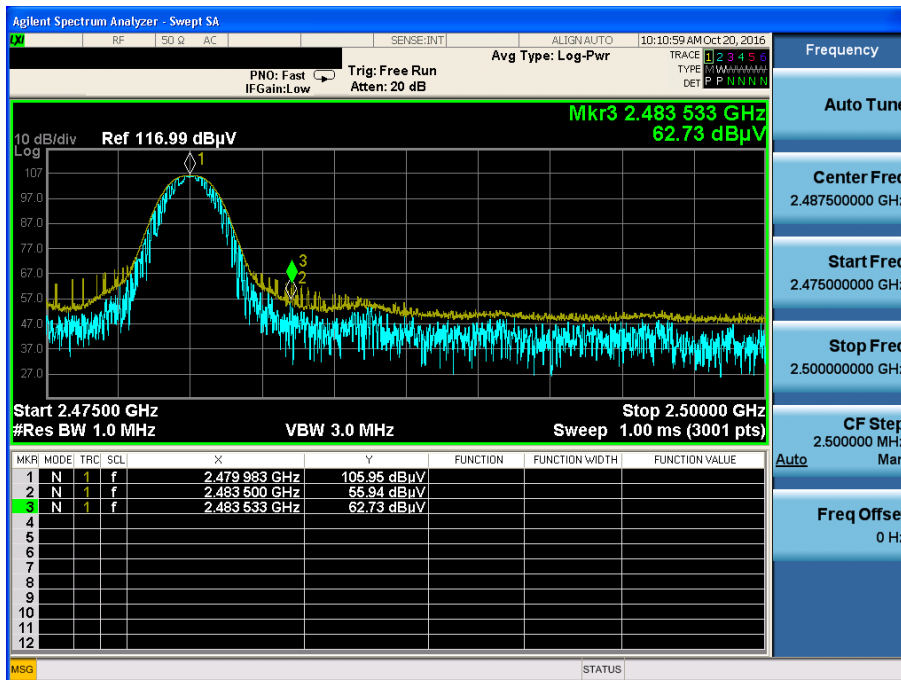

GFSK & Highest & X & Hor

Detector Mode : AV

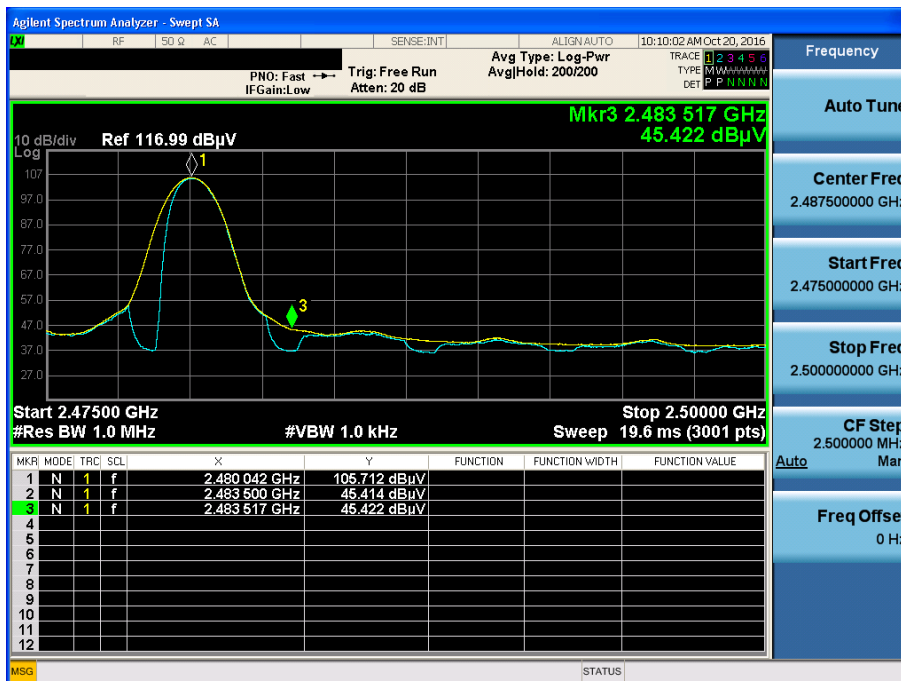

π /4DQPSK & Lowest & X & Hor

Detector Mode : PK

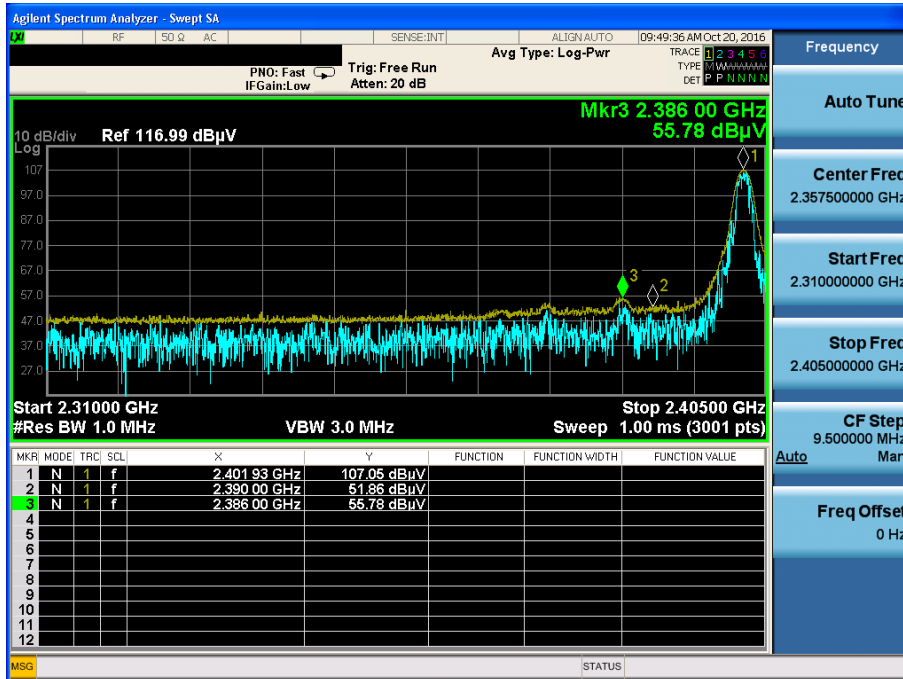

π /4DQPSK & Lowest & X & Hor

Detector Mode : AV



$\pi/4$ DQPSK & Highest & X & Hor

Detector Mode : PK

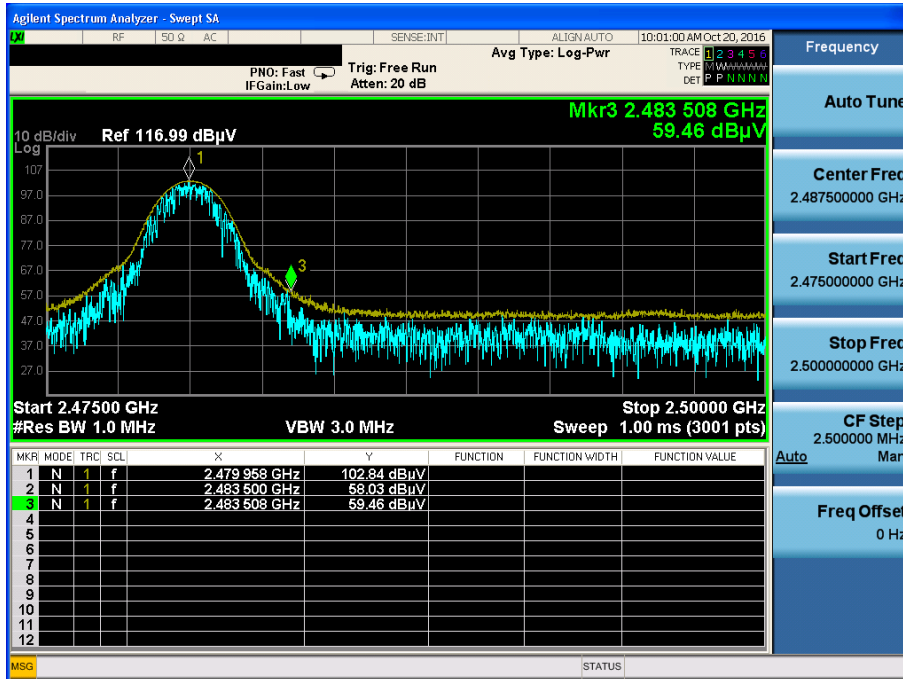

$\pi/4$ DQPSK & Highest & X & Hor

Detector Mode : AV

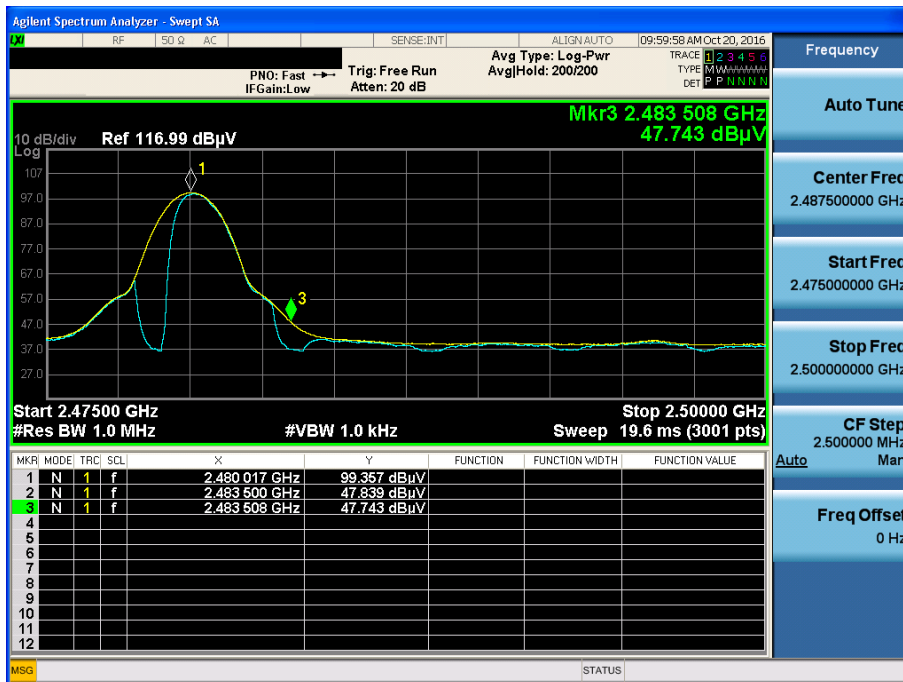

8DPSK & Lowest & X & Hor

Detector Mode : PK

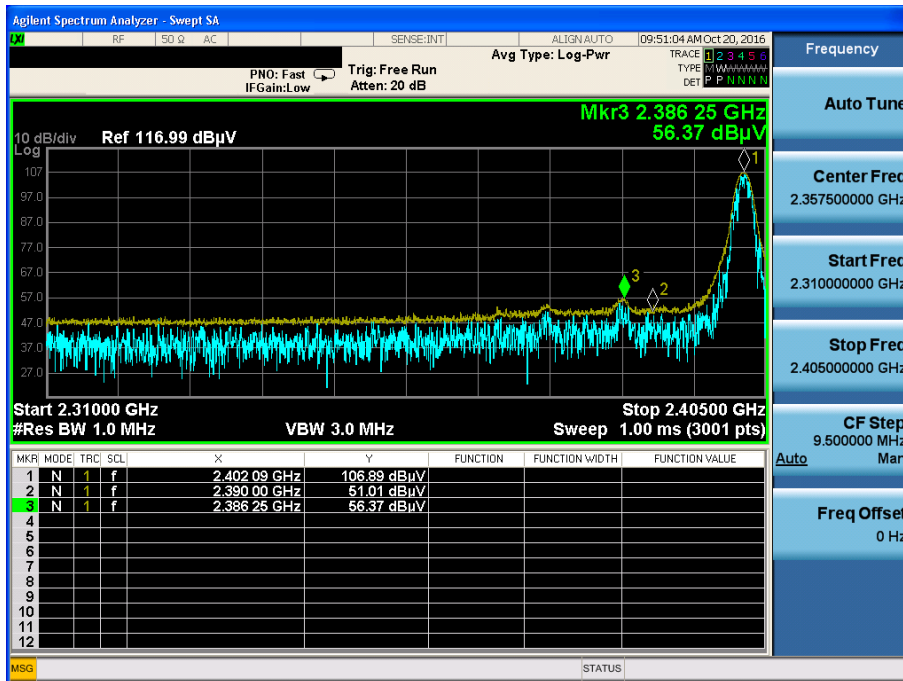

8DPSK & Lowest & X & Hor

Detector Mode : AV

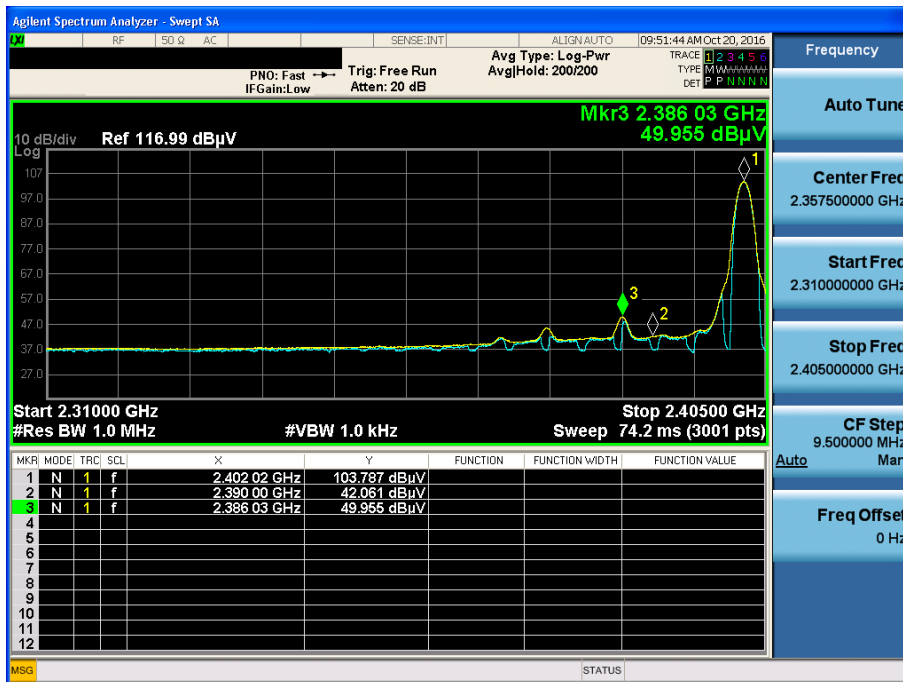

8DPSK & Highest & X & Hor

Detector Mode : PK

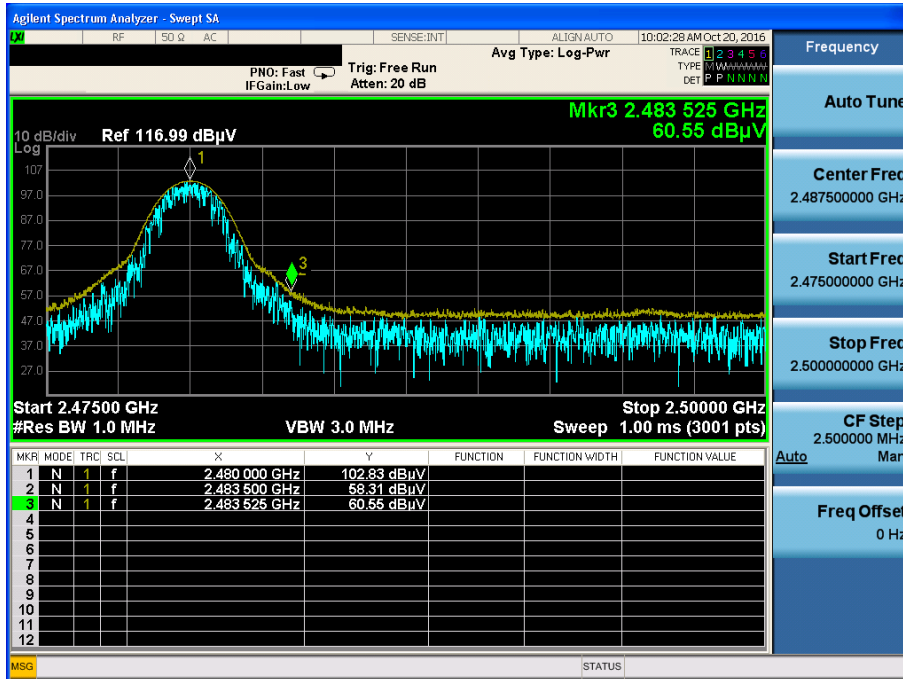

8DPSK & Highest & X & Hor

Detector Mode : AV

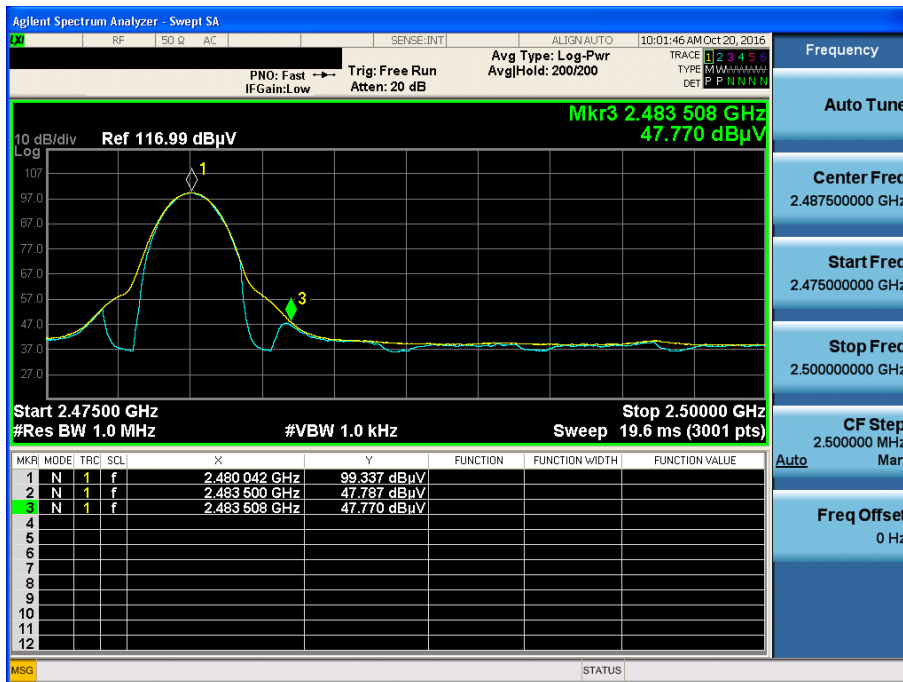

GFSK & Highest & Z & Hor

Detector Mode : PK

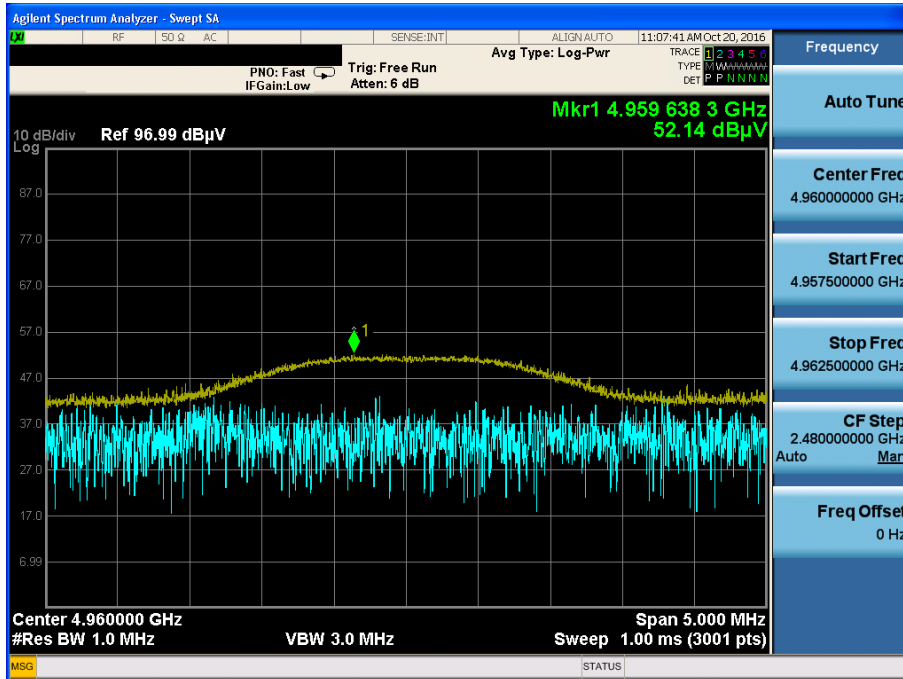

π /4DQPSK & Lowest & Z & Hor

Detector Mode : PK

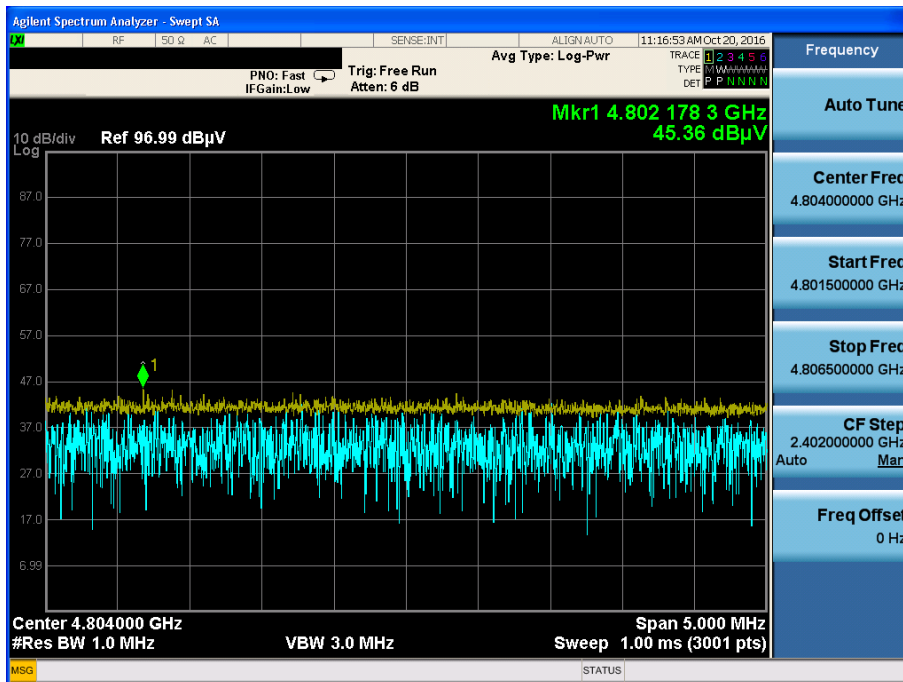

8DPSK & Middle & Z & Hor

Detector Mode : PK

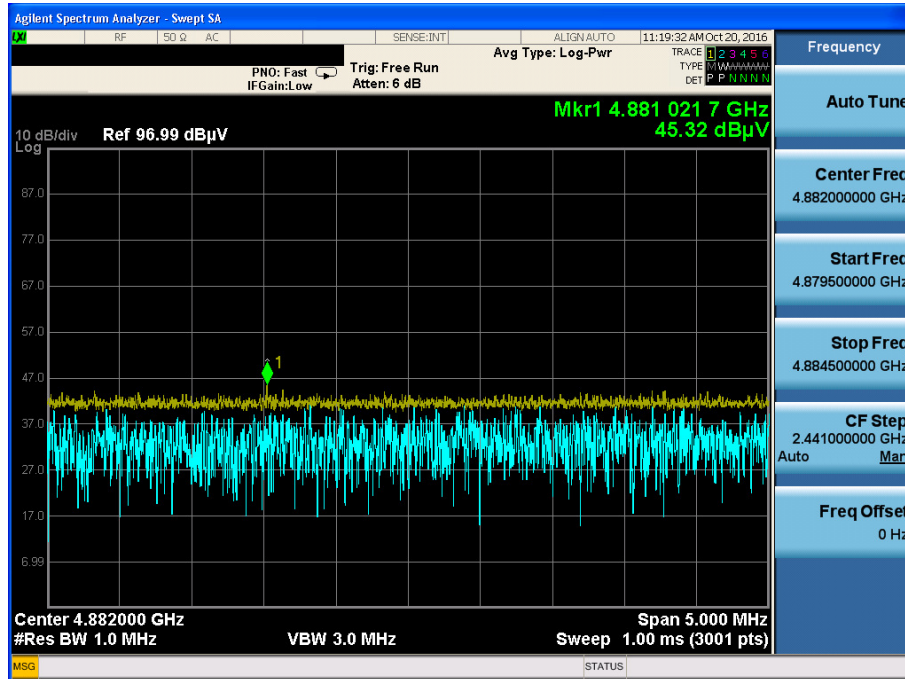

GFSK & Hopping mode & X & Hor

Detector Mode : PK

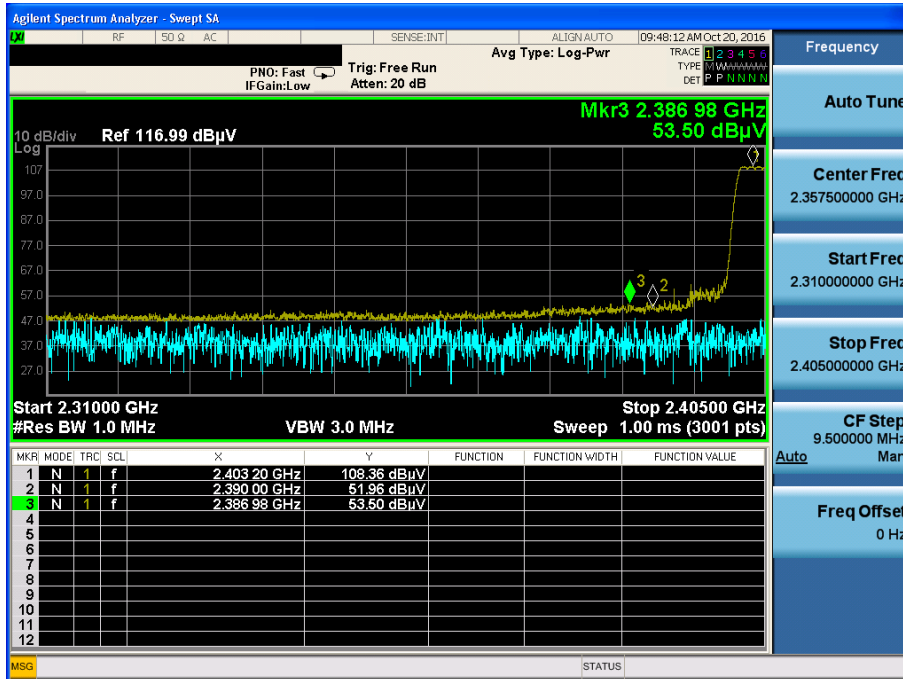

GFSK & Hopping mode & X & Hor

Detector Mode : AV

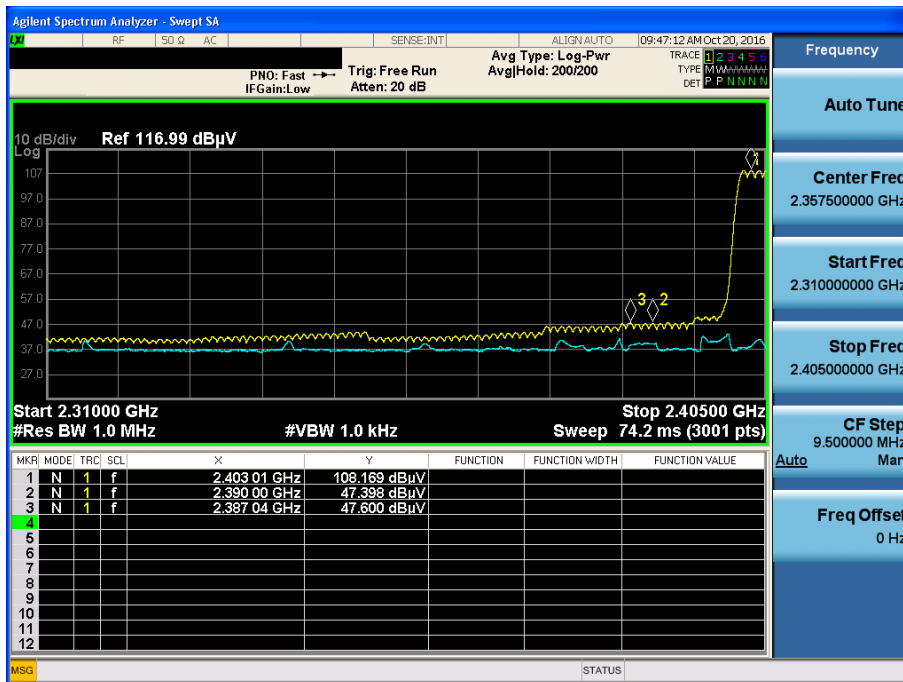

GFSK & Hopping mode & X & Hor

Detector Mode : PK

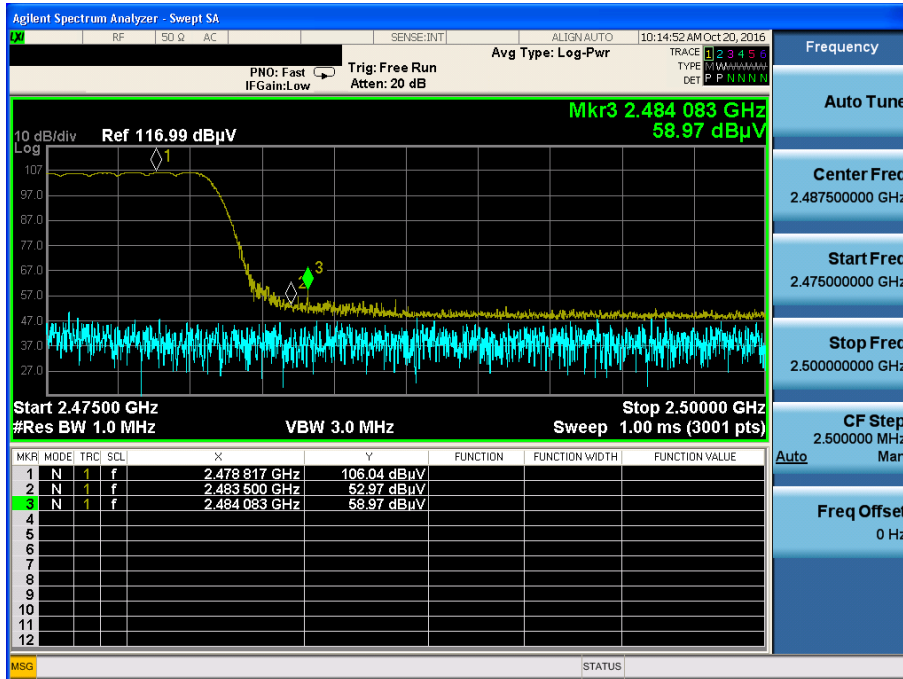

GFSK & Hopping mode & X & Hor

Detector Mode : AV

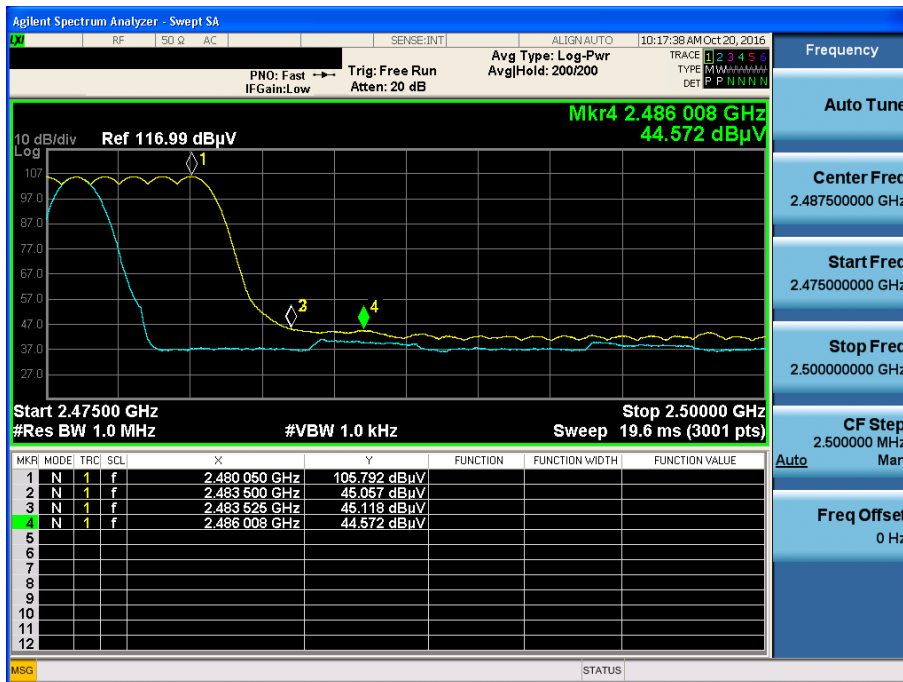

π /4DQPSK & Hopping mode & X & Hor

Detector Mode : PK

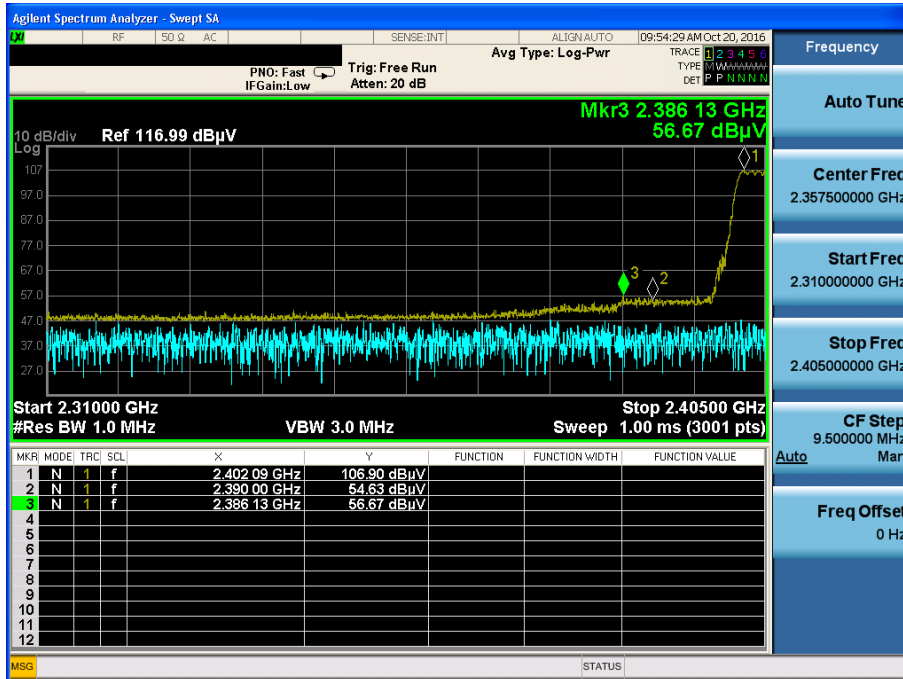

π /4DQPSK & Hopping mode & X & Hor

Detector Mode : AV



π /4DQPSK & Hopping mode & X & Hor

Detector Mode : PK

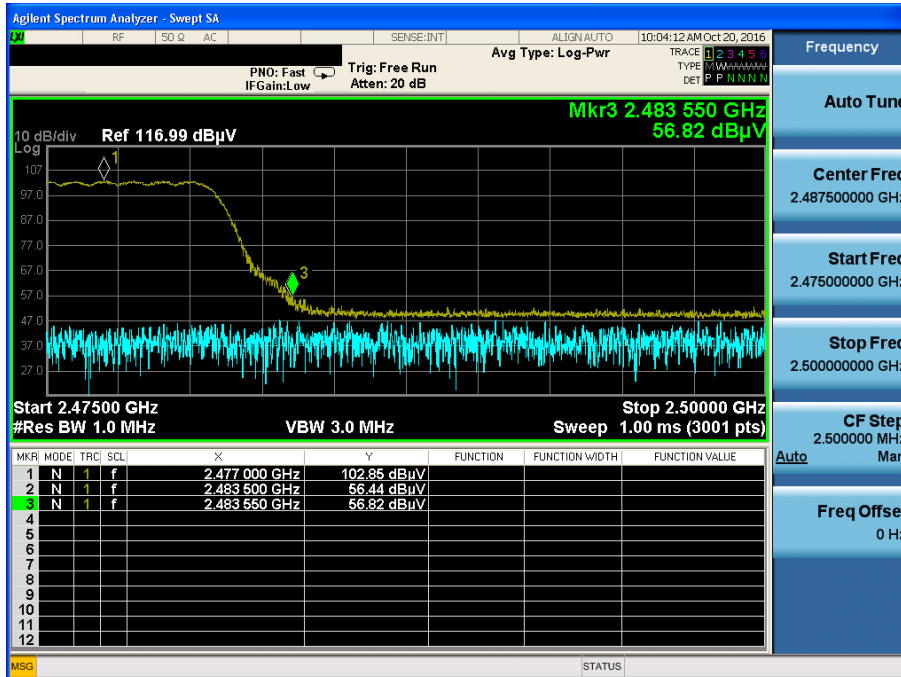

π /4DQPSK & Hopping mode & X & Hor

Detector Mode : AV



8DPSK & Hopping mode & X & Hor

Detector Mode : PK

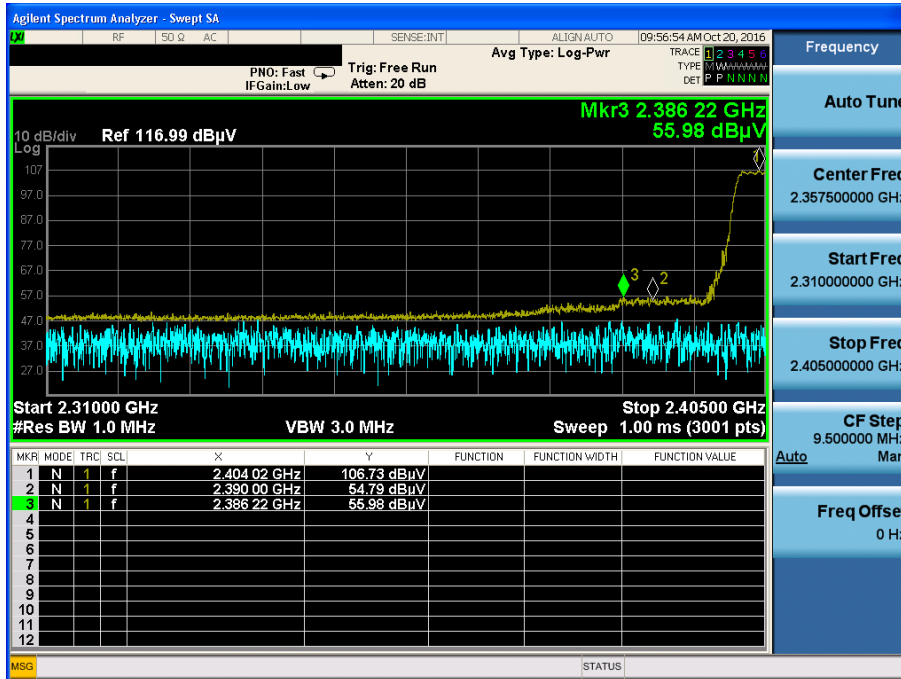

8DPSK & Hopping mode & X & Hor

Detector Mode : AV

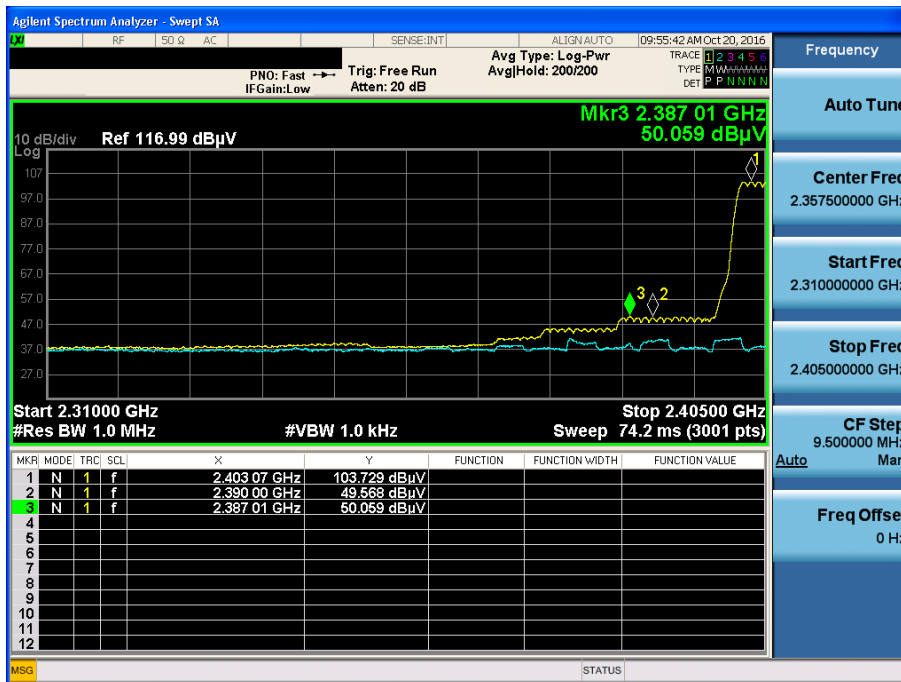

8DPSK & Hopping mode & X & Hor

Detector Mode : PK

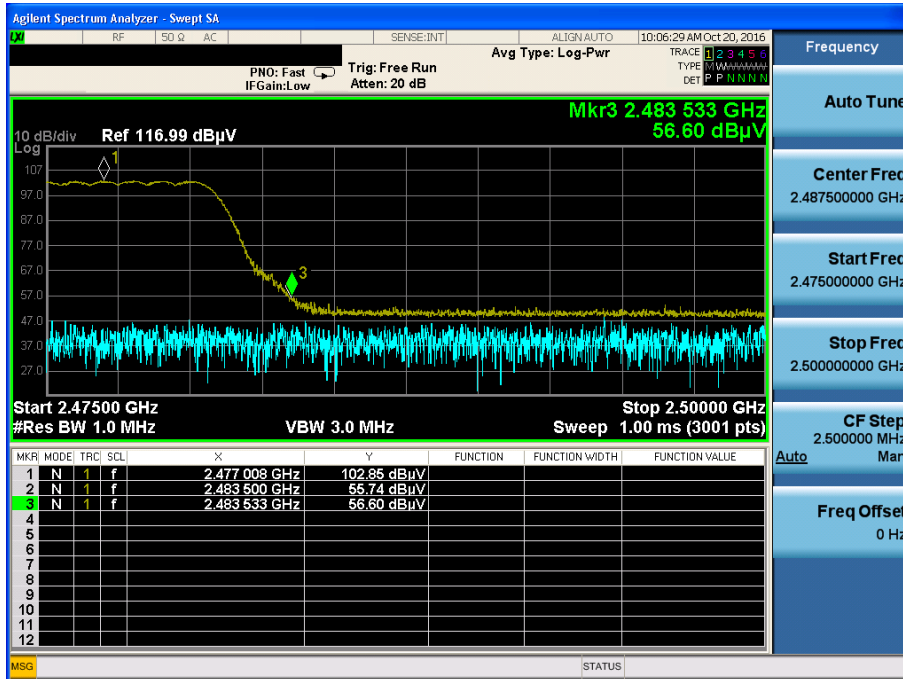

8DPSK & Hopping mode & X & Hor

Detector Mode : AV



MODE : IW05-DU_Module Type 3

GFSK & Lowest & Z & Hor

Detector Mode : PK

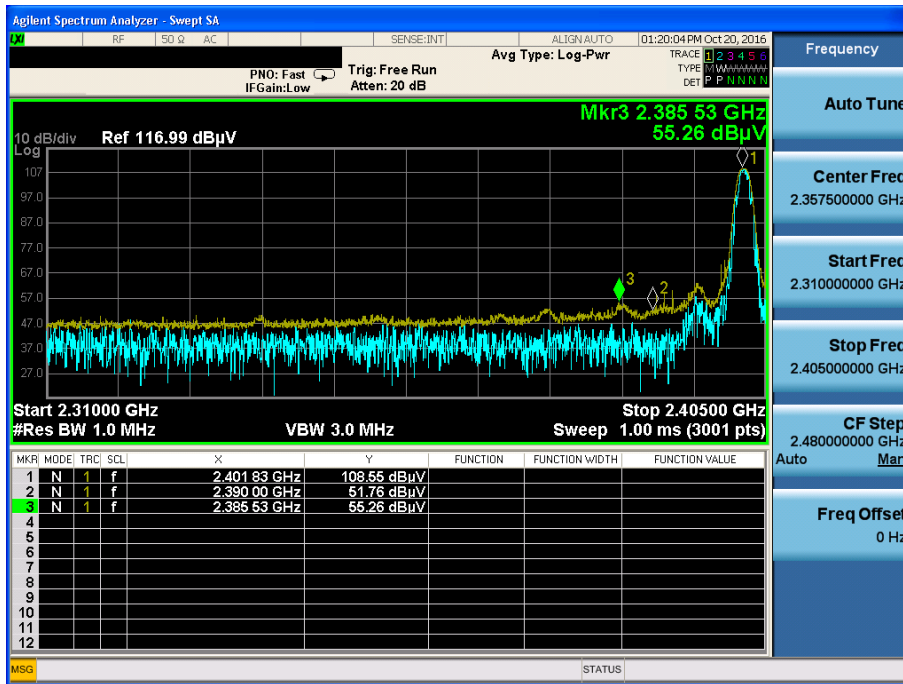

GFSK & Lowest & Z & Hor

Detector Mode : AV

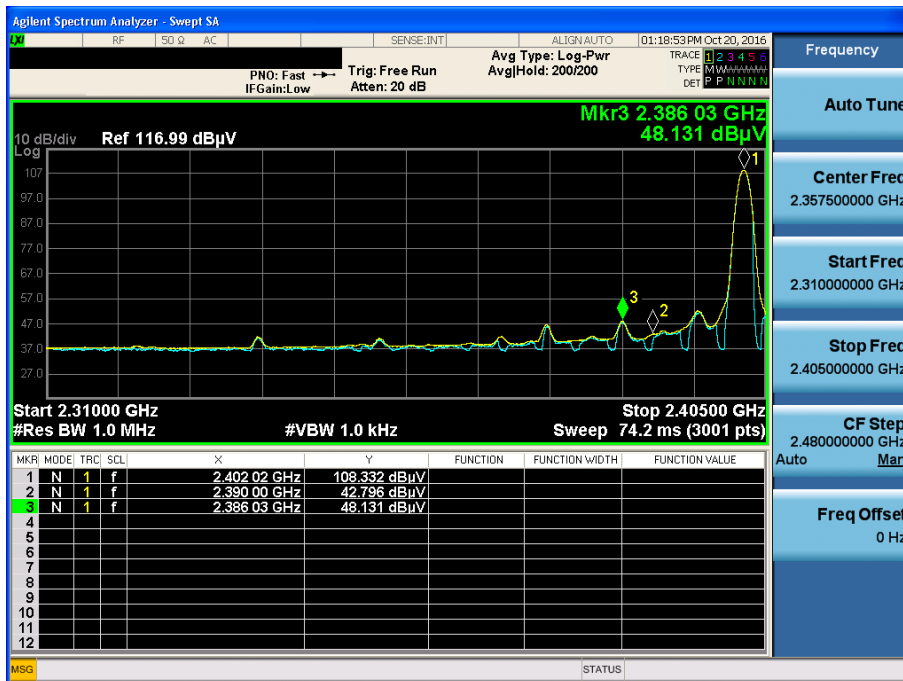

GFSK & Highest & Z & Hor

Detector Mode : PK

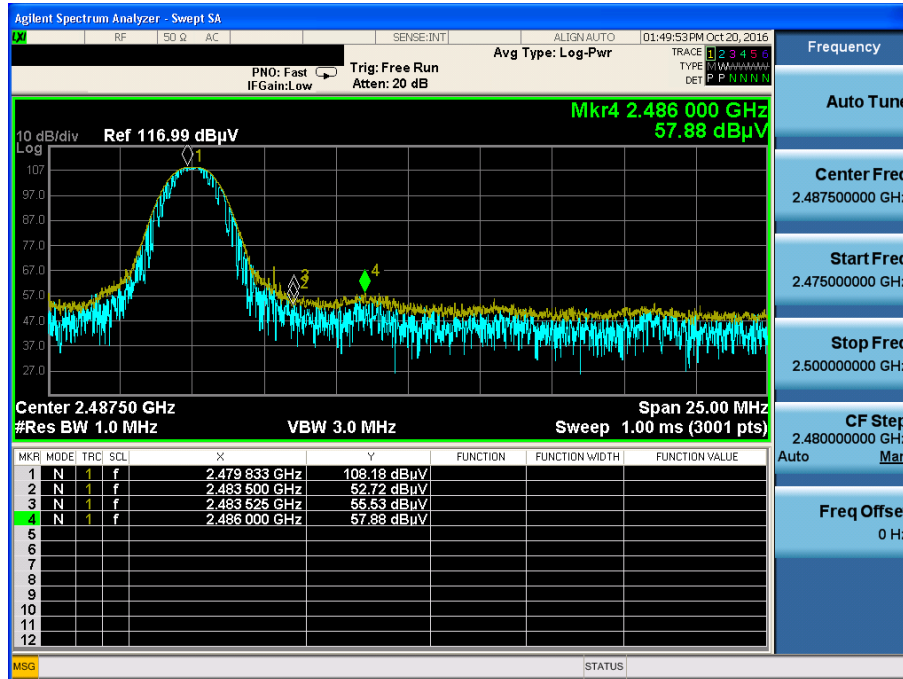

GFSK & Highest & Z & Hor

Detector Mode : AV

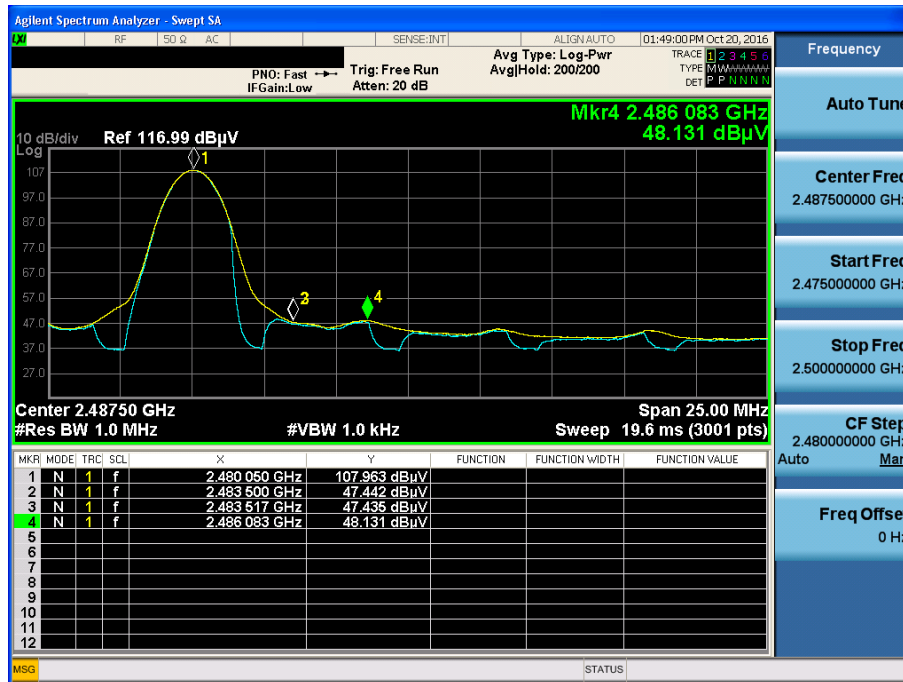

π /4DQPSK & Lowest & Z & Hor

Detector Mode : PK

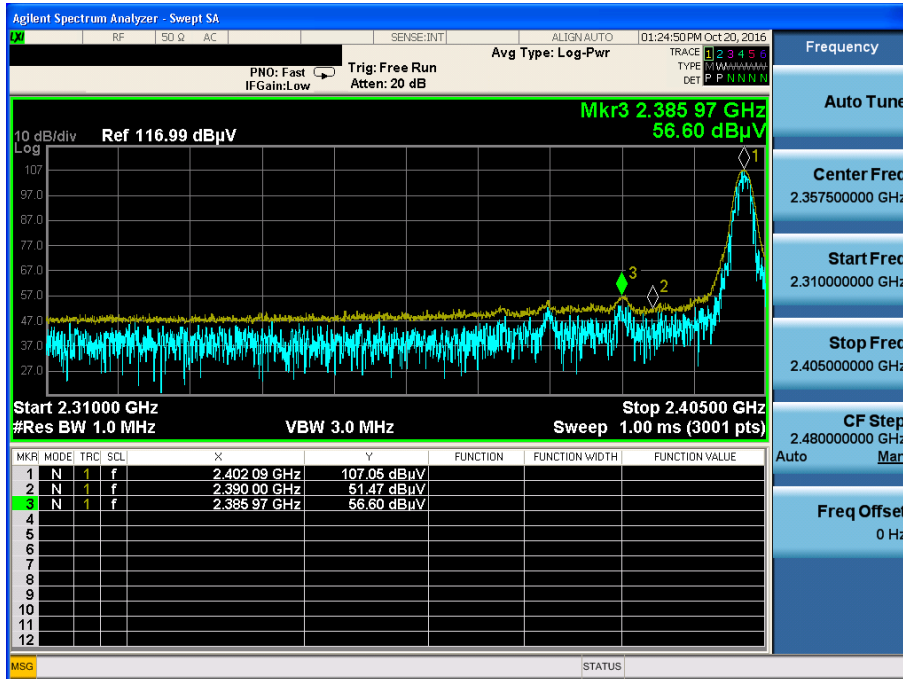

π /4DQPSK & Lowest & Z & Hor

Detector Mode : AV

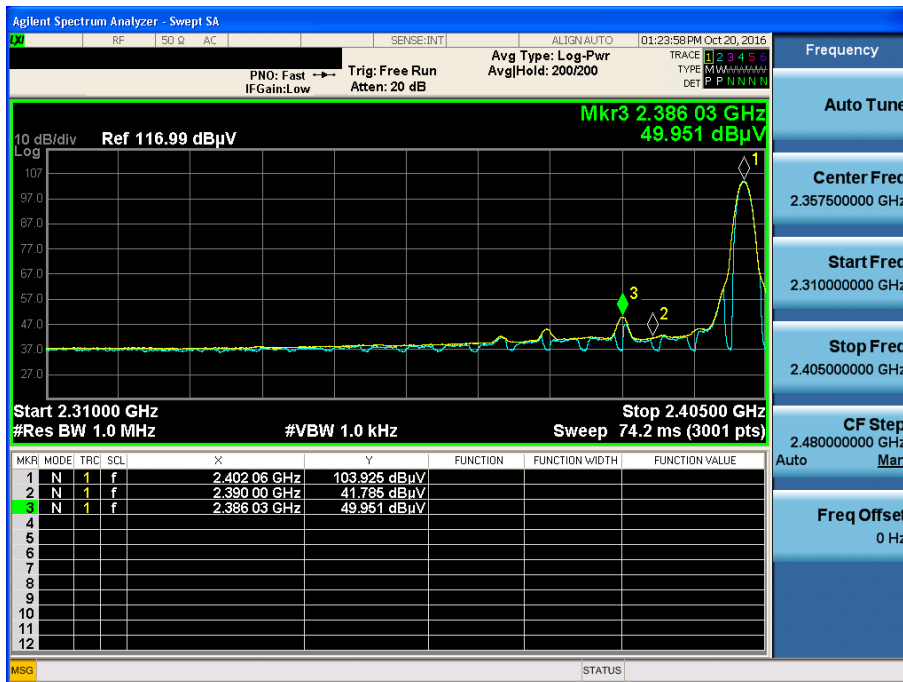

π /4DQPSK & Highest & Z & Hor

Detector Mode : PK

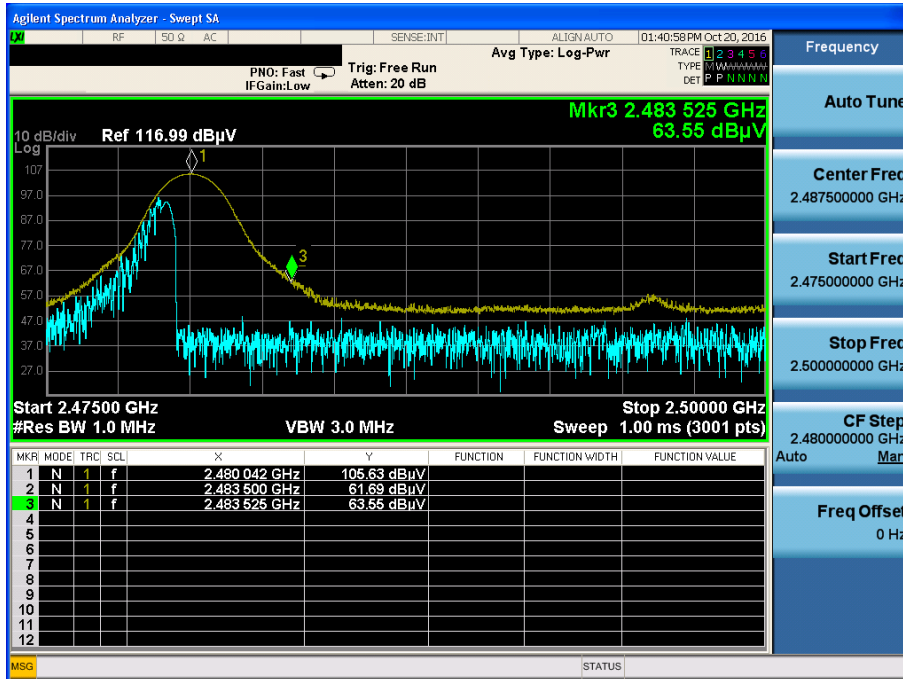

π /4DQPSK & Highest & Z & Hor

Detector Mode : AV

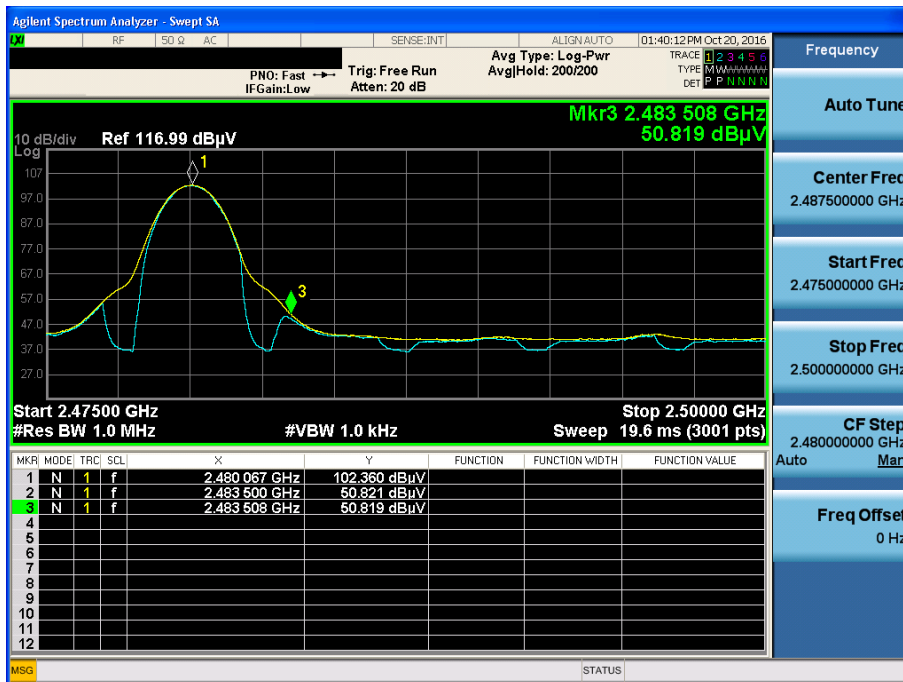

8DPSK & Lowest & Z & Hor

Detector Mode : PK

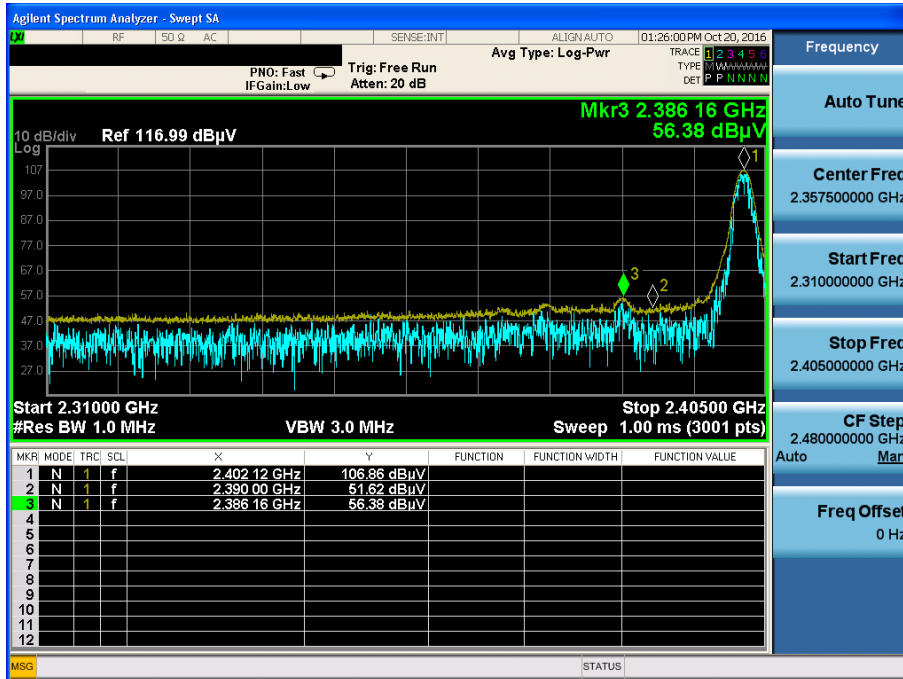

8DPSK & Lowest & Z & Hor

Detector Mode : AV

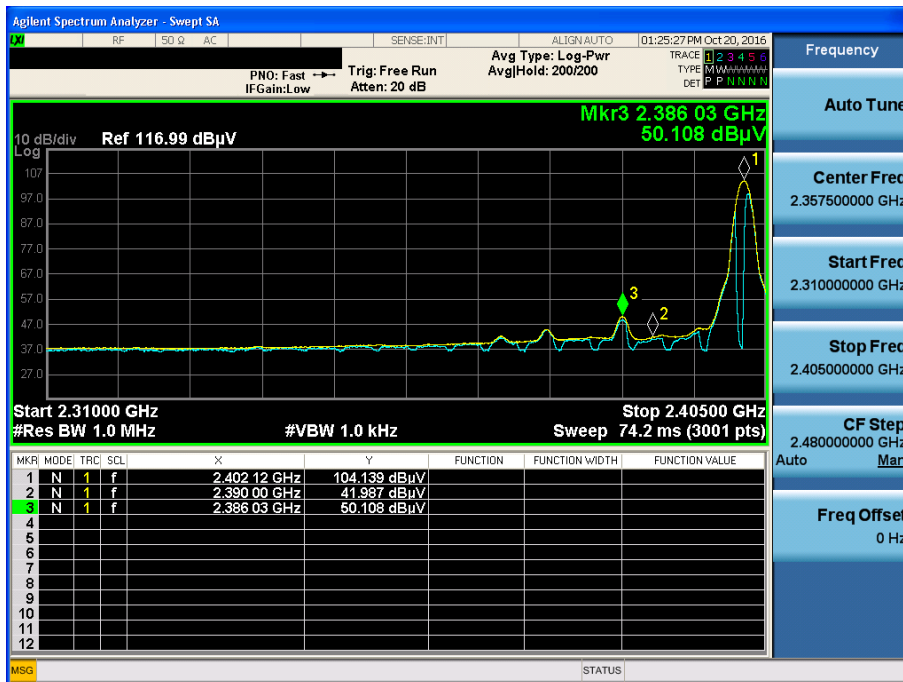

8DPSK & Highest & Z & Hor

Detector Mode : PK

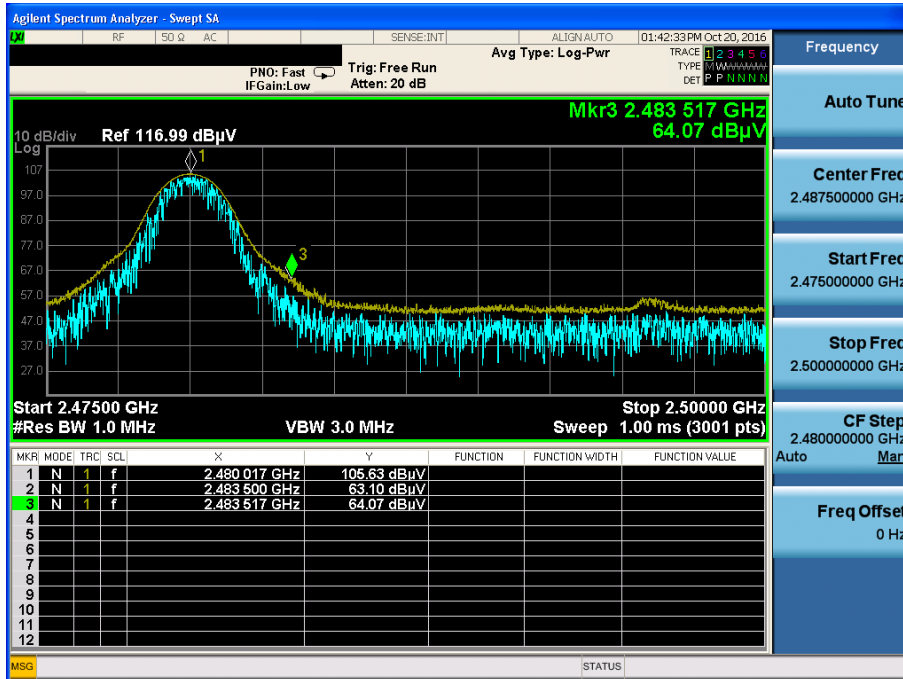

8DPSK & Highest & Z & Hor

Detector Mode : AV

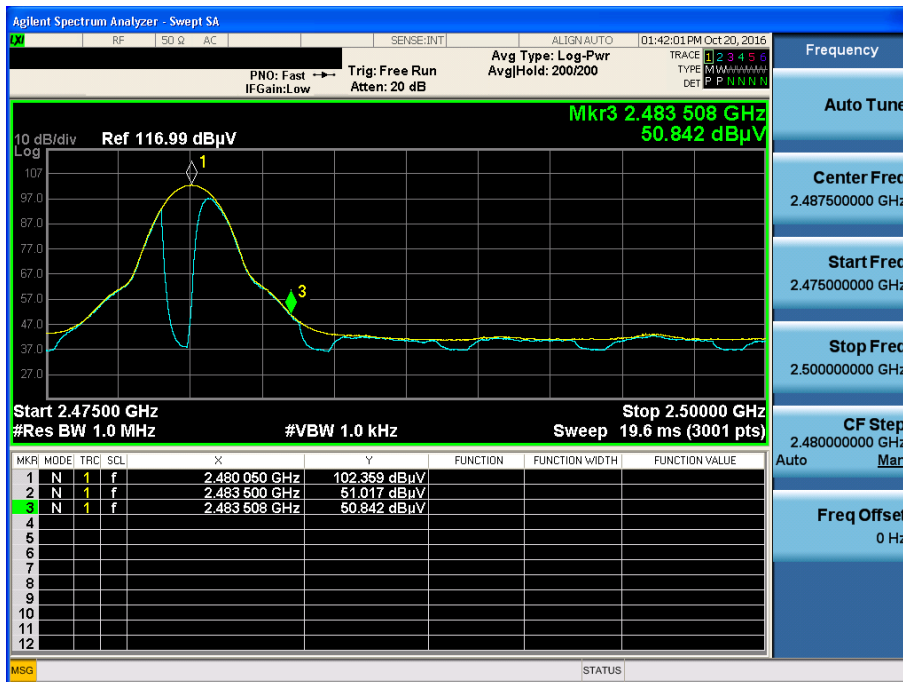

GFSK & Highest & Z & Hor

Detector Mode : PK

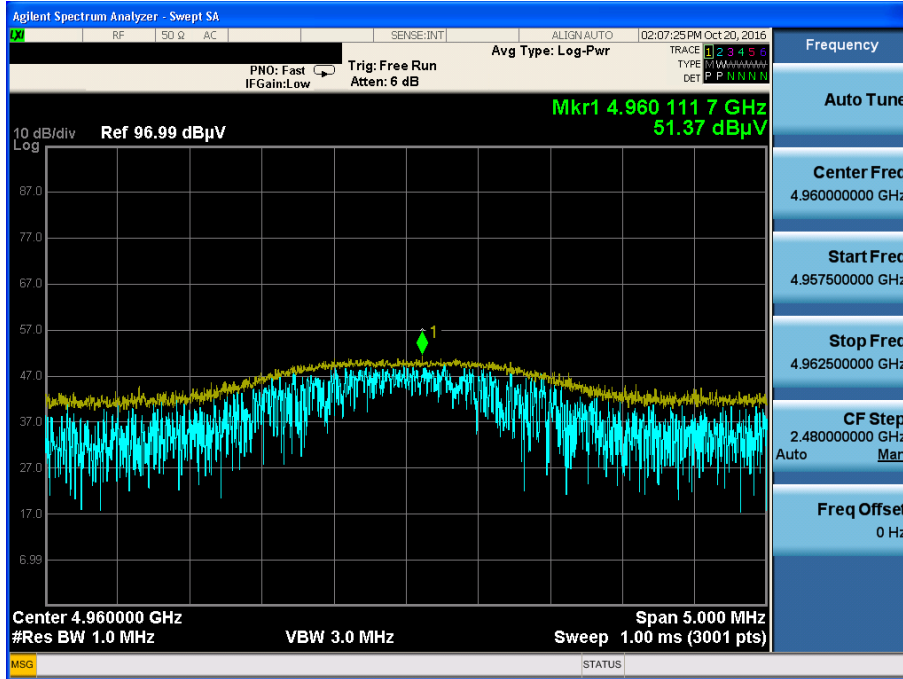

$\pi/4$ DQPSK & Lowest & Z & Hor

Detector Mode : PK

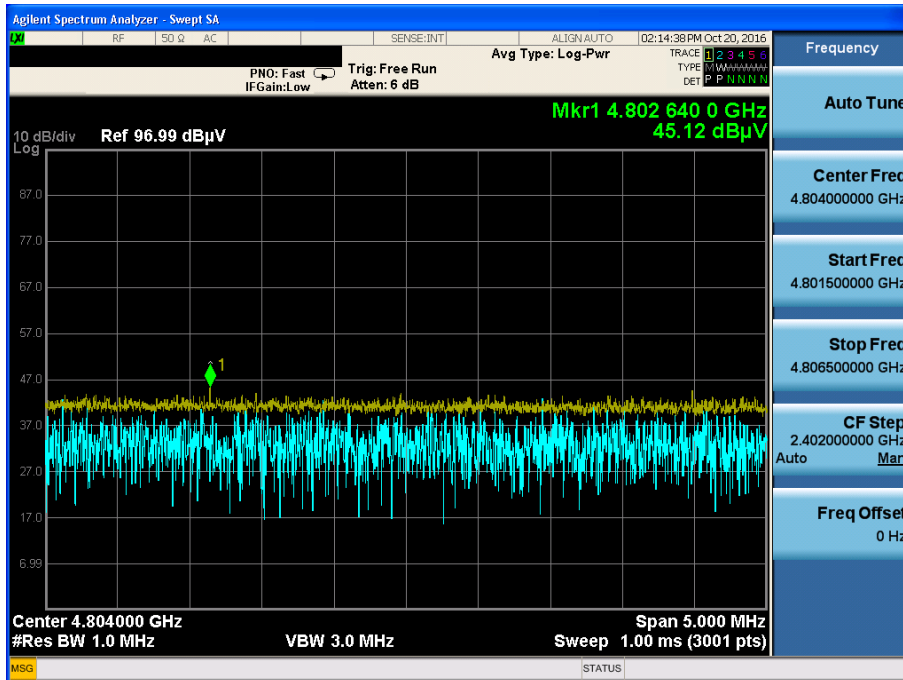

8DPSK & Highest & Z & Hor

Detector Mode : PK

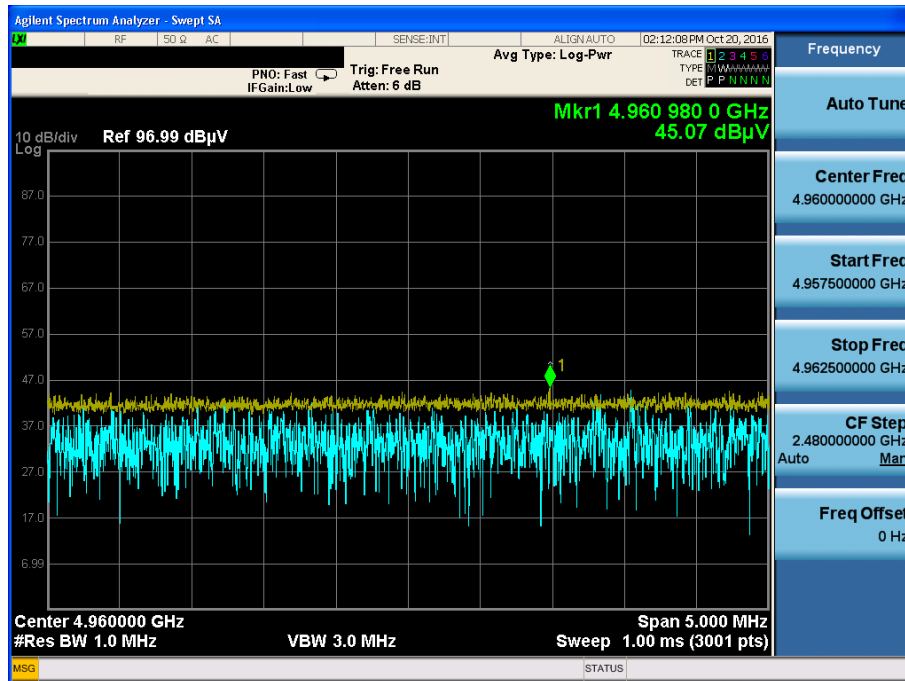

GFSK & Hopping mode & Z & Hor

Detector Mode : PK

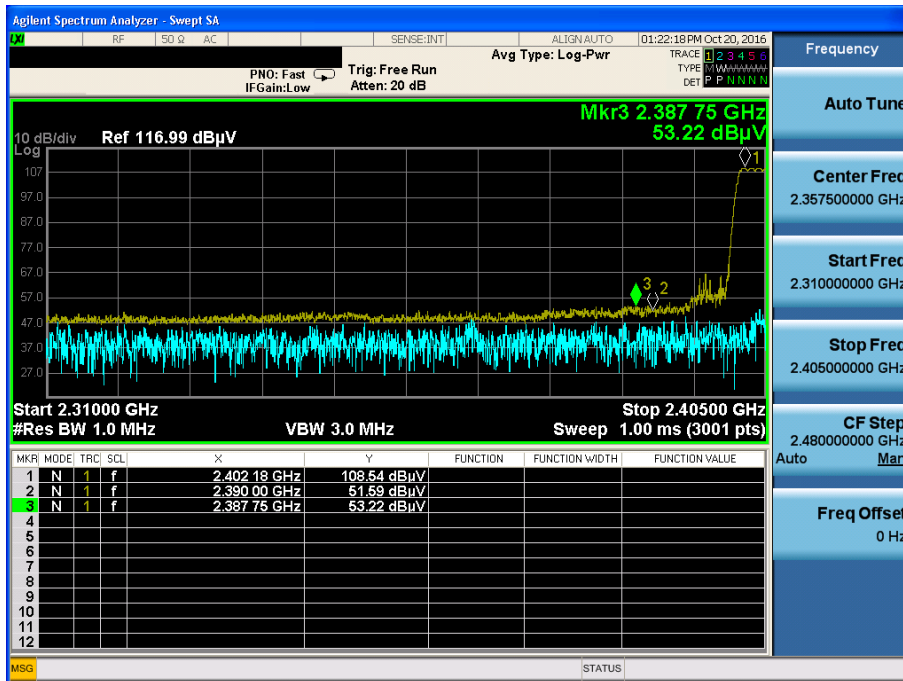

GFSK & Hopping mode & Z & Hor

Detector Mode : AV

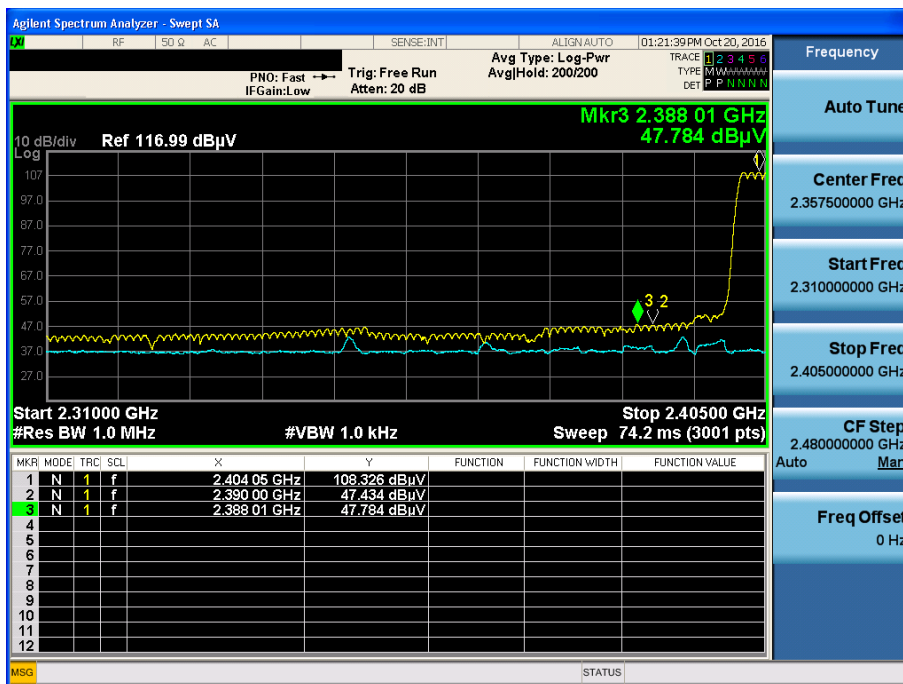

GFSK & Hopping mode & Z & Hor

Detector Mode : PK

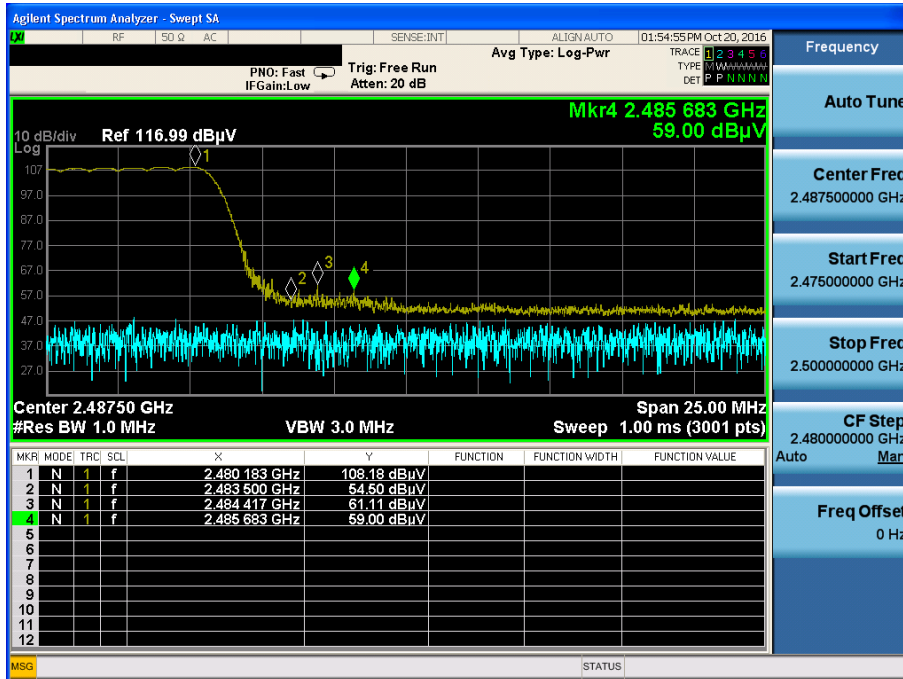

GFSK & Hopping mode & Z & Hor

Detector Mode : AV

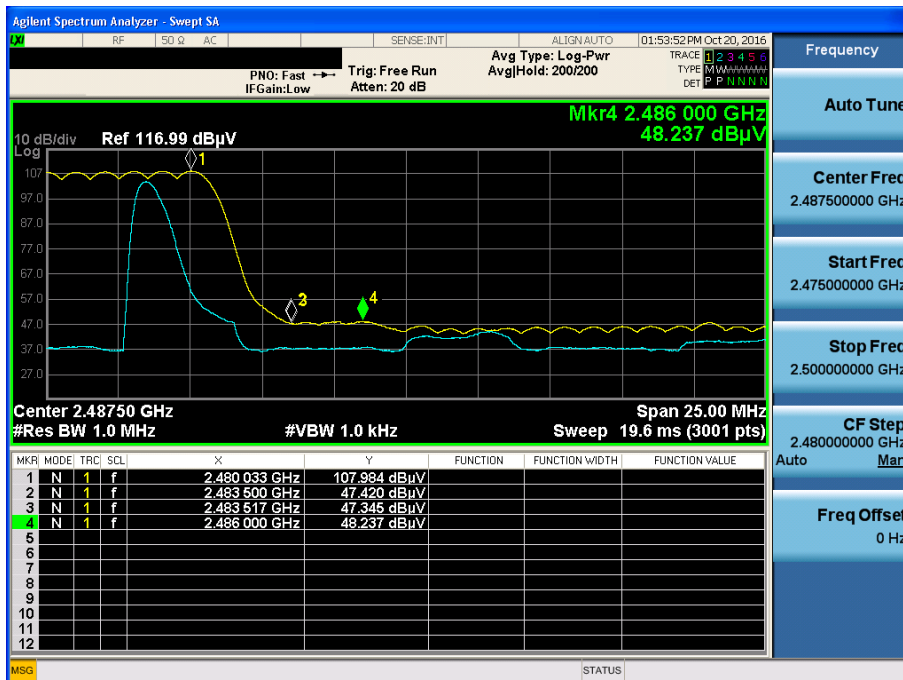

π /4DQPSK & Hopping mode & Z & Hor

Detector Mode : PK

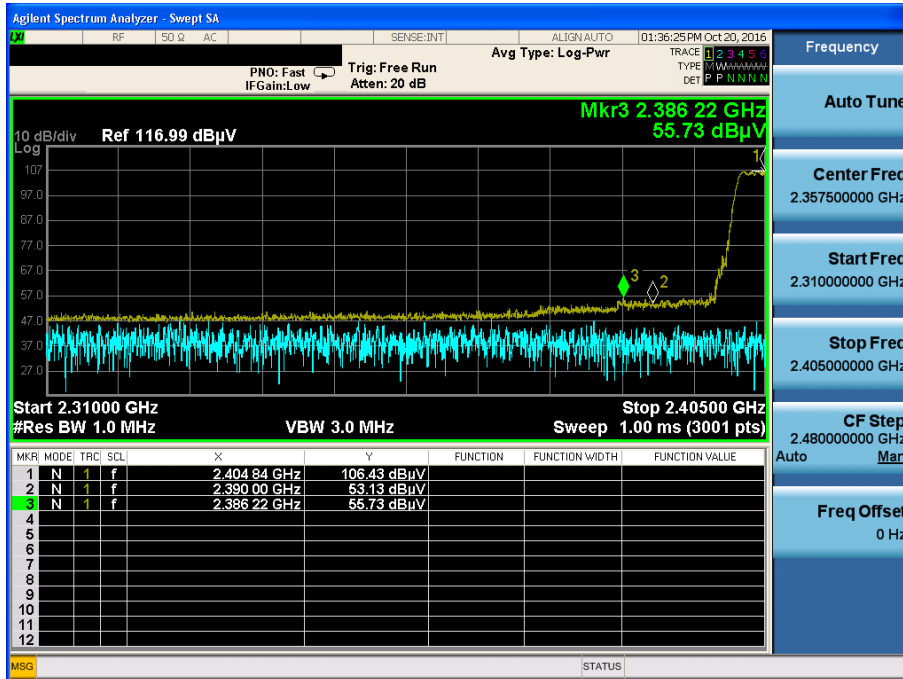

π /4DQPSK & Hopping mode & Z & Hor

Detector Mode : AV



π /4DQPSK & Hopping mode & Z & Hor

Detector Mode : PK

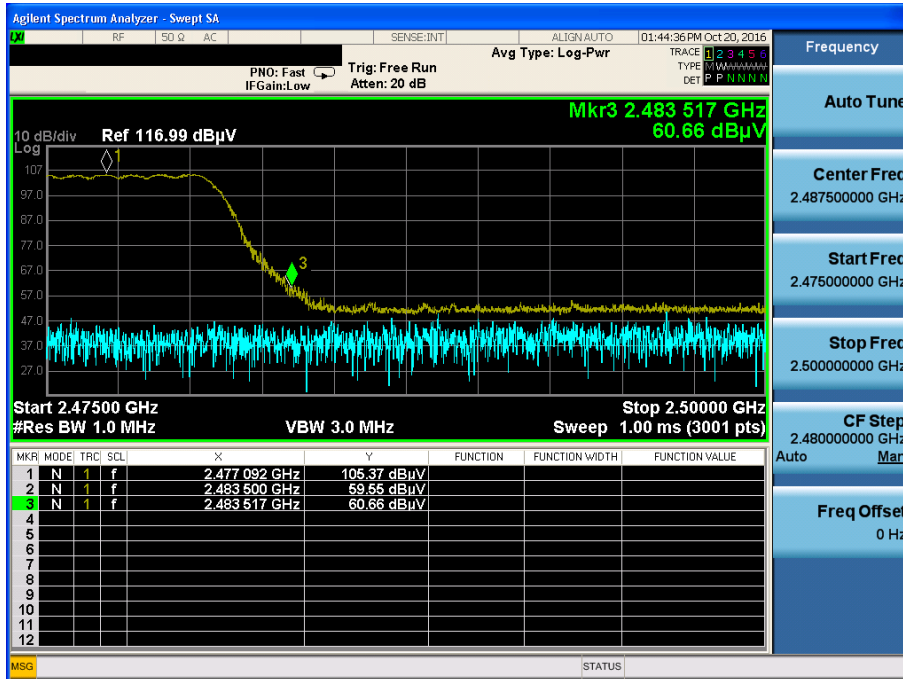

π /4DQPSK & Hopping mode & Z & Hor

Detector Mode : AV



8DPSK & Hopping mode & Z & Hor

Detector Mode : PK

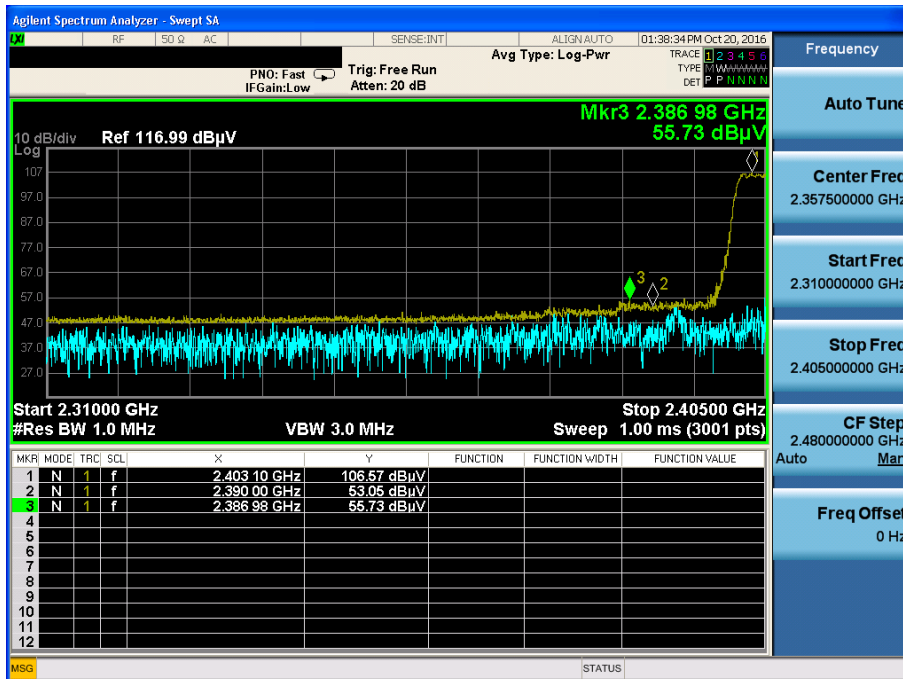

8DPSK & Hopping mode & Z & Hor

Detector Mode : AV



8DPSK & Hopping mode & Z & Hor

Detector Mode : PK

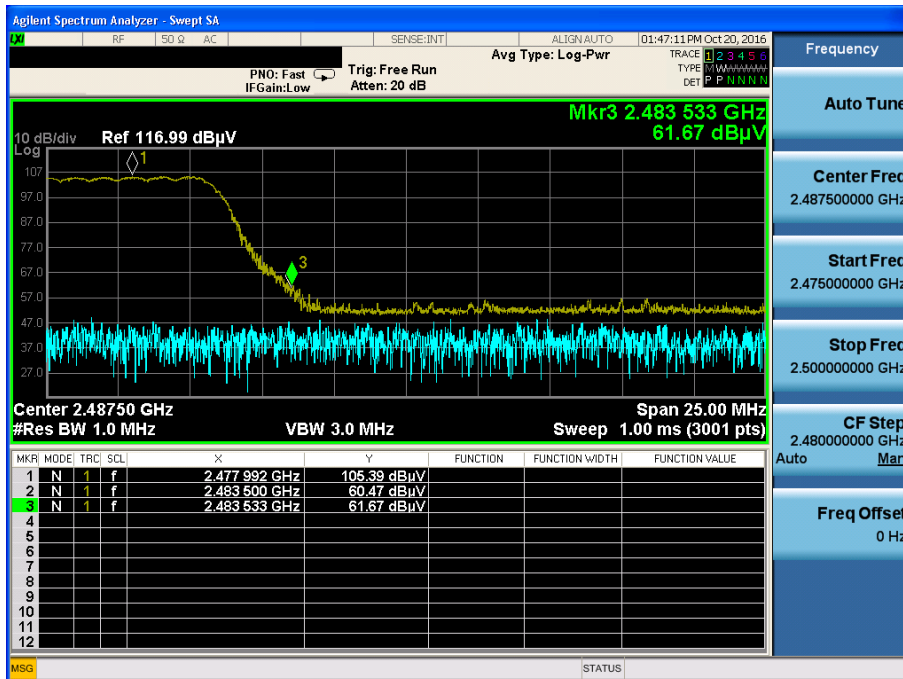

8DPSK & Hopping mode & Z & Hor

Detector Mode : AV

