

## FCC Test Report

**Report No.:** RF190529C27

**FCC ID:** S6J2128P

**Test Model:** 2128P (refer to item 3.1 for more details)

**Received Date:** May 29, 2019

**Test Date:** Jun. 10 ~ Aug. 15, 2019

**Issued Date:** Aug. 22, 2019

**Applicant:** Technology Solutions (UK) Ltd

**Address:** Suite A, Loughborough Technology Centre, Epinal Way, Loughborough,  
Leicestershire, LE11 3GE, United Kingdom

**Issued By:** Bureau Veritas Consumer Products Services (H.K.) Ltd., Taoyuan Branch

**Lab Address:** No. 47-2, 14th Ling, Chia Pau Vil., Lin Kou Dist., New Taipei City, Taiwan  
(R.O.C.)

**Test Location:** No. 19, Hwa Ya 2nd Rd., Wen Hwa Vil., Kwei Shan Dist., Taoyuan City  
33383, TAIWAN (R.O.C.)

**FCC Registration /  
Designation Number:** 788550 / TW0003



This report is for your exclusive use. Any copying or replication of this report to or for any other person or entity, or use of our name or trademark, is permitted only with our prior written permission. This report sets forth our findings solely with respect to the test samples identified herein. The results set forth in this report are not indicative or representative of the quality or characteristics of the lot from which a test sample was taken or any similar or identical product unless specifically and expressly noted. Our report includes all of the tests requested by you and the results thereof based upon the information that you provided to us. You have 60 days from date of issuance of this report to notify us of any material error or omission caused by our negligence, provided, however, that such notice shall be in writing and shall specifically address the issue you wish to raise. A failure to raise such issue within the prescribed time shall constitute your unqualified acceptance of the completeness of this report, the tests conducted and the correctness of the report contents. Unless specific mention, the uncertainty of measurement has been explicitly taken into account to declare the compliance or non-compliance to the specification. This report should not be used by the client to claim product certification, approval, or endorsement by TAF or any government agencies.

## Table of Contents

<b>Release Control Record</b> .....	<b>4</b>
<b>1 Certificate of Conformity</b> .....	<b>5</b>
<b>2 Summary of Test Results</b> .....	<b>6</b>
2.1 Measurement Uncertainty.....	6
2.2 Modification Record.....	6
<b>3 General Information</b> .....	<b>7</b>
3.1 General Description of EUT.....	7
3.2 Description of Test Modes.....	8
3.2.1 Test Mode Applicability and Tested Channel Detail.....	9
3.3 Duty Cycle of Test Signal.....	10
3.4 Description of Support Units.....	10
3.4.1 Configuration of System under Test.....	11
3.5 General Description of Applied Standards.....	11
<b>4 Test Types and Results</b> .....	<b>12</b>
4.1 Radiated Emission and Bandedge Measurement.....	12
4.1.1 Limits of Radiated Emission and Bandedge Measurement.....	12
4.1.2 Test Instruments.....	13
4.1.3 Test Procedures.....	14
4.1.4 Deviation from Test Standard.....	14
4.1.5 Test Setup.....	15
4.1.6 EUT Operating Conditions.....	16
4.1.7 Test Results.....	17
4.2 Conducted Emission Measurement.....	28
4.2.1 Limits of Conducted Emission Measurement.....	28
4.2.2 Test Instruments.....	28
4.2.3 Test Procedures.....	29
4.2.4 Deviation from Test Standard.....	29
4.2.5 Test Setup.....	29
4.2.6 EUT Operating Conditions.....	29
4.2.7 Test Results.....	30
4.3 6dB Bandwidth Measurement.....	34
4.3.1 Limits of 6dB Bandwidth Measurement.....	34
4.3.2 Test Setup.....	34
4.3.3 Test Instruments.....	34
4.3.4 Test Procedure.....	34
4.3.5 Deviation from Test Standard.....	34
4.3.6 EUT Operating Conditions.....	34
4.3.7 Test Result.....	35
4.4 Conducted Output Power Measurement.....	36
4.4.1 Limits of Conducted Output Power Measurement.....	36
4.4.2 Test Setup.....	36
4.4.3 Test Instruments.....	36
4.4.4 Test Procedures.....	36
4.4.5 Deviation from Test Standard.....	36
4.4.6 EUT Operating Conditions.....	36
4.4.7 Test Results.....	36
4.5 Power Spectral Density Measurement.....	37
4.5.1 Limits of Power Spectral Density Measurement.....	37
4.5.2 Test Setup.....	37
4.5.3 Test Instruments.....	37
4.5.4 Test Procedure.....	37
4.5.5 Deviation from Test Standard.....	37
4.5.6 EUT Operating Condition.....	37

4.5.7 Test Results .....	38
4.6 Conducted Out of Band Emission Measurement.....	39
4.6.1 Limits of Conducted Out of Band Emission Measurement .....	39
4.6.2 Test Setup.....	39
4.6.3 Test Instruments .....	39
4.6.4 Test Procedure .....	39
4.6.5 Deviation from Test Standard .....	39
4.6.6 EUT Operating Condition .....	39
4.6.7 Test Results .....	39
<b>5 Pictures of Test Arrangements.....</b>	<b>41</b>
<b>Appendix – Information of the Testing Laboratories .....</b>	<b>42</b>

### Release Control Record

Issue No.	Description	Date Issued
RF190529C27	Original release	Aug. 22, 2019

## 1 Certificate of Conformity

**Product:** 2128P Bluetooth Handheld UHF RFID Reader

**Brand:** Technology Solutions (UK) Ltd

**Test Model:** 2128P (refer to item 3.1 for more details)

**Sample Status:** Engineering sample

**Applicant:** Technology Solutions (UK) Ltd

**Test Date:** Jun. 10 ~ Aug. 15, 2019

**Standards:** 47 CFR FCC Part 15, Subpart C (Section 15.247)  
ANSI C63.10:2013

The above equipment has been tested by **Bureau Veritas Consumer Products Services (H.K.) Ltd., Taoyuan Branch**, and found compliance with the requirement of the above standards. The test record, data evaluation & Equipment Under Test (EUT) configurations represented herein are true and accurate accounts of the measurements of the sample's RF characteristics under the conditions specified in this report.

**Prepared by :** Celine Chou , **Date:** Aug. 22, 2019  
Celine Chou / Senior Specialist

**Approved by :** Bruce Chen , **Date:** Aug. 22, 2019  
Bruce Chen / Senior Project Engineer

## 2 Summary of Test Results

47 CFR FCC Part 15, Subpart C (Section 15.247)			
FCC Clause	Test Item	Result	Remarks
15.207	AC Power Conducted Emission	Pass	Meet the requirement of limit. Minimum passing margin is -11.27dB at 0.16922MHz.
15.205 / 15.209 / 15.247(d)	Radiated Emissions and Band Edge Measurement	Pass	Meet the requirement of limit. Minimum passing margin is -4.3dB at 2390.00MHz.
15.247(d)	Antenna Port Emission	Pass	Meet the requirement of limit.
15.247(a)(2)	6dB bandwidth	Pass	Meet the requirement of limit.
15.247(b)	Conducted power	Pass	Meet the requirement of limit.
15.247(e)	Power Spectral Density	Pass	Meet the requirement of limit.
15.203	Antenna Requirement	Pass	No antenna connector is used.

Note: Determining compliance based on the results of the compliance measurement, not taking into account measurement instrumentation uncertainty.

### 2.1 Measurement Uncertainty

Where relevant, the following measurement uncertainty levels have been estimated for tests performed on the EUT as specified in CISPR 16-4-2:

Measurement	Frequency	Expanded Uncertainty (k=2) (±)
Conducted Emissions at mains ports	150kHz ~ 30MHz	2.94 dB
Radiated Emissions up to 1 GHz	9kHz ~ 30MHz	3.04 dB
	30MHz ~ 200MHz	3.86 dB
	200MHz ~ 1000MHz	3.87 dB
Radiated Emissions above 1 GHz	1GHz ~ 18GHz	2.29 dB
	18GHz ~ 40GHz	2.29 dB

### 2.2 Modification Record

There were no modifications required for compliance.

### 3 General Information

#### 3.1 General Description of EUT

Product	2128P Bluetooth Handheld UHF RFID Reader
Brand	Technology Solutions (UK) Ltd
Test Model	2128P
Sample Status	Engineering sample
Power Supply Rating	3.6Vdc or 3.7Vdc (Handle's battery) 5.2Vdc (Charging Cradle's adapter)
Modulation Type	GFSK
Transfer Rate	1Mbps
Operating Frequency	2402 ~ 2480MHz
Number of Channel	40
Channel Spacing	2MHz
Output Power	3.199mW
Antenna Type	Ceramic Chip Antenna with 1dBi gain
Antenna Connector	NA
Accessory Device	Refer to note
Cable Supplied	NA

Note:

- All models are listed as below. Part Number: 2128P-AS1 was chosen for final test.

Model	Part Number	Variant Description	Remark
2128P	2128P-AX1	FCC/North America - No Imager	RFID Frequency Band is 902-928 MHz
	2128P-AS1	FCC/North America - with 2D Imager	RFID Frequency Band is 902-928 MHz, SE4750 Barcode Imager.

2. The EUT tests with following devices and cables.

Item	Brand	Model		Specification	Remark
Dummy Battery (for EUT use)	Technology Solutions (UK) Ltd	MD-2102-001		-	Accessory (Optional)
CT50	Honeywell	CT50		-	Support Unit
Smart Phone	Motorola	Moto E5		-	Support Unit
Handles	Technology Solutions (UK) Ltd	2102	P/N: 2102-PH-Y	Accessory (Optional)	Accessory
			P/N: 2102-PH-R	Accessory (Optional)	Accessory
		2128-TRG	P/N: 2128-TRG	Accessory	Accessory
			P/N: IH21-TRG	Accessory	Accessory
Battery (for Handle 2102)	Fey	PA-UL-LNB46E		Fey PA-UL-LNB46E (integrated into Power Handle) Rating: 3.6Vdc	Integrated into 2102
Battery (for Handle 2128-TRG)	VARTA Storage GmbH	EZPack XL, 11CP5/35/60-2		Varta EZPack XL (fitted to 2128P Main Body) Rating: 3.7Vdc	Accessory
Charging Cradle	Technology Solutions (UK) Ltd	2128-CRD		S-Mark File Number: CUBA 5.2Vdc, 4.0A Input (PSU:T6607YY)	Support Unit
Adapter (for Cradle use)	STONTRONICS	T6607YY		Input: 100-240Vac, 50/60Hz Output: 5.2Vdc, 4.0A Cable: 1.45m power cable without core attached on adapter	Support Unit
Micro USB cable (for Cradle use)	N/A	N/A		0.95m shielded with 4 cores	Support Unit
Micro SD Card	Kingston	8GB		-	Support Unit

3.2 Description of Test Modes

40 channels are provided to this EUT:

Channel	Freq. (MHz)	Channel	Freq. (MHz)	Channel	Freq. (MHz)	Channel	Freq. (MHz)
0	2402	10	2422	20	2442	30	2462
1	2404	11	2424	21	2444	31	2464
2	2406	12	2426	22	2446	32	2466
3	2408	13	2428	23	2448	33	2468
4	2410	14	2430	24	2450	34	2470
5	2412	15	2432	25	2452	35	2472
6	2414	16	2434	26	2454	36	2474
7	2416	17	2436	27	2456	37	2476
8	2418	18	2438	28	2458	38	2478
9	2420	19	2440	29	2460	39	2480



### 3.2.1 Test Mode Applicability and Tested Channel Detail

EUT Configure Mode	Applicable to				Description
	RE $\geq$ 1G	RE<1G	PLC	APCM	
A	√	√	-	√	EUT + Handle (2102)
B	-	√	-	-	EUT + Handle (2128-TRG)
C	-	√	√	-	EUT + Handle (2102) + Charging Cradle (2128-CRD)
D	-	√	√	-	EUT + Handle (2128-TRG) + Charging Cradle (2128-CRD)

Where RE $\geq$ 1G: Radiated Emission above 1GHz & Bandedge Measurement  
 RE<1G: Radiated Emission below 1GHz  
 PLC: Power Line Conducted Emission  
 APCM: Antenna Port Conducted Measurement

Note:

- The EUT had been pre-tested on the positioned of each 3 axis. The worst case was found when positioned on **Y-plane for test mode A and B & Z-plane for test mode C and D.**
- Radiated emission test (below 1GHz) and power line conducted emission test items chosen the worst maximum power.

#### **Radiated Emission Test (Above 1GHz):**

- Pre-Scan has been conducted to determine the worst-case mode from all possible combinations between available modulations, data rates and antenna ports (if EUT with antenna diversity architecture).
- Following channel(s) was (were) selected for the final test as listed below.

EUT Configure Mode	Available Channel	Tested Channel	Modulation Type	Data Rate (Mbps)
A	0 to 39	0, 19, 39	GFSK	1

#### **Radiated Emission Test (Below 1GHz):**

- Pre-Scan has been conducted to determine the worst-case mode from all possible combinations between available modulations, data rates and antenna ports (if EUT with antenna diversity architecture).
- Following channel(s) was (were) selected for the final test as listed below.

EUT Configure Mode	Available Channel	Tested Channel	Modulation Type	Data Rate (Mbps)
A, B, C, D	0 to 39	39	GFSK	1

#### **Power Line Conducted Emission Test:**

- Pre-Scan has been conducted to determine the worst-case mode from all possible combinations between available modulations, data rates and antenna ports (if EUT with antenna diversity architecture).
- Following channel(s) was (were) selected for the final test as listed below.

EUT Configure Mode	Available Channel	Tested Channel	Modulation Type	Data Rate (Mbps)
C, D	0 to 39	39	GFSK	1

#### **Antenna Port Conducted Measurement:**

- This item includes all test value of each mode, but only includes spectrum plot of worst value of each mode.
- Pre-Scan has been conducted to determine the worst-case mode from all possible combinations between available modulations, data rates and antenna ports (if EUT with antenna diversity architecture).
- Following channel(s) was (were) selected for the final test as listed below.

EUT Configure Mode	Available Channel	Tested Channel	Modulation Type	Data Rate (Mbps)
A	0 to 39	0, 19, 39	GFSK	1

**Test Condition:**

Applicable to	Environmental Conditions	Input Power	Tested by
RE≥1G	23 deg. C, 67% RH	3.7Vdc	Adair Peng
RE<1G	25 deg. C, 68% RH	3.6Vdc 3.7Vdc 120Vac, 60Hz	Willy Cheng
PLC	23 deg. C, 66% RH	120Vac, 60Hz	Willy Cheng
APCM	25 deg. C, 60% RH	3.7Vdc	Alan Wu

**3.3 Duty Cycle of Test Signal**

Duty cycle of test signal is < 98%.

Duty cycle = 0.400/0.628 = 0.637, Duty factor = 10 \* log (1/0.637) = 1.96

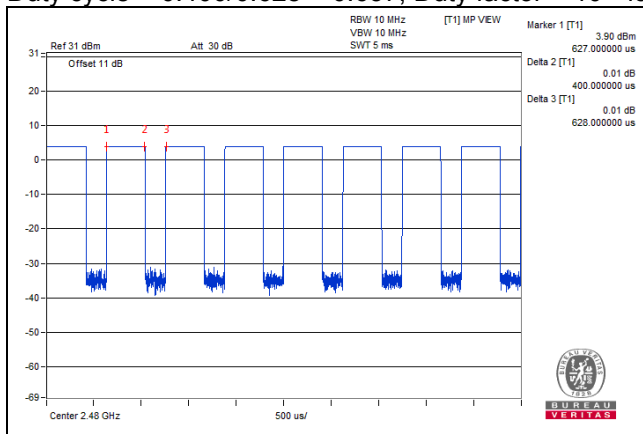

**3.4 Description of Support Units**

The EUT has been tested as an independent unit together with other necessary accessories or support units. The following support units or accessories were used to form a representative test configuration during the tests.

ID	Product	Brand	Model No.	Serial No.	FCC ID	Remarks
A.	Adapter	STONTRONICS	T6607YY	NA	NA	Provided by client For test mode C and D
B.	CT50	Honeywell	CT50	NA	NA	Provided by client For test mode A and B
C.	Charging Cradle	Technology Solutions (UK) Ltd	2128-CRD	NA	NA	Provided by client For test mode C and D
D.	Handle	Technology Solutions (UK) Ltd	2102	NA	NA	Accessory of EUT For test mode A and C
		Technology Solutions (UK) Ltd	2128-TRG	NA	NA	Accessory of EUT For test mode B and D

Note: All power cords of the above support units are non-shielded (1.8m).

ID	Descriptions	Qty.	Length (m)	Shielding (Yes/No)	Cores (Qty.)	Remarks
1.	Power cable	1	1.45	N	0	Provided by client Attached on adapter

### 3.4.1 Configuration of System under Test

Test Mode A and B

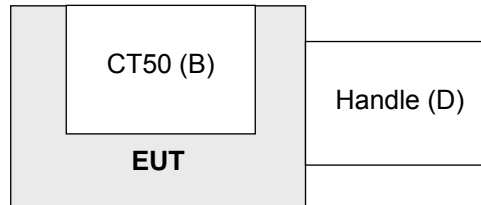

Test Mode C and D

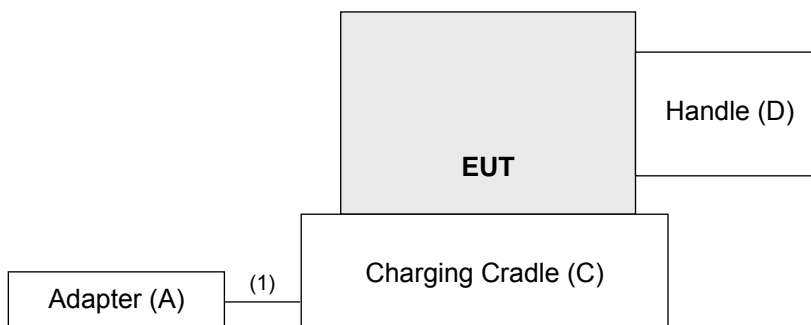

### 3.5 General Description of Applied Standards

The EUT is a RF Product. According to the specifications of the manufacturer, it must comply with the requirements of the following standards:

**FCC Part 15, Subpart C (15.247)**

**KDB 558074 D01 15.247 Meas Guidance v05r02**

ANSI C63.10:2013

All test items have been performed and recorded as per the above standards.

## 4 Test Types and Results

### 4.1 Radiated Emission and Bandedge Measurement

#### 4.1.1 Limits of Radiated Emission and Bandedge Measurement

Radiated emissions which fall in the restricted bands must comply with the radiated emission limits specified as below table. Other emissions shall be at least 20dB below the highest level of the desired power:

Frequencies (MHz)	Field Strength (microvolts/meter)	Measurement Distance (meters)
0.009 ~ 0.490	2400/F(kHz)	300
0.490 ~ 1.705	24000/F(kHz)	30
1.705 ~ 30.0	30	30
30 ~ 88	100	3
88 ~ 216	150	3
216 ~ 960	200	3
Above 960	500	3

**Note:**

1. The lower limit shall apply at the transition frequencies.
2. Emission level (dBuV/m) = 20 log Emission level (uV/m).
3. For frequencies above 1000MHz, the field strength limits are based on average detector, however, the peak field strength of any emission shall not exceed the maximum permitted average limits, specified above by more than 20dB under any condition of modulation.

#### 4.1.2 Test Instruments

Description & Manufacturer	Model No.	Serial No.	Cal. Date	Cal. Due
Test Receiver ROHDE & SCHWARZ	ESIB7	100187	May 30, 2019	May 29, 2020
Spectrum Analyzer ROHDE & SCHWARZ	FSP40	100269	Jun. 10, 2019	Jun. 09, 2020
BILOG Antenna SCHWARZBECK	VULB9168	9168-171	Nov. 22, 2018	Nov. 21, 2019
HORN Antenna SCHWARZBECK	9120D	209	Nov. 25, 2018	Nov. 24, 2019
HORN Antenna SCHWARZBECK	BBHA 9170	BBHA9170241	Nov. 25, 2018	Nov. 24, 2019
Loop Antenna EMCI	EM-6879	269	Sep. 07, 2018	Sep. 06, 2019
Preamplifier Agilent (Below 1GHz)	8447D	2944A10738	Aug. 21, 2018	Aug. 20, 2019
Preamplifier Agilent (Above 1GHz)	8449B	3008A02465	Mar. 27, 2019	Mar. 26, 2020
RF Coaxial Cable WORKEN With 5dB PAD	8D-FB	Cable-CH3-01	Aug. 21, 2018	Aug. 20, 2019
RF signal cable HUBER+SUHNER	SUCOFLEX 104	Cable-CH3-03 (223653/4)	Aug. 21, 2018	Aug. 20, 2019
RF signal cable HUBER+SUHNER& EMCI	SUCOFLEX 104&EMC104-SM-S M-8000	Cable-CH3-03 (309224+170907)	Aug. 21, 2018	Aug. 20, 2019
Software BV ADT	ADT_Radiated_ V7.6.15.9.5	NA	NA	NA
Antenna Tower inn-co GmbH	MA 4000	013303	NA	NA
Antenna Tower Controller BV ADT	AT100	AT93021702	NA	NA
Turn Table BV ADT	TT100	TT93021702	NA	NA
Turn Table Controller BV ADT	SC100	SC93021702	NA	NA
Boresight Antenna Fixture	FBA-01	FBA-SIP01	NA	NA
Pre-amplifier (18GHz-40GHz) EMC	EMC184045B	980175	Nov. 14, 2018	Nov. 13, 2019
USB Wideband Power Sensor KEYSIGHT	U2021XA	MY55050005/MY5519 0004/MY55190007/MY 55210005	Jul. 17, 2018	Jul. 16, 2019
			Jul. 15, 2019	Jul. 14, 2020

Note: 1. The calibration interval of the above test instruments is 12 months and the calibrations are traceable to NML/ROC and NIST/USA.

2. The test was performed in HwaYa Chamber 3.

### 4.1.3 Test Procedures

#### For Radiated emission below 30MHz

- a. The EUT was placed on the top of a rotating table 0.8 meters above the ground at a 3 meter chamber room. The table was rotated 360 degrees to determine the position of the highest radiation.
- b. The EUT was set 3 meters away from the interference-receiving antenna, which was mounted on the top of a variable-height antenna tower.
- c. Parallel, perpendicular, and ground-parallel orientations of the antenna are set to make the measurement.
- d. For each suspected emission, the EUT was arranged to its worst case and the rotatable table was turned from 0 degrees to 360 degrees to find the maximum reading.
- e. The test-receiver system was set to Quasi-Peak Detect Function and Specified Bandwidth with Maximum Hold Mode.

Note:

1. The resolution bandwidth and video bandwidth of test receiver/spectrum analyzer is 9kHz at frequency below 30MHz.

#### For Radiated emission above 30MHz

- a. The EUT was placed on the top of a rotating table 0.8 meters (for 30MHz ~ 1GHz) / 1.5 meters (for above 1GHz) above the ground at 3 meter chamber room for test. The table was rotated 360 degrees to determine the position of the highest radiation.
- b. The EUT was set 3 meters away from the interference-receiving antenna, which was mounted on the top of a variable-height antenna tower.
- c. The height of antenna is varied from one meter to four meters above the ground to determine the maximum value of the field strength. Both horizontal and vertical polarizations of the antenna are set to make the measurement.
- d. For each suspected emission, the EUT was arranged to its worst case and then the antenna was tuned to heights from 1 meter to 4 meters and the rotatable table was turned from 0 degrees to 360 degrees to find the maximum reading.
- e. The test-receiver system was set to quasi-peak detect function and specified bandwidth with maximum hold mode when the test frequency is below 1 GHz.
- f. The test-receiver system was set to peak and average detect function and specified bandwidth with maximum hold mode when the test frequency is above 1 GHz. If the peak reading value also meets average limit, measurement with the average detector is unnecessary.

Note:

1. The resolution bandwidth and video bandwidth of test receiver/spectrum analyzer is 120kHz for Quasi-peak detection (QP) at frequency below 1GHz.
2. The resolution bandwidth of test receiver/spectrum analyzer is 1 MHz and the video bandwidth is 3 MHz for Peak detection (PK) at frequency above 1GHz.
3. The resolution bandwidth of test receiver/spectrum analyzer is 1MHz and the video bandwidth is  $\geq 1/T$  (Duty cycle < 98%) or 10Hz (Duty cycle  $\geq 98\%$ ) for Average detection (AV) at frequency above 1GHz. (RBW = 1MHz, VBW = 3kHz)
4. All modes of operation were investigated and the worst-case emissions are reported.

### 4.1.4 Deviation from Test Standard

No deviation.

#### 4.1.5 Test Setup

##### For Radiated emission below 30MHz

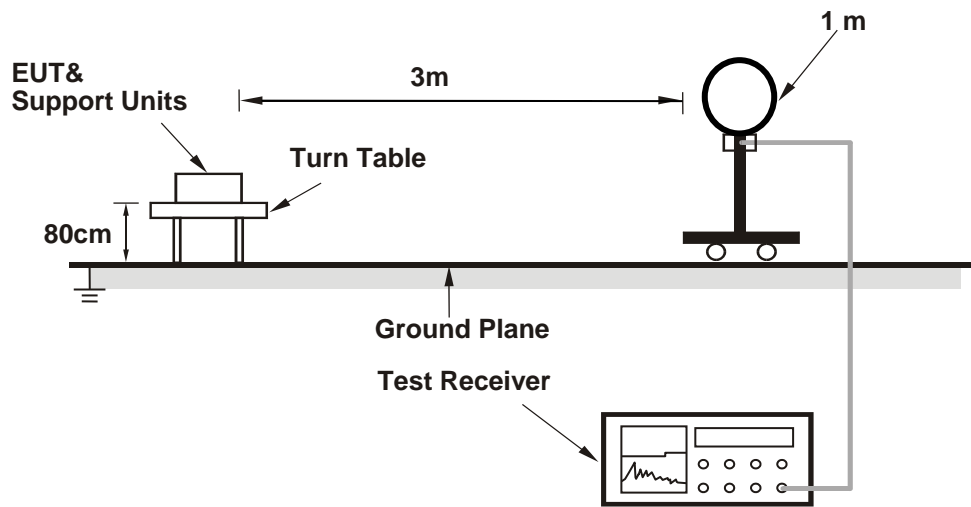

##### For Radiated emission 30MHz to 1GHz

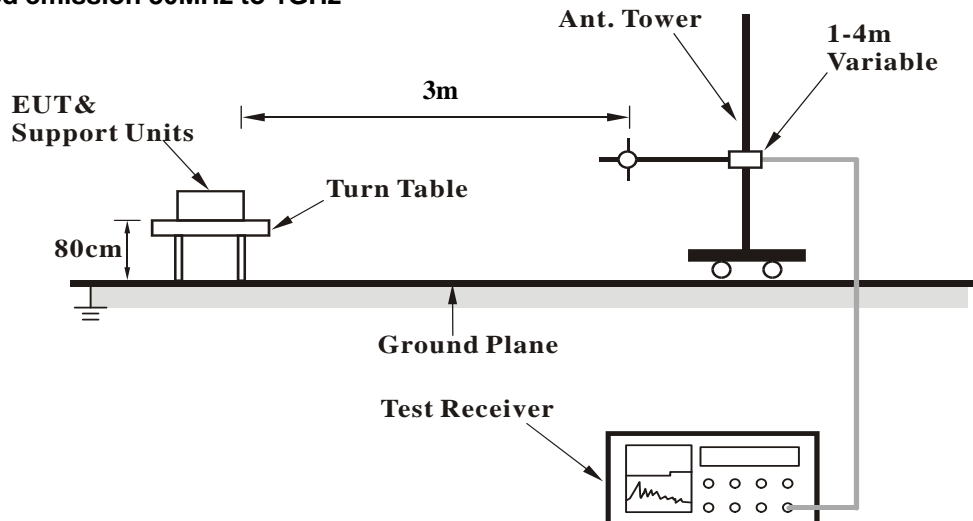

**For Radiated emission above 1GHz**

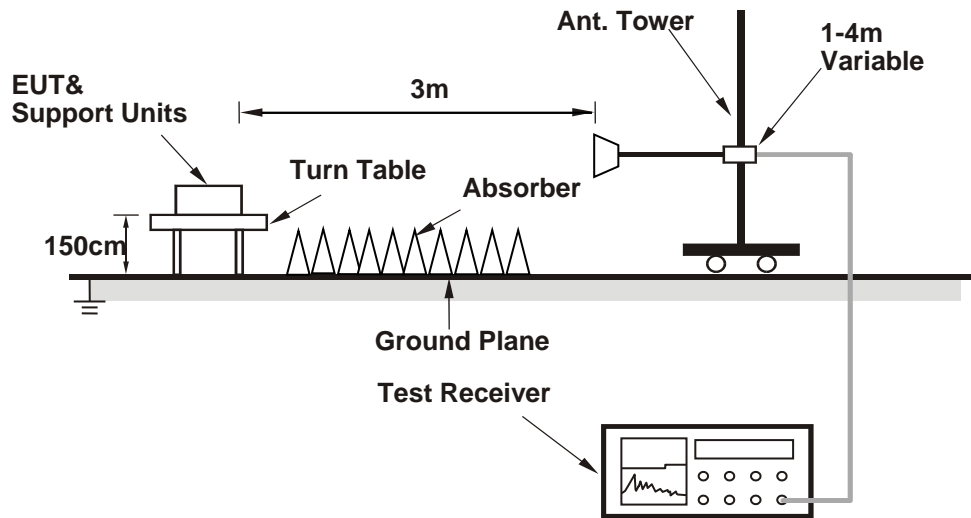

For the actual test configuration, please refer to the attached file (Test Setup Photo).

**4.1.6 EUT Operating Conditions**

- a. Set the EUT under transmission condition continuously at specific channel frequency.



#### 4.1.7 Test Results

Above 1 GHz Data:

CHANNEL	TX Channel 0	DETECTOR FUNCTION	Peak (PK) Average (AV)
FREQUENCY RANGE	1GHz ~ 25GHz		

#### ANTENNA POLARITY & TEST DISTANCE: HORIZONTAL AT 3 M

NO.	FREQ. (MHz)	EMISSION LEVEL (dBuV/m)	LIMIT (dBuV/m)	MARGIN (dB)	ANTENNA HEIGHT (m)	TABLE ANGLE (Degree)	RAW VALUE (dBuV)	CORRECTION FACTOR (dB/m)
1	2390.00	59.4 PK	74.0	-14.6	3.39 H	149	26.5	32.9
2	2390.00	49.6 AV	54.0	-4.4	3.39 H	149	16.7	32.9
3	*2402.00	91.8 PK			3.45 H	144	58.9	32.9
4	*2402.00	90.6 AV			3.45 H	144	57.7	32.9
5	4804.00	48.9 PK	74.0	-25.1	1.57 H	17	45.3	3.6
6	4804.00	37.5 AV	54.0	-16.5	1.57 H	17	33.9	3.6

#### ANTENNA POLARITY & TEST DISTANCE: VERTICAL AT 3 M

NO.	FREQ. (MHz)	EMISSION LEVEL (dBuV/m)	LIMIT (dBuV/m)	MARGIN (dB)	ANTENNA HEIGHT (m)	TABLE ANGLE (Degree)	RAW VALUE (dBuV)	CORRECTION FACTOR (dB/m)
1	2390.00	59.4 PK	74.0	-14.6	1.53 V	241	26.5	32.9
<b>2</b>	<b>2390.00</b>	<b>49.7 AV</b>	<b>54.0</b>	<b>-4.3</b>	<b>1.53 V</b>	<b>241</b>	<b>16.8</b>	<b>32.9</b>
3	*2402.00	96.0 PK			1.48 V	239	63.1	32.9
4	*2402.00	94.7 AV			1.48 V	239	61.8	32.9
5	4804.00	46.9 PK	74.0	-27.1	1.75 V	203	43.3	3.6
6	4804.00	35.4 AV	54.0	-18.6	1.75 V	203	31.8	3.6

Remarks:

1. Emission Level(dBuV/m) = Raw Value(dBuV) + Correction Factor(dB/m).
2. Correction Factor(dB/m) = Antenna Factor(dB/m) + Cable Factor(dB) – Pre-Amplifier Factor(dB).
3. Margin value = Emission Level – Limit value.
4. The other emission levels were very low against the limit.
5. " \* ": Fundamental frequency.

CHANNEL	TX Channel 19	DETECTOR FUNCTION	Peak (PK) Average (AV)
FREQUENCY RANGE	1GHz ~ 25GHz		

**ANTENNA POLARITY & TEST DISTANCE: HORIZONTAL AT 3 M**

NO.	FREQ. (MHz)	EMISSION LEVEL (dBuV/m)	LIMIT (dBuV/m)	MARGIN (dB)	ANTENNA HEIGHT (m)	TABLE ANGLE (Degree)	RAW VALUE (dBuV)	CORRECTION FACTOR (dB/m)
1	*2440.00	92.0 PK			3.23 H	149	59.1	32.9
2	*2440.00	91.1 AV			3.23 H	149	58.2	32.9
3	4880.00	48.9 PK	74.0	-25.1	1.61 H	20	44.9	4.0
4	4880.00	37.7 AV	54.0	-16.3	1.61 H	20	33.7	4.0

**ANTENNA POLARITY & TEST DISTANCE: VERTICAL AT 3 M**

NO.	FREQ. (MHz)	EMISSION LEVEL (dBuV/m)	LIMIT (dBuV/m)	MARGIN (dB)	ANTENNA HEIGHT (m)	TABLE ANGLE (Degree)	RAW VALUE (dBuV)	CORRECTION FACTOR (dB/m)
1	*2440.00	96.2 PK			1.70 V	289	63.3	32.9
2	*2440.00	95.3 AV			1.70 V	289	62.4	32.9
3	4880.00	48.1 PK	74.0	-25.9	1.85 V	223	44.1	4.0
4	4880.00	36.8 AV	54.0	-17.2	1.85 V	223	32.8	4.0

**Remarks:**

1. Emission Level(dBuV/m) = Raw Value(dBuV) + Correction Factor(dB/m).
2. Correction Factor(dB/m) = Antenna Factor(dB/m) + Cable Factor(dB) – Pre-Amplifier Factor(dB).
3. Margin value = Emission Level – Limit value.
4. The other emission levels were very low against the limit.
5. " \* ": Fundamental frequency.

CHANNEL	TX Channel 39	DETECTOR FUNCTION	Peak (PK) Average (AV)
FREQUENCY RANGE	1GHz ~ 25GHz		

**ANTENNA POLARITY & TEST DISTANCE: HORIZONTAL AT 3 M**

NO.	FREQ. (MHz)	EMISSION LEVEL (dBuV/m)	LIMIT (dBuV/m)	MARGIN (dB)	ANTENNA HEIGHT (m)	TABLE ANGLE (Degree)	RAW VALUE (dBuV)	CORRECTION FACTOR (dB/m)
1	*2480.00	90.7 PK			3.31 H	107	57.7	33.0
2	*2480.00	89.6 AV			3.31 H	107	56.6	33.0
3	2483.50	60.7 PK	74.0	-13.3	3.40 H	119	27.7	33.0
4	2483.50	49.5 AV	54.0	-4.5	3.40 H	119	16.5	33.0
5	4960.00	51.0 PK	74.0	-23.0	1.53 H	13	46.5	4.5
6	4960.00	43.1 AV	54.0	-10.9	1.53 H	13	38.6	4.5

**ANTENNA POLARITY & TEST DISTANCE: VERTICAL AT 3 M**

NO.	FREQ. (MHz)	EMISSION LEVEL (dBuV/m)	LIMIT (dBuV/m)	MARGIN (dB)	ANTENNA HEIGHT (m)	TABLE ANGLE (Degree)	RAW VALUE (dBuV)	CORRECTION FACTOR (dB/m)
1	*2480.00	95.0 PK			1.55 V	288	62.0	33.0
2	*2480.00	93.8 AV			1.55 V	288	60.8	33.0
3	2483.50	60.5 PK	74.0	-13.5	1.61 V	290	27.5	33.0
4	2483.50	49.5 AV	54.0	-4.5	1.61 V	290	16.5	33.0
5	4960.00	48.2 PK	74.0	-25.8	1.91 V	219	43.7	4.5
6	4960.00	37.8 AV	54.0	-16.2	1.91 V	219	33.3	4.5

**Remarks:**

1. Emission Level(dBuV/m) = Raw Value(dBuV) + Correction Factor(dB/m).
2. Correction Factor(dB/m) = Antenna Factor(dB/m) + Cable Factor(dB) – Pre-Amplifier Factor(dB).
3. Margin value = Emission Level – Limit value.
4. The other emission levels were very low against the limit.
5. " \* ": Fundamental frequency.

Below 1GHz worst-case data:

CHANNEL	TX Channel 39	DETECTOR FUNCTION	Quasi-Peak (QP)
FREQUENCY RANGE	9kHz ~ 1GHz		
TEST MODE	A		

ANTENNA POLARITY & TEST DISTANCE: HORIZONTAL AT 3 M								
NO.	FREQ. (MHz)	EMISSION LEVEL (dBuV/m)	LIMIT (dBuV/m)	MARGIN (dB)	ANTENNA HEIGHT (m)	TABLE ANGLE (Degree)	RAW VALUE (dBuV)	CORRECTION FACTOR (dB/m)
1	30.04	26.7 QP	40.0	-13.3	1.00 H	113	38.2	-11.5
2	70.73	20.6 QP	40.0	-19.4	1.00 H	90	32.6	-12.0
3	199.05	26.3 QP	43.5	-17.2	1.00 H	235	37.5	-11.2
4	323.49	28.9 QP	46.0	-17.1	1.00 H	99	35.8	-6.9
5	622.91	28.9 QP	46.0	-17.1	1.00 H	145	29.6	-0.7
6	745.40	31.0 QP	46.0	-15.0	1.00 H	36	29.3	1.7

Remarks:

1. Emission Level(dBuV/m) = Raw Value(dBuV) + Correction Factor(dB/m)
2. Correction Factor(dB/m) = Antenna Factor(dB/m) + Cable Factor(dB) – Pre-Amplifier Factor(dB)
3. The other emission levels were very low against the limit of frequency range 30MHz ~ 1000MHz
4. Margin value = Emission Level – Limit value
5. The emission levels were very low against the limit of frequency range 9kHz ~ 30MHz: the amplitude of spurious emissions attenuated more than 20 dB below the permissible value to be report

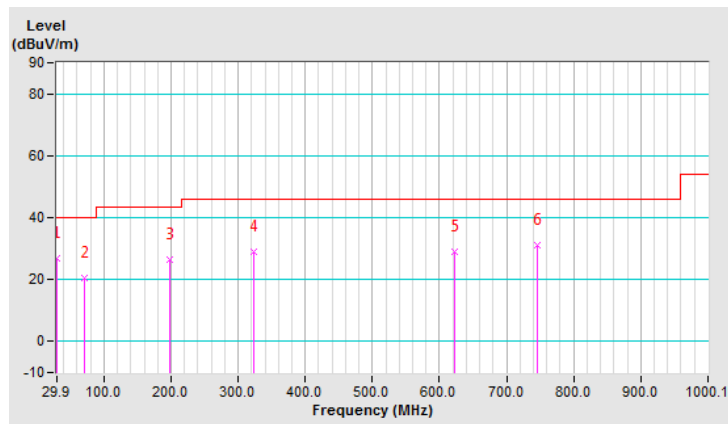

CHANNEL	TX Channel 39	DETECTOR FUNCTION	Quasi-Peak (QP)
FREQUENCY RANGE	9kHz ~ 1GHz		
TEST MODE	A		

ANTENNA POLARITY & TEST DISTANCE: VERTICAL AT 3 M								
NO.	FREQ. (MHz)	EMISSION LEVEL (dBuV/m)	LIMIT (dBuV/m)	MARGIN (dB)	ANTENNA HEIGHT (m)	TABLE ANGLE (Degree)	RAW VALUE (dBuV)	CORRECTION FACTOR (dB/m)
1	41.57	23.8 QP	40.0	-16.2	1.00 V	222	33.9	-10.1
2	167.94	23.6 QP	43.5	-19.9	1.00 V	66	32.9	-9.3
3	267.10	20.1 QP	46.0	-25.9	1.00 V	91	28.5	-8.4
4	420.70	25.3 QP	46.0	-20.7	1.00 V	271	30.2	-4.9
5	622.91	29.2 QP	46.0	-16.8	1.00 V	89	29.9	-0.7
6	790.12	32.0 QP	46.0	-14.0	1.00 V	197	29.7	2.3

Remarks:

1. Emission Level(dBuV/m) = Raw Value(dBuV) + Correction Factor(dB/m)
2. Correction Factor(dB/m) = Antenna Factor(dB/m) + Cable Factor(dB) – Pre-Amplifier Factor(dB)
3. The other emission levels were very low against the limit of frequency range 30MHz ~ 1000MHz
4. Margin value = Emission Level – Limit value
5. The emission levels were very low against the limit of frequency range 9kHz ~ 30MHz: the amplitude of spurious emissions attenuated more than 20 dB below the permissible value to be report

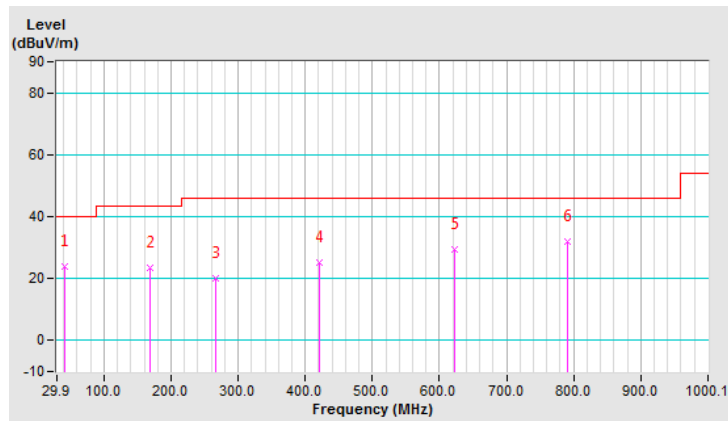

CHANNEL	TX Channel 39	DETECTOR FUNCTION	Quasi-Peak (QP)
FREQUENCY RANGE	9kHz ~ 1GHz		
TEST MODE	B		

ANTENNA POLARITY & TEST DISTANCE: HORIZONTAL AT 3 M								
NO.	FREQ. (MHz)	EMISSION LEVEL (dBuV/m)	LIMIT (dBuV/m)	MARGIN (dB)	ANTENNA HEIGHT (m)	TABLE ANGLE (Degree)	RAW VALUE (dBuV)	CORRECTION FACTOR (dB/m)
1	45.45	19.1 QP	40.0	-20.9	1.00 H	59	28.9	-9.8
2	173.78	22.0 QP	43.5	-21.5	1.00 H	288	31.7	-9.7
3	214.61	25.0 QP	43.5	-18.5	1.00 H	84	35.9	-10.9
4	381.82	22.6 QP	46.0	-23.4	1.00 H	356	28.5	-5.9
5	584.02	27.5 QP	46.0	-18.5	1.00 H	49	29.1	-1.6
6	700.68	29.9 QP	46.0	-16.1	1.00 H	108	29.7	0.2

Remarks:

1. Emission Level(dBuV/m) = Raw Value(dBuV) + Correction Factor(dB/m)
2. Correction Factor(dB/m) = Antenna Factor(dB/m) + Cable Factor(dB) – Pre-Amplifier Factor(dB)
3. The other emission levels were very low against the limit of frequency range 30MHz ~ 1000MHz
4. Margin value = Emission Level – Limit value
5. The emission levels were very low against the limit of frequency range 9kHz ~ 30MHz: the amplitude of spurious emissions attenuated more than 20 dB below the permissible value to be report

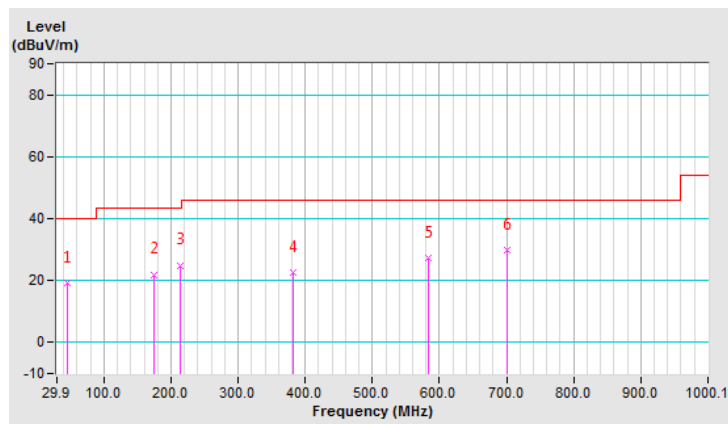

CHANNEL	TX Channel 39	DETECTOR FUNCTION	Quasi-Peak (QP)
FREQUENCY RANGE	9kHz ~ 1GHz		
TEST MODE	B		

ANTENNA POLARITY & TEST DISTANCE: VERTICAL AT 3 M								
NO.	FREQ. (MHz)	EMISSION LEVEL (dBuV/m)	LIMIT (dBuV/m)	MARGIN (dB)	ANTENNA HEIGHT (m)	TABLE ANGLE (Degree)	RAW VALUE (dBuV)	CORRECTION FACTOR (dB/m)
1	49.34	21.5 QP	40.0	-18.5	1.00 V	18	31.2	-9.7
2	167.94	22.0 QP	43.5	-21.5	1.00 V	20	31.3	-9.3
3	239.88	18.9 QP	46.0	-27.1	1.00 V	211	28.5	-9.6
4	407.09	23.0 QP	46.0	-23.0	1.00 V	72	28.5	-5.5
5	593.74	27.4 QP	46.0	-18.6	1.00 V	205	28.8	-1.4
6	706.51	29.0 QP	46.0	-17.0	1.00 V	165	28.6	0.4

Remarks:

1. Emission Level(dBuV/m) = Raw Value(dBuV) + Correction Factor(dB/m)
2. Correction Factor(dB/m) = Antenna Factor(dB/m) + Cable Factor(dB) – Pre-Amplifier Factor(dB)
3. The other emission levels were very low against the limit of frequency range 30MHz ~ 1000MHz
4. Margin value = Emission Level – Limit value
5. The emission levels were very low against the limit of frequency range 9kHz ~ 30MHz: the amplitude of spurious emissions attenuated more than 20 dB below the permissible value to be report

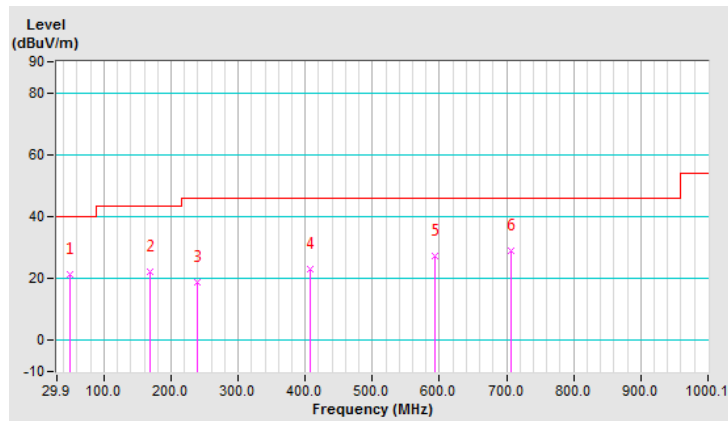

CHANNEL	TX Channel 39	DETECTOR FUNCTION	Quasi-Peak (QP)
FREQUENCY RANGE	9kHz ~ 1GHz		
TEST MODE	C		

ANTENNA POLARITY & TEST DISTANCE: HORIZONTAL AT 3 M								
NO.	FREQ. (MHz)	EMISSION LEVEL (dBuV/m)	LIMIT (dBuV/m)	MARGIN (dB)	ANTENNA HEIGHT (m)	TABLE ANGLE (Degree)	RAW VALUE (dBuV)	CORRECTION FACTOR (dB/m)
1	30.00	26.2 QP	40.0	-13.8	1.99 H	291	37.7	-11.5
2	57.21	27.6 QP	40.0	-12.4	1.99 H	14	37.7	-10.1
3	70.82	25.6 QP	40.0	-14.4	1.99 H	303	37.6	-12.0
4	257.43	31.9 QP	46.0	-14.1	1.99 H	149	40.8	-8.9
5	306.03	32.9 QP	46.0	-13.1	1.99 H	337	40.1	-7.2
6	517.92	26.8 QP	46.0	-19.2	1.49 H	257	30.1	-3.3

Remarks:

1. Emission Level(dBuV/m) = Raw Value(dBuV) + Correction Factor(dB/m)
2. Correction Factor(dB/m) = Antenna Factor(dB/m) + Cable Factor(dB) – Pre-Amplifier Factor(dB)
3. The other emission levels were very low against the limit of frequency range 30MHz ~ 1000MHz
4. Margin value = Emission Level – Limit value
5. The emission levels were very low against the limit of frequency range 9kHz ~ 30MHz: the amplitude of spurious emissions attenuated more than 20 dB below the permissible value to be report

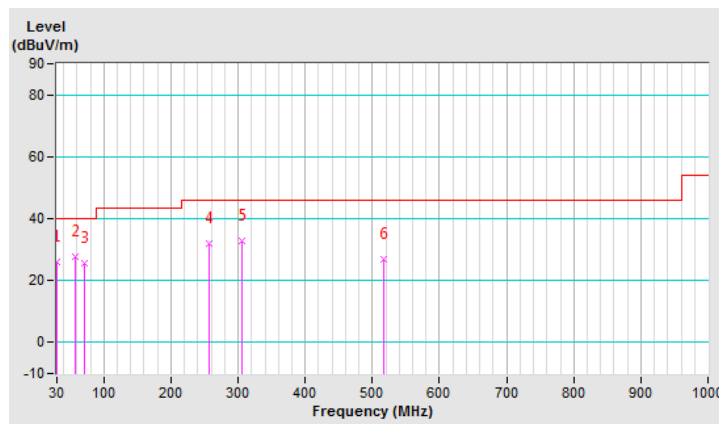



CHANNEL	TX Channel 39	DETECTOR FUNCTION	Quasi-Peak (QP)
FREQUENCY RANGE	9kHz ~ 1GHz		
TEST MODE	C		

ANTENNA POLARITY & TEST DISTANCE: VERTICAL AT 3 M								
NO.	FREQ. (MHz)	EMISSION LEVEL (dBuV/m)	LIMIT (dBuV/m)	MARGIN (dB)	ANTENNA HEIGHT (m)	TABLE ANGLE (Degree)	RAW VALUE (dBuV)	CORRECTION FACTOR (dB/m)
1	43.61	30.8 QP	40.0	-9.2	1.00 V	85	40.7	-9.9
2	59.16	24.2 QP	40.0	-15.8	1.49 V	351	34.3	-10.1
3	263.27	26.3 QP	46.0	-19.7	1.49 V	206	34.9	-8.6
4	323.53	30.4 QP	46.0	-15.6	1.49 V	142	37.3	-6.9
5	356.57	23.3 QP	46.0	-22.7	1.49 V	78	29.8	-6.5
6	554.85	26.7 QP	46.0	-19.3	1.49 V	23	29.4	-2.7

Remarks:

1. Emission Level(dBuV/m) = Raw Value(dBuV) + Correction Factor(dB/m)
2. Correction Factor(dB/m) = Antenna Factor(dB/m) + Cable Factor(dB) – Pre-Amplifier Factor(dB)
3. The other emission levels were very low against the limit of frequency range 30MHz ~ 1000MHz
4. Margin value = Emission Level – Limit value
5. The emission levels were very low against the limit of frequency range 9kHz ~ 30MHz: the amplitude of spurious emissions attenuated more than 20 dB below the permissible value to be report

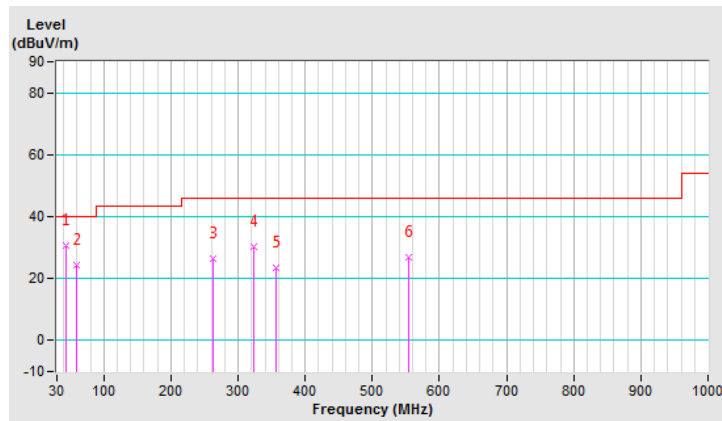

CHANNEL	TX Channel 39	DETECTOR FUNCTION	Quasi-Peak (QP)
FREQUENCY RANGE	9kHz ~ 1GHz		
TEST MODE	D		

ANTENNA POLARITY & TEST DISTANCE: HORIZONTAL AT 3 M								
NO.	FREQ. (MHz)	EMISSION LEVEL (dBuV/m)	LIMIT (dBuV/m)	MARGIN (dB)	ANTENNA HEIGHT (m)	TABLE ANGLE (Degree)	RAW VALUE (dBuV)	CORRECTION FACTOR (dB/m)
1	49.44	21.7 QP	40.0	-18.3	1.99 H	109	31.4	-9.7
2	57.21	27.4 QP	40.0	-12.6	1.99 H	169	37.5	-10.1
3	72.77	19.6 QP	40.0	-20.4	1.51 H	116	32.1	-12.5
4	253.55	31.3 QP	46.0	-14.7	1.51 H	104	40.4	-9.1
5	309.92	29.7 QP	46.0	-16.3	1.51 H	232	36.8	-7.1
6	601.50	29.3 QP	46.0	-16.7	1.51 H	212	30.5	-1.2

Remarks:

1. Emission Level(dBuV/m) = Raw Value(dBuV) + Correction Factor(dB/m)
2. Correction Factor(dB/m) = Antenna Factor(dB/m) + Cable Factor(dB) – Pre-Amplifier Factor(dB)
3. The other emission levels were very low against the limit of frequency range 30MHz ~ 1000MHz
4. Margin value = Emission Level – Limit value
5. The emission levels were very low against the limit of frequency range 9kHz ~ 30MHz: the amplitude of spurious emissions attenuated more than 20 dB below the permissible value to be report

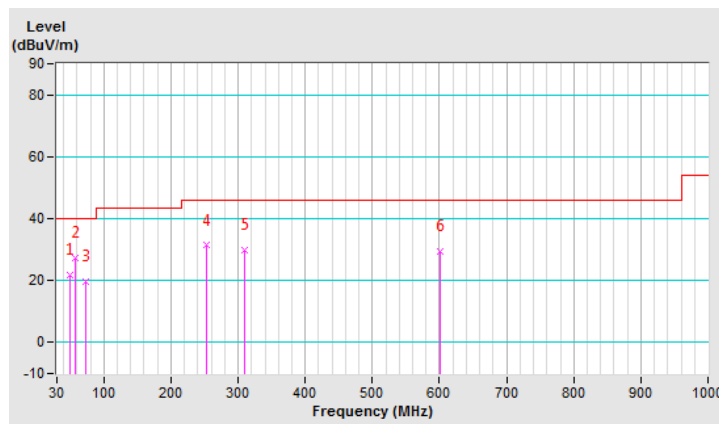

CHANNEL	TX Channel 39	DETECTOR FUNCTION	Quasi-Peak (QP)
FREQUENCY RANGE	9kHz ~ 1GHz		
TEST MODE	D		

ANTENNA POLARITY & TEST DISTANCE: VERTICAL AT 3 M								
NO.	FREQ. (MHz)	EMISSION LEVEL (dBuV/m)	LIMIT (dBuV/m)	MARGIN (dB)	ANTENNA HEIGHT (m)	TABLE ANGLE (Degree)	RAW VALUE (dBuV)	CORRECTION FACTOR (dB/m)
1	43.61	30.5 QP	40.0	-9.5	1.01 V	359	40.4	-9.9
2	57.21	26.3 QP	40.0	-13.7	1.01 V	18	36.4	-10.1
3	253.55	27.1 QP	46.0	-18.9	1.01 V	235	36.2	-9.1
4	329.36	28.8 QP	46.0	-17.2	1.50 V	59	35.5	-6.7
5	445.99	28.1 QP	46.0	-17.9	1.01 V	189	32.5	-4.4
6	646.21	30.2 QP	46.0	-15.8	1.50 V	145	30.7	-0.5

Remarks:

1. Emission Level(dBuV/m) = Raw Value(dBuV) + Correction Factor(dB/m)
2. Correction Factor(dB/m) = Antenna Factor(dB/m) + Cable Factor(dB) – Pre-Amplifier Factor(dB)
3. The other emission levels were very low against the limit of frequency range 30MHz ~ 1000MHz
4. Margin value = Emission Level – Limit value
5. The emission levels were very low against the limit of frequency range 9kHz ~ 30MHz: the amplitude of spurious emissions attenuated more than 20 dB below the permissible value to be report

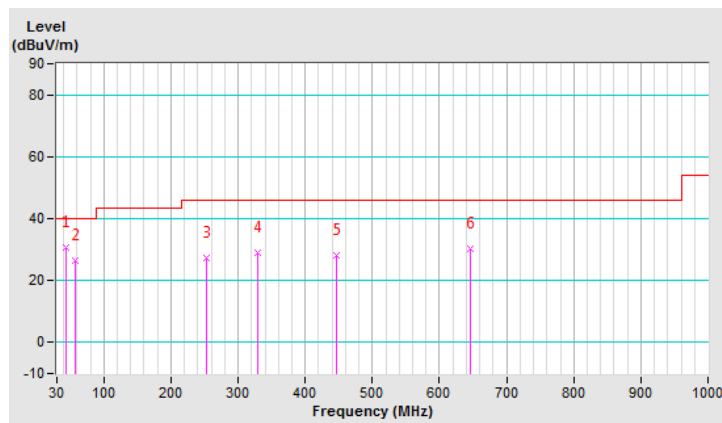

## 4.2 Conducted Emission Measurement

### 4.2.1 Limits of Conducted Emission Measurement

Frequency (MHz)	Conducted Limit (dBuV)	
	Quasi-peak	Average
0.15 - 0.5	66 - 56	56 - 46
0.50 - 5.0	56	46
5.0 - 30.0	60	50

Note: 1. The lower limit shall apply at the transition frequencies.  
 2. The limit decreases in line with the logarithm of the frequency in the range of 0.15 to 0.50MHz.

### 4.2.2 Test Instruments

Description & Manufacturer	Model No.	Serial No.	Cal. Date	Cal. Due
Test Receiver ROHDE & SCHWARZ	ESCI	100613	Dec. 10, 2018	Dec. 09, 2019
RF signal cable Woken	5D-FB	Cable-cond1-01	Sep. 05, 2018	Sep. 04, 2019
LISN ROHDE & SCHWARZ (EUT)	ENV216	101826	Feb. 21, 2019	Feb. 20, 2020
LISN ROHDE & SCHWARZ (Peripheral)	ESH3-Z5	100311	Aug. 19, 2018	Aug. 18, 2019
Software ADT	BV ADT_Cond_ V7.3.7.4	NA	NA	NA

Note: 1. The calibration interval of the above test instruments is 12 months and the calibrations are traceable to NML/ROC and NIST/USA.  
 2. The test was performed in HwaYa Shielded Room 1.  
 3. The VCCI Site Registration No. is C-12040.

#### 4.2.3 Test Procedures

- The EUT was placed 0.4 meters from the conducting wall of the shielded room with EUT being connected to the power mains through a line impedance stabilization network (LISN). Other support units were connected to the power mains through another LISN. The two LISNs provide 50 ohm/ 50uH of coupling impedance for the measuring instrument.
- Both lines of the power mains connected to the EUT were checked for maximum conducted interference.
- The frequency range from 150kHz to 30MHz was searched. Emission levels under (Limit - 20dB) was not recorded.

Note: The resolution bandwidth and video bandwidth of test receiver is 9kHz for quasi-peak detection (QP) and average detection (AV) at frequency 0.15MHz-30MHz.

#### 4.2.4 Deviation from Test Standard

No deviation.

#### 4.2.5 Test Setup

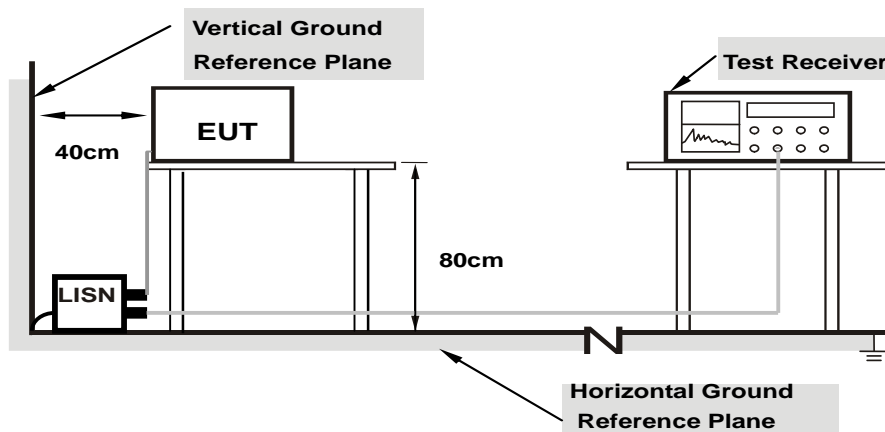

Note: 1.Support units were connected to second LISN.

For the actual test configuration, please refer to the attached file (Test Setup Photo).

#### 4.2.6 EUT Operating Conditions

Same as 4.1.6.

#### 4.2.7 Test Results

Phase	Line (L)	Detector Function	Quasi-Peak (QP) / Average (AV)
Test Mode	C		

No	Freq. [MHz]	Corr. Factor (dB)	Reading Value [dB (uV)]		Emission Level [dB (uV)]		Limit [dB (uV)]		Margin (dB)	
			Q.P.	AV.	Q.P.	AV.	Q.P.	AV.	Q.P.	AV.
			<b>1</b>	<b>0.16922</b>	<b>9.84</b>	<b>43.89</b>	<b>30.40</b>	<b>53.73</b>	<b>40.24</b>	<b>65.00</b>
2	0.31031	9.87	26.74	16.63	36.61	26.50	59.96	49.96	-23.35	-23.46
3	0.41197	9.88	28.21	17.13	38.09	27.01	57.61	47.61	-19.52	-20.60
4	1.20570	9.93	17.44	8.09	27.37	18.02	56.00	46.00	-28.63	-27.98
5	4.73252	10.04	12.43	4.49	22.47	14.53	56.00	46.00	-33.53	-31.47
6	9.76469	10.15	12.38	6.53	22.53	16.68	60.00	50.00	-37.47	-33.32

Remarks:

1. Q.P. and AV. are abbreviations of quasi-peak and average individually.
2. The emission levels of other frequencies were very low against the limit.
3. Margin value = Emission level - Limit value
4. Correction factor = Insertion loss + Cable loss
5. Emission Level = Correction Factor + Reading Value.

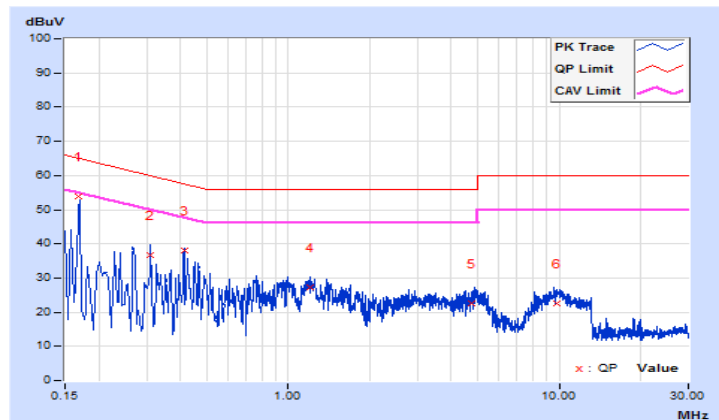

Phase	Neutral (N)	Detector Function	Quasi-Peak (QP) / Average (AV)
Test Mode	C		

No	Freq. [MHz]	Corr. Factor (dB)	Reading Value [dB (uV)]		Emission Level [dB (uV)]		Limit [dB (uV)]		Margin (dB)	
			Q.P.	AV.	Q.P.	AV.	Q.P.	AV.	Q.P.	AV.
			1	0.15000	9.82	35.73	14.15	45.55	23.97	66.00
2	0.17328	9.83	43.10	29.39	52.93	39.22	64.80	54.80	-11.87	-15.58
3	0.21621	9.84	34.34	14.88	44.18	24.72	62.96	52.96	-18.78	-28.24
4	0.43543	9.87	29.41	20.87	39.28	30.74	57.15	47.15	-17.87	-16.41
5	5.29165	10.03	11.55	3.33	21.58	13.36	60.00	50.00	-38.42	-36.64
6	9.74514	10.15	12.05	6.72	22.20	16.87	60.00	50.00	-37.80	-33.13

Remarks:

1. Q.P. and AV. are abbreviations of quasi-peak and average individually.
2. The emission levels of other frequencies were very low against the limit.
3. Margin value = Emission level - Limit value
4. Correction factor = Insertion loss + Cable loss
5. Emission Level = Correction Factor + Reading Value.

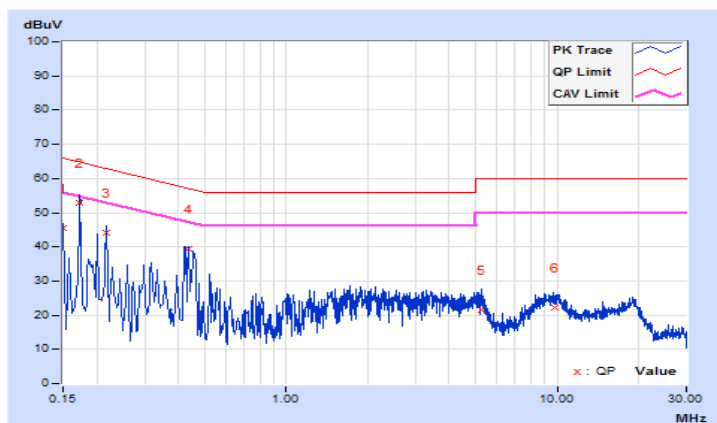

Phase	Line (L)	Detector Function	Quasi-Peak (QP) / Average (AV)
Test Mode	D		

No	Freq. [MHz]	Corr. Factor (dB)	Reading Value [dB (uV)]		Emission Level [dB (uV)]		Limit [dB (uV)]		Margin (dB)	
			Q.P.	AV.	Q.P.	AV.	Q.P.	AV.	Q.P.	AV.
			1	0.17328	9.84	43.08	29.59	52.92	39.43	64.80
2	0.20084	9.85	37.45	23.70	47.30	33.55	63.58	53.58	-16.28	-20.03
3	0.27120	9.86	27.84	14.72	37.70	24.58	61.08	51.08	-23.38	-26.50
4	0.78733	9.91	19.82	10.08	29.73	19.99	56.00	46.00	-26.27	-26.01
5	5.20172	10.05	12.86	4.60	22.91	14.65	60.00	50.00	-37.09	-35.35
6	10.14005	10.16	12.26	6.28	22.42	16.44	60.00	50.00	-37.58	-33.56

Remarks:

1. Q.P. and AV. are abbreviations of quasi-peak and average individually.
2. The emission levels of other frequencies were very low against the limit.
3. Margin value = Emission level - Limit value
4. Correction factor = Insertion loss + Cable loss
5. Emission Level = Correction Factor + Reading Value.

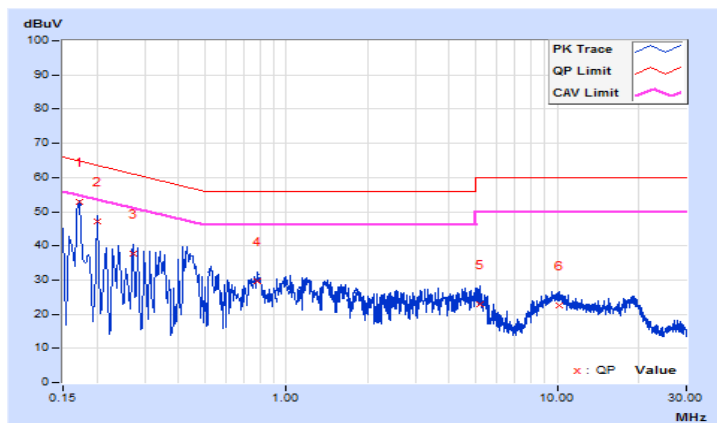



Phase	Neutral (N)	Detector Function	Quasi-Peak (QP) / Average (AV)
Test Mode	D		

No	Freq. [MHz]	Corr. Factor (dB)	Reading Value [dB (uV)]		Emission Level [dB (uV)]		Limit [dB (uV)]		Margin (dB)	
			Q.P.	AV.	Q.P.	AV.	Q.P.	AV.	Q.P.	AV.
			1	0.16173	9.82	41.27	22.39	51.09	32.21	65.37
2	0.17346	9.83	43.07	29.08	52.90	38.91	64.79	54.79	-11.89	-15.88
3	0.20243	9.84	37.37	22.65	47.21	32.49	63.51	53.51	-16.30	-21.02
4	0.42334	9.87	29.97	20.10	39.84	29.97	57.38	47.38	-17.54	-17.41
5	1.68663	9.91	16.55	8.08	26.46	17.99	56.00	46.00	-29.54	-28.01
6	9.38933	10.14	11.63	6.20	21.77	16.34	60.00	50.00	-38.23	-33.66

Remarks:

1. Q.P. and AV. are abbreviations of quasi-peak and average individually.
2. The emission levels of other frequencies were very low against the limit.
3. Margin value = Emission level - Limit value
4. Correction factor = Insertion loss + Cable loss
5. Emission Level = Correction Factor + Reading Value.

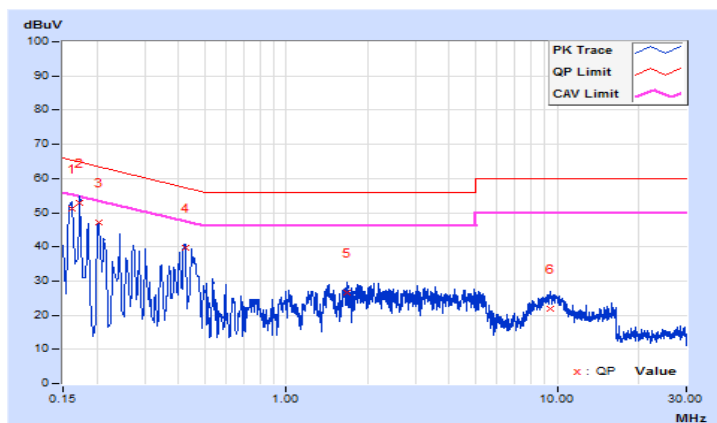

### 4.3 6dB Bandwidth Measurement

#### 4.3.1 Limits of 6dB Bandwidth Measurement

The minimum of 6dB Bandwidth Measurement is 0.5 MHz.

#### 4.3.2 Test Setup

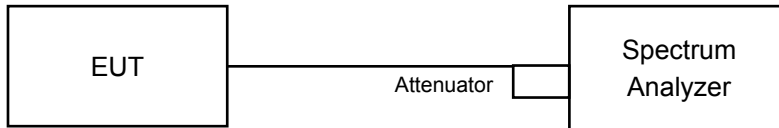

#### 4.3.3 Test Instruments

Refer to section 4.1.2 to get information of above instrument.

#### 4.3.4 Test Procedure

- Set resolution bandwidth (RBW) = 100kHz.
- Set the video bandwidth (VBW)  $\geq 3 \times$  RBW, Detector = peak.
- Trace mode = max hold.
- Sweep = auto couple.
- Measure the maximum width of the emission that is constrained by the frequencies associated with the two amplitude points (upper and lower) that are attenuated by 6 dB relative to the maximum level measured in the fundamental emission.

#### 4.3.5 Deviation from Test Standard

No deviation.

#### 4.3.6 EUT Operating Conditions

The software provided by client to enable the EUT under transmission condition continuously at lowest, middle and highest channel frequencies individually.

### 4.3.7 Test Result

Channel	Frequency (MHz)	6dB Bandwidth (MHz)	Minimum Limit (MHz)	Pass / Fail
0	2402	0.66	0.5	Pass
19	2440	0.66	0.5	Pass
39	2480	0.67	0.5	Pass

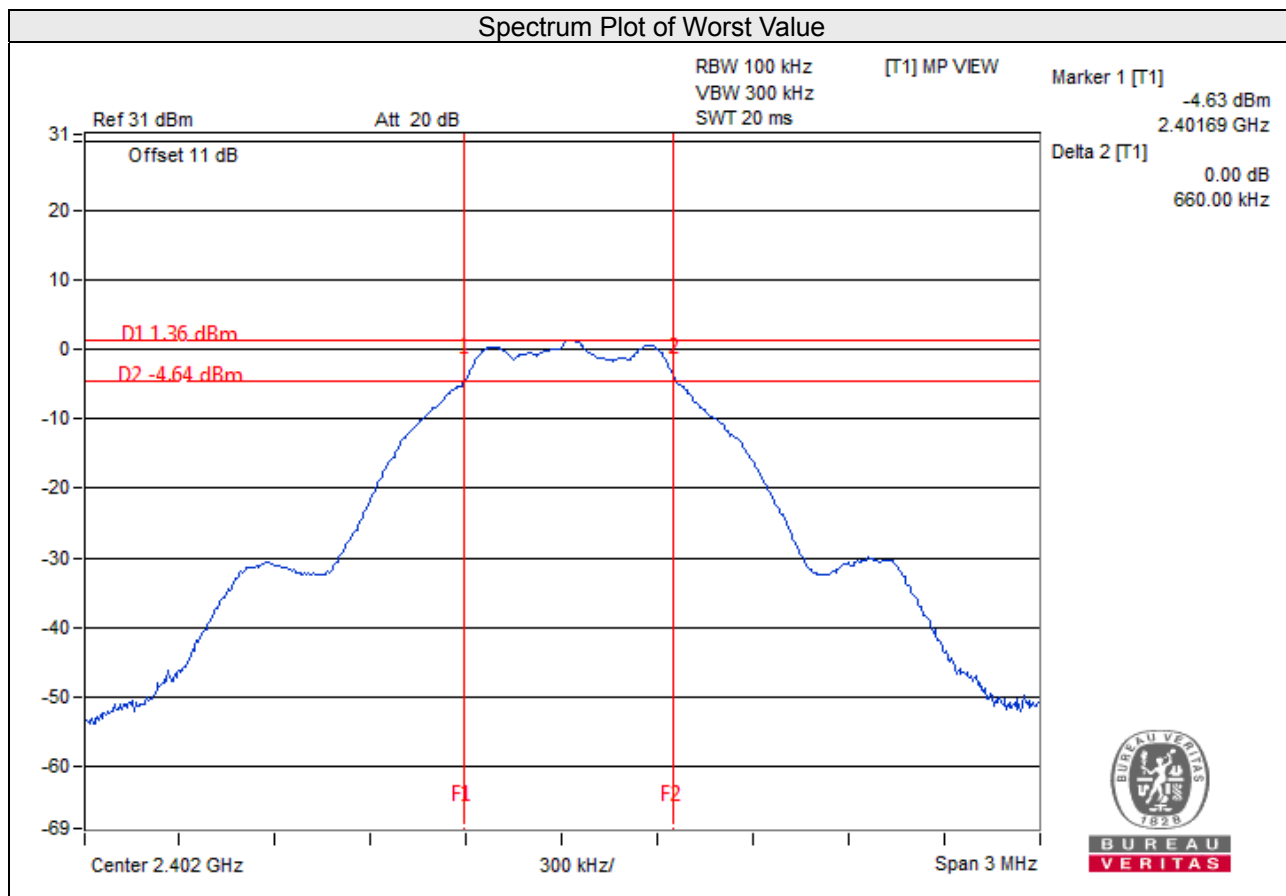

#### 4.4 Conducted Output Power Measurement

##### 4.4.1 Limits of Conducted Output Power Measurement

For systems using digital modulation in the 2400–2483.5 MHz bands: 1 Watt (30dBm)

##### 4.4.2 Test Setup

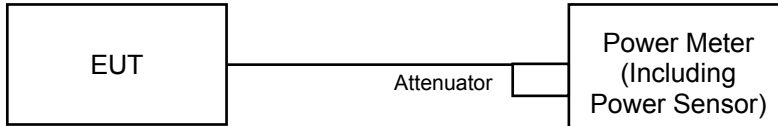

##### 4.4.3 Test Instruments

Refer to section 4.1.2 to get information of above instrument.

##### 4.4.4 Test Procedures

A peak power sensor was used on the output port of the EUT. A power meter was used to read the response of the peak power sensor. Record the power level.

##### 4.4.5 Deviation from Test Standard

No deviation.

##### 4.4.6 EUT Operating Conditions

Same as item 4.3.6.

##### 4.4.7 Test Results

Channel	Frequency (MHz)	Peak Power (mW)	Peak Power (dBm)	Limit (dBm)	Pass/Fail
0	2402	1.928	2.85	30.00	Pass
19	2440	2.404	3.81	30.00	Pass
39	2480	<b>3.199</b>	5.05	30.00	Pass

## 4.5 Power Spectral Density Measurement

### 4.5.1 Limits of Power Spectral Density Measurement

The Maximum of Power Spectral Density Measurement is 8dBm per 3kHz.

### 4.5.2 Test Setup

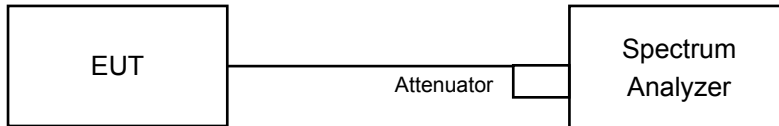

### 4.5.3 Test Instruments

Refer to section 4.1.2 to get information of above instrument.

### 4.5.4 Test Procedure

- a. Set analyzer center frequency to DTS channel center frequency.
- b. Set the span to 1.5 times the DTS bandwidth.
- c. Set the RBW to:  $3 \text{ kHz} \leq \text{RBW} \leq 100 \text{ kHz}$ .
- d. Set the VBW  $\geq 3 \times \text{RBW}$ .
- e. Detector = peak.
- f. Sweep time = auto couple.
- g. Trace mode = max hold.
- h. Allow trace to fully stabilize.
- i. Use the peak marker function to determine the maximum amplitude level within the RBW.

### 4.5.5 Deviation from Test Standard

No deviation.

### 4.5.6 EUT Operating Condition

Same as item 4.3.6

#### 4.5.7 Test Results

Channel	Freq. (MHz)	PSD (dBm/3kHz)	Limit (dBm/3kHz)	Pass / Fail
0	2402	-12.97	8.00	Pass
19	2440	-11.86	8.00	Pass
39	2480	-11.41	8.00	Pass

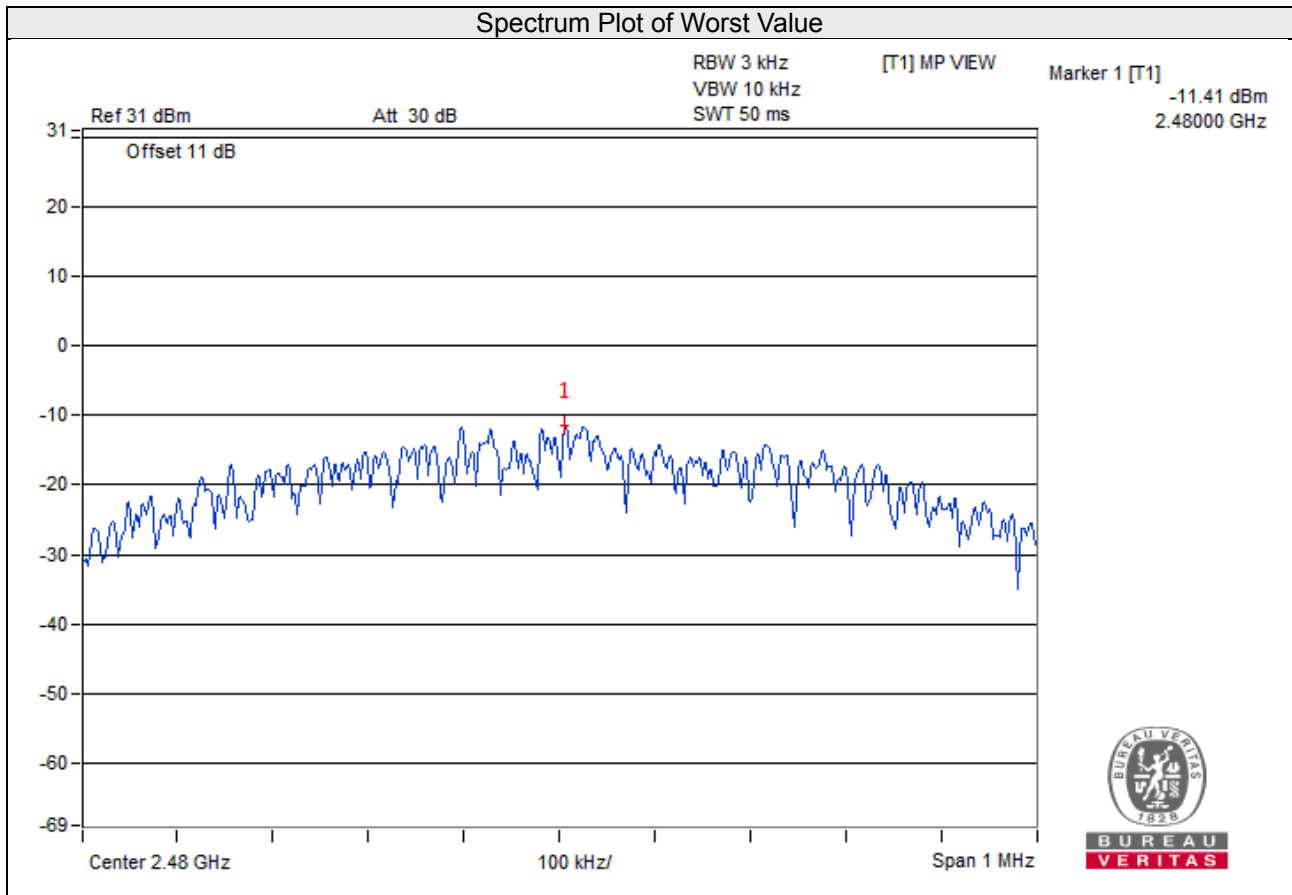

## 4.6 Conducted Out of Band Emission Measurement

### 4.6.1 Limits of Conducted Out of Band Emission Measurement

Below -20dB of the highest emission level of operating band (in 100kHz Resolution Bandwidth).

### 4.6.2 Test Setup

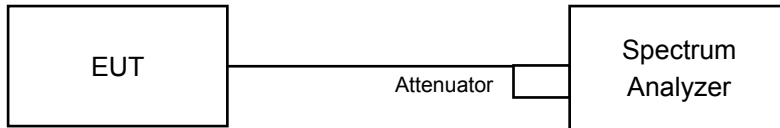

### 4.6.3 Test Instruments

Refer to section 4.1.2 to get information of above instrument.

### 4.6.4 Test Procedure

#### MEASUREMENT PROCEDURE REF

- Set the RBW = 100 kHz.
- Set the VBW  $\geq$  300 kHz.
- Detector = peak.
- Sweep time = auto couple.
- Trace mode = max hold.
- Allow trace to fully stabilize.
- Use the peak marker function to determine the maximum power level in any 100 kHz band segment within the fundamental EBW.

#### MEASUREMENT PROCEDURE OOB

- Set RBW = 100 kHz.
- Set VBW  $\geq$  300 kHz.
- Detector = peak.
- Sweep = auto couple.
- Trace Mode = max hold.
- Allow trace to fully stabilize.
- Use the peak marker function to determine the maximum amplitude level.

### 4.6.5 Deviation from Test Standard

No deviation.

### 4.6.6 EUT Operating Condition

Same as item 4.3.6

### 4.6.7 Test Results

The conducted emission test is performed on each TX port of operating mode without summing or adding 10log (N) since the limit is relative emission limit.

The spectrum plots are attached on the following pages. D1 line indicates the highest level, and D2 line indicates the 20dB offset below D1. It shows compliance with the requirement.

### CH 0

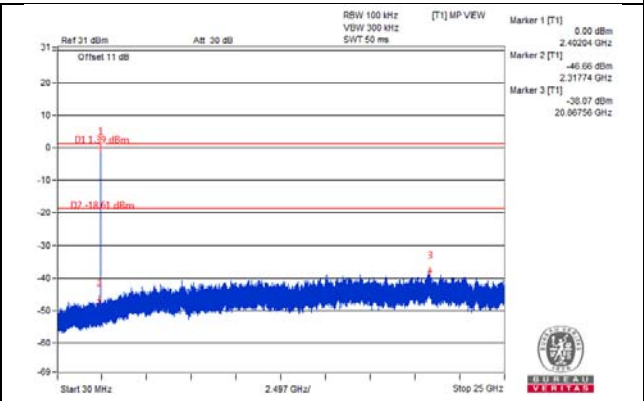
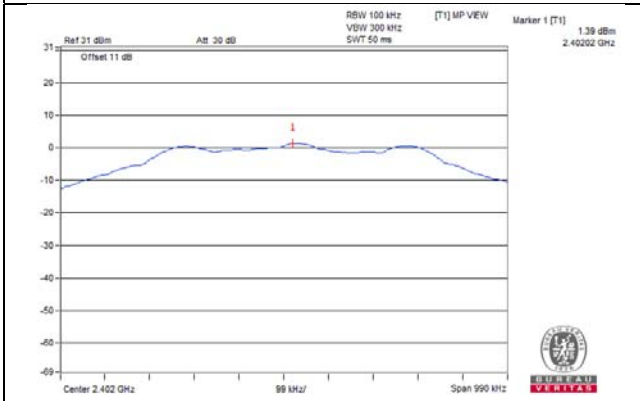

### CH 19

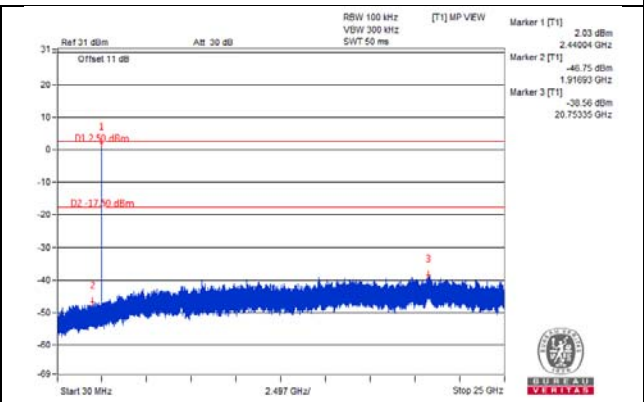
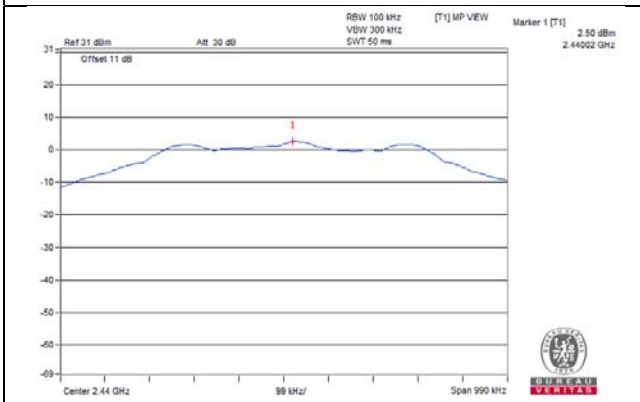

### CH 39

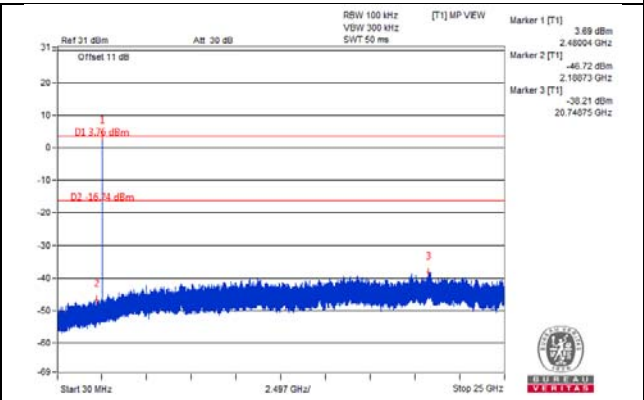
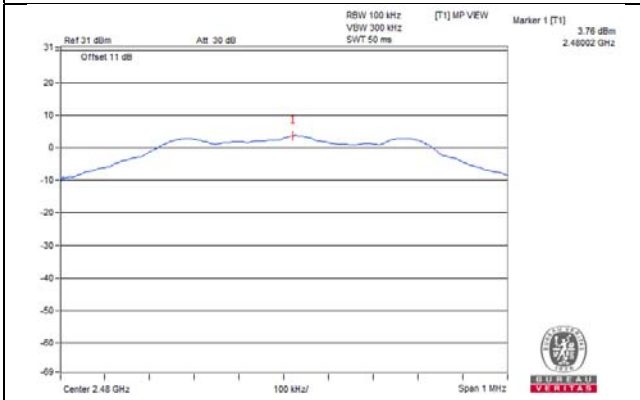

### CH 0 Band edge

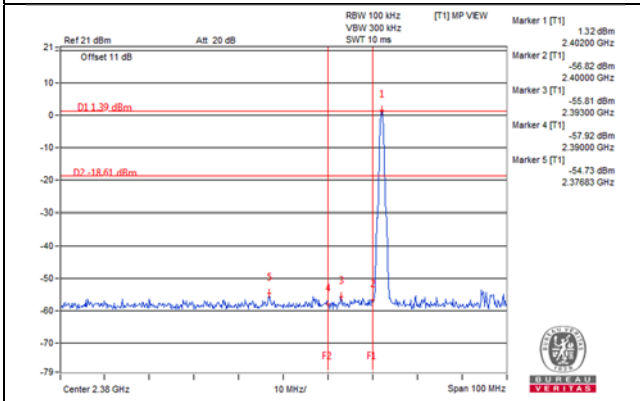

### CH 39 Band edge

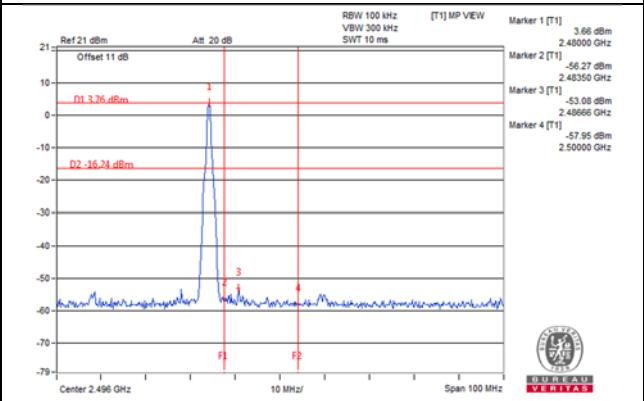



## 5 Pictures of Test Arrangements

Please refer to the attached file (Test Setup Photo).

## Appendix – Information of the Testing Laboratories

We, Bureau Veritas Consumer Products Services (H.K.) Ltd., Taoyuan Branch, were founded in 1988 to provide our best service in EMC, Radio, Telecom and Safety consultation. Our laboratories are FCC recognized accredited test firms and accredited and approved according to ISO/IEC 17025.

If you have any comments, please feel free to contact us at the following:

### Lin Kou EMC/RF Lab

Tel: 886-2-26052180

Fax: 886-2-26051924

### Hsin Chu EMC/RF/Telecom Lab

Tel: 886-3-6668565

Fax: 886-3-6668323

### Hwa Ya EMC/RF/Safety Lab

Tel: 886-3-3183232

Fax: 886-3-3270892

**Email:** [service.adt@tw.bureauveritas.com](mailto:service.adt@tw.bureauveritas.com)

**Web Site:** [www.bureauveritas-adt.com](http://www.bureauveritas-adt.com)

The address and road map of all our labs can be found in our web site also.

--- END ---