

FCC Test Report

Report No.: RF190529C27-2

FCC ID: S6J2128P

Test Model: 2128P (refer to item 3.1 for more details)

Received Date: May 29, 2019

Test Date: Jun. 04 ~ Aug. 15, 2019

Issued Date: Aug. 22, 2019

Applicant: Technology Solutions (UK) Ltd

Address: Suite A, Loughborough Technology Centre, Epinal Way, Loughborough,
Leicestershire, LE11 3GE, United Kingdom

Issued By: Bureau Veritas Consumer Products Services (H.K.) Ltd., Taoyuan Branch

Lab Address: No. 47-2, 14th Ling, Chia Pau Vil., Lin Kou Dist., New Taipei City, Taiwan
(R.O.C.)

Test Location: No. 19, Hwa Ya 2nd Rd., Wen Hwa Vil., Kwei Shan Dist., Taoyuan City
33383, TAIWAN (R.O.C.)

**FCC Registration /
Designation Number:** 788550 / TW0003



This report is for your exclusive use. Any copying or replication of this report to or for any other person or entity, or use of our name or trademark, is permitted only with our prior written permission. This report sets forth our findings solely with respect to the test samples identified herein. The results set forth in this report are not indicative or representative of the quality or characteristics of the lot from which a test sample was taken or any similar or identical product specifically and expressly noted. Our report includes all of the tests requested by you and the results thereof based upon the information that you provided to us. You have 60 days from date of issuance of this report to notify us of any material error or omission caused by our negligence, provided, however, that such notice shall be in writing and shall specifically address the issue you wish to raise. A failure to raise such issue within the prescribed time shall constitute your unqualified acceptance of the completeness of this report, the tests conducted and the correctness of the report contents. Unless specific mention, the uncertainty of measurement has been explicitly taken into account to declare the compliance or non-compliance to the specification. The report must not be used by the client to claim product certification, approval, or endorsement by TAF or any government agencies.

Table of Contents

Release Control Record	4
1 Certificate of Conformity	5
2 Summary of Test Results	6
2.1 Measurement Uncertainty.....	6
2.2 Modification Record.....	6
3 General Information	7
3.1 General Description of EUT.....	7
3.2 Description of Test Modes.....	9
3.2.1 Test Mode Applicability and Tested Channel Detail.....	10
3.3 Description of Support Units.....	11
3.3.1 Configuration of System under Test.....	12
3.4 General Description of Applied Standards.....	12
4 Test Types and Results	13
4.1 Radiated Emission and Bandedge Measurement.....	13
4.1.1 Limits of Radiated Emission and Bandedge Measurement.....	13
4.1.2 Test Instruments.....	14
4.1.3 Test Procedures.....	15
4.1.4 Deviation from Test Standard.....	15
4.1.5 Test Setup.....	16
4.1.6 EUT Operating Conditions.....	17
4.1.7 Test Results.....	18
4.2 Conducted Emission Measurement.....	48
4.2.1 Limits of Conducted Emission Measurement.....	48
4.2.2 Test Instruments.....	48
4.2.3 Test Procedures.....	49
4.2.4 Deviation from Test Standard.....	49
4.2.5 Test Setup.....	49
4.2.6 EUT Operating Conditions.....	49
4.2.7 Test Results.....	50
4.3 Number of Hopping Frequency Used.....	62
4.3.1 Limits of Hopping Frequency Used Measurement.....	62
4.3.2 Test Setup.....	62
4.3.3 Test Instruments.....	62
4.3.4 Test Procedure.....	62
4.3.5 Deviation from Test Standard.....	62
4.3.6 Test Results.....	62
4.4 Dwell Time on Each Channel.....	63
4.4.1 Limits of Dwell Time on Each Channel Measurement.....	63
4.4.2 Test Setup.....	63
4.4.3 Test Instruments.....	63
4.4.4 Test Procedures.....	63
4.4.5 Deviation from Test Standard.....	63
4.4.6 Test Results.....	64
4.5 Channel Bandwidth.....	65
4.5.1 Limits of Channel Bandwidth Measurement.....	65
4.5.2 Test Setup.....	65
4.5.3 Test Instruments.....	65
4.5.4 Test Procedure.....	65
4.5.5 Deviation from Test Standard.....	65
4.5.6 EUT Operating Condition.....	65
4.5.7 Test Results.....	66
4.6 Hopping Channel Separation.....	67
4.6.1 Limits of Hopping Channel Separation Measurement.....	67

4.6.2	Test Setup.....	67
4.6.3	Test Instruments	67
4.6.4	Test Procedure	67
4.6.5	Deviation from Test Standard	67
4.6.6	Test Results	68
4.7	Maximum Output Power.....	69
4.7.1	Limits of Maximum Output Power Measurement	69
4.7.2	Test Setup.....	69
4.7.3	Test Instruments	69
4.7.4	Test Procedure	69
4.7.5	Deviation from Test Standard	69
4.7.6	EUT Operating Condition	69
4.7.7	Test Results	69
4.8	Conducted Out of Band Emission Measurement.....	70
4.8.1	Limits Of Conducted Out Of Band Emission Measurement	70
4.8.2	Test Instruments	70
4.8.3	Test Procedure	70
4.8.4	Deviation from Test Standard	70
4.8.5	EUT Operating Condition	70
4.8.6	Test Results	70
5	Pictures of Test Arrangements.....	72
	Appendix – Information of the Testing Laboratories	73

Release Control Record

Issue No.	Description	Date Issued
RF190529C27-2	Original release	Aug. 22, 2019

1 Certificate of Conformity

Product: 2128P Bluetooth Handheld UHF RFID Reader

Brand: Technology Solutions (UK) Ltd

Test Model: 2128P (refer to item 3.1 for more details)

Sample Status: Engineering sample

Applicant: Technology Solutions (UK) Ltd

Test Date: Jun. 04 ~ Aug. 15, 2019

Standards: 47 CFR FCC Part 15, Subpart C (Section 15.247)
ANSI C63.10:2013

The above equipment has been tested by **Bureau Veritas Consumer Products Services (H.K.) Ltd., Taoyuan Branch**, and found compliance with the requirement of the above standards. The test record, data evaluation & Equipment Under Test (EUT) configurations represented herein are true and accurate accounts of the measurements of the sample's RF characteristics under the conditions specified in this report.

Prepared by : Celine Chou , **Date:** Aug. 22, 2019
Celine Chou / Senior Specialist

Approved by : Bruce Chen , **Date:** Aug. 22, 2019
Bruce Chen / Senior Project Engineer

2 Summary of Test Results

47 CFR FCC Part 15, Subpart C (Section 15.247)			
FCC Clause	Test Item	Result	Remarks
15.207	AC Power Conducted Emission	Pass	Meet the requirement of limit. Minimum passing margin is -11.09dB at 0.16569MHz.
15.247(a)(1)(i)	Number of Hopping Frequency Used	Pass	Meet the requirement of limit.
15.247(a)(1)(i)	Dwell Time on Each Channel	Pass	Meet the requirement of limit.
15.247(a)(1)(i)	1. Hopping Channel Separation 2. Spectrum Bandwidth of a Frequency Hopping Sequence Spread Spectrum System	Pass	Meet the requirement of limit.
15.247(b)(2)	Maximum Peak Output Power	Pass	Meet the requirement of limit.
15.205 & 209 & 15.247(d)	Radiated Emissions & Band Edge Measurement	Pass	Meet the requirement of limit. Minimum passing margin is -3.3dB at 2705.25MHz.
15.247(d)	Antenna Port Emission	Pass	Meet the requirement of limit.
15.203	Antenna Requirement	Pass	Antenna connector is U.FL not a standard connector.

Note:

- 20 dB bandwidth of the hopping channel is less than 250 kHz, the system shall use at least 50 hopping frequencies and the average time of occupancy on any frequency shall not be greater than 0.4 seconds within a 20 second period.
- Determining compliance based on the results of the compliance measurement, not taking into account measurement instrumentation uncertainty.

2.1 Measurement Uncertainty

Where relevant, the following measurement uncertainty levels have been estimated for tests performed on the EUT as specified in CISPR 16-4-2:

Measurement	Frequency	Expanded Uncertainty (k=2) (±)
Conducted Emissions at mains ports	150kHz ~ 30MHz	2.94 dB
Radiated Emissions up to 1 GHz	9kHz ~ 30MHz	3.04 dB
	30MHz ~ 200MHz	3.86 dB
	200MHz ~ 1000MHz	3.87 dB
Radiated Emissions above 1 GHz	1GHz ~ 18GHz	2.29 dB
	18GHz ~ 40GHz	2.29 dB

2.2 Modification Record

There were no modifications required for compliance.

3 General Information

3.1 General Description of EUT

Product	2128P Bluetooth Handheld UHF RFID Reader
Brand	Technology Solutions (UK) Ltd
Test Model	2128P
Sample Status	Engineering sample
Power Supply Rating	3.6Vdc or 3.7Vdc (Handle's battery) 5.2Vdc (Charging Cradle's adapter)
Modulation Type	FHSS (ASK)
Operating Frequency	902.75 ~ 927.25MHz
Number of Channel	50
Channel Spacing	500kHz
Output Power	897.429mW
Antenna Type	Quadrifilar Spiral Antenna with 4dBi gain
Antenna Connector	U.FL
Accessory Device	Refer to note
Cable Supplied	NA

Note:

1. All models are listed as below. Part Number: 2128P-AS1 was chosen for final test.

Model	Part Number	Variant Description	Remark
2128P	2128P-AX1	FCC/North America - No Imager	RFID Frequency Band is 902-928 MHz
	2128P-AS1	FCC/North America - with 2D Imager	RFID Frequency Band is 902-928 MHz, SE4750 Barcode Imager.

2. The EUT tests with following devices and cables.

Item	Brand	Model		Specification	Remark
Dummy Battery (for EUT use)	Technology Solutions (UK) Ltd	MD-2102-001		-	Accessory (Optional)
CT50	Honeywell	CT50		-	Support Unit
Smart Phone	Motorola	Moto E5		-	Support Unit
Handles	Technology Solutions (UK) Ltd	2102	P/N: 2102-PH-Y	Accessory (Optional)	Accessory
			P/N: 2102-PH-R	Accessory (Optional)	Accessory
		2128-TRG	P/N: 2128-TRG	Accessory	Accessory
			P/N: IH21-TRG	Accessory	Accessory
Battery (for Handle 2102)	Fey	PA-UL-LNB46E		Fey PA-UL-LNB46E (integrated into Power Handle) Rating: 3.6Vdc	Integrated into 2102
Battery (for Handle 2128-TRG)	VARTA Storage GmbH	EZPack XL, 11CP5/35/60-2		Varta EZPack XL (fitted to 2128P Main Body) Rating: 3.7Vdc	Accessory
Charging Cradle	Technology Solutions (UK) Ltd	2128-CRD		S-Mark File Number: CUBA 5.2Vdc, 4.0A Input (PSU:T6607YY)	Support Unit
Adapter (for Cradle use)	STONTRONICS	T6607YY		Input: 100-240Vac, 50/60Hz Output: 5.2Vdc, 4.0A Cable: 1.45m power cable without core attached on adapter	Support Unit
Micro USB cable (for Cradle use)	N/A	N/A		0.95m shielded with 4 cores	Support Unit
Micro SD Card	Kingston	8GB		-	Support Unit

3.2 Description of Test Modes

50 channels are provided to this EUT:

Channel	Freq. (MHz)	Channel	Freq. (MHz)
0	902.75	25	915.25
1	903.25	26	915.75
2	903.75	27	916.25
3	904.25	28	916.75
4	904.75	29	917.25
5	905.25	30	917.75
6	905.75	31	918.25
7	906.25	32	918.75
8	906.75	33	919.25
9	907.25	34	919.75
10	907.75	35	920.25
11	908.25	36	920.75
12	908.75	37	921.25
13	909.25	38	921.75
14	909.75	39	922.25
15	910.25	40	922.75
16	910.75	41	923.25
17	911.25	42	923.75
18	911.75	43	924.25
19	912.25	44	924.75
20	912.75	45	925.25
21	913.25	46	925.75
22	913.75	47	926.25
23	914.25	48	926.75
24	914.75	49	927.25

3.2.1 Test Mode Applicability and Tested Channel Detail

EUT Configure Mode	Applicable to				Description
	RE \geq 1G	RE<1G	PLC	APCM	
A	√	√	-	√	EUT + Handle (2102)
B	-	√	-	-	EUT + Handle (2128-TRG)
C	-	√	√	-	EUT + Handle (2102) + Charging Cradle (2128-CRD)
D	-	√	√	-	EUT + Handle (2128-TRG) + Charging Cradle (2128-CRD)

Where RE \geq 1G: Radiated Emission above 1GHz & Bandedge Measurement
 RE<1G: Radiated Emission below 1GHz
 PLC: Power Line Conducted Emission
 APCM: Antenna Port Conducted Measurement

Note: The EUT had been pre-tested on the positioned of each 3 axis. The worst case was found when positioned on **Z-plane**.

Radiated Emission Test (Above 1GHz):

- Pre-Scan has been conducted to determine the worst-case mode from all possible combinations between available modulations, data rates and antenna ports (if EUT with antenna diversity architecture).
- Following channel(s) was (were) selected for the final test as listed below.

EUT Configure Mode	Available Channel	Tested Channel	Modulation Type
A	0 to 49	0, 25, 49	FHSS (ASK)

Radiated Emission Test (Below 1GHz):

- Pre-Scan has been conducted to determine the worst-case mode from all possible combinations between available modulations, data rates and antenna ports (if EUT with antenna diversity architecture).
- Following channel(s) was (were) selected for the final test as listed below.

EUT Configure Mode	Available Channel	Tested Channel	Modulation Type
A, B, C, D	0 to 49	0, 25, 49	FHSS (ASK)

Power Line Conducted Emission Test:

- Pre-Scan has been conducted to determine the worst-case mode from all possible combinations between available modulations, data rates and antenna ports (if EUT with antenna diversity architecture).
- Following channel(s) was (were) selected for the final test as listed below.

EUT Configure Mode	Available Channel	Tested Channel	Modulation Type
C, D	0 to 49	0, 25, 49	FHSS (ASK)

Antenna Port Conducted Measurement:

- This item includes all test value of each mode, but only includes spectrum plot of worst value of each mode.
- Pre-Scan has been conducted to determine the worst-case mode from all possible combinations between available modulations, data rates and antenna ports (if EUT with antenna diversity architecture).
- Following channel(s) was (were) selected for the final test as listed below.

EUT Configure Mode	Available Channel	Tested Channel	Modulation Type
A	0 to 49	0, 25, 49	FHSS (ASK)

Test Condition:

Applicable to	Environmental Conditions	Input Power	Tested by
RE≥1G	24 deg. C, 70% RH	3.7Vdc	Willy Cheng
RE<1G	25 deg. C, 70% RH	3.6Vdc 3.7Vdc 120Vac, 60Hz	Willy Cheng
PLC	23 deg. C, 66% RH	120Vac, 60Hz	Willy Cheng
APCM	25 deg. C, 60% RH	3.7Vdc	Chris Lin

3.3 Description of Support Units

The EUT has been tested as an independent unit together with other necessary accessories or support units. The following support units or accessories were used to form a representative test configuration during the tests.

ID	Product	Brand	Model No.	Serial No.	FCC ID	Remarks
A.	Adapter	STONTRONICS	T6607YY	NA	NA	Provided by client For test mode C and D
B.	CT50	Honeywell	CT50	NA	NA	Provided by client For test mode A and B
C.	Charging Cradle	Technology Solutions (UK) Ltd	2128-CRD	NA	NA	Provided by client For test mode C and D
D.	Handle	Technology Solutions (UK) Ltd	2102	NA	NA	Accessory of EUT For test mode A and C
		Technology Solutions (UK) Ltd	2128-TRG	NA	NA	Accessory of EUT For test mode B and D

Note: All power cords of the above support units are non-shielded (1.8m).

ID	Descriptions	Qty.	Length (m)	Shielding (Yes/No)	Cores (Qty.)	Remarks
1.	Power cable	1	1.45	N	0	Provided by client Attached on adapter

3.3.1 Configuration of System under Test

Test Mode A and B

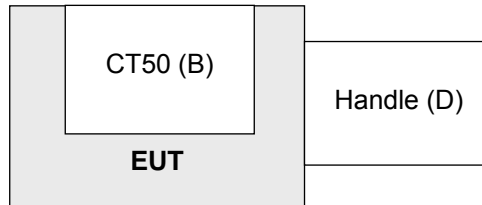

Test Mode C and D

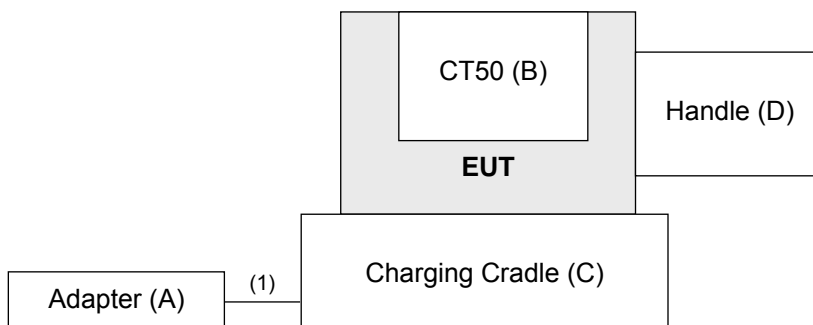

3.4 General Description of Applied Standards

The EUT is a RF Product. According to the specifications of the manufacturer, it must comply with the requirements of the following standards:

FCC Part 15, Subpart C (15.247)

KDB 558074 D01 15.247 Meas Guidance v05r02

ANSI C63.10:2013

All test items have been performed and recorded as per the above standards.

4 Test Types and Results

4.1 Radiated Emission and Bandedge Measurement

4.1.1 Limits of Radiated Emission and Bandedge Measurement

Radiated emissions which fall in the restricted bands must comply with the radiated emission limits specified as below table. Other emissions shall be at least 20dB below the highest level of the desired power:

Frequencies (MHz)	Field Strength (microvolts/meter)	Measurement Distance (meters)
0.009 ~ 0.490	2400/F(kHz)	300
0.490 ~ 1.705	24000/F(kHz)	30
1.705 ~ 30.0	30	30
30 ~ 88	100	3
88 ~ 216	150	3
216 ~ 960	200	3
Above 960	500	3

Note:

1. The lower limit shall apply at the transition frequencies.
2. Emission level (dBuV/m) = 20 log Emission level (uV/m).
3. For frequencies above 1000MHz, the field strength limits are based on average detector, however, the peak field strength of any emission shall not exceed the maximum permitted average limits, specified above by more than 20dB under any condition of modulation.

4.1.2 Test Instruments

Description & Manufacturer	Model No.	Serial No.	Cal. Date	Cal. Due
Test Receiver ROHDE & SCHWARZ	ESIB7	100187	May 30, 2019	May 29, 2020
Spectrum Analyzer ROHDE & SCHWARZ	FSP40	100269	Jun. 10, 2019	Jun. 09, 2020
BILOG Antenna SCHWARZBECK	VULB9168	9168-171	Nov. 22, 2018	Nov. 21, 2019
HORN Antenna SCHWARZBECK	9120D	209	Nov. 25, 2018	Nov. 24, 2019
HORN Antenna SCHWARZBECK	BBHA 9170	BBHA9170241	Nov. 25, 2018	Nov. 24, 2019
Loop Antenna EMCI	EM-6879	269	Sep. 07, 2018	Sep. 06, 2019
Preamplifier Agilent (Below 1GHz)	8447D	2944A10738	Aug. 21, 2018	Aug. 20, 2019
Preamplifier Agilent (Above 1GHz)	8449B	3008A02465	Mar. 27, 2019	Mar. 26, 2020
RF Coaxial Cable WORKEN With 5dB PAD	8D-FB	Cable-CH3-01	Aug. 21, 2018	Aug. 20, 2019
RF signal cable HUBER+SUHNER	SUCOFLEX 104	Cable-CH3-03 (223653/4)	Aug. 21, 2018	Aug. 20, 2019
RF signal cable HUBER+SUHNER& EMCI	SUCOFLEX 104&EMC104-SM-S M-8000	Cable-CH3-03 (309224+170907)	Aug. 21, 2018	Aug. 20, 2019
Software BV ADT	ADT_Radiated_ V7.6.15.9.5	NA	NA	NA
Antenna Tower inn-co GmbH	MA 4000	013303	NA	NA
Antenna Tower Controller BV ADT	AT100	AT93021702	NA	NA
Turn Table BV ADT	TT100	TT93021702	NA	NA
Turn Table Controller BV ADT	SC100	SC93021702	NA	NA
Boresight Antenna Fixture	FBA-01	FBA-SIP01	NA	NA
Pre-amplifier (18GHz-40GHz) EMC	EMC184045B	980175	Nov. 14, 2018	Nov. 13, 2019
USB Wideband Power Sensor KEYSIGHT	U2021XA	MY55050005/MY5519 0004/MY55190007/MY 55210005	Jul. 17, 2018	Jul. 16, 2019
			Jul. 15, 2019	Jul. 14, 2020

- Note: 1. The calibration interval of the above test instruments is 12 months and the calibrations are traceable to NML/ROC and NIST/USA.
2. The test was performed in HwaYa Chamber 3.

4.1.3 Test Procedures

For Radiated emission below 30MHz

- a. The EUT was placed on the top of a rotating table 0.8 meters above the ground at a 3 meter chamber room. The table was rotated 360 degrees to determine the position of the highest radiation.
- b. The EUT was set 3 meters away from the interference-receiving antenna, which was mounted on the top of a variable-height antenna tower.
- c. Parallel, perpendicular, and ground-parallel orientations of the antenna are set to make the measurement.
- d. For each suspected emission, the EUT was arranged to its worst case and the rotatable table was turned from 0 degrees to 360 degrees to find the maximum reading.
- e. The test-receiver system was set to Quasi-Peak Detect Function and Specified Bandwidth with Maximum Hold Mode.

Note:

1. The resolution bandwidth and video bandwidth of test receiver/spectrum analyzer is 9kHz at frequency below 30MHz.

For Radiated emission above 30MHz

- a. The EUT was placed on the top of a rotating table 0.8 meters (for 30MHz ~ 1GHz) / 1.5 meters (for above 1GHz) above the ground at 3 meter chamber room for test. The table was rotated 360 degrees to determine the position of the highest radiation.
- b. The EUT was set 3 meters away from the interference-receiving antenna, which was mounted on the top of a variable-height antenna tower.
- c. The height of antenna is varied from one meter to four meters above the ground to determine the maximum value of the field strength. Both horizontal and vertical polarizations of the antenna are set to make the measurement.
- d. For each suspected emission, the EUT was arranged to its worst case and then the antenna was tuned to heights from 1 meter to 4 meters and the rotatable table was turned from 0 degrees to 360 degrees to find the maximum reading.
- e. The test-receiver system was set to quasi-peak detect function and specified bandwidth with maximum hold mode when the test frequency is below 1 GHz.
- f. The test-receiver system was set to peak and average detect function and specified bandwidth with maximum hold mode when the test frequency is above 1 GHz. If the peak reading value also meets average limit, measurement with the average detector is unnecessary.

Note:

1. The resolution bandwidth and video bandwidth of test receiver/spectrum analyzer is 120kHz for Quasi-peak detection (QP) at frequency below 1GHz.
2. The resolution bandwidth of test receiver/spectrum analyzer is 1 MHz and the video bandwidth is 3 MHz for Peak detection (PK) at frequency above 1GHz.
3. The resolution bandwidth of test receiver/spectrum analyzer is 1MHz and the video bandwidth is $\geq 1/T$ (Duty cycle < 98%) or 10Hz (Duty cycle $\geq 98\%$) for Average detection (AV) at frequency above 1GHz. (RBW = 1 MHz, VBW = 1 kHz)
4. All modes of operation were investigated and the worst-case emissions are reported.

4.1.4 Deviation from Test Standard

No deviation.

4.1.5 Test Setup

For Radiated emission below 30MHz

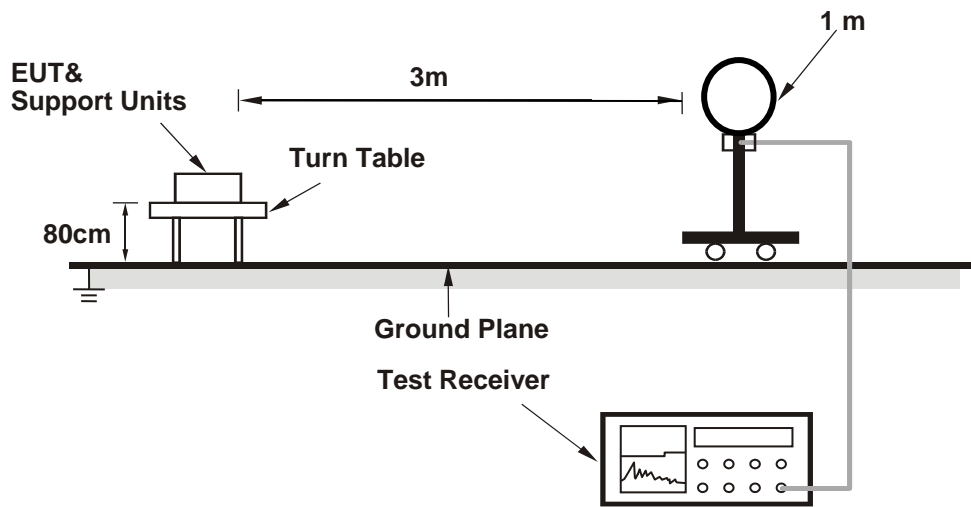

For Radiated emission 30MHz to 1GHz

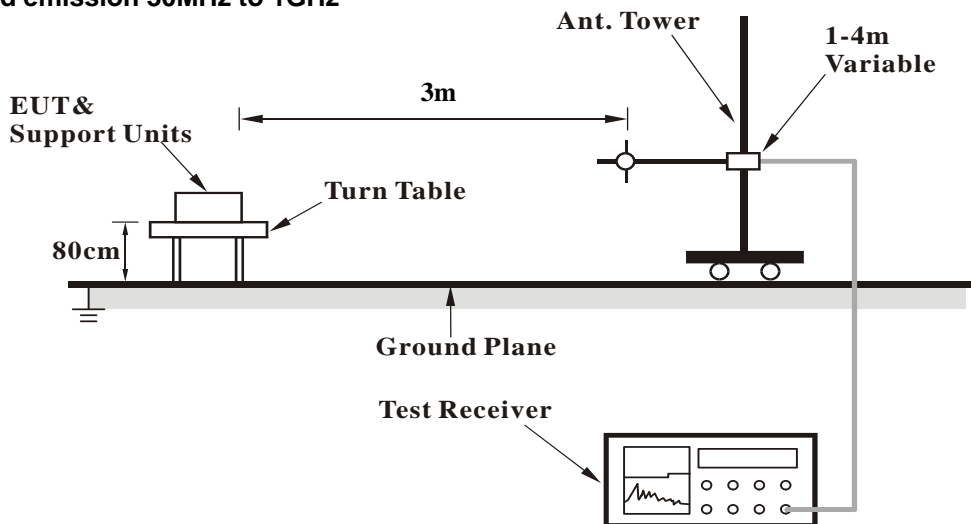

For Radiated emission above 1GHz

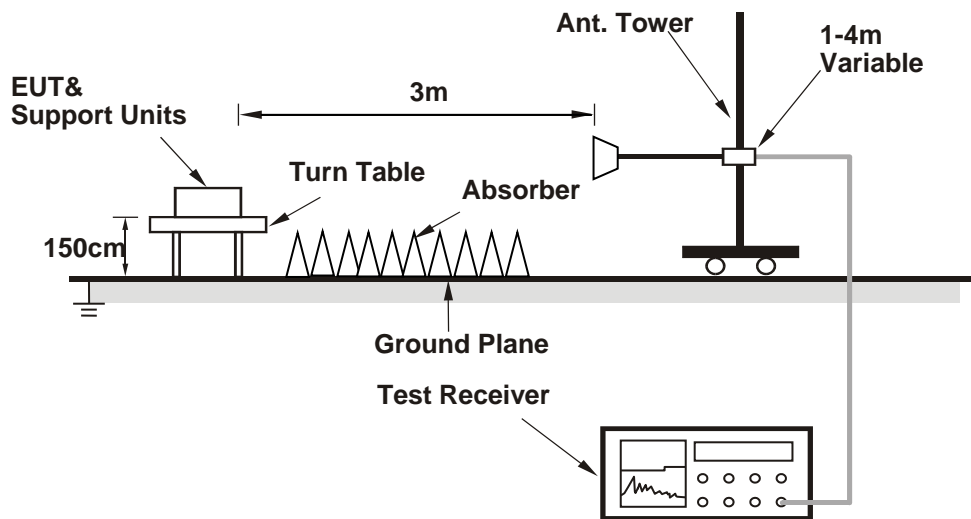

For the actual test configuration, please refer to the attached file (Test Setup Photo).

4.1.6 EUT Operating Conditions

- a. Set the EUT under transmission condition continuously at specific channel frequency.

4.1.7 Test Results

CHANNEL	TX Channel 0	DETECTOR FUNCTION	Quasi-Peak (QP)
FREQUENCY RANGE	902MHz ~ 928MHz		

ANTENNA POLARITY & TEST DISTANCE: HORIZONTAL AT 3 M

NO.	FREQ. (MHz)	EMISSION LEVEL (dBuV/m)	LIMIT (dBuV/m)	MARGIN (dB)	ANTENNA HEIGHT (m)	TABLE ANGLE (Degree)	RAW VALUE (dBuV)	CORRECTION FACTOR (dB/m)
1	#902.00	56.1 QP	105.8	-49.7	1.33 H	359	23.5	32.6
2	*902.75	125.8 QP			1.33 H	359	93.2	32.6

ANTENNA POLARITY & TEST DISTANCE: VERTICAL AT 3 M

NO.	FREQ. (MHz)	EMISSION LEVEL (dBuV/m)	LIMIT (dBuV/m)	MARGIN (dB)	ANTENNA HEIGHT (m)	TABLE ANGLE (Degree)	RAW VALUE (dBuV)	CORRECTION FACTOR (dB/m)
1	#902.00	56.4 QP	106.4	-50.0	1.02 V	352	23.8	32.6
2	*902.75	126.4 QP			1.02 V	352	93.8	32.6

Remarks:

1. Emission Level(dBuV/m) = Raw Value(dBuV) + Correction Factor(dB/m).
2. Correction Factor(dB/m) = Antenna Factor(dB/m) + Cable Factor(dB) – Pre-Amplifier Factor(dB).
3. The other emission levels were very low against the limit.
4. Margin value = Emission Level – Limit value.
5. " * ": Fundamental frequency.
6. " # ": The radiated frequency is out of the restricted band.

CHANNEL	TX Channel 25	DETECTOR FUNCTION	Quasi-Peak (QP)
FREQUENCY RANGE	902MHz ~ 928MHz		

ANTENNA POLARITY & TEST DISTANCE: HORIZONTAL AT 3 M

NO.	FREQ. (MHz)	EMISSION LEVEL (dBuV/m)	LIMIT (dBuV/m)	MARGIN (dB)	ANTENNA HEIGHT (m)	TABLE ANGLE (Degree)	RAW VALUE (dBuV)	CORRECTION FACTOR (dB/m)
1	*915.25	126.2 QP			1.34 H	353	93.3	32.9

ANTENNA POLARITY & TEST DISTANCE: VERTICAL AT 3 M

NO.	FREQ. (MHz)	EMISSION LEVEL (dBuV/m)	LIMIT (dBuV/m)	MARGIN (dB)	ANTENNA HEIGHT (m)	TABLE ANGLE (Degree)	RAW VALUE (dBuV)	CORRECTION FACTOR (dB/m)
1	*915.25	128.0 QP			1.00 V	349	95.1	32.9

Remarks:

1. Emission Level(dBuV/m) = Raw Value(dBuV) + Correction Factor(dB/m).
2. Correction Factor(dB/m) = Antenna Factor(dB/m) + Cable Factor(dB) – Pre-Amplifier Factor(dB).
3. The other emission levels were very low against the limit.
4. Margin value = Emission Level – Limit value.
5. " * ": Fundamental frequency.

CHANNEL	TX Channel 49	DETECTOR FUNCTION	Quasi-Peak (QP)
FREQUENCY RANGE	902MHz ~ 928MHz		

ANTENNA POLARITY & TEST DISTANCE: HORIZONTAL AT 3 M								
NO.	FREQ. (MHz)	EMISSION LEVEL (dBuV/m)	LIMIT (dBuV/m)	MARGIN (dB)	ANTENNA HEIGHT (m)	TABLE ANGLE (Degree)	RAW VALUE (dBuV)	CORRECTION FACTOR (dB/m)
1	*927.25	124.9 QP			1.28 H	332	91.9	33.0
2	#928.00	57.5 QP	104.9	-47.4	1.28 H	332	24.5	33.0

ANTENNA POLARITY & TEST DISTANCE: VERTICAL AT 3 M								
NO.	FREQ. (MHz)	EMISSION LEVEL (dBuV/m)	LIMIT (dBuV/m)	MARGIN (dB)	ANTENNA HEIGHT (m)	TABLE ANGLE (Degree)	RAW VALUE (dBuV)	CORRECTION FACTOR (dB/m)
1	*927.25	125.6 QP			1.00 V	353	92.6	33.0
2	#928.00	58.2 QP	105.6	-47.4	1.00 V	353	25.2	33.0

Remarks:

1. Emission Level(dBuV/m) = Raw Value(dBuV) + Correction Factor(dB/m).
2. Correction Factor(dB/m) = Antenna Factor(dB/m) + Cable Factor(dB) – Pre-Amplifier Factor(dB).
3. The other emission levels were very low against the limit.
4. Margin value = Emission Level – Limit value.
5. " * ": Fundamental frequency.
6. " # ": The radiated frequency is out of the restricted band.

CHANNEL	TX Channel 0	DETECTOR FUNCTION	Peak (PK)
FREQUENCY RANGE	1GHz ~ 25GHz		Average (AV)

ANTENNA POLARITY & TEST DISTANCE: HORIZONTAL AT 3 M

NO.	FREQ. (MHz)	EMISSION LEVEL (dBuV/m)	LIMIT (dBuV/m)	MARGIN (dB)	ANTENNA HEIGHT (m)	TABLE ANGLE (Degree)	RAW VALUE (dBuV)	CORRECTION FACTOR (dB/m)
1	2708.25	48.0 PK	74.0	-26.0	2.91 H	13	50.2	-2.2
2	2708.25	45.2 AV	54.0	-8.8	2.91 H	13	47.4	-2.2
3	5416.50	51.4 PK	74.0	-22.6	1.47 H	65	46.9	4.5
4	5416.50	47.2 AV	54.0	-6.8	1.47 H	65	42.7	4.5
5	8124.75	54.1 PK	74.0	-19.9	1.65 H	75	43.2	10.9
6	8124.75	45.0 AV	54.0	-9.0	1.65 H	75	34.1	10.9
7	9027.50	52.9 PK	74.0	-21.1	1.55 H	253	41.0	11.9
8	9027.50	41.1 AV	54.0	-12.9	1.55 H	253	29.2	11.9

ANTENNA POLARITY & TEST DISTANCE: VERTICAL AT 3 M

NO.	FREQ. (MHz)	EMISSION LEVEL (dBuV/m)	LIMIT (dBuV/m)	MARGIN (dB)	ANTENNA HEIGHT (m)	TABLE ANGLE (Degree)	RAW VALUE (dBuV)	CORRECTION FACTOR (dB/m)
1	2705.25	52.3 PK	74.0	-21.7	1.00 V	241	54.6	-2.3
2	2705.25	50.7 AV	54.0	-3.3	1.00 V	241	53.0	-2.3
3	5416.50	49.7 PK	74.0	-24.3	1.59 V	5	45.2	4.5
4	5416.50	44.1 AV	54.0	-9.9	1.59 V	5	39.6	4.5
5	8124.75	55.1 PK	74.0	-18.9	1.70 V	51	44.2	10.9
6	8124.75	48.4 AV	54.0	-5.6	1.70 V	51	37.5	10.9
7	9027.50	53.1 PK	74.0	-20.9	1.57 V	347	41.2	11.9
8	9027.50	43.5 AV	54.0	-10.5	1.57 V	347	31.6	11.9

Remarks:

1. Emission Level(dBuV/m) = Raw Value(dBuV) + Correction Factor(dB/m).
2. Correction Factor(dB/m) = Antenna Factor(dB/m) + Cable Factor(dB) – Pre-Amplifier Factor(dB).
3. The other emission levels were very low against the limit.
4. Margin value = Emission Level – Limit value.

CHANNEL	TX Channel 25	DETECTOR FUNCTION	Peak (PK)
FREQUENCY RANGE	1GHz ~ 25GHz		Average (AV)

ANTENNA POLARITY & TEST DISTANCE: HORIZONTAL AT 3 M

NO.	FREQ. (MHz)	EMISSION LEVEL (dBuV/m)	LIMIT (dBuV/m)	MARGIN (dB)	ANTENNA HEIGHT (m)	TABLE ANGLE (Degree)	RAW VALUE (dBuV)	CORRECTION FACTOR (dB/m)
1	2745.75	45.7 PK	74.0	-28.3	1.49 H	333	47.9	-2.2
2	2745.75	41.6 AV	54.0	-12.4	1.49 H	333	43.8	-2.2
3	#5491.50	49.3 PK	74.0	-24.7	1.52 H	254	44.7	4.6
4	#5491.50	43.5 AV	54.0	-10.5	1.52 H	254	38.9	4.6
5	8237.25	55.0 PK	74.0	-19.0	1.67 H	55	44.2	10.8
6	8237.25	46.3 AV	54.0	-7.7	1.67 H	55	35.5	10.8

ANTENNA POLARITY & TEST DISTANCE: VERTICAL AT 3 M

NO.	FREQ. (MHz)	EMISSION LEVEL (dBuV/m)	LIMIT (dBuV/m)	MARGIN (dB)	ANTENNA HEIGHT (m)	TABLE ANGLE (Degree)	RAW VALUE (dBuV)	CORRECTION FACTOR (dB/m)
1	2745.75	52.2 PK	74.0	-21.8	1.00 V	240	54.4	-2.2
2	2745.75	50.1 AV	54.0	-3.9	1.00 V	240	52.3	-2.2
3	#5491.50	50.3 PK	74.0	-23.7	1.77 V	6	45.7	4.6
4	#5491.50	44.5 AV	54.0	-9.5	1.77 V	6	39.9	4.6
5	8237.25	55.8 PK	74.0	-18.2	1.51 V	62	45.0	10.8
6	8237.25	49.1 AV	54.0	-4.9	1.51 V	62	38.3	10.8

Remarks:

1. Emission Level(dBuV/m) = Raw Value(dBuV) + Correction Factor(dB/m).
2. Correction Factor(dB/m) = Antenna Factor(dB/m) + Cable Factor(dB) – Pre-Amplifier Factor(dB).
3. The other emission levels were very low against the limit.
4. Margin value = Emission Level – Limit value.
5. "#": The radiated frequency is out of the restricted band.

CHANNEL	TX Channel 49	DETECTOR FUNCTION	Peak (PK)
FREQUENCY RANGE	1GHz ~ 25GHz		Average (AV)

ANTENNA POLARITY & TEST DISTANCE: HORIZONTAL AT 3 M

NO.	FREQ. (MHz)	EMISSION LEVEL (dBuV/m)	LIMIT (dBuV/m)	MARGIN (dB)	ANTENNA HEIGHT (m)	TABLE ANGLE (Degree)	RAW VALUE (dBuV)	CORRECTION FACTOR (dB/m)
1	2781.75	46.4 PK	74.0	-27.6	1.47 H	331	48.4	-2.0
2	2781.75	42.8 AV	54.0	-11.2	1.47 H	331	44.8	-2.0
3	#5563.50	48.3 PK	74.0	-25.7	2.49 H	252	43.7	4.6
4	#5563.50	41.6 AV	54.0	-12.4	2.49 H	252	37.0	4.6
5	8345.25	54.4 PK	74.0	-19.6	2.52 H	104	43.7	10.7
6	8345.25	47.8 AV	54.0	-6.2	2.52 H	104	37.1	10.7

ANTENNA POLARITY & TEST DISTANCE: VERTICAL AT 3 M

NO.	FREQ. (MHz)	EMISSION LEVEL (dBuV/m)	LIMIT (dBuV/m)	MARGIN (dB)	ANTENNA HEIGHT (m)	TABLE ANGLE (Degree)	RAW VALUE (dBuV)	CORRECTION FACTOR (dB/m)
1	2781.75	50.0 PK	74.0	-24.0	1.00 V	240	52.0	-2.0
2	2781.75	49.9 AV	54.0	-4.1	1.00 V	240	51.9	-2.0
3	#5563.50	49.3 PK	74.0	-24.7	1.64 V	357	44.7	4.6
4	#5563.50	42.6 AV	54.0	-11.4	1.64 V	357	38.0	4.6
5	8345.25	56.0 PK	74.0	-18.0	1.62 V	60	45.3	10.7
6	8345.25	48.7 AV	54.0	-5.3	1.62 V	60	38.0	10.7

Remarks:

1. Emission Level(dBuV/m) = Raw Value(dBuV) + Correction Factor(dB/m).
2. Correction Factor(dB/m) = Antenna Factor(dB/m) + Cable Factor(dB) – Pre-Amplifier Factor(dB).
3. The other emission levels were very low against the limit.
4. Margin value = Emission Level – Limit value.
5. "#": The radiated frequency is out of the restricted band.

Below 1GHz worst-case data:

CHANNEL	TX Channel 0	DETECTOR FUNCTION	Quasi-Peak (QP)
FREQUENCY RANGE	9kHz ~ 1GHz		
TEST MODE	A		

ANTENNA POLARITY & TEST DISTANCE: HORIZONTAL AT 3 M								
NO.	FREQ. (MHz)	EMISSION LEVEL (dBuV/m)	LIMIT (dBuV/m)	MARGIN (dB)	ANTENNA HEIGHT (m)	TABLE ANGLE (Degree)	RAW VALUE (dBuV)	CORRECTION FACTOR (dB/m)
1	57.12	20.8 QP	40.0	-19.2	1.99 H	15	30.9	-10.1
2	197.11	27.9 QP	43.5	-15.6	1.00 H	266	39.1	-11.2
3	313.77	31.9 QP	46.0	-14.1	1.00 H	78	39.0	-7.1
4	321.54	31.3 QP	46.0	-14.7	1.00 H	62	38.2	-6.9
5	613.19	30.6 QP	46.0	-15.4	1.00 H	76	31.5	-0.9
6	747.34	34.1 QP	46.0	-11.9	1.99 H	247	32.3	1.8

Remarks:

1. Emission Level(dBuV/m) = Raw Value(dBuV) + Correction Factor(dB/m).
2. Correction Factor(dB/m) = Antenna Factor(dB/m) + Cable Factor(dB) – Pre-Amplifier Factor(dB).
3. The other emission levels were very low against the limit of frequency range 30MHz ~ 1000MHz.
4. Margin value = Emission Level – Limit value.
5. The emission levels were very low against the limit of frequency range 9kHz ~ 30MHz: the amplitude of spurious emissions attenuated more than 20 dB below the permissible value to be report.

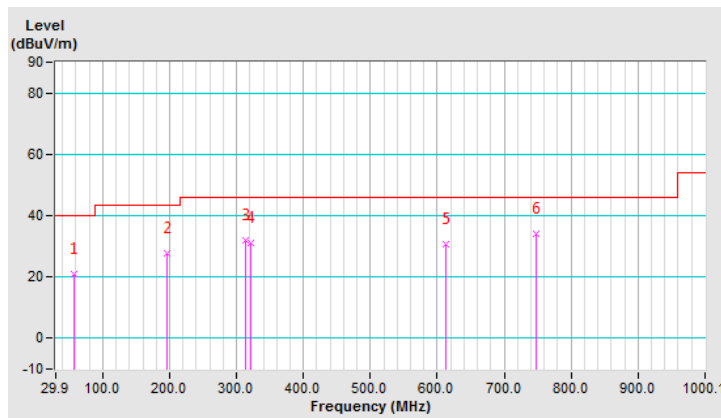

CHANNEL	TX Channel 0	DETECTOR FUNCTION	Quasi-Peak (QP)
FREQUENCY RANGE	9kHz ~ 1GHz		
TEST MODE	A		

ANTENNA POLARITY & TEST DISTANCE: VERTICAL AT 3 M								
NO.	FREQ. (MHz)	EMISSION LEVEL (dBuV/m)	LIMIT (dBuV/m)	MARGIN (dB)	ANTENNA HEIGHT (m)	TABLE ANGLE (Degree)	RAW VALUE (dBuV)	CORRECTION FACTOR (dB/m)
1	191.28	26.1 QP	43.5	-17.4	1.00 V	2	37.2	-11.1
2	202.94	26.5 QP	43.5	-17.0	1.00 V	188	37.6	-11.1
3	305.99	31.3 QP	46.0	-14.7	1.51 V	103	38.5	-7.2
4	317.65	30.1 QP	46.0	-15.9	1.51 V	50	37.1	-7.0
5	494.58	30.1 QP	46.0	-15.9	1.00 V	162	33.9	-3.8
6	539.30	31.4 QP	46.0	-14.6	1.00 V	188	34.4	-3.0

Remarks:

1. Emission Level(dBuV/m) = Raw Value(dBuV) + Correction Factor(dB/m).
2. Correction Factor(dB/m) = Antenna Factor(dB/m) + Cable Factor(dB) – Pre-Amplifier Factor(dB).
3. The other emission levels were very low against the limit of frequency range 30MHz ~ 1000MHz.
4. Margin value = Emission Level – Limit value.
5. The emission levels were very low against the limit of frequency range 9kHz ~ 30MHz: the amplitude of spurious emissions attenuated more than 20 dB below the permissible value to be report.

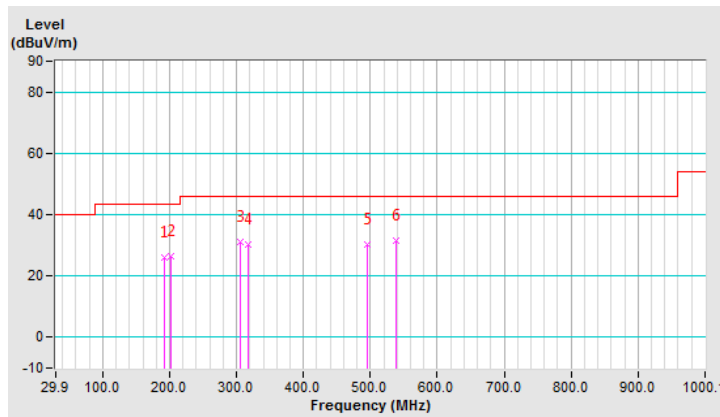

CHANNEL	TX Channel 25	DETECTOR FUNCTION	Quasi-Peak (QP)
FREQUENCY RANGE	9kHz ~ 1GHz		
TEST MODE	A		

ANTENNA POLARITY & TEST DISTANCE: HORIZONTAL AT 3 M								
NO.	FREQ. (MHz)	EMISSION LEVEL (dBuV/m)	LIMIT (dBuV/m)	MARGIN (dB)	ANTENNA HEIGHT (m)	TABLE ANGLE (Degree)	RAW VALUE (dBuV)	CORRECTION FACTOR (dB/m)
1	57.12	21.2 QP	40.0	-18.8	1.51 H	24	31.3	-10.1
2	185.44	23.7 QP	43.5	-19.8	1.51 H	108	34.4	-10.7
3	204.89	26.9 QP	43.5	-16.6	1.51 H	92	38.0	-11.1
4	317.65	32.5 QP	46.0	-13.5	1.00 H	73	39.5	-7.0
5	327.38	30.0 QP	46.0	-16.0	1.00 H	271	36.8	-6.8
6	609.30	30.5 QP	46.0	-15.5	1.00 H	97	31.5	-1.0

Remarks:

1. Emission Level(dBuV/m) = Raw Value(dBuV) + Correction Factor(dB/m).
2. Correction Factor(dB/m) = Antenna Factor(dB/m) + Cable Factor(dB) – Pre-Amplifier Factor(dB).
3. The other emission levels were very low against the limit of frequency range 30MHz ~ 1000MHz.
4. Margin value = Emission Level – Limit value.
5. The emission levels were very low against the limit of frequency range 9kHz ~ 30MHz: the amplitude of spurious emissions attenuated more than 20 dB below the permissible value to be report.

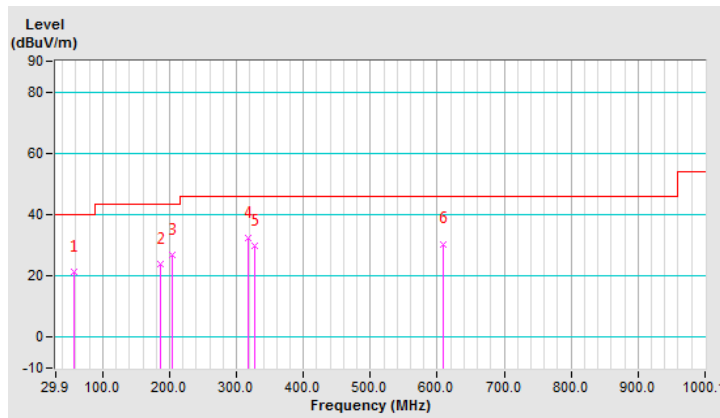

CHANNEL	TX Channel 25	DETECTOR FUNCTION	Quasi-Peak (QP)
FREQUENCY RANGE	9kHz ~ 1GHz		
TEST MODE	A		

ANTENNA POLARITY & TEST DISTANCE: VERTICAL AT 3 M								
NO.	FREQ. (MHz)	EMISSION LEVEL (dBuV/m)	LIMIT (dBuV/m)	MARGIN (dB)	ANTENNA HEIGHT (m)	TABLE ANGLE (Degree)	RAW VALUE (dBuV)	CORRECTION FACTOR (dB/m)
1	57.12	21.5 QP	40.0	-18.5	1.99 V	240	31.6	-10.1
2	197.11	28.1 QP	43.5	-15.4	1.50 V	248	39.3	-11.2
3	309.88	31.6 QP	46.0	-14.4	1.00 V	232	38.7	-7.1
4	323.49	31.7 QP	46.0	-14.3	1.00 V	255	38.6	-6.9
5	451.81	27.3 QP	46.0	-18.7	1.50 V	70	31.6	-4.3
6	603.47	30.6 QP	46.0	-15.4	1.00 V	89	31.7	-1.1

Remarks:

1. Emission Level(dBuV/m) = Raw Value(dBuV) + Correction Factor(dB/m).
2. Correction Factor(dB/m) = Antenna Factor(dB/m) + Cable Factor(dB) – Pre-Amplifier Factor(dB).
3. The other emission levels were very low against the limit of frequency range 30MHz ~ 1000MHz.
4. Margin value = Emission Level – Limit value.
5. The emission levels were very low against the limit of frequency range 9kHz ~ 30MHz: the amplitude of spurious emissions attenuated more than 20 dB below the permissible value to be report.

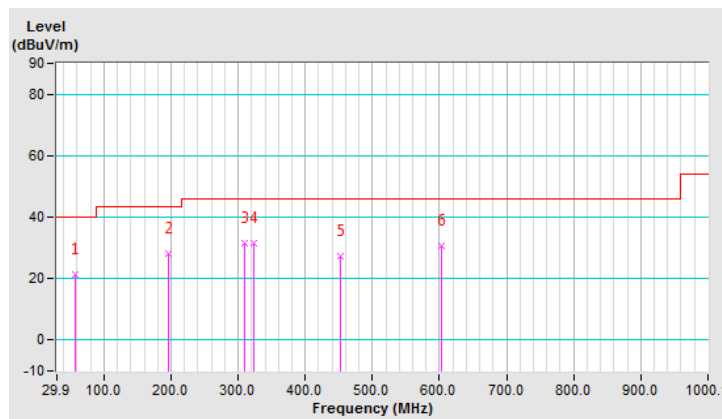

CHANNEL	TX Channel 49	DETECTOR FUNCTION	Quasi-Peak (QP)
FREQUENCY RANGE	9kHz ~ 1GHz		
TEST MODE	A		

ANTENNA POLARITY & TEST DISTANCE: HORIZONTAL AT 3 M								
NO.	FREQ. (MHz)	EMISSION LEVEL (dBuV/m)	LIMIT (dBuV/m)	MARGIN (dB)	ANTENNA HEIGHT (m)	TABLE ANGLE (Degree)	RAW VALUE (dBuV)	CORRECTION FACTOR (dB/m)
1	43.51	19.7 QP	40.0	-20.3	1.99 H	21	29.7	-10.0
2	210.72	27.1 QP	43.5	-16.4	1.00 H	248	38.1	-11.0
3	300.16	29.0 QP	46.0	-17.0	1.00 H	254	36.4	-7.4
4	317.65	31.7 QP	46.0	-14.3	1.00 H	278	38.7	-7.0
5	603.47	31.4 QP	46.0	-14.6	1.00 H	97	32.5	-1.1
6	655.96	30.5 QP	46.0	-15.5	1.49 H	15	31.0	-0.5

Remarks:

1. Emission Level(dBuV/m) = Raw Value(dBuV) + Correction Factor(dB/m).
2. Correction Factor(dB/m) = Antenna Factor(dB/m) + Cable Factor(dB) – Pre-Amplifier Factor(dB).
3. The other emission levels were very low against the limit of frequency range 30MHz ~ 1000MHz.
4. Margin value = Emission Level – Limit value.
5. The emission levels were very low against the limit of frequency range 9kHz ~ 30MHz: the amplitude of spurious emissions attenuated more than 20 dB below the permissible value to be report.

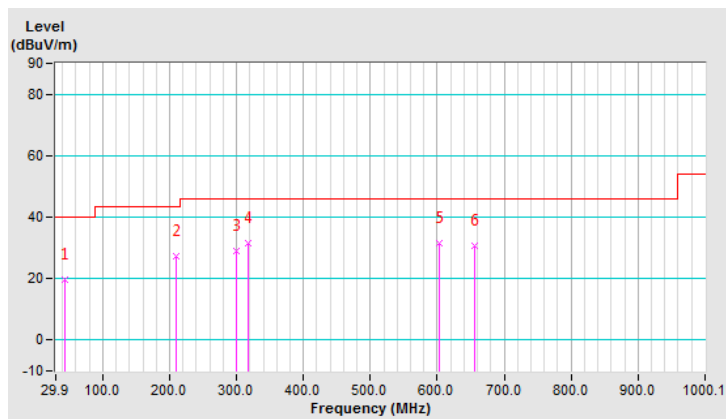

CHANNEL	TX Channel 49	DETECTOR FUNCTION	Quasi-Peak (QP)
FREQUENCY RANGE	9kHz ~ 1GHz		
TEST MODE	A		

ANTENNA POLARITY & TEST DISTANCE: VERTICAL AT 3 M								
NO.	FREQ. (MHz)	EMISSION LEVEL (dBuV/m)	LIMIT (dBuV/m)	MARGIN (dB)	ANTENNA HEIGHT (m)	TABLE ANGLE (Degree)	RAW VALUE (dBuV)	CORRECTION FACTOR (dB/m)
1	191.28	26.1 QP	43.5	-17.4	1.01 V	30	37.2	-11.1
2	197.11	25.7 QP	43.5	-17.8	1.01 V	236	36.9	-11.2
3	251.55	24.9 QP	46.0	-21.1	2.00 V	135	34.0	-9.1
4	319.60	27.3 QP	46.0	-18.7	2.00 V	144	34.2	-6.9
5	480.97	30.8 QP	46.0	-15.2	1.01 V	69	34.8	-4.0
6	619.02	30.7 QP	46.0	-15.3	1.01 V	201	31.5	-0.8

Remarks:

1. Emission Level(dBuV/m) = Raw Value(dBuV) + Correction Factor(dB/m).
2. Correction Factor(dB/m) = Antenna Factor(dB/m) + Cable Factor(dB) – Pre-Amplifier Factor(dB).
3. The other emission levels were very low against the limit of frequency range 30MHz ~ 1000MHz.
4. Margin value = Emission Level – Limit value.
5. The emission levels were very low against the limit of frequency range 9kHz ~ 30MHz: the amplitude of spurious emissions attenuated more than 20 dB below the permissible value to be report.

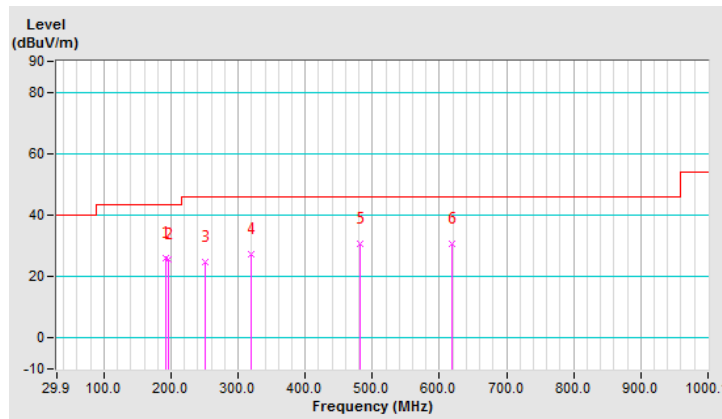

CHANNEL	TX Channel 0	DETECTOR FUNCTION	Quasi-Peak (QP)
FREQUENCY RANGE	9kHz ~ 1GHz		
TEST MODE	B		

ANTENNA POLARITY & TEST DISTANCE: HORIZONTAL AT 3 M								
NO.	FREQ. (MHz)	EMISSION LEVEL (dBuV/m)	LIMIT (dBuV/m)	MARGIN (dB)	ANTENNA HEIGHT (m)	TABLE ANGLE (Degree)	RAW VALUE (dBuV)	CORRECTION FACTOR (dB/m)
1	43.51	20.0 QP	40.0	-20.0	1.01 H	42	30.0	-10.0
2	53.23	19.9 QP	40.0	-20.1	1.01 H	165	29.7	-9.8
3	191.28	24.8 QP	43.5	-18.7	1.01 H	96	35.9	-11.1
4	204.89	23.7 QP	43.5	-19.8	1.01 H	240	34.8	-11.1
5	475.14	26.2 QP	46.0	-19.8	1.01 H	73	30.3	-4.1
6	609.30	28.7 QP	46.0	-17.3	1.01 H	15	29.7	-1.0

Remarks:

1. Emission Level(dBuV/m) = Raw Value(dBuV) + Correction Factor(dB/m).
2. Correction Factor(dB/m) = Antenna Factor(dB/m) + Cable Factor(dB) – Pre-Amplifier Factor(dB).
3. The other emission levels were very low against the limit of frequency range 30MHz ~ 1000MHz.
4. Margin value = Emission Level – Limit value.
5. The emission levels were very low against the limit of frequency range 9kHz ~ 30MHz: the amplitude of spurious emissions attenuated more than 20 dB below the permissible value to be report.

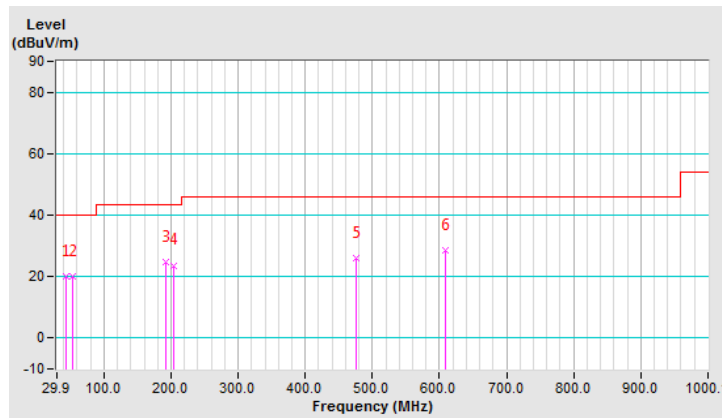

CHANNEL	TX Channel 0	DETECTOR FUNCTION	Quasi-Peak (QP)
FREQUENCY RANGE	9kHz ~ 1GHz		
TEST MODE	B		

ANTENNA POLARITY & TEST DISTANCE: VERTICAL AT 3 M								
NO.	FREQ. (MHz)	EMISSION LEVEL (dBuV/m)	LIMIT (dBuV/m)	MARGIN (dB)	ANTENNA HEIGHT (m)	TABLE ANGLE (Degree)	RAW VALUE (dBuV)	CORRECTION FACTOR (dB/m)
1	41.57	19.7 QP	40.0	-20.3	1.49 V	7	29.8	-10.1
2	191.28	25.2 QP	43.5	-18.3	1.00 V	155	36.3	-11.1
3	276.82	23.4 QP	46.0	-22.6	1.49 V	99	31.4	-8.0
4	444.03	26.2 QP	46.0	-19.8	1.49 V	355	30.6	-4.4
5	622.91	29.0 QP	46.0	-17.0	1.99 V	277	29.7	-0.7
6	638.46	29.1 QP	46.0	-16.9	1.99 V	3	29.6	-0.5

Remarks:

1. Emission Level(dBuV/m) = Raw Value(dBuV) + Correction Factor(dB/m).
2. Correction Factor(dB/m) = Antenna Factor(dB/m) + Cable Factor(dB) – Pre-Amplifier Factor(dB).
3. The other emission levels were very low against the limit of frequency range 30MHz ~ 1000MHz.
4. Margin value = Emission Level – Limit value.
5. The emission levels were very low against the limit of frequency range 9kHz ~ 30MHz: the amplitude of spurious emissions attenuated more than 20 dB below the permissible value to be report.

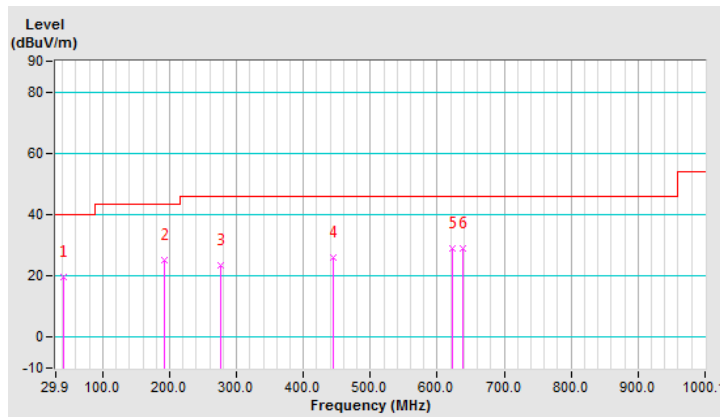

CHANNEL	TX Channel 25	DETECTOR FUNCTION	Quasi-Peak (QP)
FREQUENCY RANGE	9kHz ~ 1GHz		
TEST MODE	B		

ANTENNA POLARITY & TEST DISTANCE: HORIZONTAL AT 3 M								
NO.	FREQ. (MHz)	EMISSION LEVEL (dBuV/m)	LIMIT (dBuV/m)	MARGIN (dB)	ANTENNA HEIGHT (m)	TABLE ANGLE (Degree)	RAW VALUE (dBuV)	CORRECTION FACTOR (dB/m)
1	57.12	20.8 QP	40.0	-19.2	1.99 H	249	30.9	-10.1
2	70.73	20.3 QP	40.0	-19.7	1.99 H	96	32.3	-12.0
3	146.56	24.3 QP	43.5	-19.2	1.50 H	16	33.5	-9.2
4	201.00	25.3 QP	43.5	-18.2	1.00 H	63	36.4	-11.1
5	445.98	26.0 QP	46.0	-20.0	1.50 H	125	30.4	-4.4
6	628.74	28.8 QP	46.0	-17.2	1.00 H	98	29.4	-0.6

Remarks:

1. Emission Level(dBuV/m) = Raw Value(dBuV) + Correction Factor(dB/m).
2. Correction Factor(dB/m) = Antenna Factor(dB/m) + Cable Factor(dB) – Pre-Amplifier Factor(dB).
3. The other emission levels were very low against the limit of frequency range 30MHz ~ 1000MHz.
4. Margin value = Emission Level – Limit value.
5. The emission levels were very low against the limit of frequency range 9kHz ~ 30MHz: the amplitude of spurious emissions attenuated more than 20 dB below the permissible value to be report.

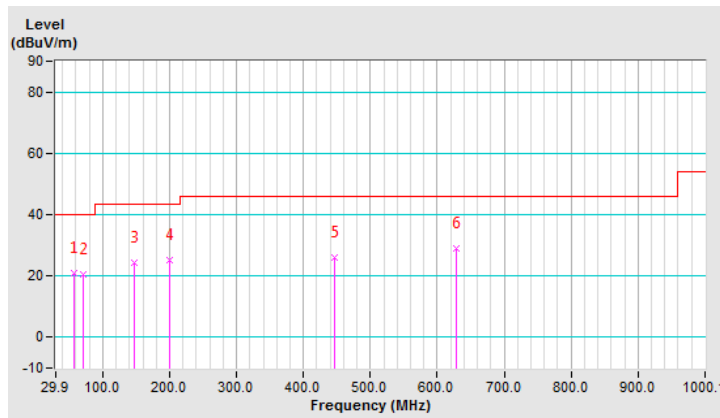

CHANNEL	TX Channel 25	DETECTOR FUNCTION	Quasi-Peak (QP)
FREQUENCY RANGE	9kHz ~ 1GHz		
TEST MODE	B		

ANTENNA POLARITY & TEST DISTANCE: VERTICAL AT 3 M								
NO.	FREQ. (MHz)	EMISSION LEVEL (dBuV/m)	LIMIT (dBuV/m)	MARGIN (dB)	ANTENNA HEIGHT (m)	TABLE ANGLE (Degree)	RAW VALUE (dBuV)	CORRECTION FACTOR (dB/m)
1	41.57	19.9 QP	40.0	-20.1	1.51 V	235	30.0	-10.1
2	191.28	25.7 QP	43.5	-17.8	1.00 V	10	36.8	-11.1
3	251.55	24.2 QP	46.0	-21.8	1.99 V	16	33.3	-9.1
4	288.49	23.8 QP	46.0	-22.2	1.51 V	276	31.4	-7.6
5	445.98	26.2 QP	46.0	-19.8	1.00 V	306	30.6	-4.4
6	624.85	29.3 QP	46.0	-16.7	1.51 V	207	30.0	-0.7

Remarks:

1. Emission Level(dBuV/m) = Raw Value(dBuV) + Correction Factor(dB/m).
2. Correction Factor(dB/m) = Antenna Factor(dB/m) + Cable Factor(dB) – Pre-Amplifier Factor(dB).
3. The other emission levels were very low against the limit of frequency range 30MHz ~ 1000MHz.
4. Margin value = Emission Level – Limit value.
5. The emission levels were very low against the limit of frequency range 9kHz ~ 30MHz: the amplitude of spurious emissions attenuated more than 20 dB below the permissible value to be report.

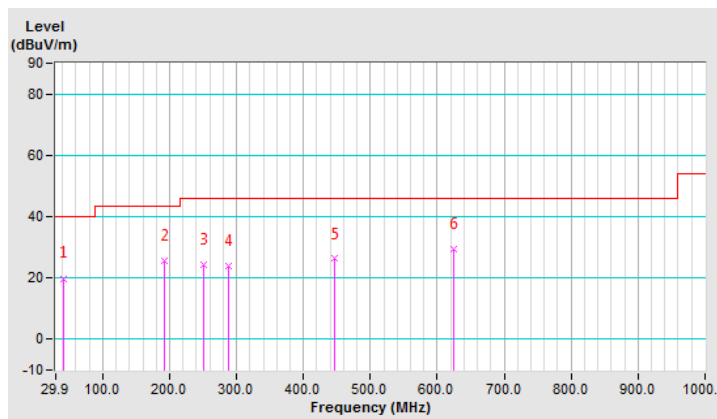

CHANNEL	TX Channel 49	DETECTOR FUNCTION	Quasi-Peak (QP)
FREQUENCY RANGE	9kHz ~ 1GHz		
TEST MODE	B		

ANTENNA POLARITY & TEST DISTANCE: HORIZONTAL AT 3 M

NO.	FREQ. (MHz)	EMISSION LEVEL (dBuV/m)	LIMIT (dBuV/m)	MARGIN (dB)	ANTENNA HEIGHT (m)	TABLE ANGLE (Degree)	RAW VALUE (dBuV)	CORRECTION FACTOR (dB/m)
1	43.51	19.3 QP	40.0	-20.7	1.99 H	267	29.3	-10.0
2	191.28	24.6 QP	43.5	-18.9	1.51 H	266	35.7	-11.1
3	202.94	25.6 QP	43.5	-17.9	1.00 H	247	36.7	-11.1
4	331.26	26.1 QP	46.0	-19.9	1.51 H	202	32.8	-6.7
5	521.81	27.5 QP	46.0	-18.5	1.00 H	307	30.8	-3.3
6	634.57	29.5 QP	46.0	-16.5	1.51 H	119	30.0	-0.5

Remarks:

1. Emission Level(dBuV/m) = Raw Value(dBuV) + Correction Factor(dB/m).
2. Correction Factor(dB/m) = Antenna Factor(dB/m) + Cable Factor(dB) – Pre-Amplifier Factor(dB).
3. The other emission levels were very low against the limit of frequency range 30MHz ~ 1000MHz.
4. Margin value = Emission Level – Limit value.
5. The emission levels were very low against the limit of frequency range 9kHz ~ 30MHz: the amplitude of spurious emissions attenuated more than 20 dB below the permissible value to be report.

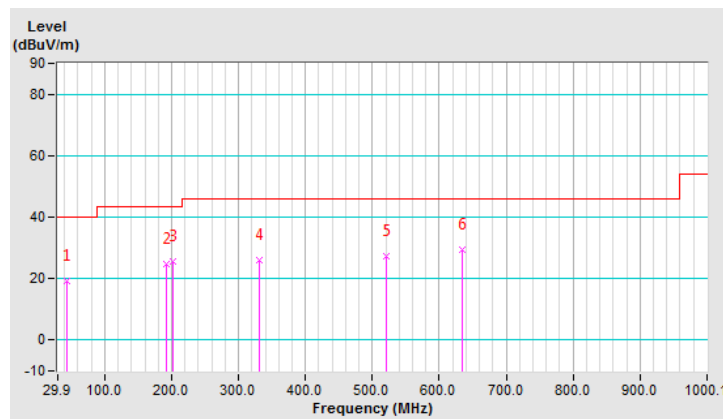

CHANNEL	TX Channel 49	DETECTOR FUNCTION	Quasi-Peak (QP)
FREQUENCY RANGE	9kHz ~ 1GHz		
TEST MODE	B		

ANTENNA POLARITY & TEST DISTANCE: VERTICAL AT 3 M								
NO.	FREQ. (MHz)	EMISSION LEVEL (dBuV/m)	LIMIT (dBuV/m)	MARGIN (dB)	ANTENNA HEIGHT (m)	TABLE ANGLE (Degree)	RAW VALUE (dBuV)	CORRECTION FACTOR (dB/m)
1	191.28	26.2 QP	43.5	-17.3	1.00 V	249	37.3	-11.1
2	251.55	23.1 QP	46.0	-22.9	1.49 V	274	32.2	-9.1
3	288.49	25.6 QP	46.0	-20.4	1.49 V	6	33.2	-7.6
4	445.98	27.2 QP	46.0	-18.8	1.00 V	241	31.6	-4.4
5	589.86	28.6 QP	46.0	-17.4	1.00 V	83	30.1	-1.5
6	652.07	29.6 QP	46.0	-16.4	1.00 V	287	30.1	-0.5

Remarks:

1. Emission Level(dBuV/m) = Raw Value(dBuV) + Correction Factor(dB/m).
2. Correction Factor(dB/m) = Antenna Factor(dB/m) + Cable Factor(dB) – Pre-Amplifier Factor(dB).
3. The other emission levels were very low against the limit of frequency range 30MHz ~ 1000MHz.
4. Margin value = Emission Level – Limit value.
5. The emission levels were very low against the limit of frequency range 9kHz ~ 30MHz: the amplitude of spurious emissions attenuated more than 20 dB below the permissible value to be report.

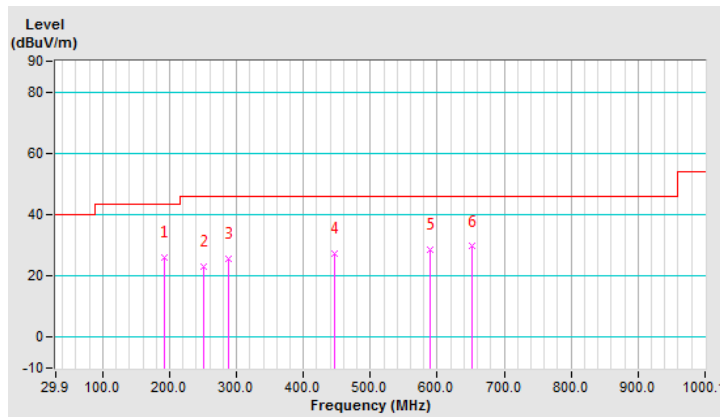

CHANNEL	TX Channel 0	DETECTOR FUNCTION	Quasi-Peak (QP)
FREQUENCY RANGE	9kHz ~ 1GHz		
TEST MODE	C		

ANTENNA POLARITY & TEST DISTANCE: HORIZONTAL AT 3 M								
NO.	FREQ. (MHz)	EMISSION LEVEL (dBuV/m)	LIMIT (dBuV/m)	MARGIN (dB)	ANTENNA HEIGHT (m)	TABLE ANGLE (Degree)	RAW VALUE (dBuV)	CORRECTION FACTOR (dB/m)
1	43.61	22.9 QP	40.0	-17.1	1.99 H	134	32.8	-9.9
2	70.82	24.7 QP	40.0	-15.3	1.49 H	150	36.7	-12.0
3	241.88	31.1 QP	46.0	-14.9	1.49 H	104	40.6	-9.5
4	267.15	34.6 QP	46.0	-11.4	1.49 H	133	43.0	-8.4
5	307.98	36.0 QP	46.0	-10.0	1.49 H	240	43.1	-7.1
6	379.90	28.4 QP	46.0	-17.6	1.99 H	67	34.3	-5.9

Remarks:

1. Emission Level(dBuV/m) = Raw Value(dBuV) + Correction Factor(dB/m).
2. Correction Factor(dB/m) = Antenna Factor(dB/m) + Cable Factor(dB) – Pre-Amplifier Factor(dB).
3. The other emission levels were very low against the limit of frequency range 30MHz ~ 1000MHz.
4. Margin value = Emission Level – Limit value.
5. The emission levels were very low against the limit of frequency range 9kHz ~ 30MHz: the amplitude of spurious emissions attenuated more than 20 dB below the permissible value to be report.

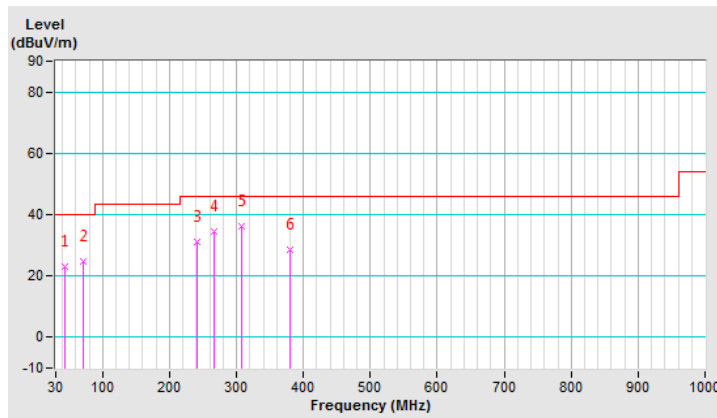

CHANNEL	TX Channel 0	DETECTOR FUNCTION	Quasi-Peak (QP)
FREQUENCY RANGE	9kHz ~ 1GHz		
TEST MODE	C		

ANTENNA POLARITY & TEST DISTANCE: VERTICAL AT 3 M								
NO.	FREQ. (MHz)	EMISSION LEVEL (dBuV/m)	LIMIT (dBuV/m)	MARGIN (dB)	ANTENNA HEIGHT (m)	TABLE ANGLE (Degree)	RAW VALUE (dBuV)	CORRECTION FACTOR (dB/m)
1	49.44	28.5 QP	40.0	-11.5	1.00 V	332	38.2	-9.7
2	232.16	29.4 QP	46.0	-16.6	1.00 V	131	39.6	-10.2
3	274.93	33.5 QP	46.0	-12.5	1.50 V	176	41.6	-8.1
4	311.86	36.2 QP	46.0	-9.8	1.50 V	170	43.2	-7.0
5	327.41	32.4 QP	46.0	-13.6	1.50 V	63	39.2	-6.8
6	383.79	28.9 QP	46.0	-17.1	1.50 V	86	34.7	-5.8

Remarks:

1. Emission Level(dBuV/m) = Raw Value(dBuV) + Correction Factor(dB/m).
2. Correction Factor(dB/m) = Antenna Factor(dB/m) + Cable Factor(dB) – Pre-Amplifier Factor(dB).
3. The other emission levels were very low against the limit of frequency range 30MHz ~ 1000MHz.
4. Margin value = Emission Level – Limit value.
5. The emission levels were very low against the limit of frequency range 9kHz ~ 30MHz: the amplitude of spurious emissions attenuated more than 20 dB below the permissible value to be report.

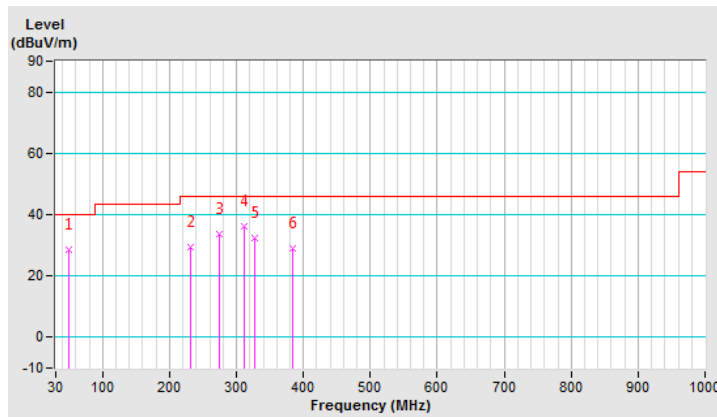

CHANNEL	TX Channel 25	DETECTOR FUNCTION	Quasi-Peak (QP)
FREQUENCY RANGE	9kHz ~ 1GHz		
TEST MODE	C		

ANTENNA POLARITY & TEST DISTANCE: HORIZONTAL AT 3 M								
NO.	FREQ. (MHz)	EMISSION LEVEL (dBuV/m)	LIMIT (dBuV/m)	MARGIN (dB)	ANTENNA HEIGHT (m)	TABLE ANGLE (Degree)	RAW VALUE (dBuV)	CORRECTION FACTOR (dB/m)
1	43.61	22.6 QP	40.0	-17.4	1.99 H	64	32.5	-9.9
2	70.82	25.3 QP	40.0	-14.7	1.99 H	123	37.3	-12.0
3	241.88	31.2 QP	46.0	-14.8	1.50 H	106	40.7	-9.5
4	271.04	32.7 QP	46.0	-13.3	1.50 H	242	41.0	-8.3
5	323.53	28.1 QP	46.0	-17.9	1.50 H	24	35.0	-6.9
6	422.67	24.5 QP	46.0	-21.5	1.99 H	232	29.4	-4.9

Remarks:

1. Emission Level(dBuV/m) = Raw Value(dBuV) + Correction Factor(dB/m).
2. Correction Factor(dB/m) = Antenna Factor(dB/m) + Cable Factor(dB) – Pre-Amplifier Factor(dB).
3. The other emission levels were very low against the limit of frequency range 30MHz ~ 1000MHz.
4. Margin value = Emission Level – Limit value.
5. The emission levels were very low against the limit of frequency range 9kHz ~ 30MHz: the amplitude of spurious emissions attenuated more than 20 dB below the permissible value to be report.

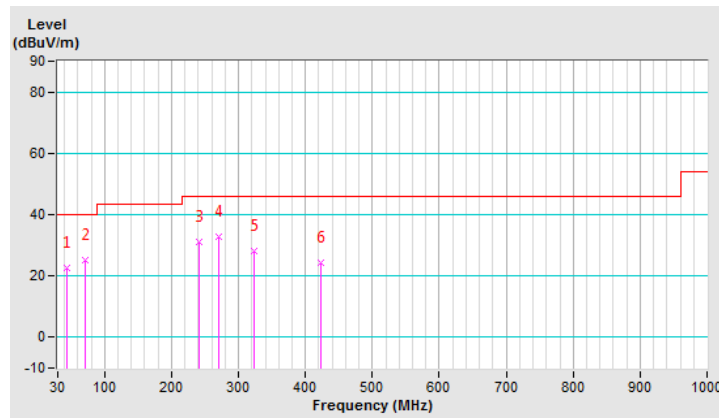

CHANNEL	TX Channel 25	DETECTOR FUNCTION	Quasi-Peak (QP)
FREQUENCY RANGE	9kHz ~ 1GHz		
TEST MODE	C		

ANTENNA POLARITY & TEST DISTANCE: VERTICAL AT 3 M								
NO.	FREQ. (MHz)	EMISSION LEVEL (dBuV/m)	LIMIT (dBuV/m)	MARGIN (dB)	ANTENNA HEIGHT (m)	TABLE ANGLE (Degree)	RAW VALUE (dBuV)	CORRECTION FACTOR (dB/m)
1	43.61	30.9 QP	40.0	-9.1	1.01 V	23	40.8	-9.9
2	57.21	26.3 QP	40.0	-13.7	1.01 V	229	36.4	-10.1
3	234.11	29.7 QP	46.0	-16.3	1.01 V	139	39.8	-10.1
4	282.71	32.6 QP	46.0	-13.4	1.50 V	144	40.4	-7.8
5	321.58	34.6 QP	46.0	-11.4	1.50 V	155	41.5	-6.9
6	372.12	27.6 QP	46.0	-18.4	1.50 V	70	33.7	-6.1

Remarks:

1. Emission Level(dBuV/m) = Raw Value(dBuV) + Correction Factor(dB/m).
2. Correction Factor(dB/m) = Antenna Factor(dB/m) + Cable Factor(dB) – Pre-Amplifier Factor(dB).
3. The other emission levels were very low against the limit of frequency range 30MHz ~ 1000MHz.
4. Margin value = Emission Level – Limit value.
5. The emission levels were very low against the limit of frequency range 9kHz ~ 30MHz: the amplitude of spurious emissions attenuated more than 20 dB below the permissible value to be report.

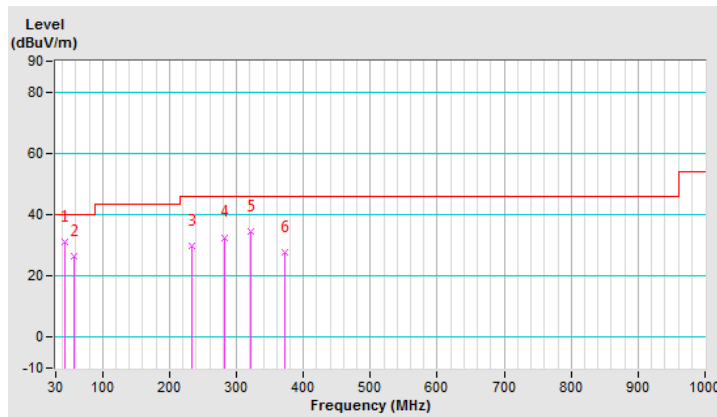

CHANNEL	TX Channel 49	DETECTOR FUNCTION	Quasi-Peak (QP)
FREQUENCY RANGE	9kHz ~ 1GHz		
TEST MODE	C		

ANTENNA POLARITY & TEST DISTANCE: HORIZONTAL AT 3 M								
NO.	FREQ. (MHz)	EMISSION LEVEL (dBuV/m)	LIMIT (dBuV/m)	MARGIN (dB)	ANTENNA HEIGHT (m)	TABLE ANGLE (Degree)	RAW VALUE (dBuV)	CORRECTION FACTOR (dB/m)
1	45.55	24.8 QP	40.0	-15.2	1.49 H	250	34.6	-9.8
2	70.82	25.6 QP	40.0	-14.4	1.99 H	114	37.6	-12.0
3	232.16	28.1 QP	46.0	-17.9	1.49 H	94	38.3	-10.2
4	282.71	31.1 QP	46.0	-14.9	1.49 H	256	38.9	-7.8
5	306.03	36.7 QP	46.0	-9.3	1.49 H	248	43.9	-7.2
6	440.16	24.8 QP	46.0	-21.2	1.49 H	11	29.2	-4.4

Remarks:

1. Emission Level(dBuV/m) = Raw Value(dBuV) + Correction Factor(dB/m).
2. Correction Factor(dB/m) = Antenna Factor(dB/m) + Cable Factor(dB) – Pre-Amplifier Factor(dB).
3. The other emission levels were very low against the limit of frequency range 30MHz ~ 1000MHz.
4. Margin value = Emission Level – Limit value.
5. The emission levels were very low against the limit of frequency range 9kHz ~ 30MHz: the amplitude of spurious emissions attenuated more than 20 dB below the permissible value to be report.

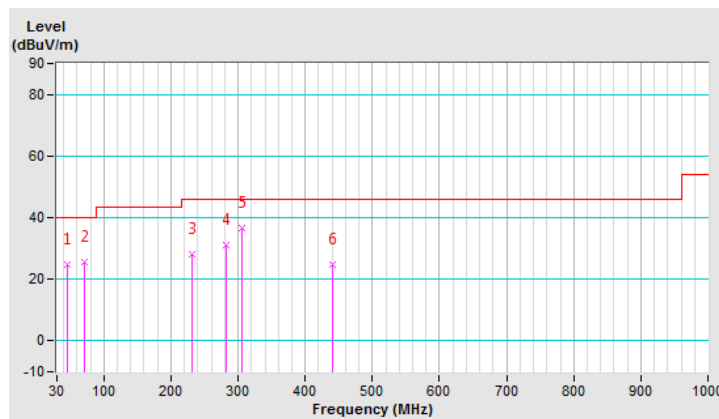

CHANNEL	TX Channel 49	DETECTOR FUNCTION	Quasi-Peak (QP)
FREQUENCY RANGE	9kHz ~ 1GHz		
TEST MODE	C		

ANTENNA POLARITY & TEST DISTANCE: VERTICAL AT 3 M								
NO.	FREQ. (MHz)	EMISSION LEVEL (dBuV/m)	LIMIT (dBuV/m)	MARGIN (dB)	ANTENNA HEIGHT (m)	TABLE ANGLE (Degree)	RAW VALUE (dBuV)	CORRECTION FACTOR (dB/m)
1	45.55	31.0 QP	40.0	-9.0	1.00 V	356	40.8	-9.8
2	55.27	35.6 QP	40.0	-4.4	1.49 V	350	45.4	-9.8
3	238.00	33.8 QP	46.0	-12.2	1.00 V	138	43.6	-9.8
4	280.76	33.8 QP	46.0	-12.2	1.49 V	181	41.6	-7.8
5	315.75	37.4 QP	46.0	-8.6	1.49 V	150	44.4	-7.0
6	620.94	29.0 QP	46.0	-17.0	1.49 V	359	29.8	-0.8

Remarks:

1. Emission Level(dBuV/m) = Raw Value(dBuV) + Correction Factor(dB/m).
2. Correction Factor(dB/m) = Antenna Factor(dB/m) + Cable Factor(dB) – Pre-Amplifier Factor(dB).
3. The other emission levels were very low against the limit of frequency range 30MHz ~ 1000MHz.
4. Margin value = Emission Level – Limit value.
5. The emission levels were very low against the limit of frequency range 9kHz ~ 30MHz: the amplitude of spurious emissions attenuated more than 20 dB below the permissible value to be report.

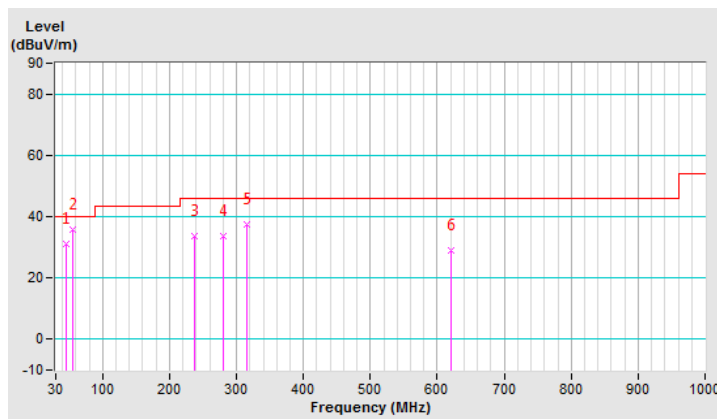

CHANNEL	TX Channel 0	DETECTOR FUNCTION	Quasi-Peak (QP)
FREQUENCY RANGE	9kHz ~ 1GHz		
TEST MODE	D		

ANTENNA POLARITY & TEST DISTANCE: HORIZONTAL AT 3 M								
NO.	FREQ. (MHz)	EMISSION LEVEL (dBuV/m)	LIMIT (dBuV/m)	MARGIN (dB)	ANTENNA HEIGHT (m)	TABLE ANGLE (Degree)	RAW VALUE (dBuV)	CORRECTION FACTOR (dB/m)
1	57.21	28.1 QP	40.0	-11.9	1.99 H	241	38.2	-10.1
2	70.82	25.9 QP	40.0	-14.1	1.99 H	152	37.9	-12.0
3	228.28	26.3 QP	46.0	-19.7	1.51 H	96	36.8	-10.5
4	261.32	37.2 QP	46.0	-8.8	1.51 H	127	46.0	-8.8
5	315.75	33.8 QP	46.0	-12.2	1.51 H	229	40.8	-7.0
6	591.78	28.9 QP	46.0	-17.1	1.99 H	22	30.3	-1.4

Remarks:

1. Emission Level(dBuV/m) = Raw Value(dBuV) + Correction Factor(dB/m).
2. Correction Factor(dB/m) = Antenna Factor(dB/m) + Cable Factor(dB) – Pre-Amplifier Factor(dB).
3. The other emission levels were very low against the limit of frequency range 30MHz ~ 1000MHz.
4. Margin value = Emission Level – Limit value.
5. The emission levels were very low against the limit of frequency range 9kHz ~ 30MHz: the amplitude of spurious emissions attenuated more than 20 dB below the permissible value to be report.

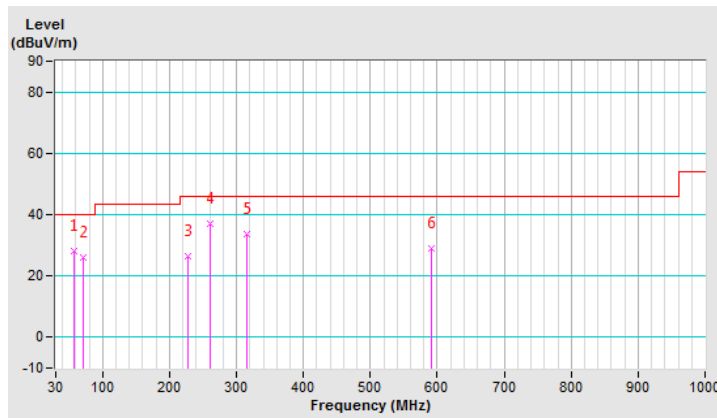

CHANNEL	TX Channel 0	DETECTOR FUNCTION	Quasi-Peak (QP)
FREQUENCY RANGE	9kHz ~ 1GHz		
TEST MODE	D		

ANTENNA POLARITY & TEST DISTANCE: VERTICAL AT 3 M								
NO.	FREQ. (MHz)	EMISSION LEVEL (dBuV/m)	LIMIT (dBuV/m)	MARGIN (dB)	ANTENNA HEIGHT (m)	TABLE ANGLE (Degree)	RAW VALUE (dBuV)	CORRECTION FACTOR (dB/m)
1	45.55	30.7 QP	40.0	-9.3	1.00 V	4	40.5	-9.8
2	230.22	28.9 QP	46.0	-17.1	1.00 V	156	39.3	-10.4
3	243.83	31.0 QP	46.0	-15.0	1.00 V	114	40.4	-9.4
4	274.93	34.8 QP	46.0	-11.2	1.50 V	164	42.9	-8.1
5	315.75	37.6 QP	46.0	-8.4	1.50 V	175	44.6	-7.0
6	445.99	27.7 QP	46.0	-18.3	1.00 V	21	32.1	-4.4

Remarks:

1. Emission Level(dBuV/m) = Raw Value(dBuV) + Correction Factor(dB/m).
2. Correction Factor(dB/m) = Antenna Factor(dB/m) + Cable Factor(dB) – Pre-Amplifier Factor(dB).
3. The other emission levels were very low against the limit of frequency range 30MHz ~ 1000MHz.
4. Margin value = Emission Level – Limit value.
5. The emission levels were very low against the limit of frequency range 9kHz ~ 30MHz: the amplitude of spurious emissions attenuated more than 20 dB below the permissible value to be report.

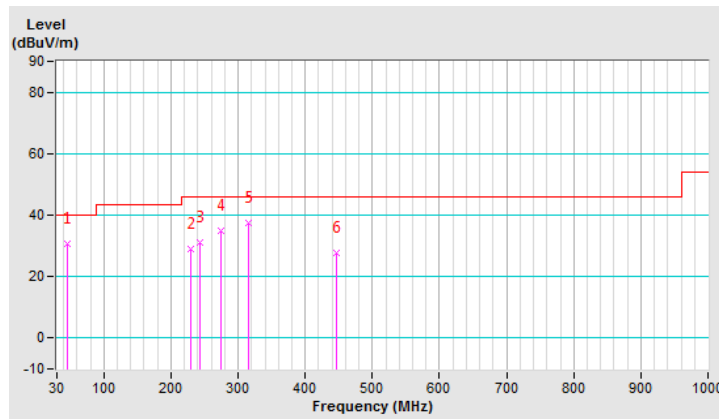

CHANNEL	TX Channel 25	DETECTOR FUNCTION	Quasi-Peak (QP)
FREQUENCY RANGE	9kHz ~ 1GHz		
TEST MODE	D		

ANTENNA POLARITY & TEST DISTANCE: HORIZONTAL AT 3 M								
NO.	FREQ. (MHz)	EMISSION LEVEL (dBuV/m)	LIMIT (dBuV/m)	MARGIN (dB)	ANTENNA HEIGHT (m)	TABLE ANGLE (Degree)	RAW VALUE (dBuV)	CORRECTION FACTOR (dB/m)
1	70.82	25.6 QP	40.0	-14.4	1.99 H	232	37.6	-12.0
2	164.13	21.6 QP	43.5	-21.9	1.49 H	241	30.7	-9.1
3	243.83	32.5 QP	46.0	-13.5	1.49 H	101	41.9	-9.4
4	274.93	31.6 QP	46.0	-14.4	1.49 H	243	39.7	-8.1
5	319.64	31.0 QP	46.0	-15.0	1.49 H	243	37.9	-6.9
6	479.04	25.4 QP	46.0	-20.6	1.49 H	289	29.4	-4.0

Remarks:

1. Emission Level(dBuV/m) = Raw Value(dBuV) + Correction Factor(dB/m).
2. Correction Factor(dB/m) = Antenna Factor(dB/m) + Cable Factor(dB) – Pre-Amplifier Factor(dB).
3. The other emission levels were very low against the limit of frequency range 30MHz ~ 1000MHz.
4. Margin value = Emission Level – Limit value.
5. The emission levels were very low against the limit of frequency range 9kHz ~ 30MHz: the amplitude of spurious emissions attenuated more than 20 dB below the permissible value to be report.

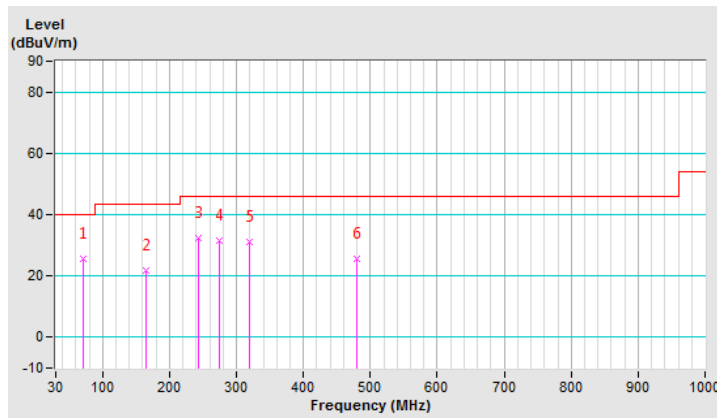

CHANNEL	TX Channel 25	DETECTOR FUNCTION	Quasi-Peak (QP)
FREQUENCY RANGE	9kHz ~ 1GHz		
TEST MODE	D		

ANTENNA POLARITY & TEST DISTANCE: VERTICAL AT 3 M								
NO.	FREQ. (MHz)	EMISSION LEVEL (dBuV/m)	LIMIT (dBuV/m)	MARGIN (dB)	ANTENNA HEIGHT (m)	TABLE ANGLE (Degree)	RAW VALUE (dBuV)	CORRECTION FACTOR (dB/m)
1	39.72	26.5 QP	40.0	-13.5	1.00 V	114	36.9	-10.4
2	64.99	23.3 QP	40.0	-16.7	1.00 V	4	34.2	-10.9
3	241.88	33.1 QP	46.0	-12.9	1.00 V	155	42.6	-9.5
4	286.59	31.2 QP	46.0	-14.8	1.49 V	144	38.8	-7.6
5	319.64	35.7 QP	46.0	-10.3	1.49 V	147	42.6	-6.9
6	387.68	28.5 QP	46.0	-17.5	1.49 V	80	34.3	-5.8

Remarks:

1. Emission Level(dBuV/m) = Raw Value(dBuV) + Correction Factor(dB/m).
2. Correction Factor(dB/m) = Antenna Factor(dB/m) + Cable Factor(dB) – Pre-Amplifier Factor(dB).
3. The other emission levels were very low against the limit of frequency range 30MHz ~ 1000MHz.
4. Margin value = Emission Level – Limit value.
5. The emission levels were very low against the limit of frequency range 9kHz ~ 30MHz: the amplitude of spurious emissions attenuated more than 20 dB below the permissible value to be report.

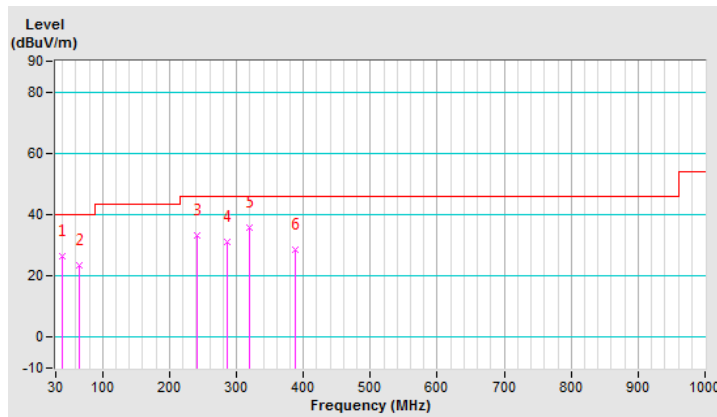

CHANNEL	TX Channel 49	DETECTOR FUNCTION	Quasi-Peak (QP)
FREQUENCY RANGE	9kHz ~ 1GHz		
TEST MODE	D		

ANTENNA POLARITY & TEST DISTANCE: HORIZONTAL AT 3 M								
NO.	FREQ. (MHz)	EMISSION LEVEL (dBuV/m)	LIMIT (dBuV/m)	MARGIN (dB)	ANTENNA HEIGHT (m)	TABLE ANGLE (Degree)	RAW VALUE (dBuV)	CORRECTION FACTOR (dB/m)
1	57.21	28.4 QP	40.0	-11.6	1.99 H	230	38.5	-10.1
2	140.80	21.4 QP	43.5	-22.1	1.99 H	129	31.0	-9.6
3	269.10	34.9 QP	46.0	-11.1	1.51 H	120	43.2	-8.3
4	306.03	36.0 QP	46.0	-10.0	1.51 H	246	43.2	-7.2
5	416.83	23.8 QP	46.0	-22.2	1.51 H	183	29.0	-5.2
6	541.24	27.9 QP	46.0	-18.1	1.51 H	265	30.9	-3.0

Remarks:

1. Emission Level(dBuV/m) = Raw Value(dBuV) + Correction Factor(dB/m).
2. Correction Factor(dB/m) = Antenna Factor(dB/m) + Cable Factor(dB) – Pre-Amplifier Factor(dB).
3. The other emission levels were very low against the limit of frequency range 30MHz ~ 1000MHz.
4. Margin value = Emission Level – Limit value.
5. The emission levels were very low against the limit of frequency range 9kHz ~ 30MHz: the amplitude of spurious emissions attenuated more than 20 dB below the permissible value to be report.

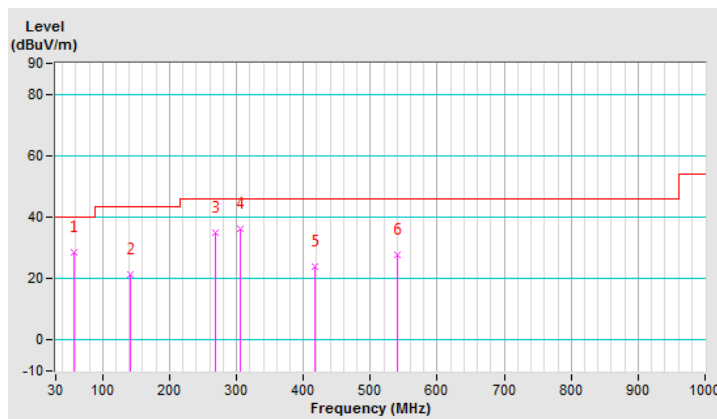

CHANNEL	TX Channel 49	DETECTOR FUNCTION	Quasi-Peak (QP)
FREQUENCY RANGE	9kHz ~ 1GHz		
TEST MODE	D		

ANTENNA POLARITY & TEST DISTANCE: VERTICAL AT 3 M								
NO.	FREQ. (MHz)	EMISSION LEVEL (dBuV/m)	LIMIT (dBuV/m)	MARGIN (dB)	ANTENNA HEIGHT (m)	TABLE ANGLE (Degree)	RAW VALUE (dBuV)	CORRECTION FACTOR (dB/m)
1	43.61	30.4 QP	40.0	-9.6	1.50 V	6	40.3	-9.9
2	239.94	33.4 QP	46.0	-12.6	1.00 V	145	43.0	-9.6
3	272.99	35.1 QP	46.0	-10.9	1.50 V	181	43.3	-8.2
4	315.75	38.6 QP	46.0	-7.4	1.50 V	143	45.6	-7.0
5	383.79	29.5 QP	46.0	-16.5	1.50 V	86	35.3	-5.8
6	455.71	27.3 QP	46.0	-18.7	1.00 V	217	31.7	-4.4

Remarks:

1. Emission Level(dBuV/m) = Raw Value(dBuV) + Correction Factor(dB/m).
2. Correction Factor(dB/m) = Antenna Factor(dB/m) + Cable Factor(dB) – Pre-Amplifier Factor(dB).
3. The other emission levels were very low against the limit of frequency range 30MHz ~ 1000MHz.
4. Margin value = Emission Level – Limit value.
5. The emission levels were very low against the limit of frequency range 9kHz ~ 30MHz: the amplitude of spurious emissions attenuated more than 20 dB below the permissible value to be report.

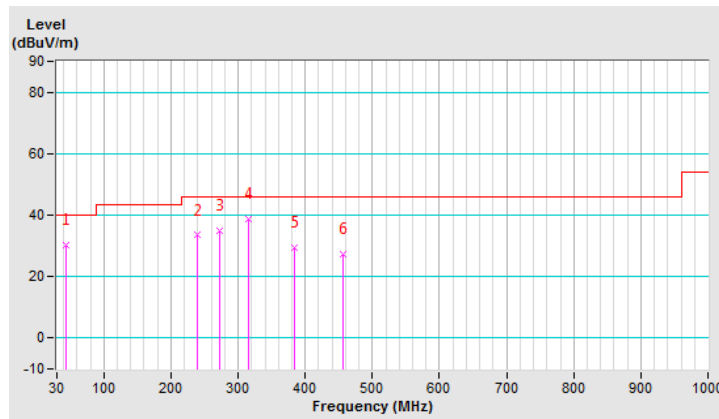

4.2 Conducted Emission Measurement

4.2.1 Limits of Conducted Emission Measurement

Frequency (MHz)	Conducted Limit (dBuV)	
	Quasi-peak	Average
0.15 - 0.5	66 - 56	56 - 46
0.50 - 5.0	56	46
5.0 - 30.0	60	50

Note: 1. The lower limit shall apply at the transition frequencies.

2. The limit decreases in line with the logarithm of the frequency in the range of 0.15 to 0.50MHz.

4.2.2 Test Instruments

Description & Manufacturer	Model No.	Serial No.	Cal. Date	Cal. Due
Test Receiver ROHDE & SCHWARZ	ESCI	100613	Dec. 10, 2018	Dec. 09, 2019
RF signal cable Woken	5D-FB	Cable-cond1-01	Sep. 05, 2018	Sep. 04, 2019
LISN ROHDE & SCHWARZ (EUT)	ENV216	101826	Feb. 21, 2019	Feb. 20, 2020
LISN ROHDE & SCHWARZ (Peripheral)	ESH3-Z5	100311	Aug. 19, 2018	Aug. 18, 2019
Software ADT	BV ADT_Cond_ V7.3.7.4	NA	NA	NA

Note: 1. The calibration interval of the above test instruments is 12 months and the calibrations are traceable to NML/ROC and NIST/USA.

2. The test was performed in HwaYa Shielded Room 1.

3. The VCCI Site Registration No. is C-12040.

4.2.3 Test Procedures

- The EUT was placed 0.4 meters from the conducting wall of the shielded room with EUT being connected to the power mains through a line impedance stabilization network (LISN). Other support units were connected to the power mains through another LISN. The two LISNs provide 50 ohm/ 50uH of coupling impedance for the measuring instrument.
- Both lines of the power mains connected to the EUT were checked for maximum conducted interference.
- The frequency range from 150kHz to 30MHz was searched. Emission levels under (Limit - 20dB) was not recorded.

Note: The resolution bandwidth and video bandwidth of test receiver is 9kHz for quasi-peak detection (QP) and average detection (AV) at frequency 0.15MHz-30MHz.

4.2.4 Deviation from Test Standard

No deviation.

4.2.5 Test Setup

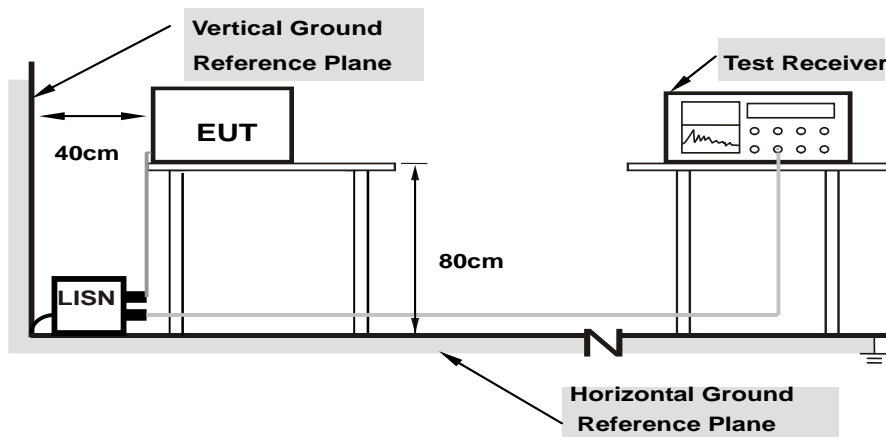

Note: 1.Support units were connected to second LISN.

For the actual test configuration, please refer to the attached file (Test Setup Photo).

4.2.6 EUT Operating Conditions

Same as 4.1.6.

4.2.7 Test Results

Phase	Line (L)	Detector Function	Quasi-Peak (QP) / Average (AV)
Channel	TX Channel 0	Test Mode	C

No	Freq. [MHz]	Corr. Factor (dB)	Reading Value [dB (uV)]		Emission Level [dB (uV)]		Limit [dB (uV)]		Margin (dB)	
			Q.P.	AV.	Q.P.	AV.	Q.P.	AV.	Q.P.	AV.
			1	0.16181	9.84	40.09	21.25	49.93	31.09	65.37
2	0.18853	9.85	23.36	3.18	33.21	13.03	64.10	54.10	-30.89	-41.07
3	0.23216	9.85	32.21	16.00	42.06	25.85	62.37	52.37	-20.31	-26.52
4	0.43924	9.88	21.69	5.31	31.57	15.19	57.08	47.08	-25.51	-31.89
5	3.21544	9.99	11.72	3.05	21.71	13.04	56.00	46.00	-34.29	-32.96
6	9.94442	10.16	12.59	6.71	22.75	16.87	60.00	50.00	-37.25	-33.13

Remarks:

1. Q.P. and AV. are abbreviations of quasi-peak and average individually.
2. The emission levels of other frequencies were very low against the limit.
3. Margin value = Emission level - Limit value
4. Correction factor = Insertion loss + Cable loss
5. Emission Level = Correction Factor + Reading Value.

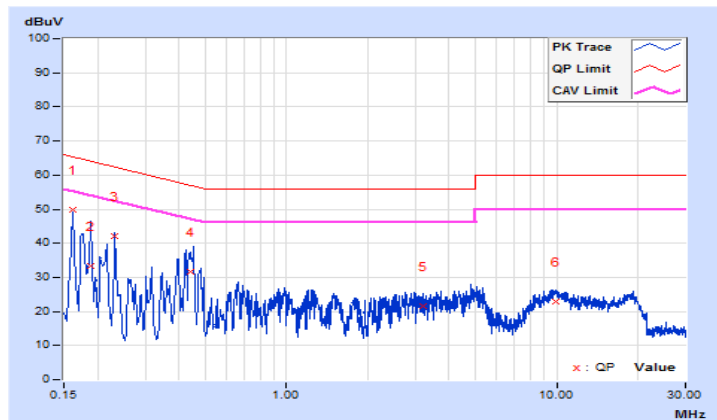

Phase	Neutral (N)	Detector Function	Quasi-Peak (QP) / Average (AV)
Channel	TX Channel 0	Test Mode	C

No	Freq. [MHz]	Corr. Factor (dB)	Reading Value [dB (uV)]		Emission Level [dB (uV)]		Limit [dB (uV)]		Margin (dB)	
			Q.P.	AV.	Q.P.	AV.	Q.P.	AV.	Q.P.	AV.
			1	0.16181	9.82	40.21	20.62	50.03	30.44	65.37
2	0.17283	9.83	43.03	28.87	52.86	38.70	64.82	54.82	-11.96	-16.12
3	0.20404	9.84	34.67	13.10	44.51	22.94	63.44	53.44	-18.93	-30.50
4	0.44742	9.87	28.49	17.09	38.36	26.96	56.92	46.92	-18.56	-19.96
5	1.67502	9.91	15.61	6.90	25.52	16.81	56.00	46.00	-30.48	-29.19
6	9.22120	10.14	11.80	6.23	21.94	16.37	60.00	50.00	-38.06	-33.63

Remarks:

1. Q.P. and AV. are abbreviations of quasi-peak and average individually.
2. The emission levels of other frequencies were very low against the limit.
3. Margin value = Emission level - Limit value
4. Correction factor = Insertion loss + Cable loss
5. Emission Level = Correction Factor + Reading Value.

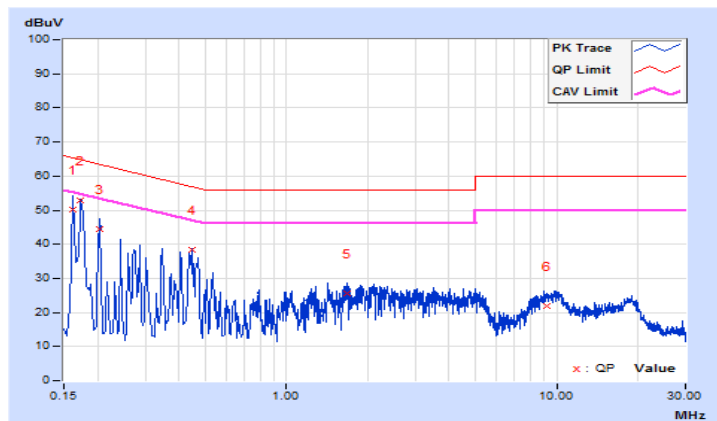

Phase	Line (L)	Detector Function	Quasi-Peak (QP) / Average (AV)
Channel	TX Channel 25	Test Mode	C

No	Freq. [MHz]	Corr. Factor (dB)	Reading Value [dB (uV)]		Emission Level [dB (uV)]		Limit [dB (uV)]		Margin (dB)	
			Q.P.	AV.	Q.P.	AV.	Q.P.	AV.	Q.P.	AV.
			1	0.17698	9.85	42.34	27.03	52.19	36.88	64.63
2	0.20511	9.85	36.71	23.38	46.56	33.23	63.40	53.40	-16.84	-20.17
3	0.31813	9.87	26.74	15.58	36.61	25.45	59.76	49.76	-23.15	-24.31
4	0.41233	9.88	28.51	17.23	38.39	27.11	57.60	47.60	-19.21	-20.49
5	5.12743	10.05	12.54	4.19	22.59	14.24	60.00	50.00	-37.41	-35.76
6	10.24171	10.16	12.28	6.31	22.44	16.47	60.00	50.00	-37.56	-33.53

Remarks:

1. Q.P. and AV. are abbreviations of quasi-peak and average individually.
2. The emission levels of other frequencies were very low against the limit.
3. Margin value = Emission level - Limit value
4. Correction factor = Insertion loss + Cable loss
5. Emission Level = Correction Factor + Reading Value.

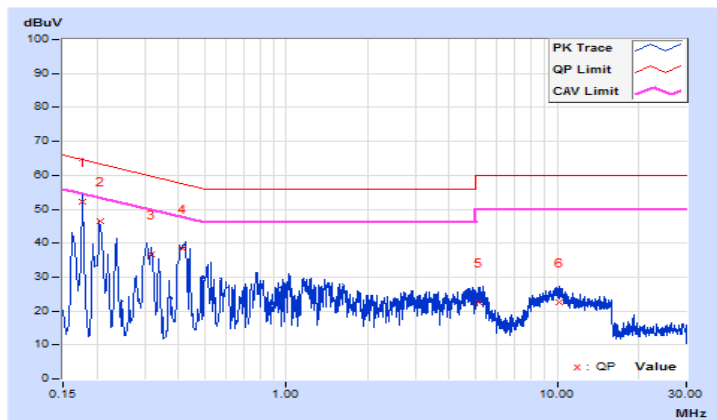

Phase	Neutral (N)	Detector Function	Quasi-Peak (QP) / Average (AV)
Channel	TX Channel 25	Test Mode	C

No	Freq. [MHz]	Corr. Factor (dB)	Reading Value [dB (uV)]		Emission Level [dB (uV)]		Limit [dB (uV)]		Margin (dB)	
			Q.P.	AV.	Q.P.	AV.	Q.P.	AV.	Q.P.	AV.
			1	0.17374	9.83	42.84	28.44	52.67	38.27	64.78
2	0.24384	9.85	30.78	15.62	40.63	25.47	61.96	51.96	-21.33	-26.49
3	0.43350	9.87	29.50	21.32	39.37	31.19	57.19	47.19	-17.82	-16.00
4	2.01898	9.93	14.63	5.49	24.56	15.42	56.00	46.00	-31.44	-30.58
5	4.99934	10.03	12.24	4.32	22.27	14.35	56.00	46.00	-33.73	-31.65
6	9.84680	10.16	11.98	6.74	22.14	16.90	60.00	50.00	-37.86	-33.10

Remarks:

1. Q.P. and AV. are abbreviations of quasi-peak and average individually.
2. The emission levels of other frequencies were very low against the limit.
3. Margin value = Emission level - Limit value
4. Correction factor = Insertion loss + Cable loss
5. Emission Level = Correction Factor + Reading Value.

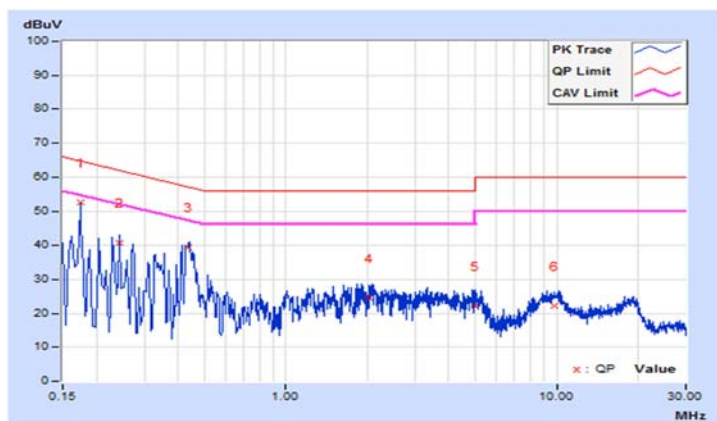

Phase	Line (L)	Detector Function	Quasi-Peak (QP) / Average (AV)
Channel	TX Channel 49	Test Mode	C

No	Freq. [MHz]	Corr. Factor (dB)	Reading Value [dB (uV)]		Emission Level [dB (uV)]		Limit [dB (uV)]		Margin (dB)	
			Q.P.	AV.	Q.P.	AV.	Q.P.	AV.	Q.P.	AV.
			1	0.16922	9.84	43.73	30.43	53.57	40.27	65.00
2	0.21282	9.85	35.62	19.80	45.47	29.65	63.09	53.09	-17.62	-23.44
3	0.42334	9.88	28.57	24.86	38.45	34.74	57.38	47.38	-18.93	-12.64
4	1.42466	9.93	17.29	9.35	27.22	19.28	56.00	46.00	-28.78	-26.72
5	5.03750	10.04	12.65	4.40	22.69	14.44	60.00	50.00	-37.31	-35.56
6	10.33164	10.16	12.17	6.27	22.33	16.43	60.00	50.00	-37.67	-33.57

Remarks:

1. Q.P. and AV. are abbreviations of quasi-peak and average individually.
2. The emission levels of other frequencies were very low against the limit.
3. Margin value = Emission level - Limit value
4. Correction factor = Insertion loss + Cable loss
5. Emission Level = Correction Factor + Reading Value.

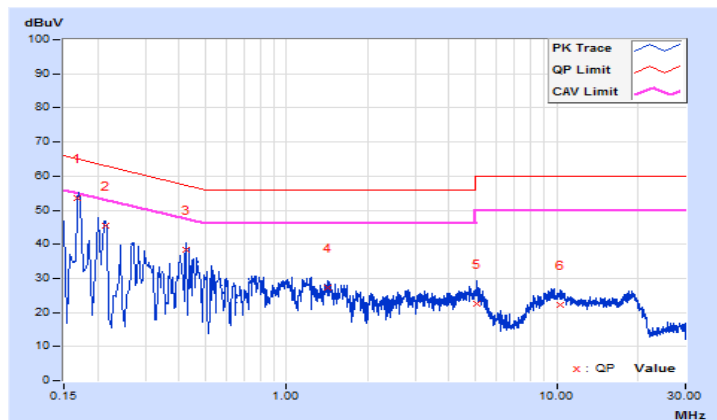

Phase	Neutral (N)	Detector Function	Quasi-Peak (QP) / Average (AV)
Channel	TX Channel 49	Test Mode	C

No	Freq. [MHz]	Corr. Factor (dB)	Reading Value [dB (uV)]		Emission Level [dB (uV)]		Limit [dB (uV)]		Margin (dB)	
			Q.P.	AV.	Q.P.	AV.	Q.P.	AV.	Q.P.	AV.
			1	0.16922	9.83	43.71	30.00	53.54	39.83	65.00
2	0.21282	9.84	35.58	18.66	45.42	28.50	63.09	53.09	-17.67	-24.59
3	0.45107	9.87	28.05	16.65	37.92	26.52	56.86	46.86	-18.94	-20.34
4	2.05417	9.93	15.54	7.05	25.47	16.98	56.00	46.00	-30.53	-29.02
5	3.73938	9.99	12.71	4.81	22.70	14.80	56.00	46.00	-33.30	-31.20
6	9.51836	10.15	11.91	6.38	22.06	16.53	60.00	50.00	-37.94	-33.47

Remarks:

1. Q.P. and AV. are abbreviations of quasi-peak and average individually.
2. The emission levels of other frequencies were very low against the limit.
3. Margin value = Emission level - Limit value
4. Correction factor = Insertion loss + Cable loss
5. Emission Level = Correction Factor + Reading Value.

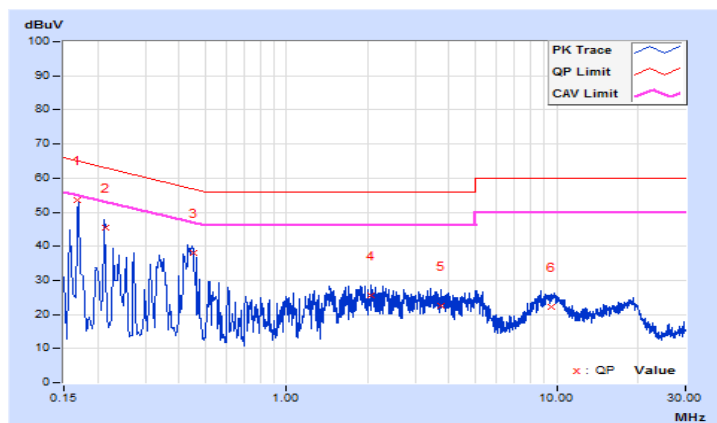

Phase	Line (L)	Detector Function	Quasi-Peak (QP) / Average (AV)
Channel	TX Channel 0	Test Mode	D

No	Freq. [MHz]	Corr. Factor (dB)	Reading Value [dB (uV)]		Emission Level [dB (uV)]		Limit [dB (uV)]		Margin (dB)	
			Q.P.	AV.	Q.P.	AV.	Q.P.	AV.	Q.P.	AV.
			1	0.17346	9.84	43.02	29.46	52.86	39.30	64.79
2	0.24666	9.86	30.34	14.58	40.20	24.44	61.87	51.87	-21.67	-27.43
3	0.42782	9.88	26.86	17.39	36.74	27.27	57.29	47.29	-20.55	-20.02
4	0.76789	9.90	19.88	10.26	29.78	20.16	56.00	46.00	-26.22	-25.84
5	1.21352	9.93	18.70	10.46	28.63	20.39	56.00	46.00	-27.37	-25.61
6	5.11179	10.05	13.32	5.08	23.37	15.13	60.00	50.00	-36.63	-34.87

Remarks:

1. Q.P. and AV. are abbreviations of quasi-peak and average individually.
2. The emission levels of other frequencies were very low against the limit.
3. Margin value = Emission level - Limit value
4. Correction factor = Insertion loss + Cable loss
5. Emission Level = Correction Factor + Reading Value.

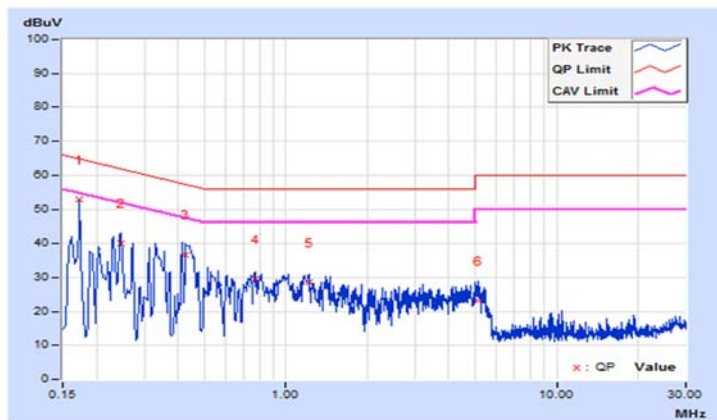

Phase	Neutral (N)	Detector Function	Quasi-Peak (QP) / Average (AV)
Channel	TX Channel 0	Test Mode	D

No	Freq. [MHz]	Corr. Factor (dB)	Reading Value [dB (uV)]		Emission Level [dB (uV)]		Limit [dB (uV)]		Margin (dB)	
			Q.P.	AV.	Q.P.	AV.	Q.P.	AV.	Q.P.	AV.
			1	0.17346	9.83	42.97	28.99	52.80	38.82	64.79
2	0.20084	9.84	30.77	7.41	40.61	17.25	63.58	53.58	-22.97	-36.33
3	0.42782	9.87	30.23	22.11	40.10	31.98	57.29	47.29	-17.19	-15.31
4	0.52544	9.87	21.12	11.44	30.99	21.31	56.00	46.00	-25.01	-24.69
5	1.92905	9.93	16.66	7.45	26.59	17.38	56.00	46.00	-29.41	-28.62
6	10.17133	10.16	11.49	6.09	21.65	16.25	60.00	50.00	-38.35	-33.75

Remarks:

1. Q.P. and AV. are abbreviations of quasi-peak and average individually.
2. The emission levels of other frequencies were very low against the limit.
3. Margin value = Emission level - Limit value
4. Correction factor = Insertion loss + Cable loss
5. Emission Level = Correction Factor + Reading Value.

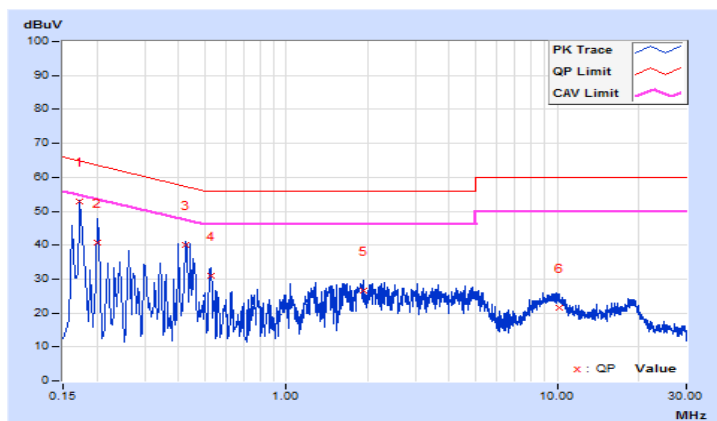

Phase	Line (L)	Detector Function	Quasi-Peak (QP) / Average (AV)
Channel	TX Channel 25	Test Mode	D

No	Freq. [MHz]	Corr. Factor (dB)	Reading Value [dB (uV)]		Emission Level [dB (uV)]		Limit [dB (uV)]		Margin (dB)	
			Q.P.	AV.	Q.P.	AV.	Q.P.	AV.	Q.P.	AV.
			1	0.16564	9.84	44.22	28.99	54.06	38.83	65.18
2	0.20511	9.85	36.63	23.35	46.48	33.20	63.40	53.40	-16.92	-20.20
3	0.40415	9.88	27.97	17.02	37.85	26.90	57.77	47.77	-19.92	-20.87
4	0.75605	9.90	12.96	3.34	22.86	13.24	56.00	46.00	-33.14	-32.76
5	5.01013	10.04	13.52	5.33	23.56	15.37	60.00	50.00	-36.44	-34.63
6	9.73341	10.15	12.06	6.12	22.21	16.27	60.00	50.00	-37.79	-33.73

Remarks:

1. Q.P. and AV. are abbreviations of quasi-peak and average individually.
2. The emission levels of other frequencies were very low against the limit.
3. Margin value = Emission level - Limit value
4. Correction factor = Insertion loss + Cable loss
5. Emission Level = Correction Factor + Reading Value.

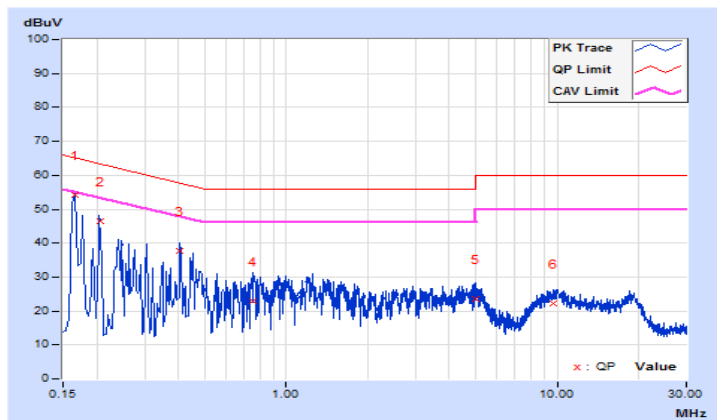

Phase	Neutral (N)	Detector Function	Quasi-Peak (QP) / Average (AV)
Channel	TX Channel 25	Test Mode	D

No	Freq. [MHz]	Corr. Factor (dB)	Reading Value [dB (uV)]		Emission Level [dB (uV)]		Limit [dB (uV)]		Margin (dB)	
			Q.P.	AV.	Q.P.	AV.	Q.P.	AV.	Q.P.	AV.
			1	0.16569	9.83	44.25	28.63	54.08	38.46	65.17
2	0.23216	9.84	32.23	16.97	42.07	26.81	62.37	52.37	-20.30	-25.56
3	0.43008	9.87	29.97	21.92	39.84	31.79	57.25	47.25	-17.41	-15.46
4	1.89386	9.92	17.03	9.06	26.95	18.98	56.00	46.00	-29.05	-27.02
5	2.81271	9.96	13.79	5.16	23.75	15.12	56.00	46.00	-32.25	-30.88
6	19.33246	10.30	8.82	4.07	19.12	14.37	60.00	50.00	-40.88	-35.63

Remarks:

1. Q.P. and AV. are abbreviations of quasi-peak and average individually.
2. The emission levels of other frequencies were very low against the limit.
3. Margin value = Emission level - Limit value
4. Correction factor = Insertion loss + Cable loss
5. Emission Level = Correction Factor + Reading Value.

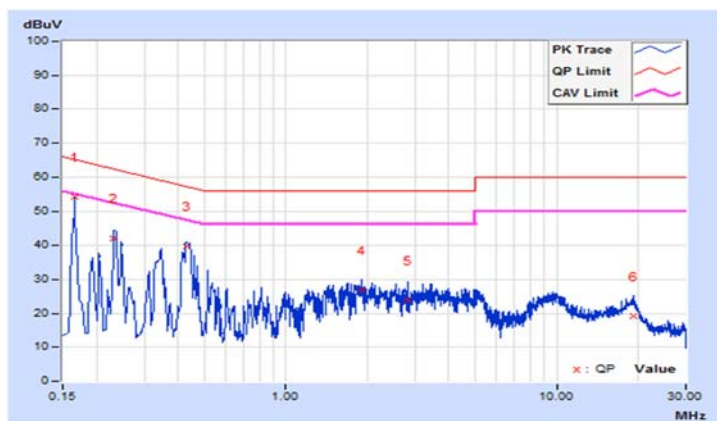

Phase	Line (L)	Detector Function	Quasi-Peak (QP) / Average (AV)
Channel	TX Channel 49	Test Mode	D

No	Freq. [MHz]	Corr. Factor (dB)	Reading Value [dB (uV)]		Emission Level [dB (uV)]		Limit [dB (uV)]		Margin (dB)	
			Q.P.	AV.	Q.P.	AV.	Q.P.	AV.	Q.P.	AV.
			1	0.16955	9.84	43.58	30.49	53.42	40.33	64.98
2	0.21256	9.85	35.64	19.43	45.49	29.28	63.10	53.10	-17.61	-23.82
3	0.41979	9.88	29.74	18.51	39.62	28.39	57.45	47.45	-17.83	-19.06
4	1.17833	9.93	18.70	10.30	28.63	20.23	56.00	46.00	-27.37	-25.77
5	4.76380	10.04	13.32	5.63	23.36	15.67	56.00	46.00	-32.64	-30.33
6	10.22607	10.16	11.77	6.01	21.93	16.17	60.00	50.00	-38.07	-33.83

Remarks:

1. Q.P. and AV. are abbreviations of quasi-peak and average individually.
2. The emission levels of other frequencies were very low against the limit.
3. Margin value = Emission level - Limit value
4. Correction factor = Insertion loss + Cable loss
5. Emission Level = Correction Factor + Reading Value.

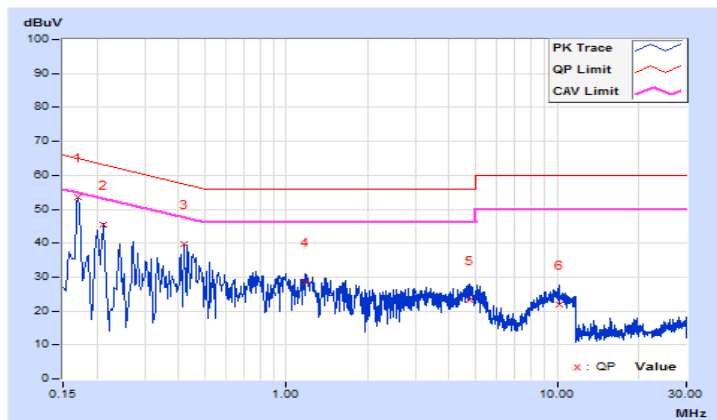

Phase	Neutral (N)	Detector Function	Quasi-Peak (QP) / Average (AV)
Channel	TX Channel 49	Test Mode	D

No	Freq. [MHz]	Corr. Factor (dB)	Reading Value [dB (uV)]		Emission Level [dB (uV)]		Limit [dB (uV)]		Margin (dB)	
			Q.P.	AV.	Q.P.	AV.	Q.P.	AV.	Q.P.	AV.
			1	0.16173	9.82	41.08	22.14	50.90	31.96	65.37
2	0.17283	9.83	42.96	29.11	52.79	38.94	64.82	54.82	-12.03	-15.88
3	0.20474	9.84	36.65	22.20	46.49	32.04	63.42	53.42	-16.93	-21.38
4	0.42370	9.87	30.00	20.27	39.87	30.14	57.38	47.38	-17.51	-17.24
5	1.70620	9.92	16.60	7.06	26.52	16.98	56.00	46.00	-29.48	-29.02
6	9.41279	10.14	11.60	6.07	21.74	16.21	60.00	50.00	-38.26	-33.79

Remarks:

1. Q.P. and AV. are abbreviations of quasi-peak and average individually.
2. The emission levels of other frequencies were very low against the limit.
3. Margin value = Emission level - Limit value
4. Correction factor = Insertion loss + Cable loss
5. Emission Level = Correction Factor + Reading Value.

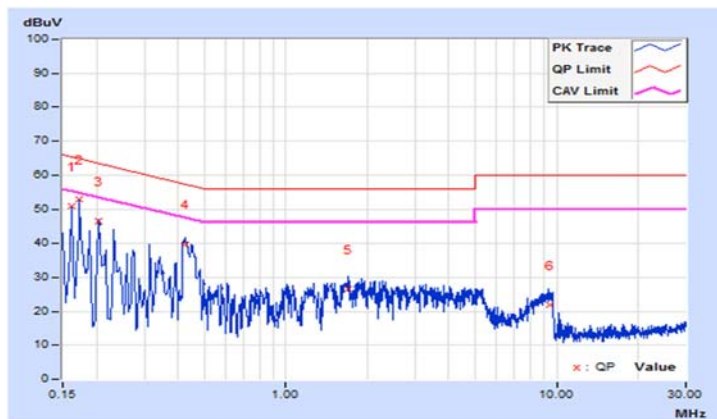

4.3 Number of Hopping Frequency Used

4.3.1 Limits of Hopping Frequency Used Measurement

The 20 dB bandwidth of the hopping channel is less than 250 kHz, at least 50 channels frequencies, and should be equally spaced.

4.3.2 Test Setup



4.3.3 Test Instruments

Refer to section 4.1.2 to get information of above instrument.

4.3.4 Test Procedure

- Check the calibration of the measuring instrument (SA) using either an internal calibrator or a known signal from an external generator.
- Turn on the EUT and connect its antenna terminal to measurement via a low loss cable. Then set it to any one measured frequency within its operating range and make sure the instrument is operated in its linear range.
- Set the SA on MaxHold Mode, and then keep the EUT in hopping mode. Record all the signals from each channel until each one has been recorded.
- Set the SA on View mode and then plot the result on SA screen.
- Repeat above procedures until all frequencies measured were complete.

4.3.5 Deviation from Test Standard

No deviation.

4.3.6 Test Results

There are 50 hopping frequencies in the hopping mode. On the plots, it shows that the hopping frequencies are equally spaced.

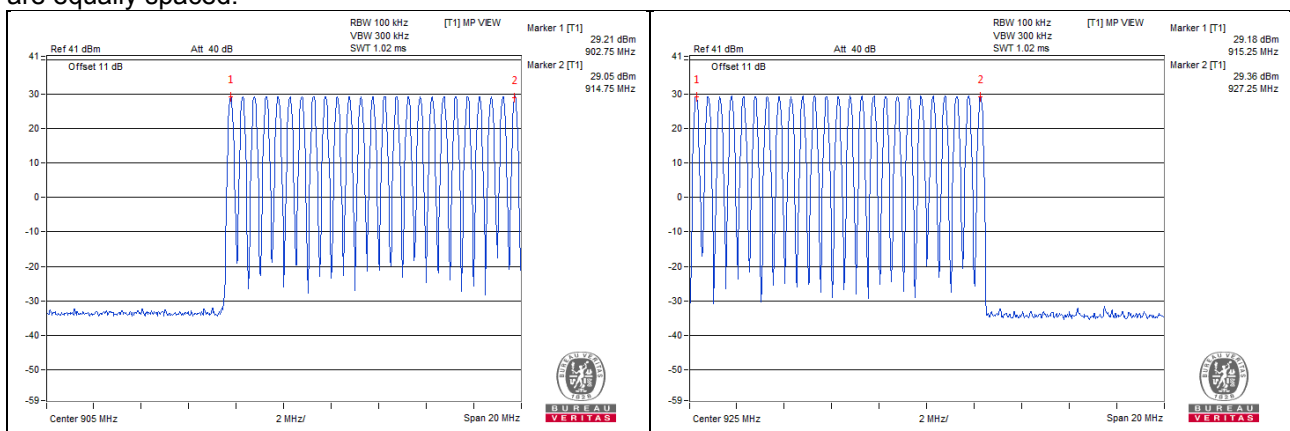

4.4 Dwell Time on Each Channel

4.4.1 Limits of Dwell Time on Each Channel Measurement

The average time of occupancy on any frequency shall not be greater than 0.4 seconds within a 20 second period. (If the 20 dB bandwidth of the hopping channel is less than 250 kHz)

4.4.2 Test Setup

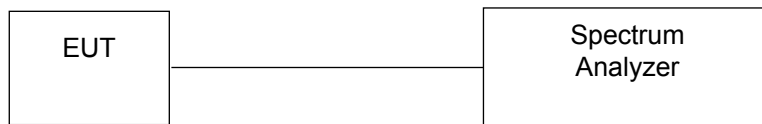

4.4.3 Test Instruments

Refer to section 4.1.2 to get information of above instrument.

4.4.4 Test Procedures

- a. Check the calibration of the measuring instrument (SA) using either an internal calibrator or a known signal from an external generator.
- b. Turn on the EUT and connect its antenna terminal to measurement via a low loss cable. Then set it to any one measured frequency within its operating range and make sure the instrument is operated in its linear range.
- c. Adjust the center frequency of SA on any frequency be measured and set SA to zero span mode. And then, set RBW and VBW of spectrum analyzer to proper value.
- d. Measure the time duration of one transmission on the measured frequency. And then plot the result with time difference of this time duration.
- e. Repeat above procedures until all different time-slot modes have been completed.

4.4.5 Deviation from Test Standard

No deviation.

4.4.6 Test Results

Number of transmission in a period	Length of transmission time (msec)	Result (msec)	Limit (msec)
2 (times / 20 sec) = 2 times	192.754	385.508	400

Note: Test plots of the transmitting time slot are shown as below.

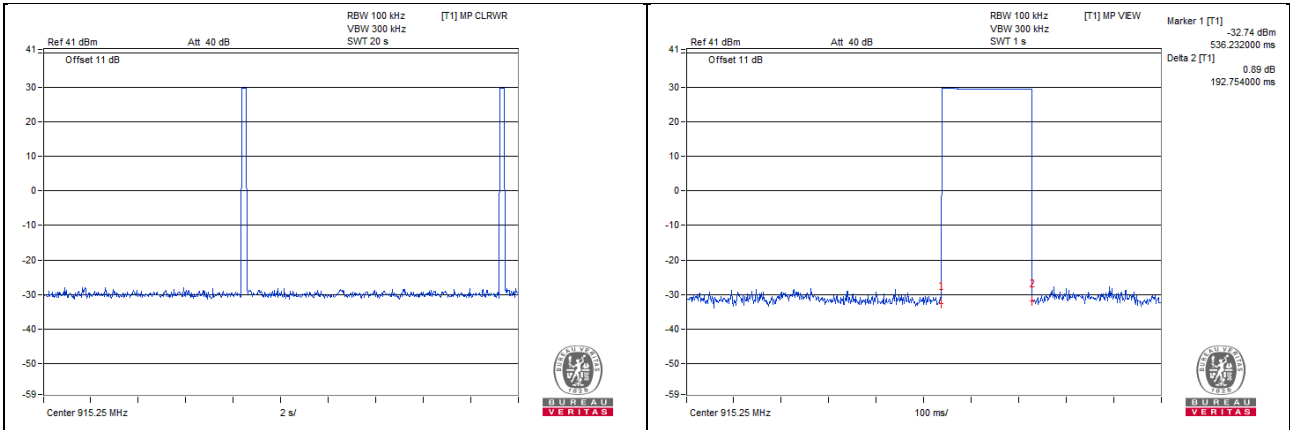

4.5 Channel Bandwidth

4.5.1 Limits of Channel Bandwidth Measurement

For frequency hopping systems operating in the 902–928 MHz band: if the 20 dB bandwidth of the hopping channel is less than 250 kHz, the system shall use at least 50 hopping frequencies and the average time of occupancy on any frequency shall not be greater than 0.4 seconds within a 20 second period.

4.5.2 Test Setup

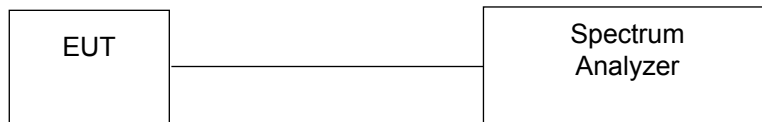

4.5.3 Test Instruments

Refer to section 4.1.2 to get information of above instrument.

4.5.4 Test Procedure

- a. Check the calibration of the measuring instrument using either an internal calibrator or a known signal from an external generator.
- b. Turn on the EUT and connect it to measurement instrument. Then set it to any one convenient frequency within its operating range. Set a reference level on the measuring instrument equal to the highest peak value.
- c. Measure the frequency difference of two frequencies that were attenuated 20dB from the reference level. Record the frequency difference as the emission bandwidth.
- d. Repeat above procedures until all frequencies measured were complete.

4.5.5 Deviation from Test Standard

No deviation.

4.5.6 EUT Operating Condition

The software provided by client enabled the EUT to transmit and receive data at lowest, middle and highest channel frequencies individually.

4.5.7 Test Results

Channel	Frequency (MHz)	20dB Bandwidth (MHz)
0	902.75	0.04512
25	915.25	0.08383
49	927.25	0.08825

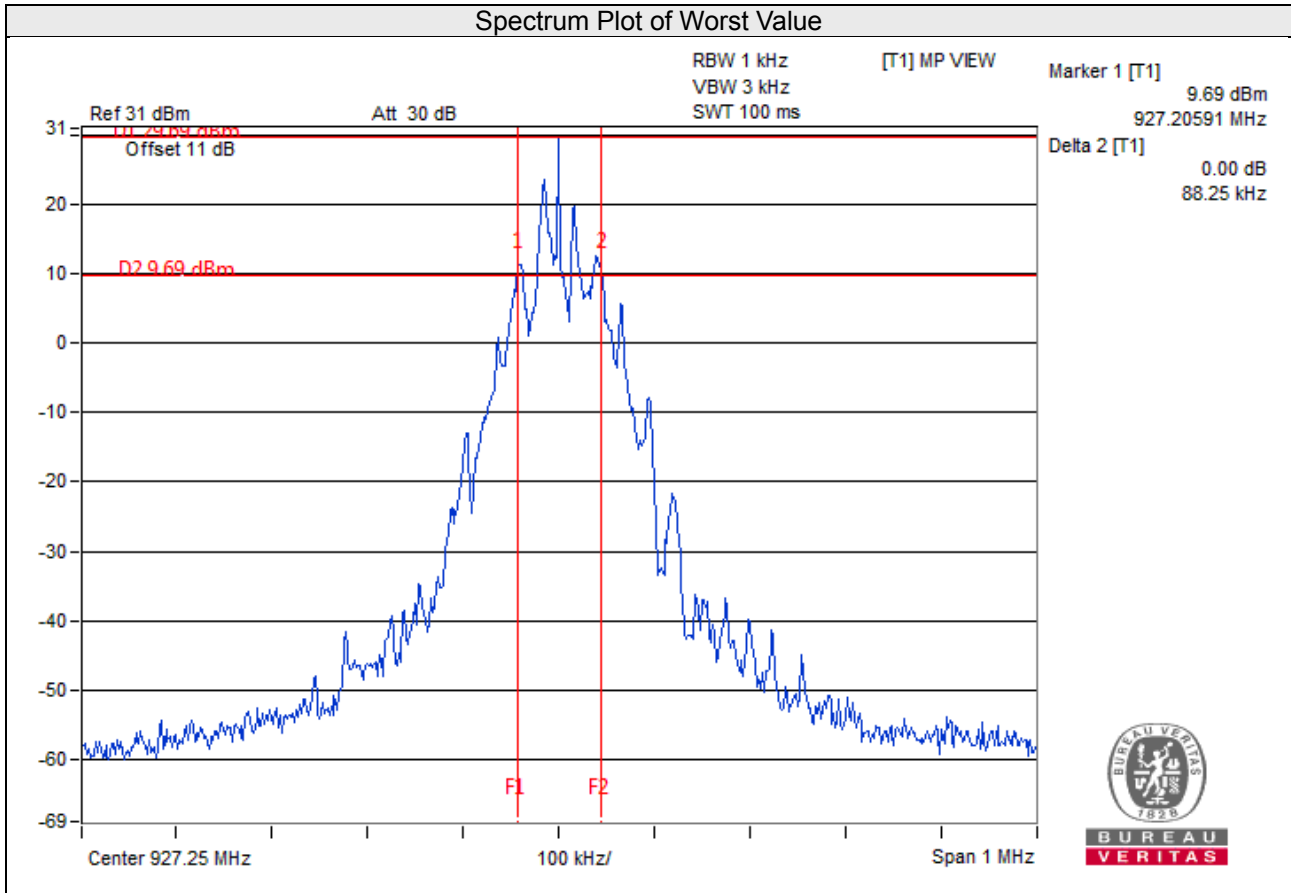

4.6 Hopping Channel Separation

4.6.1 Limits of Hopping Channel Separation Measurement

At least 25kHz or 20dB hopping channel bandwidth (whichever is greater).

4.6.2 Test Setup

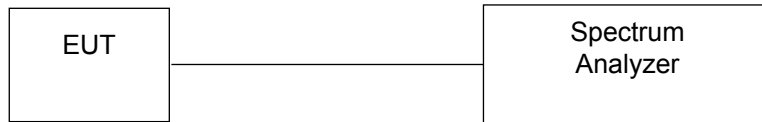

4.6.3 Test Instruments

Refer to section 4.1.2 to get information of above instrument.

4.6.4 Test Procedure

Measurement Procedure REF

- Check the calibration of the measuring instrument using either an internal calibrator or a known signal from an external generator.
- Turn on the EUT and connect it to measurement instrument. Then set it to any one convenient frequency within its operating range.
- By using the MaxHold function record the separation of two adjacent channels.
- Measure the frequency difference of these two adjacent channels by SA MARK function. And then plot the result on SA screen.
- Repeat above procedures until all frequencies measured were complete.

4.6.5 Deviation from Test Standard

No deviation.

4.6.6 Test Results

Channel	Frequency (MHz)	Adjacent Channel Separation (MHz)	Minimum Limit (MHz)	Pass / Fail
0	902.75	0.501	0.04512	Pass
25	915.25	0.497	0.08383	Pass
49	927.25	0.500	0.08825	Pass

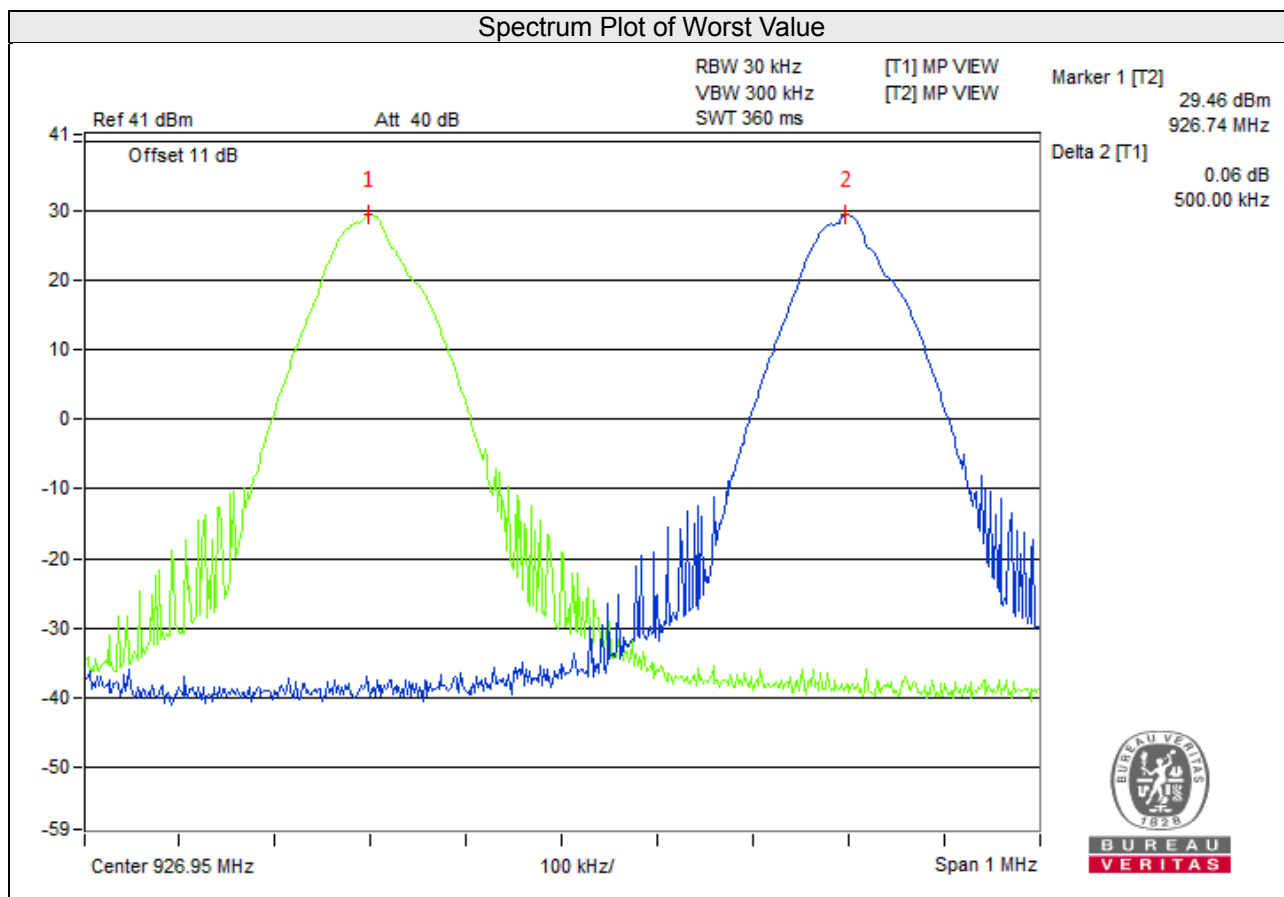

4.7 Maximum Output Power

4.7.1 Limits of Maximum Output Power Measurement

For frequency hopping systems operating in the 902-928 MHz band: 1 watt for systems employing at least 50 hopping channels.

4.7.2 Test Setup

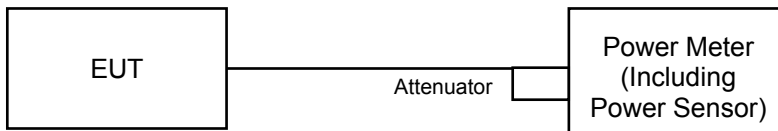

4.7.3 Test Instruments

Refer to section 4.1.2 to get information of above instrument.

4.7.4 Test Procedure

For Peak Power

A peak power sensor was used on the output port of the EUT. A power meter was used to read the response of the peak power sensor. Record the power level.

For Average Power

Average power sensor was used to perform output power measurement, trigger and gating function of wide band power meter is enabled to measure max output power of TX on burst. Duty factor is not added to measured value.

4.7.5 Deviation from Test Standard

No deviation.

4.7.6 EUT Operating Condition

The software provided by client enabled the EUT to transmit and receive data at lowest, middle and highest channel frequencies individually.

4.7.7 Test Results

For Peak Power

Channel	Frequency (MHz)	Peak Power (mW)	Peak Power (dBm)	Power Limit (mW)	Pass / Fail
0	902.75	891.251	29.50	1000	Pass
25	915.25	879.023	29.44	1000	Pass
49	927.25	897.429	29.53	1000	Pass

For Average Power

Channel	Frequency (MHz)	Average Power (mW)	Average Power (dBm)
0	902.75	864.968	29.37
25	915.25	864.968	29.37
49	927.25	887.156	29.48

4.8 Conducted Out of Band Emission Measurement

4.8.1 Limits Of Conducted Out Of Band Emission Measurement

Below -20dB of the highest emission level of operating band (in 100kHz RBW).

4.8.2 Test Instruments

Refer to section 4.1.2 to get information of above instrument.

4.8.3 Test Procedure

The transmitter output was connected to the spectrum analyzer via a low lose cable. Set both RBW and VBW of spectrum analyzer to 100 kHz and 300 kHz with suitable frequency span including 100 MHz bandwidth from band edge. The band edges was measured and recorded.

4.8.4 Deviation from Test Standard

No deviation.

4.8.5 EUT Operating Condition

The software provided by client enabled the EUT to transmit and receive data at lowest, middle and highest channel frequencies individually.

4.8.6 Test Results

The spectrum plots are attached on the following images. D1 line indicates the highest level, D2 line indicates the 20dB offset below D1. It shows compliance with the requirement.

Hopping disabled Low Channel

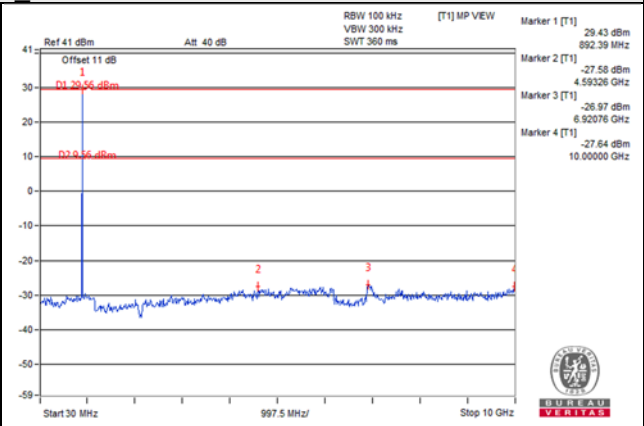
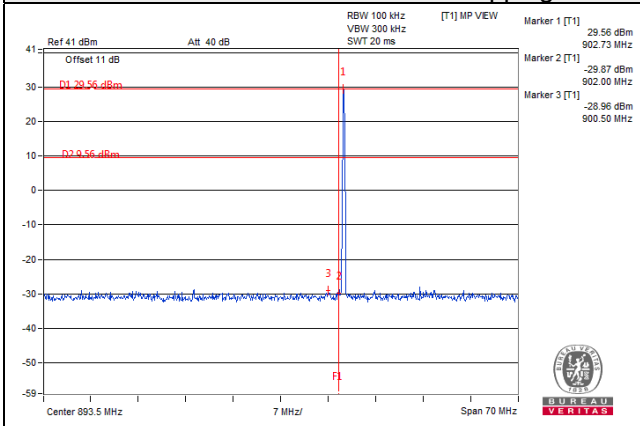

Hopping disabled High Channel

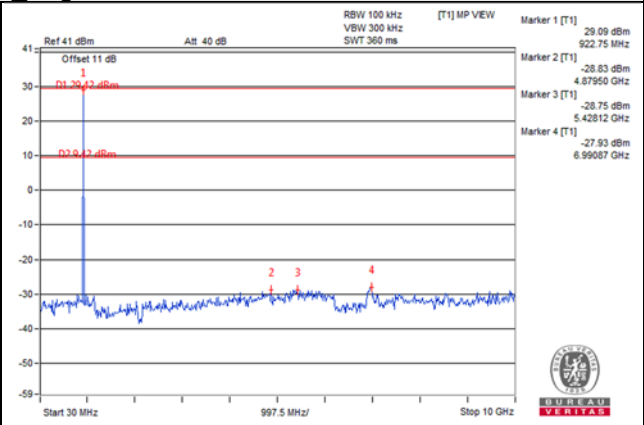
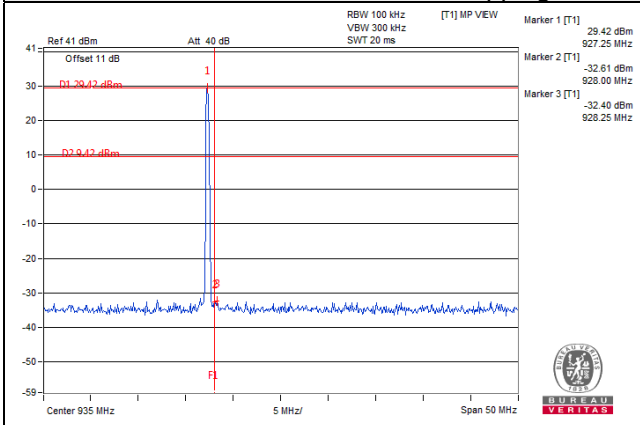

Hopping enabled

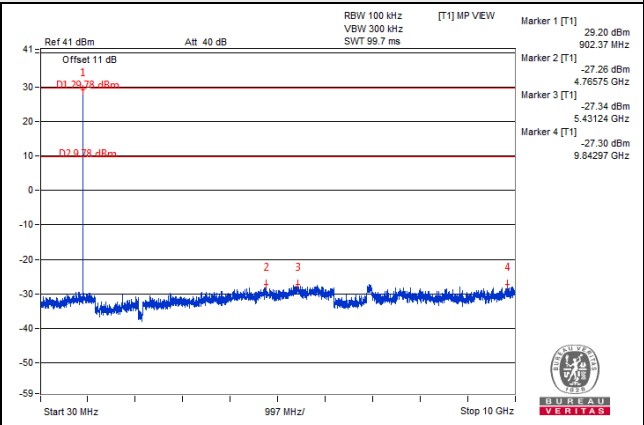
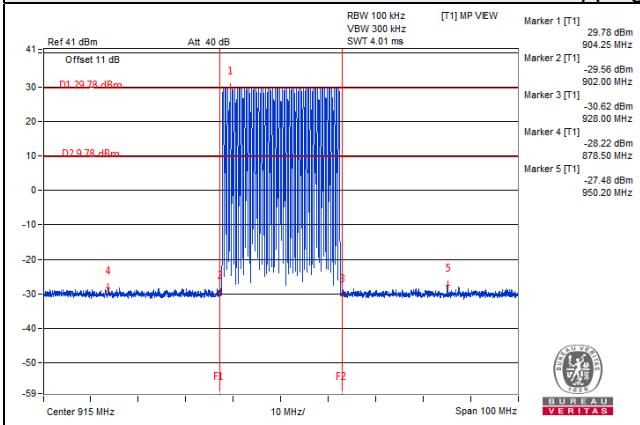

Note: Emissions in non-restricted frequency bands by radiated measurement comply with test requirement.

5 Pictures of Test Arrangements

Please refer to the attached file (Test Setup Photo).

Appendix – Information of the Testing Laboratories

We, Bureau Veritas Consumer Products Services (H.K.) Ltd., Taoyuan Branch, were founded in 1988 to provide our best service in EMC, Radio, Telecom and Safety consultation. Our laboratories are FCC recognized accredited test firms and accredited and approved according to ISO/IEC 17025.

If you have any comments, please feel free to contact us at the following:

Lin Kou EMC/RF Lab

Tel: 886-2-26052180

Fax: 886-2-26051924

Hsin Chu EMC/RF/Telecom Lab

Tel: 886-3-6668565

Fax: 886-3-6668323

Hwa Ya EMC/RF/Safety Lab

Tel: 886-3-3183232

Fax: 886-3-3270892

Email: service.adt@tw.bureauveritas.com

Web Site: www.bureauveritas-adt.com

The address and road map of all our labs can be found in our web site also.

--- END ---