

TEST REPORT

FCC ID: S5V-SOPHPADX11

Product: Tablet PC

Model No.: SophPad X11

**Additional Model No.: SophPad X21, SophPad X22, SophPad Y11,
SophPad Y21, MemoPad A1, MemoPad A2, MemoPad A3, MemoPad C1,
MemoPad C2, MemoPad C3**

Trade Mark: ARKNIKKO

Report No.: TCT200918E010

Issued Date: Oct. 13, 2020

Issued for:

PROEXPRESS DISTRIBUTOR LLC

7668 standish place, STE B, Rockville, Maryland 20855, United States

Issued By:

Shenzhen Tongce Testing Lab.

**1B/F., Building 1, Yibaolai Industrial Park, Qiaotou, Fuyong, Baoan District,
Shenzhen, Guangdong, China**

TEL: +86-755-27673339

FAX: +86-755-27673332

Note: This report shall not be reproduced except in full, without the written approval of Shenzhen Tongce Testing Lab.

This document may be altered or revised by Shenzhen Tongce Testing Lab. personnel only, and shall be noted in the revision section of the document. The test results in the report only apply to the tested sample.

TABLE OF CONTENTS

1. Test Certification	3
2. Test Result Summary	4
3. EUT Description.....	5
4. General Information.....	7
4.1. Test environment and mode.....	7
4.2. Description of Support Units.....	8
5. Facilities and Accreditations	9
5.1. Facilities	9
5.2. Location	9
5.3. Measurement Uncertainty.....	9
6. Test Results and Measurement Data	10
6.1. Antenna requirement	10
6.2. Conducted Emission.....	11
6.3. Conducted Output Power	15
6.4. 20dB Occupy Bandwidth	20
6.5. Carrier Frequencies Separation	25
6.6. Hopping Channel Number	30
6.7. Dwell Time.....	33
6.8. Pseudorandom Frequency Hopping Sequence	38
6.9. Conducted Band Edge Measurement.....	39
6.10. Conducted Spurious Emission Measurement.....	43
6.11. Radiated Spurious Emission Measurement	47

Appendix A: Photographs of Test Setup

Appendix B: Photographs of EUT

1. Test Certification

Product:	Tablet PC
Model No.:	SophPad X11
Additional Model:	SophPad X21, SophPad X22, SophPad Y11, SophPad Y21, MemoPad A1, MemoPad A2, MemoPad A3, MemoPad C1, MemoPad C2, MemoPad C3
Trade Mark:	ARKNIKKO
Applicant:	PROEXPRESS DISTRIBUTOR LLC
Address:	7668 standish place, STE B, Rockville, Maryland 20855, United States
Manufacturer:	Shenzhen Rui Ming Xin Technology Co. LTD
Address:	6/F, Building 4, Heng Chang Rong, NO.128, Shang Nan East Road, ShaJing, Baoan, ShenZhen, China
Date of Test:	Sep. 21, 2020 – Oct. 12, 2020
Applicable Standards:	FCC CFR Title 47 Part 15 Subpart C Section 15.247 FCC KDB 558074 D01 15.247 Meas Guidance v05r02 ANSI C63.10:2013

The above equipment has been tested by Shenzhen Tongce Testing Lab. and found compliance with the requirements set forth in the technical standards mentioned above. The results of testing in this report apply only to the product/system, which was tested. Other similar equipment will not necessarily produce the same results due to production tolerance and measurement uncertainties.

Tested By:

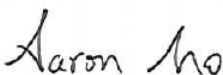

Aaron Mo

Date:

Oct. 12, 2020

Reviewed By:



Beryl Zhao

Date:

Oct. 13, 2020

Approved By:



Tomsin

Date:

Oct. 13, 2020

2. Test Result Summary

Requirement	CFR 47 Section	Result
Antenna Requirement	§15.203/§15.247 (c)	PASS
AC Power Line Conducted Emission	§15.207	PASS
Conducted Peak Output Power	§15.247 (b)(1)	PASS
20dB Occupied Bandwidth	§15.247 (a)(1)	PASS
Carrier Frequencies Separation	§15.247 (a)(1)	PASS
Hopping Channel Number	§15.247 (a)(1)	PASS
Dwell Time	§15.247 (a)(1)	PASS
Radiated Emission	§15.205/§15.209	PASS
Band Edge	§15.247(d)	PASS

Note:

1. PASS: Test item meets the requirement.
2. Fail: Test item does not meet the requirement.
3. N/A: Test case does not apply to the test object.
4. The test result judgment is decided by the limit of test standard.

3. EUT Description

Product:	Tablet PC
Model No.:	SophPad X11
Additional Model:	SophPad X21, SophPad X22, SophPad Y11, SophPad Y21, MemoPad A1, MemoPad A2, MemoPad A3, MemoPad C1, MemoPad C2, MemoPad C3
Trade Mark:	ARKNIKKO
Bluetooth version:	V5.0
Operation Frequency:	2402MHz~2480MHz
Transfer Rate:	1/2/3 Mbits/s
Number of Channel:	79
Modulation Type:	GFSK, $\pi/4$ -DQPSK, 8DPSK
Modulation Technology:	FHSS
Antenna Type:	Internal Antenna
Antenna Gain:	1.55dBi
Power Supply:	Rechargeable Li-ion battery DC 3.8V
AC adapter:	Adapter Information: MODEL: OS-10052A INPUT: AC 100-240V, 50/60Hz, 0.3A, Max OUTPUT: DC 5V, 2000mA
Remark:	All models above are identical in interior structure, electrical circuits and components, and just model names are different for the marketing requirement.

Note: The antenna gain listed in this report is provided by applicant, and the test laboratory is not responsible for this parameter.

Operation Frequency each of channel for GFSK, $\pi/4$ -DQPSK, 8DPSK

Channel	Frequency	Channel	Frequency	Channel	Frequency	Channel	Frequency
0	2402MHz	20	2422MHz	40	2442MHz	60	2462MHz
1	2403MHz	21	2423MHz	41	2443MHz	61	2463MHz
...
10	2412MHz	30	2432MHz	50	2452MHz	70	2472MHz
11	2413MHz	31	2433MHz	51	2453MHz	71	2473MHz
...
18	2420MHz	38	2440MHz	58	2460MHz	78	2480MHz
19	2421MHz	39	2441MHz	59	2461MHz	-	

Remark: Channel 0, 39 & 78 have been tested for GFSK, $\pi/4$ -DQPSK, 8DPSK modulation mode.

4. General Information

4.1. Test environment and mode

Operating Environment:		
Condition	Conducted Emission	Radiated Emission
Temperature:	25.0 °C	25.0 °C
Humidity:	55 % RH	55 % RH
Atmospheric Pressure:	1010 mbar	1010 mbar
Test software:	Pandora_R22.0.0001	
Power level setting:	N/A	
Test Mode:		
Engineering mode:	Keep the EUT in continuous transmitting by select channel and modulations with Fully-charged battery	
<p>The sample was placed 0.8m & 1.5m for the measurement below & above 1GHz above the ground plane of 3m chamber. Measurements in both horizontal and vertical polarities were performed. During the test, each emission was maximized by: having the EUT continuously working, investigated all operating modes, rotated about all 3 axis (X, Y & Z) and considered typical configuration to obtain worst position, manipulating interconnecting cables, rotating the turntable, varying antenna height from 1m to 4m in both horizontal and vertical polarizations. The emissions worst-case(Z axis) are shown in Test Results of the following pages.</p>		

4.2. Description of Support Units

The EUT has been tested as an independent unit together with other necessary accessories or support units. The following support units or accessories were used to form a representative test configuration during the tests.

Equipment	Model No.	Serial No.	FCC ID	Trade Name
/	/	/	/	/

Note:

1. All the equipment/cables were placed in the worst-case configuration to maximize the emission during the test.
2. Grounding was established in accordance with the manufacturer's requirements and conditions for the intended use.
3. For conducted measurements (Output Power, 20dB Occupied Bandwidth, Carrier Frequencies Separation, Hopping Channel Number, Dwell Time, Spurious Emissions), the antenna of EUT is connected to the test equipment via temporary antenna connector, the antenna connector is soldered on the antenna port of EUT, and the temporary antenna connector is listed in the Test Instruments.

5. Facilities and Accreditations

5.1. Facilities

The test facility is recognized, certified, or accredited by the following organizations:

- FCC - Registration No.: 645098

Shenzhen Tongce Testing Lab

The 3m Semi-anechoic chamber has been registered and fully described in a report with the (FCC) Federal Communications Commission. The acceptance letter from the FCC is maintained in our files.

- IC - Registration No.: 10668A-1

The 3m Semi-anechoic chamber of Shenzhen TCT Testing Technology Co., Ltd. has been registered by Certification and Engineering Bureau of Industry Canada for radio equipment testing

5.2. Location

Shenzhen Tongce Testing Lab

Address: 1B/F., Building 1, Yibaolai Industrial Park, Qiaotou, Fuyong, Baoan District, Shenzhen, Guangdong, China

Tel: 86-755-27673339

5.3. Measurement Uncertainty

The reported uncertainty of measurement $y \pm U$, where expanded uncertainty U is based on a standard uncertainty multiplied by a coverage factor of $k=2$, providing a level of confidence of approximately 95 %.

No.	Item	MU
1	Conducted Emission	$\pm 2.56\text{dB}$
2	RF power, conducted	$\pm 0.12\text{dB}$
3	Spurious emissions, conducted	$\pm 0.11\text{dB}$
4	All emissions, radiated(<1G)	$\pm 3.92\text{dB}$
5	All emissions, radiated(>1G)	$\pm 4.28\text{dB}$
6	Temperature	$\pm 0.1^\circ\text{C}$
7	Humidity	$\pm 1.0\%$

6. Test Results and Measurement Data

6.1. Antenna requirement

Standard requirement:	FCC Part15 C Section 15.203 /247(c)
15.203 requirement: An intentional radiator shall be designed to ensure that no antenna other than that furnished by the responsible party shall be used with the device. The use of a permanently attached antenna or of an antenna that uses a unique coupling to the intentional radiator, the manufacturer may design the unit so that a broken antenna can be replaced by the user, but the use of a standard antenna jack or electrical connector is prohibited.	
15.247(c) (1)(i) requirement: (i) Systems operating in the 2400-2483.5 MHz band that is used exclusively for fixed. Point-to-point operations may employ transmitting antennas with directional gain greater than 6dBi provided the maximum conducted output power of the intentional radiator is reduced by 1 dB for every 3 dB that the directional gain of the antenna exceeds 6dBi.	
E.U.T Antenna:	
The Bluetooth antenna is internal antenna which permanently attached, and the best case gain of the antenna is 1.55dBi.	

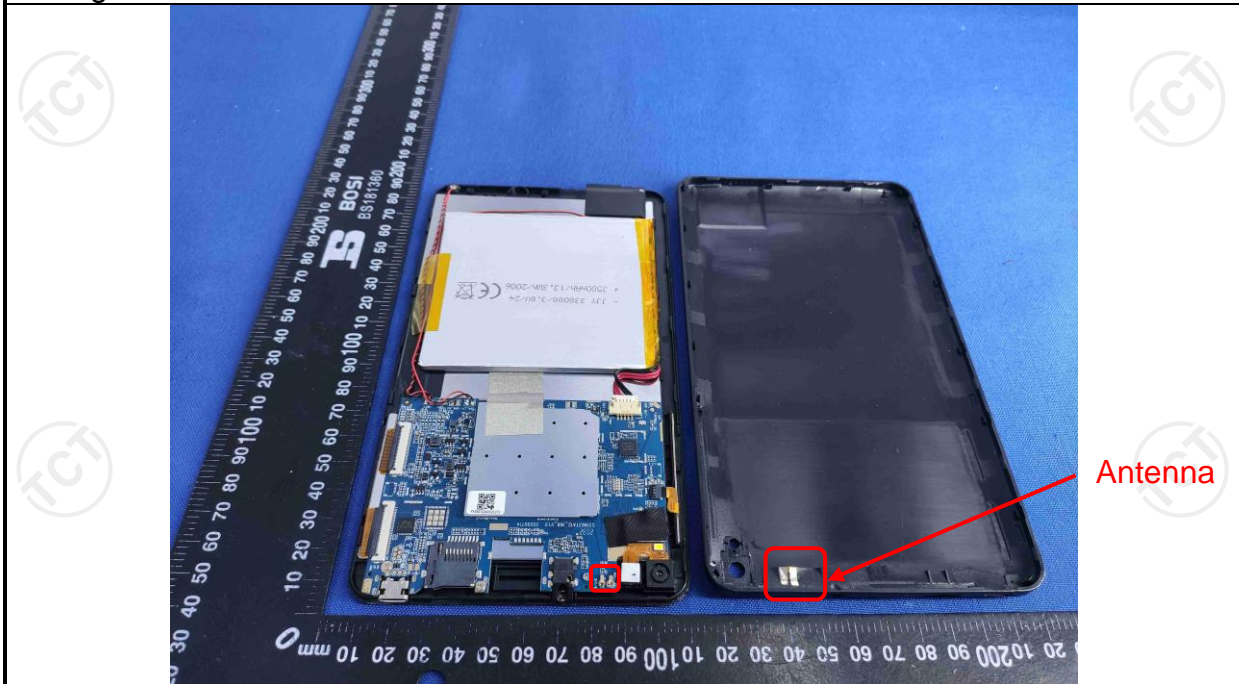

6.2. Conducted Emission

6.2.1. Test Specification

Test Requirement:	FCC Part15 C Section 15.207														
Test Method:	ANSI C63.10:2013														
Frequency Range:	150 kHz to 30 MHz														
Receiver setup:	RBW=9 kHz, VBW=30 kHz, Sweep time=auto														
Limits:	<table border="1"> <thead> <tr> <th rowspan="2">Frequency range (MHz)</th> <th colspan="2">Limit (dBuV)</th> </tr> <tr> <th>Quasi-peak</th> <th>Average</th> </tr> </thead> <tbody> <tr> <td>0.15-0.5</td> <td>66 to 56*</td> <td>56 to 46*</td> </tr> <tr> <td>0.5-5</td> <td>56</td> <td>46</td> </tr> <tr> <td>5-30</td> <td>60</td> <td>50</td> </tr> </tbody> </table>	Frequency range (MHz)	Limit (dBuV)		Quasi-peak	Average	0.15-0.5	66 to 56*	56 to 46*	0.5-5	56	46	5-30	60	50
Frequency range (MHz)	Limit (dBuV)														
	Quasi-peak	Average													
0.15-0.5	66 to 56*	56 to 46*													
0.5-5	56	46													
5-30	60	50													
Test Setup:	<p><i>Remark</i> E.U.T: Equipment Under Test LISN: Line Impedance Stabilization Network Test table height=0.8m</p>														
Test Mode:	Refer to item 4.1														
Test Procedure:	<ol style="list-style-type: none"> 1. The E.U.T is connected to an adapter through a line impedance stabilization network (L.I.S.N.). This provides a 50ohm/50uH coupling impedance for the measuring equipment. 2. The peripheral devices are also connected to the main power through a LISN that provides a 50ohm/50uH coupling impedance with 50ohm termination. (Please refer to the block diagram of the test setup and photographs). 3. Both sides of A.C. line are checked for maximum conducted interference. In order to find the maximum emission, the relative positions of equipment and all of the interface cables must be changed according to ANSI C63.10:2013 on conducted measurement. 														
Test Result:	PASS														

6.2.2. Test Instruments

Conducted Emission Shielding Room Test Site (843)				
Equipment	Manufacturer	Model	Serial Number	Calibration Due
Test Receiver	R&S	ESCI3	100898	Jul. 27, 2021
LISN-2	Schwarzbeck	NSLK 8126	8126453	Sep. 11, 2021
Line-5	TCT	CE-05	N/A	Sep. 02, 2021
EMI Test Software	Shurple Technology	EZ-EMC	N/A	N/A

Note: The calibration interval of the above test instruments is 12 months and the calibrations are traceable to international system unit (SI).

6.2.3. Test data

Please refer to following diagram for individual

Conducted Emission on Line Terminal of the power line (150 kHz to 30MHz)

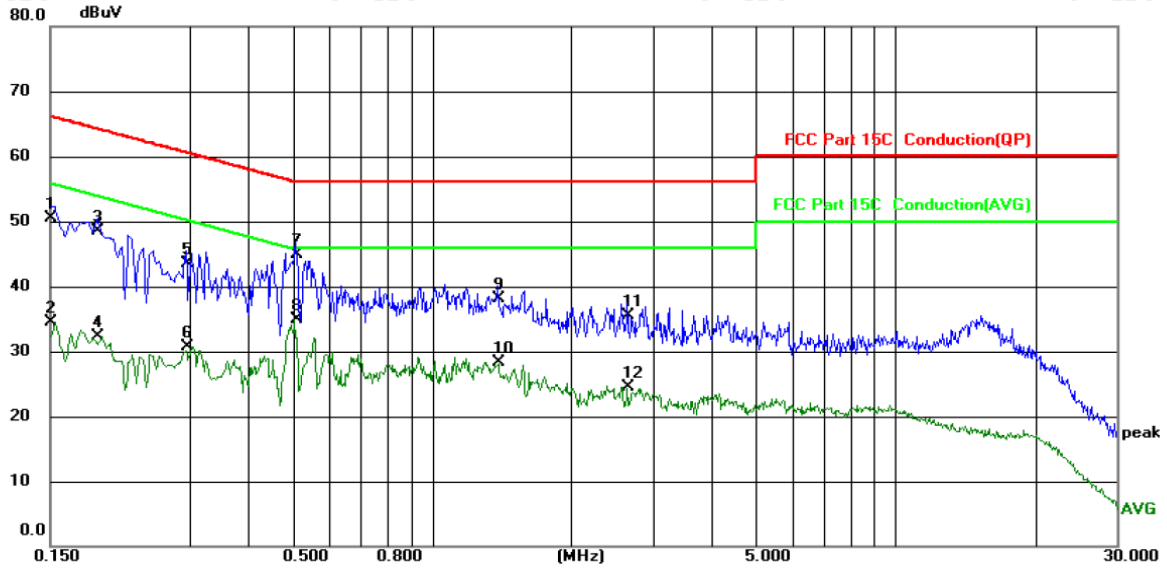

Site: Phase: **L1** Temperature: 25 (C)
Limit: FCC Part 15C Conduction(QP) Power: AC 120V/60Hz Humidity: 55 %RH

No.	Mk.	Freq. MHz	Reading Level dBuV	Correct Factor dB	Measure- ment dBuV	Limit dBuV	Over dB	Detector	Comment
1		0.1500	40.30	10.12	50.42	66.00	-15.58	QP	
2		0.1500	24.36	10.12	34.48	56.00	-21.52	AVG	
3		0.1900	38.48	10.12	48.60	64.04	-15.44	QP	
4		0.1900	22.13	10.12	32.25	54.04	-21.79	AVG	
5		0.2940	33.30	10.13	43.43	60.41	-16.98	QP	
6		0.2940	20.66	10.13	30.79	50.41	-19.62	AVG	
7		0.5100	34.71	10.13	44.84	56.00	-11.16	QP	
8	*	0.5100	24.73	10.13	34.86	46.00	-11.14	AVG	
9		1.3860	27.95	10.12	38.07	56.00	-17.93	QP	
10		1.3860	18.11	10.12	28.23	46.00	-17.77	AVG	
11		2.6420	25.43	10.12	35.55	56.00	-20.45	QP	
12		2.6420	14.39	10.12	24.51	46.00	-21.49	AVG	

Note:

Freq. = Emission frequency in MHz
 Reading level (dBuV) = Receiver reading
 Corr. Factor (dB) = LISN factor + Cable loss
 Measurement (dBuV) = Reading level (dBuV) + Corr. Factor (dB)
 Limit (dBuV) = Limit stated in standard
 Over (dB) = Measurement (dBuV) – Limits (dBuV)
 Q.P. =Quasi-Peak
 AVG =average
 Any value more than 10dB below limit have not been specifically reported.
 * is meaning the worst frequency has been tested in the frequency range 150 kHz to 30MHz

Conducted Emission on Neutral Terminal of the power line (150 kHz to 30MHz)

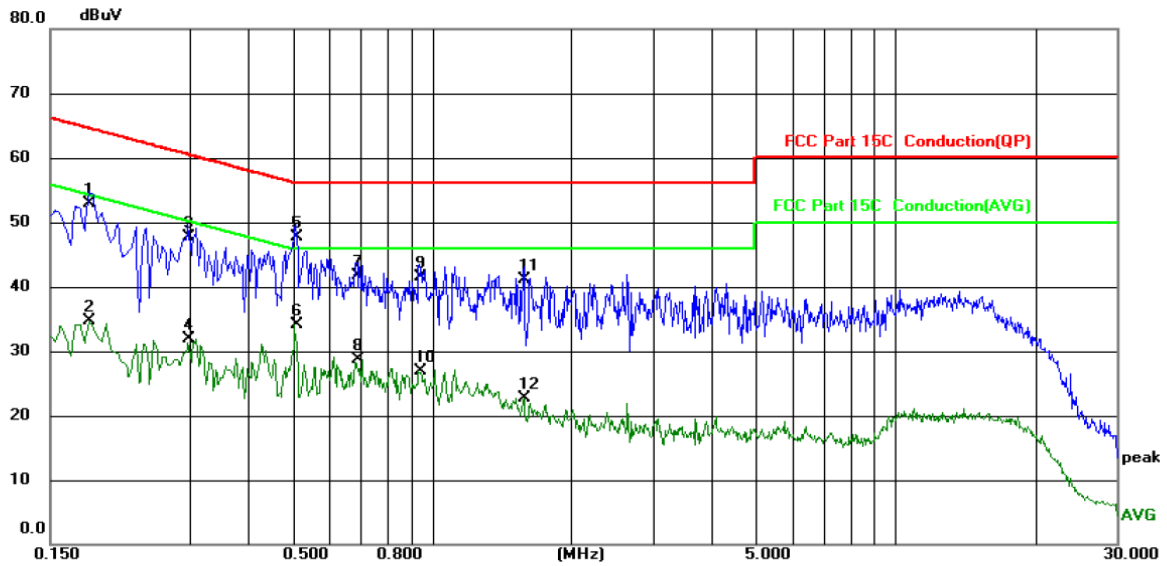

Site: Phase: **N** Temperature: 25 (C)
Limit: FCC Part 15C Conduction(QP) Power: AC 120V/60Hz Humidity: 55 %RH

No.	Mk.	Freq. MHz	Reading Level dBuV	Correct Factor dB	Measure- ment dBuV	Limit dBuV	Over dB	Detector	Comment
1		0.1819	42.75	10.12	52.87	64.40	-11.53	QP	
2		0.1819	24.60	10.12	34.72	54.40	-19.68	AVG	
3		0.2980	37.52	10.13	47.65	60.30	-12.65	QP	
4		0.2980	21.87	10.13	32.00	50.30	-18.30	AVG	
5	*	0.5100	37.54	10.13	47.67	56.00	-8.33	QP	
6		0.5100	24.03	10.13	34.16	46.00	-11.84	AVG	
7		0.6900	31.63	10.12	41.75	56.00	-14.25	QP	
8		0.6900	18.53	10.12	28.65	46.00	-17.35	AVG	
9		0.9420	31.42	10.12	41.54	56.00	-14.46	QP	
10		0.9420	16.78	10.12	26.90	46.00	-19.10	AVG	
11		1.5780	31.02	10.12	41.14	56.00	-14.86	QP	
12		1.5780	12.58	10.12	22.70	46.00	-23.30	AVG	

Note1:

Freq. = Emission frequency in MHz
Reading level (dBuV) = Receiver reading
Corr. Factor (dB) = LISN factor + Cable loss
Measurement (dBuV) = Reading level (dBuV) + Corr. Factor (dB)
Limit (dBuV) = Limit stated in standard
Over (dB) = Measurement (dBuV) – Limits (dBuV)
Q.P. =Quasi-Peak
AVG =average
Any value more than 10dB below limit have not been specifically reported.
** is meaning the worst frequency has been tested in the frequency range 150 kHz to 30MHz.*

Note2:

Measurements were conducted in all three channels (high, middle, low) and three modulation (GFSK, Pi/4 DQPSK, 8DPSK), and the worst case Mode (middle channel and 8DPSK) was submitted only.

6.3. Conducted Output Power

6.3.1. Test Specification

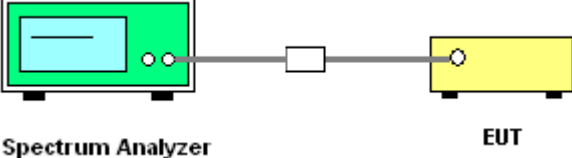
Test Requirement:	FCC Part15 C Section 15.247 (b)(1)
Test Method:	KDB 558074 D01 v05r02
Limit:	Section 15.247 (b) The maximum peak conducted output power of the intentional radiator shall not exceed the following: (1) For frequency hopping systems operating in the 2400-2483.5 MHz band employing at least 75 non-overlapping hopping channels, and all frequency hopping systems in the 5725-5850 MHz band: 1 watt. For all other frequency hopping systems in the 2400-2483.5 MHz band 0.125 watts.
Test Setup:	 <p style="text-align: center;">Spectrum Analyzer EUT</p>
Test Mode:	Transmitting mode with modulation
Test Procedure:	Use the following spectrum analyzer settings: Span = approximately 5 times the 20 dB bandwidth, centered on a hopping channel RBW > the 20 dB bandwidth of the emission being measured VBW ≥ RBW Sweep = auto Detector function = peak Trace = max hold Allow the trace to stabilize. Use the marker-to-peak function to set the marker to the peak of the emission.
Test Result:	PASS

6.3.2. Test Instruments

Equipment	Manufacturer	Model	Serial Number	Calibration Due
Spectrum Analyzer	R&S	FSU	200054	Sep. 11, 2021
RF cable (9kHz-26.5GHz)	TCT	RE-06	N/A	Sep. 11, 2021
Antenna Connector	TCT	RFC-01	N/A	Sep. 11, 2021

Note: The calibration interval of the above test instruments is 12 months and the calibrations are traceable to international system unit (SI).

6.3.3. Test Data

GFSK mode			
Test channel	Peak Output Power (dBm)	Limit (dBm)	Result
Lowest	5.24	30.00	PASS
Middle	5.30	30.00	PASS
Highest	4.36	30.00	PASS

Pi/4DQPSK mode			
Test channel	Peak Output Power (dBm)	Limit (dBm)	Result
Lowest	5.54	21.00	PASS
Middle	5.59	21.00	PASS
Highest	4.65	21.00	PASS

8DPSK mode			
Test channel	Peak Output Power (dBm)	Limit (dBm)	Result
Lowest	5.97	21.00	PASS
Middle	5.98	21.00	PASS
Highest	5.12	21.00	PASS

Test plots as follows:

GFSK Modulation

Lowest channel

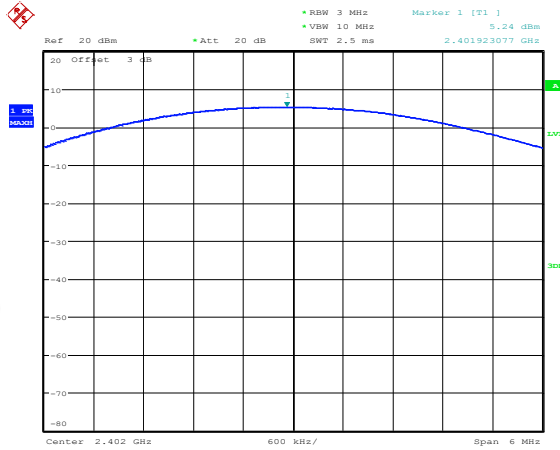

Date: 29.SEP.2020 10:54:36

Middle channel

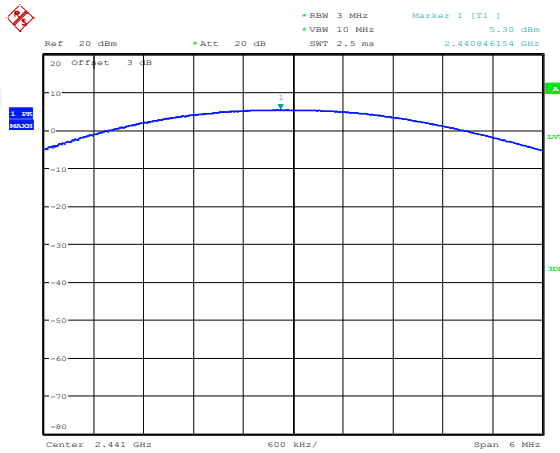

Date: 29.SEP.2020 10:54:57

Highest channel

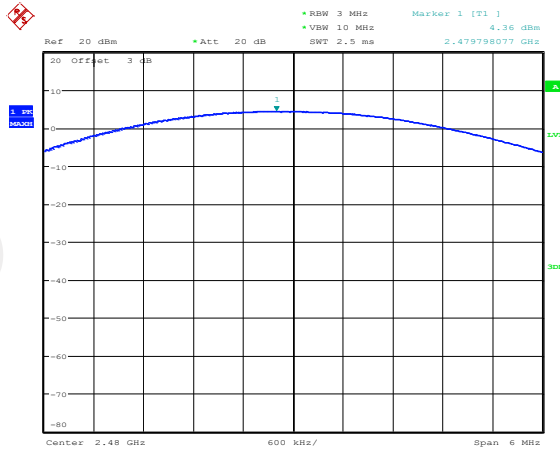

Date: 29.SEP.2020 10:56:44

Pi/4DQPSK Modulation

Lowest channel

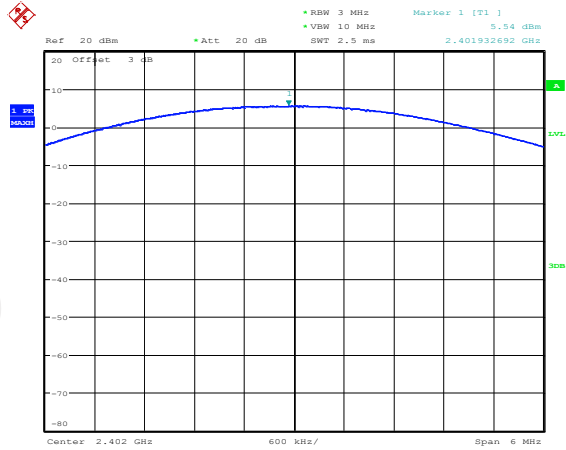

Date: 29.SEP.2020 10:54:19

Middle channel

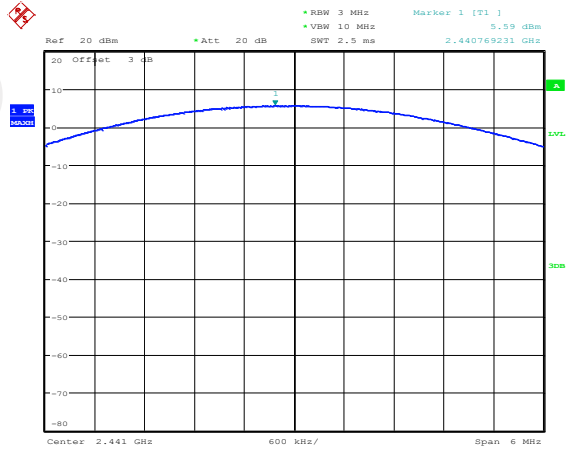

Date: 29.SEP.2020 10:55:17

Highest channel

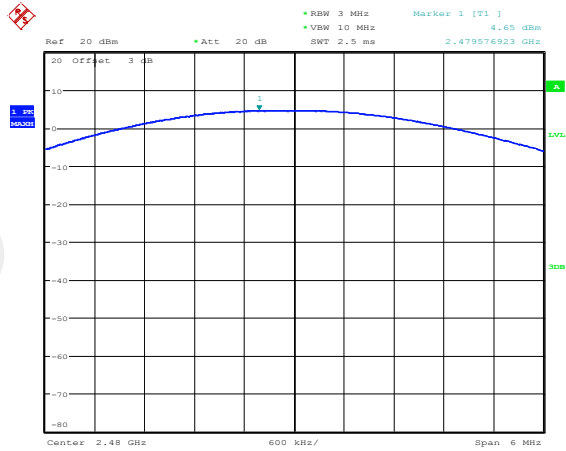

Date: 29.SEP.2020 10:56:23

8DPSK Modulation

Lowest channel

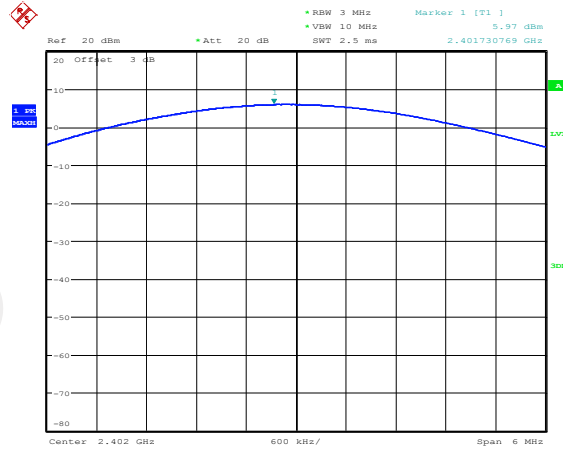

Date: 29.SEP.2020 10:54:01

Middle channel

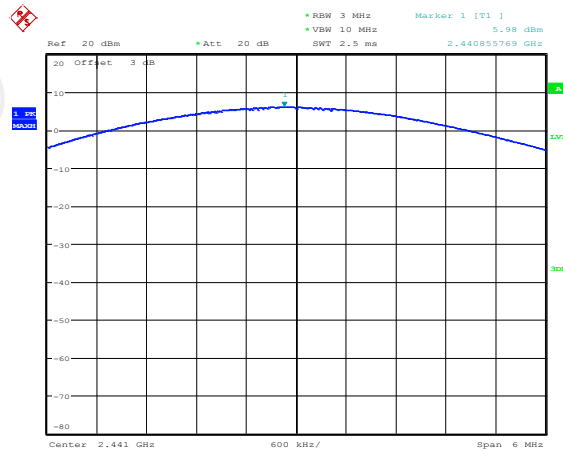

Date: 29.SEP.2020 10:55:38

Highest channel

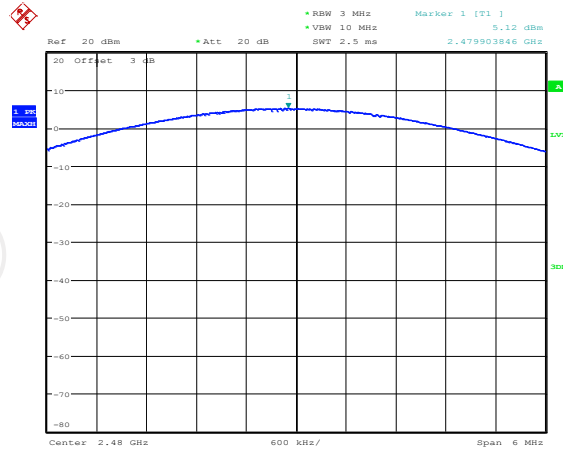

Date: 29.SEP.2020 10:56:02

6.4. 20dB Occupy Bandwidth

6.4.1. Test Specification

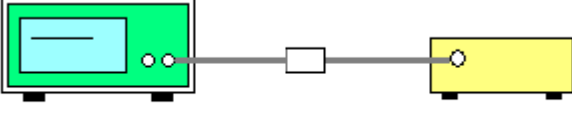
Test Requirement:	FCC Part15 C Section 15.247 (a)(1)
Test Method:	KDB 558074 D01 v05r02
Limit:	N/A
Test Setup:	 <p style="text-align: center;">Spectrum Analyzer EUT</p>
Test Mode:	Transmitting mode with modulation
Test Procedure:	<ol style="list-style-type: none"> 1. The RF output of EUT was connected to the spectrum analyzer by RF cable and attenuator. The path loss was compensated to the results for each measurement. 2. Set to the maximum power setting and enable the EUT transmit continuously. 3. Use the following spectrum analyzer settings for 20dB Bandwidth measurement. Span = approximately 2 to 5 times the 20 dB bandwidth, centered on a hopping channel; $1\% \leq RBW \leq 5\%$ of the 20 dB bandwidth; $VBW \geq 3RBW$; Sweep = auto; Detector function = peak; Trace = max hold. 4. Measure and record the results in the test report.
Test Result:	PASS

6.4.2. Test Instruments

Equipment	Manufacturer	Model	Serial Number	Calibration Due
Spectrum Analyzer	R&S	FSU	200054	Sep. 11, 2021
RF cable (9kHz-26.5GHz)	TCT	RE-06	N/A	Sep. 11, 2021
Antenna Connector	TCT	RFC-01	N/A	Sep. 11, 2021

Note: The calibration interval of the above test instruments is 12 months and the calibrations are traceable to international system unit (SI).

6.4.3. Test data

Test channel	20dB Occupy Bandwidth (kHz)			
	GFSK	$\pi/4$ -DQPSK	8DPSK	Conclusion
Lowest	964.74	1365.38	1360.58	PASS
Middle	967.95	1365.38	1365.38	PASS
Highest	971.15	1370.19	1375.00	PASS

Test plots as follows:

GFSK Modulation

Lowest channel

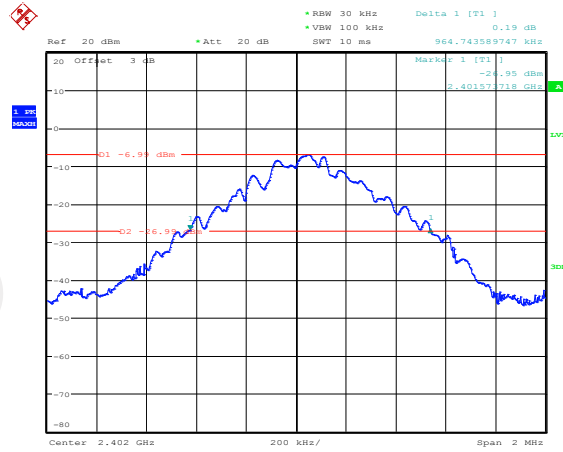

Date: 12.OCT.2020 14:00:18

Middle channel

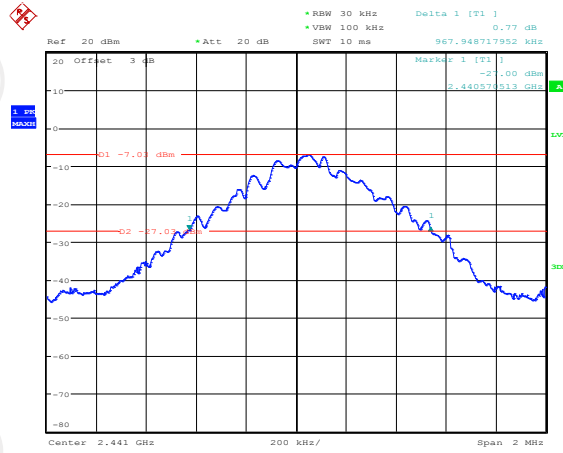

Date: 12.OCT.2020 13:58:48

Highest channel

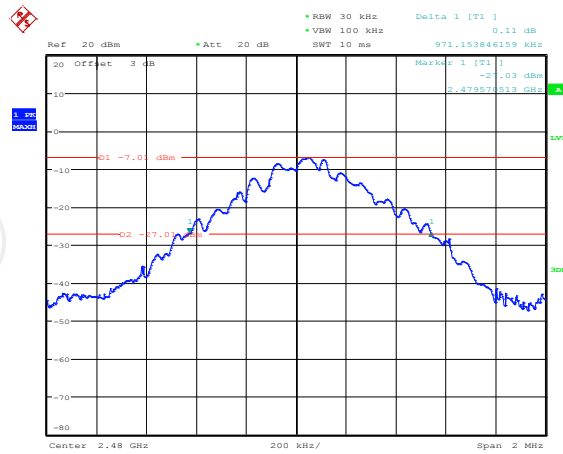

Date: 12.OCT.2020 14:01:03

Pi/4DQPSK Modulation

Lowest channel

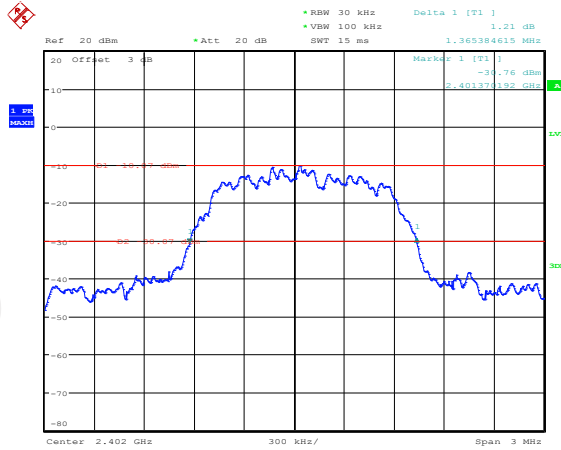

Date: 9.OCT.2020 14:38:22

Middle channel

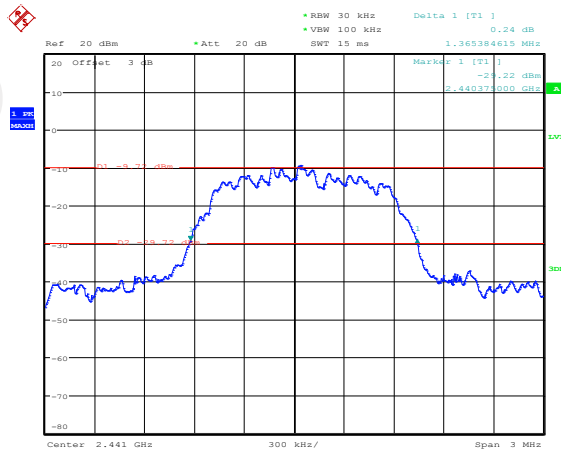

Date: 9.OCT.2020 14:37:24

Highest channel

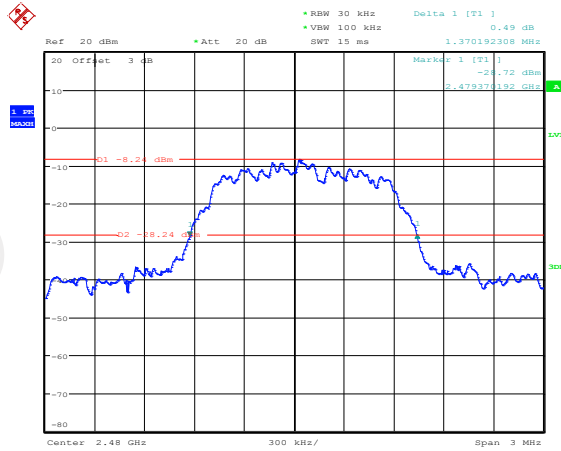

Date: 9.OCT.2020 14:36:12

8DPSK Modulation

Lowest channel

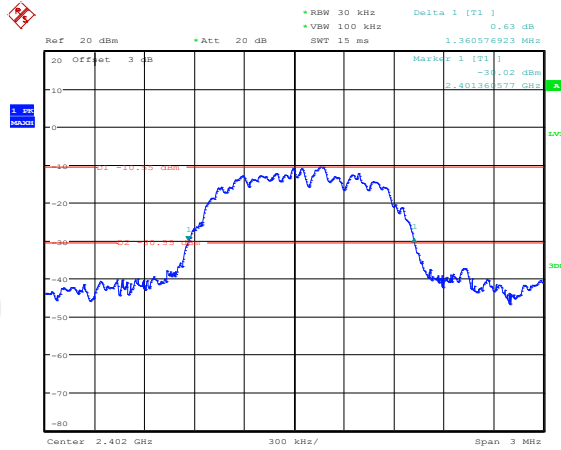

Date: 9.OCT.2020 14:39:07

Middle channel

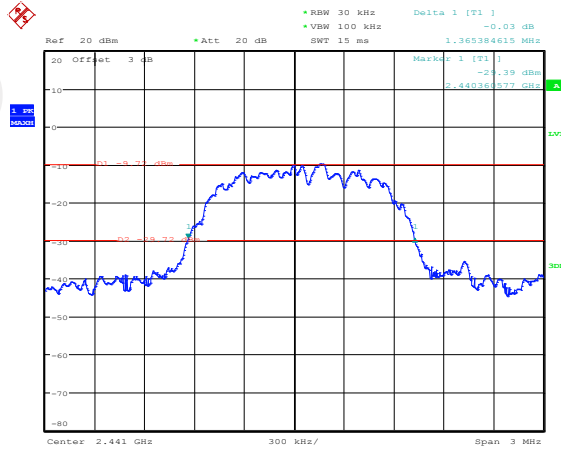

Date: 9.OCT.2020 14:39:48

Highest channel

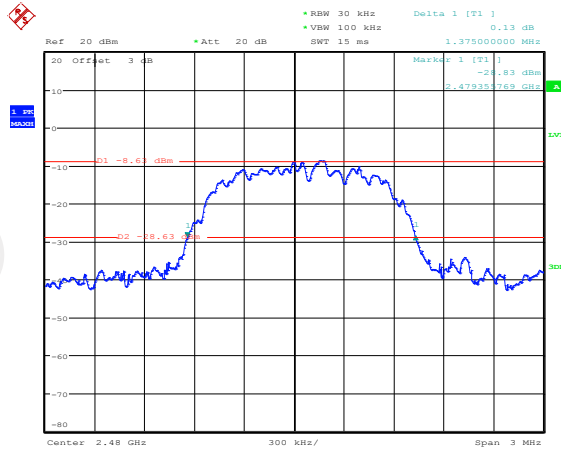

Date: 9.OCT.2020 14:41:23

6.5.3. Test data

GFSK mode			
Test channel	Carrier Frequencies Separation (kHz)	Limit (kHz)	Result
Lowest	1000.00	971.15	PASS
Middle	1000.00	971.15	PASS
Highest	1003.21	971.15	PASS

Pi/4 DQPSK mode			
Test channel	Carrier Frequencies Separation (kHz)	Limit (kHz)	Result
Lowest	1000.00	913.46	PASS
Middle	1003.21	913.46	PASS
Highest	1003.21	913.46	PASS

8DPSK mode			
Test channel	Carrier Frequencies Separation (kHz)	Limit (kHz)	Result
Lowest	1000.00	916.67	PASS
Middle	1000.00	916.67	PASS
Highest	1003.21	916.67	PASS

Note: According to section 6.4

Mode	20dB bandwidth (kHz) (worse case)	Limit (kHz) (Carrier Frequencies Separation)
GFSK	971.15	971.15
$\pi/4$ -DQPSK	1370.19	913.46
8DPSK	1375.00	916.67

Test plots as follows:

GFSK Modulation

Lowest channel

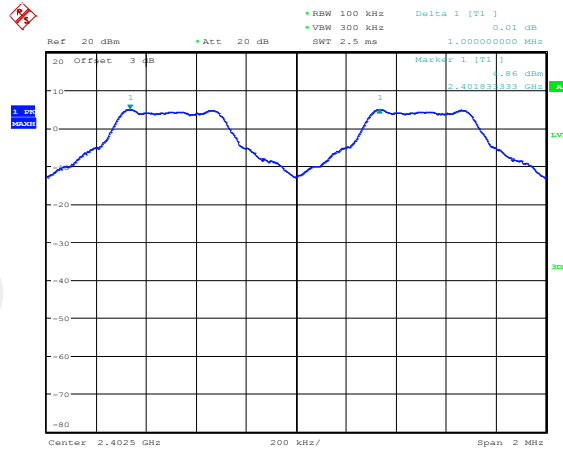

Date: 29.SEP.2020 11:30:49

Middle channel

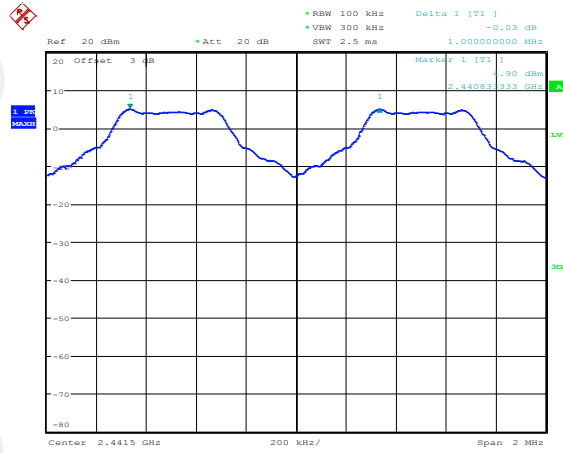

Date: 29.SEP.2020 11:31:45

Highest channel

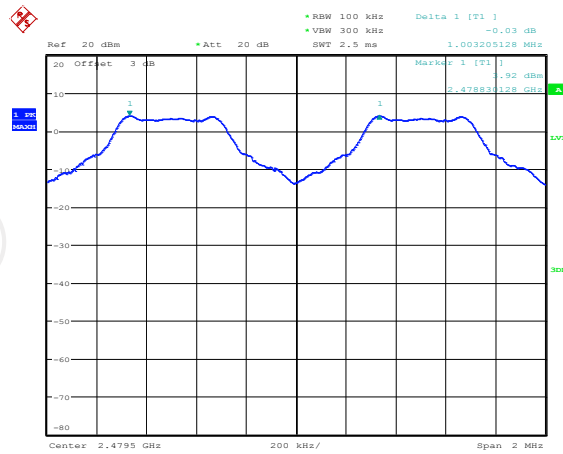

Date: 29.SEP.2020 11:32:31

Pi/4DQPSK Modulation

Lowest channel

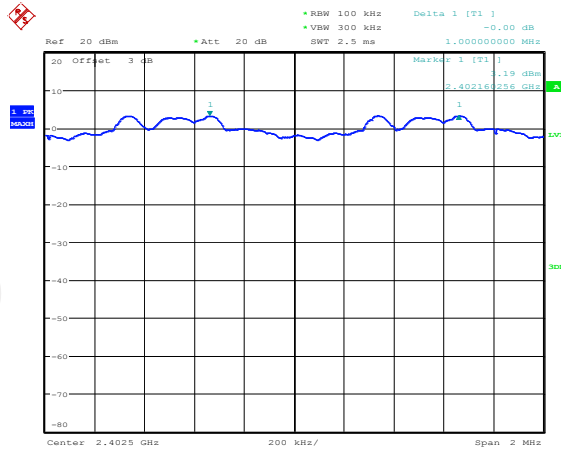

Date: 29.SEP.2020 11:29:58

Middle channel

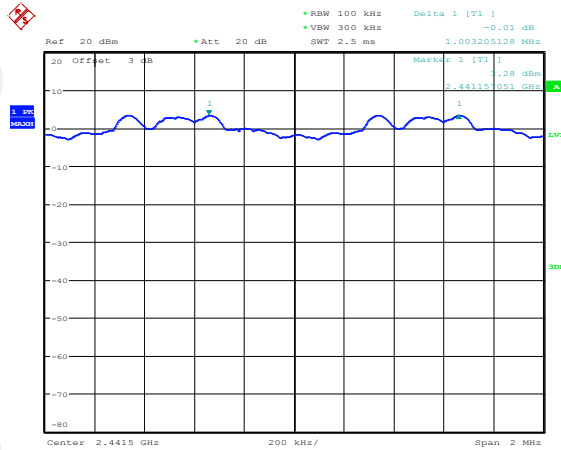

Date: 29.SEP.2020 11:35:16

Highest channel

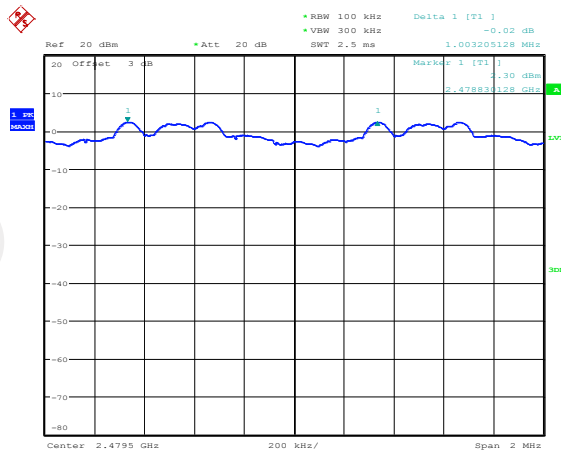

Date: 29.SEP.2020 11:33:28

8DPSK Modulation

Lowest channel

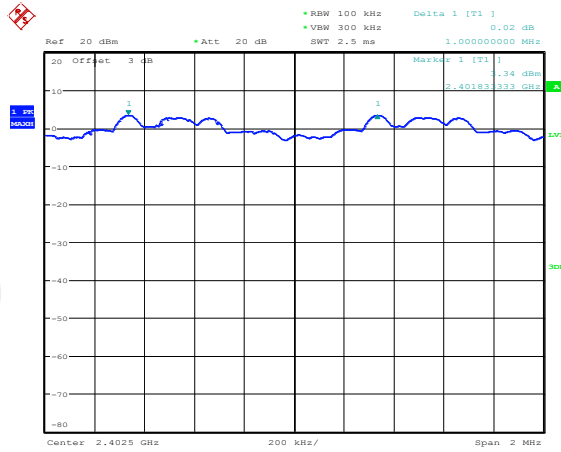

Date: 29.SEP.2020 11:28:39

Middle channel

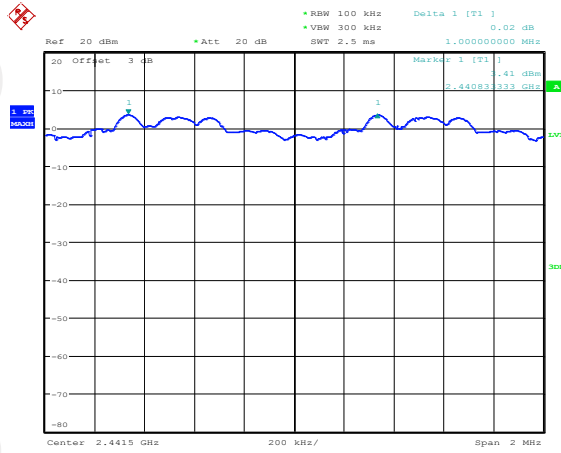

Date: 29.SEP.2020 11:36:05

Highest channel

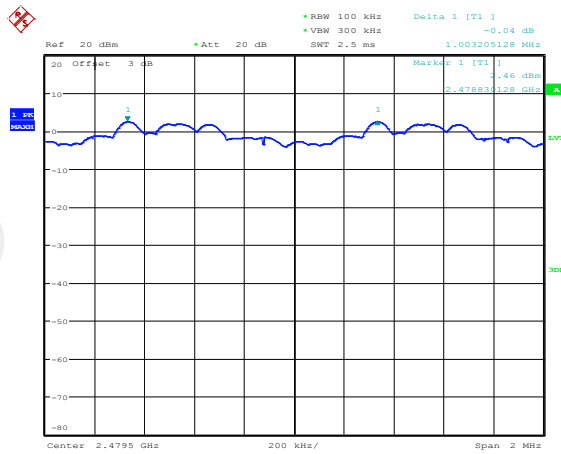

Date: 29.SEP.2020 11:36:51

6.6. Hopping Channel Number

6.6.1. Test Specification

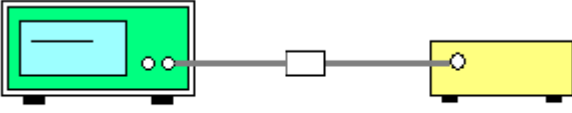
Test Requirement:	FCC Part15 C Section 15.247 (a)(1)
Test Method:	KDB 558074 D01 v05r02
Limit:	Frequency hopping systems in the 2400-2483.5 MHz band shall use at least 15 channels.
Test Setup:	 <p style="text-align: center;">Spectrum Analyzer EUT</p>
Test Mode:	Hopping mode
Test Procedure:	<ol style="list-style-type: none"> 1. The RF output of EUT was connected to the spectrum analyzer by RF cable and attenuator. The path loss was compensated to the results for each measurement. 2. Set to the maximum power setting and enable the EUT transmit continuously. 3. Enable the EUT hopping function. 4. Use the following spectrum analyzer settings: Span = the frequency band of operation; set the RBW to less than 30% of the channel spacing or the 20 dB bandwidth, whichever is smaller; VBW≥RBW; Sweep = auto; Detector function = peak; Trace = max hold. 5. The number of hopping frequency used is defined as the number of total channel. 6. Record the measurement data in report.
Test Result:	PASS

6.6.2. Test Instruments

Equipment	Manufacturer	Model	Serial Number	Calibration Due
Spectrum Analyzer	R&S	FSU	200054	Sep. 11, 2021
RF cable (9kHz-26.5GHz)	TCT	RE-06	N/A	Sep. 11, 2021
Antenna Connector	TCT	RFC-01	N/A	Sep. 11, 2021

Note: The calibration interval of the above test instruments is 12 months and the calibrations are traceable to international system unit (SI).

6.6.3. Test data

Mode	Hopping channel numbers	Limit	Result
GFSK, Pi/4DQPSK, 8DPSK	79	15	PASS

Test plots as follows:

GFSK

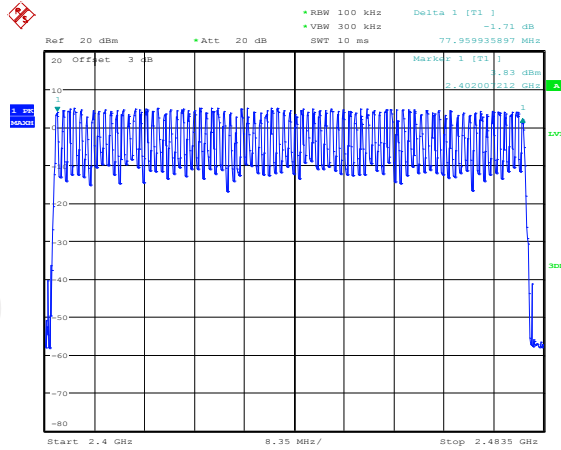

Date: 29.SEP.2020 11:55:39

Pi/4DQPSK

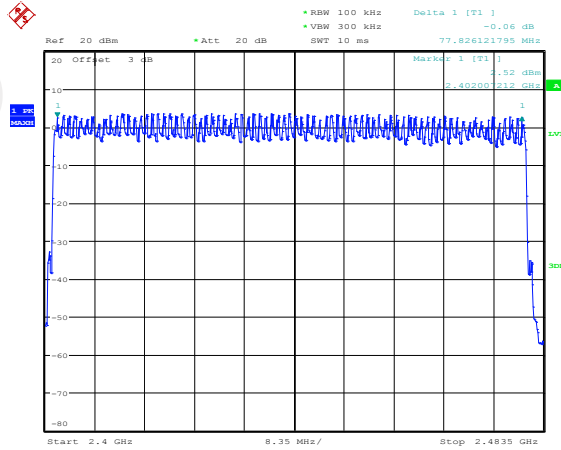

Date: 29.SEP.2020 11:51:51

8DPSK

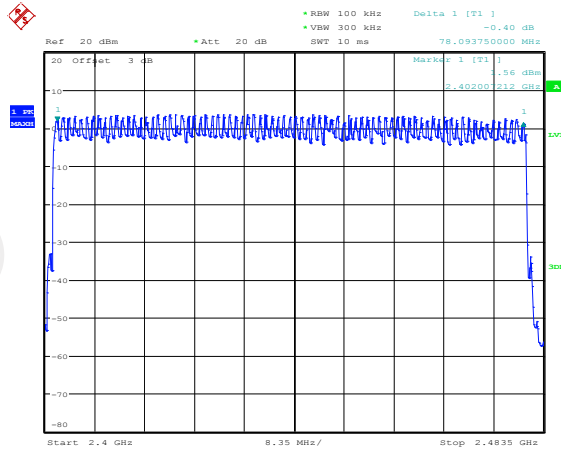

Date: 29.SEP.2020 11:48:03

6.7. Dwell Time

6.7.1. Test Specification

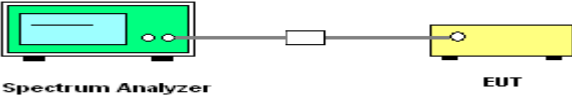
Test Requirement:	FCC Part15 C Section 15.247 (a)(1)
Test Method:	KDB 558074 D01 v05r02
Limit:	The average time of occupancy on any channel shall not be greater than 0.4 seconds within a period of 0.4 seconds multiplied by the number of hopping channels employed.
Test Setup:	 <p style="text-align: center;">Spectrum Analyzer EUT</p>
Test Mode:	Hopping mode
Test Procedure:	<ol style="list-style-type: none"> 1. The RF output of EUT was connected to the spectrum analyzer by RF cable and attenuator. The path loss was compensated to the results for each measurement. 2. Set to the maximum power setting and enable the EUT transmit continuously. 3. Enable the EUT hopping function. 4. Use the following spectrum analyzer settings: Span = zero span, centered on a hopping channel; RBW shall be \leq channel spacing and where possible RBW should be set $\gg 1 / T$, where T is the expected dwell time per channel; VBW \geq RBW; Sweep = as necessary to capture the entire dwell time per hopping channel; Detector function = peak; Trace = max hold. 5. Measure and record the results in the test report.
Test Result:	PASS

6.7.2. Test Instruments

Equipment	Manufacturer	Model	Serial Number	Calibration Due
Spectrum Analyzer	R&S	FSU	200054	Sep. 11, 2021
RF cable (9kHz-26.5GHz)	TCT	RE-06	N/A	Sep. 11, 2021
Antenna Connector	TCT	RFC-01	N/A	Sep. 11, 2021

Note: The calibration interval of the above test instruments is 12 months and the calibrations are traceable to international system unit (SI).

6.7.3. Test Data

Mode	Packet	Hops Over Occupancy Time (hops)	Package Transfer Time (ms)	Dwell time (second)	Limit (second)	Result
GFSK	DH1	320	0.418	0.134	0.4	PASS
GFSK	DH3	160	1.689	0.270	0.4	PASS
GFSK	DH5	106.67	2.971	0.317	0.4	PASS
Pi/4 DQPSK	2-DH1	320	0.415	0.133	0.4	PASS
Pi/4 DQPSK	2-DH3	160	1.679	0.269	0.4	PASS
Pi/4 DQPSK	2-DH5	106.67	2.946	0.314	0.4	PASS
8DPSK	3-DH1	320	0.410	0.131	0.4	PASS
8DPSK	3-DH3	160	1.675	0.268	0.4	PASS
8DPSK	3-DH5	106.67	2.875	0.307	0.4	PASS

Note: 1. In normal mode, hopping rate is 1600 hops/s with 6 slots in 79 hopping channels.

For DH1, With channel hopping rate $(1600 / 2 / 79)$ in Occupancy Time Limit (0.4×79) (s), Hops Over Occupancy Time comes to $(1600 / 2 / 79) \times (0.4 \times 79) = 320$ hops

For DH3, With channel hopping rate $(1600 / 4 / 79)$ in Occupancy Time Limit (0.4×79) (s), Hops Over Occupancy Time comes to $(1600 / 4 / 79) \times (0.4 \times 79) = 160$ hops

For DH5, With channel hopping rate $(1600 / 6 / 79)$ in Occupancy Time Limit (0.4×79) (s), Hops Over Occupancy Time comes to $(1600 / 6 / 79) \times (0.4 \times 79) = 106.67$ hops

2. Dwell Time(s) = Hops Over Occupancy Time (hops) x Package Transfer Time

Test plots as follows:

**GFSK
DH1**

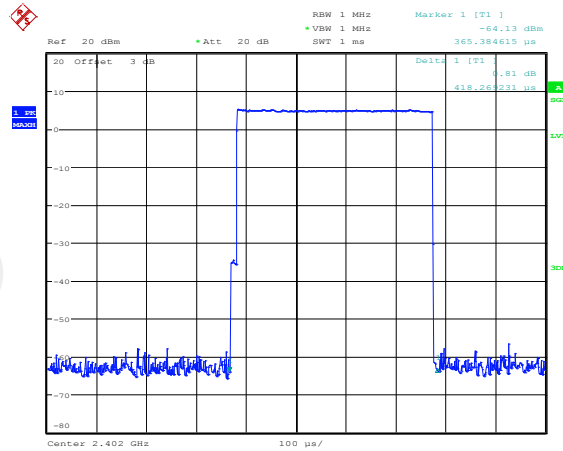

Date: 29.SEP.2020 11:21:55

DH3

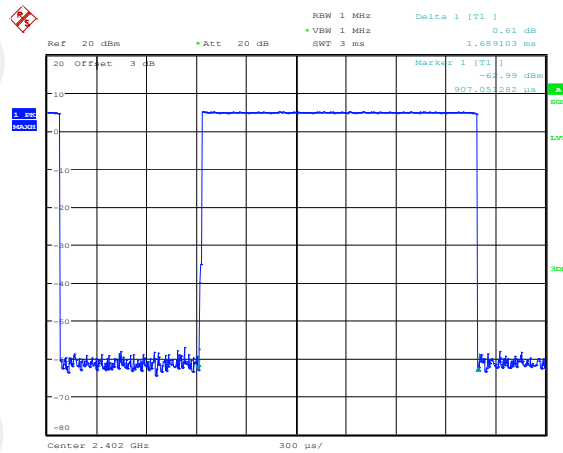

Date: 29.SEP.2020 11:25:08

DH5

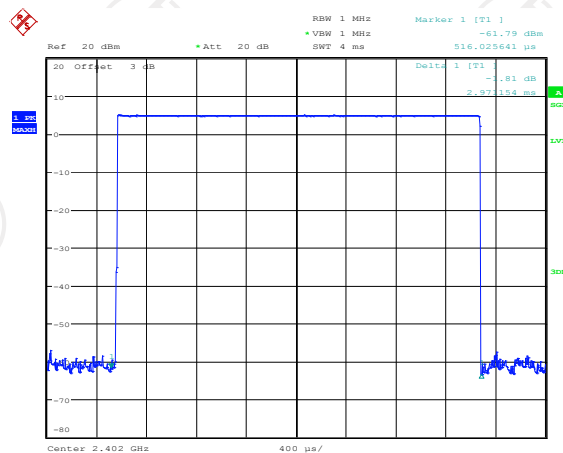

Date: 29.SEP.2020 11:25:40

Pi/4DQPSK
2-DH1

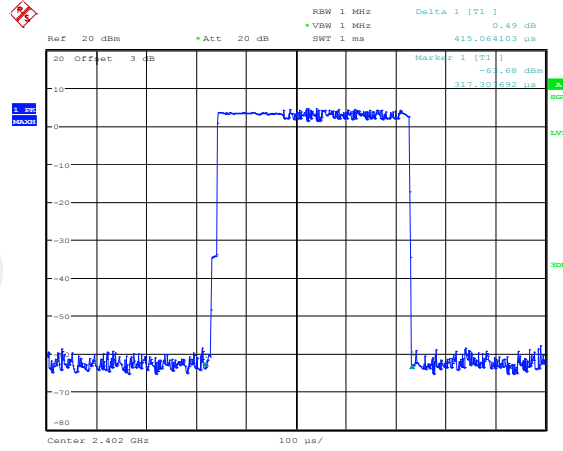

Date: 29.SEP.2020 11:22:29

2-DH3

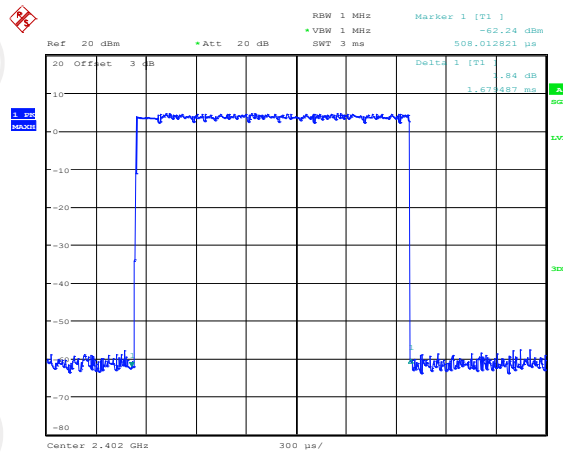

Date: 29.SEP.2020 11:24:23

2-DH5

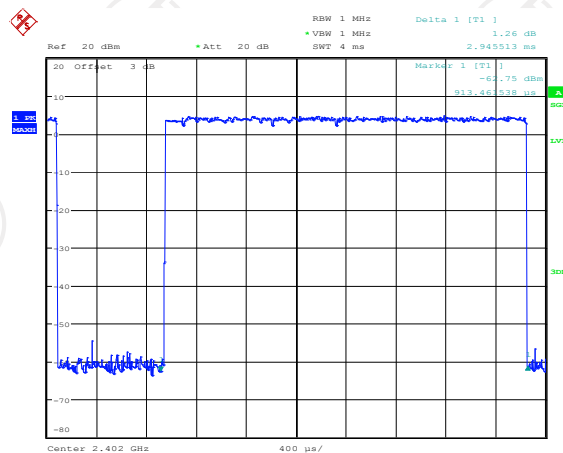

Date: 29.SEP.2020 11:26:28

8DPSK 3-DH1

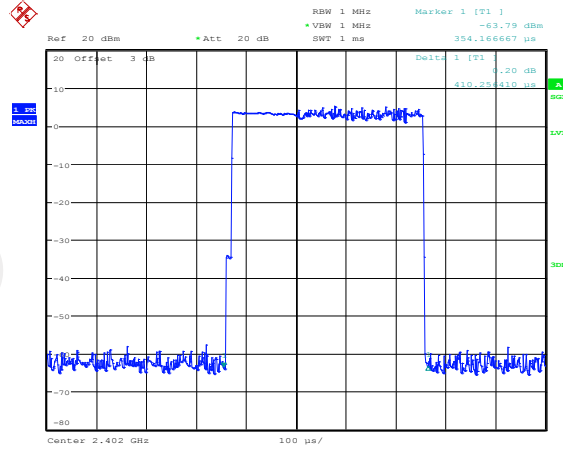

Date: 29.SEP.2020 11:23:04

3-DH3

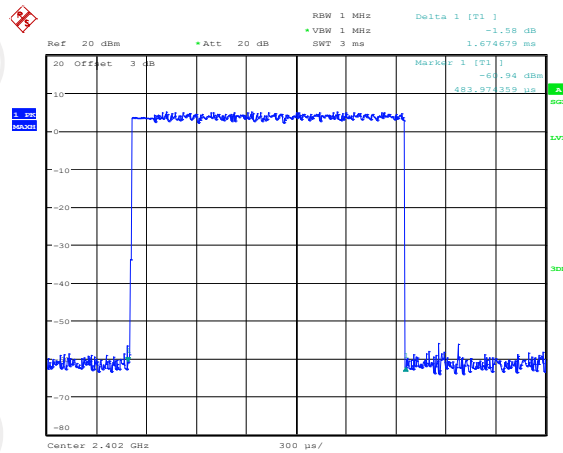

Date: 29.SEP.2020 11:23:48

3-DH5

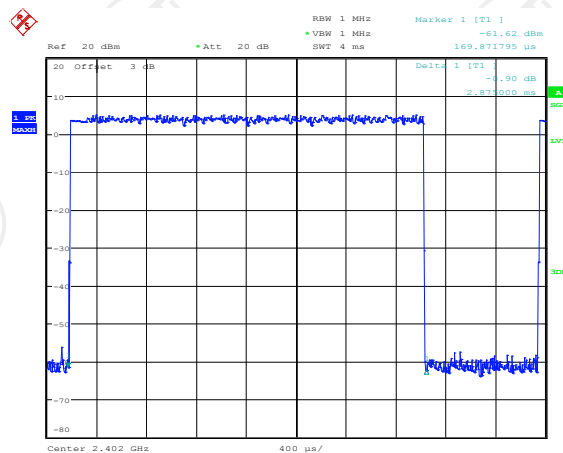

Date: 29.SEP.2020 11:26:56

6.8. Pseudorandom Frequency Hopping Sequence

Test Requirement: FCC Part15 C Section 15.247 (a)(1) requirement:

Frequency hopping systems shall have hopping channel carrier frequencies separated by a minimum of 25 kHz or the 20 dB bandwidth of the hopping channel, whichever is greater.

Alternatively. Frequency hopping systems operating in the 2400-2483.5 MHz band may have hopping channel carrier frequencies that are separated by 25 kHz or two-thirds of the 20 dB bandwidth of the hopping channel, whichever is greater, provided the systems operate with an output power no greater than 125 mW. The system shall hop to channel frequencies that are selected at the system hopping rate from a Pseudorandom ordered list of hopping frequencies. Each frequency must be used equally on the average by each transmitter. The system receivers shall have input bandwidths that match the hopping channel bandwidths of their corresponding transmitters and shall shift frequencies in synchronization with the transmitted signals.

EUT Pseudorandom Frequency Hopping Sequence

The pseudorandom sequence may be generated in a nine-stage shift register whose 5th and 9th stage outputs are added in a modulo-two addition stage. And the result is fed back to the input of the first stage. The sequence begins with the first one of 9 consecutive ones; i.e. the shift register is initialized with nine ones.

- Number of shift register stages: 9
- Length of pseudo-random sequence: $2^9 - 1 = 511$ bits
- Longest sequence of zeros: 8 (non-inverted signal)

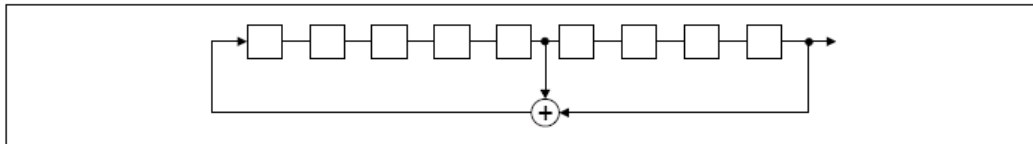

Linear Feedback Shift Register for Generation of the PRBS sequence

An example of Pseudorandom Frequency Hopping Sequence as follow:

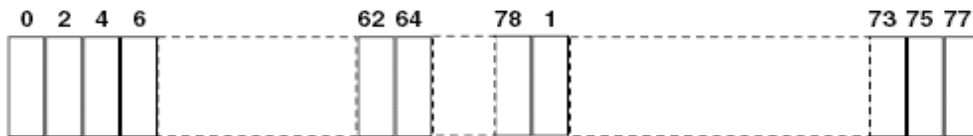

Each frequency used equally on the average by each transmitter. The system receivers have input bandwidths that match the hopping channel bandwidths of their corresponding transmitters and shift frequencies in synchronization with the transmitted signals.

6.9. Conducted Band Edge Measurement

6.9.1. Test Specification

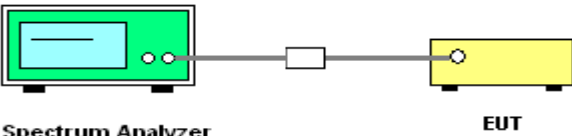
Test Requirement:	FCC Part15 C Section 15.247 (d)
Test Method:	KDB 558074 D01 v05r02
Limit:	In any 100 kHz bandwidth outside the intentional radiation frequency band, the radio frequency power shall be at least 20 dB below the highest level of the radiated power. In addition, radiated emissions which fall in the restricted bands must also comply with the radiated emission limits.
Test Setup:	 <p style="text-align: center;">Spectrum Analyzer EUT</p>
Test Mode:	Transmitting mode with modulation
Test Procedure:	<ol style="list-style-type: none"> 1. Set to the maximum power setting and enable the EUT transmit continuously. 2. Set RBW = 100 kHz ($\geq 1\%$ span=10MHz), VBW = 300 kHz (\geqRBW). Band edge emissions must be at least 20 dB down from the highest emission level within the authorized band as measured with a 100kHz RBW. The attenuation shall be 30 dB instead of 20 dB when RMS conducted output power procedure is used. 3. Enable hopping function of the EUT and then repeat step 2 and 3. 4. Measure and record the results in the test report.
Test Result:	PASS

6.9.2. Test Instruments

Equipment	Manufacturer	Model	Serial Number	Calibration Due
Spectrum Analyzer	R&S	FSU	200054	Sep. 11, 2021
RF cable (9kHz-26.5GHz)	TCT	RE-06	N/A	Sep. 11, 2021
Antenna Connector	TCT	RFC-01	N/A	Sep. 11, 2021

Note: The calibration interval of the above test instruments is 12 months and the calibrations are traceable to international system unit (SI).

6.9.3. Test Data

GFSK Modulation

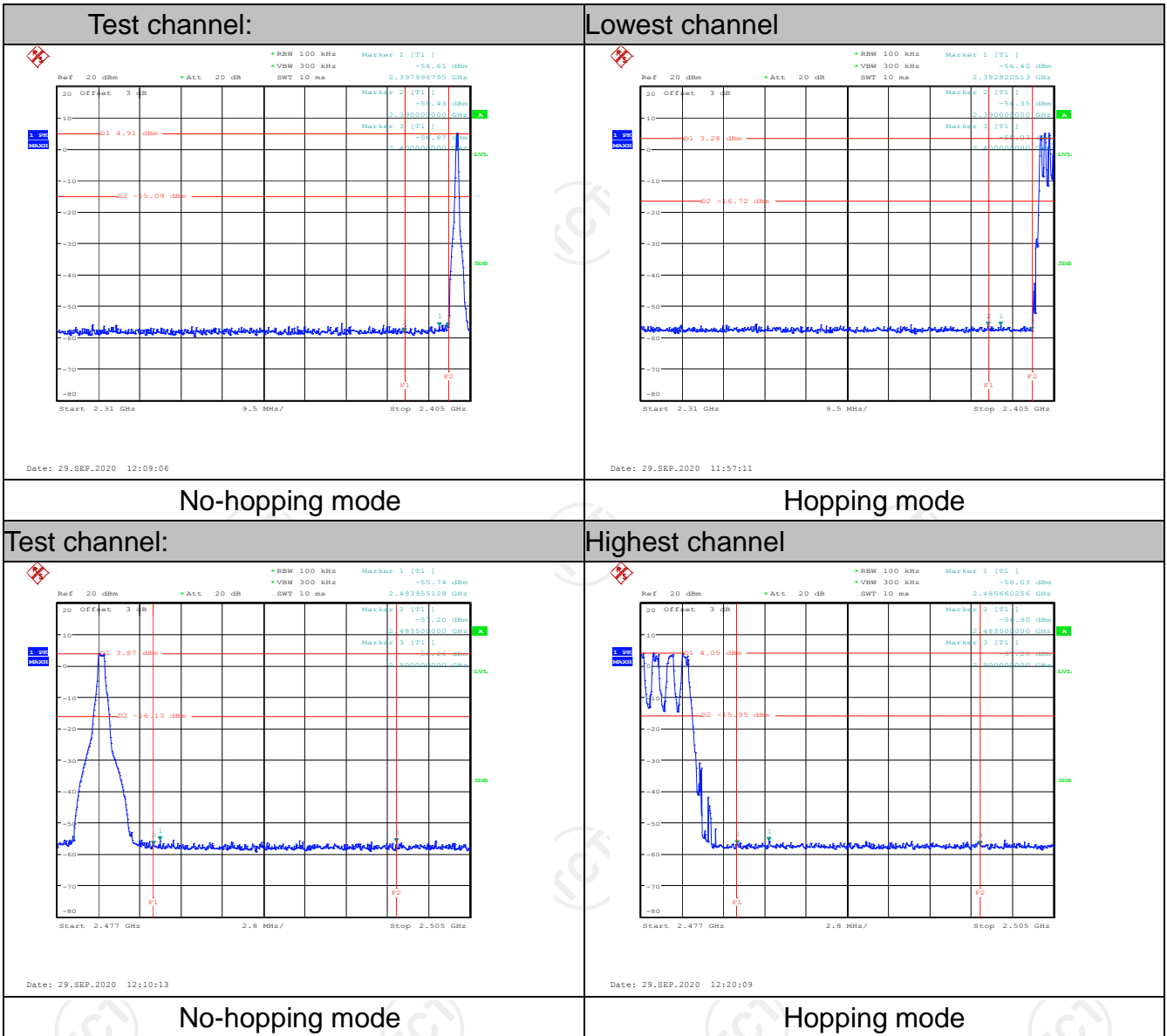

Pi/4DQPSK Modulation

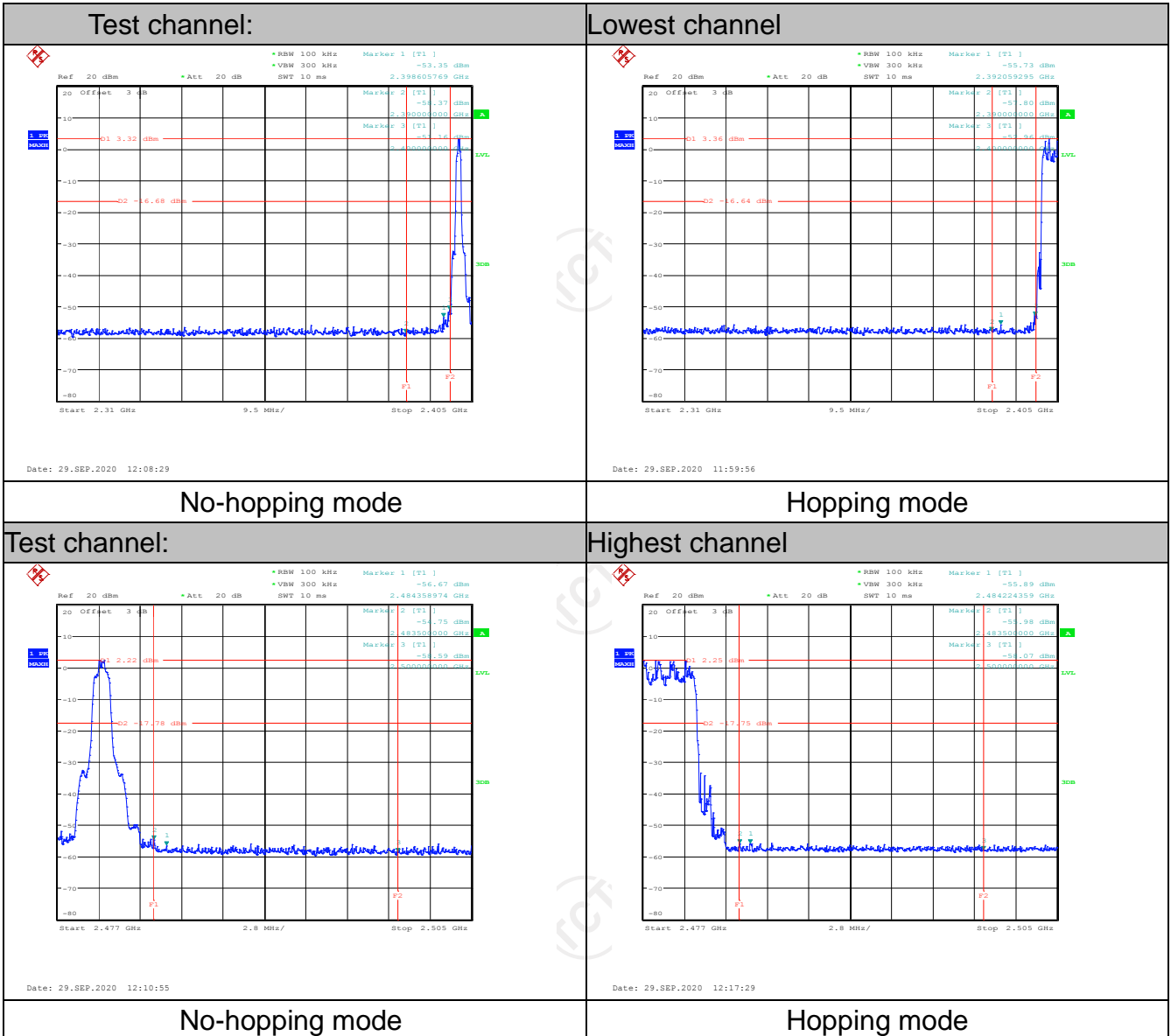

8DPSK Modulation

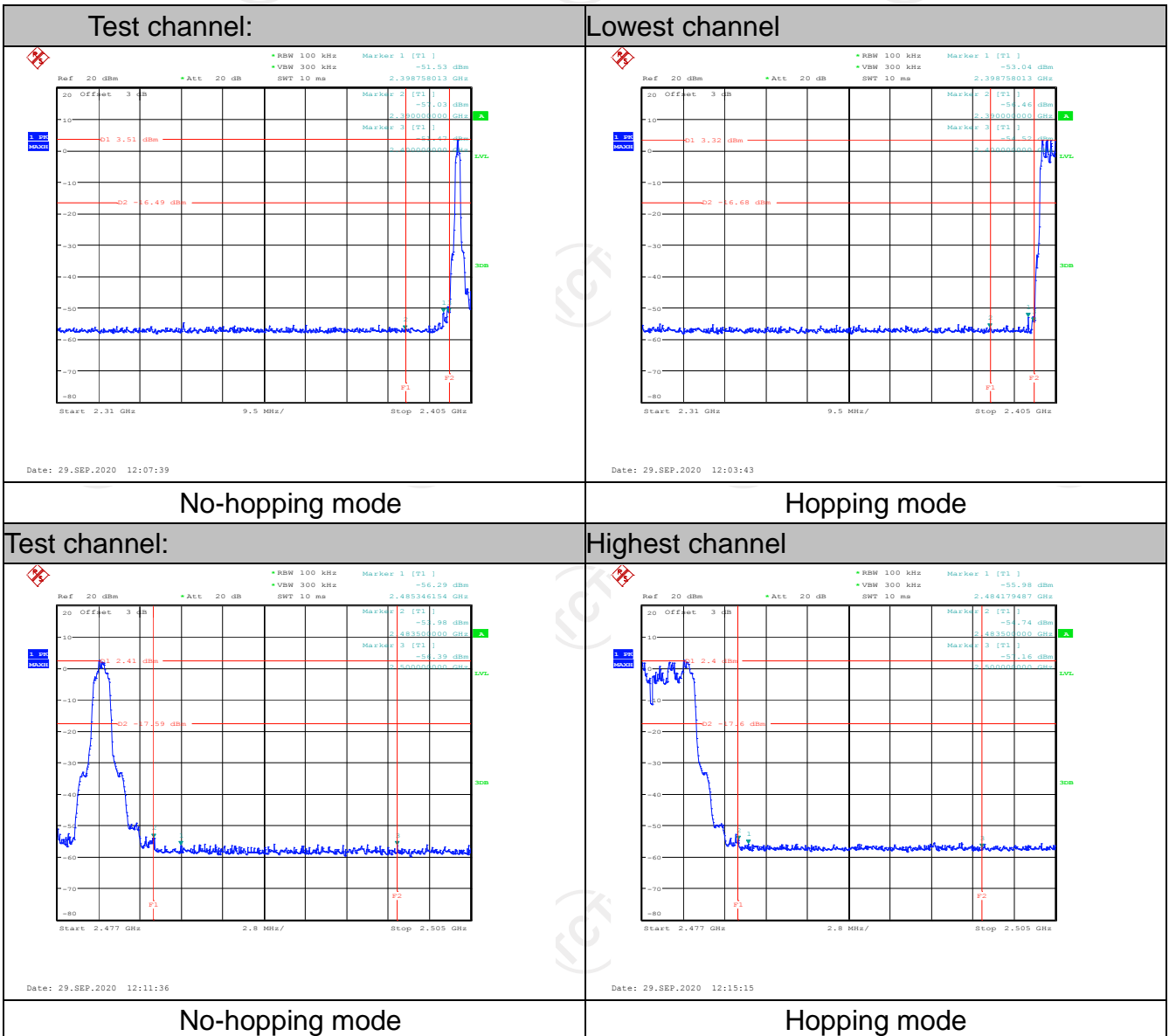

6.10. Conducted Spurious Emission Measurement

6.10.1. Test Specification

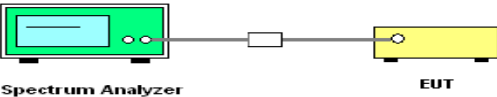
Test Requirement:	FCC Part15 C Section 15.247 (d)
Test Method:	KDB 558074 D01 v05r02
Limit:	In any 100 kHz bandwidth outside the intentional radiation frequency band, the radio frequency power shall be at least 20 dB below the highest level of the radiated power. In addition, radiated emissions which fall in the restricted bands must also comply with the radiated emission limits.
Test Setup:	 <p style="text-align: center;">Spectrum Analyzer EUT</p>
Test Mode:	Transmitting mode with modulation
Test Procedure:	<ol style="list-style-type: none"> 1. The RF output of EUT was connected to the spectrum analyzer by RF cable and attenuator. The path loss was compensated to the results for each measurement. 2. Set to the maximum power setting and enable the EUT transmit continuously. 3. Set RBW = 100 kHz, VBW = 300kHz, scan up through 10th harmonic. All harmonics / spurs must be at least 20 dB down from the highest emission level within the authorized band as measured with a 100 kHz RBW. 4. Measure and record the results in the test report. 5. The RF fundamental frequency should be excluded against the limit line in the operating frequency band.
Test Result:	PASS

6.10.2. Test Instruments

Equipment	Manufacturer	Model	Serial Number	Calibration Due
Spectrum Analyzer	R&S	FSU	200054	Sep. 11, 2021
Spectrum Analyzer	ROHDE&SCH WARZ	FSQ40	200061	Sep. 11, 2021
RF Cable (9KHz-26.5GHz)	TCT	RE-06	N/A	Sep. 11, 2021
Antenna Connector	TCT	RFC-01	N/A	Sep. 11, 2021

Note: The calibration interval of the above test instruments is 12 months and the calibrations are traceable to international system unit (SI).

6.10.3. Test Data

GFSK mode

Lowest Channel

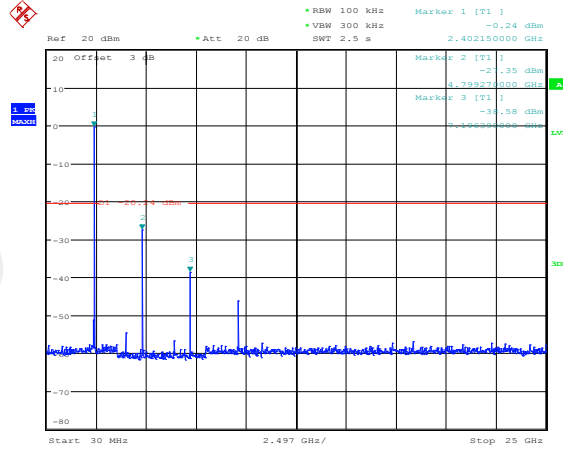

Date: 9.OCT.2020 15:08:06

Middle Channel

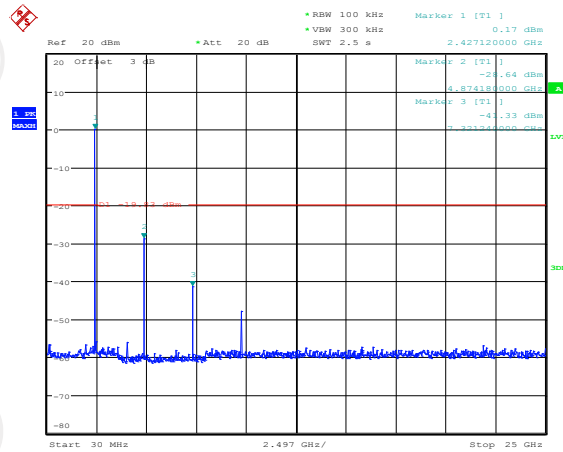

Date: 9.OCT.2020 14:55:55

Highest Channel

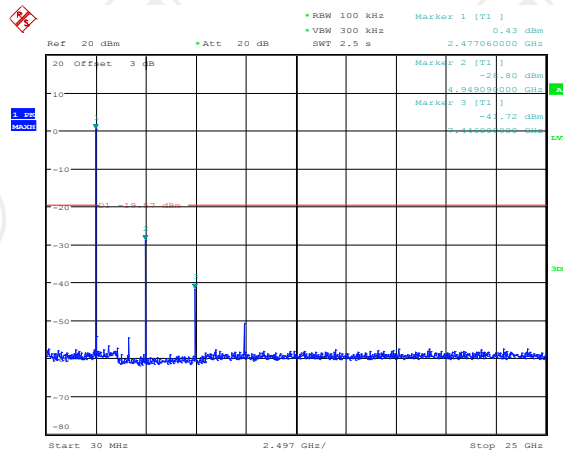

Date: 9.OCT.2020 15:02:44

Pi/4DQPSK mode

Lowest Channel

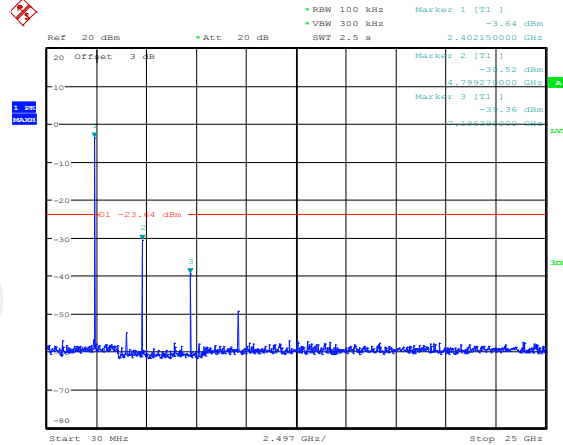

Middle Channel

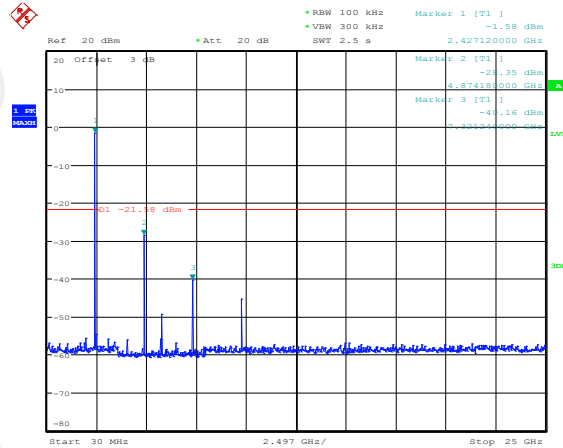

Highest Channel

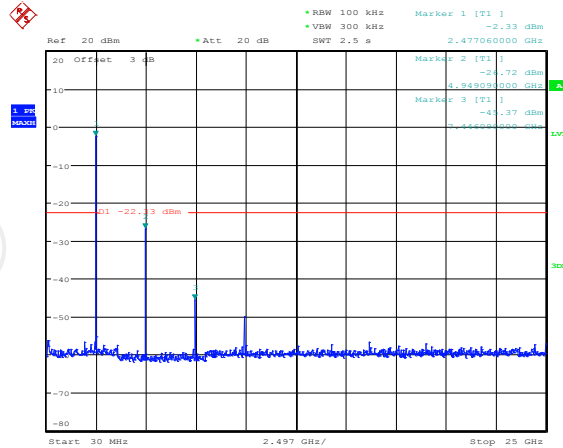

8DPSK mode

Lowest Channel

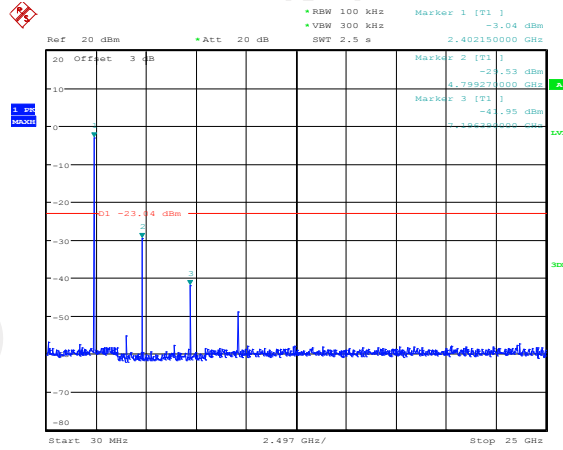

Date: 9.OCT.2020 15:03:51

Middle Channel

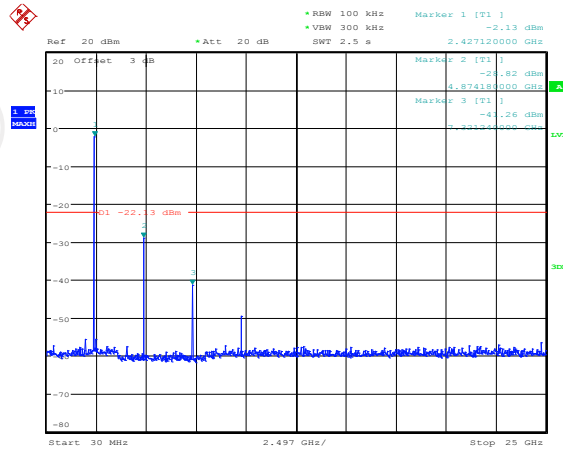

Date: 9.OCT.2020 15:09:05

Highest Channel

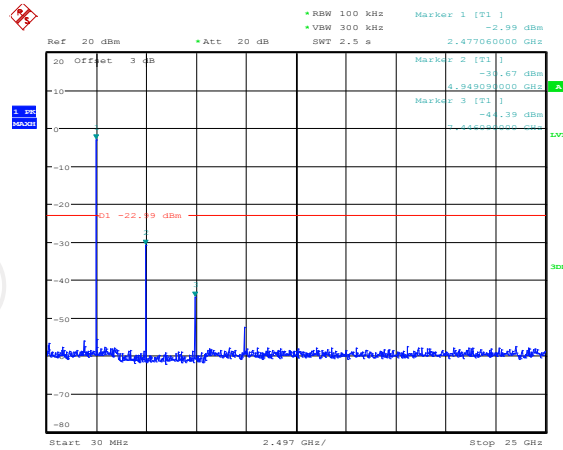

Date: 9.OCT.2020 15:01:26

6.11. Radiated Spurious Emission Measurement

6.11.1. Test Specification

Test Requirement:	FCC Part15 C Section 15.209																													
Test Method:	ANSI C63.10:2013																													
Frequency Range:	9 kHz to 25 GHz																													
Measurement Distance:	3 m																													
Antenna Polarization:	Horizontal & Vertical																													
Receiver Setup:	<table border="1"> <thead> <tr> <th>Frequency</th> <th>Detector</th> <th>RBW</th> <th>VBW</th> <th>Remark</th> </tr> </thead> <tbody> <tr> <td>9kHz- 150kHz</td> <td>Quasi-peak</td> <td>200Hz</td> <td>1kHz</td> <td>Quasi-peak Value</td> </tr> <tr> <td>150kHz- 30MHz</td> <td>Quasi-peak</td> <td>9kHz</td> <td>30kHz</td> <td>Quasi-peak Value</td> </tr> <tr> <td>30MHz-1GHz</td> <td>Quasi-peak</td> <td>120KHz</td> <td>300KHz</td> <td>Quasi-peak Value</td> </tr> <tr> <td rowspan="2">Above 1GHz</td> <td>Peak</td> <td>1MHz</td> <td>3MHz</td> <td>Peak Value</td> </tr> <tr> <td>Peak</td> <td>1MHz</td> <td>10Hz</td> <td>Average Value</td> </tr> </tbody> </table>	Frequency	Detector	RBW	VBW	Remark	9kHz- 150kHz	Quasi-peak	200Hz	1kHz	Quasi-peak Value	150kHz- 30MHz	Quasi-peak	9kHz	30kHz	Quasi-peak Value	30MHz-1GHz	Quasi-peak	120KHz	300KHz	Quasi-peak Value	Above 1GHz	Peak	1MHz	3MHz	Peak Value	Peak	1MHz	10Hz	Average Value
	Frequency	Detector	RBW	VBW	Remark																									
	9kHz- 150kHz	Quasi-peak	200Hz	1kHz	Quasi-peak Value																									
	150kHz- 30MHz	Quasi-peak	9kHz	30kHz	Quasi-peak Value																									
	30MHz-1GHz	Quasi-peak	120KHz	300KHz	Quasi-peak Value																									
Above 1GHz	Peak	1MHz	3MHz	Peak Value																										
	Peak	1MHz	10Hz	Average Value																										
Limit:	<table border="1"> <thead> <tr> <th>Frequency</th> <th>Field Strength (microvolts/meter)</th> <th>Measurement Distance (meters)</th> </tr> </thead> <tbody> <tr> <td>0.009-0.490</td> <td>2400/F(KHz)</td> <td>300</td> </tr> <tr> <td>0.490-1.705</td> <td>24000/F(KHz)</td> <td>30</td> </tr> <tr> <td>1.705-30</td> <td>30</td> <td>30</td> </tr> <tr> <td>30-88</td> <td>100</td> <td>3</td> </tr> <tr> <td>88-216</td> <td>150</td> <td>3</td> </tr> <tr> <td>216-960</td> <td>200</td> <td>3</td> </tr> <tr> <td>Above 960</td> <td>500</td> <td>3</td> </tr> </tbody> </table>	Frequency	Field Strength (microvolts/meter)	Measurement Distance (meters)	0.009-0.490	2400/F(KHz)	300	0.490-1.705	24000/F(KHz)	30	1.705-30	30	30	30-88	100	3	88-216	150	3	216-960	200	3	Above 960	500	3					
	Frequency	Field Strength (microvolts/meter)	Measurement Distance (meters)																											
	0.009-0.490	2400/F(KHz)	300																											
	0.490-1.705	24000/F(KHz)	30																											
	1.705-30	30	30																											
	30-88	100	3																											
	88-216	150	3																											
	216-960	200	3																											
	Above 960	500	3																											
	<table border="1"> <thead> <tr> <th>Frequency</th> <th>Field Strength (microvolts/meter)</th> <th>Measurement Distance (meters)</th> <th>Detector</th> </tr> </thead> <tbody> <tr> <td rowspan="2">Above 1GHz</td> <td>500</td> <td>3</td> <td>Average</td> </tr> <tr> <td>5000</td> <td>3</td> <td>Peak</td> </tr> </tbody> </table>	Frequency	Field Strength (microvolts/meter)	Measurement Distance (meters)	Detector	Above 1GHz	500	3	Average	5000	3	Peak																		
Frequency	Field Strength (microvolts/meter)	Measurement Distance (meters)	Detector																											
Above 1GHz	500	3	Average																											
	5000	3	Peak																											
Test setup:	For radiated emissions below 30MHz																													
	<p>30MHz to 1GHz</p>																													

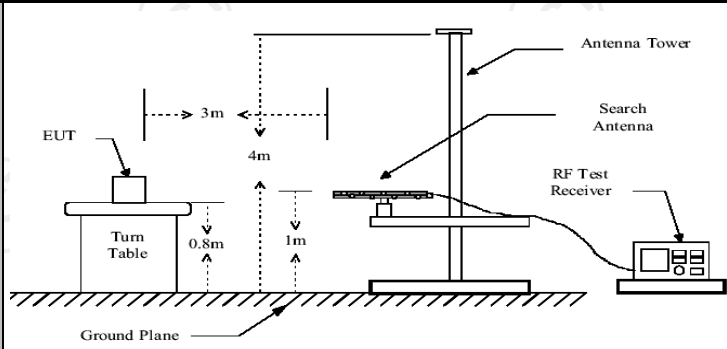

Above 1GHz

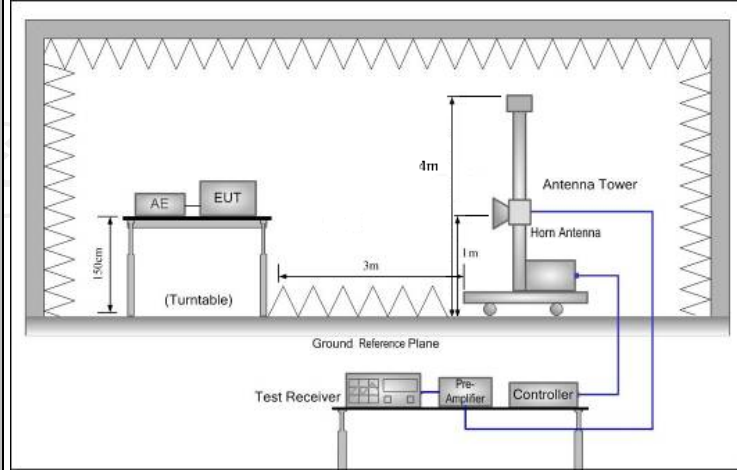

Test Mode:

Transmitting mode with modulation

Test Procedure:

1. The testing follows the guidelines in Spurious Radiated Emissions of ANSI C63.10:2013 Measurement Guidelines.
2. For the radiated emission test below 1GHz:
The EUT was placed on a turntable with 0.8 meter above ground. The EUT was set 3 meters from the interference receiving antenna, which was mounted on the top of a variable height antenna tower. The EUT was arranged to its worst case and then tune the antenna tower (from 1 m to 4 m) and turntable (from 0 degree to 360 degrees) to find the maximum reading. A pre-amp and a high PASS filter are used for the test in order to get better signal level.
For the radiated emission test above 1GHz:
Place the measurement antenna on a turntable with 1.5 meter above ground, which is away from each area of the EUT determined to be a source of emissions at the specified measurement distance, while keeping the measurement antenna aimed at the source of emissions at each frequency of significant emissions, with polarization oriented for maximum response. The measurement antenna may have to be higher or lower than the EUT, depending on the radiation pattern of the emission

	<p>and staying aimed at the emission source for receiving the maximum signal. The final measurement antenna elevation shall be that which maximizes the emissions. The measurement antenna elevation for maximum emissions shall be restricted to a range of heights of from 1 m to 4 m above the ground or reference ground plane.</p> <p>3. Set to the maximum power setting and enable the EUT transmit continuously.</p> <p>4. Use the following spectrum analyzer settings:</p> <p>(1) Span shall wide enough to fully capture the emission being measured;</p> <p>(2) Set RBW=120 kHz for $f < 1$ GHz, RBW=1MHz for $f > 1$GHz ; VBW\geqRBW; Sweep = auto; Detector function = peak; Trace = max hold for peak</p> <p>(3) For average measurement: use duty cycle correction factor method per 15.35(c). Duty cycle = On time/100 milliseconds On time = $N_1 * L_1 + N_2 * L_2 + \dots + N_{n-1} * L_{n-1} + N_n * L_n$ Where N_1 is number of type 1 pulses, L_1 is length of type 1 pulses, etc. Average Emission Level = Peak Emission Level + $20 * \log(\text{Duty cycle})$ Corrected Reading: Antenna Factor + Cable Loss + Read Level - Preamp Factor = Level</p>
Test results:	PASS

6.11.2. Test Instruments

Radiated Emission Test Site (966)				
Name of Equipment	Manufacturer	Model	Serial Number	Calibration Due
Test Receiver	ROHDE&SCHW ARZ	ESIB7	100197	Jul. 27, 2021
Spectrum Analyzer	ROHDE&SCHW ARZ	FSQ40	200061	Sep. 11, 2021
Pre-amplifier	EM Electronics Corporation CO.,LTD	EM30265	07032613	Sep. 02, 2021
Pre-amplifier	HP	8447D	2727A05017	Sep. 02, 2021
Loop antenna	ZHINAN	ZN30900A	12024	Sep. 05, 2022
Broadband Antenna	Schwarzbeck	VULB9163	340	Sep. 04, 2022
Horn Antenna	Schwarzbeck	BBHA 9120D	631	Sep. 04, 2022
Horn Antenna	A-INFO	LB-180400-KF	J211020657	Sep. 04, 2022
Antenna Mast	Keleto	RE-AM	N/A	N/A
Line-4	RE-high-04	TCT	N/A	Sep. 02, 2021
Line-8	RE-01	TCT	N/A	Jul. 27, 2021
EMI Test Software	Shurple Technology	EZ-EMC	N/A	N/A

Note: The calibration interval of the above test instruments is 12 months and the calibrations are traceable to international system unit (SI).

6.11.3. Test Data

Duty cycle correction factor for average measurement

3DH5 on time (One Pulse) Plot on Channel 00

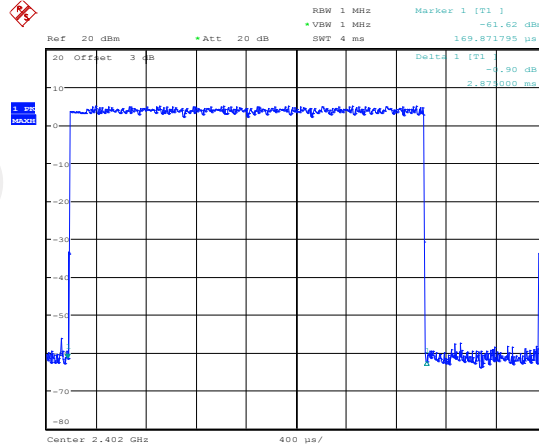

Date: 29.SEP.2020 11:26:56

3DH5 on time (Count Pulses) Plot on Channel 00

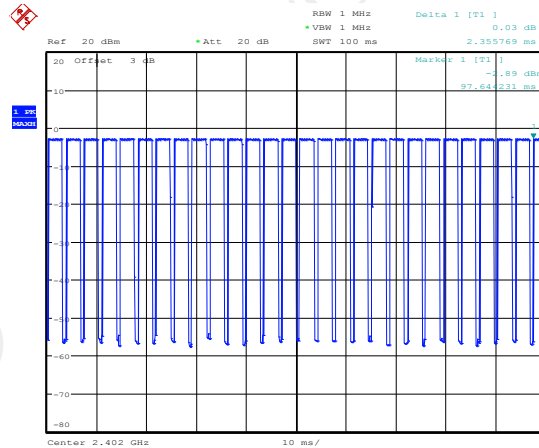

Date: 9.OCT.2020 14:43:37

Note:

1. Worst case Duty cycle = on time/100 milliseconds = $(2.875 \times 28 + 2.356) / 100 = 0.8286$
2. Worst case Duty cycle correction factor = $20 \times \log(\text{Duty cycle}) = -1.63\text{dB}$
3. 3DH5 has the highest duty cycle worst case and is reported.
4. The average levels were calculated from the peak level corrected with duty cycle correction factor (-1.63dB) derived from $20 \log(\text{dwell time}/100\text{ms})$. This correction is only for signals that hop with the fundamental signal, such as band-edge and harmonic. Other spurious signals that are independent of the hopping signal would not use this correction.

Please refer to following diagram for individual

Below 1GHz

Horizontal:

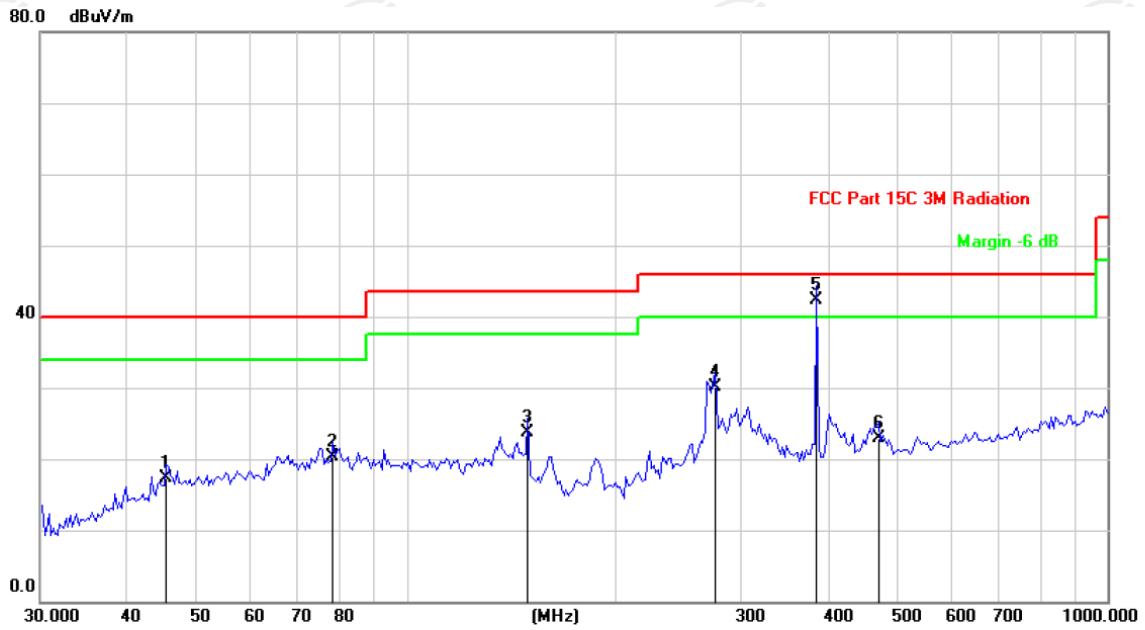

Site: Polarization: **Horizontal** Temperature: 25
Limit: FCC Part 15C 3M Radiation Power: AC 120V/60Hz Humidity: 55 %

No.	Mk.	Freq. MHz	Reading Level dBuV	Correct Factor dB	Measure- ment dBuV/m	Limit dB/m	Over dB	Detector
1		45.4130	27.77	-10.49	17.28	40.00	-22.72	QP
2		78.5644	36.82	-16.55	20.27	40.00	-19.73	QP
3		148.9173	39.90	-16.24	23.66	43.50	-19.84	QP
4		276.3817	41.86	-11.69	30.17	46.00	-15.83	QP
5	*	384.5446	51.57	-9.18	42.39	46.00	-3.61	QP
6		471.4664	30.92	-7.92	23.00	46.00	-23.00	QP

Vertical:

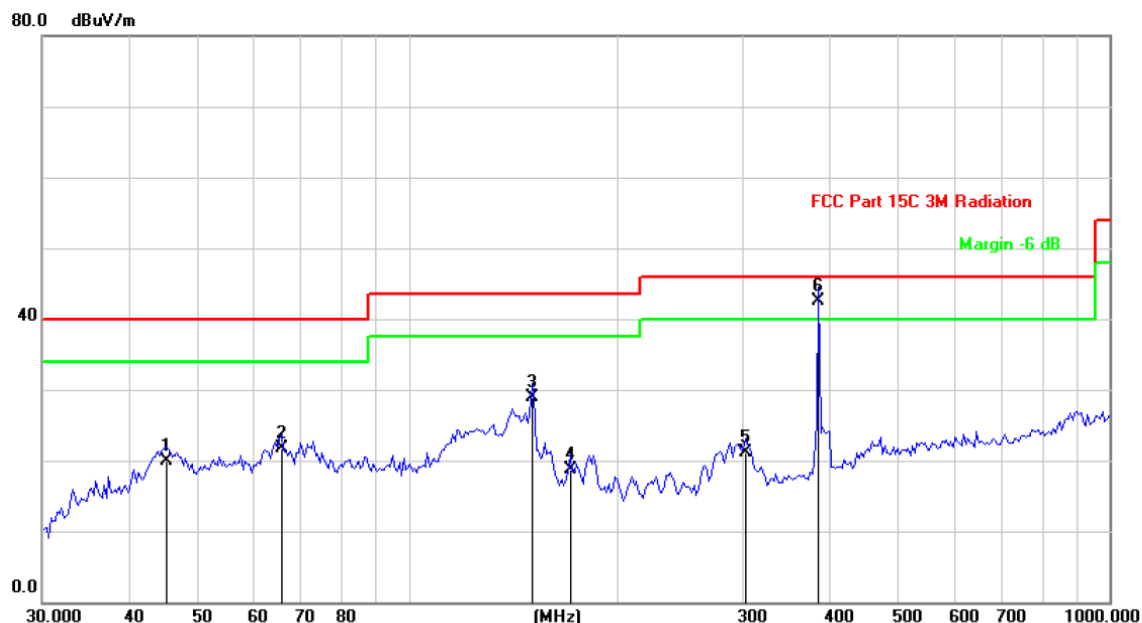

Site: Polarization: **Vertical** Temperature: 25
 Limit: FCC Part 15C 3M Radiation Power: AC 120V/60Hz Humidity: 55 %

No.	Mk.	Freq. MHz	Reading Level dBuV	Correct Factor dB	Measure- ment dBuV/m	Limit dB/m	Over dB	Detector
1		45.0951	30.48	-10.52	19.96	40.00	-20.04	QP
2		65.9067	36.03	-14.31	21.72	40.00	-18.28	QP
3		149.9676	45.07	-16.26	28.81	43.50	-14.69	QP
4		170.1887	34.00	-15.35	18.65	43.50	-24.85	QP
5		302.8192	32.00	-10.85	21.15	46.00	-24.85	QP
6	*	384.5446	51.77	-9.18	42.59	46.00	-3.41	QP

Note: 1. The low frequency, which started from 9KHz~30MHz, was pre-scanned and the result which was 20dB lower than the limit line per 15.31(o) was not reported
 2. Measurements were conducted in all three channels (high, middle, low) and three modulation (GFSK, Pi/4 DQPSK, 8DPSK) and the worst case Mode (middle channel and 8DPSK) was submitted only.
 3. Freq. = Emission frequency in MHz
 Measurement (dBuV/m) = Reading level (dBuV) + Corr. Factor (dB)
 Correction Factor = Antenna Factor + Cable loss - Pre-amplifier
 Limit (dBuV/m) = Limit stated in standard
 Over (dB) = Measurement (dBuV/m) - Limits (dBuV/m)
 Any value more than 10dB below limit have not been specifically reported.
 * is meaning the worst frequency has been tested in the test frequency range

Test Result of Radiated Spurious at Band edges

Lowest channel 2402:

Horizontal:

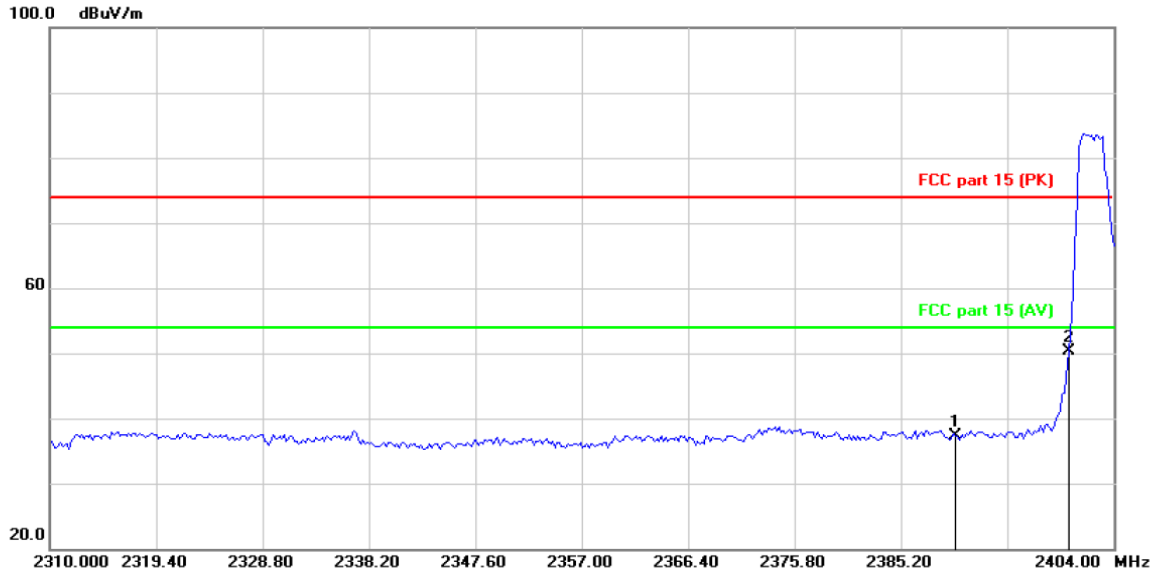

Site: Polarization: **Horizontal** Temperature: 25
Limit: FCC part 15 (PK) Power: Humidity: 55 %

Vertical:

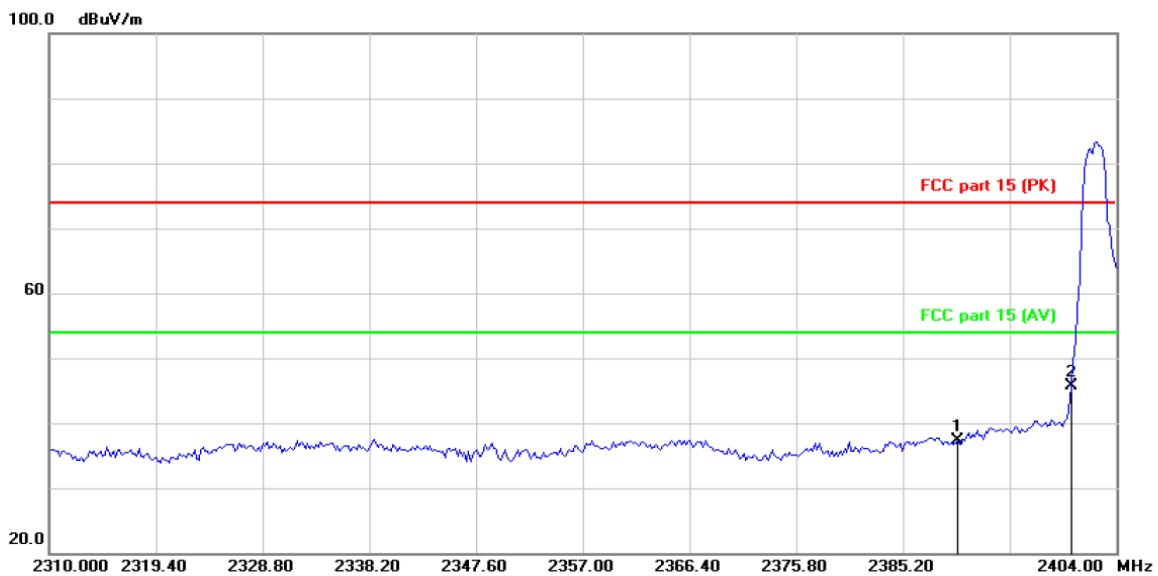

Site: Polarization: **Vertical** Temperature: 25
Limit: FCC part 15 (PK) Power: Humidity: 55 %

Frequency (MHz)	Ant. Pol. H/V	Peak (dBuV/m)	Dutycycle factor (dB/m)	AV (dBuV/m)	Peak limit (dBuV/m)	AV limit (dBuV/m)	PK Margin (dB)	AVG Margin (dB)
2390	H	37.27	-1.63	35.64	74	54	-36.73	-18.36
2390	V	39.39	-1.63	37.76	74	54	-34.61	-16.24
2400	H	50.30	-1.63	48.67	74	54	-23.70	-5.33
2400	V	48.69	-1.63	47.06	74	54	-25.31	-6.94

Highest channel 2480:
Horizontal:

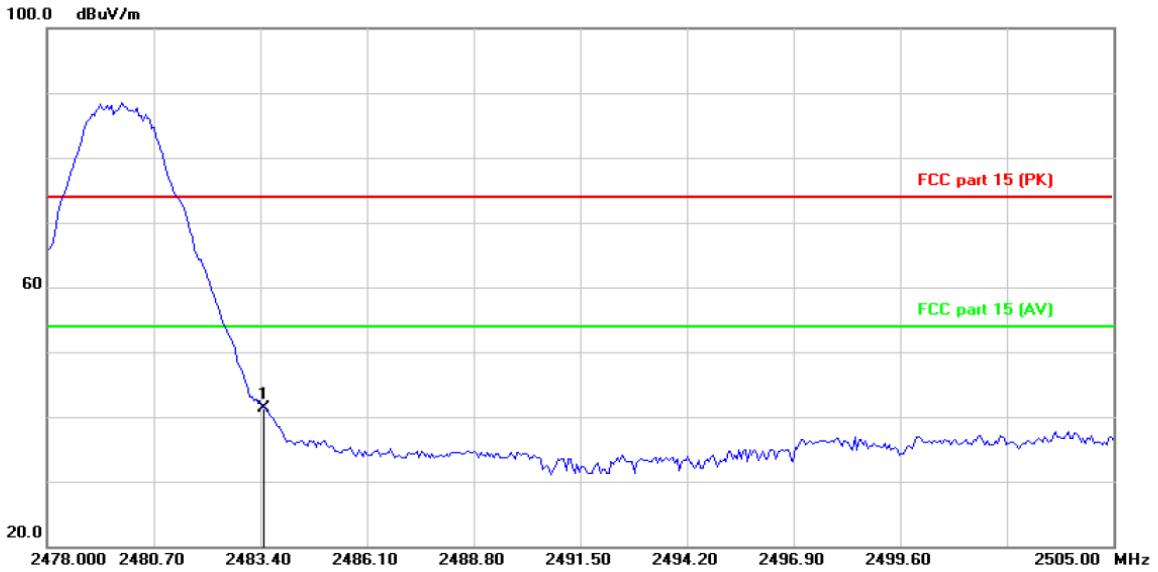

Site: Polarization: **Horizontal** Temperature: 25
Limit: FCC part 15 (PK) Power: Humidity: 55 %

Vertical:

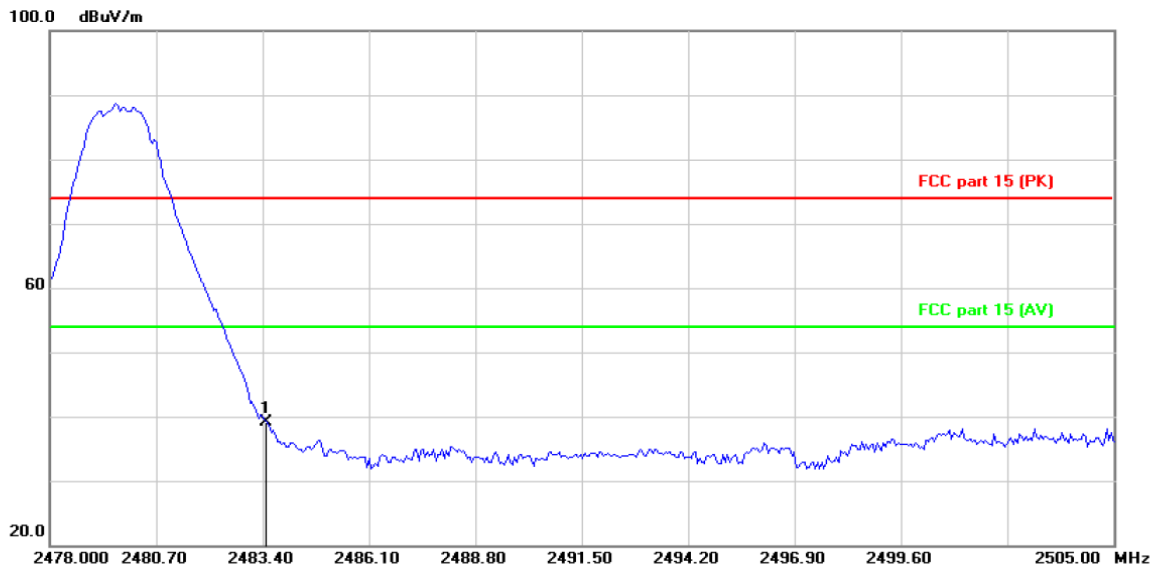

Site: Polarization: **Vertical** Temperature: 25
Limit: FCC part 15 (PK) Power: Humidity: 55 %

Frequency (MHz)	Ant. Pol. H/V	Peak (dB μ V/m)	Dutycycle factor (dB/m)	AV (dB μ V/m)	Peak limit (dB μ V/m)	AV limit (dB μ V/m)	PK Margin (dB)	AVG Margin (dB)
2483.5	H	41.35	-1.63	39.72	74	54	-32.65	-14.28
2483.5	V	39.19	-1.63	37.56	74	54	-34.81	-16.44

Note: Measurements were conducted in all three modulation (GFSK, Pi/4 DQPSK, 8DPSK), and the worst case Mode (8DPSK) was submitted only.

Above 1GHz

Modulation Type: 8DPSK									
Low channel: 2402 MHz									
Frequency (MHz)	Ant. Pol. H/V	Peak reading (dB μ V)	AV reading (dB μ V)	Correction Factor (dB/m)	Emission Level		Peak limit (dB μ V/m)	AV limit (dB μ V/m)	Margin (dB)
					Peak (dB μ V/m)	AV (dB μ V/m)			
4804	H	45.66	---	0.66	46.32	---	74	54	-7.68
7206	H	36.92	---	9.5	46.42	---	74	54	-7.58
---	H	---	---	---	---	---	---	---	---
4804	V	44.39	---	0.66	45.05	---	74	54	-8.95
7206	V	37.91	---	9.5	47.41	---	74	54	-6.59
---	V	---	---	---	---	---	---	---	---

Middle channel: 2441 MHz									
Frequency (MHz)	Ant. Pol. H/V	Peak reading (dB μ V)	AV reading (dB μ V)	Correction Factor (dB/m)	Emission Level		Peak limit (dB μ V/m)	AV limit (dB μ V/m)	Margin (dB)
					Peak (dB μ V/m)	AV (dB μ V/m)			
4882	H	47.87	---	0.99	48.86	---	74	54	-5.14
7323	H	38.34	---	9.87	48.21	---	74	54	-5.79
---	H	---	---	---	---	---	---	---	---
4882	V	46.55	---	0.99	47.54	---	74	54	-6.46
7323	V	38.93	---	9.87	48.80	---	74	54	-5.20
---	V	---	---	---	---	---	---	---	---

High channel: 2480 MHz									
Frequency (MHz)	Ant. Pol. H/V	Peak reading (dB μ V)	AV reading (dB μ V)	Correction Factor (dB/m)	Emission Level		Peak limit (dB μ V/m)	AV limit (dB μ V/m)	Margin (dB)
					Peak (dB μ V/m)	AV (dB μ V/m)			
4960	H	46.19	---	1.33	47.52	---	74	54	-6.48
7440	H	36.38	---	10.22	46.60	---	74	54	-7.40
---	H	---	---	---	---	---	---	---	---
4960	V	48.44	---	1.33	49.77	---	74	54	-4.23
7440	V	36.57	---	10.22	46.79	---	74	54	-7.21
---	V	---	---	---	---	---	---	---	---

Note:

1. Emission Level=Peak Reading + Correction Factor; Correction Factor=Antenna Factor + Cable loss – Pre-amplifier
2. Margin (dB) = Emission Level (Peak) (dB μ V/m)-Average limit (dB μ V/m)
3. The emission levels of other frequencies are very lower than the limit and not show in test report.
4. Measurements were conducted from 1 GHz to the 10th harmonic of highest fundamental frequency.
5. Data of measurement shown “---“in the above table mean that the reading of emissions is attenuated more than 20 dB below the limits or the field strength is too small to be measured.
6. Measurements were conducted in all three modulation (GFSK, Pi/4 DQPSK, 8DPSK), and the worst case Mode (8DPSK) was submitted only.
7. All the restriction bands are compliance with the limit of 15.209.

Appendix A: Photographs of Test Setup

Product: Tablet PC
Model: SophPad X11
Radiated Emission

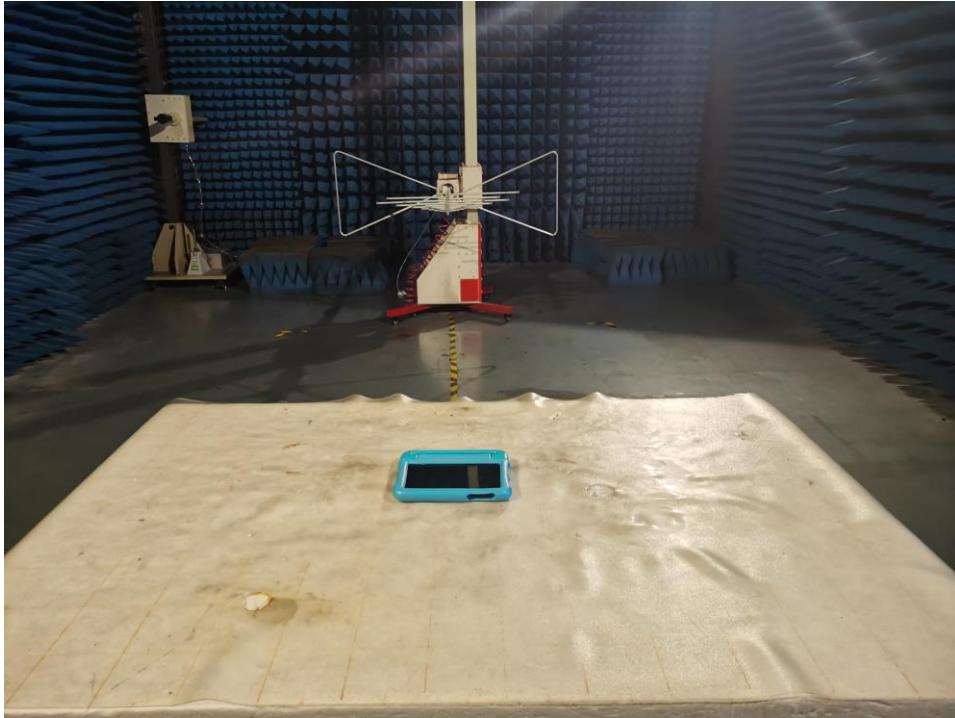

Conducted Emission



Appendix B: Photographs of EUT

Product: Tablet PC

Model: SophPad X11

External Photos

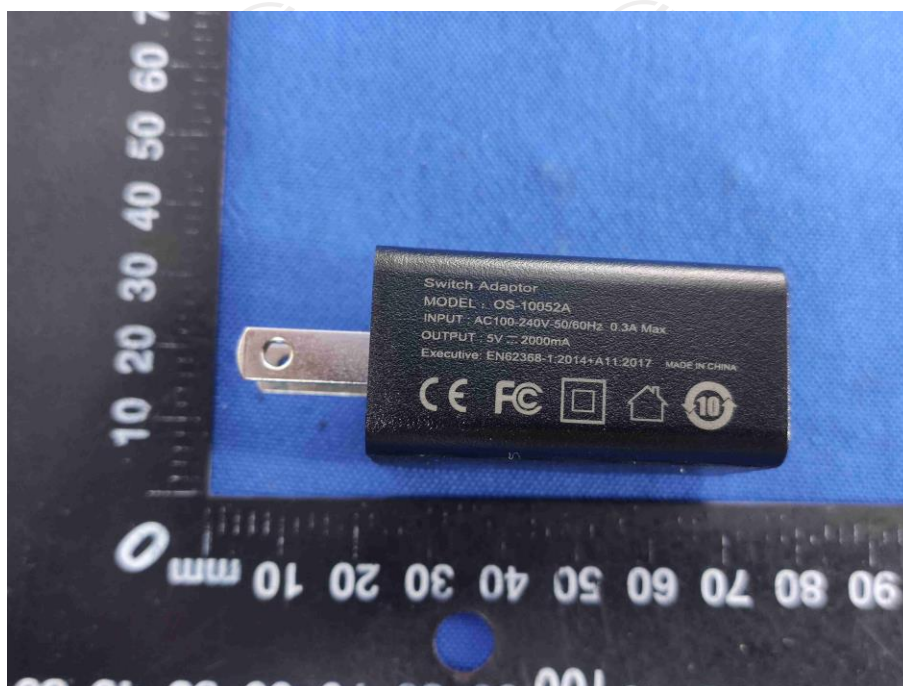



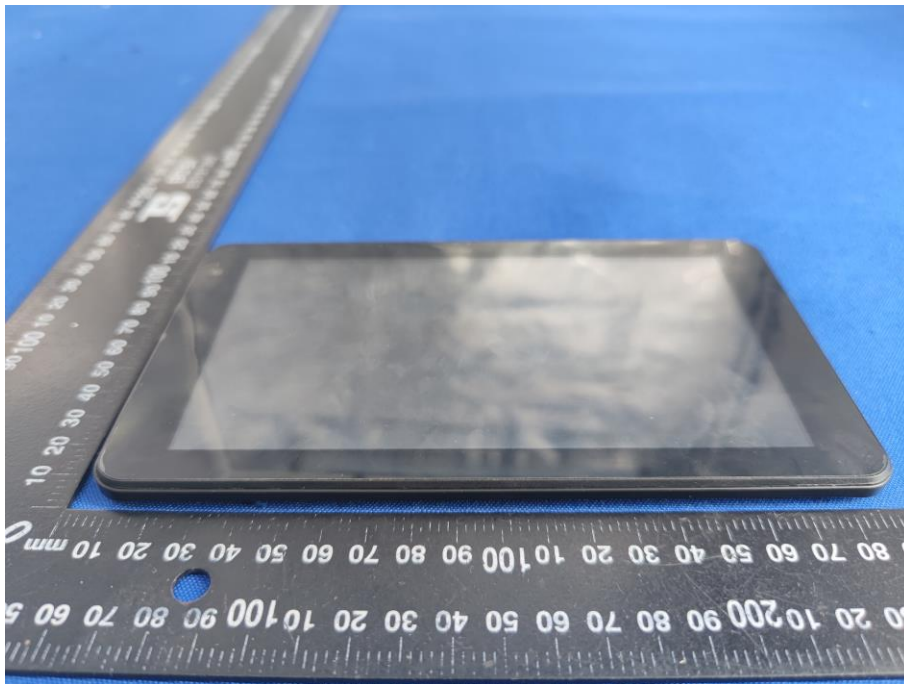

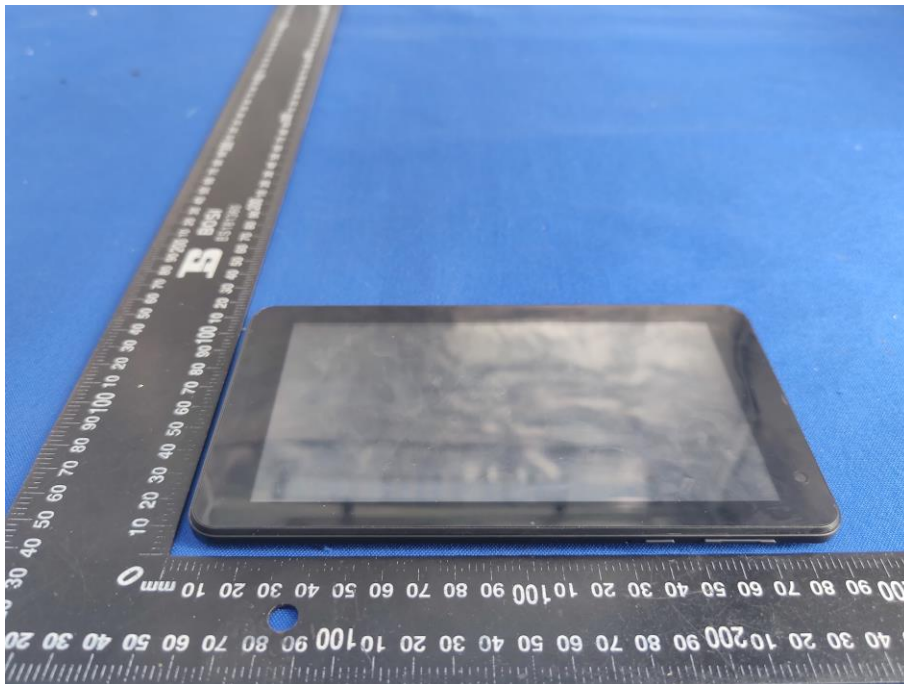
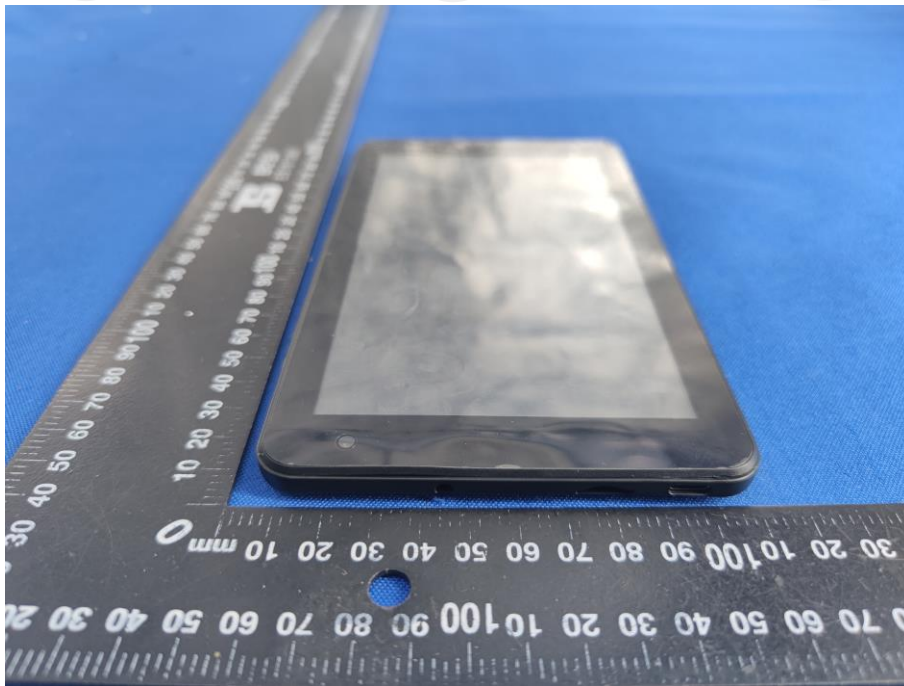

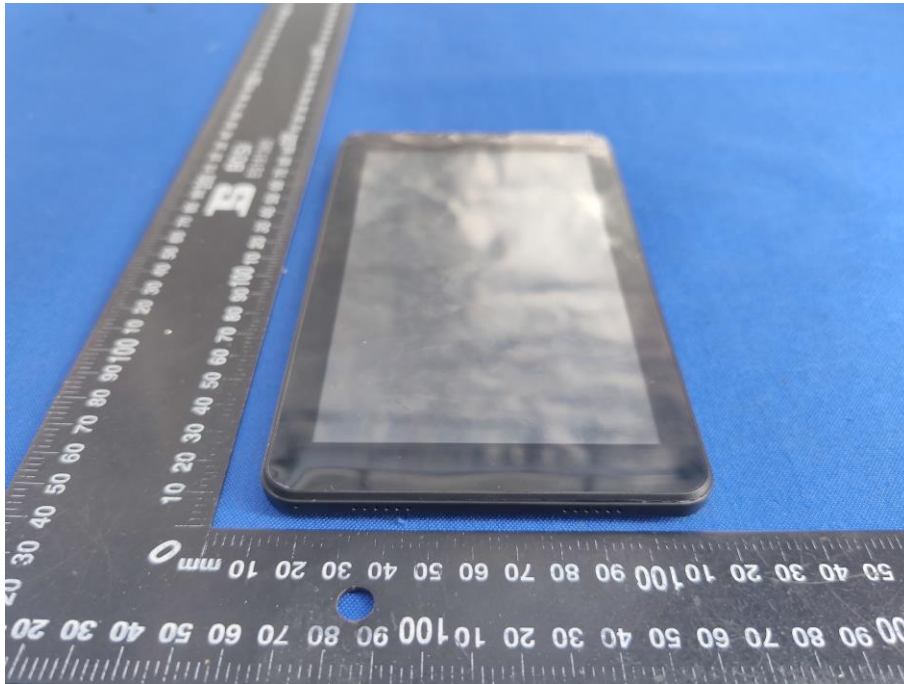

Product: Tablet PC
Model: SophPad X11
Internal Photos

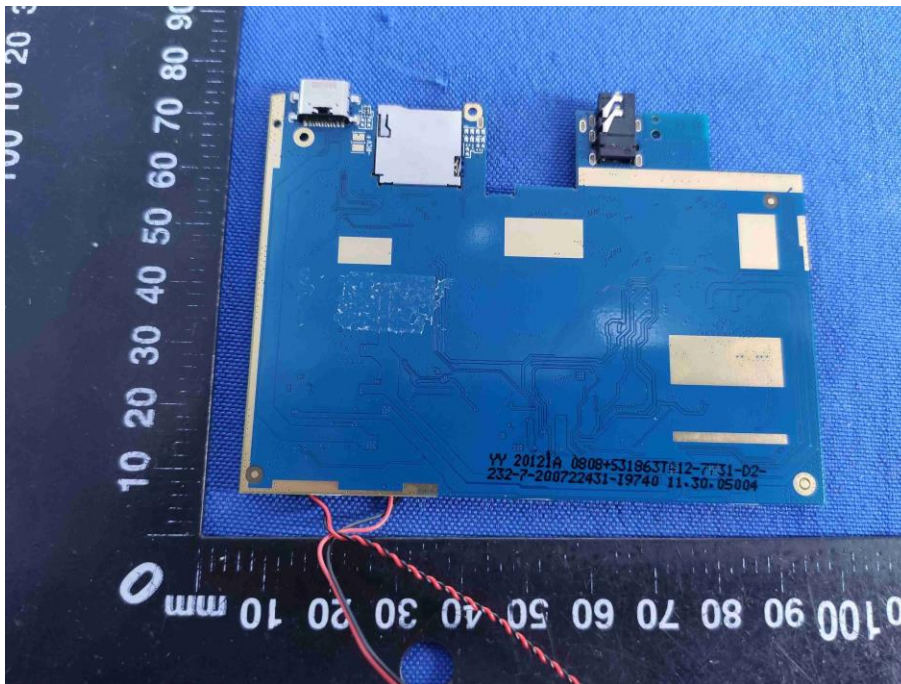

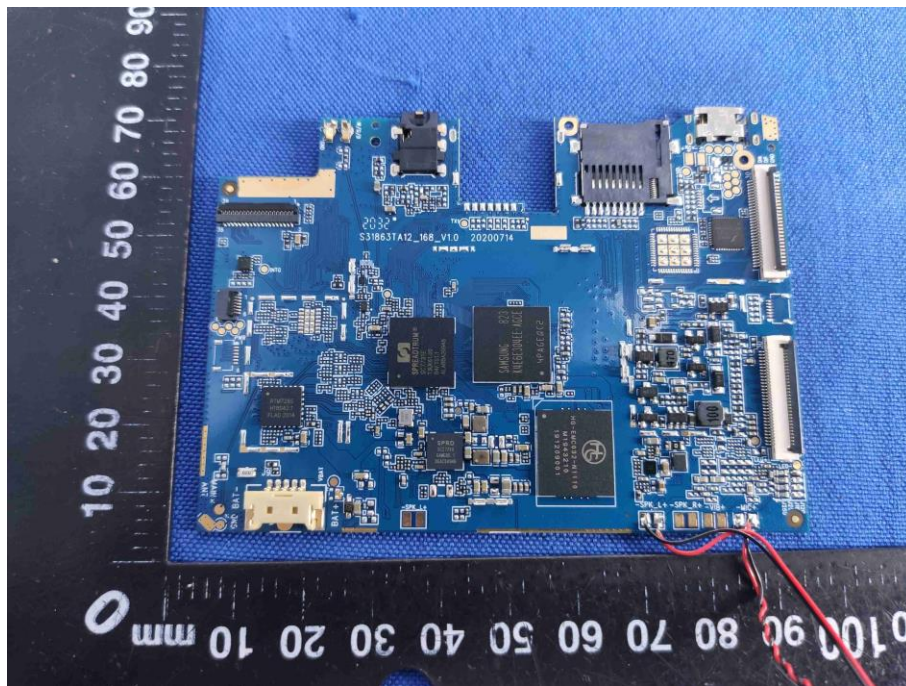
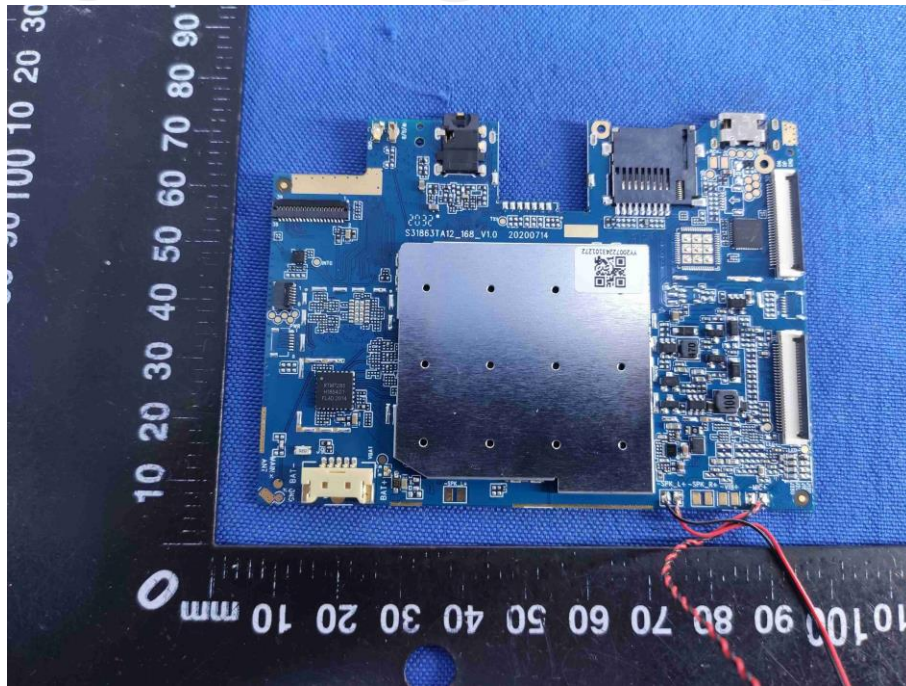

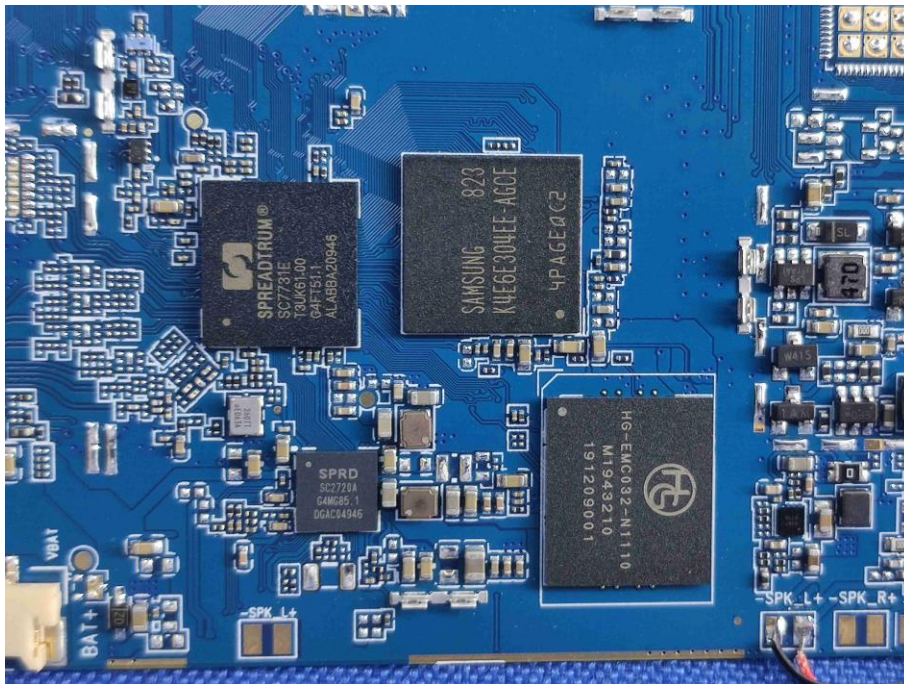
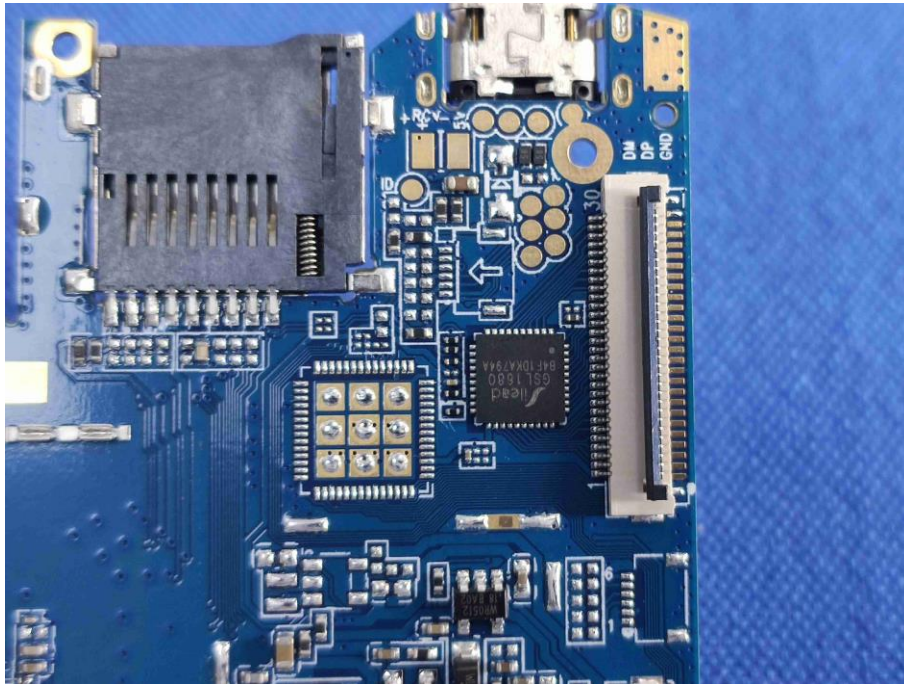

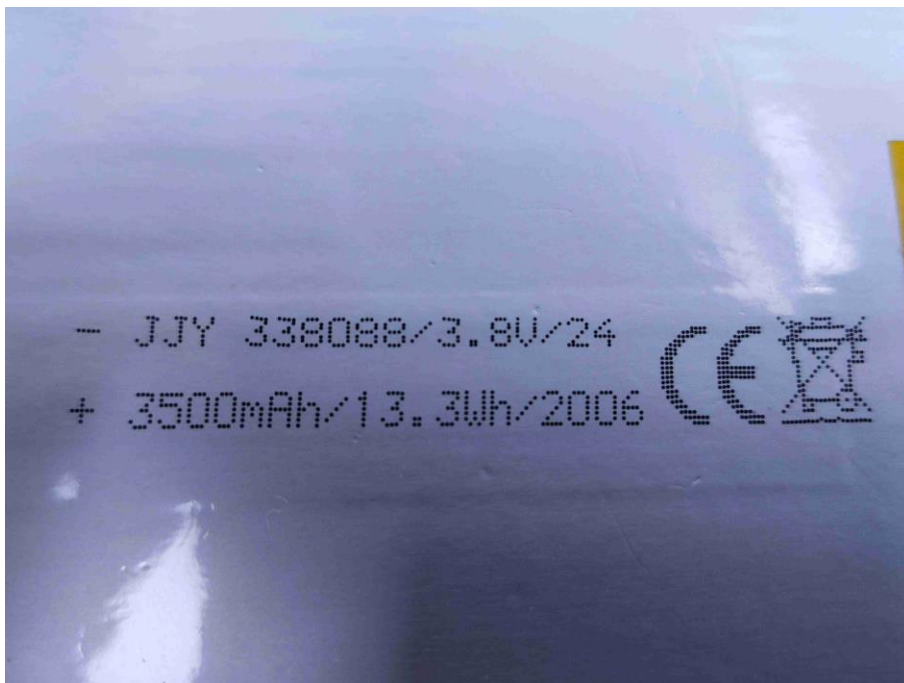
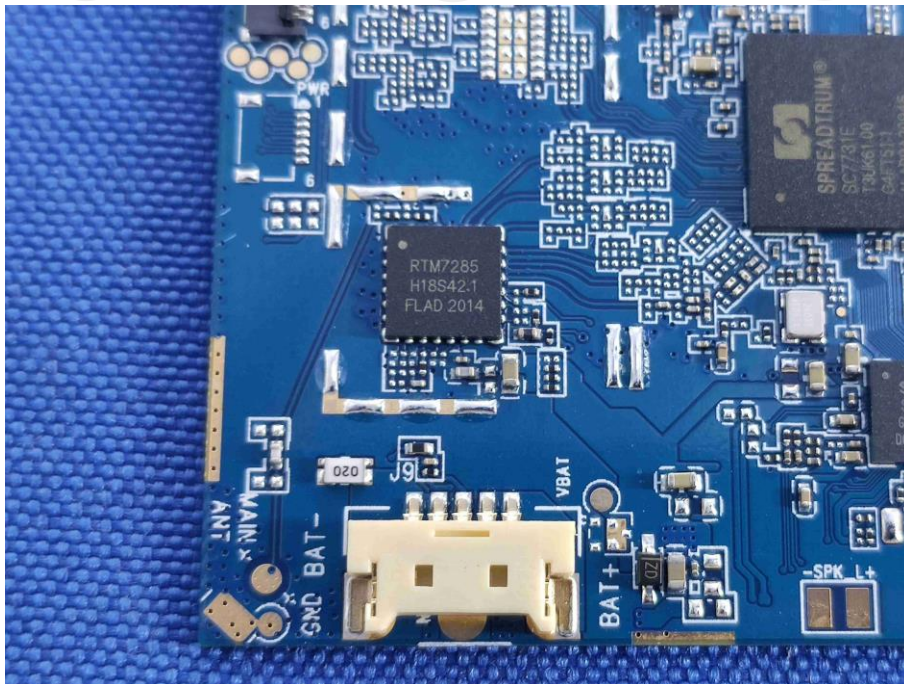

*******END OF REPORT*******