



Shenzhen GTI Technology Co., Ltd.

1F,2 Block, Jiaquan Building, Guanlan High-tech Park Baoan District,
Shenzhen, Guangdong, China.

Tel: +86-755-27559792

Fax: +86-755-86116468

Report No.: GTI20150050F-2

Page 1 of 62

TEST REPORT

Product Name: 10.1" Tablet PC

Trademark: Dragon Touch

Model/Type reference: A1X PLUS

Listed Model(s): /

FCC ID.....: S5V-D10A2X

Test Standards: **FCC Part 15.247: Operation within the bands 902-928 MHz, 2400-2483.5 MHz and 5725-5850 MHz**

Applicant: Proexpress Distributor LLC

Address of applicant: 11011 Greenwood Ave N 11011 Greenwood Ave N, Seattle, WA, United States

Date of Receipt: Jan. 25, 2015

Date of Test Date.....: Jan. 25, 2015 - Feb. 05, 2015

Data of issue.: Feb. 06, 2015

Test result	Pass *
--------------------	---------------

* In the configuration tested, the EUT complied with the standards specified above

GENERAL DESCRIPTION OF EUT	
Equipment:	10.1" Tablet PC
Model Name:	A1X PLUS
Manufacturer:	Shenzhen Modex Technology Co.,Ltd.
Manufacturer Address:	Add:No.1 Rd1 Shangxue Technology Park,Longgang District Shenzhen,China
Power Rating:	DC 3.7V form 5000mAh by rechargeable battery or DC 5.0V form Input:100-240V~,50/60Hz adapter Output: 5.0V===2000mA

Compiled By:



(Allen Wang)

Reviewed By:

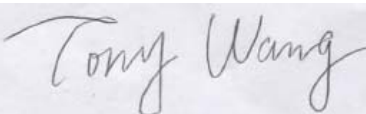

(Tony Wang)

Approved By:

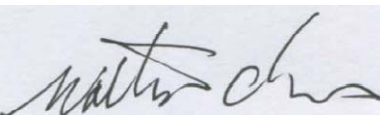

(Walter Chen)

This test report consists of 62 pages in total. It may be duplicated completely for legal use with the approval of the applicant. It should not be reproduced except in full, without the written approval of our laboratory. The client should not use it to claim product endorsement by GTI. The test results in the report only apply to the tested sample. The test report shall be invalid without all the signatures of compiler, reviewer and approver. Any objections must be raised to GTI within 15 days since the date when the report is received. It will not be taken into consideration beyond this limit.



Table of Contents

Page

1. SUMMARY.....	4
1.1. TEST STANDARDS.....	4
1.2. TEST DESCRIPTION.....	4
1.3. TEST FACILITY.....	5
1.4. MEASUREMENT UNCERTAINTY.....	5
2. GENERAL INFORMATION.....	6
2.1. ENVIRONMENTAL CONDITIONS.....	6
2.2. GENERAL DESCRIPTION OF EUT.....	6
2.3. DESCRIPTION OF TEST MODES.....	7
2.4. MEASUREMENT INSTRUMENTS LIST.....	7
3. TEST CONDITIONS AND RESULTS.....	9
3.1. CONDUCTED EMISSION (AC MAIN).....	9
3.2. RADIATED EMISSION.....	12
3.3. MAXIMUM PEAK OUTPUT POWER.....	17
3.4. 20dB BANDWIDTH.....	21
3.5. BAND EDGE.....	25
3.6. FREQUENCY SEPARATION.....	41
3.7. NUMBER OF HOPPING FREQUENCY.....	43
3.8. TIME OF OCCUPANCY (DWELL TIME).....	45
3.9. SPURIOUS RF CONDUCTED EMISSION.....	49
3.10. PSEUDORANDOM FREQUENCY HOPPING SEQUENCE.....	59
3.11. ANTENNA REQUIREMENT.....	60
4. EUT TEST PHOTO.....	61
5. PHOTOGRAPHS OF EUT CONSTRUCTIONAL.....	61

1. SUMMARY

1.1. Test Standards

The tests were performed according to following standards:

[FCC Rules Part 15.247](#): Frequency Hopping, Direct Spread Spectrum and Hybrid Systems that are in operation within the bands of 902-928 MHz, 2400-2483.5 MHz, and 5725-5850 MHz

[ANSI C63.10-2009](#): American National Standard for Testing Unlicensed Wireless Devices

1.2. Test Description

FCC PART 15 15.247		
FCC Part 15.207	AC Power Conducted Emission	PASS
FCC Part 15.247(a)(1)(i)	20dB Bandwidth	PASS
FCC Part 15.247(d)	Spurious RF Conducted Emission	PASS
FCC Part 15.247(b)	Maximum Peak Output Power	PASS
FCC Part 15.247(b)	Pseudorandom Frequency Hopping Sequence	PASS
FCC Part 15.247(a)(1)(iii)	Number of hopping frequency& Time of Occupancy	PASS
FCC Part 15.247(a)(1)	Frequency Separation	PASS
FCC Part 15.109/15.205/15.209	Radiated Emissions	PASS
FCC Part 15.247(d)	Band Edge Compliance of RF Emission	PASS
FCC Part 15.203/15.247 (b)	Antenna Requirement	PASS

Remark: The measurement uncertainty is not included in the test result.

1.3. Test Facility

1.3.1 Address of the test laboratory

Shenzhen General Testing & Inspection Technology Co., Ltd.

Add: 1F, 2 Block, Jiaquan Building, Guanlan High-tech Park Baoan District, Shenzhen, Guangdong, China

1.3.2 Laboratory accreditation

The test facility is recognized, certified, or accredited by the following organizations:

IC Registration No.: 9783A

The 3m alternate test site of Shenzhen GTI Technology Co., Ltd. EMC Laboratory has been registered by Certification and Engineer Bureau of Industry Canada for the performance of with Registration NO.: 9783A on Aug, 2011.

FCC-Registration No.: 214666

Shenzhen GTI Technology Co., Ltd. EMC Laboratory has been registered and fully described in a report filed with the (FCC) Federal Communications Commission. The acceptance letter from the FCC is maintained in our files. Registration 214666, Sep 19, 2011

1.4. Measurement Uncertainty

The data and results referenced in this document are true and accurate. The reader is cautioned that there may be errors within the calibration limits of the equipment and facilities. The measurement uncertainty was calculated for all measurements listed in this test report acc. to CISPR 16 - 4 Specification for radio disturbance and immunity measuring apparatus and methods – Part 4: Uncertainty in EMC Measurements and is documented in the Shenzhen General Testing & Inspection Technology Co., Ltd quality system acc. to DIN EN ISO/IEC 17025. Furthermore, component and process variability of devices similar to that tested may result in additional deviation. The manufacturer has the sole responsibility of continued compliance of the device.

Hereafter the best measurement capability for General Testing & Inspection laboratory is reported:

Test Items	Measurement Uncertainty	Notes
Transmitter power conducted	0.57 dB	(1)
Transmitter power Radiated	2.20 dB	(1)
Conducted spurious emission 9KHz-40 GHz	1.60 dB	(1)
Radiated spurious emission 9KHz-40 GHz	2.20 dB	(1)
Conducted Emission 9KHz-30MHz	3.39 dB	(1)
Radiated Emission 30~1000MHz	4.24 dB	(1)
Radiated Emission 1~18GHz	5.16 dB	(1)
Radiated Emission 18-40GHz	5.54 dB	(1)
Occupied Bandwidth	-----	(1)

(1) This uncertainty represents an expanded uncertainty expressed at approximately the 95% confidence level using a coverage factor of k=1.96.

2. GENERAL INFORMATION

2.1. Environmental conditions

During the measurement the environmental conditions were within the listed ranges:

Temperature:	15~35°C
Relative Humidity:	30~60 %
Air Pressure:	950~1050mba

2.2. General Description of EUT

Product Name:	10.1" Tablet PC
Model/Type reference:	A1X PLUS
Power supply:	DC 3.7V from battery
Adapter information :	Model: UBP-A806-05200 Input: 100-240VAC, 50/60Hz Output: 5V---2000m A
Hardware version:	V1.3
Software version:	Android 4.4.2
Bluetooth 3.0	
Version:	Supported BT3.0
Modulation:	GFSK, π/4DQPSK, 8DPSK
Operation frequency:	2402MHz~2480MHz
Channel number:	79
Channel separation:	1MHz
Antenna type:	FPC Antenna
Antenna gain:	-1.5dBi

Note: For a more detailed features description, please refer to the manufacturer's specifications or the User's Manual.

2.3. Description of Test Modes

The Applicant provides communication tools software to control the EUT for staying in continuous transmitting (Duty Cycle more than 98%) and receiving mode for testing .There are 79 channels provided to the EUT. Channel 00/39/78 was selected to test.

Operation Frequency :

Channel	Frequency (MHz)
00	2402
01	2403
:	:
38	2440
39	2441
40	2442
:	:
77	2479
78	2480

2.4. Measurement Instruments List

Maximum Peak Output Power / Band Edge Compliance of RF Emission / Spurious RF Conducted Emission /Hoping Require/ 20dB bandwidth					
Item	Test Equipment	Manufacturer	Model No.	Serial No.	Calibrated until
1	Spectrum Analyzer	Rohde & Schwarz	FSU	100105	Jan 07,2016

Conducted Emission					
Item	Test Equipment	Manufacturer	Model No.	Serial No.	Calibrated until
1	LISN	R&S	ENV216	101112	Jan. 07, 2016
2	LISN	R&S	ENV216	101113	Jan. 07, 2016
3	EMI Test Receiver	R&S	ESCI	100920	Jan. 07, 2016
4	Cable	Schwarzbeck	Cable001	--	Jan. 07, 2016

Radiated Emission					
Item	Test Equipment	Manufacturer	Model No.	Serial No.	Calibrated until
1	EMI Test Receiver	R&S	ESCI	100967	Jan 07,2016
2	High pass filter	micro-tranics	HPM50111	34202	Jan 07,2016
3	Log-Bicon Antenna	Schwarzbeck	CBL6141A	4180	Jan. 10,2016
4	Ultra-Broadband Antenna	ShwarzBeck	BBHA9170	25841	Jan. 10,2016
5	Loop Antenna	LAPLAC	RF300	9138	Jan. 10,2016
6	Spectrum Analyzer	Rohde & Schwarz	FSU	100105	Jan 07,2016
7	Horn Antenna	Schwarzbeck	BBHA 9120D	648	Jan. 10,2016
8	Pre-Amplifier	HP	8447D	1937A03050	Jan. 07,2016



9	Pre-Amplifier	EMCI	EMC05183 5	980075	Jan. 07,2016
10	Antenna Mast	UC	UC3000	N/A	N/A
11	Turn Table	UC	UC3000	N/A	N/A
12	Cable	Schwarzbeck	Cable002	--	Jan. 07,2016
13	Cable	Schwarzbeck	Cable003	--	Jan. 07,2016

- Note: 1. The Cal.Interval was one year.
2. The cable loss has calculated in test result which connection between each test instruments.

3. TEST CONDITIONS AND RESULTS

3.1. Conducted Emission (AC Main)

LIMIT

FCC CFR Title 47 Part 15 Subpart C Section 15.207

Frequency range (MHz)	Limit (dBuV)	
	Quasi-peak	Average
0.15-0.5	66 to 56*	56 to 46*
0.5-5	56	46
5-30	60	50

* Decreases with the logarithm of the frequency.

TEST CONFIGURATION

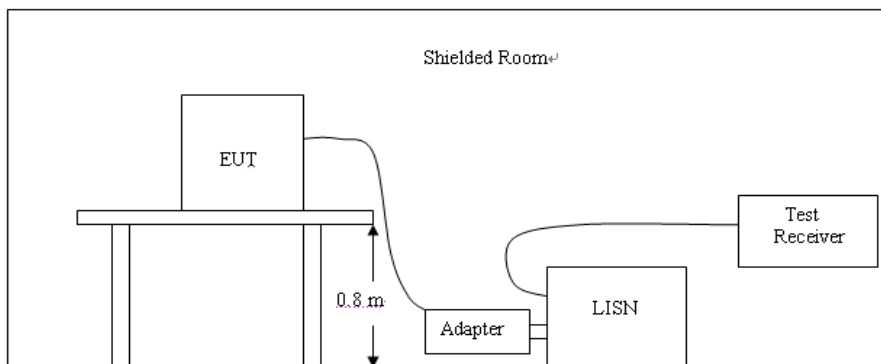

TEST PROCEDURE

1. The equipment was set up as per the test configuration to simulate typical actual usage per the user's manual. The EUT is a tabletop system; a wooden table with a height of 0.8 meters is used and is placed on the ground plane as per ANSI C63.10-2009.
2. Support equipment, if needed, was placed as per ANSI C63.10-2009
3. All I/O cables were positioned to simulate typical actual usage as per ANSI C63.10-2009
4. The EUT received DC5V power from the adapter, the adapter received AC120V/60Hz power through a Line Impedance Stabilization Network (LISN) which supplied power source and was grounded to the ground plane.
5. All support equipments received AC power from a second LISN, if any.
6. The EUT test program was started. Emissions were measured on each current carrying line of the EUT using a spectrum Analyzer / Receiver connected to the LISN powering the EUT. The LISN has two monitoring points: Line 1 (Hot Side) and Line 2 (Neutral Side). Two scans were taken: one with Line 1 connected to Analyzer / Receiver and Line 2 connected to a 50 ohm load; the second scan had Line 1 connected to a 50 ohm load and Line 2 connected to the Analyzer / Receiver.
7. Analyzer / Receiver scanned from 150 KHz to 30MHz for emissions in each of the test modes.
8. During the above scans, the emissions were maximized by cable manipulation.

TEST RESULTS

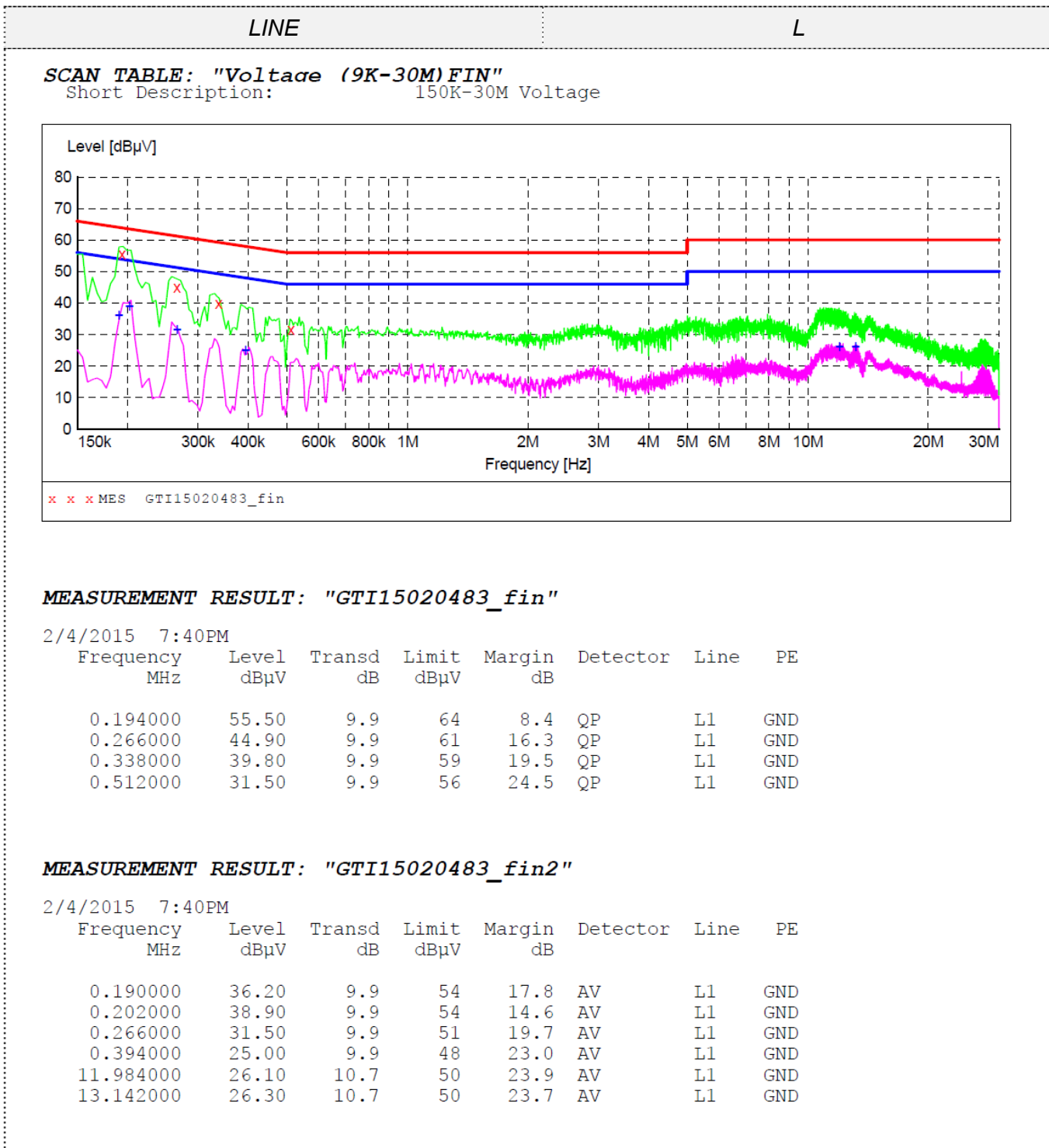

LINE

N

SCAN TABLE: "Voltage (9K-30M) FIN"

Short Description: 150K-30M Voltage

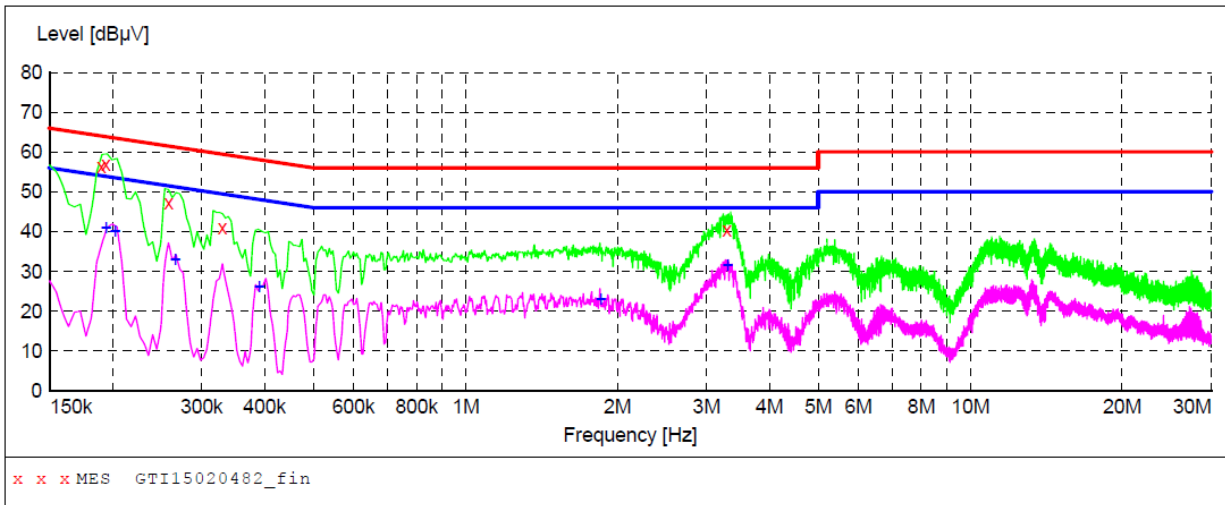

MEASUREMENT RESULT: "GTI15020482_fin"

2/4/2015 7:37PM

Frequency MHz	Level dBµV	Transd dB	Limit dBµV	Margin dB	Detector	Line	PE
0.190000	56.30	9.9	64	7.7	QP	N	GND
0.194000	56.90	9.9	64	7.0	QP	N	GND
0.258000	47.30	9.9	62	14.2	QP	N	GND
0.330000	40.90	9.9	60	18.6	QP	N	GND
3.296000	40.40	10.5	56	15.6	QP	N	GND

MEASUREMENT RESULT: "GTI15020482_fin2"

2/4/2015 7:37PM

Frequency MHz	Level dBµV	Transd dB	Limit dBµV	Margin dB	Detector	Line	PE
0.194000	41.00	9.9	54	12.9	AV	N	GND
0.202000	40.00	9.9	54	13.5	AV	N	GND
0.266000	33.10	9.9	51	18.1	AV	N	GND
0.390000	26.20	9.9	48	21.9	AV	N	GND
1.850000	23.10	10.4	46	22.9	AV	N	GND
3.302000	31.50	10.5	46	14.5	AV	N	GND

3.2. Radiated Emission

Limit

For intentional device, according to § 15.209(a), the general requirement of field strength of radiated emission from intentional radiators at a distance of 3 meters shall not exceed the following table. According to § 15.247(d), in any 100kHz bandwidth outside the frequency band in which the EUT is operating, the radio frequency power that is produced by the intentional radiator shall be at least 20dB below that in the 100kHz bandwidth within the band that contains the highest level of desired power.

The frequency spectrum above 1 GHz for Transmitter was investigated. All emission not reported are much lower than the prescribed limits. Set the RBW=1MHz, VBW=3MHz for Peak Detector while the RBW=1MHz, VBW=10Hz for Average Detector, Readings are both peak and average values. The pre-test have done for the EUT in three axes and found the worst emission at position shown in test setup photos.

Frequency (MHz)	Distance (Meters)	Radiated (dBuV/m)	Radiated (µV/m)
0.009-0.49	3	$20\log(2400/F(\text{KHz}))+40\log(300/3)$	$2400/F(\text{KHz})$
0.49-1.705	3	$20\log(24000/F(\text{KHz}))+40\log(30/3)$	$24000/F(\text{KHz})$
1.705-30	3	$20\log(30)+40\log(30/3)$	30
30-88	3	40.0	100
88-216	3	43.5	150
216-960	3	46.0	200
Above 960	3	54.0	500

Test Procedure

1. The EUT was placed on a turn table which is 0.8m above ground plane.
2. Maximum procedure was performed by raising the receiving antenna from 1m to 4m and rotating the turn table from 0° to 360° to acquire the highest emissions from EUT
3. And also, each emission was to be maximized by changing the polarization of receiving antenna both horizontal and vertical.
4. Repeat above procedures until all frequency measurements have been completed.

Field Strength Calculation

The field strength is calculated by adding the Antenna Factor and Cable Factor and subtracting the Amplifier Gain and Duty Cycle Correction Factor (if any) from the measured reading. The basic equation with a sample calculation is as follows:

$$FS = RA + AF + CL - AG$$

Where FS = Field Strength	CL = Cable Attenuation Factor (Cable Loss)
RA = Reading Amplitude	AG = Amplifier Gain
AF = Antenna Factor	

For example

Frequency (MHz)	FS (dBµV/m)	RA (dBµV/m)	AF (dB)	CL (dB)	AG (dB)	Transd (dB)
150.00	40	58.1	12.2	1.6	31.90	-18.1

$$\text{Transd} = \text{AF} + \text{CL} - \text{AG}$$

Test Configuration

Frequency range 9 KHz – 30MHz

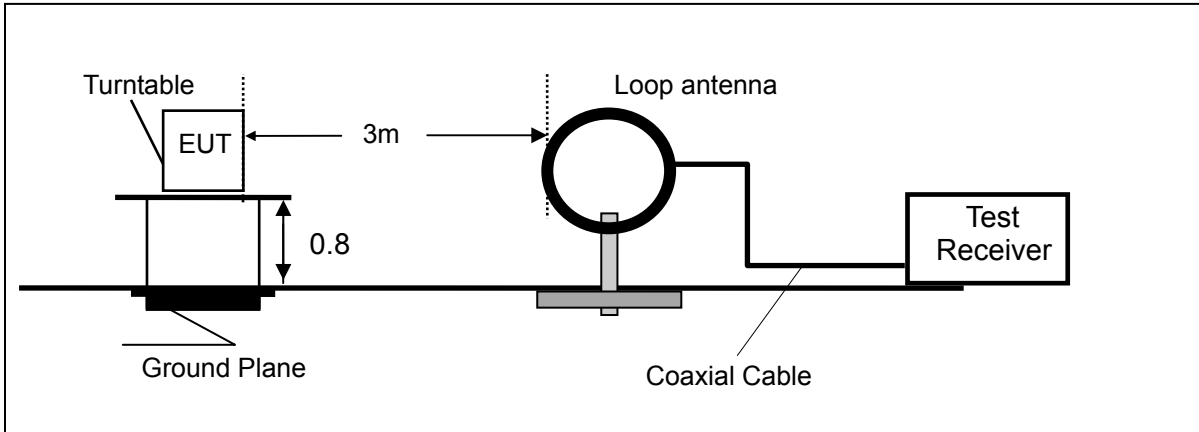

Frequency range 30MHz – 1000MHz

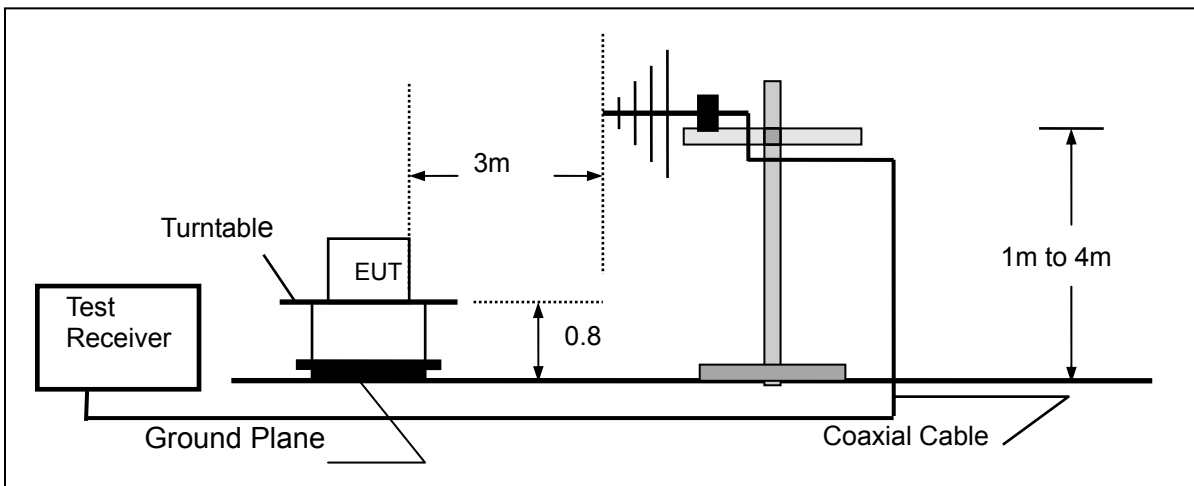

Frequency range above 1GHz-25GHz

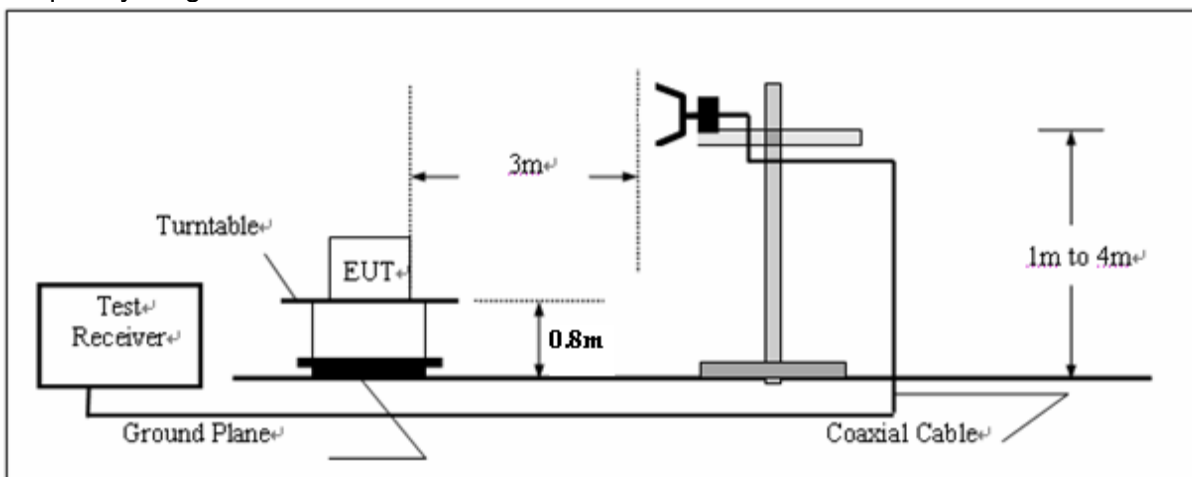

Test Results

Remark: We measured Radiated Emission at GFSK, $\pi/4$ DQPSK and 8DPSK mode from 9 KHz to 25GHz and recorded worst case at GFSK mode.

For 9 KHz-30MHz

Frequency (MHz)	Corrected Reading (dBuV/m)@3m	FCC Limit (dBuV/m) @3m	Margin (dB)	Detector	Result
0.21	54.54	101.16	46.62	QP	PASS
1.59	42.3	63.58	21.28	QP	PASS
20.62	53.22	69.54	16.32	QP	PASS
25.59	49.87	69.54	19.67	QP	PASS

For 30MHz-1GHz

Horizontal

Data: 22

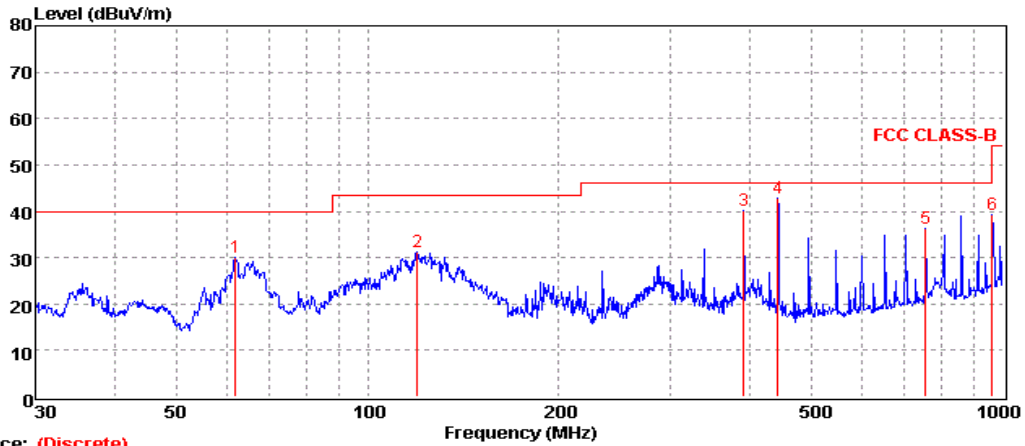

Trace: (Discrete)

Mark	Frequency MHz	Level dBuV/m	Factor dB/m	Reading dBuV	Limit dBuV/m	Margin dB	Polarization	Detector
1	62.00	30.11	-20.06	50.17	40.00	9.89	HORIZONTAL	Peak
2	119.86	31.09	-18.67	49.76	43.50	12.41	HORIZONTAL	Peak
3	390.72	40.07	-13.57	53.64	46.00	5.93	HORIZONTAL	Peak
4	441.74	42.71	-12.52	55.23	46.00	3.29	HORIZONTAL	Peak
5	755.39	36.20	-8.21	44.41	46.00	9.80	HORIZONTAL	Peak
6	962.16	39.32	-4.50	43.82	54.00	14.68	HORIZONTAL	Peak

Vertical

Data: 23

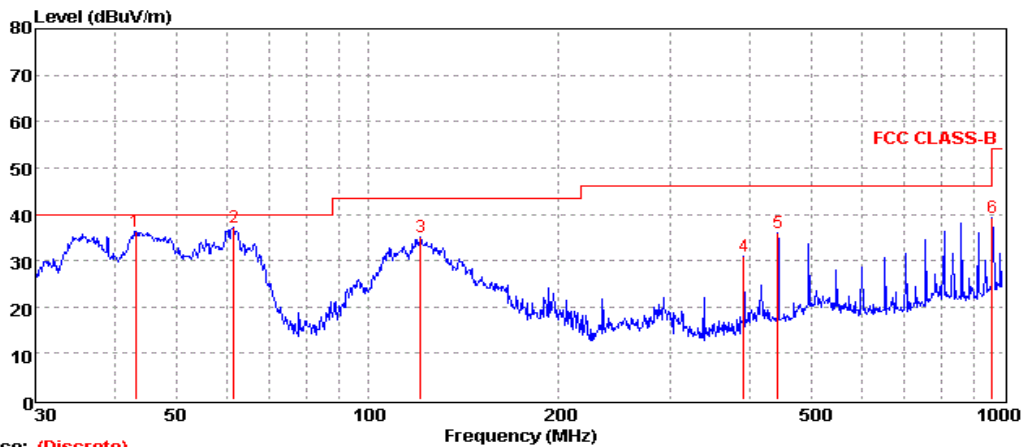

Trace: (Discrete)

Mark	Frequency MHz	Level dBuV/m	Factor dB/m	Reading dBuV	Limit dBuV/m	Margin dB	Polarization	Detector
1	43.20	36.25	-13.52	49.77	40.00	3.75	HORIZONTAL	Peak
2	61.56	37.11	-20.06	57.17	40.00	2.89	HORIZONTAL	Peak
3	121.12	35.02	-18.69	53.71	43.50	8.48	HORIZONTAL	Peak
4	390.72	30.92	-13.57	44.49	46.00	15.08	HORIZONTAL	Peak
5	441.74	36.03	-12.52	48.55	46.00	9.97	HORIZONTAL	Peak
6	962.16	39.14	-4.50	43.64	54.00	14.86	HORIZONTAL	Peak

For 1GHz to 25GHz

GFSK Mode (above 1GHz)

Frequency(MHz):				2402			Polarity:			HORIZONTAL		
No.	Frequency (MHz)	Emission Level (dBuV/m)		Limit (dBuV/m)	Margin (dB)	Antenna Height (m)	Table Angle (Degree)	Raw Value (dBuV)	Antenna Factor (dB/m)	Cable Factor (dB)	Pre-amplifier (dB)	Correction Factor (dB/m)
1	4804.00	56.65	PK	74.00	17.35	1.00 H	115	54.75	31.42	6.98	36.5	1.90
1	4804.00	41.25	AV	54.00	12.75	1.00 H	115	39.35	31.42	6.98	36.5	1.90
2	7206.00	47.54	PK	74.00	26.46	1.00 H	58	36.94	37.03	8.87	35.3	10.60
2	7206.00	--	AV	--	--	--	--	--	--	--	--	--

Frequency(MHz):				2402			Polarity:			VERTICAL		
No.	Frequency (MHz)	Emission Level (dBuV/m)		Limit (dBuV/m)	Margin (dB)	Antenna Height (m)	Table Angle (Degree)	Raw Value (dBuV)	Antenna Factor (dB/m)	Cable Factor (dB)	Pre-amplifier (dB)	Correction Factor (dB/m)
1	4804.00	57.69	PK	74.00	16.31	1.00 V	120	55.79	31.42	6.98	36.5	1.90
1	4804.00	40.23	AV	54.00	13.77	1.00 V	120	38.33	31.42	6.98	36.5	1.90
2	7206.00	48.23	PK	74.00	25.77	1.00 V	100	37.63	37.03	8.87	35.3	10.60
2	7206.00	--	AV	--	--	--	--	--	--	--	--	--

Frequency(MHz):				2440			Polarity:			HORIZONTAL		
No.	Frequency (MHz)	Emission Level (dBuV/m)		Limit (dBuV/m)	Margin (dB)	Antenna Height (m)	Table Angle (Degree)	Raw Value (dBuV)	Antenna Factor (dB/m)	Cable Factor (dB)	Pre-amplifier (dB)	Correction Factor (dB/m)
1	4882.00	57.63	PK	74.00	16.64	1.00 H	130	55.30	30.98	7.58	36.5	2.06
1	4882.00	43.58	AV	54.00	10.55	1.00 H	130	41.39	30.98	7.58	36.5	2.06
2	7323.00	42.21	PK	74.00	31.53	1.00 H	135	31.55	37.66	8.56	35.3	10.92
2	7323.00	--	AV	--	--	--	--	--	--	--	--	--

Frequency(MHz):				2440			Polarity:			VERTICAL		
No.	Frequency (MHz)	Emission Level (dBuV/m)		Limit (dBuV/m)	Margin (dB)	Antenna Height (m)	Table Angle (Degree)	Raw Value (dBuV)	Antenna Factor (dB/m)	Cable Factor (dB)	Pre-amplifier (dB)	Correction Factor (dB/m)
1	4882.00	61.63	PK	74.00	12.37	1.00 V	90	59.57	30.98	7.58	36.5	2.06
1	4882.00	46.50	AV	54.00	7.50	1.00 V	90	44.44	30.98	7.58	36.5	2.06
2	7323.00	49.32	PK	74.00	24.68	1.00 V	125	38.40	37.66	8.56	35.3	10.92
2	7323.00	--	AV	--	--	--	--	--	--	--	--	--

Frequency(MHz):				2480			Polarity:			HORIZONTAL		
No.	Frequency (MHz)	Emission Level (dBuV/m)		Limit (dBuV/m)	Margin (dB)	Antenna Height (m)	Table Angle (Degree)	Raw Value (dBuV)	Antenna Factor (dB/m)	Cable Factor (dB)	Pre-amplifier (dB)	Correction Factor (dB/m)
1	4960.00	58.87	PK	74.00	15.13	1.00 H	125	55.80	31.47	7.80	36.2	3.07
1	4960.00	42.36	AV	54.00	11.64	1.00 H	125	39.29	31.47	7.80	36.2	3.07
2	7340.00	45.15	PK	74.00	28.85	1.00 H	250	33.41	38.32	8.72	35.3	11.74
2	7340.00	--	AV	--	--	--	--	--	--	--	--	--

Frequency(MHz):				2480			Polarity:			VERTICAL		
No.	Frequency (MHz)	Emission Level (dBuV/m)		Limit (dBuV/m)	Margin (dB)	Antenna Height (m)	Table Angle (Degree)	Raw Value (dBuV)	Antenna Factor (dB/m)	Cable Factor (dB)	Pre-amplifier (dB)	Correction Factor (dB/m)
1	4960.00	57.36	PK	74.00	16.64	1.00 V	150	54.29	31.47	7.80	-36.2	3.07
1	4960.00	39.15	AV	54.00	14.85	1.00 V	150	36.08	31.47	7.80	-36.2	3.07
2	7340.00	47.39	PK	74.00	26.61	1.00 V	95	35.65	38.32	8.72	-35.3	11.74
2	7340.00	--	AV	--	--	--	--	--	--	--	--	--



REMARKS:

1. Emission level (dBuV/m) =Raw Value (dBuV)+Correction Factor (dB/m)
2. Correction Factor (dB/m) = Antenna Factor (dB/m)+Cable Factor (dB)-Pre-amplifier Factor
3. Margin value = Limit value- Emission level.
4. -- Mean the PK detector measured value is below average limit.
5. The other emission levels were very low against the limit.

3.3. Maximum Peak Output Power

Limit

The Maximum Peak Output Power Measurement is 30dBm.

Test Procedure

Remove the antenna from the EUT and then connect a low loss RF cable from the antenna port to the spectrum.

Test Configuration

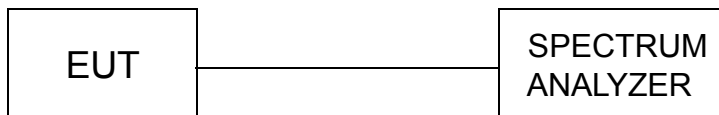

Test Results

Type	Channel	Output power (dBm)	Limit (dBm)	Result
GFSK	00	3.52	30.00	Pass
	39	4.04		
	78	3.83		
π/4DQPSK	00	2.83	30.00	Pass
	39	3.27		
	78	3.02		
8DPSK	00	2.90	30.00	Pass
	39	3.34		
	78	3.05		

Note: 1.The test results including the cable lose.

Test plot as follows:

GFSK Modulation

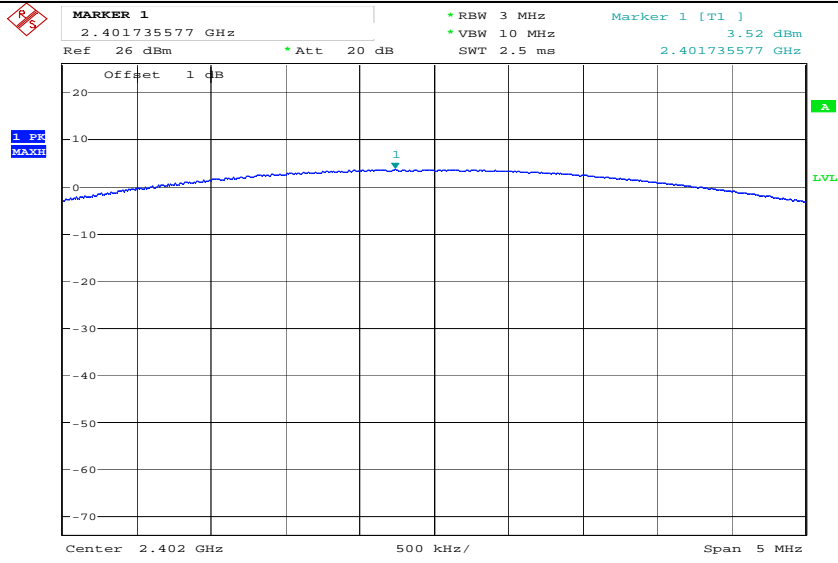

CH00

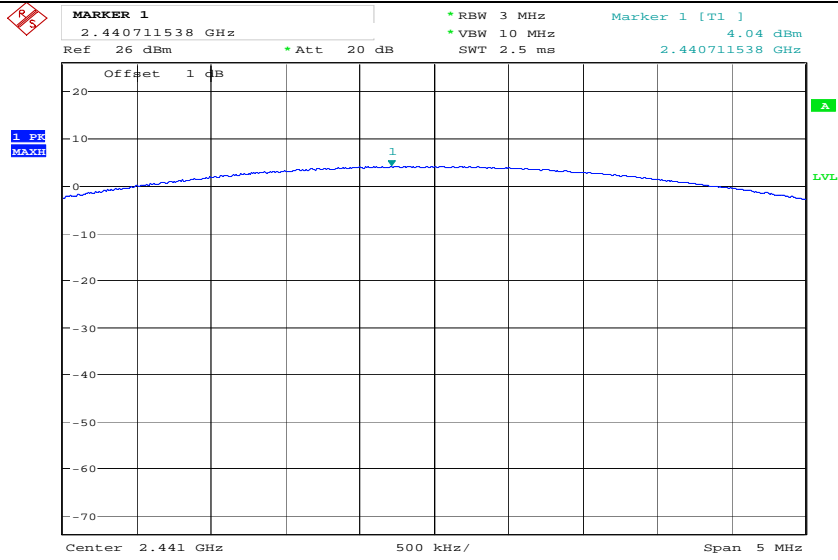

CH39

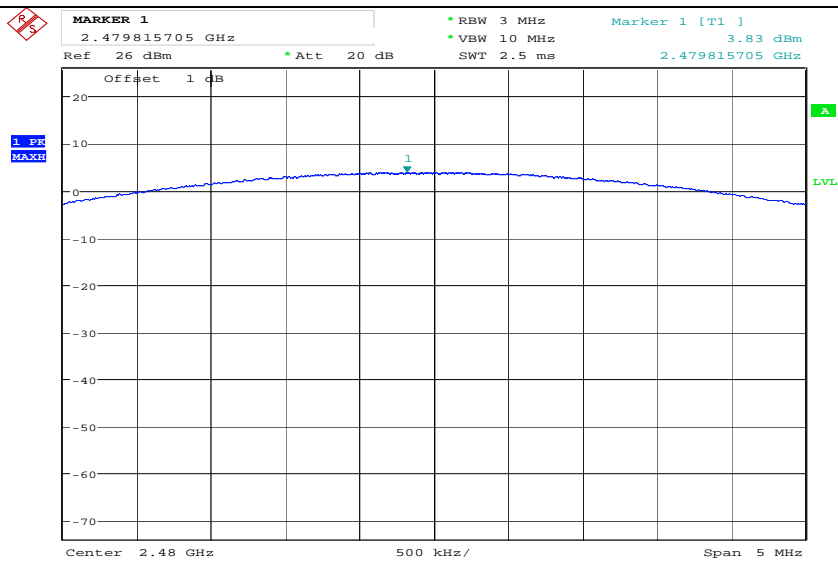

CH78

$\pi/4$ DQPSK Modulation

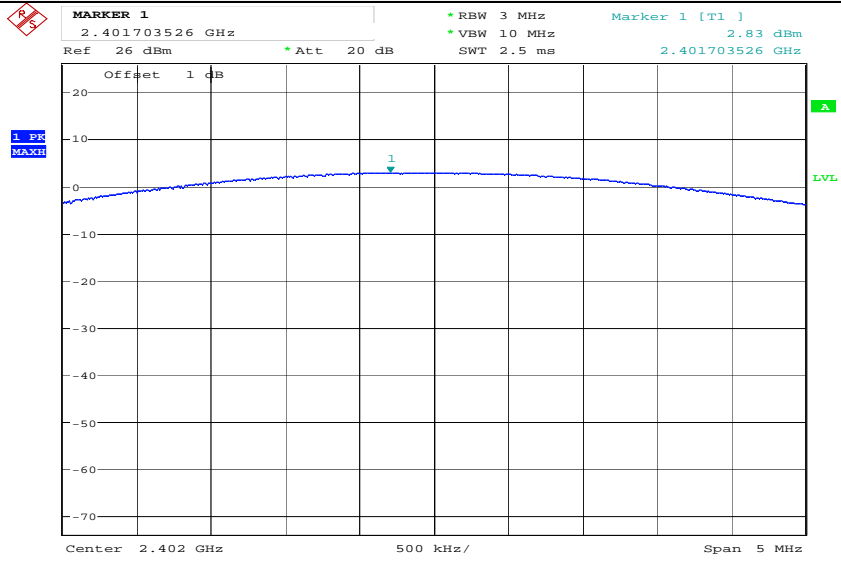

CH00

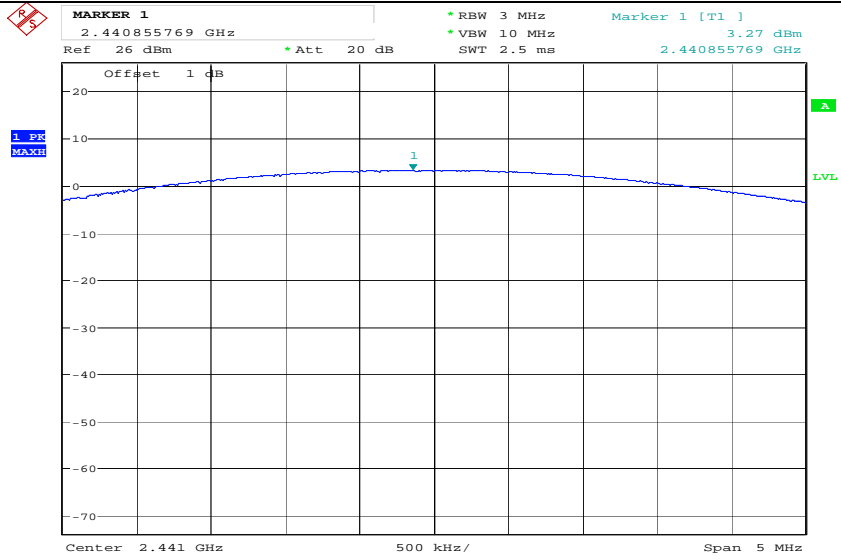

CH39

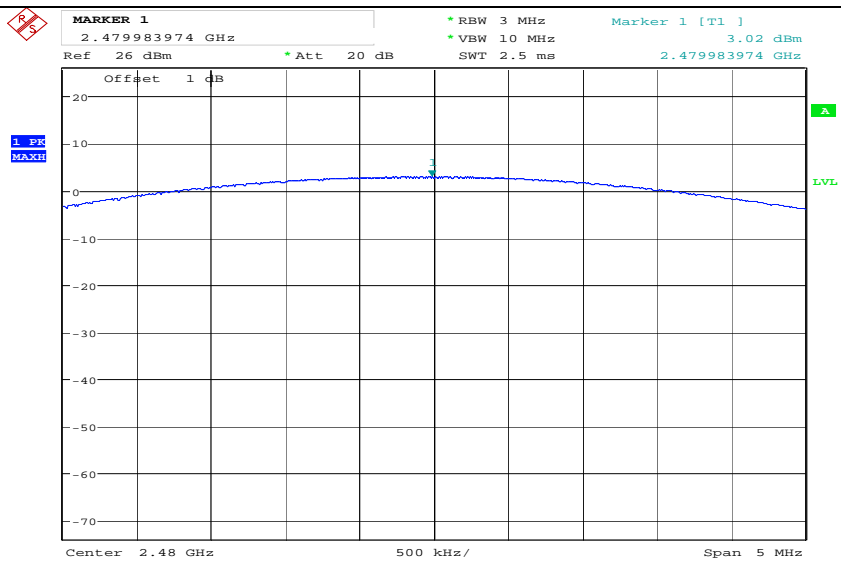

CH78

8DPSK Modulation

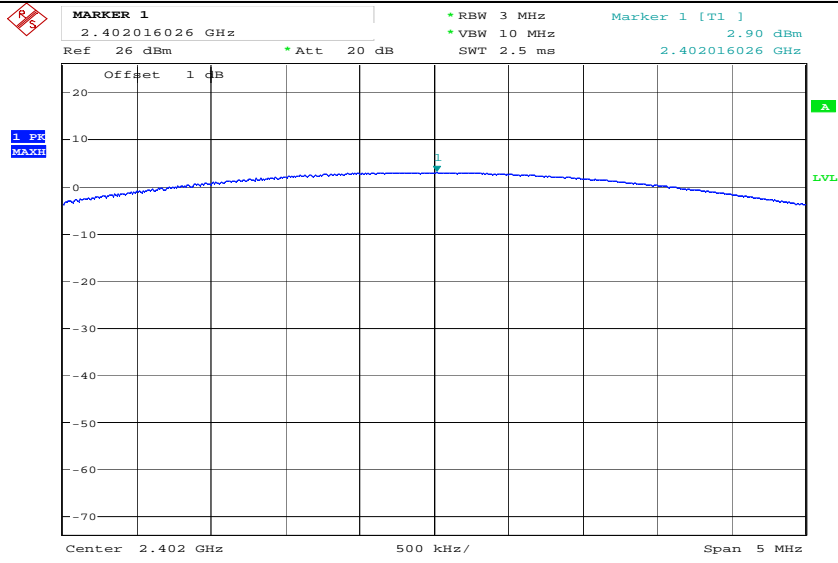

CH00

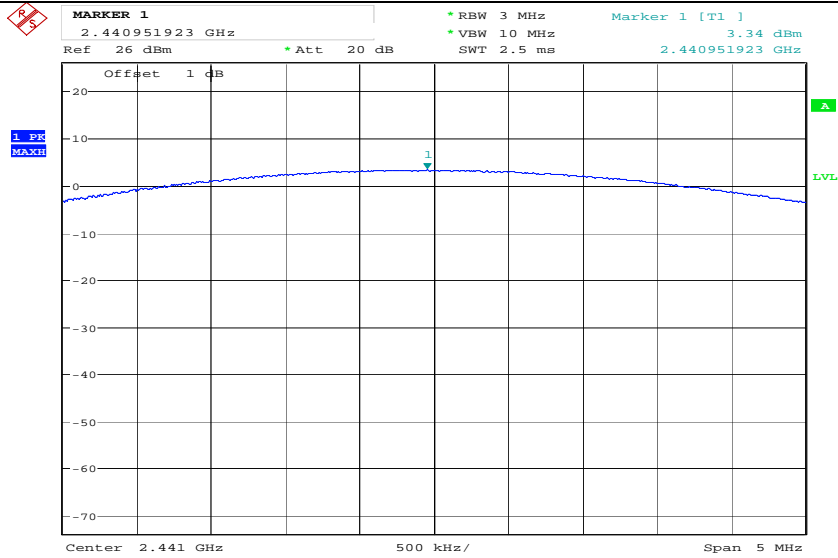

CH39

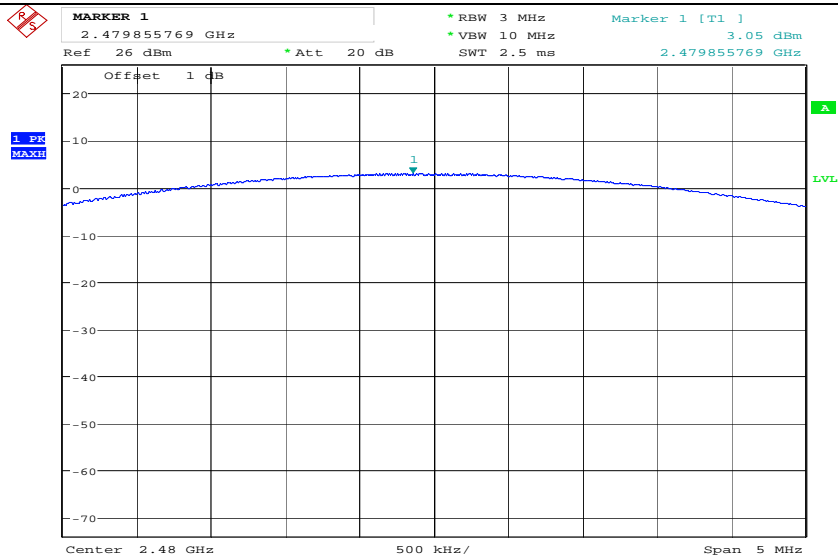

CH78

3.4. 20dB Bandwidth

Limit

For frequency hopping systems operating in the 2400MHz-2483.5MHz no limit for 20dB bandwidth.

Test Procedure

The transmitter output was connected to the spectrum analyzer through an attenuator. The bandwidth of the fundamental frequency was measured by spectrum analyzer with 30 KHz RBW and 100 KHz VBW.

The 20dB bandwidth is defined as the total spectrum the power of which is higher than peak power minus 20dB.

Test Configuration

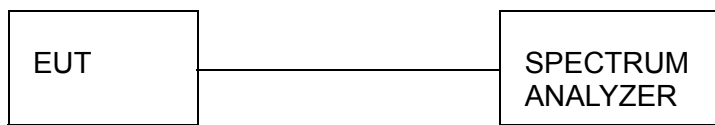

Test Results

Modulation	Channel	20dB bandwidth (MHz)	Result
GFSK	CH00	0.841	Pass
	CH39	0.846	
	CH78	0.841	
π/4DQPSK	CH00	1.130	
	CH39	1.125	
	CH78	1.130	
8DPSK	CH00	1.168	
	CH39	1.173	
	CH78	1.173	

Test plot as follows:

GFSK Modulation

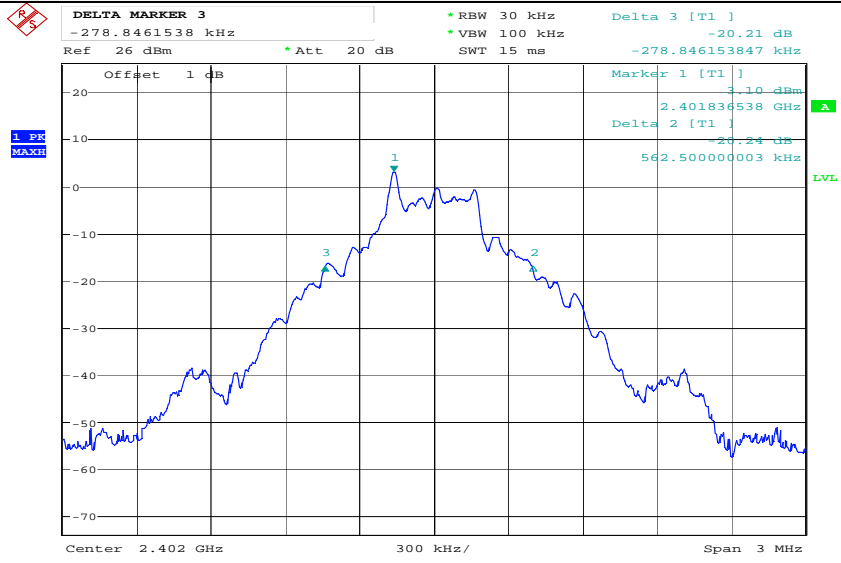

CH00

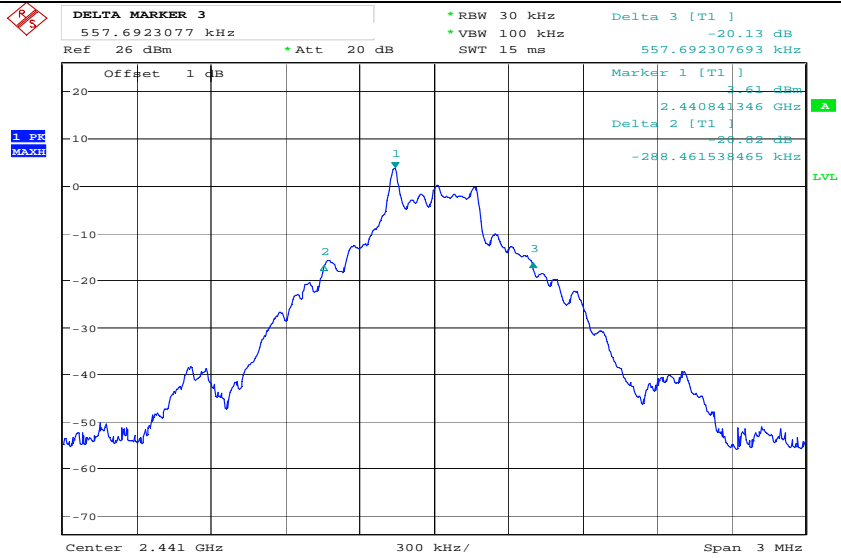

CH39

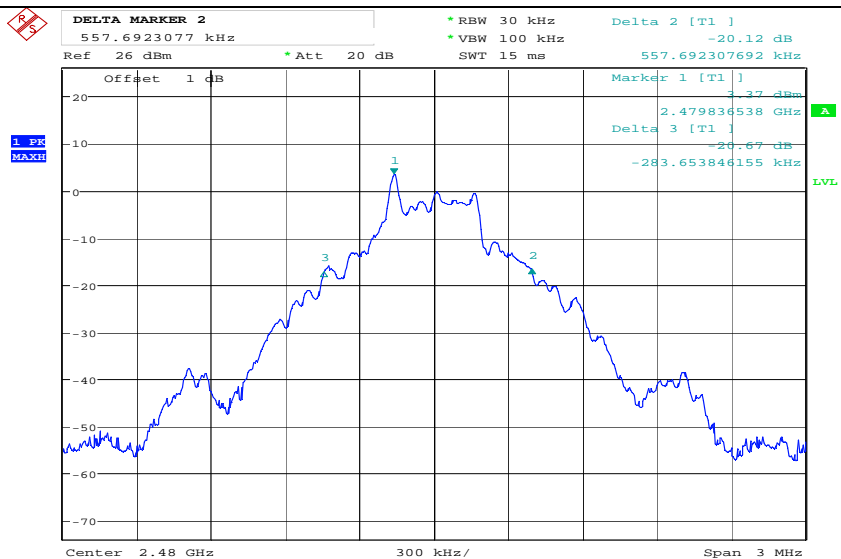

CH78

$\pi/4$ DQPSK Modulation

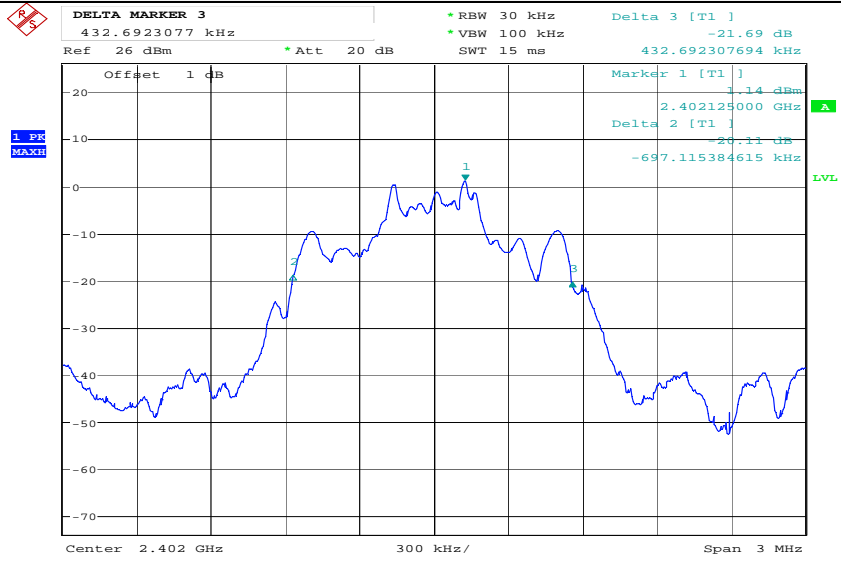

CH00

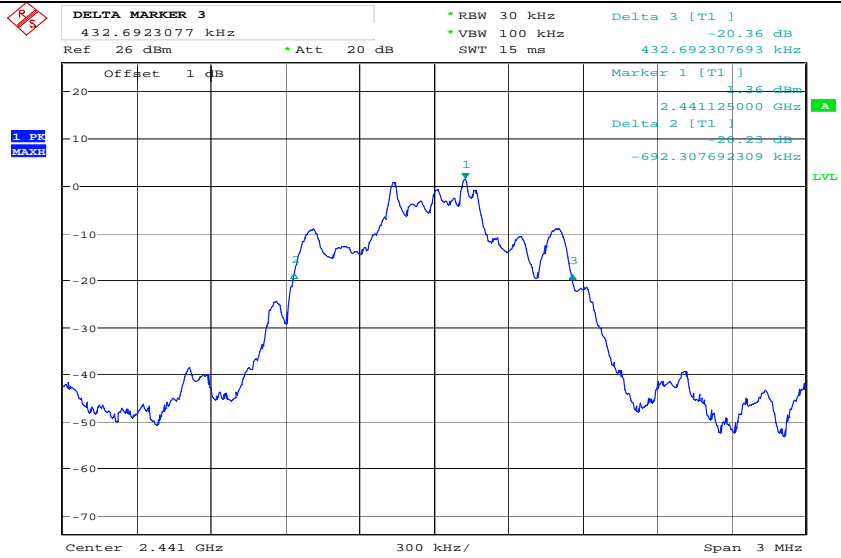

CH39

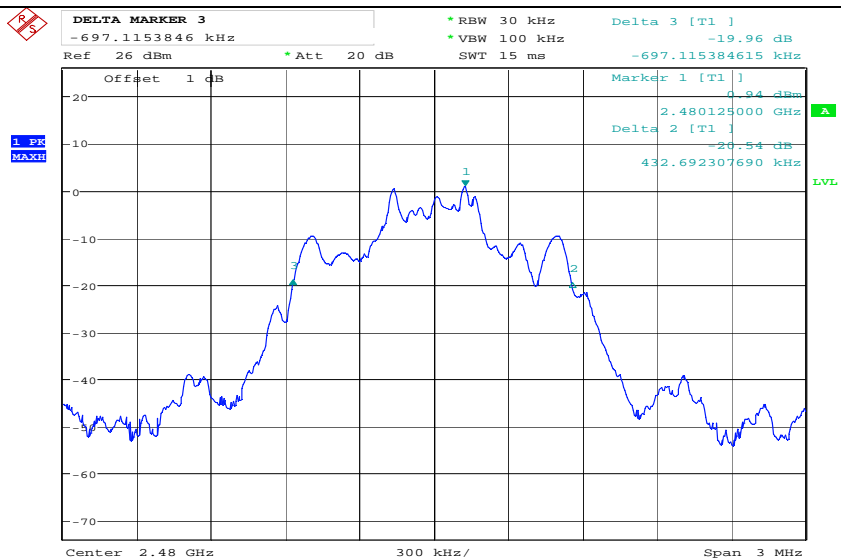

CH78

8DPSK Modulation

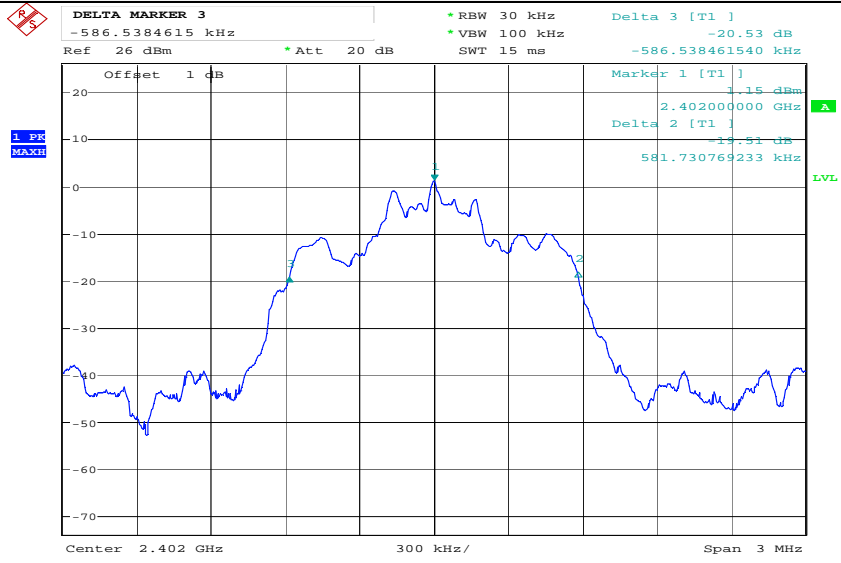

CH00

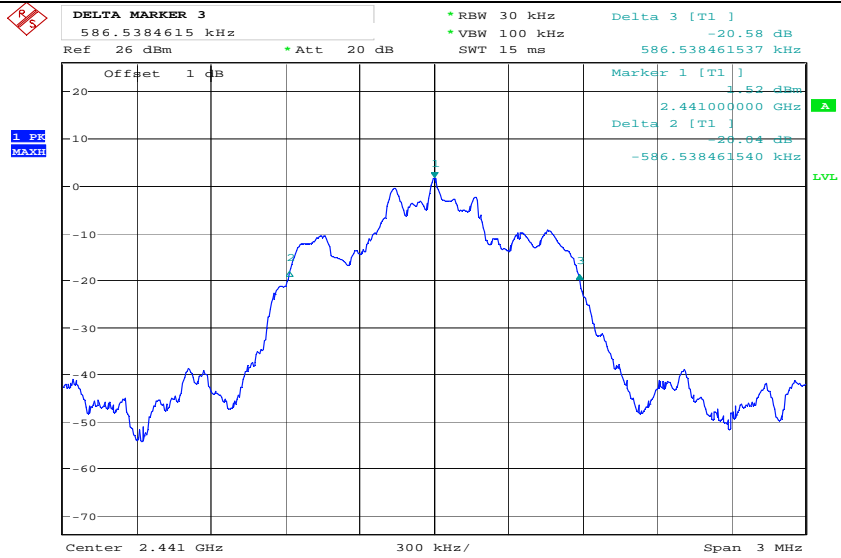

CH39

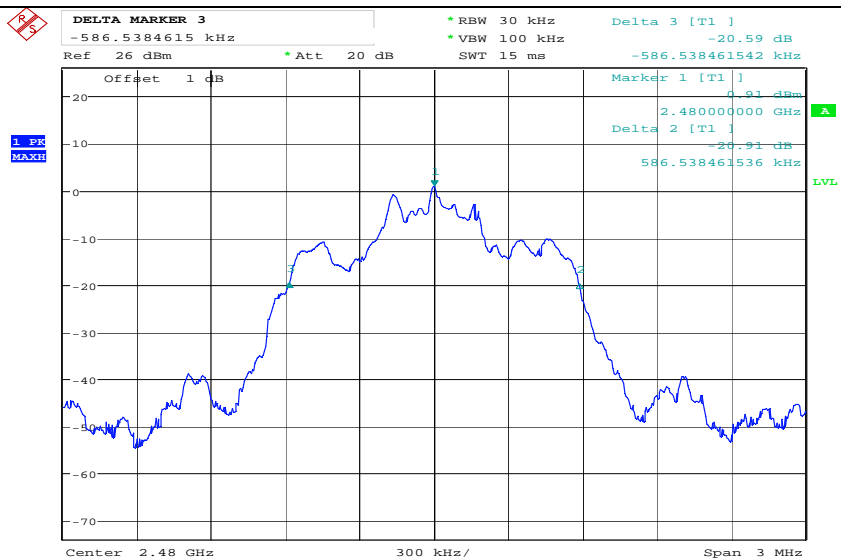

CH78

3.5. Band Edge

Applicable Standard

In any 100 kHz bandwidth outside the frequency band in which the spread spectrum or digitally modulated intentional radiator is operating, the radio frequency power that is produced by the intentional radiator shall be at least 20 dB below that in the 100 kHz bandwidth within the band that contains the highest level of the desired power, based on either an RF conducted or a radiated measurement, provided the transmitter demonstrates compliance with the peak conducted power limits. If the transmitter complies with the conducted power limits based on the use of RMS averaging over a time interval, as permitted under paragraph (b)(3) of this section, the attenuation required under this paragraph shall be 30 dB instead of 20 dB. Attenuation below the general limits specified in §15.209(a) is not required. In addition, radiated emissions which fall in the restricted bands, as defined in §15.205(a), must also comply with the radiated emission limits specified in §15.209(a) (see §15.205(c)).

Test Procedure

Test Procedure for conducted method

1. Remove the antenna from the EUT and then connect to a low loss RF cable from the antenna port to a spectrum analyzer
2. Turn on the EUT and make it operate in transmitting mode. Then set it to Low Channel and High Channel within its operating range, and make sure the instrument is operated in its linear range.
3. Set spectrum analyzer RBW =100 kHz and VBW=300 kHz
4. Use spectrum analyzer Maxhold function to allow trace to fully stabilize
5. Marker the highest point which fall into restricted frequency bands
6. Repeat above procedures until all measured frequencies were complete.

Test Procedure for radiated method

1. The EUT was placed on the top of a rotating table 0.8 meters above the ground at a 3 meter anechoic chamber. The table was rotated 360 degrees to determine the position of the highest radiation.
2. The EUT was set 3 meters away from the interference receiving antenna, which was mounted on the top of a variable height antenna tower.
3. The antenna height is varied from one meter to four meters above the ground to determine the maximum value of the field strength. Both horizontal and vertical polarizations of the antenna are set to make the measurement.
4. For each suspected emission, the EUT was arranged to its worst case and then the antenna was tuned to heights from 1 meter to 4 meters and the rotatable table was turned from 0 degrees to 360 degrees to find the maximum reading.
5. The test-receiver system was set to Peak Detect Function and Specified Bandwidth with Maximum Hold Mode.
6. Place a marker at the end of the restricted band closest to the transmit frequency to show compliance. Also measure any emissions in the restricted bands. Save the spectrum analyzer plot. Repeat for each power and modulation for lowest and highest channel
7. Test the EUT in the lowest channel, the highest channel
8. The radiation measurements are performed in X, Y, Z axis positioning. And found the X axis positioning which it is worse case, only the test worst case mode is recorded in the report.
9. Repeat above procedures until all frequencies measured was complete.

TEST RESULTS

Remark: we measured all conditions (DH1, DH3, DH5) and recorded worst case at DH1

A. Radiated Bandedge Measurement

Test Mode:	GFSK	Polarization:	Horizontal
-------------------	-------------	----------------------	-------------------

Data: 61

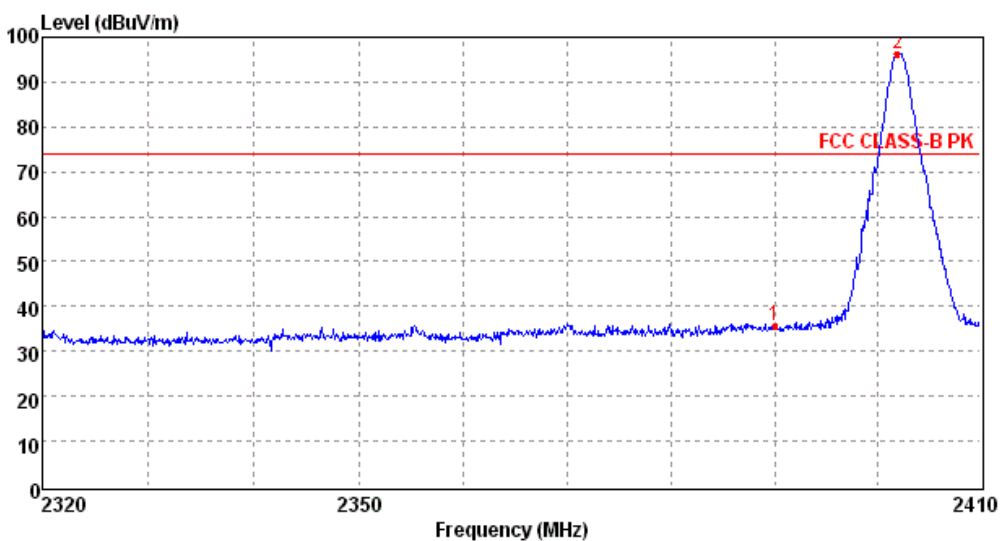

Mark	Frequency (MHz)	Level (dBuV/m)	Cable Loss (dB)	Antenna Factor (dB/m)	Preamplifier Factor (dB)	Reading Level (dBuV/m)	Limit (dBuV/m)	Margin (dB)	Detector
1	2390.00	35.63	3.32	27.49	36.12	40.91	74.00	38.37	Peak
2	2402.03	96.39	3.32	27.49	36.12	101.70	74.00	-22.39	Peak

Data: 59

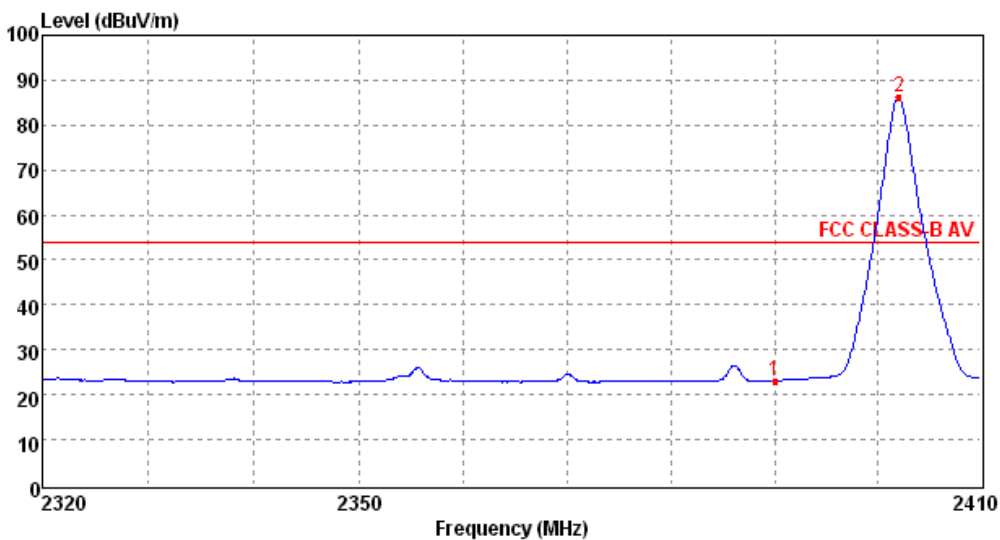

Mark	Frequency (MHz)	Level (dBuV/m)	Cable Loss (dB)	Antenna Factor (dB/m)	Preamplifier Factor (dB)	Reading Level (dBuV/m)	Limit (dBuV/m)	Margin (dB)	Detector
1	2390.00	23.12	3.32	27.49	36.12	28.40	54.00	30.88	Average
2	2402.13	86.32	3.32	27.49	36.12	91.63	54.00	-32.32	Average

Test Mode:	GFSK	Polarization:	Vertical
-------------------	-------------	----------------------	-----------------

Data: 62

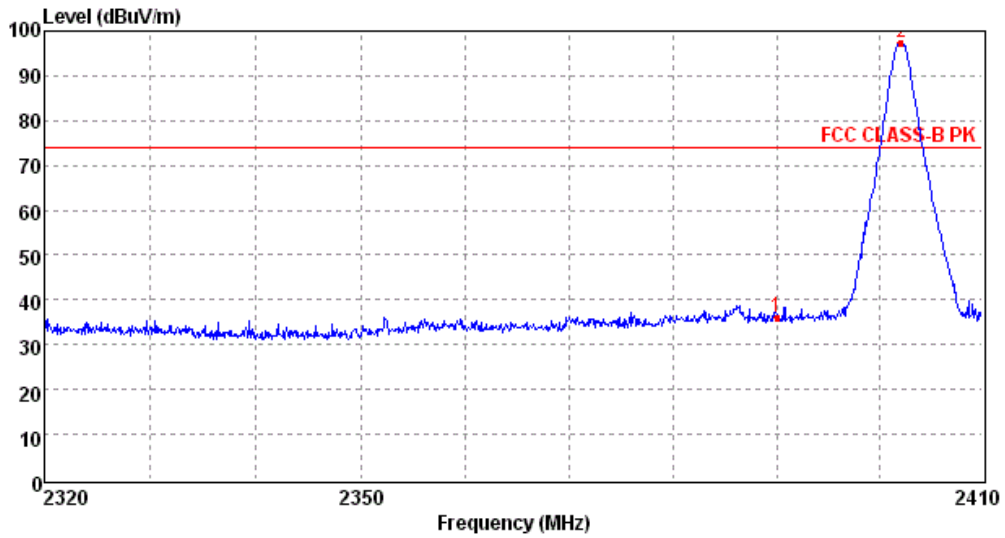

Mark	Frequency (MHz)	Level (dBuV/m)	Cable Loss (dB)	Antenna Factor (dB/m)	Preamp Factor (dB)	Reading Level (dBuV/m)	Limit (dBuV/m)	Margin (dB)	Detector
1	2390.00	36.02	3.32	27.49	36.12	41.30	74.00	37.98	Peak
2	2402.22	97.50	3.32	27.49	36.12	102.81	74.00	-23.50	Peak

Data: 60

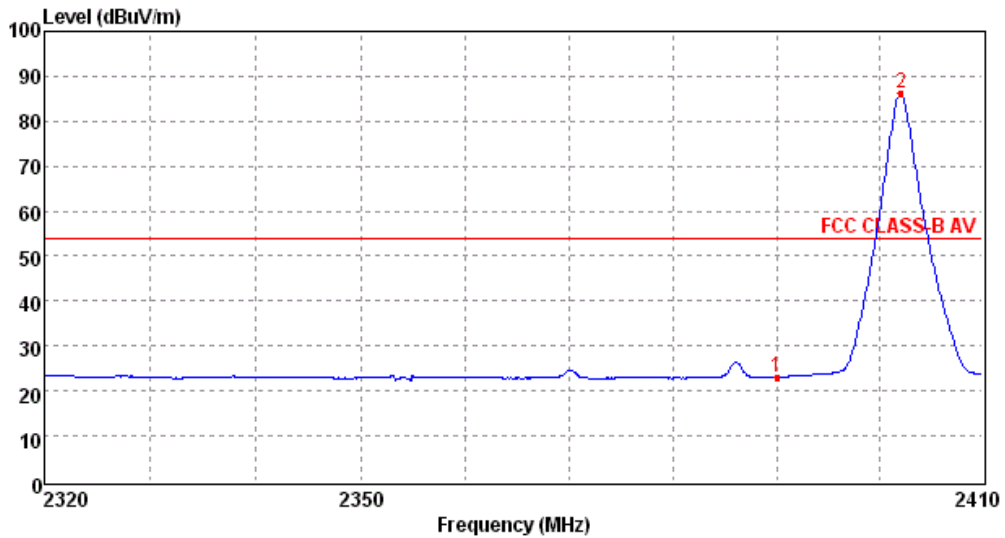

Mark	Frequency (MHz)	Level (dBuV/m)	Cable Loss (dB)	Antenna Factor (dB/m)	Preamp Factor (dB)	Reading Level (dBuV/m)	Limit (dBuV/m)	Margin (dB)	Detector
1	2390.00	23.04	3.32	27.49	36.12	28.32	54.00	30.96	Average
2	2402.13	86.23	3.32	27.49	36.12	91.54	54.00	-32.23	Average

Test Mode:	GFSK	Polarization:	Horizontal
-------------------	-------------	----------------------	-------------------

Data: 65

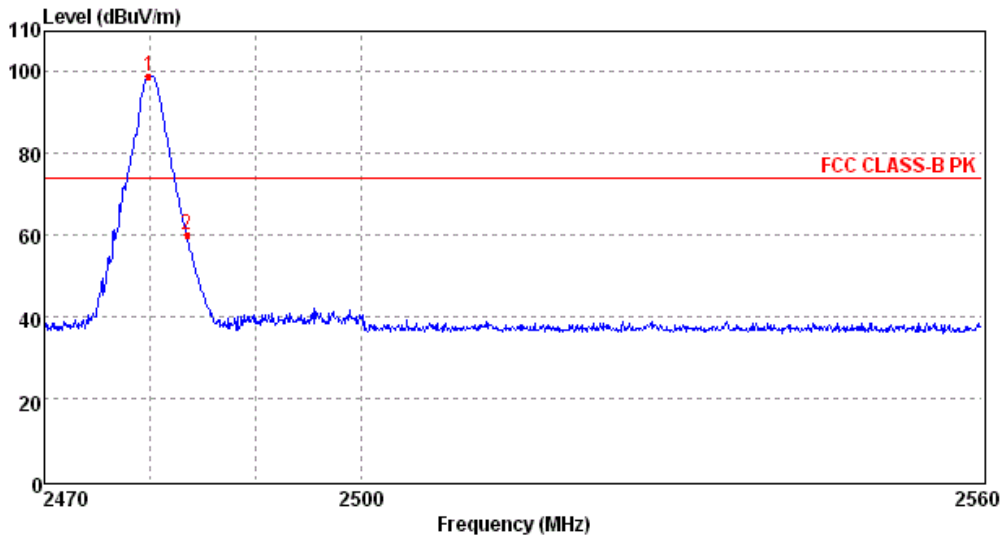

Mark	Frequency (MHz)	Level (dBuV/m)	Cable Loss (dB)	Antenna Factor (dB/m)	Preamp Factor (dB)	Reading Level (dBuV/m)	Limit (dBuV/m)	Margin (dB)	Detector
1	2479.83	99.15	3.88	27.45	36.55	104.37	74.00	-25.15	Peak
2	2483.50	60.25	3.88	27.45	36.55	65.47	74.00	13.75	Peak

Data: 63

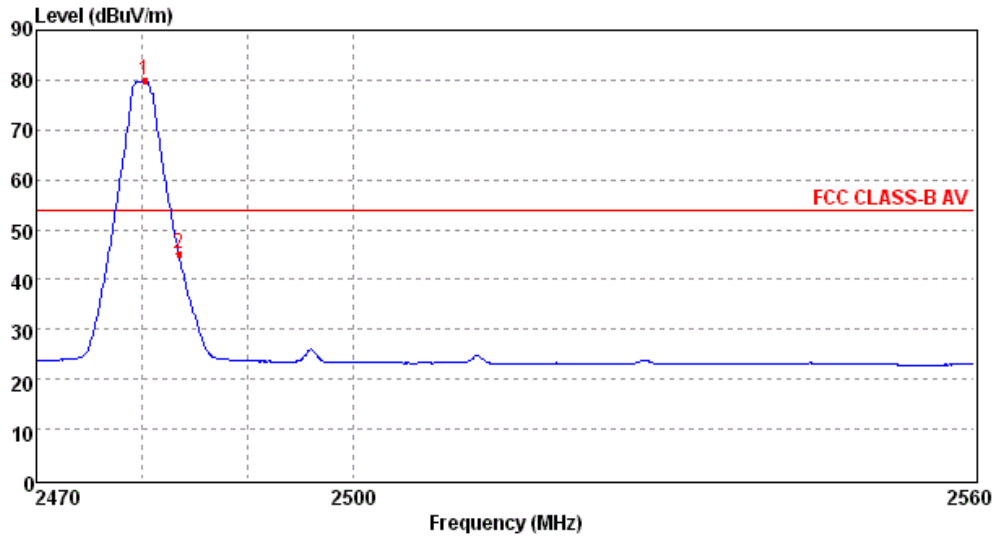

Mark	Frequency (MHz)	Level (dBuV/m)	Cable Loss (dB)	Antenna Factor (dB/m)	Preamp Factor (dB)	Reading Level (dBuV/m)	Limit (dBuV/m)	Margin (dB)	Detector
1	2480.28	80.07	3.88	27.45	36.55	85.29	54.00	-26.07	Average
2	2483.50	45.15	3.88	27.45	36.55	50.37	54.00	8.85	Average

Test Mode:	GFSK	Polarization:	Vertical
-------------------	-------------	----------------------	-----------------

Data: 66

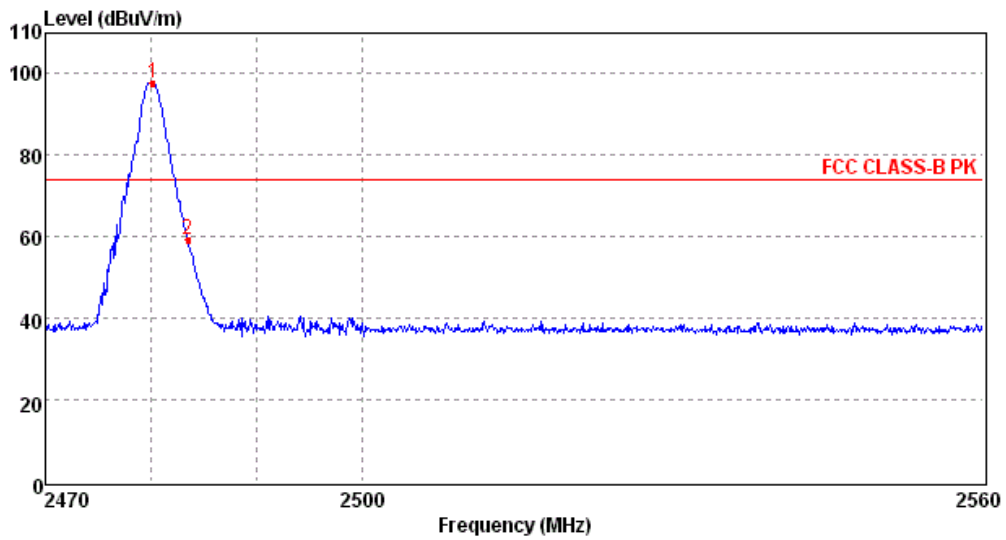

Mark	Frequency (MHz)	Level (dBuV/m)	Cable Loss (dB)	Antenna Factor (dB/m)	Preamp Factor (dB)	Reading Level (dBuV/m)	Limit (dBuV/m)	Margin (dB)	Detector
1	2480.19	97.81	3.88	27.45	36.55	103.03	74.00	-23.81	Peak
2	2483.50	59.26	3.88	27.45	36.55	64.48	74.00	14.74	Peak

Data: 64

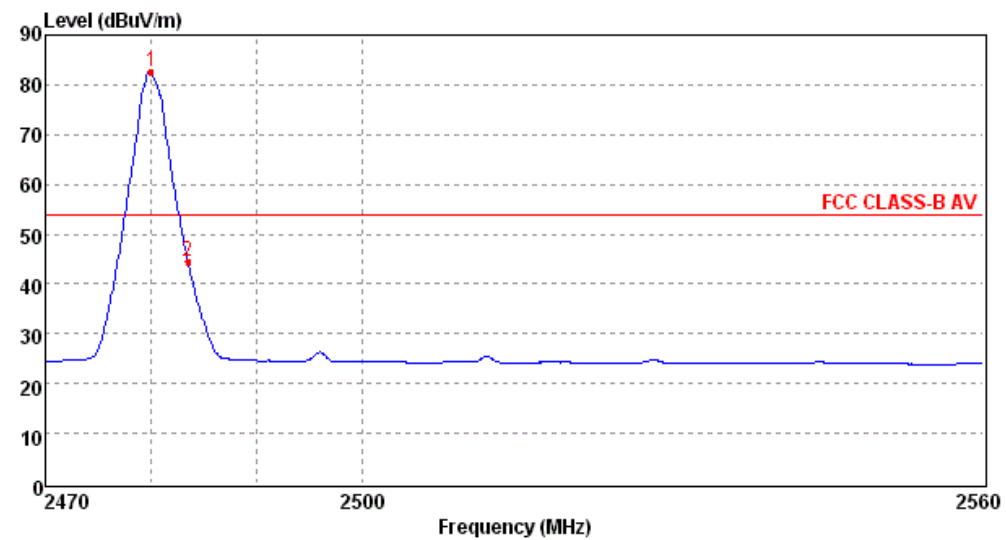

Mark	Frequency (MHz)	Level (dBuV/m)	Cable Loss (dB)	Antenna Factor (dB/m)	Preamp Factor (dB)	Reading Level (dBuV/m)	Limit (dBuV/m)	Margin (dB)	Detector
1	2480.01	82.74	3.88	27.45	36.55	87.96	54.00	-28.74	Average
2	2483.50	44.56	3.88	27.45	36.55	49.78	54.00	9.44	Average

Test Mode:	$\pi/4$ QPSK	Polarization:	Horizontal
-------------------	--------------	----------------------	------------

Data: 53

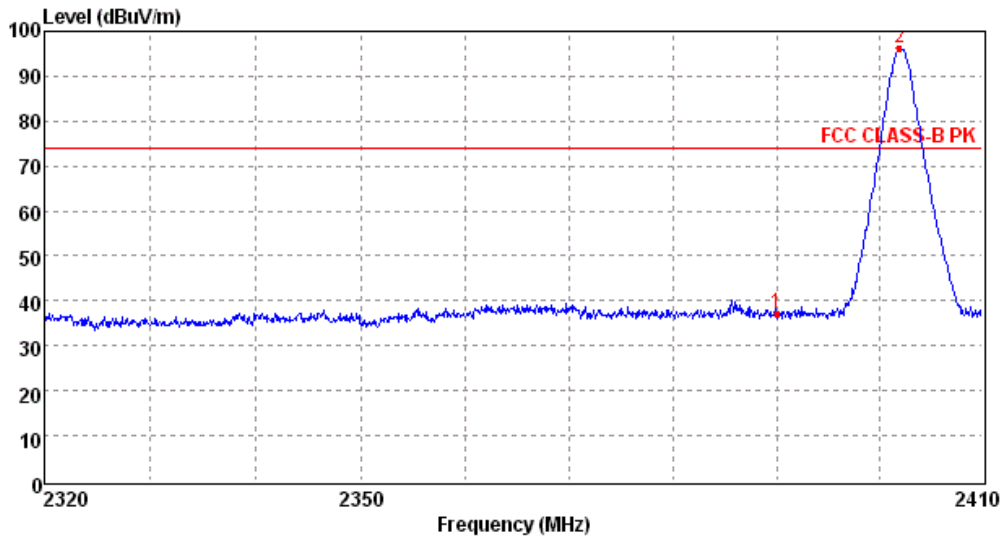

Mark	Frequency (MHz)	Level (dBuV/m)	Cable Loss (dB)	Antenna Factor (dB/m)	Preamp Factor (dB)	Reading Level (dBuV/m)	Limit (dBuV/m)	Margin (dB)	Detector
1	2390.00	37.03	3.32	27.49	36.12	42.31	74.00	36.97	Peak
2	2401.94	96.30	3.32	27.49	36.12	101.61	74.00	-22.30	Peak

Data: 51

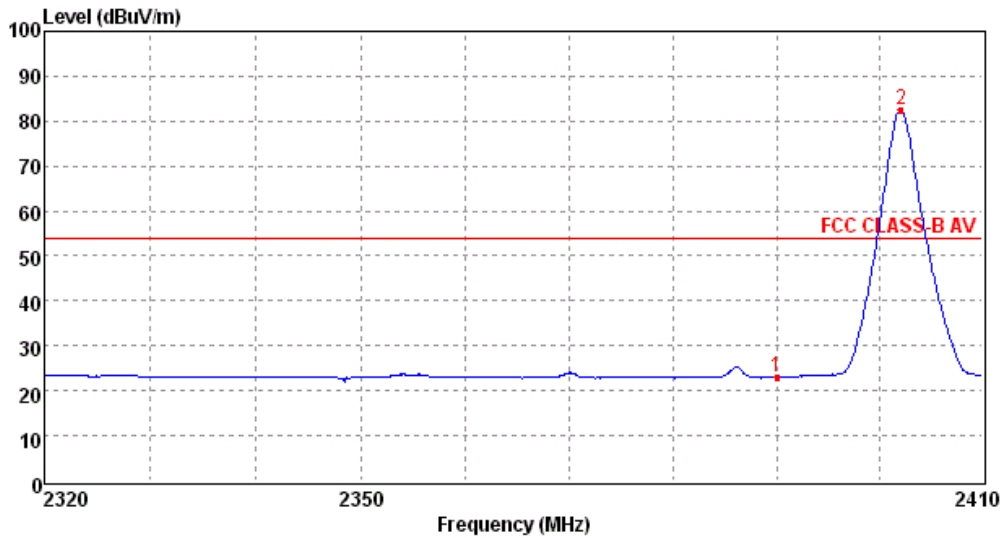

Mark	Frequency (MHz)	Level (dBuV/m)	Cable Loss (dB)	Antenna Factor (dB/m)	Preamp Factor (dB)	Reading Level (dBuV/m)	Limit (dBuV/m)	Margin (dB)	Detector
1	2390.00	22.96	3.32	27.49	36.12	28.24	54.00	31.04	Average
2	2402.13	82.69	3.32	27.49	36.12	88.00	54.00	-28.69	Average

Test Mode:	$\pi/4$ DQPSK	Polarization:	Vertical
-------------------	---------------	----------------------	-----------------

Data: 54

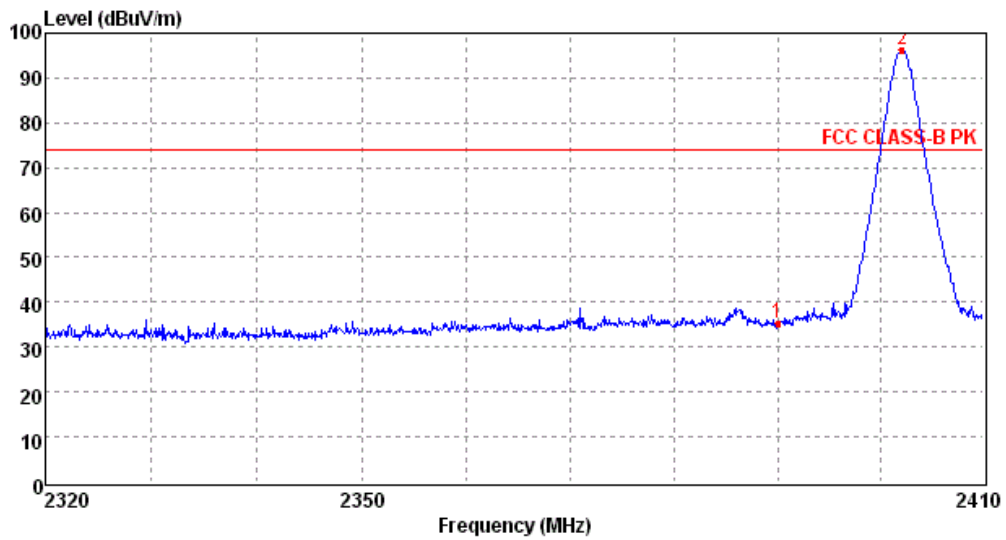

Mark	Frequency (MHz)	Level (dBuV/m)	Cable Loss (dB)	Antenna Factor (dB/m)	Preamp Factor (dB)	Reading Level (dBuV/m)	Limit (dBuV/m)	Margin (dB)	Detector
1	2390.00	35.38	3.32	27.49	36.12	40.66	74.00	38.62	Peak
2	2402.13	96.13	3.32	27.49	36.12	101.44	74.00	-22.13	Peak

Data: 52

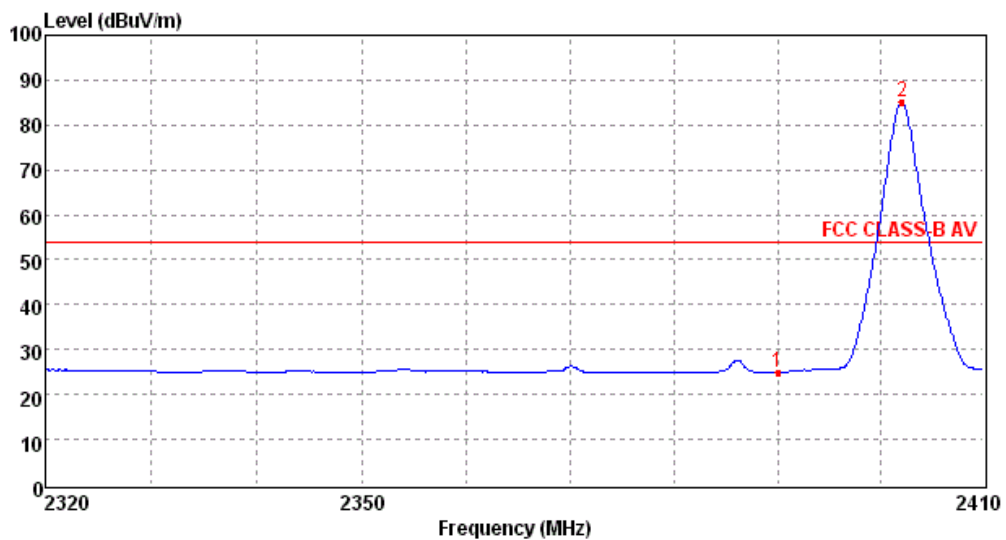

Mark	Frequency (MHz)	Level (dBuV/m)	Cable Loss (dB)	Antenna Factor (dB/m)	Preamp Factor (dB)	Reading Level (dBuV/m)	Limit (dBuV/m)	Margin (dB)	Detector
1	2390.00	25.02	3.32	27.49	36.12	30.30	54.00	28.98	Average
2	2402.13	85.17	3.32	27.49	36.12	90.48	54.00	-31.17	Average

Test Mode:	$\pi/4$DQPSK	Polarization:	Horizontal
-------------------	--------------------------------	----------------------	-------------------

Data: 57

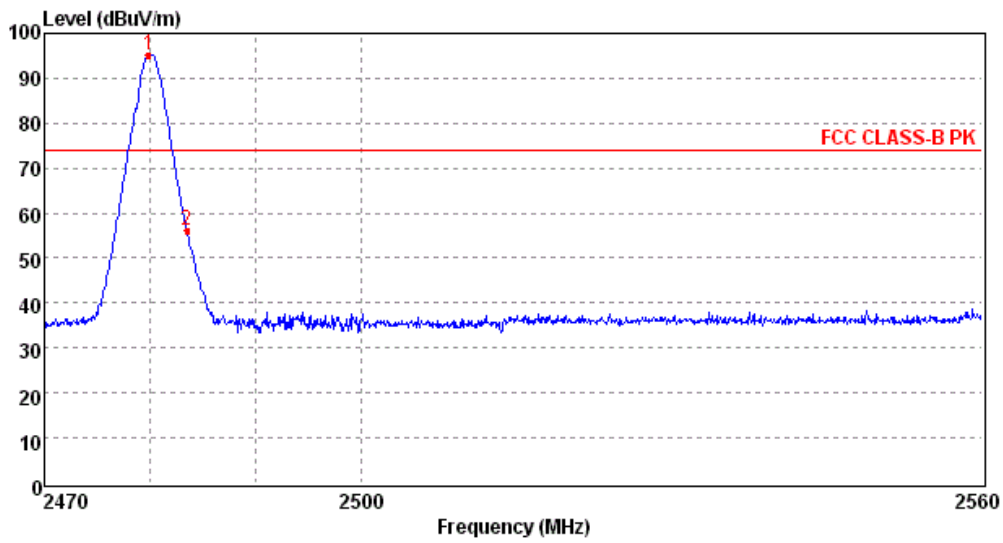

Mark	Frequency (MHz)	Level (dBuV/m)	Cable Loss (dB)	Antenna Factor (dB/m)	Preamp Factor (dB)	Reading Level (dBuV/m)	Limit (dBuV/m)	Margin (dB)	Detector
1	2479.83	95.35	3.88	27.45	36.55	100.57	74.00	-21.35	Peak
2	2483.47	56.27	3.88	27.45	36.55	61.49	74.00	17.73	Peak

Data: 55

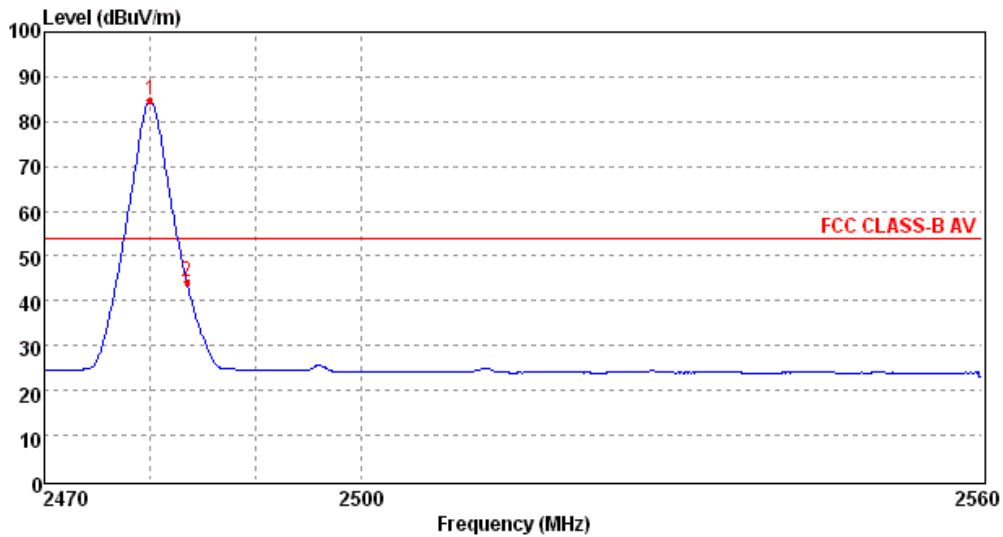

Mark	Frequency (MHz)	Level (dBuV/m)	Cable Loss (dB)	Antenna Factor (dB/m)	Preamp Factor (dB)	Reading Level (dBuV/m)	Limit (dBuV/m)	Margin (dB)	Detector
1	2480.01	84.63	3.88	27.45	36.55	89.85	54.00	-30.63	Average
2	2483.50	44.27	3.88	27.45	36.55	49.49	54.00	9.73	Average

Test Mode:	$\pi/4$ DQPSK	Polarization:	Vertical
-------------------	---------------	----------------------	-----------------

Data: 58

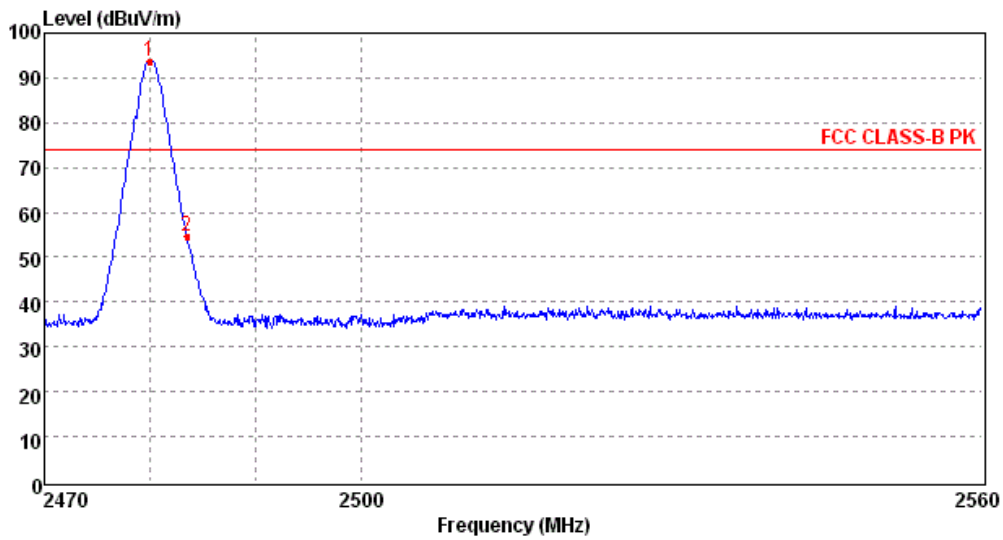

Mark	Frequency (MHz)	Level (dBUV/m)	Cable Loss (dB)	Antenna Factor (dB/m)	Preamp Factor (dB)	Reading Level (dBUV/m)	Limit (dBUV/m)	Margin (dB)	Detector
1	2479.92	93.76	3.88	27.45	36.55	98.98	74.00	-19.76	Peak
2	2483.50	54.68	3.88	27.45	36.55	59.90	74.00	19.32	Peak

Data: 56

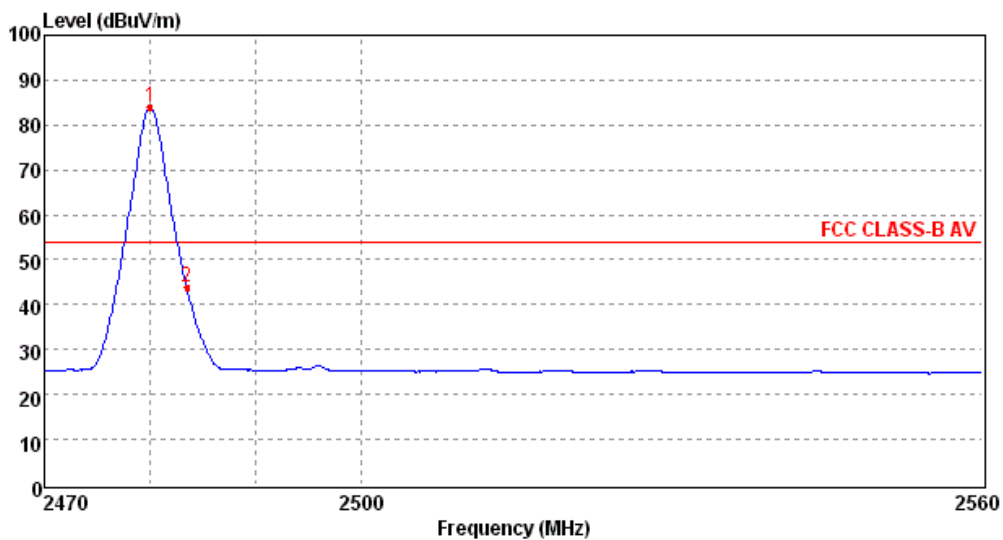

Mark	Frequency (MHz)	Level (dBUV/m)	Cable Loss (dB)	Antenna Factor (dB/m)	Preamp Factor (dB)	Reading Level (dBUV/m)	Limit (dBUV/m)	Margin (dB)	Detector
1	2480.01	83.97	3.88	27.45	36.55	89.19	54.00	-29.97	Average
2	2483.50	43.78	3.88	27.45	36.55	49.00	54.00	10.22	Average

Test Mode:	8DPSK	Polarization:	Horizontal
-------------------	--------------	----------------------	-------------------

Data: 44

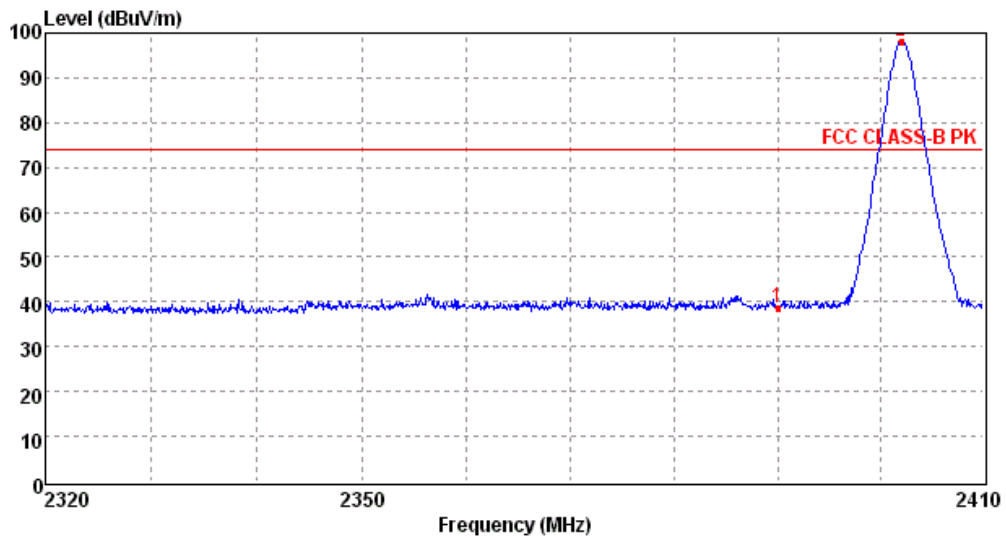

Mark	Frequency (MHz)	Level (dBuV/m)	Cable Loss (dB)	Antenna Factor (dB/m)	Preamp Factor (dB)	Reading Level (dBuV/m)	Limit (dBuV/m)	Margin (dB)	Detector
1	2390.00	38.48	3.32	27.49	36.12	43.76	74.00	35.52	Peak
2	2402.03	98.14	3.32	27.49	36.12	103.45	74.00	-24.14	Peak

Data: 42

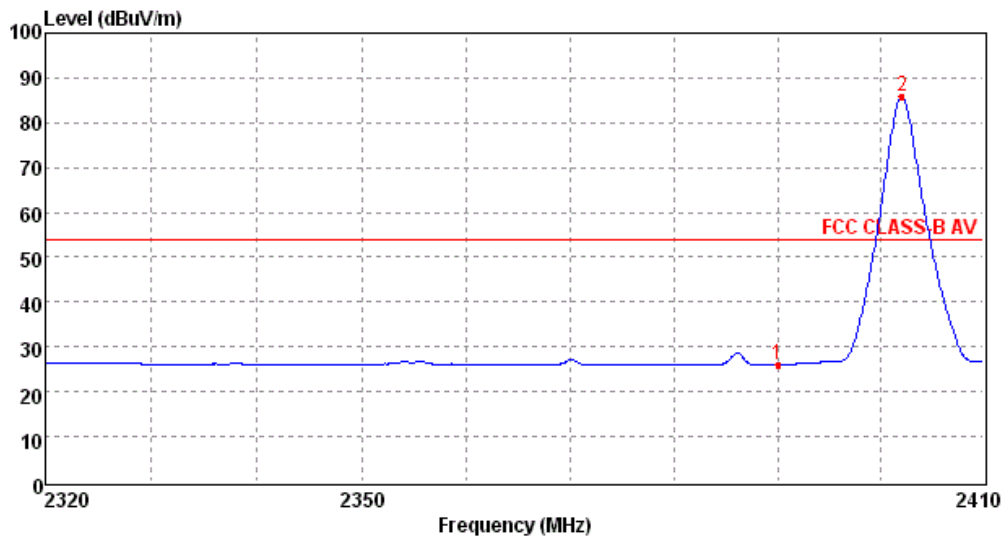

Mark	Frequency (MHz)	Level (dBuV/m)	Cable Loss (dB)	Antenna Factor (dB/m)	Preamp Factor (dB)	Reading Level (dBuV/m)	Limit (dBuV/m)	Margin (dB)	Detector
1	2390.00	26.02	3.32	27.49	36.12	31.30	54.00	27.98	Average
2	2402.13	85.99	3.32	27.49	36.12	91.30	54.00	-31.99	Average

Test Mode:	8DPSK	Polarization:	Vertical
-------------------	--------------	----------------------	-----------------

Data: 45

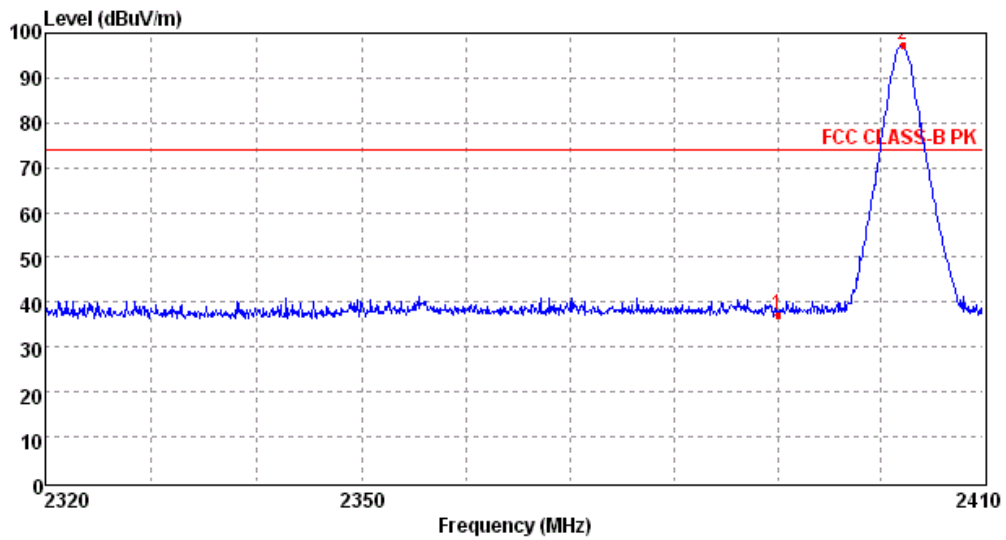

Mark	Frequency (MHz)	Level (dBuV/m)	Cable Loss (dB)	Antenna Factor (dB/m)	Preamp Factor (dB)	Reading Level (dBuV/m)	Limit (dBuV/m)	Margin (dB)	Detector
1	2390.00	37.16	3.32	27.49	36.12	42.44	74.00	36.84	Peak
2	2402.22	97.35	3.32	27.49	36.12	102.66	74.00	-23.35	Peak

Data: 43

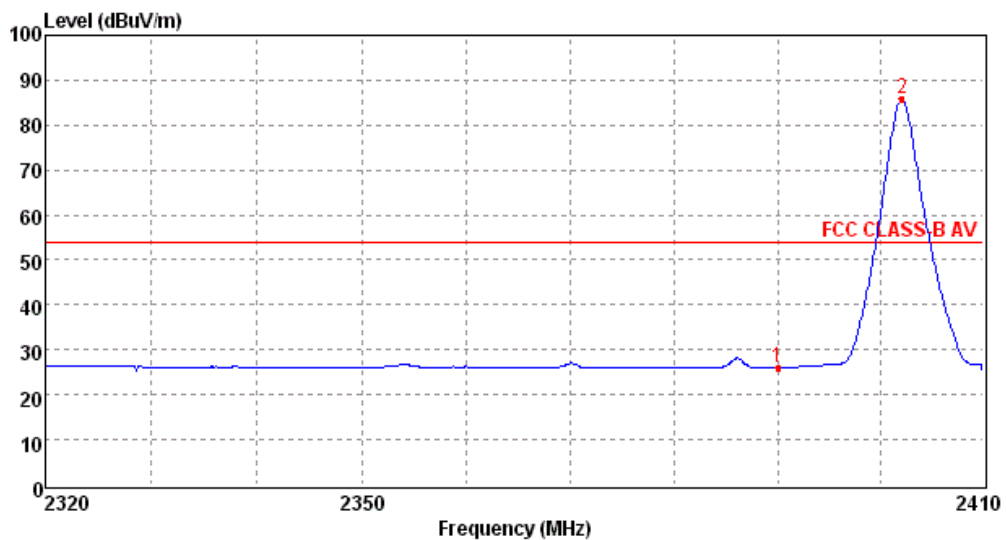

Mark	Frequency (MHz)	Level (dBuV/m)	Cable Loss (dB)	Antenna Factor (dB/m)	Preamp Factor (dB)	Reading Level (dBuV/m)	Limit (dBuV/m)	Margin (dB)	Detector
1	2390.00	26.00	3.32	27.49	36.12	31.28	54.00	28.00	Average
2	2402.13	85.88	3.32	27.49	36.12	91.19	54.00	-31.88	Average

Test Mode:	8DPSK	Polarization:	Horizontal
-------------------	--------------	----------------------	-------------------

Data: 49

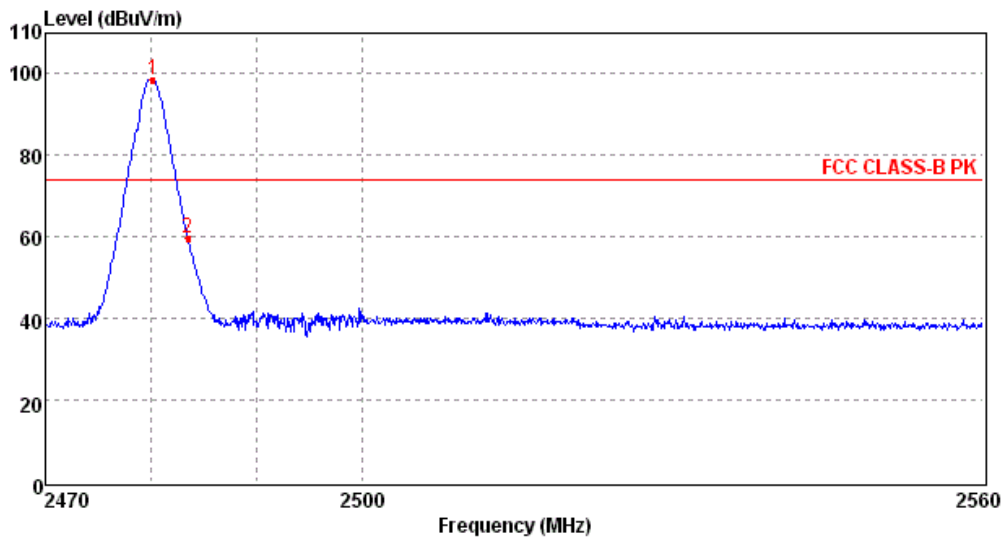

Mark	Frequency (MHz)	Level (dBuV/m)	Cable Loss (dB)	Antenna Factor (dB/m)	Preamp Factor (dB)	Reading Level (dBuV/m)	Limit (dBuV/m)	Margin (dB)	Detector
1	2480.19	95.68	3.88	27.45	36.55	103.90	74.00	-24.68	Peak
2	2483.50	59.69	3.88	27.45	36.55	64.91	74.00	14.31	Peak

Data: 46

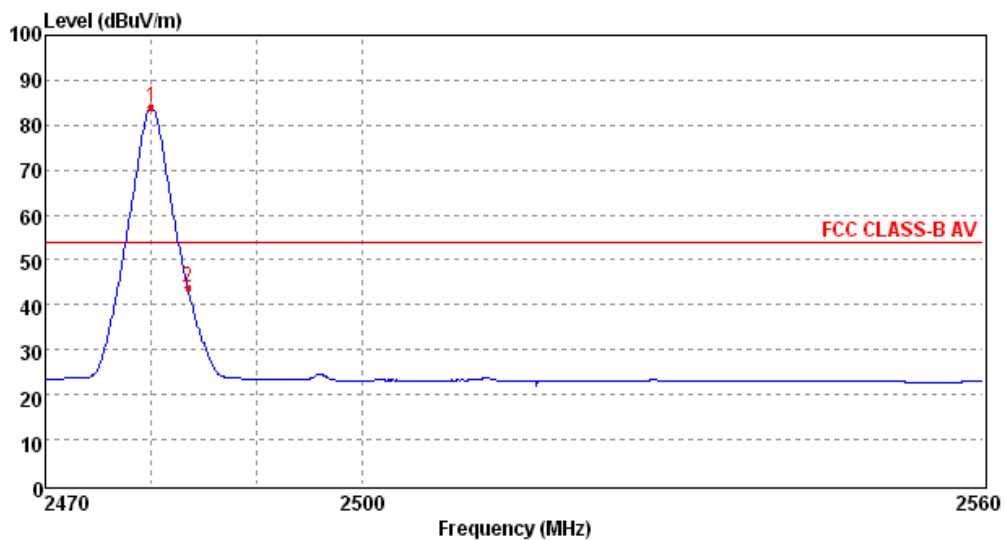

Mark	Frequency (MHz)	Level (dBuV/m)	Cable Loss (dB)	Antenna Factor (dB/m)	Preamp Factor (dB)	Reading Level (dBuV/m)	Limit (dBuV/m)	Margin (dB)	Detector
1	2480.01	83.97	3.88	27.45	36.55	89.19	54.00	-29.97	Average
2	2483.50	43.79	3.88	27.45	36.55	49.01	54.00	10.21	Average

Test Mode:	8DPSK	Polarization:	Vertical
-------------------	--------------	----------------------	-----------------

Data: 50

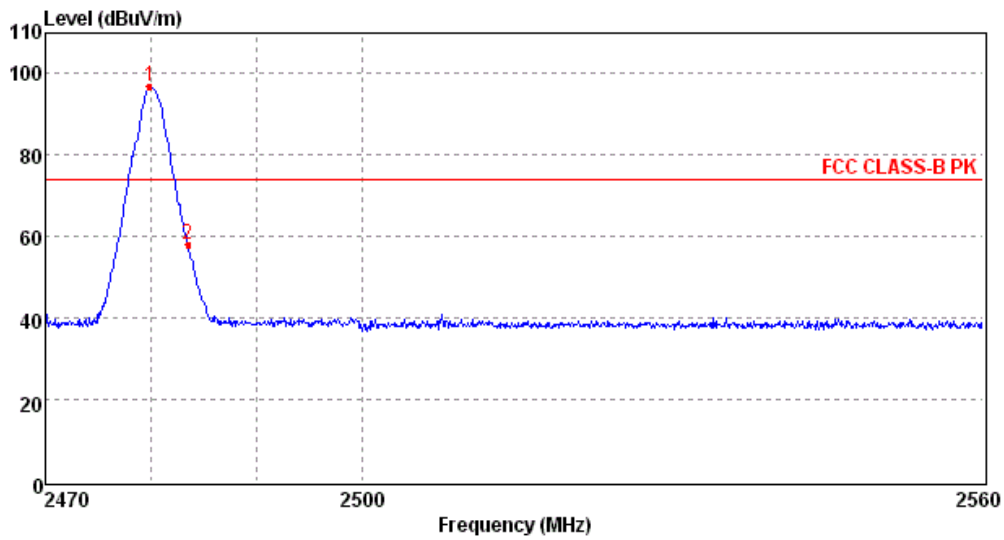

Mark	Frequency (MHz)	Level (dBuV/m)	Cable Loss (dB)	Antenna Factor (dB/m)	Preamp Factor (dB)	Reading Level (dBuV/m)	Limit (dBuV/m)	Margin (dB)	Detector
1	2479.83	96.72	3.88	27.45	36.55	101.94	74.00	-22.72	Peak
2	2483.50	57.91	3.88	27.45	36.55	63.13	74.00	16.09	Peak

Data: 47

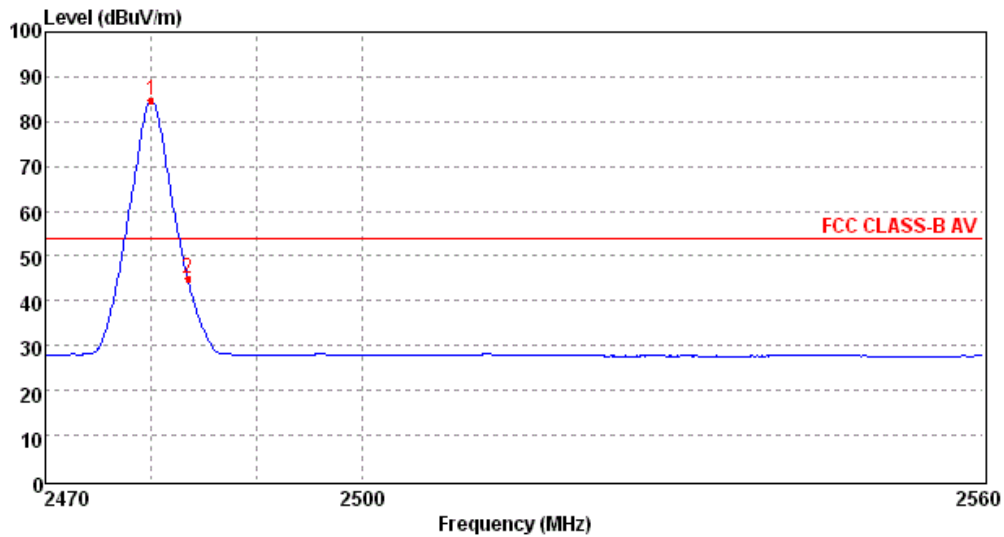

Mark	Frequency (MHz)	Level (dBuV/m)	Cable Loss (dB)	Antenna Factor (dB/m)	Preamp Factor (dB)	Reading Level (dBuV/m)	Limit (dBuV/m)	Margin (dB)	Detector
1	2480.01	84.79	3.88	27.45	36.55	90.01	54.00	-30.79	Average
2	2483.50	44.88	3.88	27.45	36.55	50.10	54.00	9.12	Average

B. Conducted Bandedge Measurement

GFSK

Frequency (MHz)	Delta Peak to Band emission (dBc)	Hopping Mode	Limit (dBc)	Verdict
2400.00	55.41	OFF	20	PASS
2400.00	55.53	ON	20	PASS
2483.50	56.15	OFF	20	PASS
2483.50	55.72	ON	20	PASS

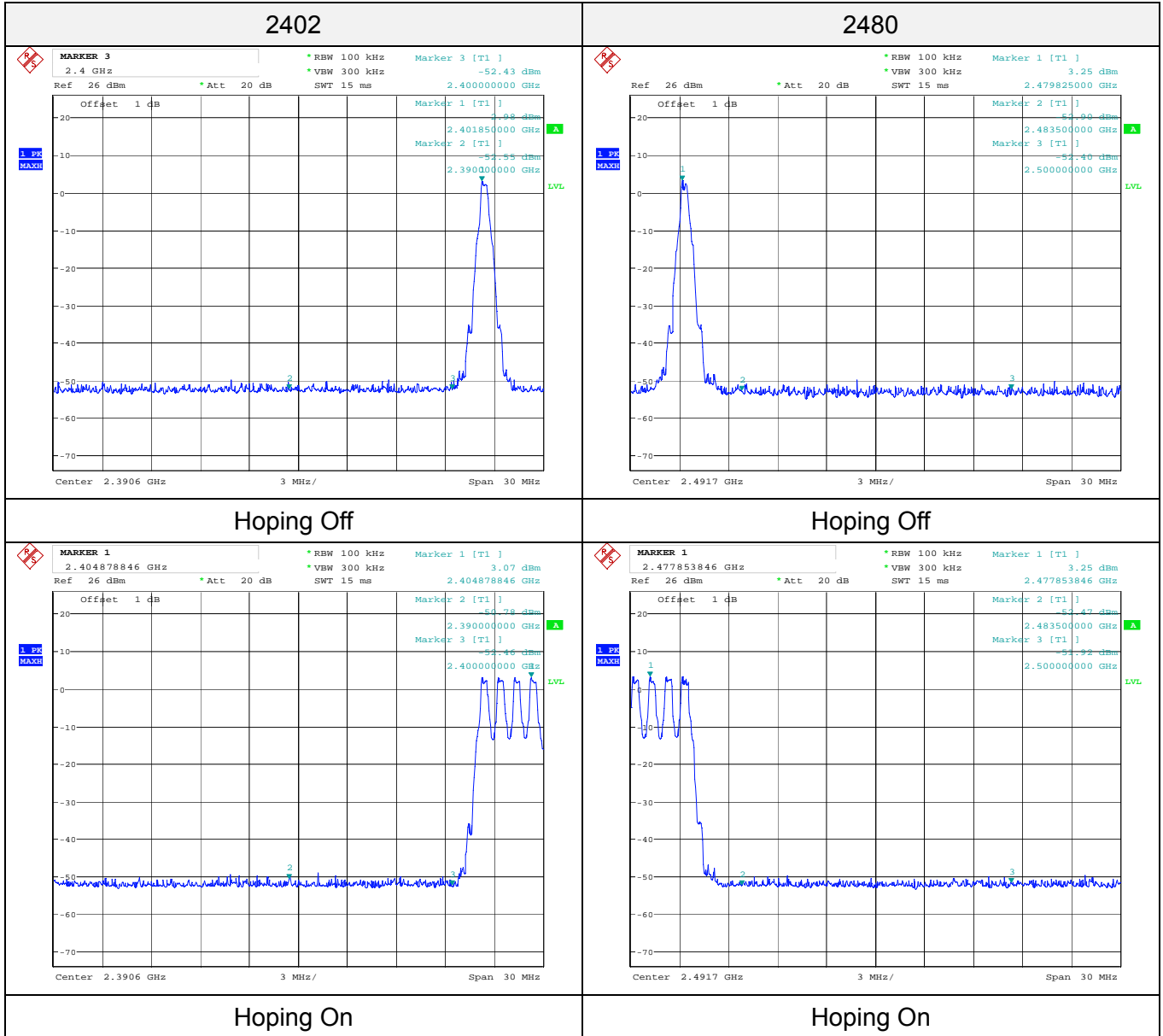

$\pi/4$ DQPSK

Frequency (MHz)	Delta Peak to Band emission (dBc)	Hopping Mode	Limit (dBc)	Verdict
2400.00	53.89	OFF	20	PASS
2400.00	54.39	ON	20	PASS
2483.50	55.74	OFF	20	PASS
2483.50	54.49	ON	20	PASS

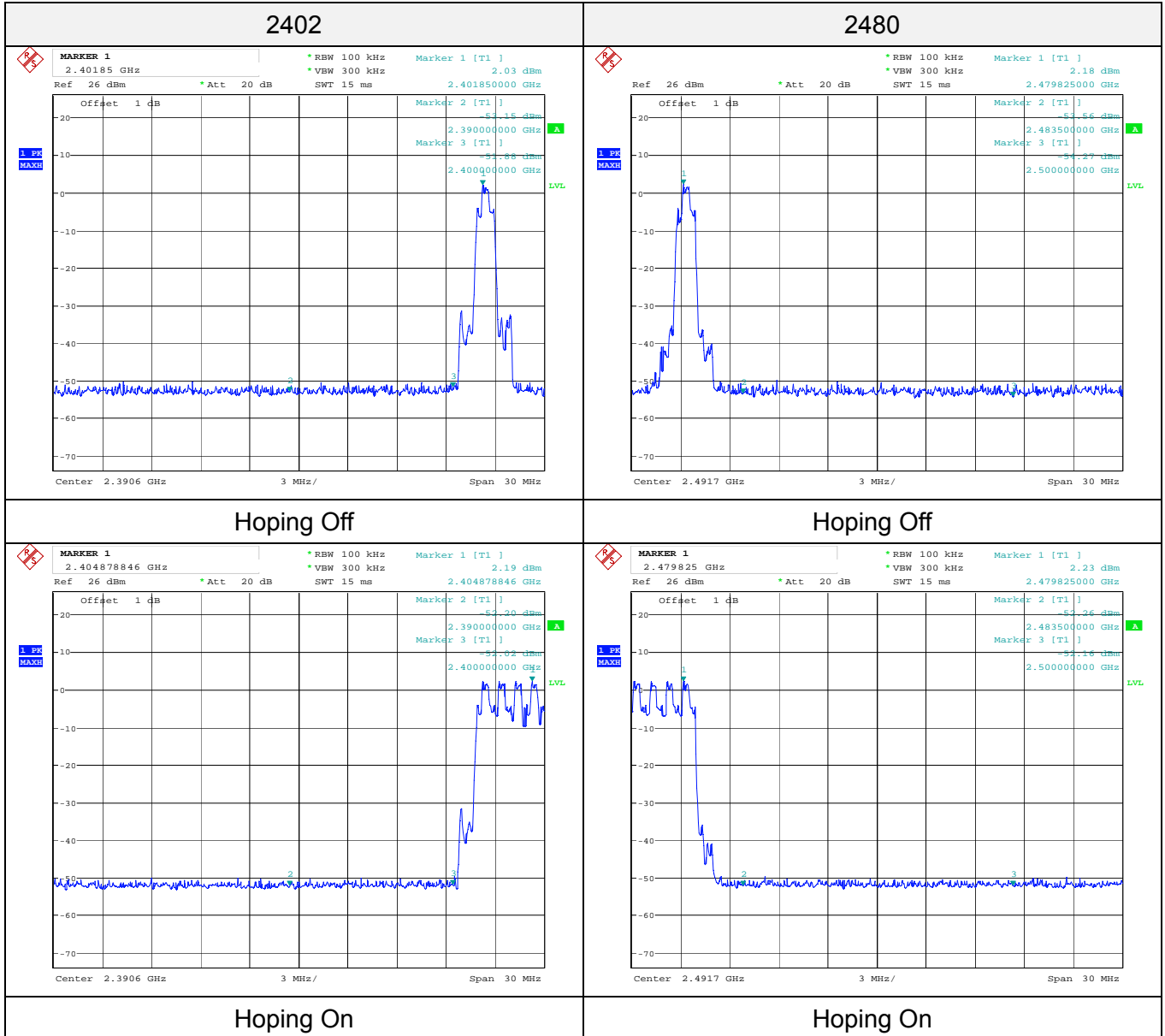

8DPSK

Frequency (MHz)	Delta Peak to Band emission (dBc)	Hopping Mode	Limit (dBc)	Verdict
2400.00	53.89	OFF	20	PASS
2400.00	53.32	ON	20	PASS
2483.50	53.61	OFF	20	PASS
2483.50	53.56	ON	20	PASS

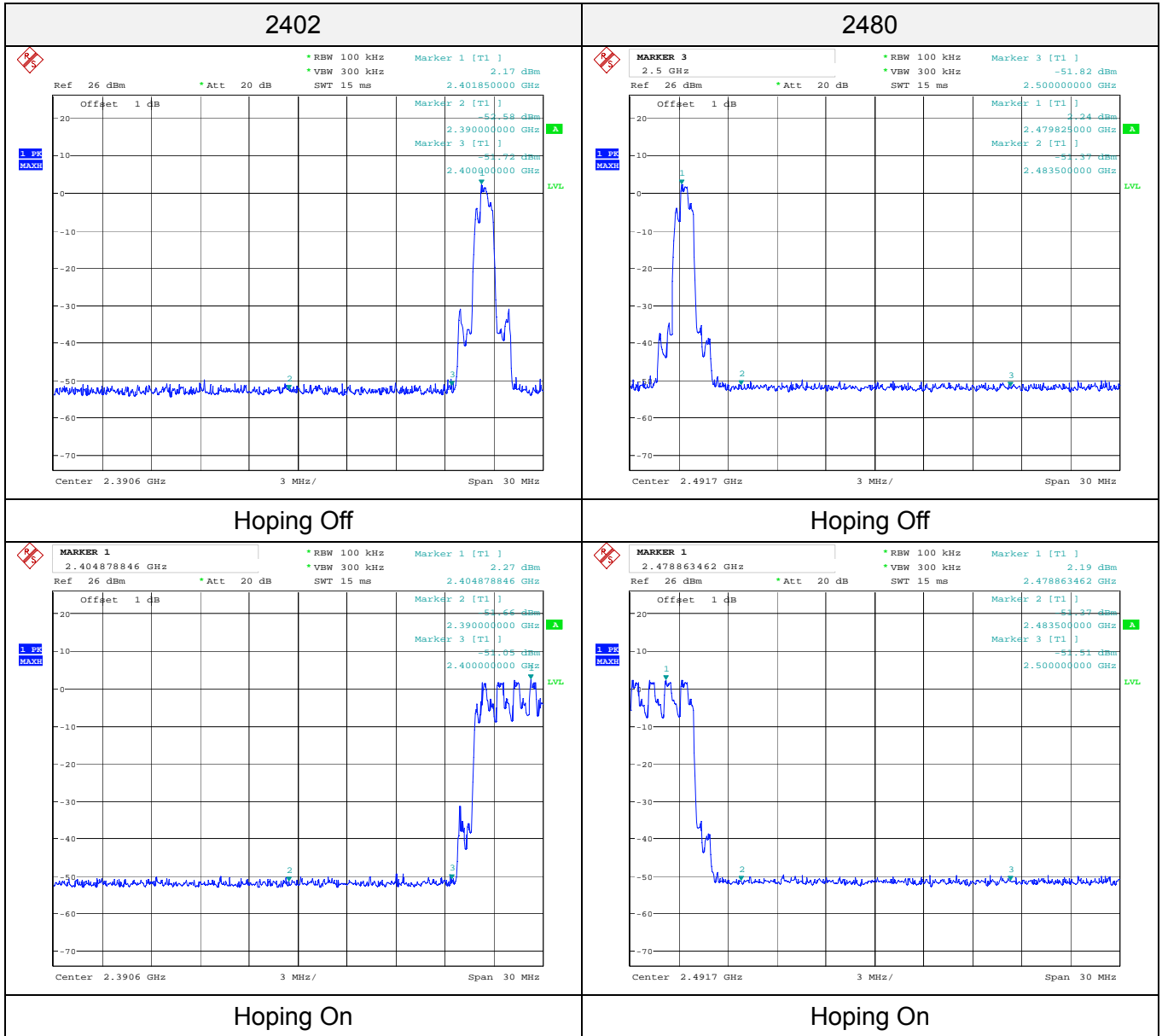

3.6. Frequency Separation

LIMIT

According to 15.247(a)(1), frequency hopping systems shall have hopping channel carrier frequencies separated by minimum of 25KHz or the $2/3 \times 20\text{dB}$ bandwidth of the hopping channel, whichever is greater.

TEST PROCEDURE

The transmitter output was connected to the spectrum analyzer through an attenuator. The bandwidth of the fundamental frequency was measured by spectrum analyzer with 30 KHz RBW and 100KHz VBW.

TEST CONFIGURATION

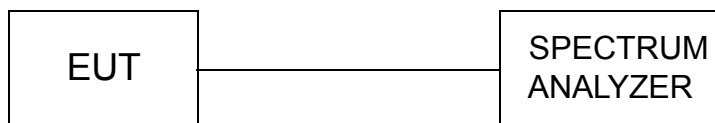

TEST RESULTS

Modulation	Channel	Channel Separation (MHz)	Limit(MHz)	Result
GFSK	CH39	1.004	25KHz or $2/3 \times 20\text{dB}$ bandwidth	Pass
	CH40			
$\pi/4$ DQPSK	CH39	1.004	25KHz or $2/3 \times 20\text{dB}$ bandwidth	Pass
	CH40			
8DPSK	CH39	1.004	25KHz or $2/3 \times 20\text{dB}$ bandwidth	Pass
	CH40			

Note:

We have tested all mode at high, middle and low channel, and recorded worst case at middle

Test plot as follows:

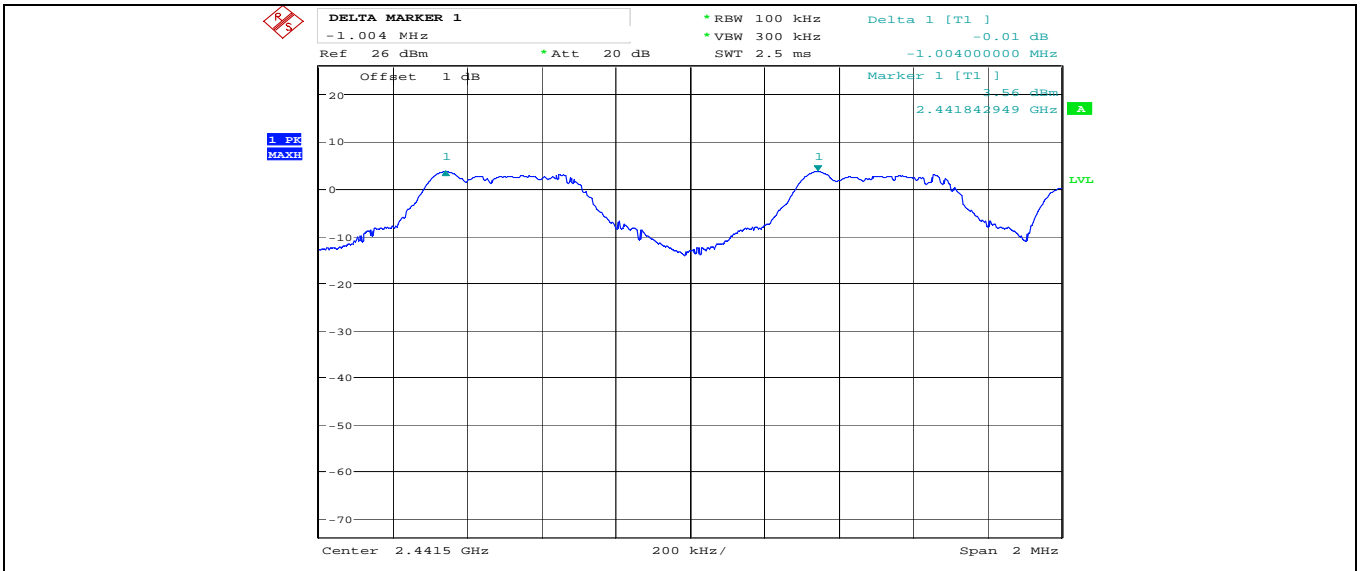

GFSK

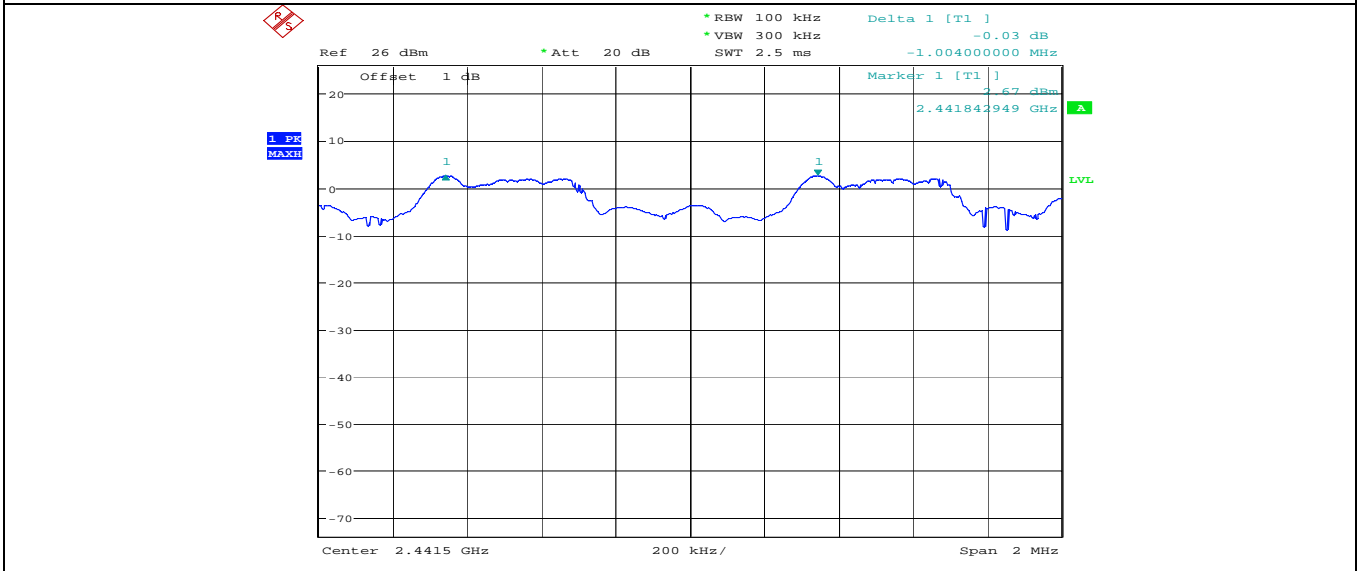

8DPSK

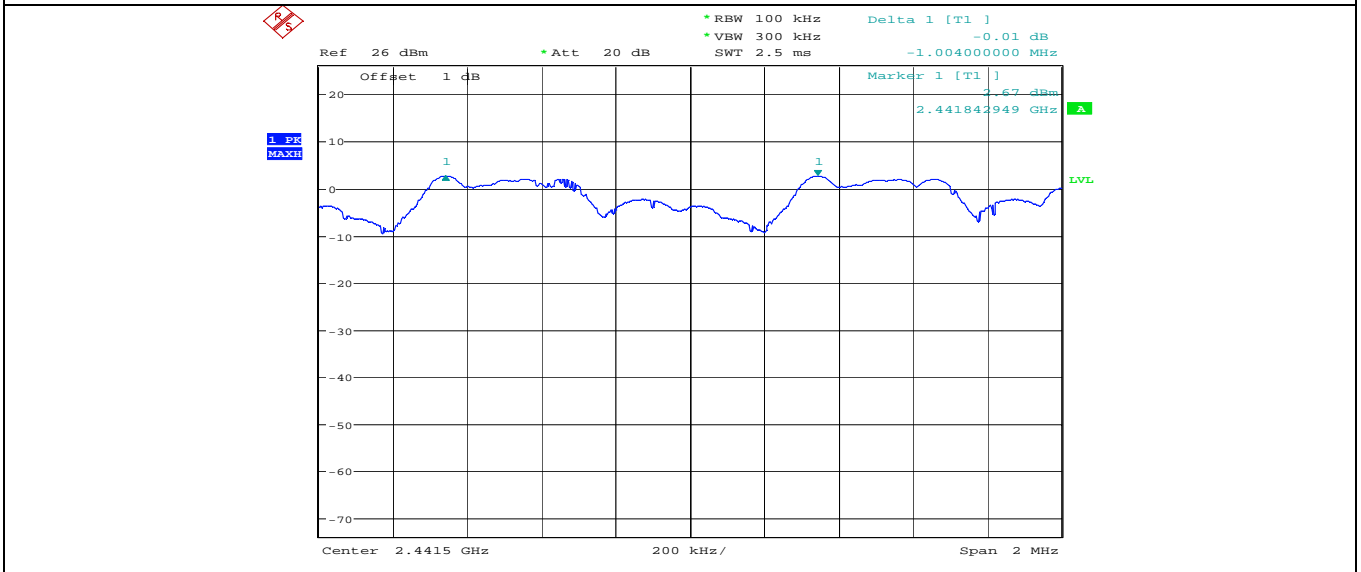

$\pi/4$ DQPSK

3.7. Number of hopping frequency

Limit

Frequency hopping systems in the 2400–2483.5 MHz band shall use at least 15 channels.

Test Procedure

The transmitter output was connected to the spectrum analyzer through an attenuator. Set spectrum analyzer start 2400MHz to 2483.5MHz with 100 KHz RBW and 300 KHz VBW.

Test Configuration

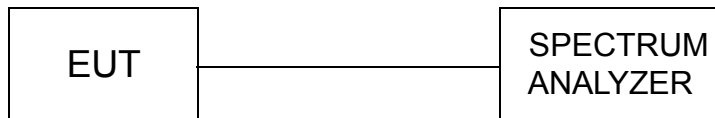

Test Results

Modulation	Number of Hopping Channel	Limit	Result
GFSK	79	≥15	Pass
$\pi/4$ DQPSK	79		
8DPSK	79		

Test plot as follows:

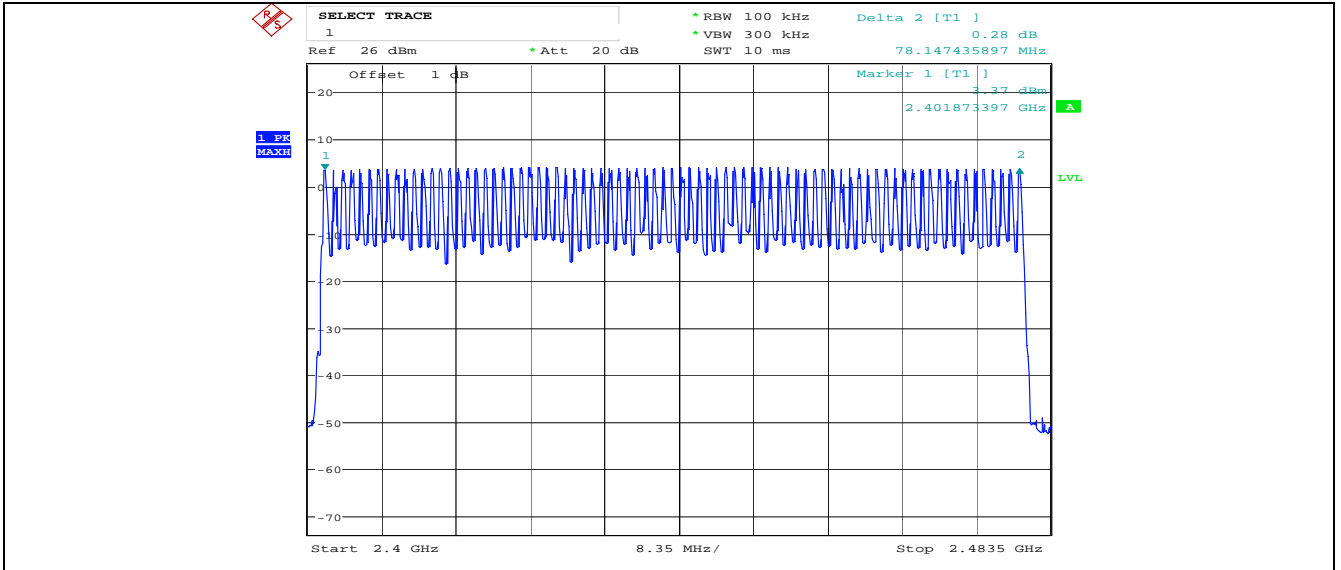

GFSK Modulation

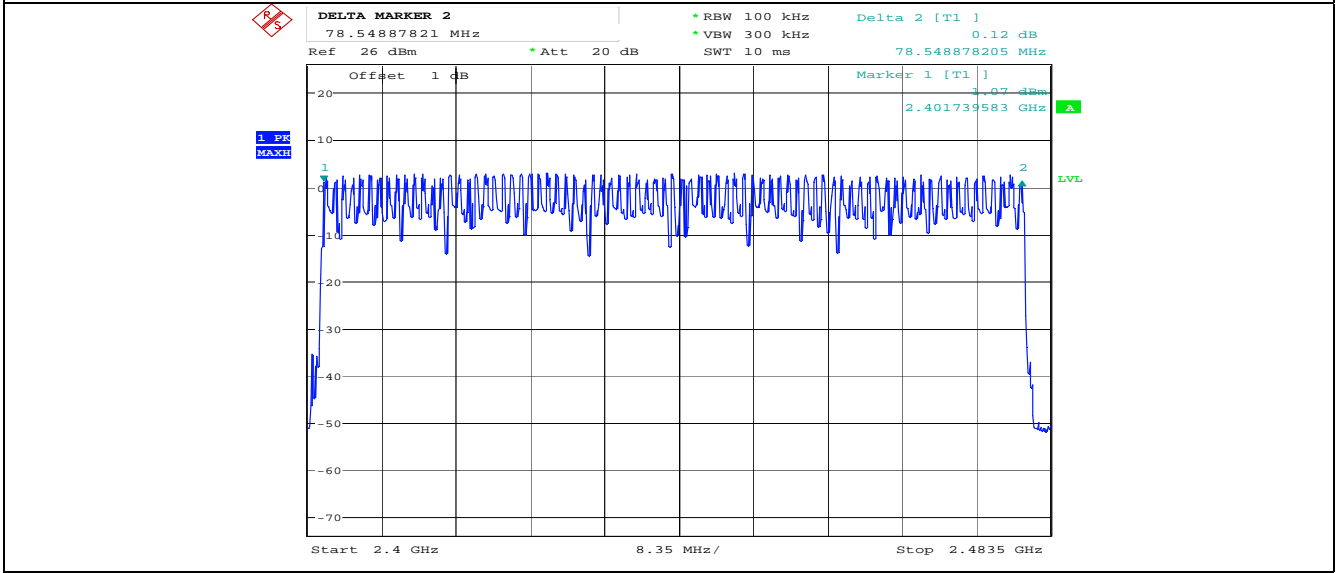

$\pi/4$ DQPSK Modulation

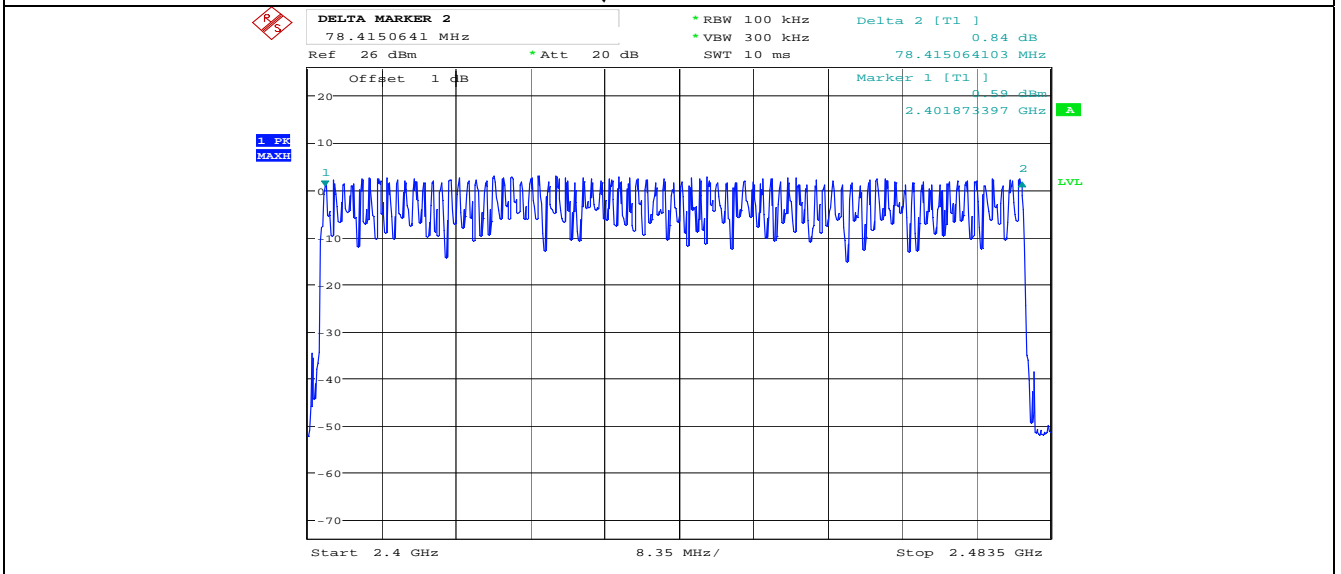

8DPSK Modulation

3.8. Time of Occupancy (Dwell Time)

Limit

The average time of occupancy on any channel shall not be greater than 0.4 seconds within a period of 0.4 seconds multiplied by the number of hopping channels employed.

Test Procedure

The transmitter output was connected to the spectrum analyzer through an attenuator. Set center frequency of spectrum analyzer=operating frequency with 1MHz RBW and 3MHz VBW,Span 0Hz.

Test Configuration

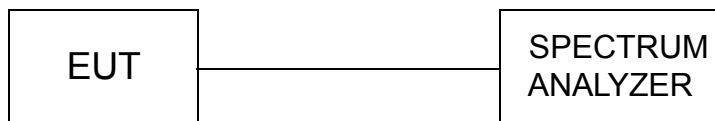

Test Results

Modulation	Packet	Dwell time (second)	Limit (second)	Result
GFSK	DH1	0.124	0.40	Pass
	DH3	0.268		
	DH5	0.310		
π/4DQPSK	2-DH1	0.126	0.40	Pass
	2-DH3	0.267		
	2-DH5	0.311		
8DPSK	3-DH1	0.126	0.40	Pass
	3-DH3	0.265		
	3-DH5	0.312		

Note:

- We have tested all mode at high,middle and low channel,and recoreded worst case at middle channel.
- $Dwell\ time = Pulse\ time\ (ms) \times (1600 \div 2 \div 79) \times 31.6\ Second$ for DH1, 2-DH1, 3-DH1
 $Dwell\ time = Pulse\ time\ (ms) \times (1600 \div 4 \div 79) \times 31.6\ Second$ for DH3, 2-DH3, 3-DH3
 $Dwell\ time = Pulse\ time\ (ms) \times (1600 \div 6 \div 79) \times 31.6\ Second$ for DH5, 2-DH5, 3-DH5

Test plot as follows:

GFSK Modulation

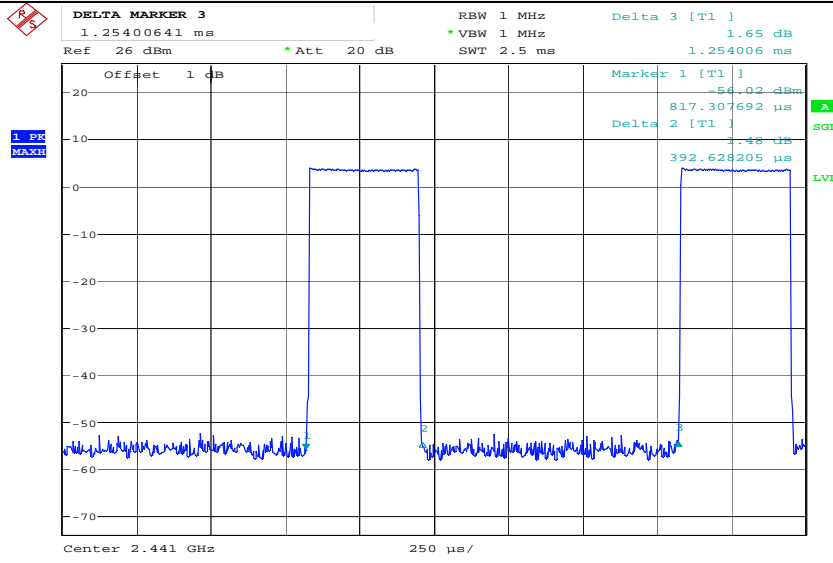

DH1

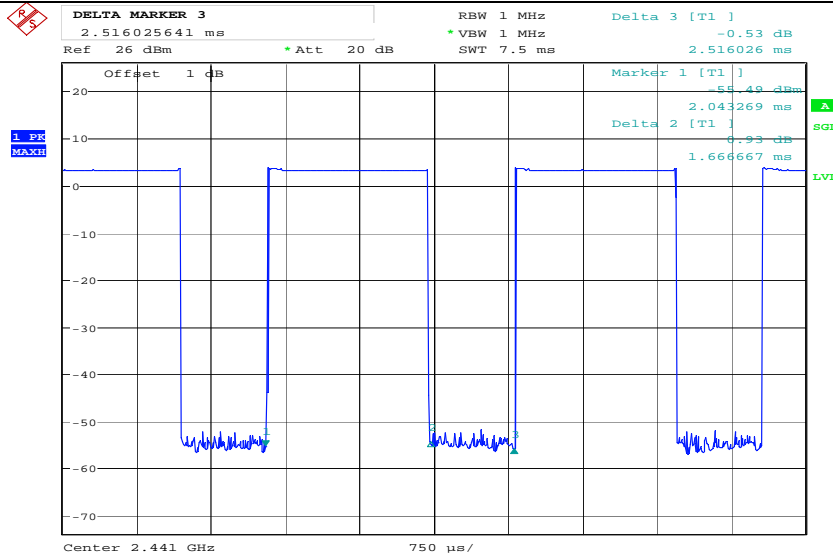

DH3

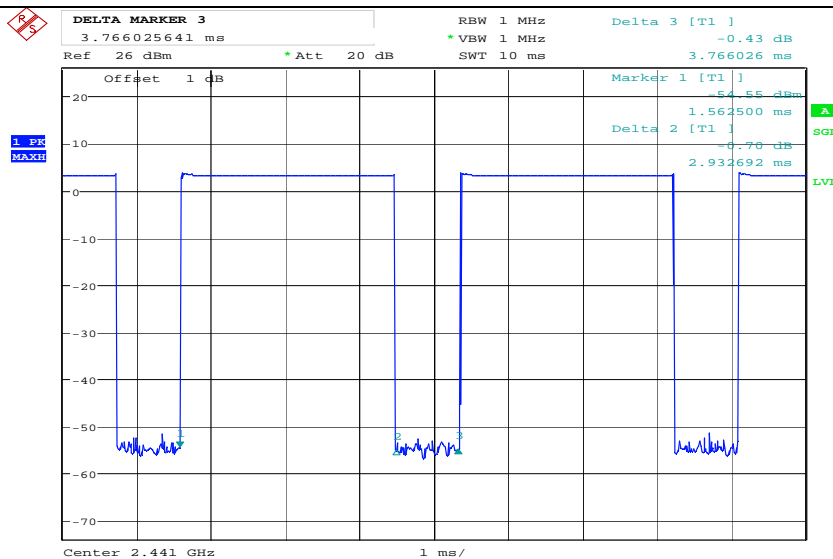

DH5

$\pi/4$ DQPSK Modulation

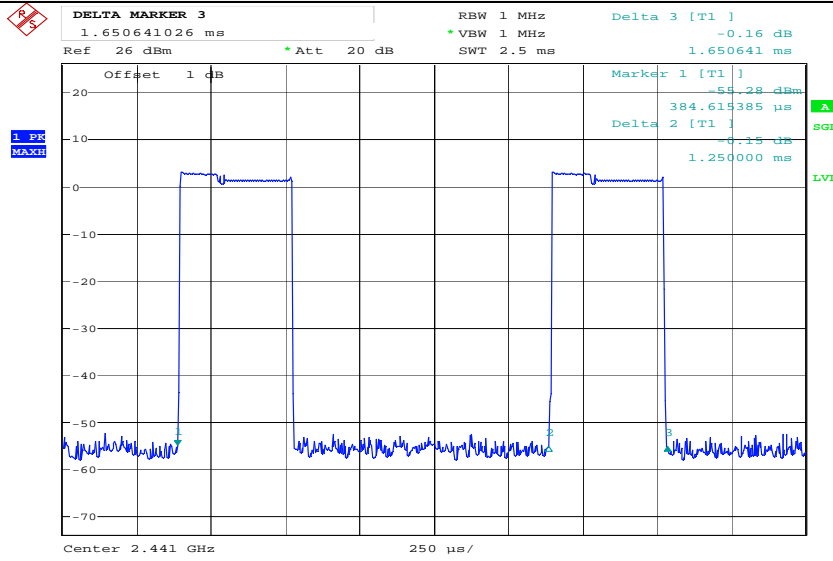

2-DH1

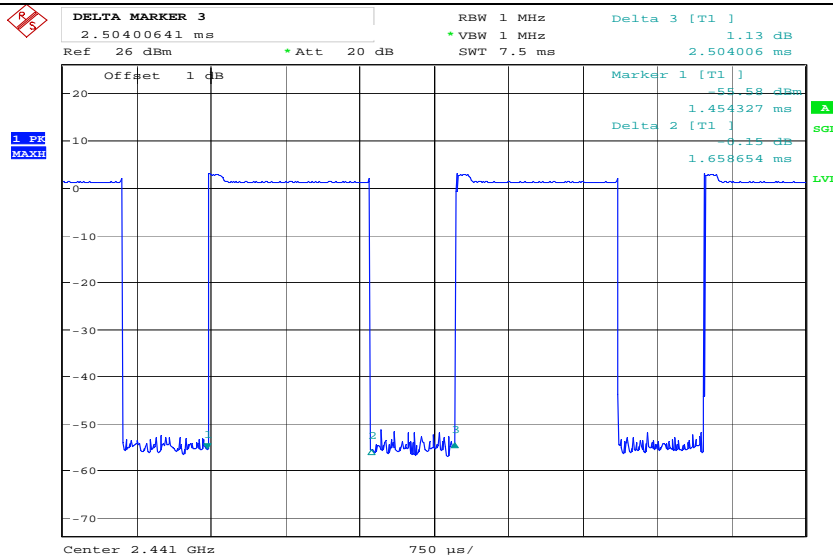

2-DH3

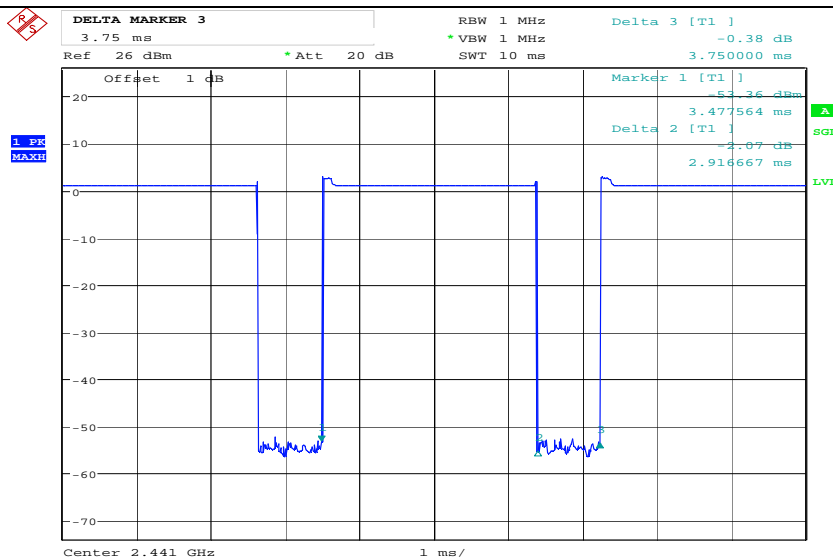

2-DH5

8DPSK Modulation

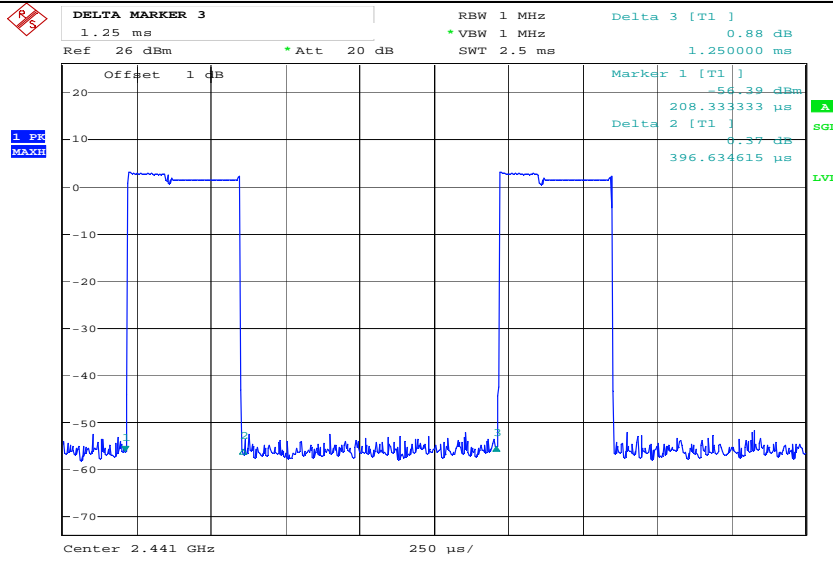

3-DH1

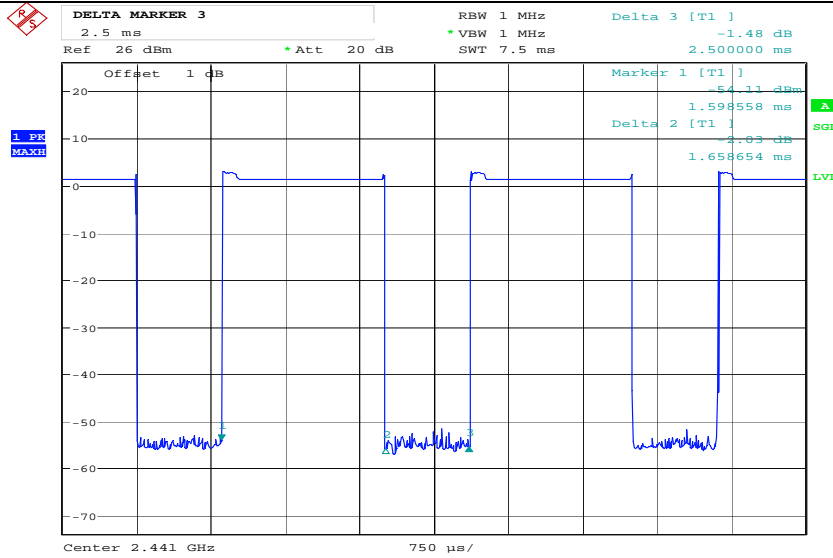

3-DH3

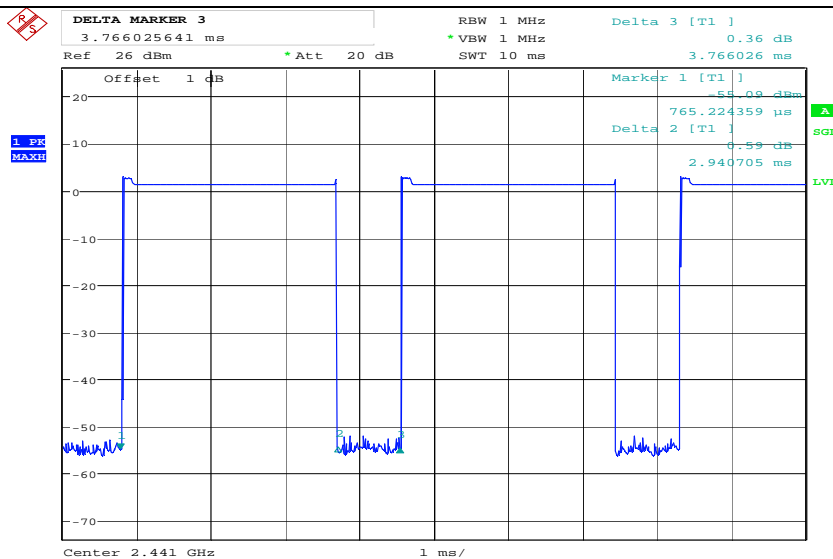

3-DH5

3.9. Spurious RF Conducted Emission

Limit

1. Below -20dB of the highest emission level in operating band.
2. Fall in the restricted bands listed in section 15.205. The maximum permitted average field strength is listed in section 15.209.

Test Procedure

The Spurious RF conducted emissions compliance of RF radiated emission should be measured by following the guidance in ANSI C63.10-2009 with respect to maximizing the emission by rotating the EUT, measuring the emission while the EUT is situated in three orthogonal planes (if appropriate), adjusting the measurement antenna height and polarization etc. Set RBW=100 kHz and VBM= 300 KHz to measure the peak field strength, and measurement frequency range from 30MHz to 26.5GHz.

Test Configuration

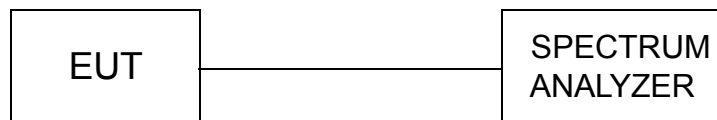

Test Results

Remark: We measured all conditions (DH1, DH3, DH5) and recorded worst case at DH1

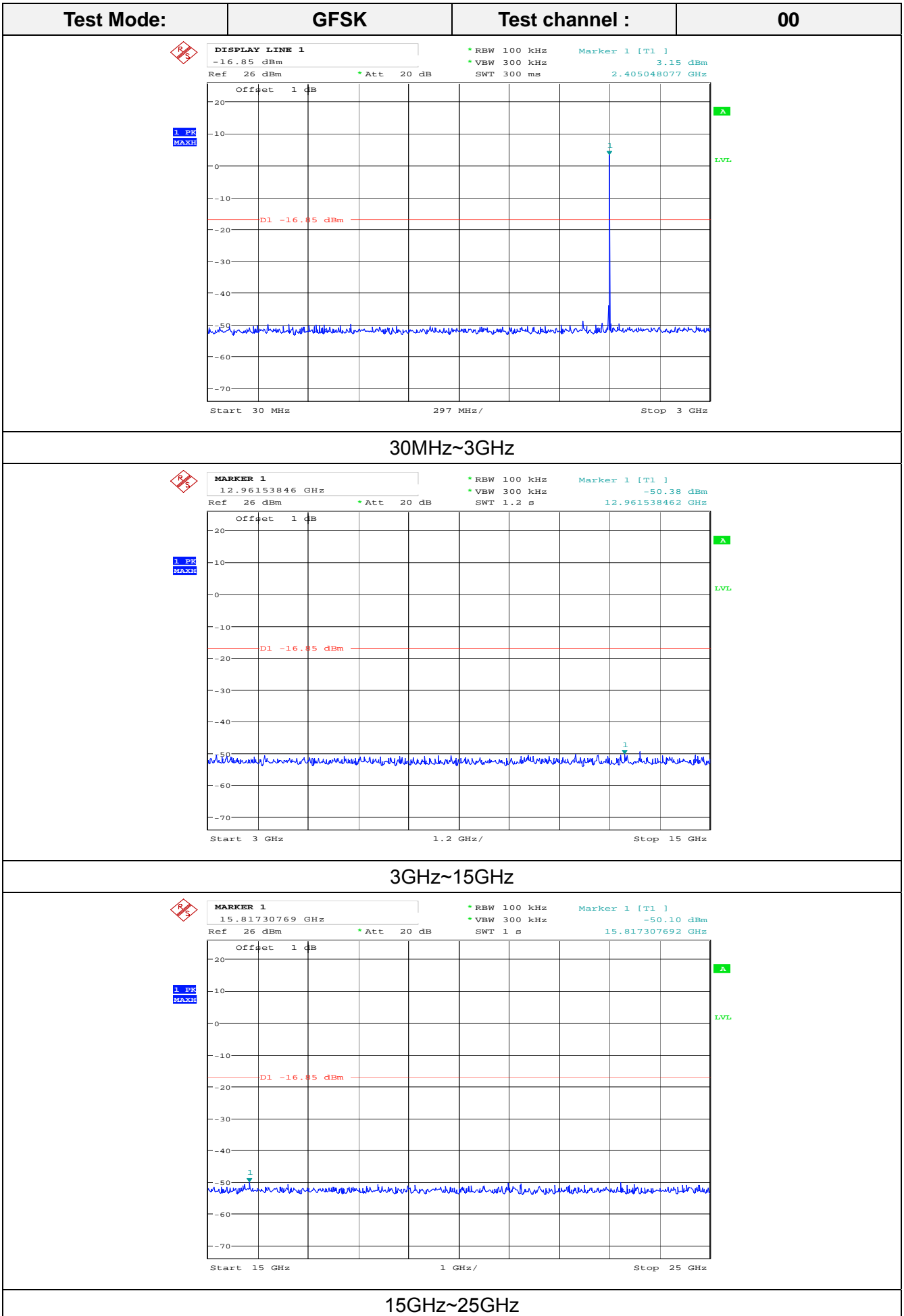

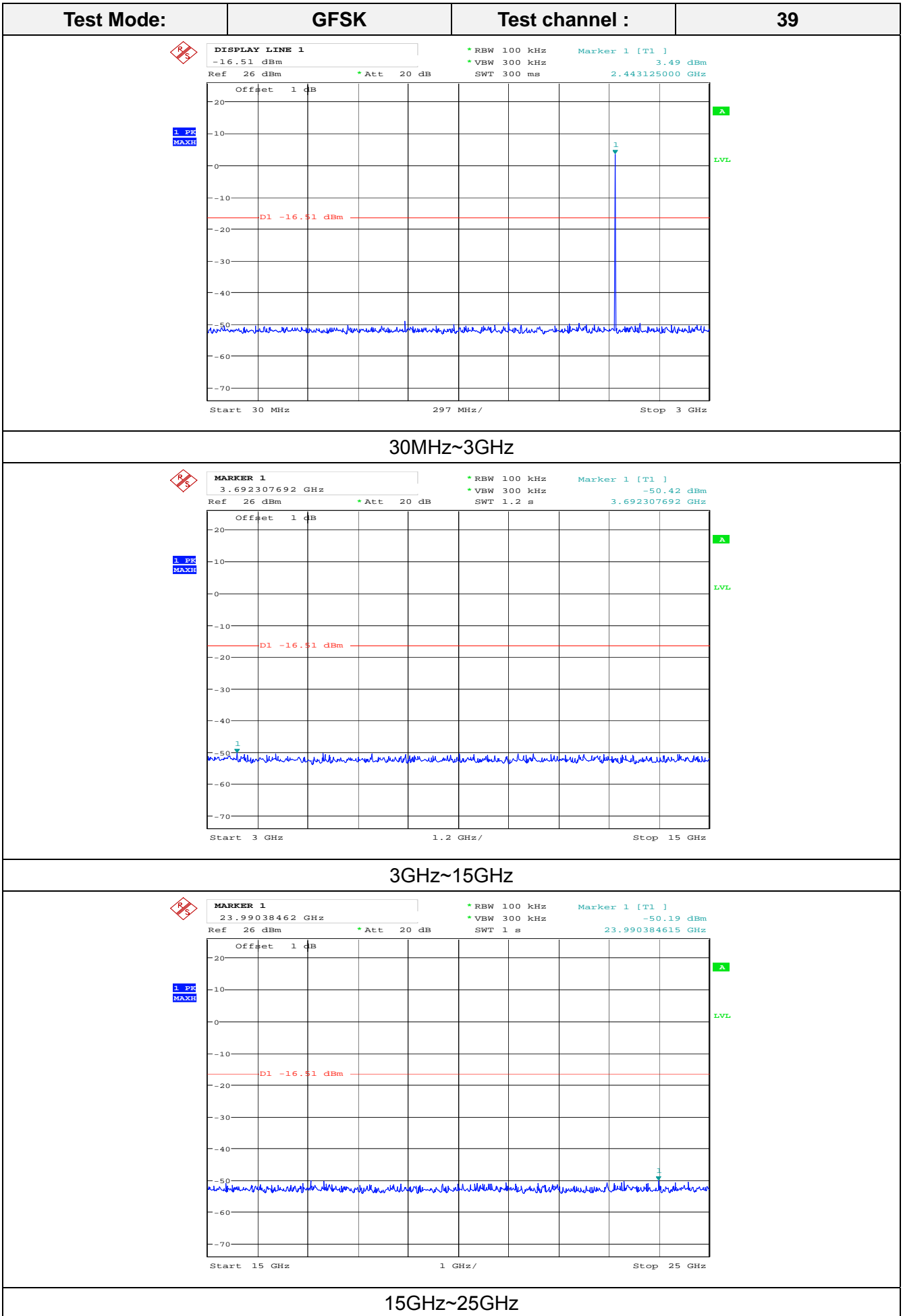

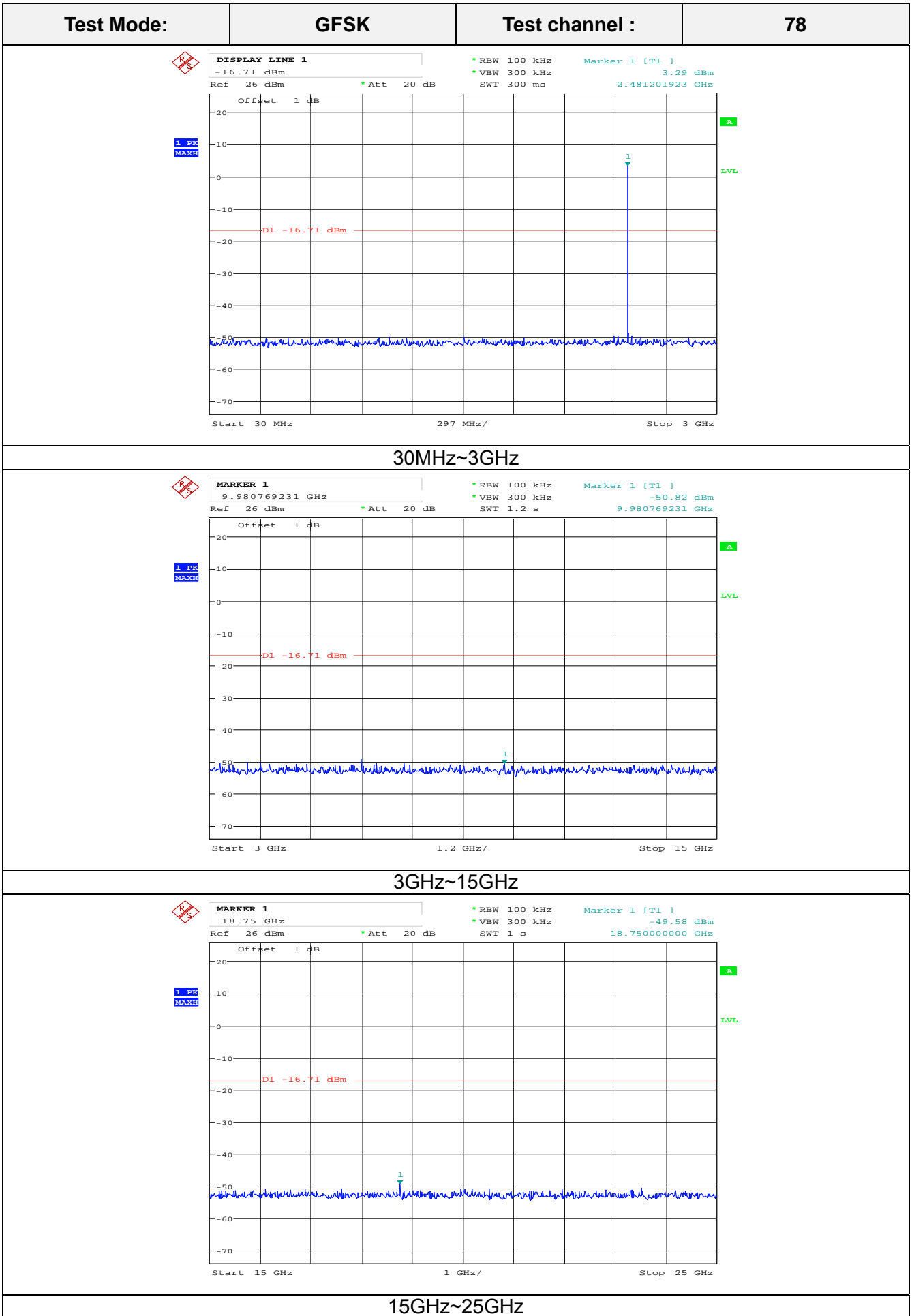



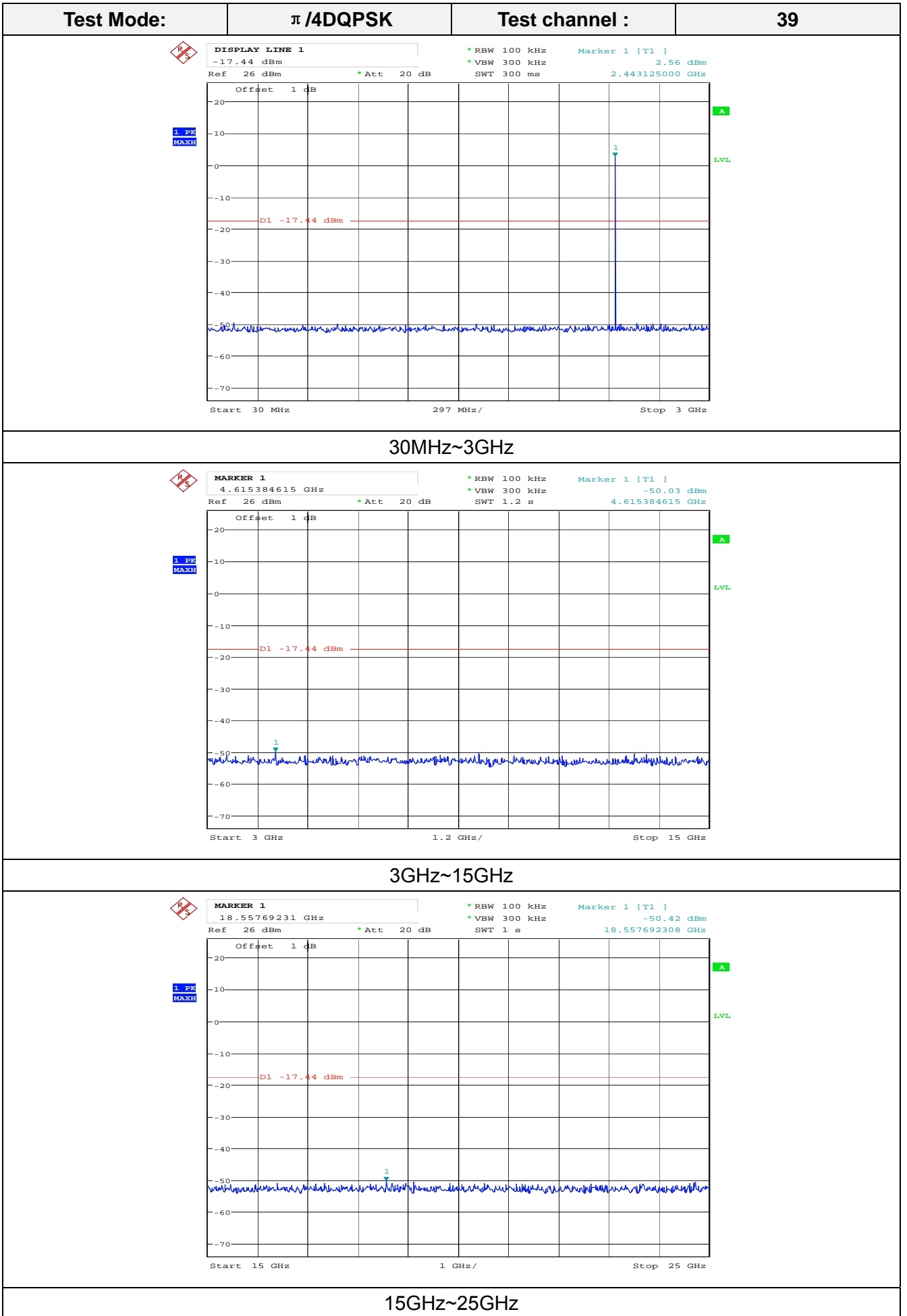

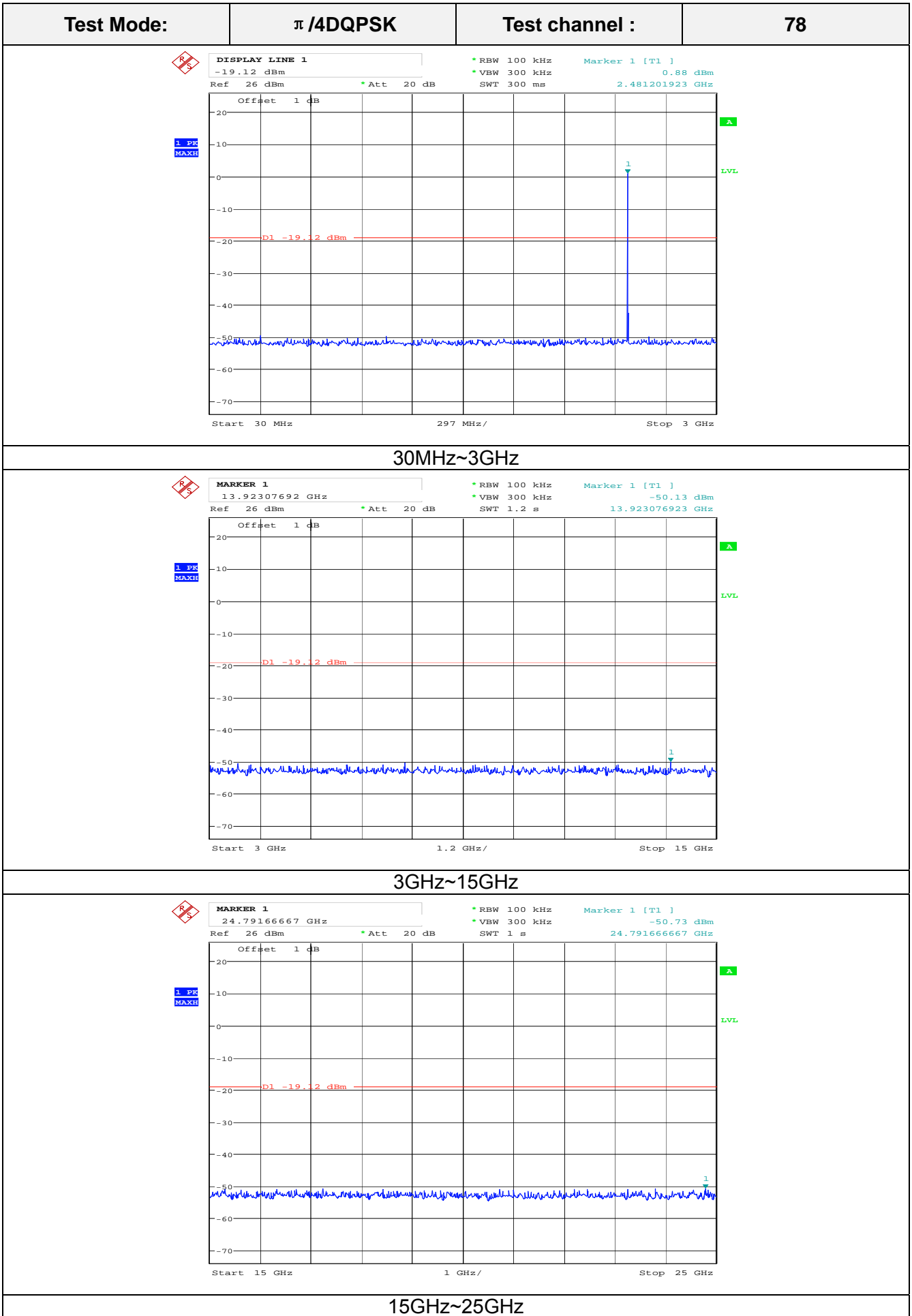

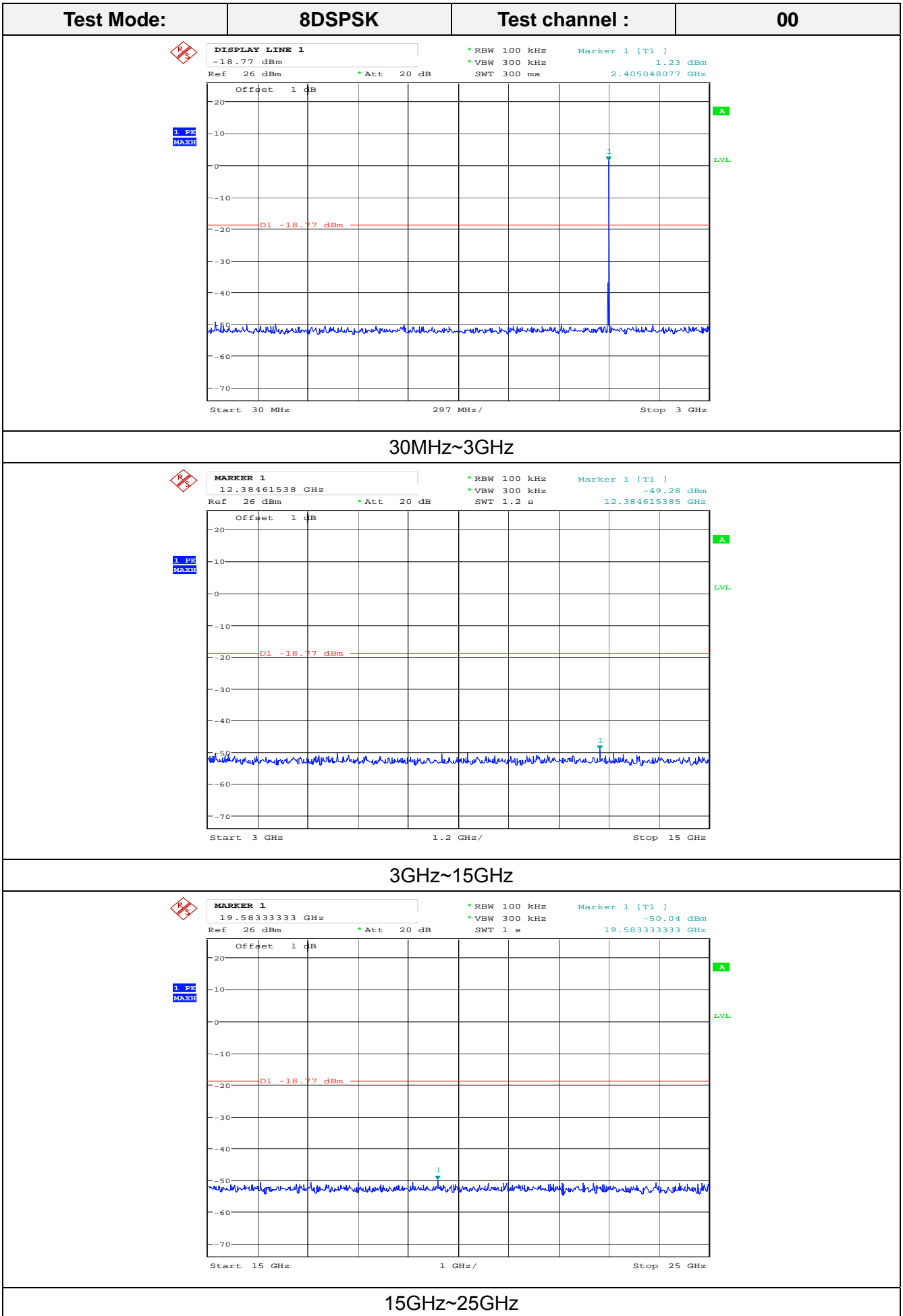

3.10. Pseudorandom Frequency Hopping Sequence

TEST APPLICABLE

For 47 CFR Part 15C section 15.247 (a) (1) requirement:

Frequency hopping systems shall have hopping channel carrier frequencies separated by a minimum of 25 kHz or the 20 dB bandwidth of the hop-ping channel, whichever is greater. Alternatively, frequency hopping systems operating in the 2400–2483.5 MHz band may have hopping channel carrier frequencies that are separated by 25 kHz or two-thirds of the 20 dB bandwidth of the hopping channel, whichever is greater, provided the systems operate with an output power no greater than 125 mW. The system shall hop to channel frequencies that are selected at the system hopping rate from a pseudo randomly ordered list of hopping frequencies. Each frequency must be used equally on the average by each transmitter. The system receivers shall have input bandwidths that match the hop-ping channel bandwidths of their corresponding transmitters and shall shift frequencies in synchronization with the transmitted signals.

EUT Pseudorandom Frequency Hopping Sequence Requirement

The pseudorandom frequency hopping sequence may be generated in a nine-stage shift register whose 5th and 9th stage outputs are added in a modulo-two addition stage. And the result is fed back to the input of the first stage. The sequence begins with the first one of 9 consecutive ones, for example: the shift register is initialized with nine ones.

- Number of shift register stages:9
- Length of pseudo-random sequence:29-1=511 bits
- Longest sequence of zeros:8(non-inverted signal)

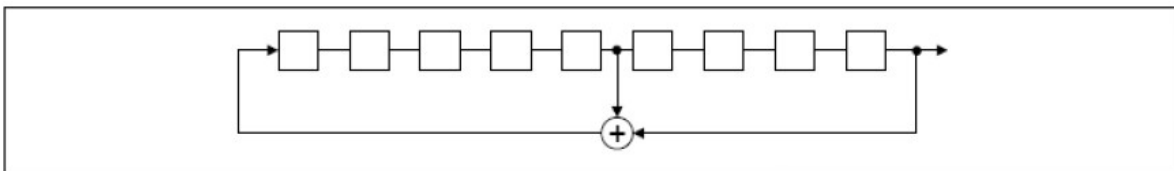

Linear Feedback Shift Register for Generation of the PRBS sequence

An example of pseudorandom frequency hopping sequence as follows:

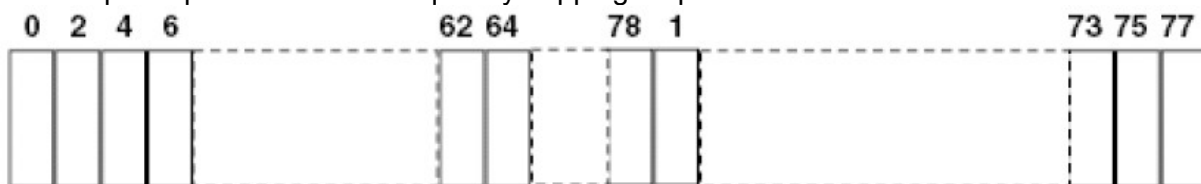

Each frequency used equally one the average by each transmitter.

The system receiver have input bandwidths that match the hopping channel bandwidths of their corresponding transmitter and shift frequencies in synchronization with the transmitted signals.

3.11. Antenna Requirement

Standard Applicable

For intentional device, according to FCC 47 CFR Section 15.203, an intentional radiator shall be designed to ensure that no antenna other than that furnished by the responsible party shall be used with the device.

And according to FCC 47 CFR Section 15.247 (c), if transmitting antennas of directional gain greater than 6dBi are used, the power shall be reduced by the amount in dB that the directional gain of the antenna exceeds 6dBi.

Refer to statement below for compliance

The manufacturer may design the unit so that the user can replace a broken antenna, but the use of a standard antenna jack or electrical connector is prohibited. Further, this requirement does not apply to intentional radiators that must be professionally installed.

Antenna Connected Construction

The maximum gain of WIFI/BT antenna was -1.5dBi.

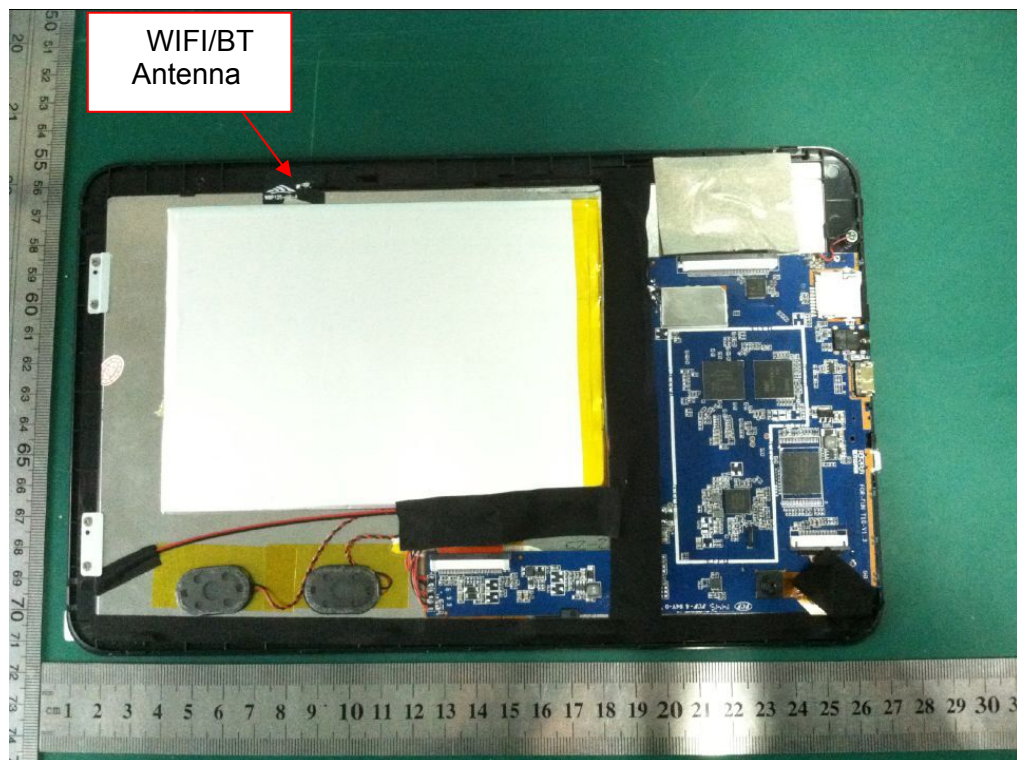

4. EUT TEST PHOTO

Radiated Emission (30MHz-1GHz)



Radiated Emission (1GHz-25GHz)

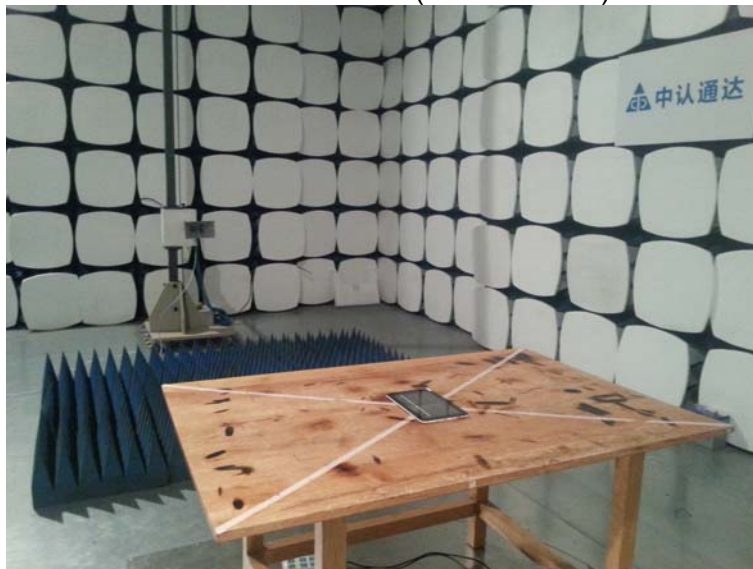

Conducted Emission





5. PHOTOGRAPHS OF EUT CONSTRUCTIONAL

Please reference to the test report No.: GTI20150050F-1

*****THE END*****