



**Shenzhen GTI Technology Co., Ltd.**

1F,2 Block, Jiaquan Building, Guanlan High-tech Park Baoan District,  
Shenzhen, Guangdong, China.

Tel: +86-755-27559792

Fax: +86-755-86116468

Report No.: GTI20150050F-1

Page 1 of 62

# TEST REPORT

**Product Name** .....: 10.1" Tablet PC

**Trademark** .....: Dragon Touch

**Model/Type reference** .....: A1X PLUS

**Listed Model(s)** .....: /

**FCC ID**.....: S5V-D10A2X

**Test Standards** .....: **FCC Part 15.247: Operation within the bands 902-928 MHz, 2400-2483.5 MHz and 5725-5850 MHz**

**Applicant** .....: Proexpress Distributor LLC

**Address of applicant** .....: 11011 Greenwood Ave N 11011 Greenwood Ave N, Seattle, WA, United States

**Date of Receipt** .....: Jan. 25, 2015

**Date of Test Date**.....: Jan. 25, 2015 - Feb. 05, 2015

**Data of issue.** .....: Feb. 06, 2015

<b>Test result</b>	<b>Pass *</b>
--------------------	---------------

\* In the configuration tested, the EUT complied with the standards specified above

GENERAL DESCRIPTION OF EUT	
Equipment:	10.1" Tablet PC
Model Name:	A1X PLUS
Manufacturer:	Shenzhen Modex Technology Co.,Ltd.
Manufacturer Address:	Add:No.1 Rd1 Shangxue Technology Park,Longgang District Shenzhen,China
Power Rating:	DC 3.7V form 5000mAh by rechargeable battery or DC 5.0V form Input:100-240V~,50/60Hz adapter Output: 5.0V===2000mA

Compiled By:



(Allen Wang)

Reviewed By:

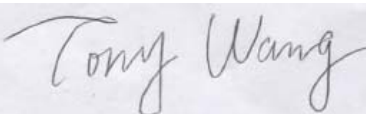

(Tony Wang)

Approved By:

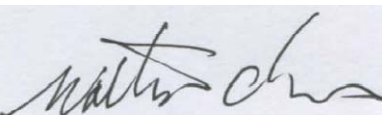

(Walter Chen)

This test report consists of 62 pages in total. It may be duplicated completely for legal use with the approval of the applicant. It should not be reproduced except in full, without the written approval of our laboratory. The client should not use it to claim product endorsement by GTI. The test results in the report only apply to the tested sample. The test report shall be invalid without all the signatures of compiler, reviewer and approver. Any objections must be raised to GTI within 15 days since the date when the report is received. It will not be taken into consideration beyond this limit.



**Table of Contents**

**Page**

**1. SUMMARY..... 4**

1.1. TEST STANDARDS.....4

1.2. TEST DESCRIPTION.....4

1.3. TEST FACILITY .....5

1.4. MEASUREMENT UNCERTAINTY .....5

**2. GENERAL INFORMATION..... 6**

2.1. ENVIRONMENTAL CONDITIONS .....6

2.2. GENERAL DESCRIPTION OF EUT .....6

2.3. DESCRIPTION OF TEST MODES .....7

2.4. MEASUREMENT INSTRUMENTS LIST .....8

**3. TEST CONDITIONS AND RESULTS ..... 9**

3.1. CONDUCTED EMISSION (AC MAIN) .....9

3.2. RADIATED EMISSION .....12

3.3. MAXIMUM PEAK OUTPUT POWER .....21

3.4. POWER SPECTRAL DENSITY .....22

3.5. 6dB BANDWIDTH.....26

3.6. BAND EDGE COMPLIANCE OF RF EMISSION .....30

3.7. SPURIOUS RF CONDUCTED EMISSION.....36

3.8. ANTENNA REQUIREMENT.....52

**4. EUT TEST PHOTO ..... 53**

**5. PHOTOGRAPHS OF EUT CONSTRUCTIONAL ..... 54**

## 1. SUMMARY

### 1.1. Test Standards

The tests were performed according to following standards:

[FCC Rules Part 15.247](#): Frequency Hopping, Direct Spread Spectrum and Hybrid Systems that are in operation within the bands of 902-928 MHz, 2400-2483.5 MHz, and 5725-5850 MHz

[ANSI C63.10](#): American National Standard for Testing Unlicensed Wireless Devices

[KDB558074 D01 V03r02](#): Guidance for Performing Compliance Measurements on Digital Transmission Systems (DTS) Operating Under §15.247

### 1.2. Test Description

FCC PART 15 15.247		
FCC Part 15.207	AC Power Conducted Emission	PASS
FCC Part 15.247(a)(2)	6dB Bandwidth	PASS
FCC Part 15.247(d)	Spurious RF Conducted Emission	PASS
FCC Part 15.247(b)	Maximum Peak Output Power	PASS
FCC Part 15.247(e)	Power Spectral Density	PASS
FCC Part 15.109/ 15.205/ 15.209	Radiated Emissions	PASS
FCC Part 15.247(d)	Band Edge	PASS
FCC Part 15.203/15.247 (b)	Antenna Requirement	PASS

Remark: The measurement uncertainty is not included in the test result.

## 1.3. Test Facility

### 1.3.1 Address of the test laboratory

#### Shenzhen General Testing & Inspection Technology Co., Ltd.

Add: 1F, 2 Block, Jiaquan Building, Guanlan High-tech Park Baoan District, Shenzhen, Guangdong, China

### 1.3.2 Laboratory accreditation

The test facility is recognized, certified, or accredited by the following organizations:

#### IC Registration No.: 9783A

The 3m alternate test site of Shenzhen GTI Technology Co., Ltd. EMC Laboratory has been registered by Certification and Engineer Bureau of Industry Canada for the performance of with Registration NO.: 9783A on Aug, 2011.

#### FCC-Registration No.: 214666

Shenzhen GTI Technology Co., Ltd. EMC Laboratory has been registered and fully described in a report filed with the (FCC) Federal Communications Commission. The acceptance letter from the FCC is maintained in our files. Registration 214666, Sep 19, 2011

## 1.4. Measurement Uncertainty

The data and results referenced in this document are true and accurate. The reader is cautioned that there may be errors within the calibration limits of the equipment and facilities. The measurement uncertainty was calculated for all measurements listed in this test report acc. to CISPR 16 - 4 Specification for radio disturbance and immunity measuring apparatus and methods – Part 4: Uncertainty in EMC Measurements and is documented in the Shenzhen General Testing & Inspection Technology Co., Ltd quality system acc. to DIN EN ISO/IEC 17025. Furthermore, component and process variability of devices similar to that tested may result in additional deviation. The manufacturer has the sole responsibility of continued compliance of the device.

Hereafter the best measurement capability for General Testing & Inspection laboratory is reported:

Test Items	Measurement Uncertainty	Notes
Transmitter power conducted	0.57 dB	(1)
Transmitter power Radiated	2.20 dB	(1)
Conducted spurious emission 9KHz-40 GHz	1.60 dB	(1)
Radiated spurious emission 9KHz-40 GHz	2.20 dB	(1)
Conducted Emission 9KHz-30MHz	3.39 dB	(1)
Radiated Emission 30~1000MHz	4.24 dB	(1)
Radiated Emission 1~18GHz	5.16 dB	(1)
Radiated Emission 18-40GHz	5.54 dB	(1)
Occupied Bandwidth	-----	(1)

(1) This uncertainty represents an expanded uncertainty expressed at approximately the 95% confidence level using a coverage factor of k=1.96.

## 2. GENERAL INFORMATION

### 2.1. Environmental conditions

During the measurement the environmental conditions were within the listed ranges:

Temperature:	15~35°C
Relative Humidity:	30~60 %
Air Pressure:	950~1050mba

### 2.2. General Description of EUT

Product Name:	10.1" Tablet PC
Model/Type reference:	A1X PLUS
Power supply:	DC 3.7V from battery
Adapter information :	Model: UBP-A806-05200 Input: 100-240VAC, 50/60Hz Output: 5V---2000m A
Hardware version:	V1.3
Software version:	Android 4.4.2
<b>WIFI :</b>	
Supported type:	802.11b/802.11g/802.11n(H20)/802.11n(H40)
Modulation:	802.11b: DSSS 802.11g/802.11n(H20)/802.11n(H40): OFDM
Operation frequency:	802.11b/802.11g/802.11n(H20): 2412MHz~2462MHz 802.11n(H40): 2422MHz~2452MHz
Channel number:	802.11b/802.11g/802.11n(H20): 11 802.11n(H40): 7
Channel separation:	5MHz
Antenna type:	FPC Antenna
Antenna gain:	-1.5dBi
<b>Bluetooth:4.0</b>	
Supported type:	Version 4.0 for low Energy
Modulation:	GFSK
Operation frequency:	2402MHz to 2480MHz
Channel number:	40
Channel separation:	2 MHz
Antenna type:	FPC Antenna
Antenna gain:	-1.5dBi

Note: For a more detailed features description, please refer to the manufacturer's specifications or the User's Manual.

### 2.3. Description of Test Modes

The Applicant provides communication tools software to control the EUT for staying in continuous transmitting (Duty Cycle more than 98%) and receiving mode for testing.

**BT 4.0 Operation Frequency :**

Channel	Frequency (MHz)
<b>00</b>	<b>2402</b>
01	2404
02	2406
:	:
<b>19</b>	<b>2440</b>
:	:
37	2476
38	2478
<b>39</b>	<b>2480</b>

**WIFI Operation Frequency :**

Channel	Frequency(MHz)	Channel	Frequency(MHz)
<b>1</b>	<b>2412</b>	8	2447
2	2417	<b>9</b>	<b>2452</b>
<b>3</b>	<b>2422</b>	10	2457
4	2427	<b>11</b>	<b>2462</b>
5	2432		
<b>6</b>	<b>2437</b>		
7	2442		

**Data Rate Used:**

Preliminary tests were performed in different data rate to find the worst radiated emission. The data rate shown in the table below is the worst-case rate with respect to the specific test item. Investigation has been done on all the possible configurations for searching the worst cases. The following table is a list of the test modes shown in this test report.

Test Items	Mode	Data Rate	Channel
Maximum Peak Conducted Output Power Power Spectral Density 6dB Bandwidth Spurious RF conducted emission Radiated Emission 9kHz~1GHz& Radiated Emission 1GHz~10th Harmonic	11b/DSSS	1 Mbps	1/6/11
	11g/OFDM	6 Mbps	1/6/11
	11n(20MHz)/OFDM	6.5Mbps	1/6/11
	11n(40MHz)/OFDM	13.5 Mbps	3/6/9
Band Edge	11b/DSSS	1 Mbps	1/11
	11g/OFDM	6 Mbps	1/11
	11n(20MHz)/OFDM	6.5Mbps	1/11
	11n(40MHz)/OFDM	13.5 Mbps	3//9

## 2.4. Measurement Instruments List

Maximum Peak Output Power					
Item	Test Equipment	Manufacturer	Model No.	Serial No.	Calibrated until
1	Power Meter	Anritsu	ML2487B	110553	July 10,2015
2	Power Sensor	Anritsu	MA2411B	100345	July 10,2015

Power Spectral Density / 6dB Bandwidth / Band Edge Compliance of RF Emission / Spurious RF Conducted Emission					
Item	Test Equipment	Manufacturer	Model No.	Serial No.	Calibrated until
1	Spectrum Analyzer	Rohde & Schwarz	FSU	100105	Jan 07,2016

Conducted Emission					
Item	Test Equipment	Manufacturer	Model No.	Serial No.	Calibrate until
1	LISN	R&S	ENV216	101112	Jan. 07, 2016
2	LISN	R&S	ENV216	101113	Jan. 07, 2016
3	EMI Test Receiver	R&S	ESCI	100920	Jan. 07, 2016
4	Cable	Schwarzbeck	Cable001	--	Jan. 07, 2016

Radiated Emission					
Item	Test Equipment	Manufacturer	Model No.	Serial No.	Calibrated until
1	EMI Test Receiver	R&S	ESCI	100967	Jan 07,2016
2	High pass filter	micro-tranics	HPM50111	34202	Jan 07,2016
3	Log-Bicon Antenna	Schwarzbeck	CBL6141A	4180	Jan. 10,2016
4	Ultra-Broadband Antenna	ShwarzBeck	BBHA9170	25841	Jan. 10,2016
5	Loop Antenna	LAPLAC	RF300	9138	Jan. 10,2016
6	Spectrum Analyzer	Rohde & Schwarz	FSU	100105	Jan 07,2016
7	Horn Antenna	Schwarzbeck	BBHA 9120D	648	Jan. 10,2016
8	Pre-Amplifier	HP	8447D	1937A03050	Jan. 07,2016
9	Pre-Amplifier	EMCI	EMC05183 5	980075	Jan. 07,2016
10	Antenna Mast	UC	UC3000	N/A	N/A
11	Turn Table	UC	UC3000	N/A	N/A
12	Cable	Schwarzbeck	Cable002	--	Jan. 07,2016
13	Cable	Schwarzbeck	Cable003	--	Jan. 07,2016

Note: 1. The Cal.Interval was one year.

2. The cable loss has calculated in test result which connection between each test instruments.



### 3. TEST CONDITIONS AND RESULTS

#### 3.1. Conducted Emission (AC Main)

##### LIMIT

FCC CFR Title 47 Part 15 Subpart C Section 15.207

Frequency range (MHz)	Limit (dBuV)	
	Quasi-peak	Average
0.15-0.5	66 to 56*	56 to 46*
0.5-5	56	46
5-30	60	50

\* Decreases with the logarithm of the frequency.

##### TEST CONFIGURATION

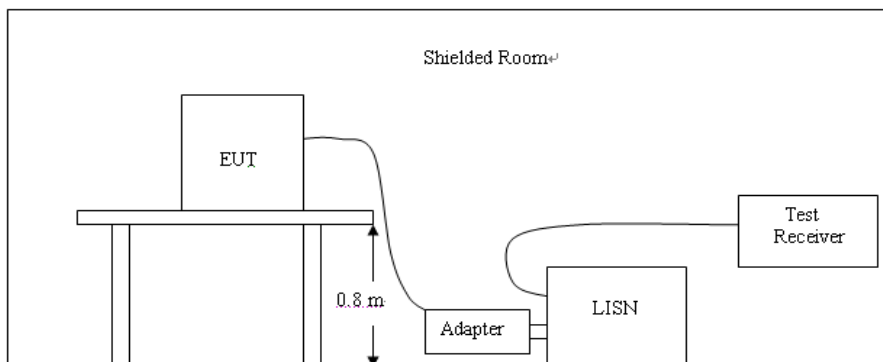

##### TEST PROCEDURE

1. The equipment was set up as per the test configuration to simulate typical actual usage per the user’s manual. The EUT is a tabletop system; a wooden table with a height of 0.8 meters is used and is placed on the ground plane as per ANSI C63.10-2009.
2. Support equipment, if needed, was placed as per ANSI C63.10-2009
3. All I/O cables were positioned to simulate typical actual usage as per ANSI C63.10-2009
4. The EUT received DC5V power from the adapter, the adapter received AC120V/60Hz power through a Line Impedance Stabilization Network (LISN) which supplied power source and was grounded to the ground plane.
5. All support equipments received AC power from a second LISN, if any.
6. The EUT test program was started. Emissions were measured on each current carrying line of the EUT using a spectrum Analyzer / Receiver connected to the LISN powering the EUT. The LISN has two monitoring points: Line 1 (Hot Side) and Line 2 (Neutral Side). Two scans were taken: one with Line 1 connected to Analyzer / Receiver and Line 2 connected to a 50 ohm load; the second scan had Line 1 connected to a 50 ohm load and Line 2 connected to the Analyzer / Receiver.
7. Analyzer / Receiver scanned from 150 KHz to 30MHz for emissions in each of the test modes.
8. During the above scans, the emissions were maximized by cable manipulation.

**TEST RESULTS**

LINE	L
------	---

**SCAN TABLE: "Voltage (9K-30M) FIN"**  
 Short Description: 150K-30M Voltage

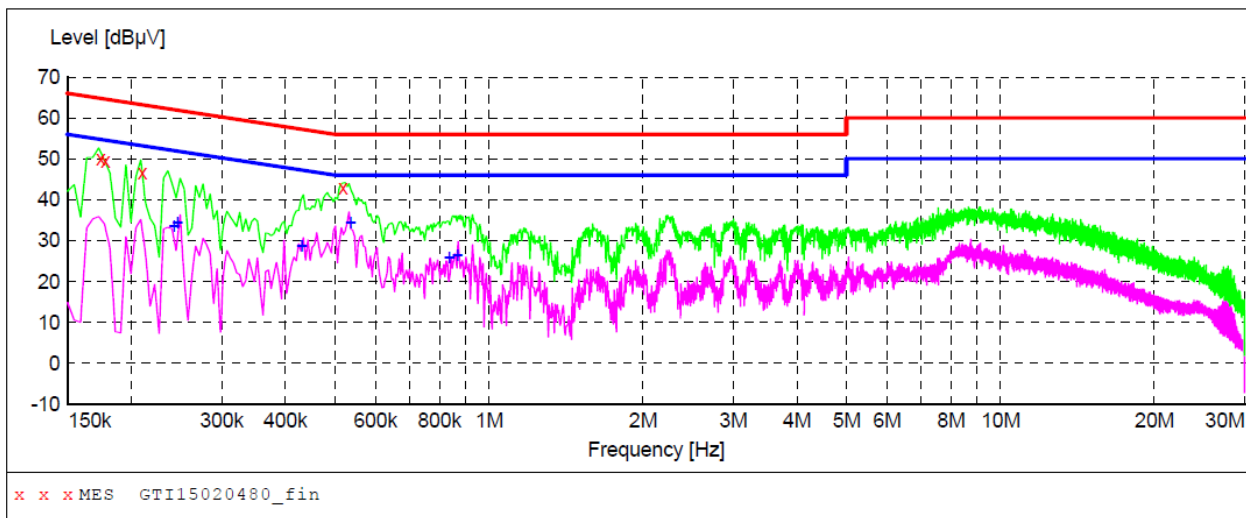

**MEASUREMENT RESULT: "GTI15020480\_fin"**

2/4/2015 7:30PM

Frequency MHz	Level dBµV	Transd dB	Limit dBµV	Margin dB	Detector	Line	PE
0.174000	50.00	9.9	65	14.8	QP	L1	GND
0.178000	49.60	9.9	65	15.0	QP	L1	GND
0.210000	46.70	9.9	63	16.5	QP	L1	GND
0.518000	43.00	9.9	56	13.0	QP	L1	GND

**MEASUREMENT RESULT: "GTI15020480\_fin2"**

2/4/2015 7:30PM

Frequency MHz	Level dBµV	Transd dB	Limit dBµV	Margin dB	Detector	Line	PE
0.242000	33.60	9.9	52	18.4	AV	L1	GND
0.246000	34.40	9.9	52	17.5	AV	L1	GND
0.430000	28.70	9.9	47	18.6	AV	L1	GND
0.536000	34.40	9.9	46	11.6	AV	L1	GND
0.836000	25.80	10.1	46	20.2	AV	L1	GND
0.866000	26.40	10.1	46	19.6	AV	L1	GND

LINE

N

**SCAN TABLE: "Voltage (9K-30M) FIN"**

Short Description: 150K-30M Voltage

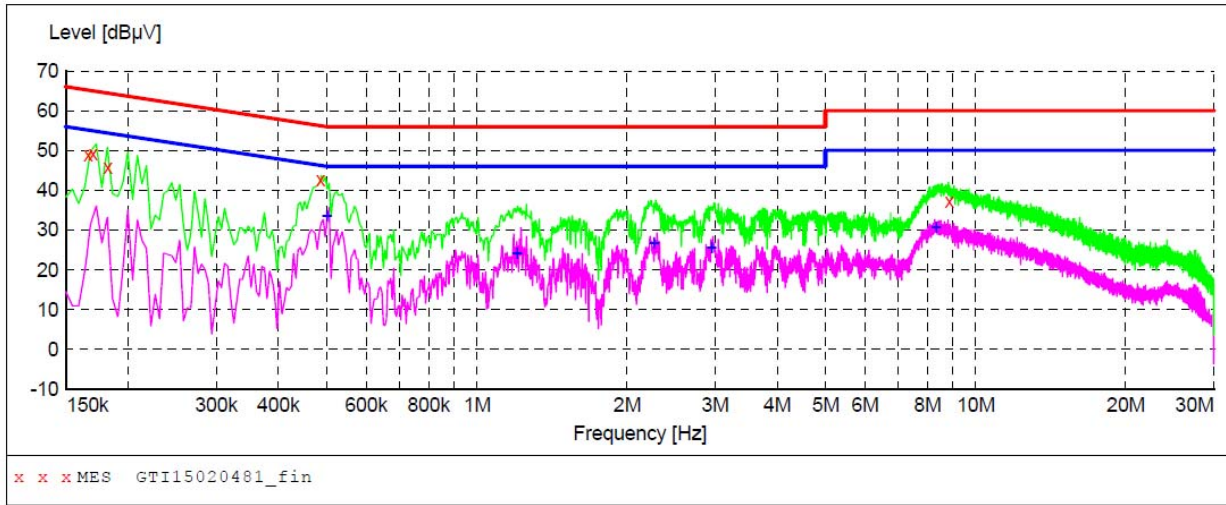

**MEASUREMENT RESULT: "GTI15020481\_fin"**

2/4/2015 7:33PM

Frequency MHz	Level dBµV	Transd dB	Limit dBµV	Margin dB	Detector	Line	PE
0.166000	48.80	9.9	65	16.4	QP	N	GND
0.170000	49.10	9.9	65	15.9	QP	N	GND
0.182000	45.70	9.9	64	18.7	QP	N	GND
0.486000	42.80	9.9	56	13.4	QP	N	GND
8.852000	37.20	10.7	60	22.8	QP	N	GND

**MEASUREMENT RESULT: "GTI15020481\_fin2"**

2/4/2015 7:33PM

Frequency MHz	Level dBµV	Transd dB	Limit dBµV	Margin dB	Detector	Line	PE
0.500000	33.40	9.9	46	12.6	AV	N	GND
1.202000	24.10	10.2	46	21.9	AV	N	GND
2.264000	26.70	10.4	46	19.3	AV	N	GND
2.954000	25.70	10.5	46	20.3	AV	N	GND
8.318000	30.60	10.7	50	19.4	AV	N	GND

### 3.2. Radiated Emission

#### Limit

For intentional device, according to § 15.209(a), the general requirement of field strength of radiated emission from intentional radiators at a distance of 3 meters shall not exceed the following table. According to § 15.247(d), in any 100kHz bandwidth outside the frequency band in which the EUT is operating, the radio frequency power that is produced by the intentional radiator shall be at least 20dB below that in the 100kHz bandwidth within the band that contains the highest level of desired power.

The frequency spectrum above 1 GHz for Transmitter was investigated. All emission not reported are much lower than the prescribed limits. Set the RBW=1MHz, VBW=3MHz for Peak Detector while the RBW=1MHz, VBW=10Hz for Average Detector, Readings are both peak and average values. The pre-test have done for the EUT in three axes and found the worst emission at position shown in test setup photos.

Frequency (MHz)	Distance (Meters)	Radiated (dBuV/m)	Radiated (µV/m)
0.009-0.49	3	$20\log(2400/F(\text{KHz}))+40\log(300/3)$	$2400/F(\text{KHz})$
0.49-1.705	3	$20\log(24000/F(\text{KHz}))+40\log(30/3)$	$24000/F(\text{KHz})$
1.705-30	3	$20\log(30)+40\log(30/3)$	30
30-88	3	40.0	100
88-216	3	43.5	150
216-960	3	46.0	200
Above 960	3	54.0	500

#### Test Procedure

1. The EUT was placed on a turn table which is 0.8m above ground plane.
2. Maximum procedure was performed by raising the receiving antenna from 1m to 4m and rotating the turn table from 0°C to 360°C to acquire the highest emissions from EUT
3. And also, each emission was to be maximized by changing the polarization of receiving antenna both horizontal and vertical.
4. Repeat above procedures until all frequency measurements have been completed.

#### Field Strength Calculation

The field strength is calculated by adding the Antenna Factor and Cable Factor and subtracting the Amplifier Gain and Duty Cycle Correction Factor (if any) from the measured reading. The basic equation with a sample calculation is as follows:

$$FS = RA + AF + CL - AG$$

Where	FS = Field Strength	CL = Cable Attenuation Factor (Cable Loss)
	RA = Reading Amplitude	AG = Amplifier Gain
	AF = Antenna Factor	

For example

Frequency (MHz)	FS (dBµV/m)	RA (dBµV/m)	AF (dB)	CL (dB)	AG (dB)	Transd (dB)
150.00	40	58.1	12.2	1.6	31.90	-18.1

$$\text{Transd} = \text{AF} + \text{CL} - \text{AG}$$

### Test Configuration

Frequency range 9 KHz – 30MHz

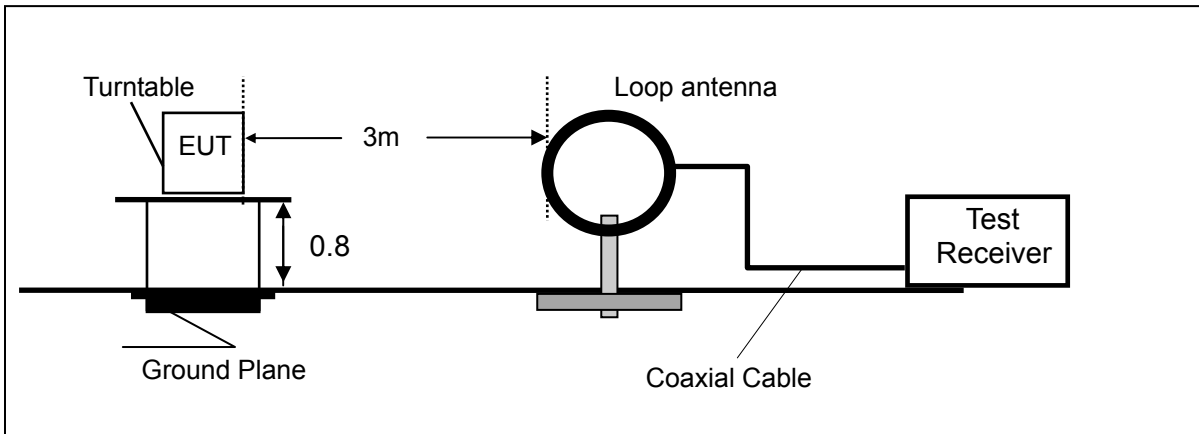

Frequency range 30MHz – 1000MHz

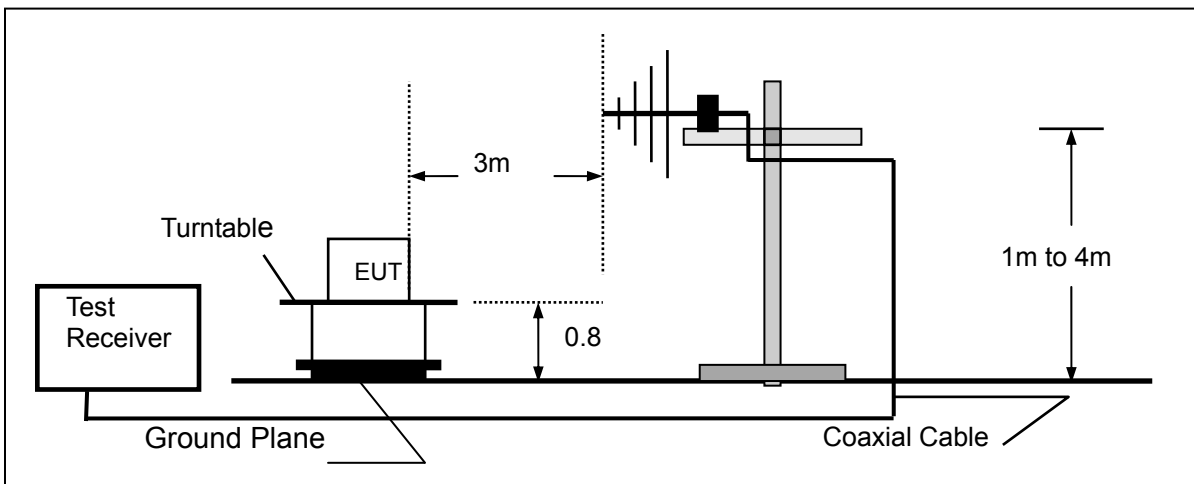

Frequency range above 1GHz-25GHz

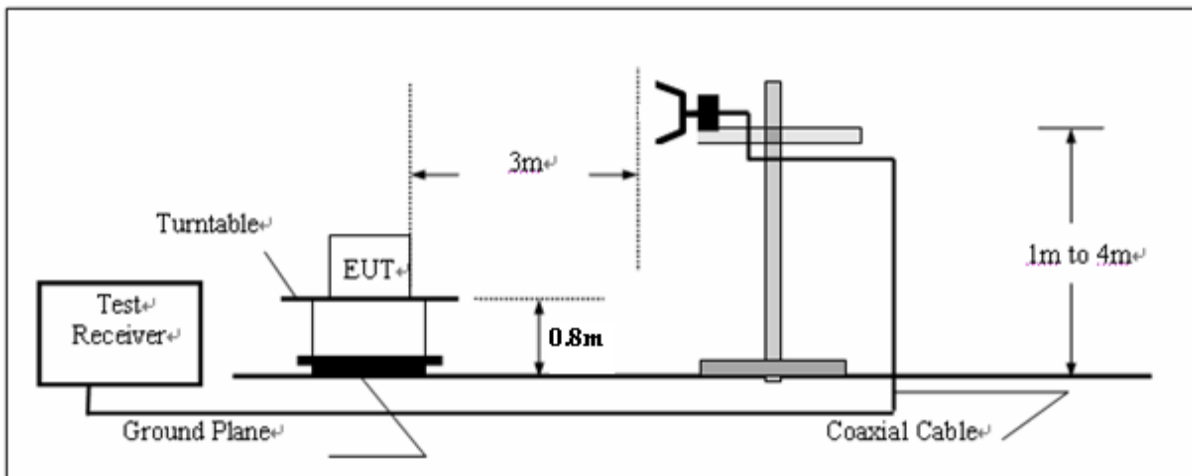

### Test Results

Remark:

1. We tested three channels for each mode of BT4.0/WIFI and recorded worst case at low channel at 802.11b mode below 1GHz.

For 9 KHz-30MHz

Frequency (MHz)	Corrected Reading (dBuV/m)@3m	FCC Limit (dBuV/m) @3m	Margin (dB)	Detector	Result
0.20	54.45	101.58	47.13	QP	PASS
1.59	42.36	63.58	21.22	QP	PASS
28.62	53.41	69.54	16.13	QP	PASS
25.47	50.57	69.54	18.97	QP	PASS

For 30MHz-1GHz

Horizontal

Data: 22

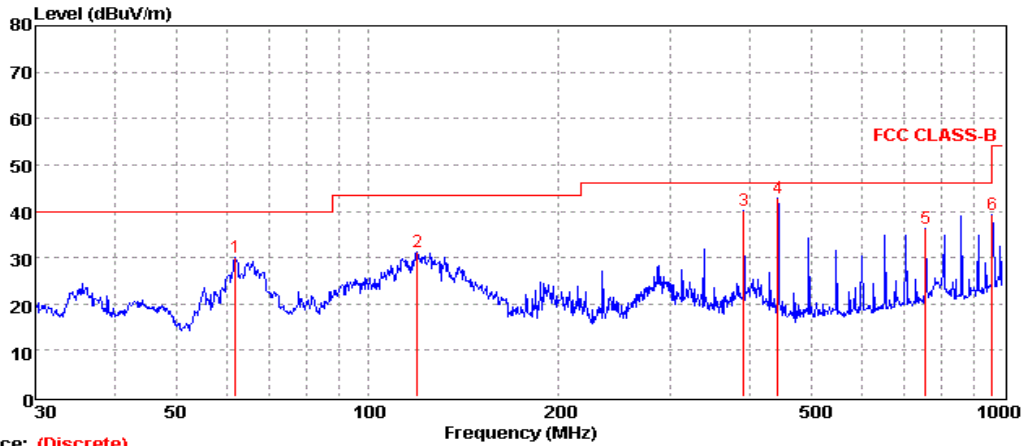

Mark	Frequency MHz	Level dBuV/m	Factor dB/m	Reading dBuV	Limit dBuV/m	Margin dB	Polarization	Detector
1	62.00	30.11	-20.06	50.17	40.00	9.89	HORIZONTAL	Peak
2	119.86	31.09	-18.67	49.76	43.50	12.41	HORIZONTAL	Peak
3	390.72	40.07	-13.57	53.64	46.00	5.93	HORIZONTAL	Peak
4	441.74	42.71	-12.52	55.23	46.00	3.29	HORIZONTAL	Peak
5	755.39	36.20	-8.21	44.41	46.00	9.80	HORIZONTAL	Peak
6	962.16	39.32	-4.50	43.82	54.00	14.68	HORIZONTAL	Peak

Vertical

Data: 23

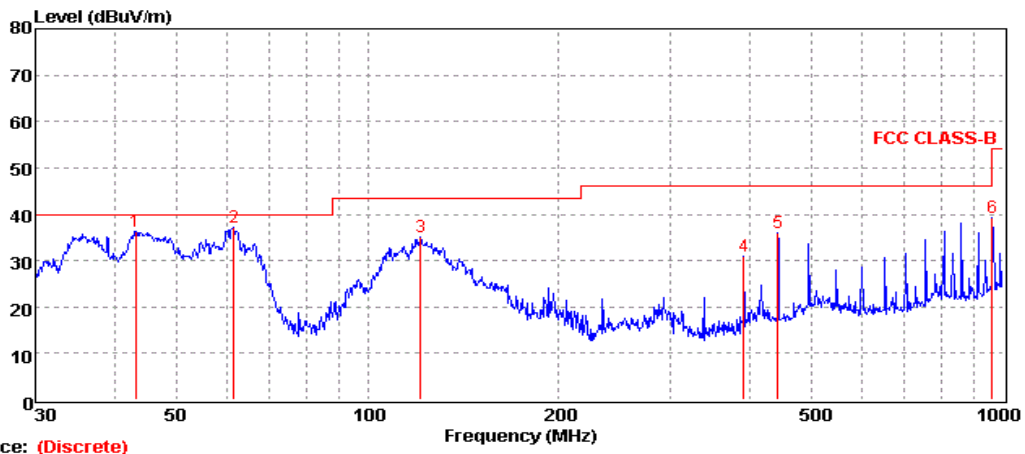

Mark	Frequency MHz	Level dBuV/m	Factor dB/m	Reading dBuV	Limit dBuV/m	Margin dB	Polarization	Detector
1	43.20	36.25	-13.52	49.77	40.00	3.75	HORIZONTAL	Peak
2	61.56	37.11	-20.06	57.17	40.00	2.89	HORIZONTAL	Peak
3	121.12	35.02	-18.69	53.71	43.50	8.48	HORIZONTAL	Peak
4	390.72	30.92	-13.57	44.49	46.00	15.08	HORIZONTAL	Peak
5	441.74	36.03	-12.52	48.55	46.00	9.97	HORIZONTAL	Peak
6	962.16	39.14	-4.50	43.64	54.00	14.86	HORIZONTAL	Peak



For 1GHz to 25GHz

802.11b Mode (above 1GHz)

Frequency(MHz):				2412			Polarity:			HORIZONTAL		
No.	Frequency (MHz)	Emission Level (dBuV/m)		Limit (dBuV/m)	Margin (dB)	Antenna Height (m)	Table Angle (Degree)	Raw Value (dBuV)	Antenna Factor (dB/m)	Cable Factor (dB)	Pre-amplifier (dB)	Correction Factor (dB/m)
1	4824	65.54	PK	74.00	8.46	1.00	55	63.44	31.6	7.00	36.5	2.10
1	4824	46.26	AV	54.00	7.74	1.00	55	44.16	31.6	7.00	36.5	2.10
2	7236	59.52	PK	74.00	14.48	1.00	112	48.59	37.33	8.90	35.3	10.93
2	7236	40.14	AV	54.00	13.86	1.00	112	29.21	37.33	8.90	35.3	10.93

Frequency(MHz):				2412			Polarity:			VERTICAL		
No.	Frequency (MHz)	Emission Level (dBuV/m)		Limit (dBuV/m)	Margin (dB)	Antenna Height (m)	Table Angle (Degree)	Raw Value (dBuV)	Antenna Factor (dB/m)	Cable Factor (dB)	Pre-amplifier (dB)	Correction Factor (dB/m)
1	4824	63.26	PK	74.00	10.74	1.00	125	61.16	31.60	7.00	36.50	2.10
1	4824	46.55	AV	54.00	7.45	1.00	125	44.45	31.60	7.00	36.50	2.10
2	7236	59.14	PK	74.00	14.86	1.00	145	48.21	37.33	8.90	35.30	10.93
2	7236	41.47	AV	54.00	12.53	1.00	142	30.54	37.33	8.90	35.30	10.93

Frequency(MHz):				2437			Polarity:			HORIZONTAL		
No.	Frequency (MHz)	Emission Level (dBuV/m)		Limit (dBuV/m)	Margin (dB)	Antenna Height (m)	Table Angle (Degree)	Raw Value (dBuV)	Antenna Factor (dB/m)	Cable Factor (dB)	Pre-amplifier (dB)	Correction Factor (dB/m)
1	4874.00	64.48	PK	74.00	9.52	1.00	112	62.36	31.02	7.60	36.5	2.12
1	4874.00	45.26	AV	54.00	8.74	1.00	112	43.14	31.02	7.60	36.5	2.12
2	7311.00	59.36	PK	74.00	14.64	1.00	184	48.28	37.28	8.60	34.8	11.08
2	7311.00	40.15	AV	54.00	13.85	1.00	184	29.07	37.28	8.60	34.8	11.08

Frequency(MHz):				2437			Polarity:			VERTICAL		
No.	Frequency (MHz)	Emission Level (dBuV/m)		Limit (dBuV/m)	Margin (dB)	Antenna Height (m)	Table Angle (Degree)	Raw Value (dBuV)	Antenna Factor (dB/m)	Cable Factor (dB)	Pre-amplifier (dB)	Correction Factor (dB/m)
1	4874.00	64.25	PK	74.00	9.75	1.00	110	62.13	31.02	7.60	36.5	2.12
1	4874.00	46.26	AV	54.00	7.74	1.00	110	44.14	31.02	7.60	36.5	2.12
2	7311.00	59.66	PK	74.00	14.34	1.00	65	48.58	37.28	8.60	34.8	11.08
2	7311.00	41.44	AV	54.00	12.56	1.00	65	30.36	37.28	8.60	34.8	11.08

Frequency(MHz):				2462			Polarity:			HORIZONTAL		
No.	Frequency (MHz)	Emission Level (dBuV/m)		Limit (dBuV/m)	Margin (dB)	Antenna Height (m)	Table Angle (Degree)	Raw Value (dBuV)	Antenna Factor (dB/m)	Cable Factor (dB)	Pre-amplifier (dB)	Correction Factor (dB/m)
1	4924.00	63.65	PK	74.00	10.35	1.00	134	60.45	31.58	7.82	36.2	3.20
1	4924.00	45.12	AV	54.00	8.88	1.00	134	41.92	31.58	7.82	36.2	3.20
2	7386.00	59.12	PK	74.00	14.88	1.00	125	47.18	38.51	8.73	35.3	11.94
2	7386.00	40.14	AV	54.00	13.86	1.00	125	28.20	38.51	8.73	35.3	11.94

Frequency(MHz):				2462			Polarity:			VERTICAL		
No.	Frequency (MHz)	Emission Level (dBuV/m)		Limit (dBuV/m)	Margin (dB)	Antenna Height (m)	Table Angle (Degree)	Raw Value (dBuV)	Antenna Factor (dB/m)	Cable Factor (dB)	Pre-amplifier (dB)	Correction Factor (dB/m)
1	4924.00	64.41	PK	74.00	9.59	1.00	105	61.21	31.58	7.82	36.2	3.20
1	4924.00	46.26	AV	54.00	7.74	1.00	105	43.06	31.58	7.82	36.2	3.20
2	7386.00	60.36	PK	74.00	13.64	1.00	155	48.42	38.51	8.73	35.3	11.94
2	7386.00	42.47	AV	54.00	11.53	1.00	155	30.53	38.51	8.73	35.3	11.94

**802.11g Mode (above 1GHz)**

Frequency(MHz):			2412			Polarity:			HORIZONTAL		
No.	Frequency (MHz)	Emission Level (dBuV/m)	Limit (dBuV/m)	Margin (dB)	Antenna Height (m)	Table Angle (Degree)	Raw Value (dBuV)	Antenna Factor (dB/m)	Cable Factor (dB)	Pre-amplifier (dB)	Correction Factor (dB/m)
1	4824	64.57 PK	74.00	9.43	1.00	45	62.47	31.6	7.00	36.5	2.10
1	4824	45.69 AV	54.00	8.31	1.00	45	43.59	31.6	7.00	36.5	2.10
2	7236	58.65 PK	74.00	15.35	1.00	110	47.72	37.33	8.90	35.3	10.93
2	7236	39.65 AV	54.00	14.35	1.00	110	28.72	37.33	8.90	35.3	10.93

Frequency(MHz):			2412			Polarity:			VERTICAL		
No.	Frequency (MHz)	Emission Level (dBuV/m)	Limit (dBuV/m)	Margin (dB)	Antenna Height (m)	Table Angle (Degree)	Raw Value (dBuV)	Antenna Factor (dB/m)	Cable Factor (dB)	Pre-amplifier (dB)	Correction Factor (dB/m)
1	4824	63.15 PK	74.00	10.85	1.00	120	61.05	31.60	7.00	36.50	2.10
1	4824	46.25 AV	54.00	7.75	1.00	120	44.15	31.60	7.00	36.50	2.10
2	7236	58.62 PK	74.00	15.38	1.00	140	47.69	37.33	8.90	35.30	10.93
2	7236	40.69 AV	54.00	13.31	1.00	140	29.76	37.33	8.90	35.30	10.93

Frequency(MHz):			2437			Polarity:			HORIZONTAL		
No.	Frequency (MHz)	Emission Level (dBuV/m)	Limit (dBuV/m)	Margin (dB)	Antenna Height (m)	Table Angle (Degree)	Raw Value (dBuV)	Antenna Factor (dB/m)	Cable Factor (dB)	Pre-amplifier (dB)	Correction Factor (dB/m)
1	4874.00	63.69 PK	74.00	10.31	1.00	115	61.57	31.02	7.60	36.5	2.12
1	4874.00	45.12 AV	54.00	8.88	1.00	115	43.00	31.02	7.60	36.5	2.12
2	7311.00	58.33 PK	74.00	15.67	1.00	180	47.25	37.28	8.60	34.8	11.08
2	7311.00	39.65 AV	54.00	14.35	1.00	180	28.57	37.28	8.60	34.8	11.08

Frequency(MHz):			2437			Polarity:			VERTICAL		
No.	Frequency (MHz)	Emission Level (dBuV/m)	Limit (dBuV/m)	Margin (dB)	Antenna Height (m)	Table Angle (Degree)	Raw Value (dBuV)	Antenna Factor (dB/m)	Cable Factor (dB)	Pre-amplifier (dB)	Correction Factor (dB/m)
1	4874.00	63.56 PK	74.00	10.44	1.00	125	61.44	31.02	7.60	36.5	2.12
1	4874.00	45.18 AV	54.00	8.82	1.00	125	43.06	31.02	7.60	36.5	2.12
2	7311.00	58.36 PK	74.00	15.64	1.00	75	47.28	37.28	8.60	34.8	11.08
2	7311.00	40.15 AV	54.00	13.85	1.00	75	29.07	37.28	8.60	34.8	11.08

Frequency(MHz):			2462			Polarity:			HORIZONTAL		
No.	Frequency (MHz)	Emission Level (dBuV/m)	Limit (dBuV/m)	Margin (dB)	Antenna Height (m)	Table Angle (Degree)	Raw Value (dBuV)	Antenna Factor (dB/m)	Cable Factor (dB)	Pre-amplifier (dB)	Correction Factor (dB/m)
1	4924.00	63.26 PK	74.00	10.74	1.00	130	60.06	31.58	7.82	36.2	3.20
1	4924.00	44.26 AV	54.00	9.74	1.00	130	41.06	31.58	7.82	36.2	3.20
2	7386.00	58.36 PK	74.00	15.64	1.00	120	46.42	38.51	8.73	35.3	11.94
2	7386.00	40.24 AV	54.00	13.76	1.00	120	28.30	38.51	8.73	35.3	11.94

Frequency(MHz):			2462			Polarity:			VERTICAL		
No.	Frequency (MHz)	Emission Level (dBuV/m)	Limit (dBuV/m)	Margin (dB)	Antenna Height (m)	Table Angle (Degree)	Raw Value (dBuV)	Antenna Factor (dB/m)	Cable Factor (dB)	Pre-amplifier (dB)	Correction Factor (dB/m)
1	4924.00	65.26 PK	74.00	8.74	1.00	100	62.06	31.58	7.82	36.2	3.20
1	4924.00	45.18 AV	54.00	8.82	1.00	100	41.98	31.58	7.82	36.2	3.20
2	7386.00	59.36 PK	74.00	14.64	1.00	150	47.42	38.51	8.73	35.3	11.94
2	7386.00	41.87 AV	54.00	28.00	1.00	150	29.93	38.51	8.73	35.3	11.94



**802.11n (H20) Mode (above 1GHz)**

Frequency(MHz):			2412			Polarity:			HORIZONTAL		
No.	Frequency (MHz)	Emission Level (dBuV/m)	Limit (dBuV/m)	Margin (dB)	Antenna Height (m)	Table Angle (Degree)	Raw Value (dBuV)	Antenna Factor (dB/m)	Cable Factor (dB)	Pre-amplifier (dB)	Correction Factor (dB/m)
1	4824	64.78 PK	74.00	9.22	1.00	55	62.68	31.6	7.00	36.5	2.10
1	4824	45.98 AV	54.00	8.02	1.00	55	43.88	31.6	7.00	36.5	2.10
2	7236	58.26 PK	74.00	15.74	1.00	112	47.33	37.33	8.90	35.3	10.93
2	7236	39.47 AV	54.00	14.53	1.00	112	28.54	37.33	8.90	35.3	10.93

Frequency(MHz):			2412			Polarity:			VERTICAL		
No.	Frequency (MHz)	Emission Level (dBuV/m)	Limit (dBuV/m)	Margin (dB)	Antenna Height (m)	Table Angle (Degree)	Raw Value (dBuV)	Antenna Factor (dB/m)	Cable Factor (dB)	Pre-amplifier (dB)	Correction Factor (dB/m)
1	4824	64.26 PK	74.00	9.74	1.00	125	62.16	31.60	7.00	36.50	2.10
1	4824	45.29 AV	54.00	8.71	1.00	125	43.19	31.60	7.00	36.50	2.10
2	7236	56.16 PK	74.00	17.84	1.00	145	45.23	37.33	8.90	35.30	10.93
2	7236	40.17 AV	54.00	13.83	1.00	142	29.24	37.33	8.90	35.30	10.93

Frequency(MHz):			2437			Polarity:			HORIZONTAL		
No.	Frequency (MHz)	Emission Level (dBuV/m)	Limit (dBuV/m)	Margin (dB)	Antenna Height (m)	Table Angle (Degree)	Raw Value (dBuV)	Antenna Factor (dB/m)	Cable Factor (dB)	Pre-amplifier (dB)	Correction Factor (dB/m)
1	4874.00	63.59 PK	74.00	10.41	1.00	112	61.47	31.02	7.60	36.5	2.12
1	4874.00	44.87 AV	54.00	9.13	1.00	112	42.75	31.02	7.60	36.5	2.12
2	7311.00	58.99 PK	74.00	15.01	1.00	184	47.91	37.28	8.60	34.8	11.08
2	7311.00	39.68 AV	54.00	14.32	1.00	184	28.60	37.28	8.60	34.8	11.08

Frequency(MHz):			2437			Polarity:			VERTICAL		
No.	Frequency (MHz)	Emission Level (dBuV/m)	Limit (dBuV/m)	Margin (dB)	Antenna Height (m)	Table Angle (Degree)	Raw Value (dBuV)	Antenna Factor (dB/m)	Cable Factor (dB)	Pre-amplifier (dB)	Correction Factor (dB/m)
1	4874.00	63.15 PK	74.00	10.85	1.00	110	61.03	31.02	7.60	36.5	2.12
1	4874.00	45.78 AV	54.00	8.22	1.00	110	43.66	31.02	7.60	36.5	2.12
2	7311.00	58.69 PK	74.00	15.31	1.00	65	47.61	37.28	8.60	34.8	11.08
2	7311.00	40.15 AV	54.00	13.85	1.00	65	29.07	37.28	8.60	34.8	11.08

Frequency(MHz):			2462			Polarity:			HORIZONTAL		
No.	Frequency (MHz)	Emission Level (dBuV/m)	Limit (dBuV/m)	Margin (dB)	Antenna Height (m)	Table Angle (Degree)	Raw Value (dBuV)	Antenna Factor (dB/m)	Cable Factor (dB)	Pre-amplifier (dB)	Correction Factor (dB/m)
1	4924.00	63.15 PK	74.00	10.85	1.00	134	59.95	31.58	7.82	36.2	3.20
1	4924.00	44.96 AV	54.00	9.04	1.00	134	41.76	31.58	7.82	36.2	3.20
2	7386.00	58.62 PK	74.00	15.38	1.00	125	46.68	38.51	8.73	35.3	11.94
2	7386.00	39.52 AV	54.00	14.48	1.00	125	27.58	38.51	8.73	35.3	11.94

Frequency(MHz):			2462			Polarity:			VERTICAL		
No.	Frequency (MHz)	Emission Level (dBuV/m)	Limit (dBuV/m)	Margin (dB)	Antenna Height (m)	Table Angle (Degree)	Raw Value (dBuV)	Antenna Factor (dB/m)	Cable Factor (dB)	Pre-amplifier (dB)	Correction Factor (dB/m)
1	4924.00	64.36 PK	74.00	9.64	1.00	105	61.16	31.58	7.82	36.2	3.20
1	4924.00	45.78 AV	54.00	8.22	1.00	105	42.58	31.58	7.82	36.2	3.20
2	7386.00	59.36 PK	74.00	14.64	1.00	155	47.42	38.51	8.73	35.3	11.94
2	7386.00	41.74 AV	54.00	12.26	1.00	155	29.80	38.51	8.73	35.3	11.94

**802.11n (H40) Mode (above 1GHz)**

Frequency(MHz):				2422			Polarity:			HORIZONTAL		
No.	Frequency (MHz)	Emission Level (dBuV/m)		Limit (dBuV/m)	Margin (dB)	Antenna Height (m)	Table Angle (Degree)	Raw Value (dBuV)	Antenna Factor (dB/m)	Cable Factor (dB)	Pre-amplifier (dB)	Correction Factor (dB/m)
1	4844	60.69	PK	74.00	13.31	1.00	55	58.49	31.6	7.10	36.5	2.20
1	4844	46.35	AV	54.00	7.65	1.00	55	44.15	31.6	7.10	36.5	2.20
2	7266	53.26	PK	74.00	20.74	1.00	112	42.28	37.33	8.95	35.3	10.98
2	7266	--	AV	54.00	--	--	--	--	--	--	--	--

Frequency(MHz):				2422			Polarity:			VERTICAL		
No.	Frequency (MHz)	Emission Level (dBuV/m)		Limit (dBuV/m)	Margin (dB)	Antenna Height (m)	Table Angle (Degree)	Raw Value (dBuV)	Antenna Factor (dB/m)	Cable Factor (dB)	Pre-amplifier (dB)	Correction Factor (dB/m)
1	4844	60.64	PK	74.00	13.36	1.00	125	58.44	31.60	7.10	36.50	2.20
1	4844	46.65	AV	54.00	7.35	1.00	125	44.45	31.60	7.10	36.50	2.20
2	7266	52.14	PK	74.00	21.86	1.00	145	41.16	37.33	8.95	35.30	10.98
2	7266	--	AV	54.00	--	--	--	--	--	--	--	--

Frequency(MHz):				2437			Polarity:			HORIZONTAL		
No.	Frequency (MHz)	Emission Level (dBuV/m)		Limit (dBuV/m)	Margin (dB)	Antenna Height (m)	Table Angle (Degree)	Raw Value (dBuV)	Antenna Factor (dB/m)	Cable Factor (dB)	Pre-amplifier (dB)	Correction Factor (dB/m)
1	4874.00	60.25	PK	74.00	13.75	1.00	112	58.13	31.02	7.60	36.5	2.12
1	4874.00	45.23	AV	54.00	8.77	1.00	112	43.11	31.02	7.60	36.5	2.12
2	7311.00	41.26	PK	74.00	32.74	1.00	184	30.18	37.28	8.60	34.8	11.08
2	7311.00	--	AV	54.00	--	--	--	--	--	--	--	--

Frequency(MHz):				2437			Polarity:			VERTICAL		
No.	Frequency (MHz)	Emission Level (dBuV/m)		Limit (dBuV/m)	Margin (dB)	Antenna Height (m)	Table Angle (Degree)	Raw Value (dBuV)	Antenna Factor (dB/m)	Cable Factor (dB)	Pre-amplifier (dB)	Correction Factor (dB/m)
1	4874.00	59.36	PK	74.00	14.64	1.00	110	57.24	31.02	7.60	36.5	2.12
1	4874.00	46.15	AV	54.00	7.85	1.00	110	44.03	31.02	7.60	36.5	2.12
2	7311.00	53.15	PK	74.00	20.85	1.00	65	42.07	37.28	8.60	34.8	11.08
2	7311.00	--	AV	54.00	--	--	--	--	--	--	--	--

Frequency(MHz):				2452			Polarity:			HORIZONTAL		
No.	Frequency (MHz)	Emission Level (dBuV/m)		Limit (dBuV/m)	Margin (dB)	Antenna Height (m)	Table Angle (Degree)	Raw Value (dBuV)	Antenna Factor (dB/m)	Cable Factor (dB)	Pre-amplifier (dB)	Correction Factor (dB/m)
1	4904.00	60.26	PK	74.00	13.74	1.00	134	57.03	31.58	7.85	36.2	3.23
1	4904.00	45.14	AV	54.00	8.86	1.00	134	41.91	31.58	7.85	36.2	3.23
2	7356.00	53.54	PK	74.00	20.46	1.00	125	41.58	38.51	8.75	35.3	11.96
2	7356.00	--	AV	54.00	--	--	--	--	--	--	--	--

Frequency(MHz):				2452			Polarity:			VERTICAL		
No.	Frequency (MHz)	Emission Level (dBuV/m)		Limit (dBuV/m)	Margin (dB)	Antenna Height (m)	Table Angle (Degree)	Raw Value (dBuV)	Antenna Factor (dB/m)	Cable Factor (dB)	Pre-amplifier (dB)	Correction Factor (dB/m)
1	4904.00	59.68	PK	74.00	14.32	1.00	105	56.45	31.58	7.85	36.2	3.23
1	4904.00	46.31	AV	54.00	7.69	1.00	105	43.08	31.58	7.85	36.2	3.23
2	7356.00	52.69	PK	74.00	21.31	1.00	155	40.73	38.51	8.75	35.3	11.96
2	7356.00	--	AV	54.00	--	--	--	--	--	--	--	--

**BT4.0 Mode (above 1GHz)**

Frequency(MHz):				2402			Polarity:			HORIZONTAL		
No.	Frequency (MHz)	Emission Level (dBuV/m)		Limit (dBuV/m)	Margin (dB)	Antenna Height (m)	Table Angle (Degree)	Raw Value (dBuV)	Antenna Factor (dB/m)	Cable Factor (dB)	Pre-amplifier (dB)	Correction Factor (dB/m)
1	4804.00	55.78	PK	74.00	18.22	1.00 H	110	53.88	31.42	6.98	36.5	1.90
1	4804.00	40.21	AV	54.00	13.79	1.00 H	110	38.31	31.42	6.98	36.5	1.90
2	7206.00	45.74	PK	74.00	28.26	1.00 H	125	35.14	37.03	8.87	35.3	10.60
2	7206.00	--	AV	--	--	--	--	--	--	--	--	--

Frequency(MHz):				2402			Polarity:			VERTICAL		
No.	Frequency (MHz)	Emission Level (dBuV/m)		Limit (dBuV/m)	Margin (dB)	Antenna Height (m)	Table Angle (Degree)	Raw Value (dBuV)	Antenna Factor (dB/m)	Cable Factor (dB)	Pre-amplifier (dB)	Correction Factor (dB/m)
1	4804.00	55.36	PK	74.00	18.64	1.00 V	125	53.46	31.42	6.98	36.5	1.90
1	4804.00	42.22	AV	54.00	11.78	1.00 V	125	40.32	31.42	6.98	36.5	1.90
2	7206.00	43.25	PK	74.00	30.75	1.00 V	110	32.65	37.03	8.87	35.3	10.60
2	7206.00	--	AV	--	--	--	--	--	--	--	--	--

Frequency(MHz):				2440			Polarity:			HORIZONTAL		
No.	Frequency (MHz)	Emission Level (dBuV/m)		Limit (dBuV/m)	Margin (dB)	Antenna Height (m)	Table Angle (Degree)	Raw Value (dBuV)	Antenna Factor (dB/m)	Cable Factor (dB)	Pre-amplifier (dB)	Correction Factor (dB/m)
1	4882.00	57.48	PK	74.00	16.52	1.00 H	175	55.42	30.98	7.58	36.5	2.06
1	4882.00	45.22	AV	54.00	8.78	1.00 H	175	43.16	30.98	7.58	36.5	2.06
2	7323.00	42.36	PK	74.00	31.64	1.00 H	85	31.44	37.66	8.56	35.3	10.92
2	7323.00	--	AV	--	--	--	--	--	--	--	--	--

Frequency(MHz):				2440			Polarity:			VERTICAL		
No.	Frequency (MHz)	Emission Level (dBuV/m)		Limit (dBuV/m)	Margin (dB)	Antenna Height (m)	Table Angle (Degree)	Raw Value (dBuV)	Antenna Factor (dB/m)	Cable Factor (dB)	Pre-amplifier (dB)	Correction Factor (dB/m)
1	4882.00	55.54	PK	74.00	18.46	1.00 V	185	53.48	30.98	7.58	36.5	2.06
1	4882.00	45.66	AV	54.00	8.34	1.00 V	185	43.60	30.98	7.58	36.5	2.06
2	7323.00	40.15	PK	74.00	33.85	1.00 V	85	29.23	37.66	8.56	35.3	10.92
2	7323.00	--	AV	--	--	--	--	--	--	--	--	--

Frequency(MHz):				2480			Polarity:			HORIZONTAL		
No.	Frequency (MHz)	Emission Level (dBuV/m)		Limit (dBuV/m)	Margin (dB)	Antenna Height (m)	Table Angle (Degree)	Raw Value (dBuV)	Antenna Factor (dB/m)	Cable Factor (dB)	Pre-amplifier (dB)	Correction Factor (dB/m)
1	4960.00	57.48	PK	74.00	16.52	1.00 H	76	54.41	31.47	7.80	36.2	3.07
1	4960.00	46.33	AV	54.00	7.67	1.00 H	76	43.26	31.47	7.80	36.2	3.07
2	7340.00	44.15	PK	74.00	29.85	1.00 H	130	32.41	38.32	8.72	35.3	11.74
2	7340.00	--	AV	--	--	--	--	--	--	--	--	--

Frequency(MHz):				2480			Polarity:			VERTICAL		
No.	Frequency (MHz)	Emission Level (dBuV/m)		Limit (dBuV/m)	Margin (dB)	Antenna Height (m)	Table Angle (Degree)	Raw Value (dBuV)	Antenna Factor (dB/m)	Cable Factor (dB)	Pre-amplifier (dB)	Correction Factor (dB/m)
1	4960.00	57.31	PK	74.00	16.69	1.00 V	120	54.24	31.47	7.80	-36.2	3.07
1	4960.00	44.25	AV	54.00	9.75	1.00 V	120	41.18	31.47	7.80	-36.2	3.07
2	7340.00	46.36	PK	74.00	27.64	1.00 V	133	34.62	38.32	8.72	-35.3	11.74
2	7340.00	--	AV	--	--	--	--	--	--	--	--	--



REMARKS:

1. Emission level (dBuV/m) =Raw Value (dBuV)+Correction Factor (dB/m)
2. Correction Factor (dB/m) = Antenna Factor (dB/m)+Cable Factor (dB)-Pre-amplifier Factor
3. Margin value = Limit value- Emission level.
4. -- Mean the PK detector measured value is below average limit.
5. The other emission levels were very low against the limit.

### 3.3. Maximum Peak Output Power

#### Limit

The Maximum Peak Output Power Measurement is 30dBm.

#### Test Procedure

Remove the antenna from the EUT and then connect a low loss RF cable from the antenna port to the power sensor.

#### Test Configuration



#### Test Results

##### WIFI

Type	Channel	Output power (dBm)	Limit (dBm)	Result
802.11b	01	9.16	30.00	Pass
	06	9.07		
	11	9.15		
802.11g	01	9.35	30.00	Pass
	06	9.49		
	11	9.15		
802.11n(H20)	01	8.85	30.00	Pass
	06	8.99		
	11	8.89		
802.11n(H40)	03	7.60	30.00	Pass
	06	7.64		
	09	7.56		

Note: 1.The test results including the cable loss.

##### BT4.0

Type	Channel	Output power (dBm)	Limit (dBm)	Result
GFSK	00	-5.83	30.00	Pass
	19	-5.80		
	39	-6.30		

Note: The test results including the cable loss.

### 3.4. Power Spectral Density

#### Limit

For digitally modulated systems, the power spectral density conducted from the intentional radiator to the antenna shall not be greater than 8 dBm in any 3 kHz band during any time interval of continuous transmission.

#### Test Procedure

1. Use this procedure when the maximum peak conducted output power in the fundamental emission is used to demonstrate compliance.
2. Set the RBW  $\geq$  3 kHz.
3. Set the VBW  $\geq$  3 $\times$  RBW.
4. Set the span to 1.5 times the DTS channel bandwidth.
5. Detector = peak.
6. Sweep time = auto couple.
7. Trace mode = max hold.
8. Allow trace to fully stabilize.
9. Use the peak marker function to determine the maximum power level.
10. If measured value exceeds limit, reduce RBW (no less than 3 kHz) and repeat.
11. The resulting peak PSD level must be 8dBm.

#### Test Configuration

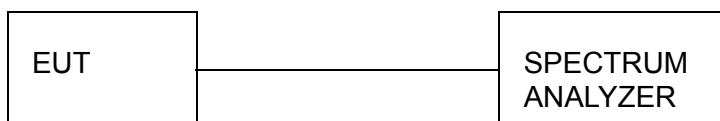

#### Test Results

##### WIFI

Type	Channel	Power Spectral Density (dBm/3KHz)	Limit (dBm/3KHz)	Result
802.11b	01	-9.82	8.00	Pass
	06	-10.41		
	11	-10.88		
802.11g	01	-12.85	8.00	Pass
	06	-13.69		
	11	-14.27		
802.11n(HT20)	01	-15.61	8.00	Pass
	06	-15.86		
	11	-16.75		
802.11n(HT40)	03	-21.14	8.00	Pass
	06	-20.95		
	09	-20.83		

##### BT4.0

Type	Channel	Power Spectral Density (dBm/3KHz)	Limit (dBm/3KHz)	Result
BT4.0	00	-19.78	8.00	Pass
	19	-19.66		
	39	-20.31		

Test plot as follows:

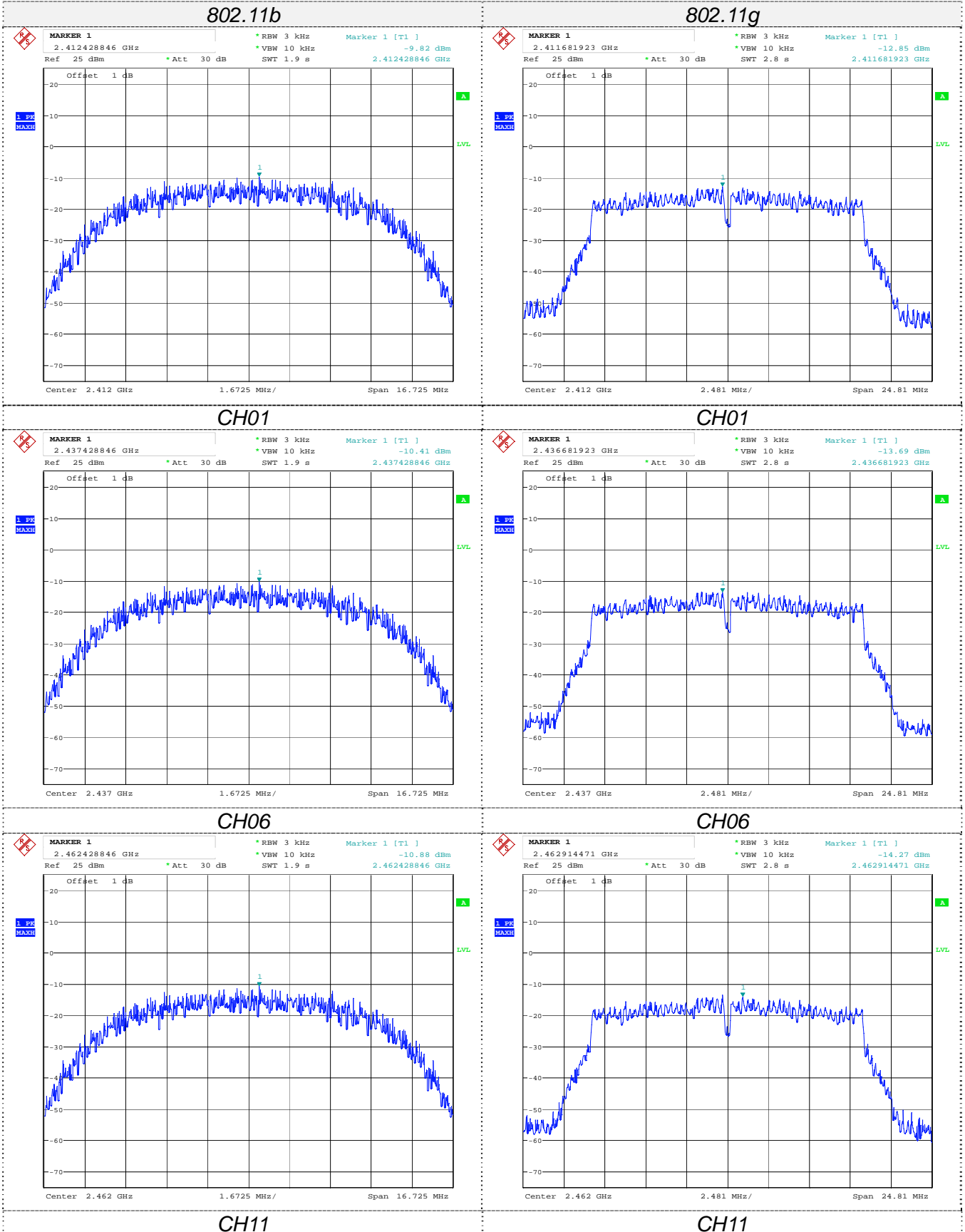

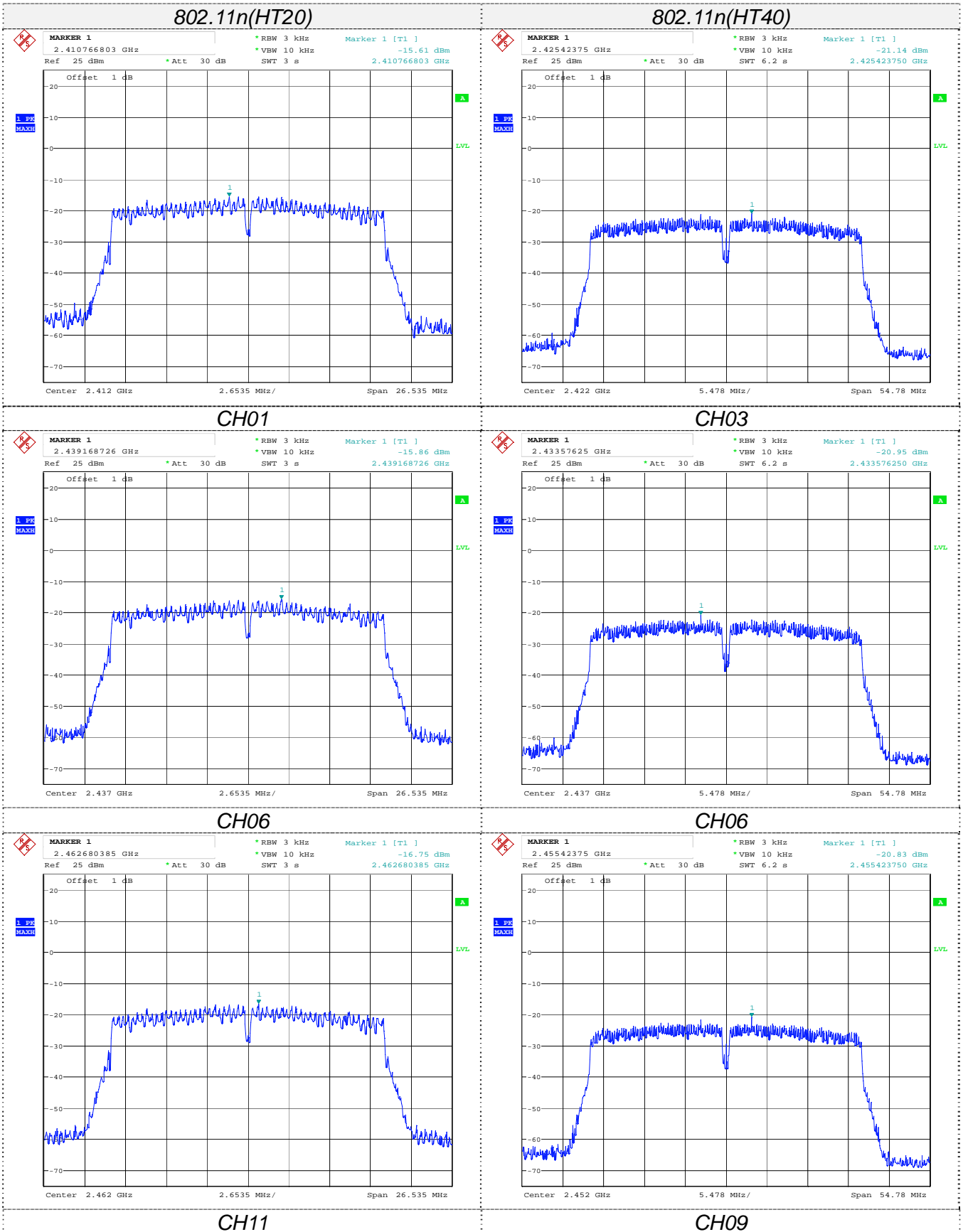



**BT4.0**

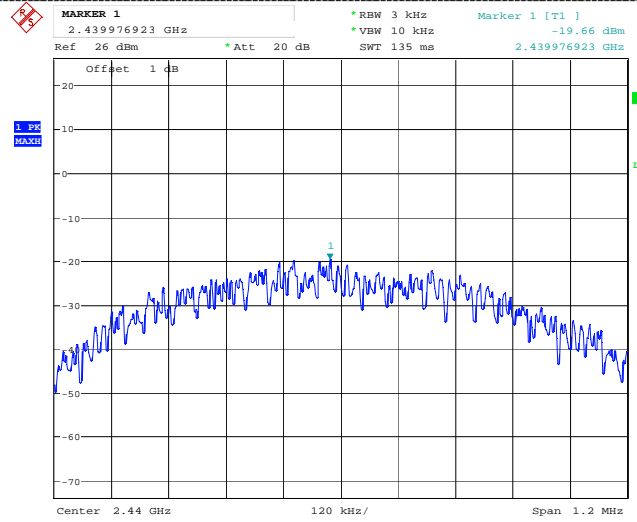
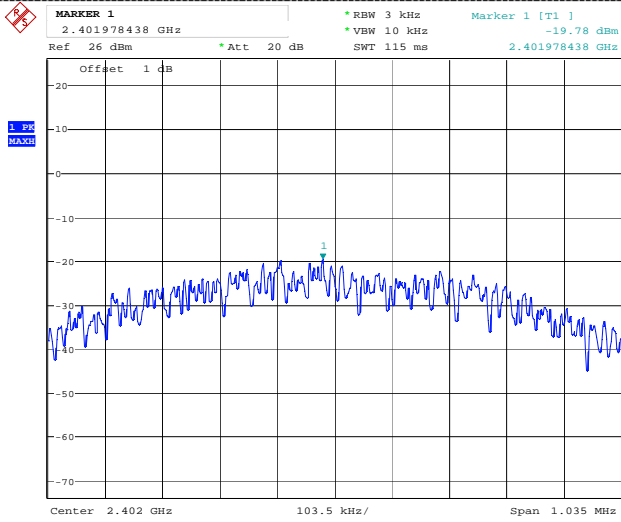

**CH00**

**CH19**

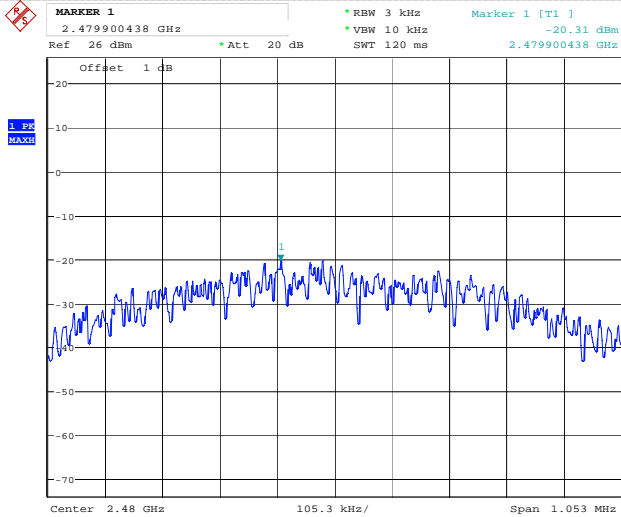

**CH39**

### 3.5. 6dB Bandwidth

#### Limit

For digital modulation systems, the minimum 6 dB bandwidth shall be at least 500 kHz

#### Test Procedure

The transmitter output was connected to the spectrum analyzer through an attenuator. The bandwidth of the fundamental frequency was measured by spectrum analyzer with 100 KHz RBW and 300 KHz VBW. The 6dB bandwidth is defined as the total spectrum the power of which is higher than peak power minus 6dB.

#### Test Configuration

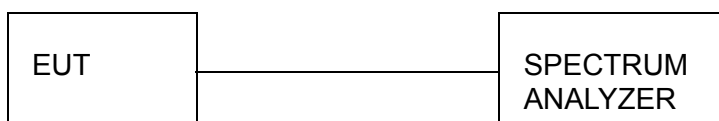

#### Test Results

##### WIFI

Type	Channel	6dB Bandwidth (MHz)	Limit (KHz)	Result
802.11b	01	11.15	≥500	Pass
	06	11.15		
	11	11.15		
802.11g	01	16.64	≥500	Pass
	06	16.49		
	11	16.49		
802.11n(HT20)	01	17.64	≥500	Pass
	06	17.69		
	11	17.69		
802.11n(HT40)	03	36.44	≥500	Pass
	06	36.52		
	09	36.35		

##### BT4.0

Type	Channel	6dB Bandwidth (MHz)	Limit (KHz)	Result
GFSK	00	0.69	≥500	Pass
	19	0.70		
	39	0.70		

Test plot as follows:

802.11b

802.11g

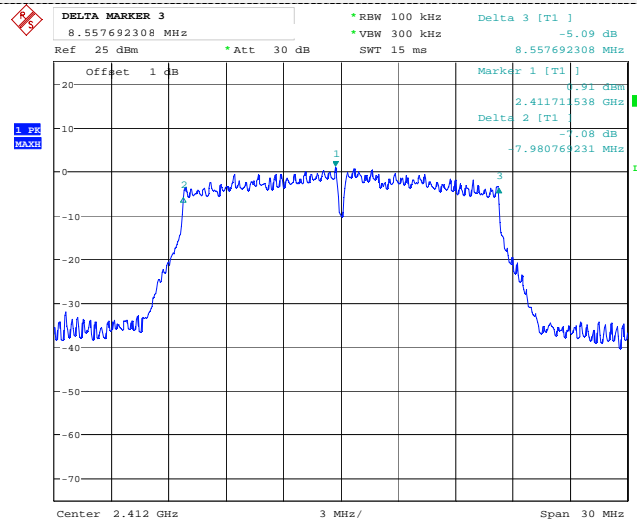
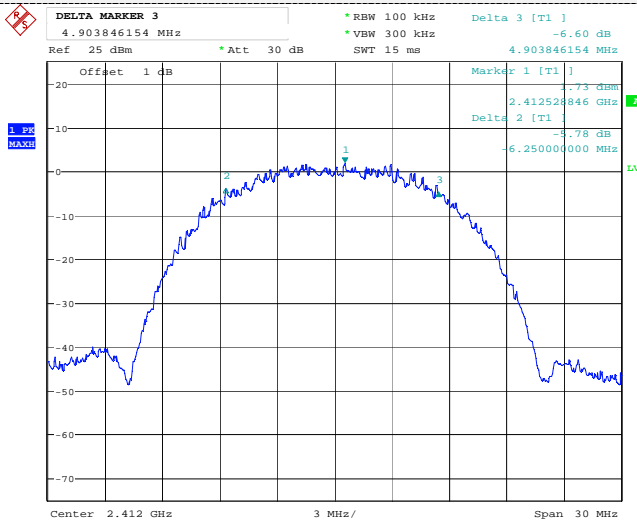

CH01

CH01

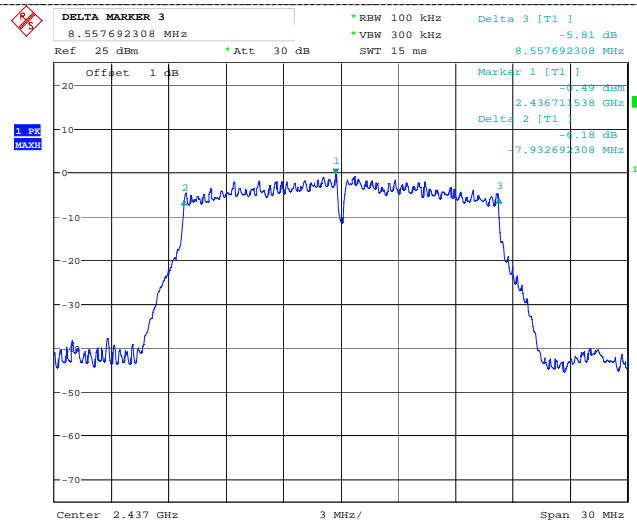
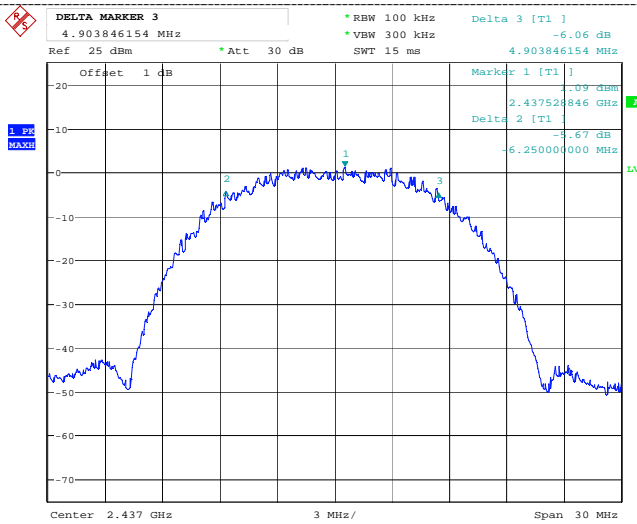

CH06

CH06

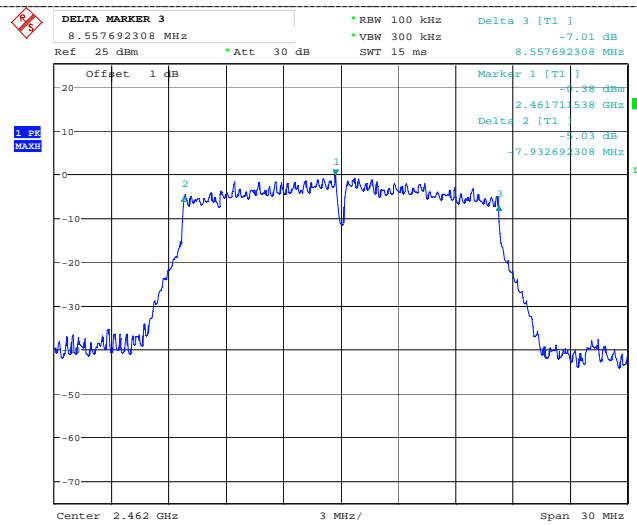
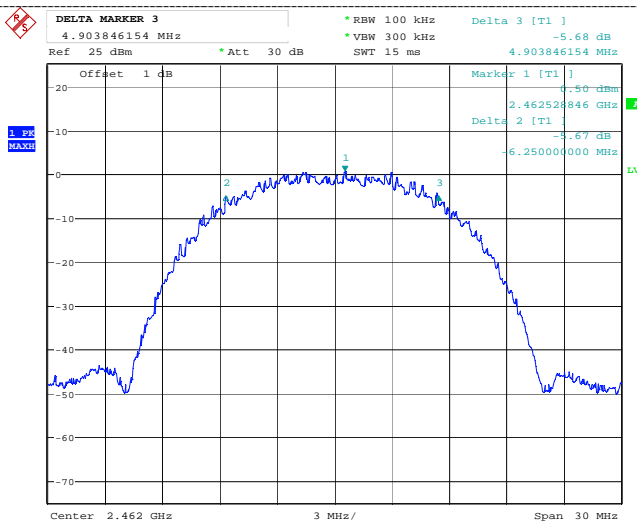

CH11

CH11

802.11n(HT20)

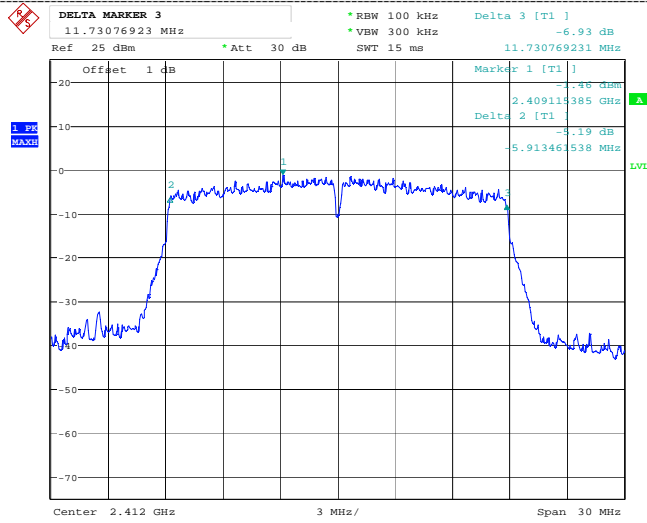

802.11n(HT40)

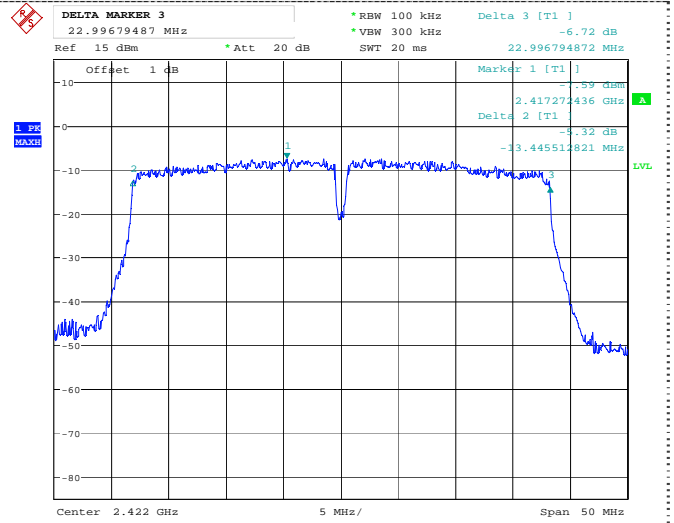

CH01

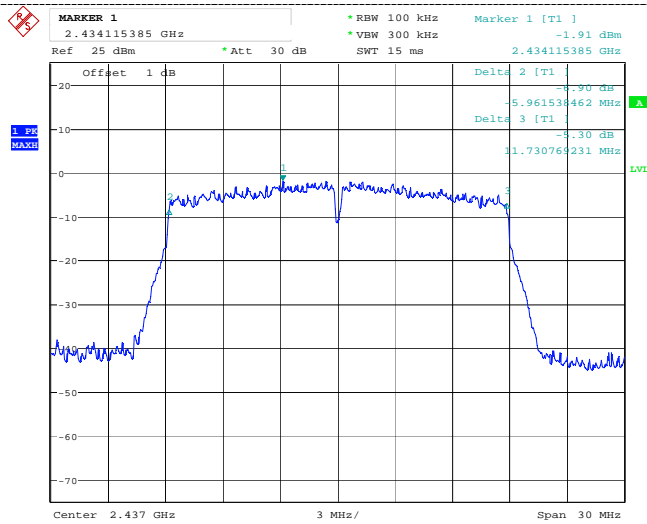

CH00

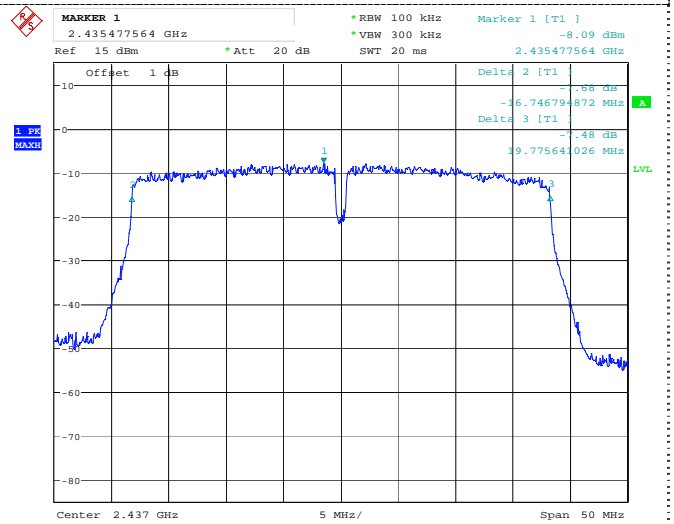

CH06

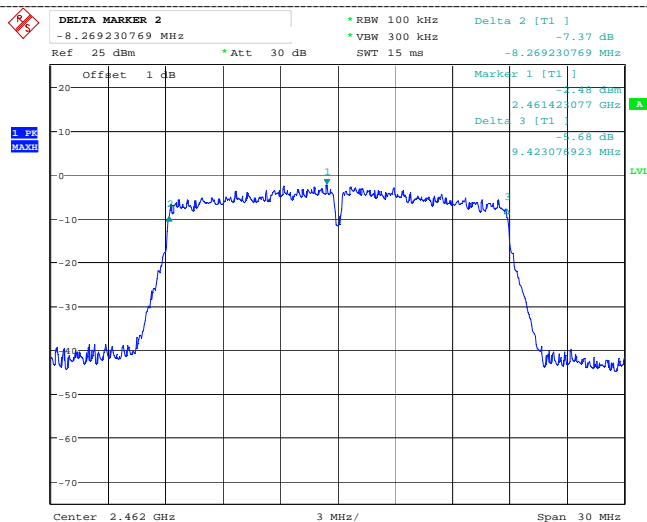

CH06

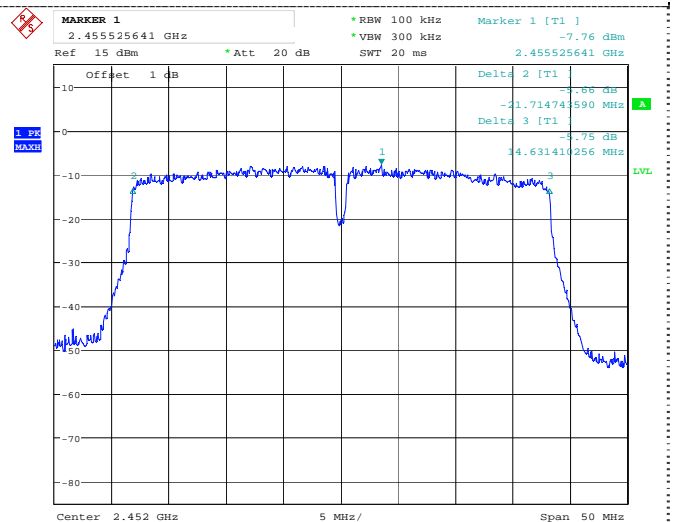

CH11

CH09

**BT4.0**

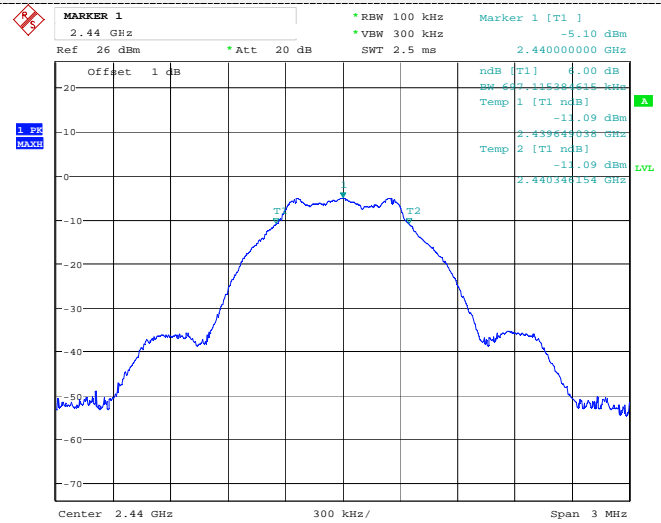
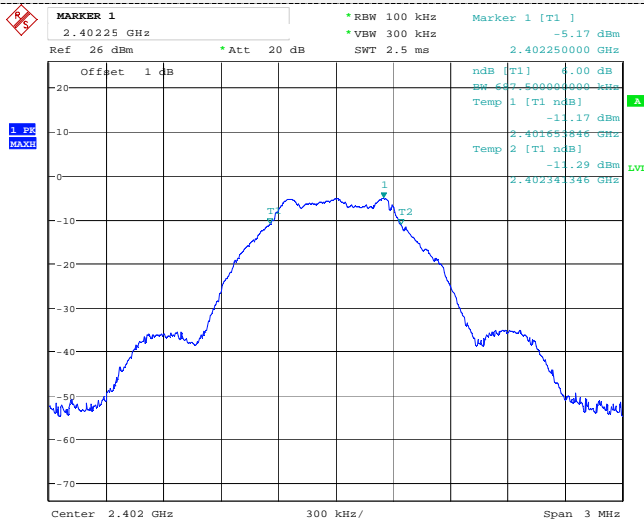

**CH00**

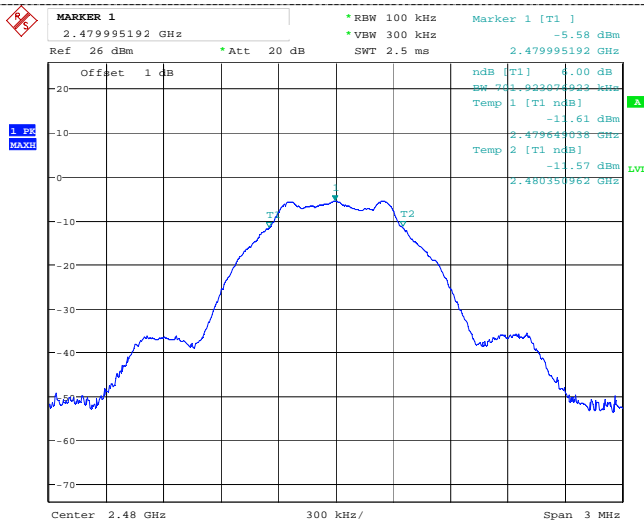

**CH19**

**CH39**

### 3.6. Band Edge Compliance of RF Emission

#### Limit

In any 100 kHz bandwidth outside the frequency band in which the spread spectrum or digitally modulated intentional radiator is operating, the radio frequency power that is produced by the intentional radiator shall be at least 20 dB below that in the 100 kHz bandwidth within the band that contains the highest level of the desired power, based on either an RF conducted or a radiated measurement, provided the transmitter demonstrates compliance with the peak conducted power limits. If the transmitter complies with the conducted power limits based on the use of RMS averaging over a time interval, as permitted under paragraph (b)(3) of this section, the attenuation required under this paragraph shall be 30 dB instead of 20 dB. Attenuation below the general limits specified in §15.209(a) is not required. In addition, radiated emissions which fall in the restricted bands, as defined in §15.205(a), must also comply with the radiated emission limits specified in §15.209(a) (see §15.205(c)).

Below -20dB of the highest emission level in operating band.

Radiated emissions which fall in the restricted bands, as defined in § 15.205(a), must also comply with the radiated emission limits specified in § 15.209(a)

#### Test Procedure

##### **Test Procedure for conducted method**

1. Remove the antenna from the EUT and then connect to a low loss RF cable from the antenna port to a spectrum analyzer
2. Turn on the EUT and make it operate in transmitting mode. Then set it to Low Channel and High Channel within its operating range, and make sure the instrument is operated in its linear range.
3. Set spectrum analyzer RBW =100 kHz and VBW=300 kHz
4. Use spectrum analyzer Maxhold function to allow trace to fully stabilize
5. Marker the highest point which fall into restricted frequency bands
6. Repeat above procedures until all measured frequencies were complete.

##### **Test Procedure for radiated method**

1. The EUT was placed on the top of a rotating table 0.8 meters above the ground at a 3 meter anechoic chamber. The table was rotated 360 degrees to determine the position of the highest radiation.
2. The EUT was set 3 meters away from the interference receiving antenna, which was mounted on the top of a variable height antenna tower.
3. The antenna height is varied from one meter to four meters above the ground to determine the maximum value of the field strength. Both horizontal and vertical polarizations of the antenna are set to make the measurement.
4. For each suspected emission, the EUT was arranged to its worst case and then the antenna was tuned to heights from 1 meter to 4 meters and the rotatable table was turned from 0 degrees to 360 degrees to find the maximum reading.
5. The test-receiver system was set to Peak Detect Function and Specified Bandwidth with Maximum Hold Mode.
6. Place a marker at the end of the restricted band closest to the transmit frequency to show compliance. Also measure any emissions in the restricted bands. Save the spectrum analyzer plot. Repeat for each power and modulation for lowest and highest channel
7. Test the EUT in the lowest channel, the highest channel
8. The radiation measurements are performed in X, Y, Z axis positioning. And found the X axis positioning which it is worse case, only the test worst case mode is recorded in the report.
9. Repeat above procedures until all frequencies measured was complete.

**Test Results**

**A. Conducted measurements**

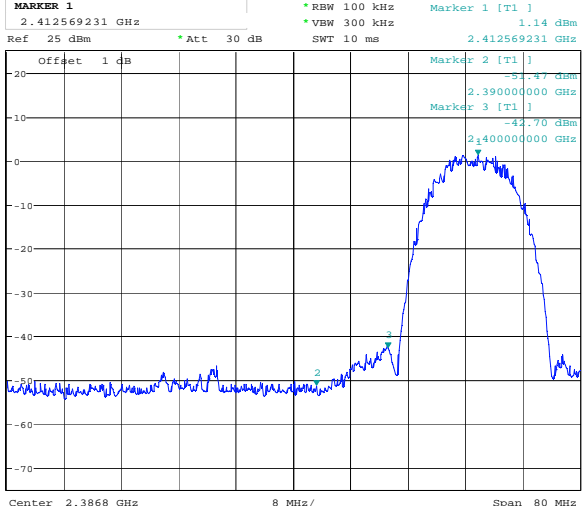
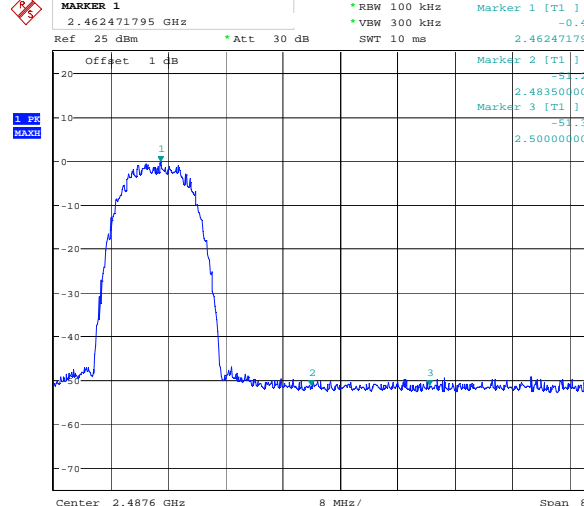
<b>802.11b</b>			
Frequency (MHz)	Delta Peak to Band emission (dBc)	Limit (dBc)	Verdict
2390.00	52.61	20	PASS
2483.50	50.85	20	PASS
			
<b>2412</b>		<b>2462</b>	

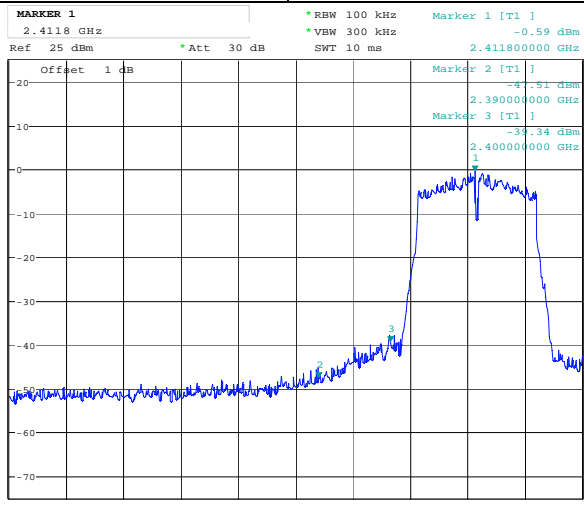
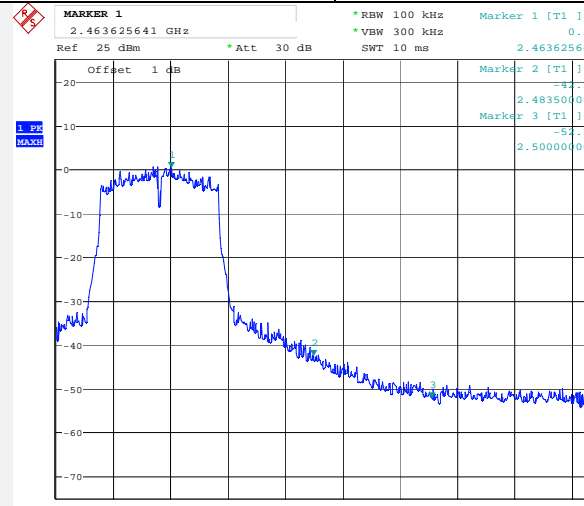
<b>802.11g</b>			
Frequency (MHz)	Delta Peak to Band emission (dBc)	Limit (dBc)	Verdict
2390.00	46.92	20	PASS
2483.50	42.81	20	PASS
			
<b>2412</b>		<b>2462</b>	

802.11n20			
Frequency (MHz)	Delta Peak to Band emission (dBc)	Limit (dBc)	Verdict
2390.00	36.65	20	PASS
2483.50	44.47	20	PASS
		2412	
		2462	

802.11n40			
Frequency (MHz)	Delta Peak to Band emission (dBc)	Limit (dBc)	Verdict
2390.00	41.70	20	PASS
2483.50	41.48	20	PASS
		2422	
		2452	



BT4.0			
Frequency (MHz)	Delta Peak to Band emission (dBc)	Limit (dBc)	Verdict
2390.00	47.47	20	PASS
2483.50	48.05	20	PASS

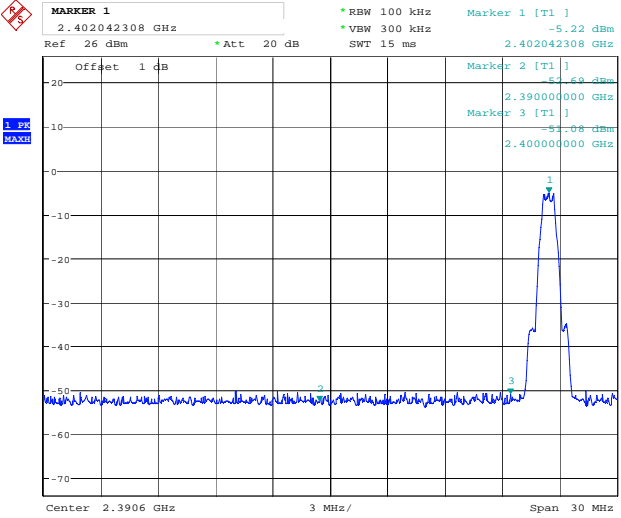

Center: 2.3906 GHz, Span: 30 MHz

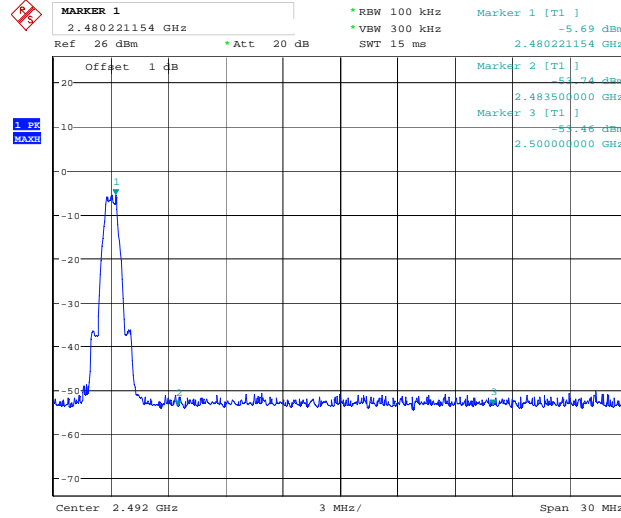

Center: 2.492 GHz, Span: 30 MHz

**B. Radiated measurements**

**802.11b**

Frequency(MHz):		2412				Polarity:			HORIZONTAL		
Frequency (MHz)	Emission Level (dBuV/m)	Limit (dBuV/m)	Margin (dB)	Antenna Height (m)	Table Angle (Degree)	Raw Value (dBuV)	Antenna Factor (dB/m)	Cable Factor (dB)	Pre-amplifier (dB)	Correction Factor (dB/m)	
2390.00	62.47 PK	74.00	11.53	1.00	110	67.78	27.49	3.32	36.12	-5.31	
2390.00	47.26 AV	54.00	6.74	1.00	110	52.57	27.49	3.32	36.12	-5.31	
Frequency(MHz):		2412				Polarity:			VERTICAL		
Frequency (MHz)	Emission Level (dBuV/m)	Limit (dBuV/m)	Margin (dB)	Antenna Height (m)	Table Angle (Degree)	Raw Value (dBuV)	Antenna Factor (dB/m)	Cable Factor (dB)	Pre-amplifier (dB)	Correction Factor (dB/m)	
2390.00	63.34 PK	74.00	10.66	1.00	65	68.65	27.49	3.32	36.12	-5.31	
2390.00	48.69 AV	54.00	5.31	1.00	65	54.00	27.49	3.32	36.12	-5.31	
Frequency(MHz):		2462				Polarity:			HORIZONTAL		
Frequency (MHz)	Emission Level (dBuV/m)	Limit (dBuV/m)	Margin (dB)	Antenna Height (m)	Table Angle (Degree)	Raw Value (dBuV)	Antenna Factor (dB/m)	Cable Factor (dB)	Pre-amplifier (dB)	Correction Factor (dB/m)	
2483.50	60.55 PK	74.00	13.45	1.00	181	66.27	27.45	3.38	36.55	-5.72	
2483.50	45.23 AV	54.00	8.77	1.00	181	50.95	27.45	3.38	36.55	-5.72	
Frequency(MHz):		2462				Polarity:			VERTICAL		
Frequency (MHz)	Emission Level (dBuV/m)	Limit (dBuV/m)	Margin (dB)	Antenna Height (m)	Table Angle (Degree)	Raw Value (dBuV)	Antenna Factor (dB/m)	Cable Factor (dB)	Pre-amplifier (dB)	Correction Factor (dB/m)	
2483.50	63.55 PK	74.00	10.45	1.00	145	69.27	27.45	3.38	36.55	-5.72	
2483.50	47.12 AV	54.00	6.88	1.00	145	52.84	27.45	3.38	36.55	-5.72	

**802.11g**

Frequency(MHz):			2412			Polarity:			HORIZONTAL		
Frequency (MHz)	Emission Level (dBuV/m)		Limit (dBuV/m)	Margin (dB)	Antenna Height (m)	Table Angle (Degree)	Raw Value (dBuV)	Antenna Factor (dB/m)	Cable Factor (dB)	Pre-amplifier (dB)	Correction Factor (dB/m)
2390.00	64.74	PK	74.00	9.26	1.00	139	70.05	27.49	3.32	36.12	-5.31
2390.00	48.36	AV	54.00	5.64	1.00	139	53.67	27.49	3.32	36.12	-5.31
Frequency(MHz):			2412			Polarity:			VERTICAL		
Frequency (MHz)	Emission Level (dBuV/m)		Limit (dBuV/m)	Margin (dB)	Antenna Height (m)	Table Angle (Degree)	Raw Value (dBuV)	Antenna Factor (dB/m)	Cable Factor (dB)	Pre-amplifier (dB)	Correction Factor (dB/m)
2390.00	65.69	PK	74.00	8.31	1.00	48	71.00	27.49	3.32	36.12	-5.31
2390.00	49.56	AV	54.00	4.44	1.00	48	54.87	27.49	3.32	36.12	-5.31
Frequency(MHz):			2462			Polarity:			HORIZONTAL		
Frequency (MHz)	Emission Level (dBuV/m)		Limit (dBuV/m)	Margin (dB)	Antenna Height (m)	Table Angle (Degree)	Raw Value (dBuV)	Antenna Factor (dB/m)	Cable Factor (dB)	Pre-amplifier (dB)	Correction Factor (dB/m)
2483.50	65.65	PK	74.00	8.35	1.00	50	71.37	27.45	3.38	36.55	-5.72
2483.50	48.26	AV	54.00	5.74	1.00	50	53.98	27.45	3.38	36.55	-5.72
Frequency(MHz):			2462			Polarity:			VERTICAL		
Frequency (MHz)	Emission Level (dBuV/m)		Limit (dBuV/m)	Margin (dB)	Antenna Height (m)	Table Angle (Degree)	Raw Value (dBuV)	Antenna Factor (dB/m)	Cable Factor (dB)	Pre-amplifier (dB)	Correction Factor (dB/m)
2483.50	64.30	PK	74.00	9.70	1.00	125	70.02	27.45	3.38	36.55	-5.72
2483.50	49.45	AV	54.00	4.55	1.00	125	55.17	27.45	3.38	36.55	-5.72

**802.11n20**

Frequency(MHz):			2412			Polarity:			HORIZONTAL		
Frequency (MHz)	Emission Level (dBuV/m)		Limit (dBuV/m)	Margin (dB)	Antenna Height (m)	Table Angle (Degree)	Raw Value (dBuV)	Antenna Factor (dB/m)	Cable Factor (dB)	Pre-amplifier (dB)	Correction Factor (dB/m)
2390.00	63.22	PK	74.00	10.78	1.00	145	68.53	27.49	3.32	36.12	-5.31
2390.00	46.37	AV	54.00	7.63	1.00	145	51.68	27.49	3.32	36.12	-5.31
Frequency(MHz):			2412			Polarity:			VERTICAL		
Frequency (MHz)	Emission Level (dBuV/m)		Limit (dBuV/m)	Margin (dB)	Antenna Height (m)	Table Angle (Degree)	Raw Value (dBuV)	Antenna Factor (dB/m)	Cable Factor (dB)	Pre-amplifier (dB)	Correction Factor (dB/m)
2390.00	64.36	PK	74.00	9.64	1.00	55	69.67	27.49	3.32	36.12	-5.31
2390.00	47.15	AV	54.00	6.85	1.00	55	52.46	27.49	3.32	36.12	-5.31
Frequency(MHz):			2462			Polarity:			HORIZONTAL		
Frequency (MHz)	Emission Level (dBuV/m)		Limit (dBuV/m)	Margin (dB)	Antenna Height (m)	Table Angle (Degree)	Raw Value (dBuV)	Antenna Factor (dB/m)	Cable Factor (dB)	Pre-amplifier (dB)	Correction Factor (dB/m)
2483.50	66.12	PK	74.00	7.88	1.00	123	71.84	27.45	3.38	36.55	-5.72
2483.50	47.20	AV	54.00	6.80	1.00	123	52.92	27.45	3.38	36.55	-5.72
Frequency(MHz):			2462			Polarity:			VERTICAL		
Frequency (MHz)	Emission Level (dBuV/m)		Limit (dBuV/m)	Margin (dB)	Antenna Height (m)	Table Angle (Degree)	Raw Value (dBuV)	Antenna Factor (dB/m)	Cable Factor (dB)	Pre-amplifier (dB)	Correction Factor (dB/m)
2483.50	65.32	PK	74.00	8.68	1.00	75	71.04	27.45	3.38	36.55	-5.72
2483.50	49.21	AV	54.00	4.79	1.00	75	54.93	27.45	3.38	36.55	-5.72

**802.11n40**

Frequency(MHz):			2422			Polarity:			HORIZONTAL		
Frequency (MHz)	Emission Level (dBuV/m)		Limit (dBuV/m)	Margin (dB)	Antenna Height (m)	Table Angle (Degree)	Raw Value (dBuV)	Antenna Factor (dB/m)	Cable Factor (dB)	Pre-amplifier (dB)	Correction Factor (dB/m)
2390.00	64.22	PK	74.00	9.78	1.00	137	69.53	27.49	3.32	36.12	-5.31
2390.00	48.12	AV	54.00	5.88	1.00	137	53.43	27.49	3.32	36.12	-5.31
Frequency(MHz):			2422			Polarity:			VERTICAL		
Frequency (MHz)	Emission Level (dBuV/m)		Limit (dBuV/m)	Margin (dB)	Antenna Height (m)	Table Angle (Degree)	Raw Value (dBuV)	Antenna Factor (dB/m)	Cable Factor (dB)	Pre-amplifier (dB)	Correction Factor (dB/m)
2390.00	66.39	PK	74.00	7.61	1.00	121	71.70	27.49	3.32	36.12	-5.31
2390.00	48.26	AV	54.00	5.74	1.00	121	53.57	27.49	3.32	36.12	-5.31
Frequency(MHz):			2452			Polarity:			HORIZONTAL		
Frequency (MHz)	Emission Level (dBuV/m)		Limit (dBuV/m)	Margin (dB)	Antenna Height (m)	Table Angle (Degree)	Raw Value (dBuV)	Antenna Factor (dB/m)	Cable Factor (dB)	Pre-amplifier (dB)	Correction Factor (dB/m)
2483.50	66.64	PK	74.00	7.36	1.00	55	72.36	27.45	3.38	36.55	-5.72
2483.50	47.26	AV	54.00	6.74	1.00	55	52.98	27.45	3.38	36.55	-5.72
Frequency(MHz):			2452			Polarity:			VERTICAL		
Frequency (MHz)	Emission Level (dBuV/m)		Limit (dBuV/m)	Margin (dB)	Antenna Height (m)	Table Angle (Degree)	Raw Value (dBuV)	Antenna Factor (dB/m)	Cable Factor (dB)	Pre-amplifier (dB)	Correction Factor (dB/m)
2483.50	66.47	PK	74.00	7.53	1.00	135	72.19	27.45	3.38	36.55	-5.72
2483.50	47.52	AV	54.00	6.48	1.00	135	53.24	27.45	3.38	36.55	-5.72

**BT4.0**

Frequency(MHz):			2402			Polarity:			HORIZONTAL		
Frequency (MHz)	Emission Level (dBuV/m)		Limit (dBuV/m)	Margin (dB)	Antenna Height (m)	Table Angle (Degree)	Raw Value (dBuV)	Antenna Factor (dB/m)	Cable Factor (dB)	Pre-amplifier (dB)	Correction Factor (dB/m)
2390.00	58.65	PK	74.00	15.35	1.00	135	63.96	27.49	3.32	36.12	-5.31
2390.00	39.25	AV	54.00	14.75	1.00	135	44.56	27.49	3.32	36.12	-5.31
Frequency(MHz):			2402			Polarity:			VERTICAL		
Frequency (MHz)	Emission Level (dBuV/m)		Limit (dBuV/m)	Margin (dB)	Antenna Height (m)	Table Angle (Degree)	Raw Value (dBuV)	Antenna Factor (dB/m)	Cable Factor (dB)	Pre-amplifier (dB)	Correction Factor (dB/m)
2390.00	57.47	PK	74.00	16.53	1.00	150	62.78	27.49	3.32	36.12	-5.31
2390.00	41.47	AV	54.00	12.53	1.00	150	46.78	27.49	3.32	36.12	-5.31
Frequency(MHz):			2480			Polarity:			HORIZONTAL		
Frequency (MHz)	Emission Level (dBuV/m)		Limit (dBuV/m)	Margin (dB)	Antenna Height (m)	Table Angle (Degree)	Raw Value (dBuV)	Antenna Factor (dB/m)	Cable Factor (dB)	Pre-amplifier (dB)	Correction Factor (dB/m)
2483.50	57.26	PK	74.00	16.74	1.00	251	62.98	27.45	3.38	36.55	-5.72
2483.50	40.22	AV	54.00	13.78	1.00	251	45.94	27.45	3.38	36.55	-5.72
Frequency(MHz):			2480			Polarity:			VERTICAL		
Frequency (MHz)	Emission Level (dBuV/m)		Limit (dBuV/m)	Margin (dB)	Antenna Height (m)	Table Angle (Degree)	Raw Value (dBuV)	Antenna Factor (dB/m)	Cable Factor (dB)	Pre-amplifier (dB)	Correction Factor (dB/m)
2483.50	58.47	PK	74.00	15.53	1.00	175	64.19	27.45	3.38	36.55	-5.72
2483.50	41.36	AV	54.00	12.64	1.00	175	47.08	27.45	3.38	36.55	-5.72

### 3.7. Spurious RF Conducted Emission

#### Limit

1. Below -20dB of the highest emission level in operating band.
2. Fall in the restricted bands listed in section 15.205. The maximum permitted average field strength is listed in section 15.209.

#### Test Procedure

The Spurious RF conducted emissions compliance of RF radiated emission should be measured by following the guidance in ANSI C63.10-2009 with respect to maximizing the emission by rotating the EUT, measuring the emission while the EUT is situated in three orthogonal planes (if appropriate), adjusting the measurement antenna height and polarization etc. Set RBW=100 kHz and VBM= 300 KHz to measure the peak field strength, and measured frequency range from 30MHz to 26.5GHz.

#### Test Configuration

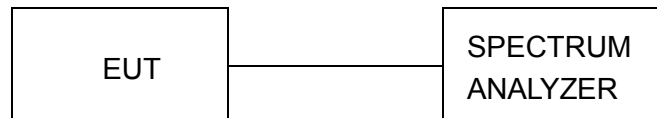

#### Test Results

Remark: The measurement frequency range is from 30MHz to the 10th harmonic of the fundamental frequency. The lowest, middle and highest channels are tested to verify the spurious emissions and bandage measurement data.

Test plot as follows:

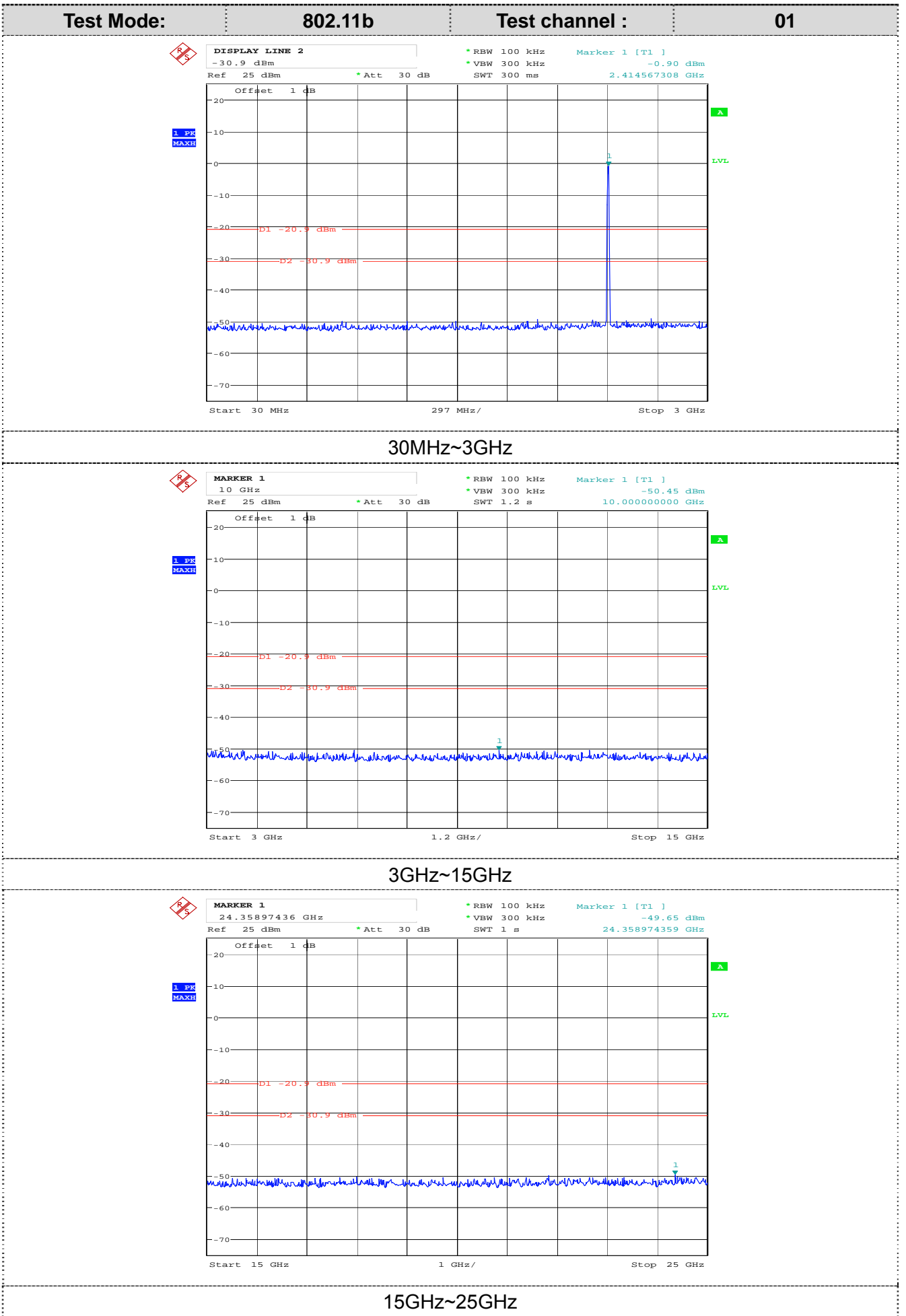

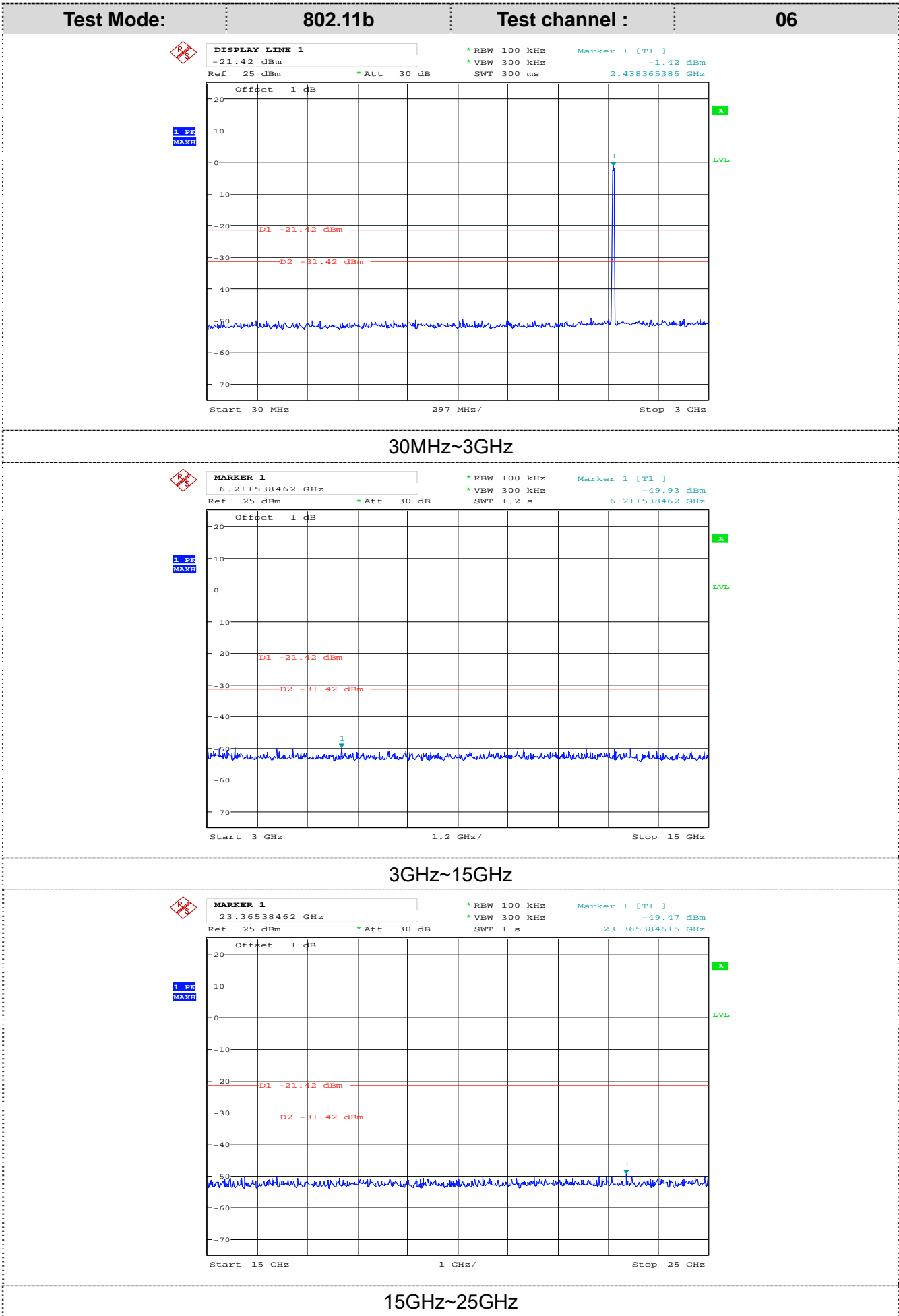

**Test Mode:** 802.11b **Test channel :** 11

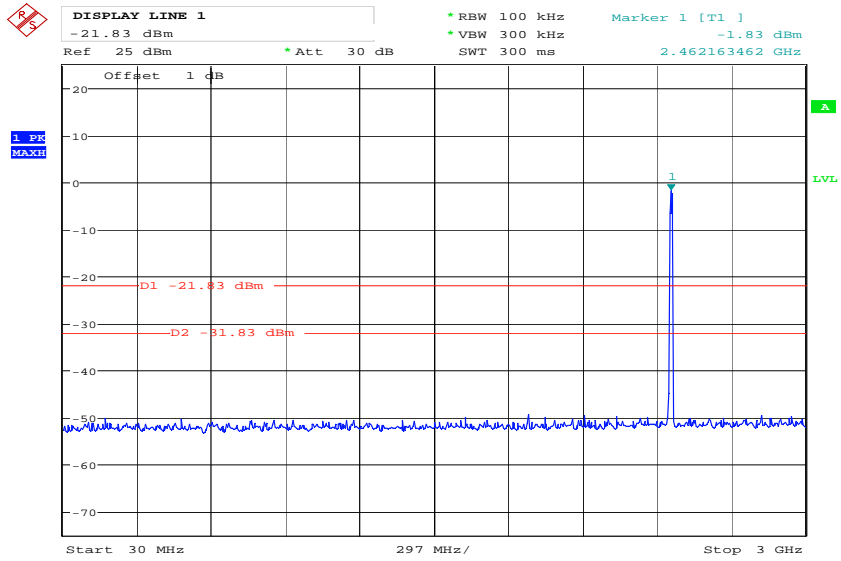

**30MHz~3GHz**

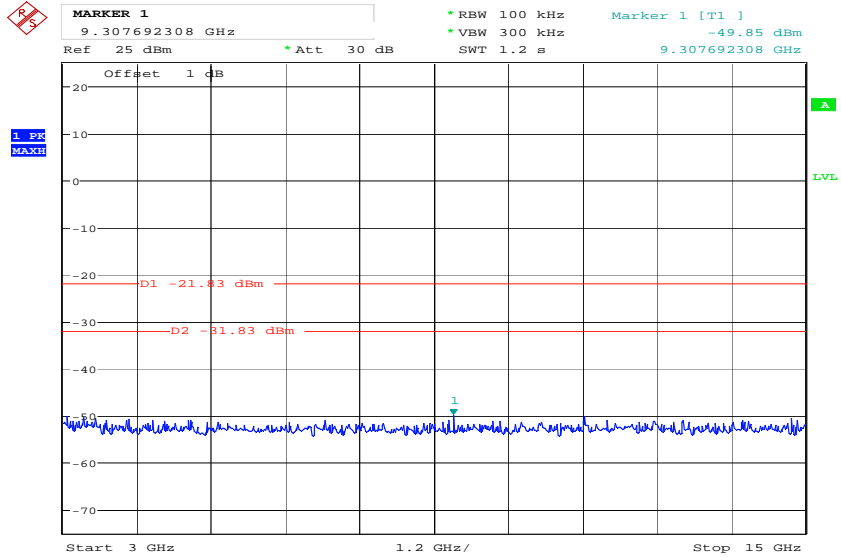

**3GHz~15GHz**

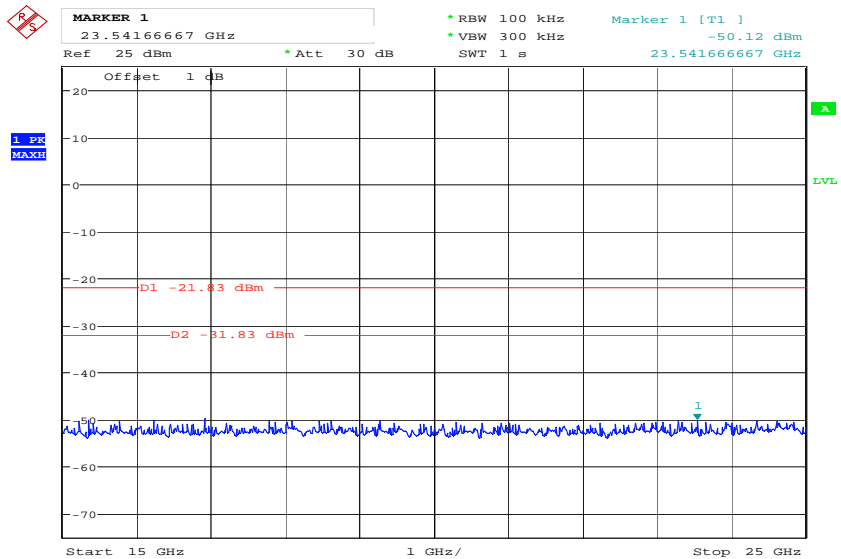

**15GHz~25GHz**

**Test Mode:** 802.11g **Test channel :** 01

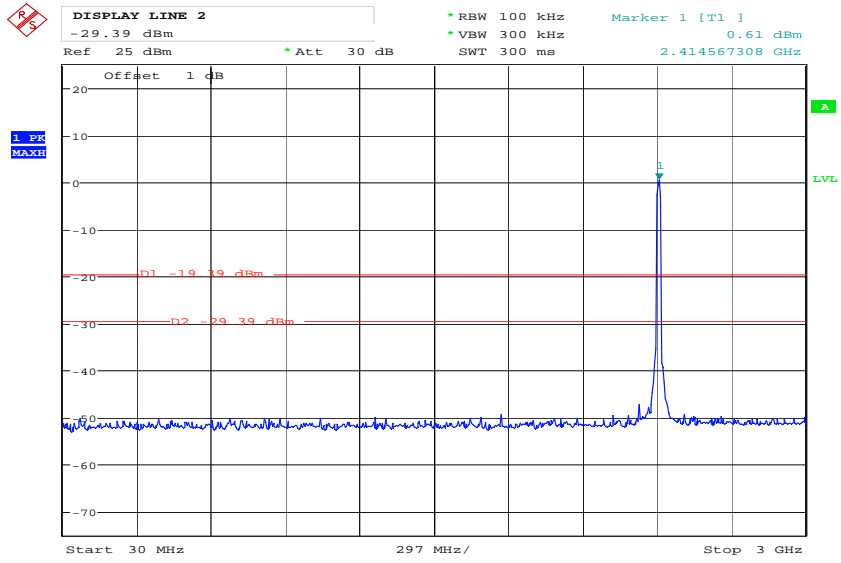

30MHz~3GHz

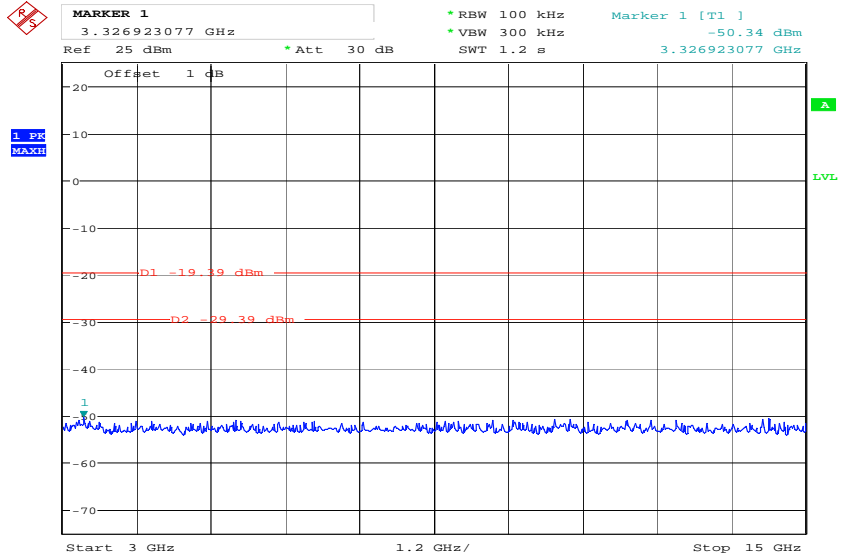

3GHz~15GHz

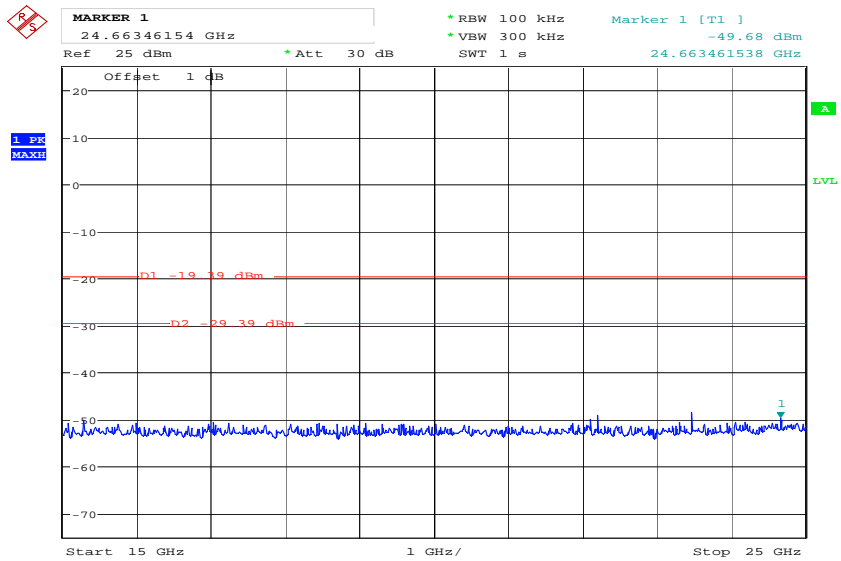

15GHz~25GHz



**Test Mode:** 802.11g **Test channel :** 06

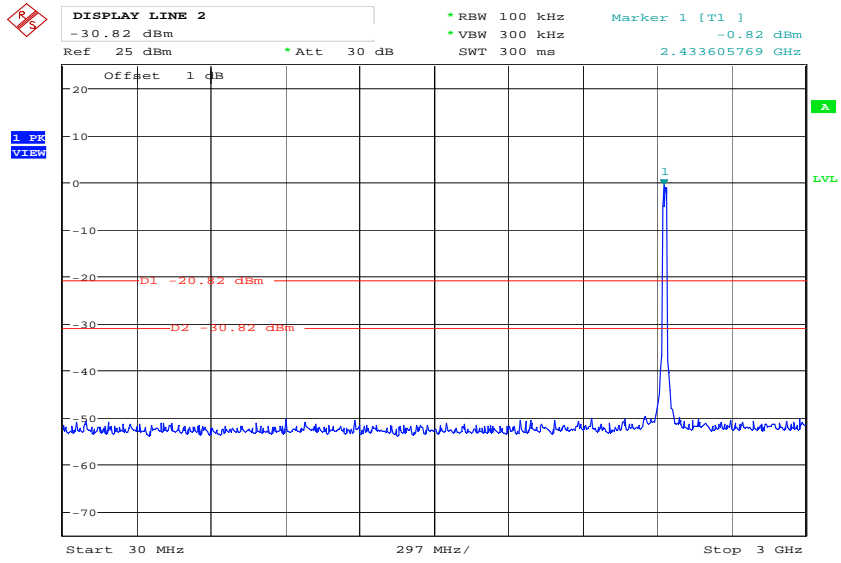

30MHz~3GHz

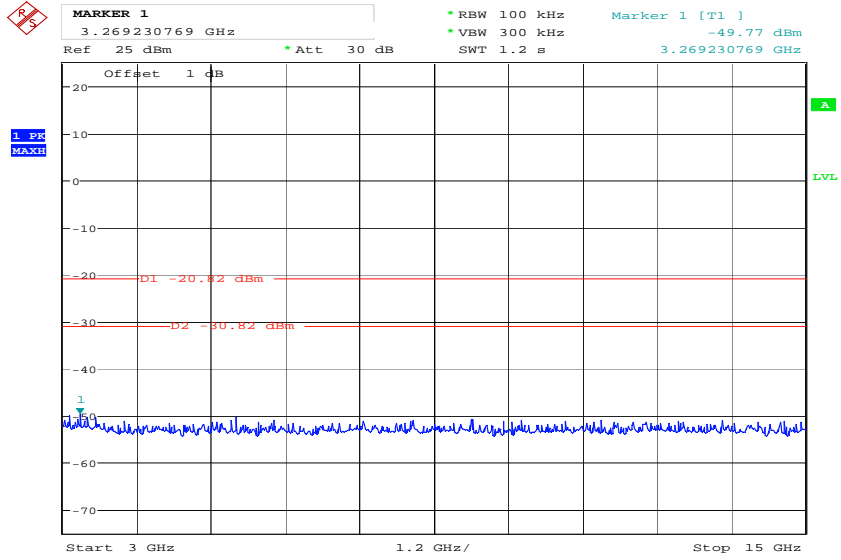

3GHz~15GHz

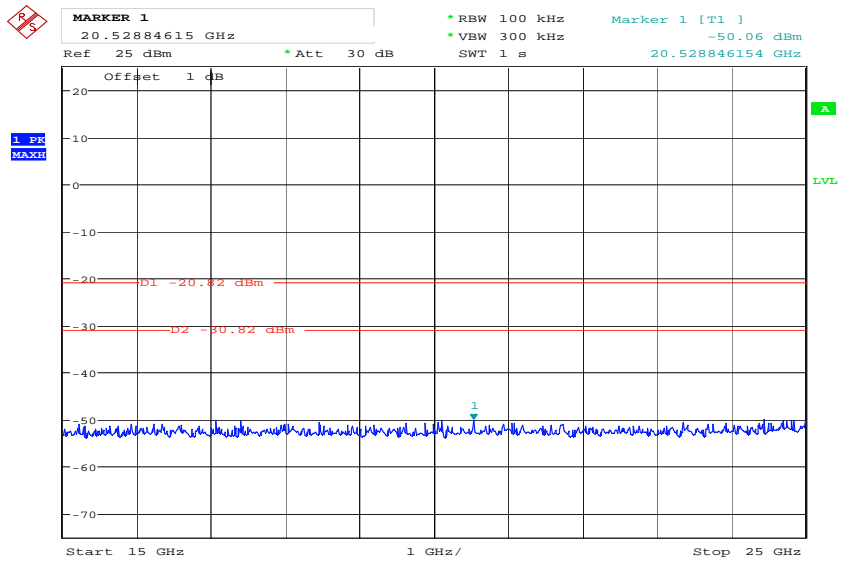

15GHz~25GHz

Test Mode: 802.11g Test channel : 11

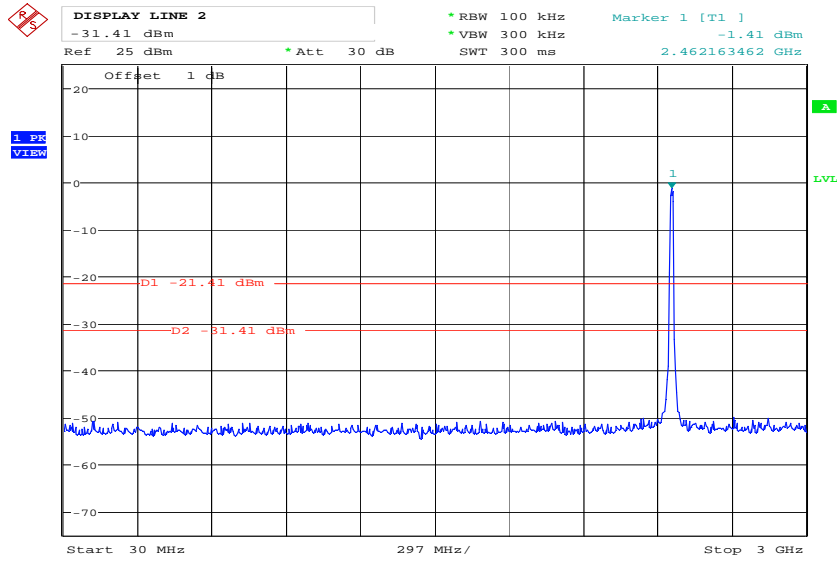

30MHz~3GHz

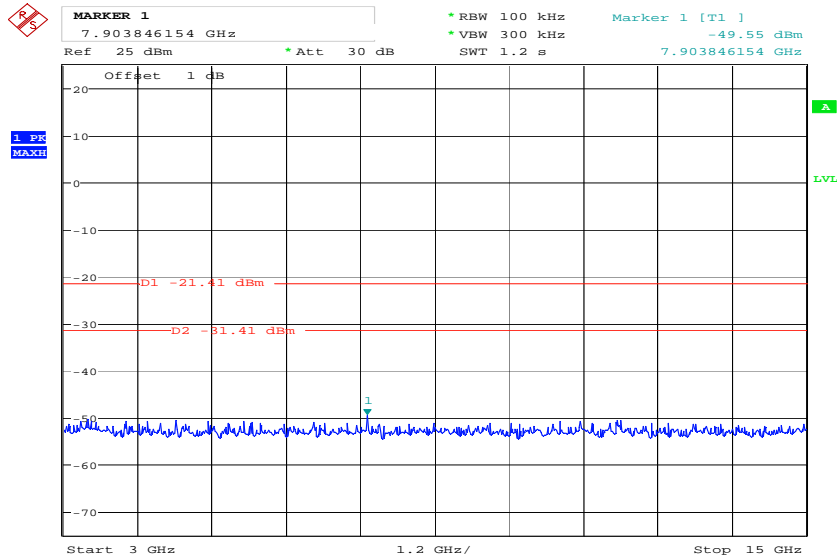

3GHz~15GHz

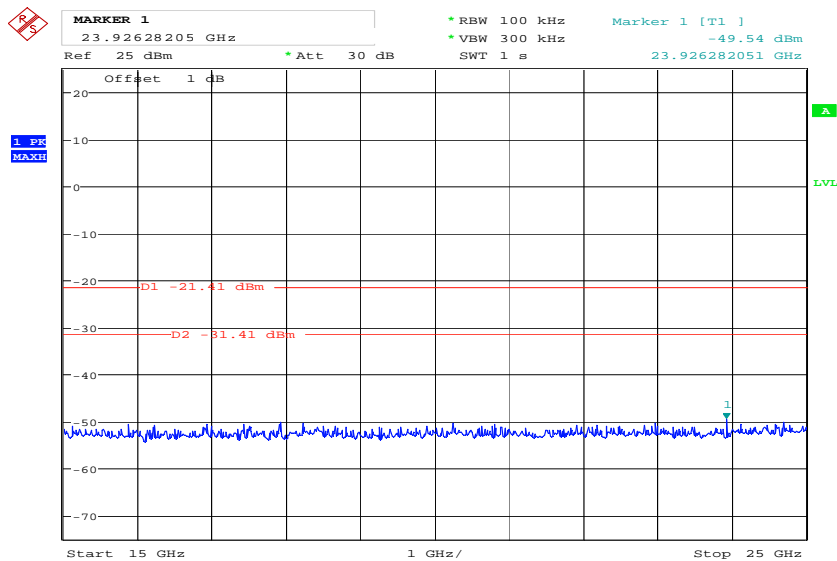

15GHz~25GHz

Test Mode: 802.11n(HT20) Test channel : 01

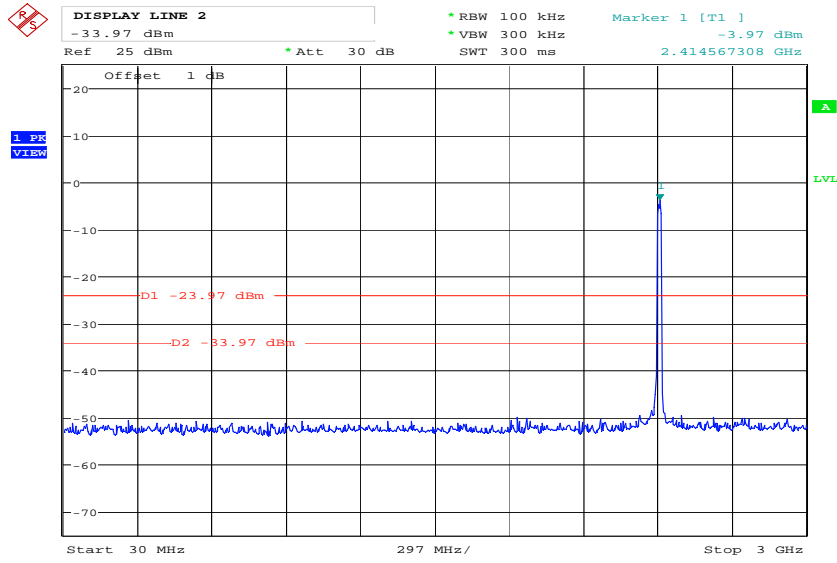

30MHz~3GHz

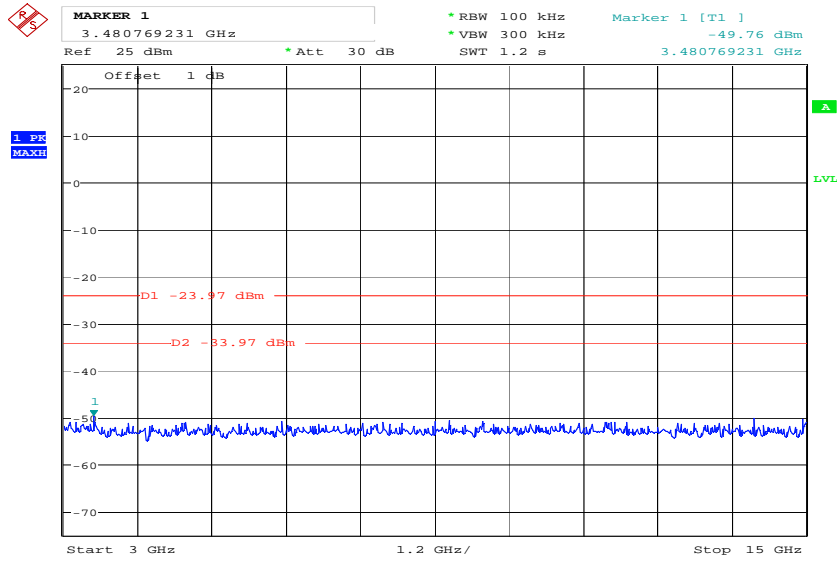

3GHz~15GHz

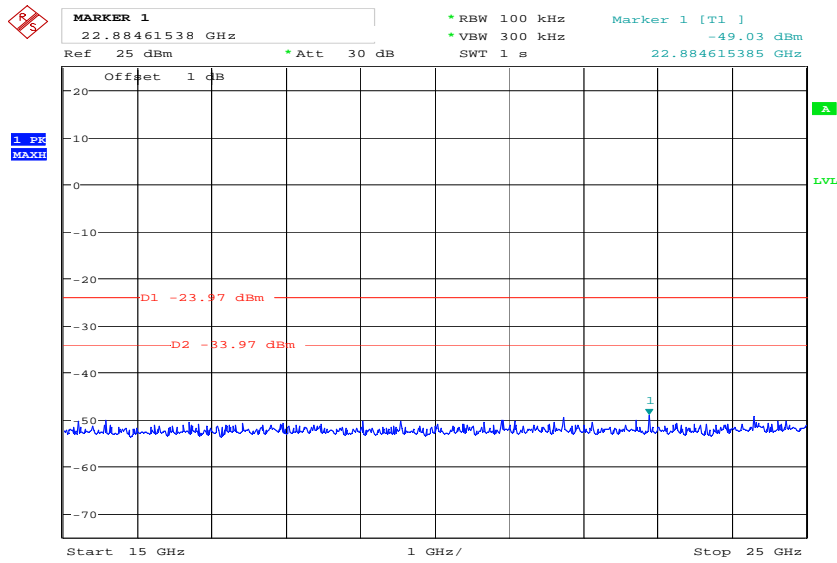

15GHz~25GHz

Test Mode: 802.11n(HT20) Test channel : 06

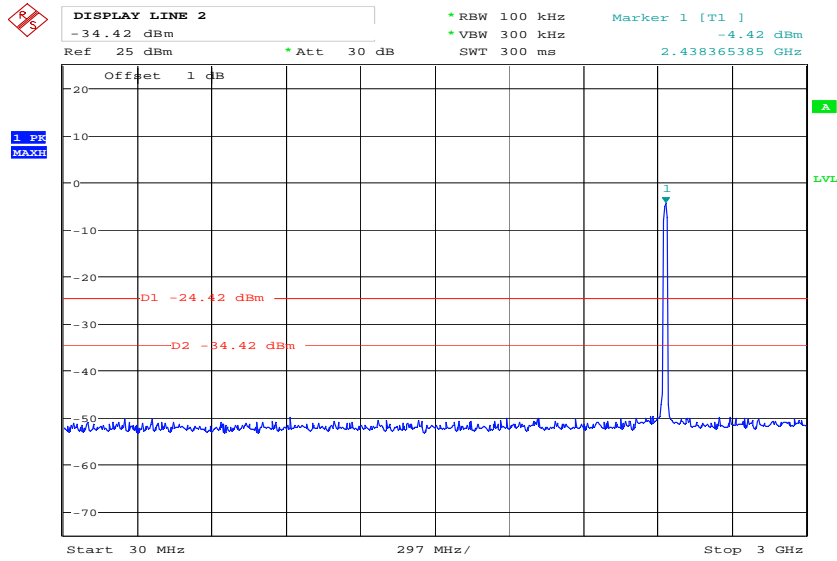

30MHz~3GHz

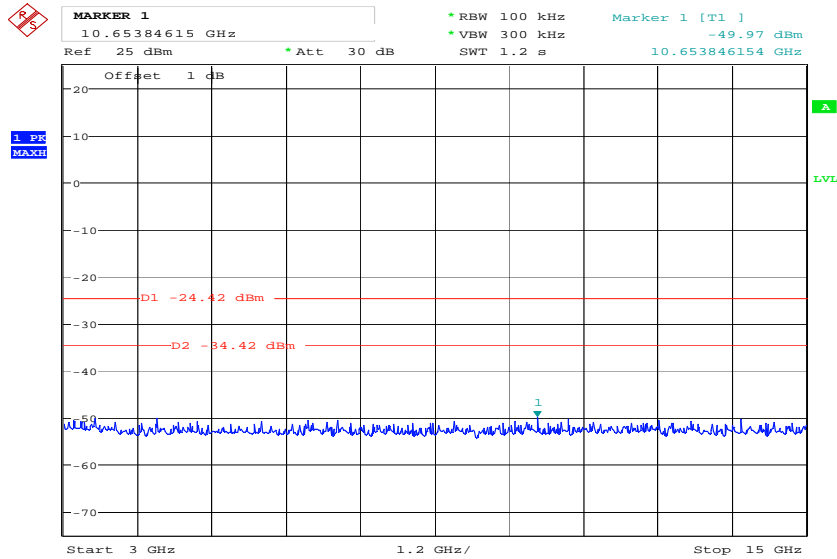

3GHz~15GHz

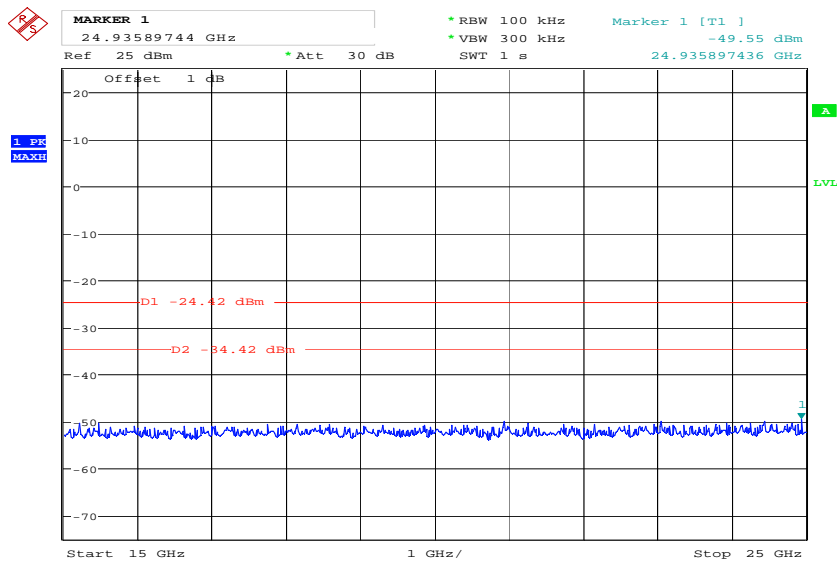

15GHz~25GHz



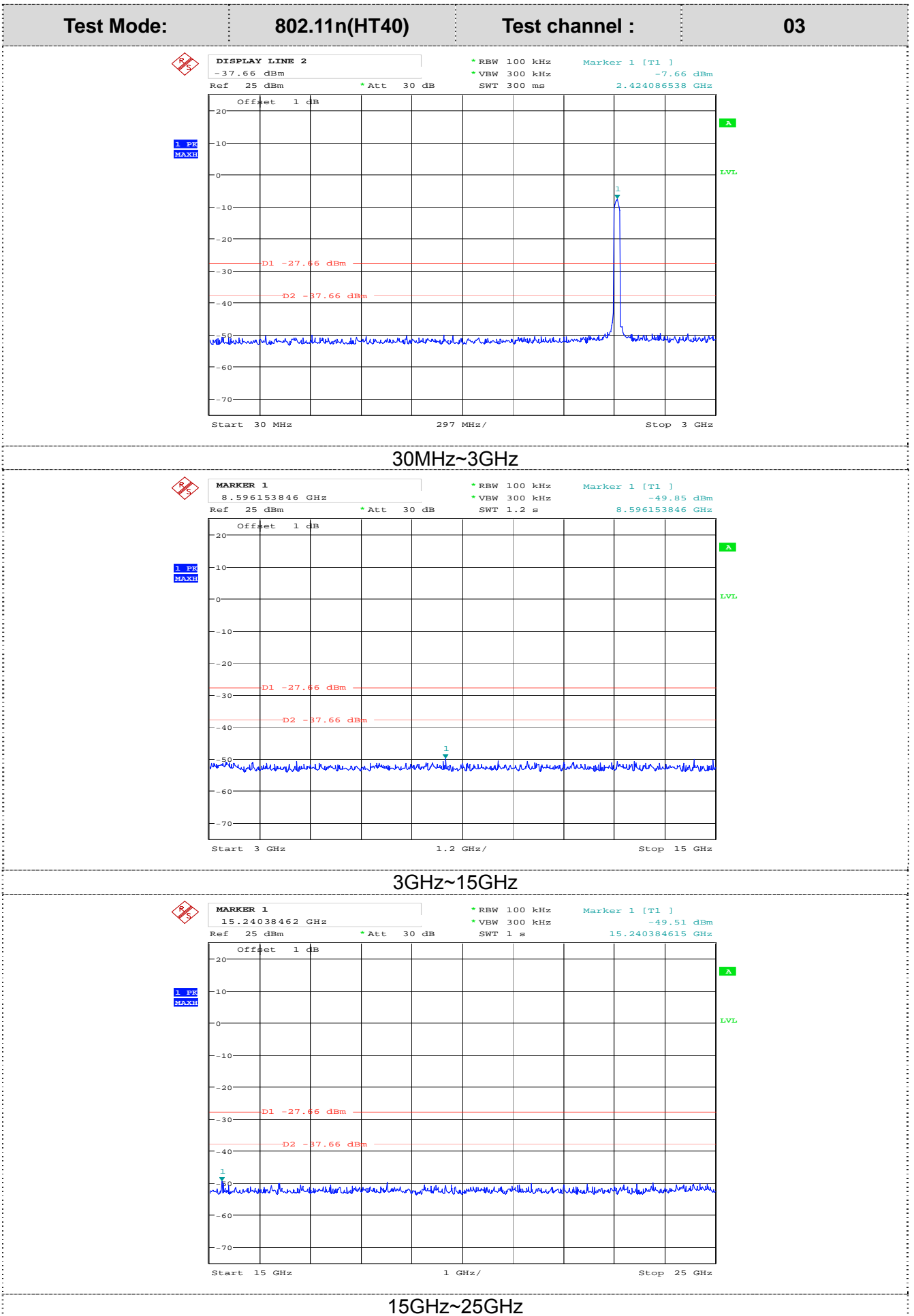

Test Mode: 802.11n(HT40) Test channel : 06

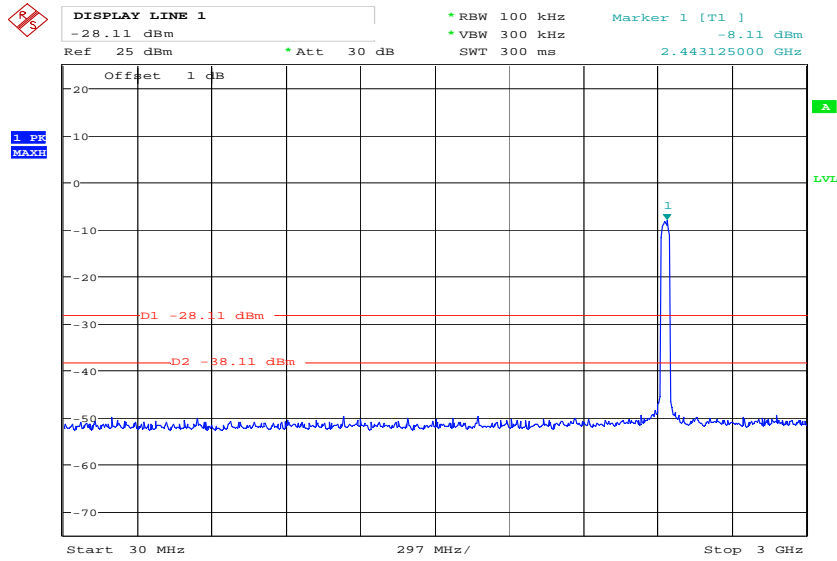

30MHz~3GHz

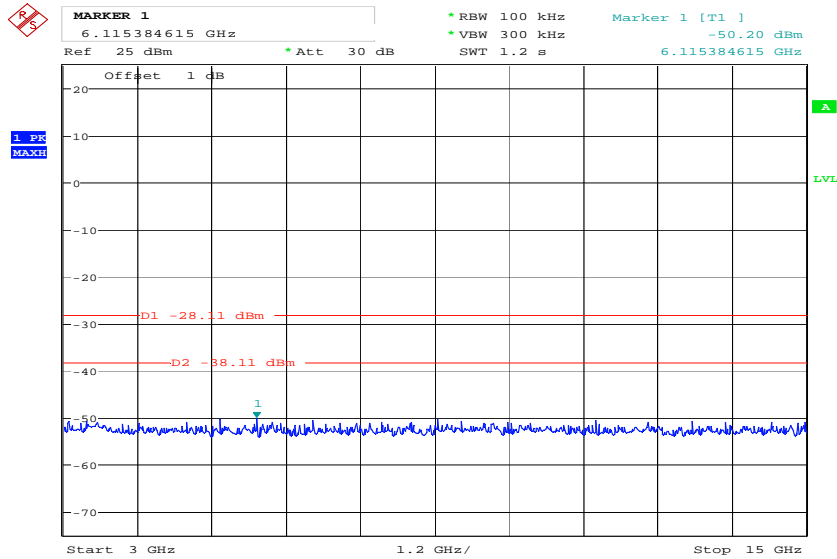

3GHz~15GHz

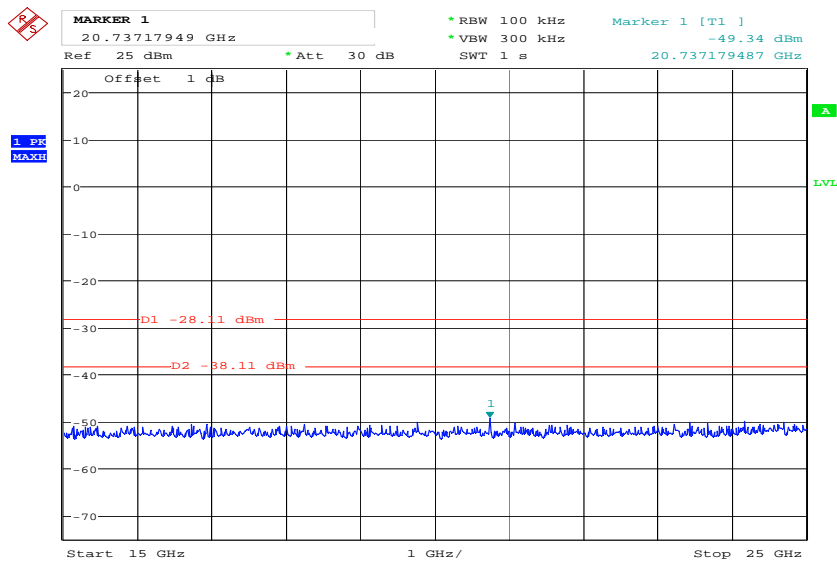

15GHz~25GHz

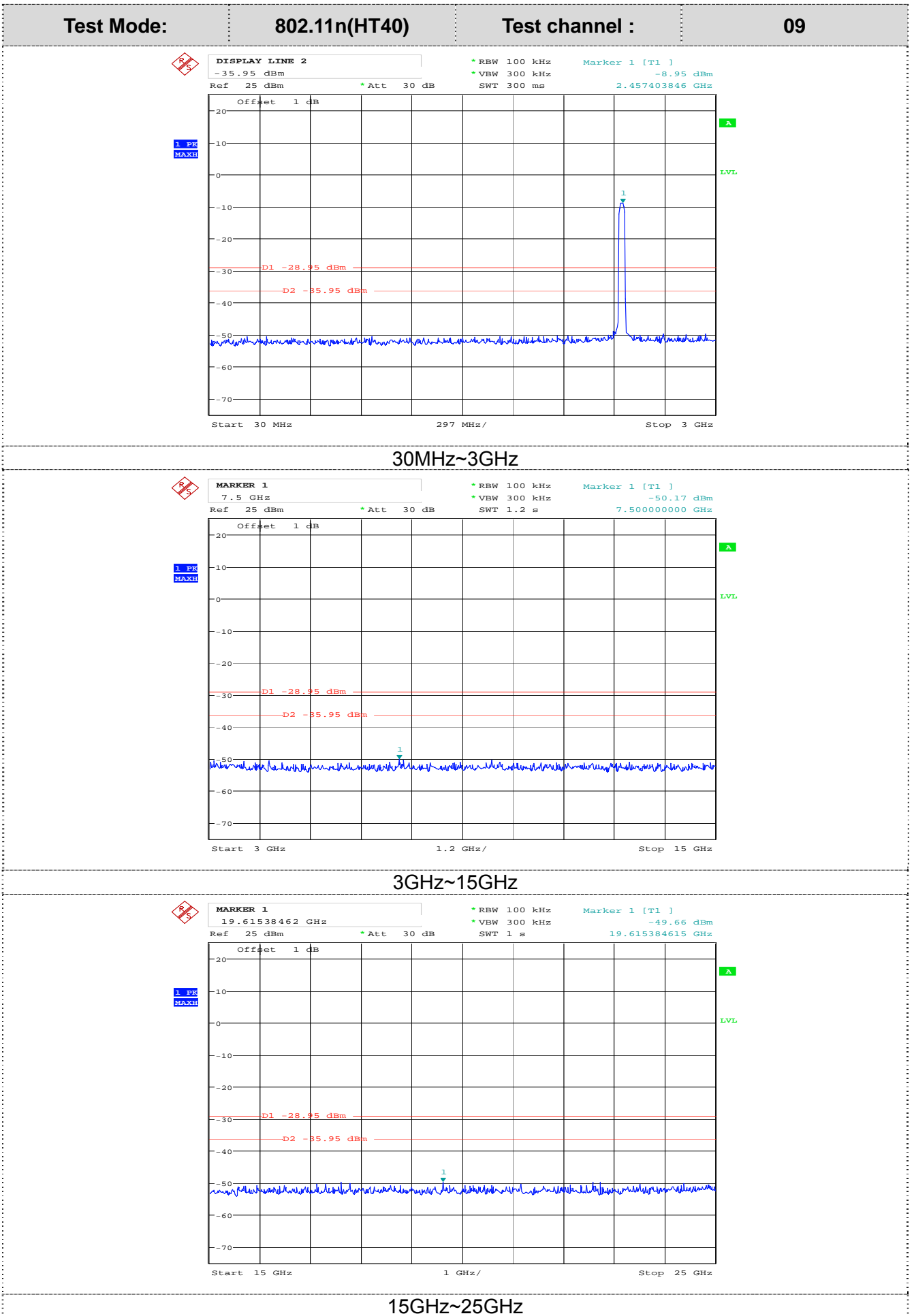



Test Mode: BT4.0 Test channel : 00

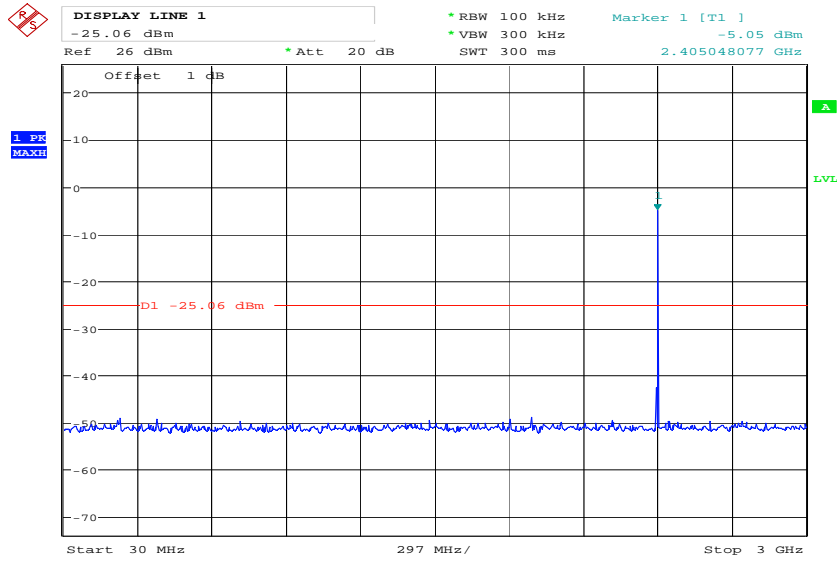

30MHz~3GHz

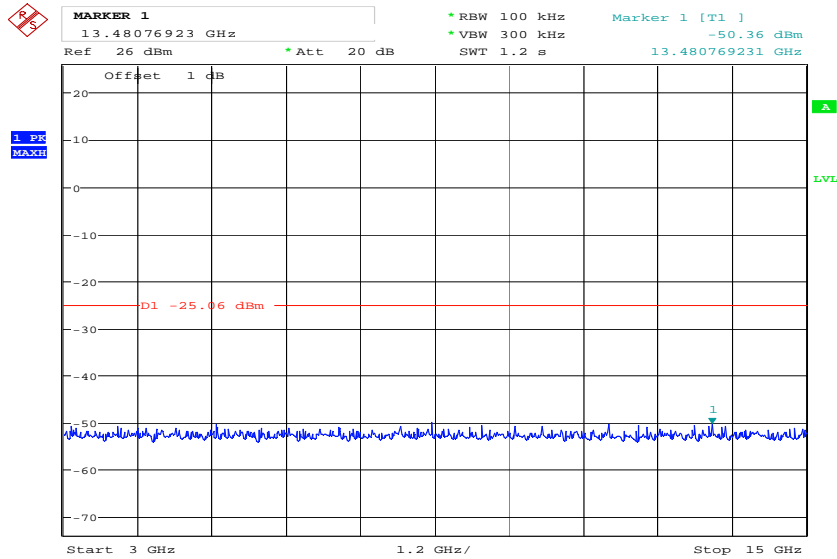

3GHz~15GHz

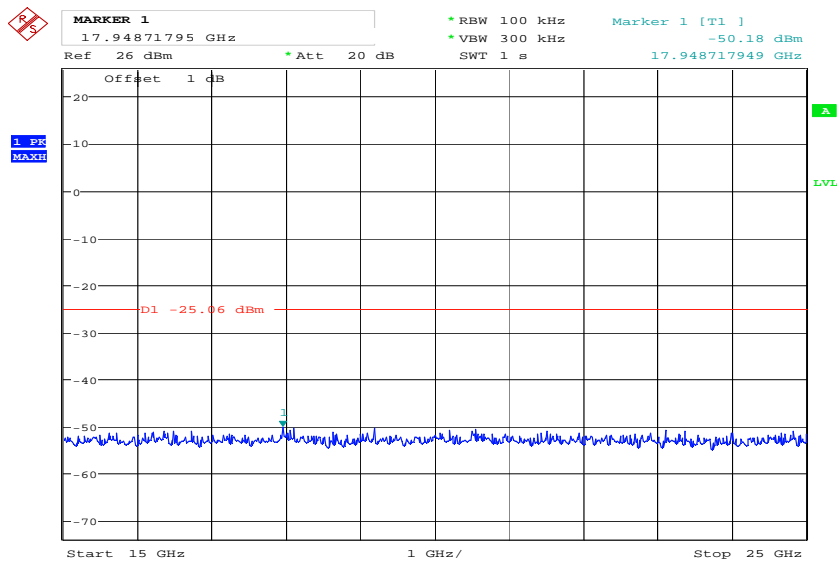

15GHz~25GHz

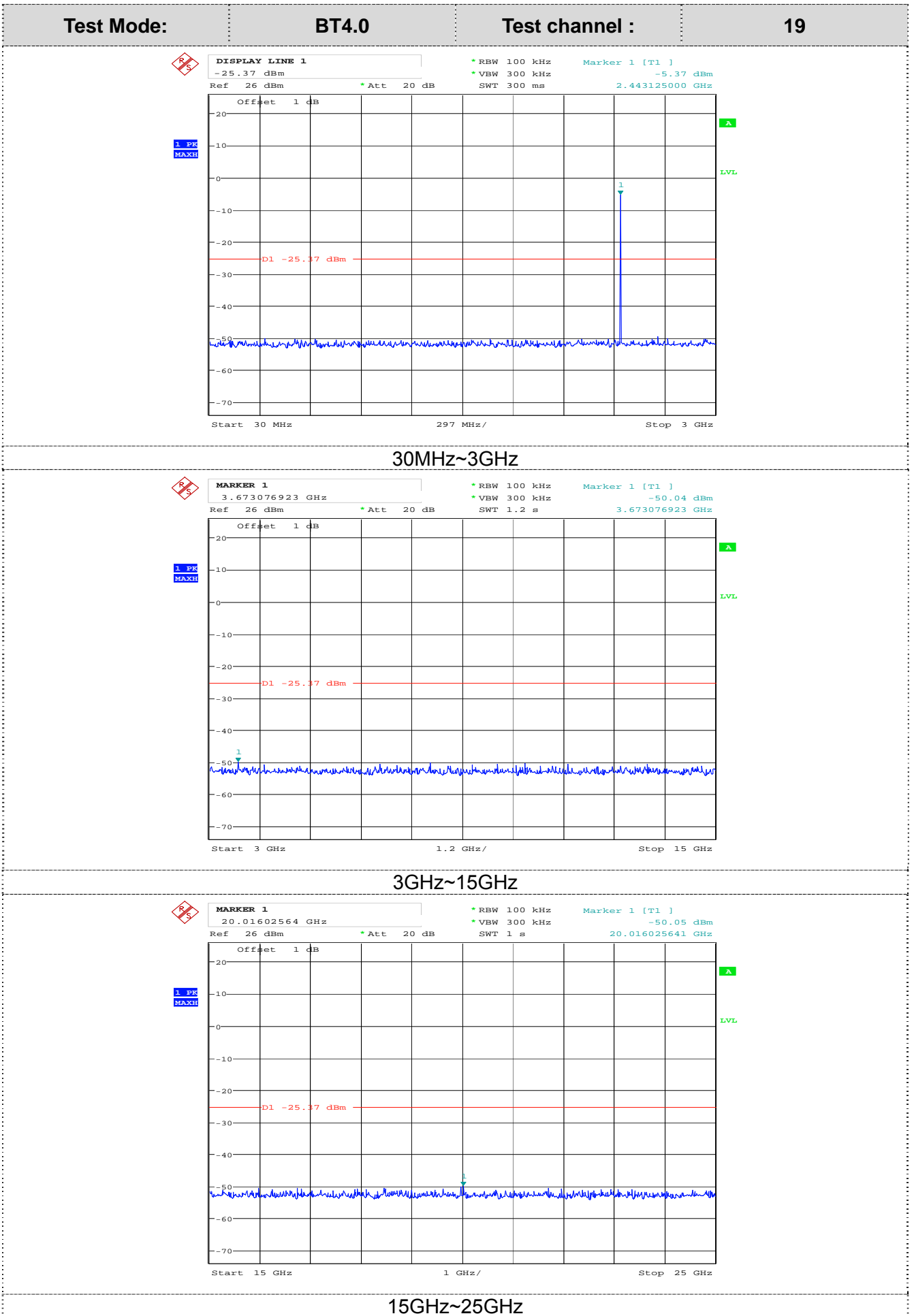

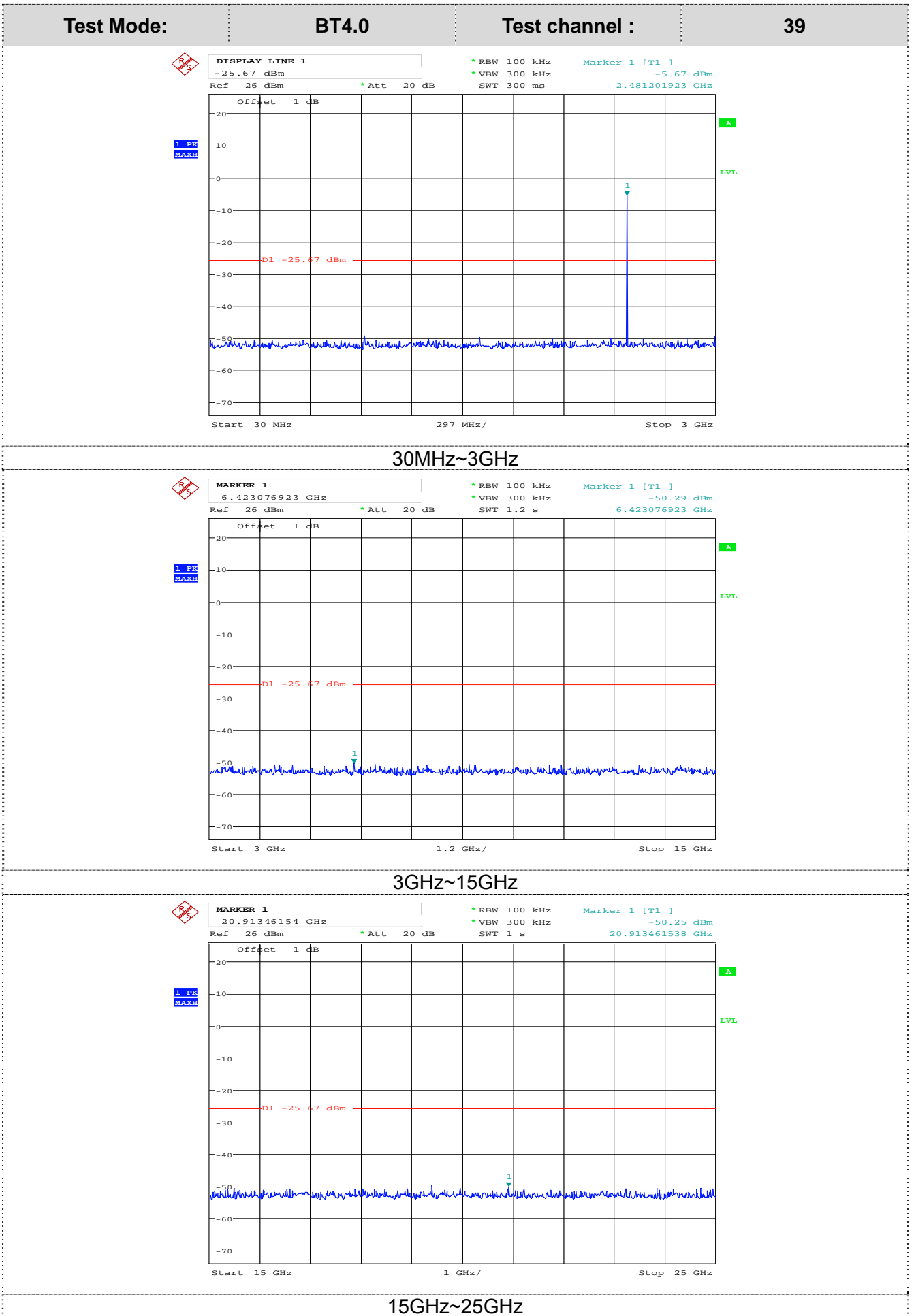

### 3.8. Antenna Requirement

#### Standard Applicable

For intentional device, according to FCC 47 CFR Section 15.203:

An intentional radiator shall be designed to ensure that no antenna other than that furnished by the responsible party shall be used with the device. The use of a permanently attached antenna or of an antenna that uses a unique coupling to the intentional radiator, the manufacturer may design the unit so that a broken antenna can be replaced by the user, but the use of a standard antenna jack or electrical connector is prohibited

#### **FCC CFR Title 47 Part 15 Subpart C Section 15.247(c) (1) (I):**

(i) Systems operating in the 2400-2483.5 MHz band that is used exclusively for fixed. Point-to-point operations may employ transmitting antennas with directional gain greater than 6dBi provided the maximum conducted output power of the intentional radiator is reduced by 1 dB for every 3 dB that the directional gain of the antenna exceeds 6dBi.

#### **Test Result:**

The maximum gain of WIFI/BT antenna was -1.5dBi.

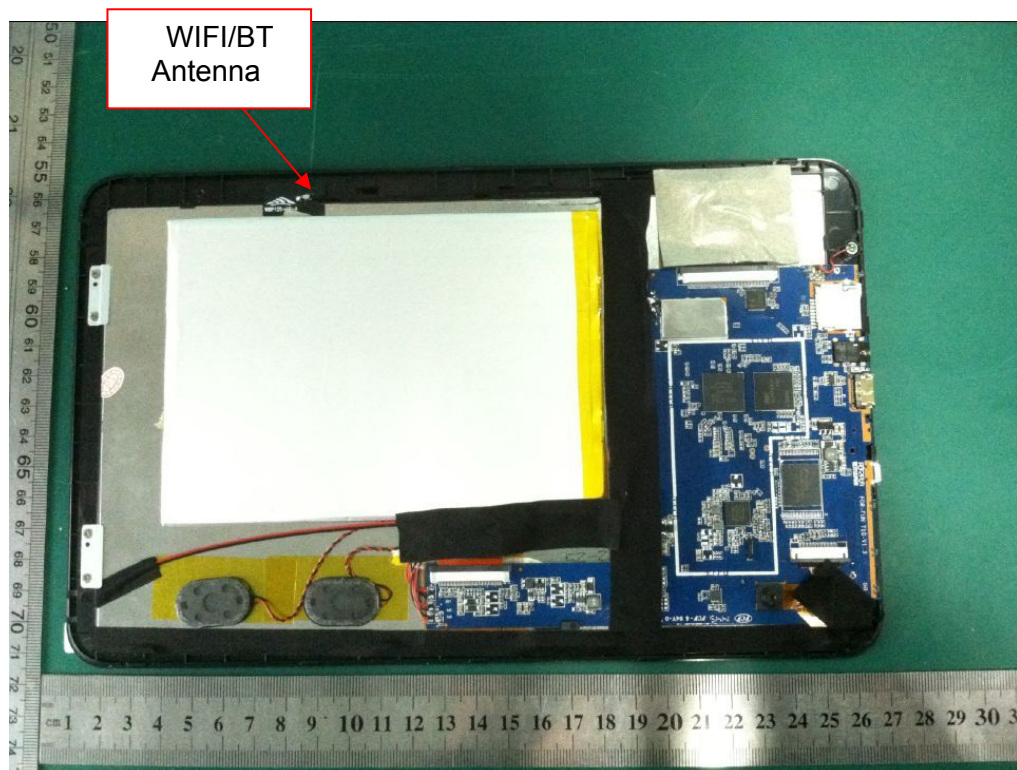

## 4. EUT TEST PHOTO

Radiated Emission (30MHz-1GHz)



Radiated Emission (1GHz-25GHz)

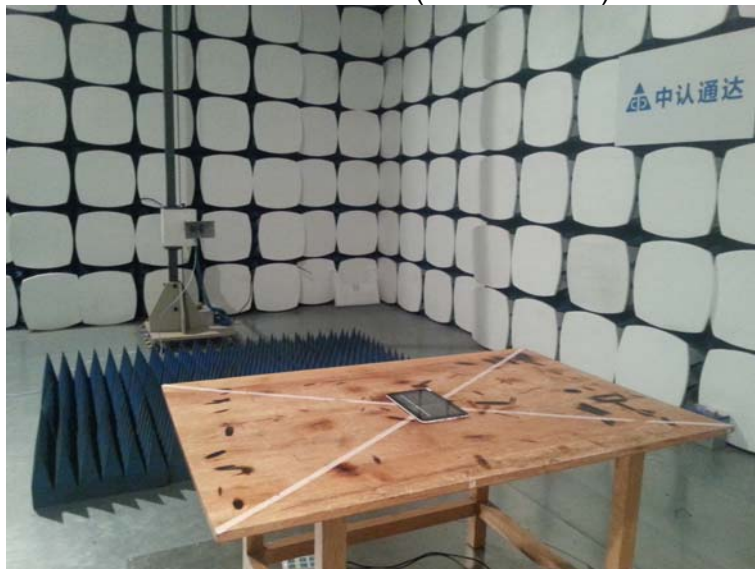

Conducted Emission





## 5. PHOTOGRAPHS OF EUT CONSTRUCTIONAL

### External photos of EUT





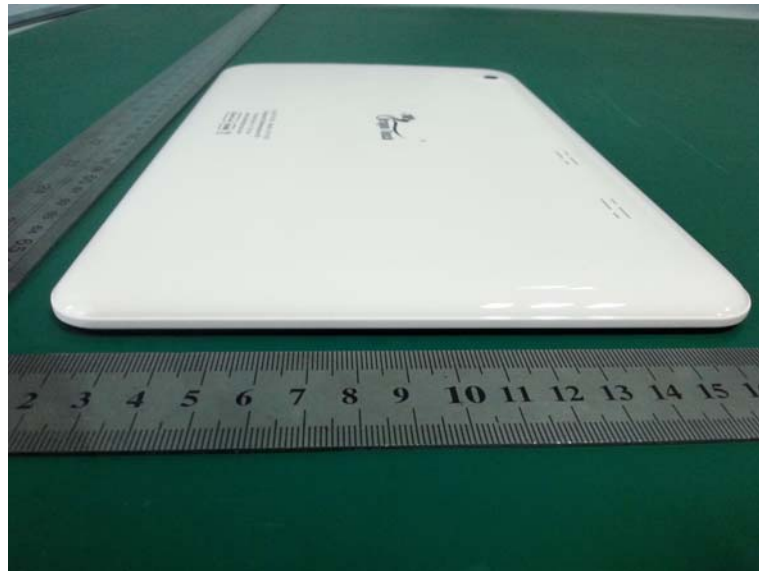



### Internal photos of EUT

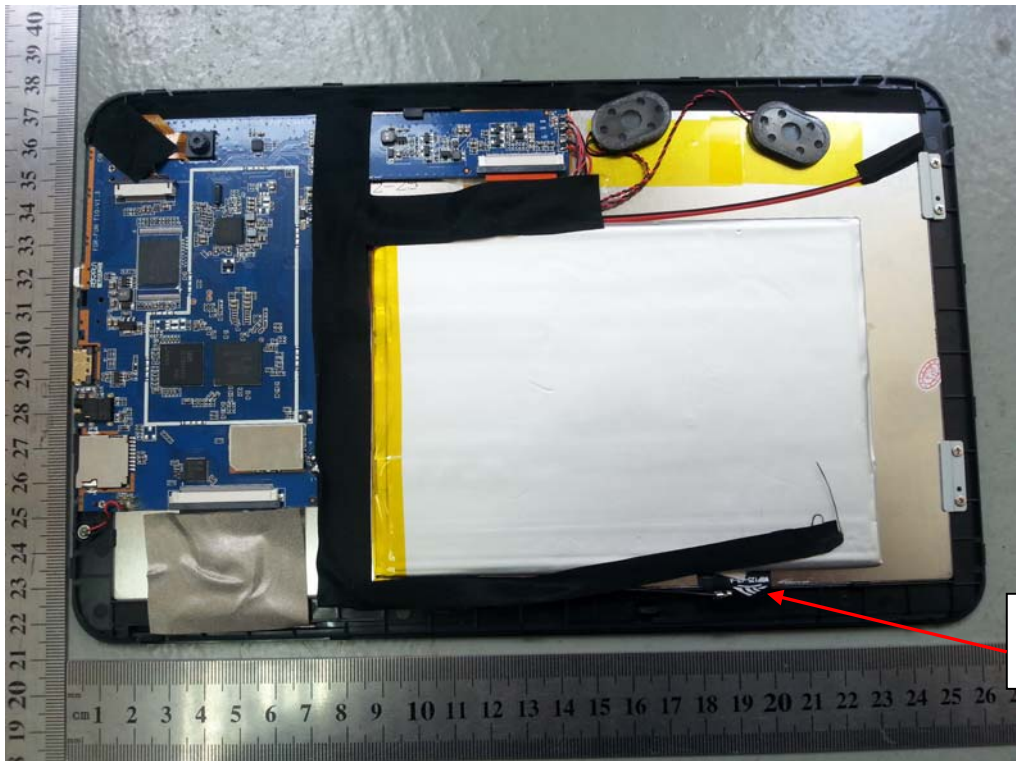

WiFi/BT  
Antenna

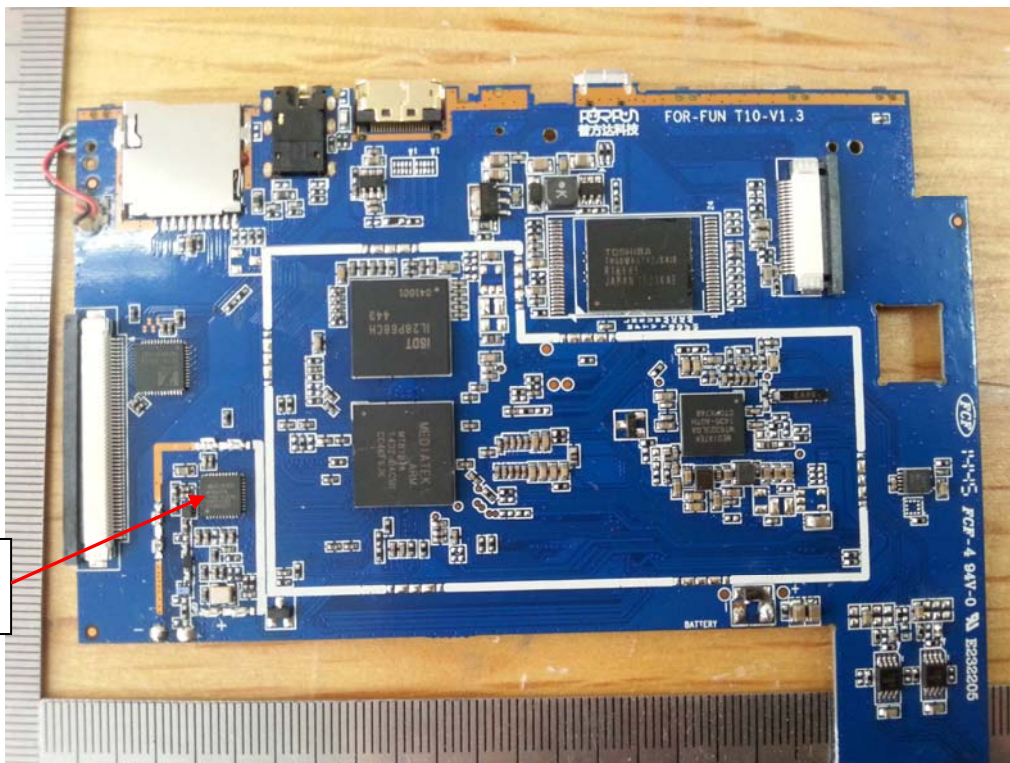
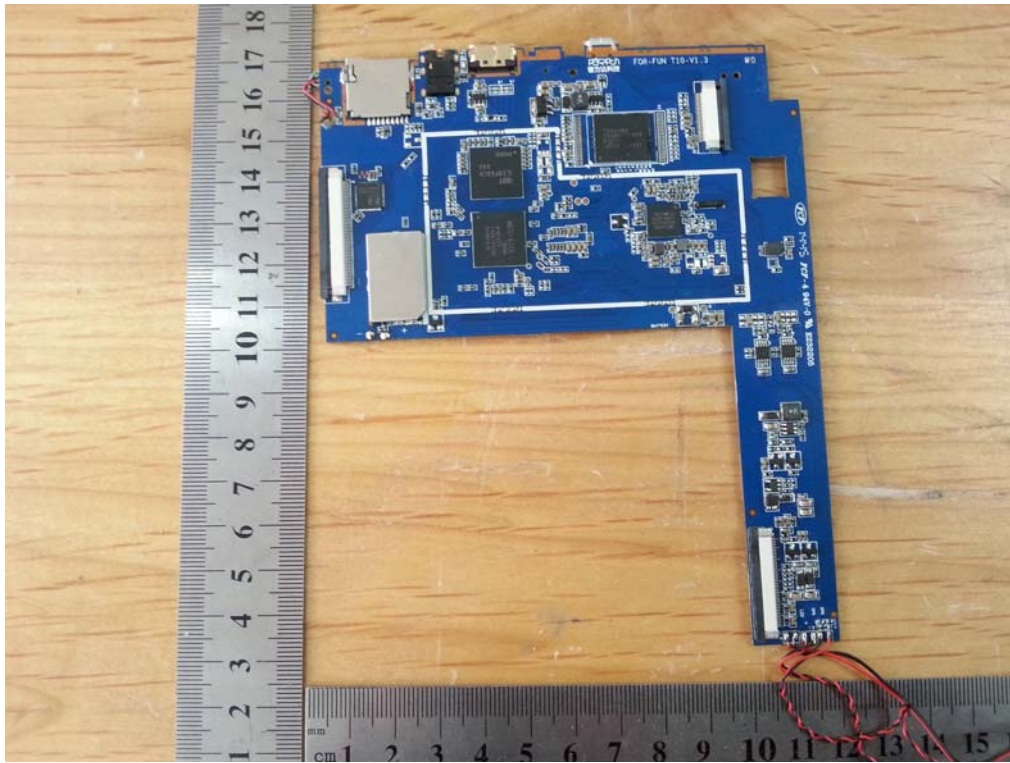

WIFI/BT  
Chip



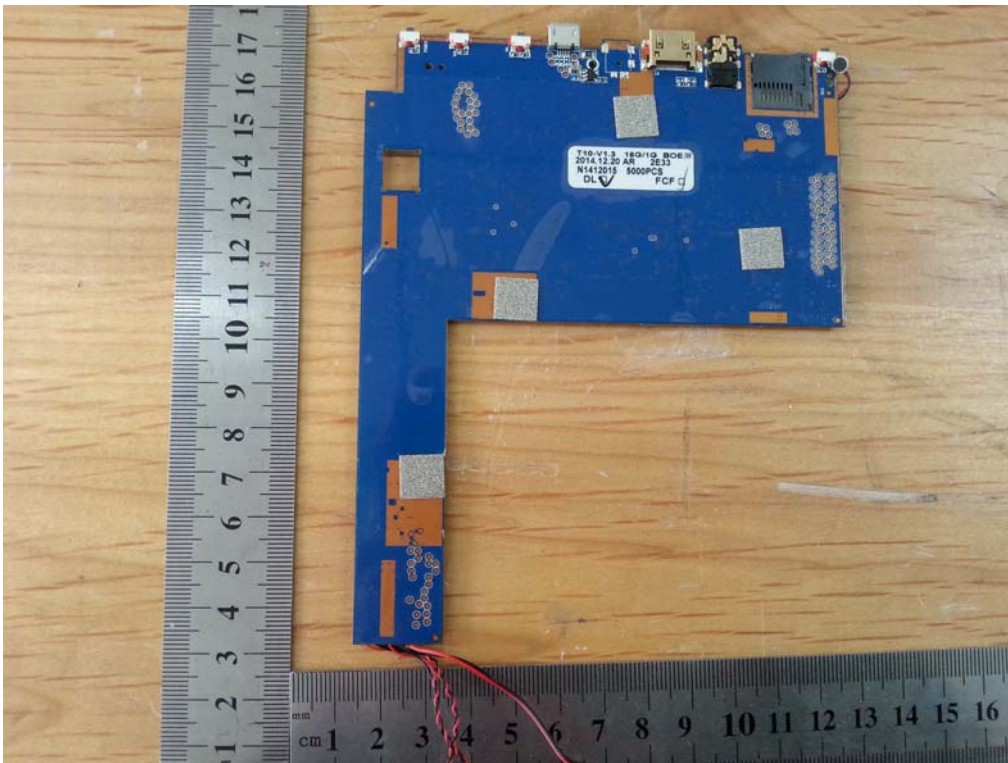
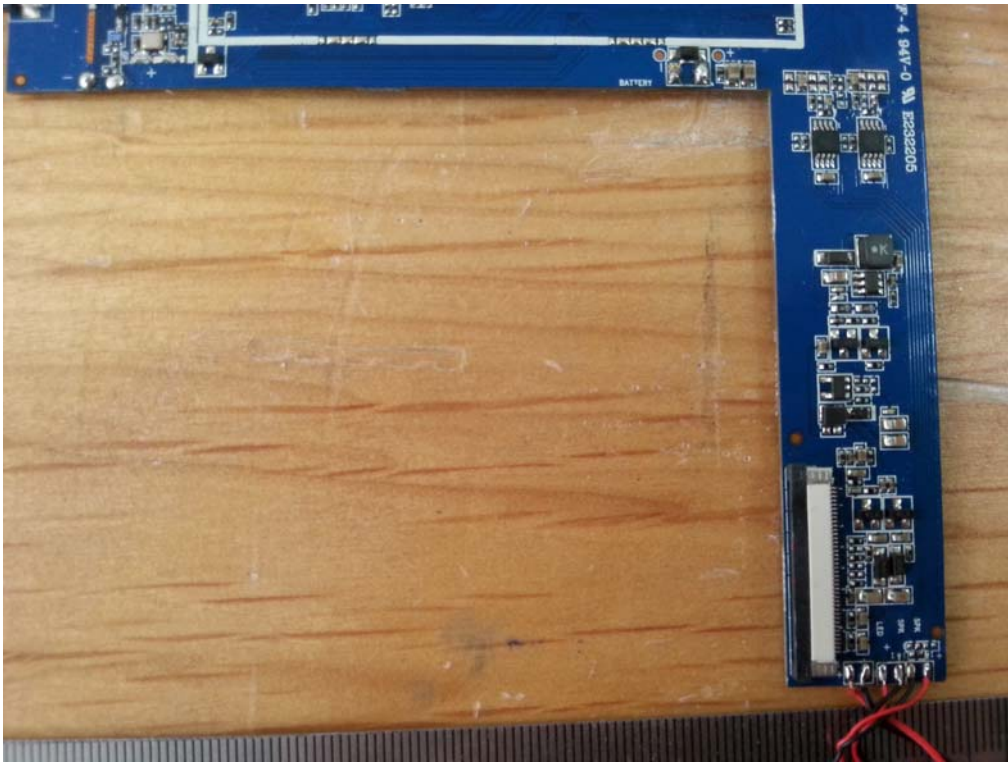

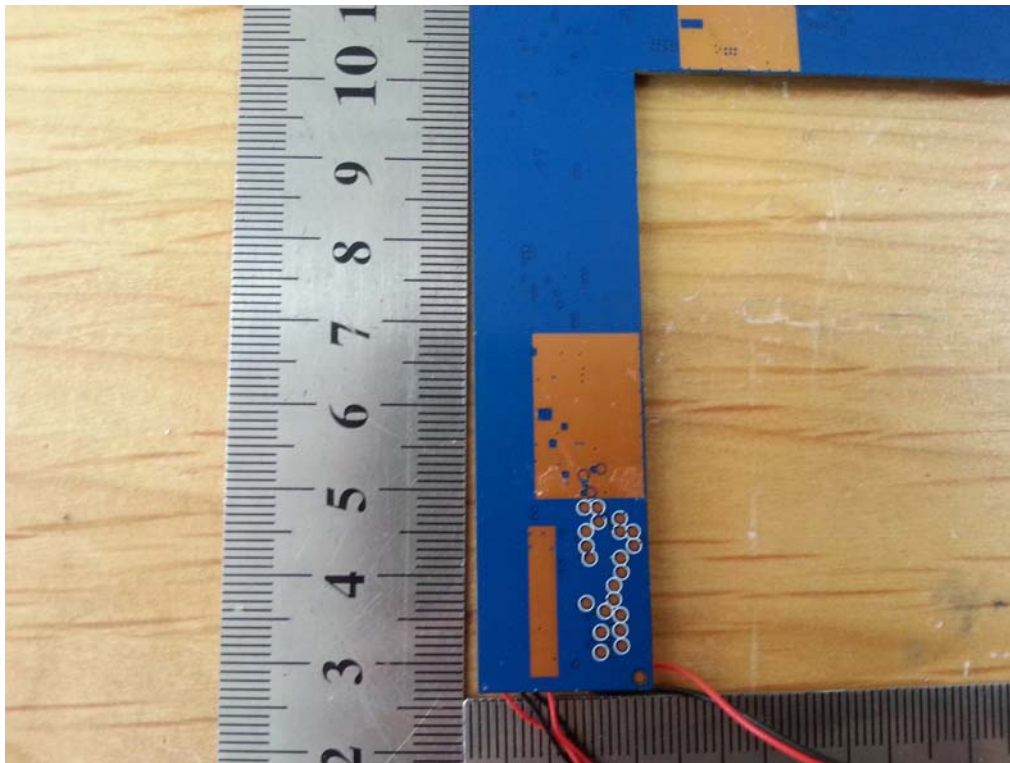
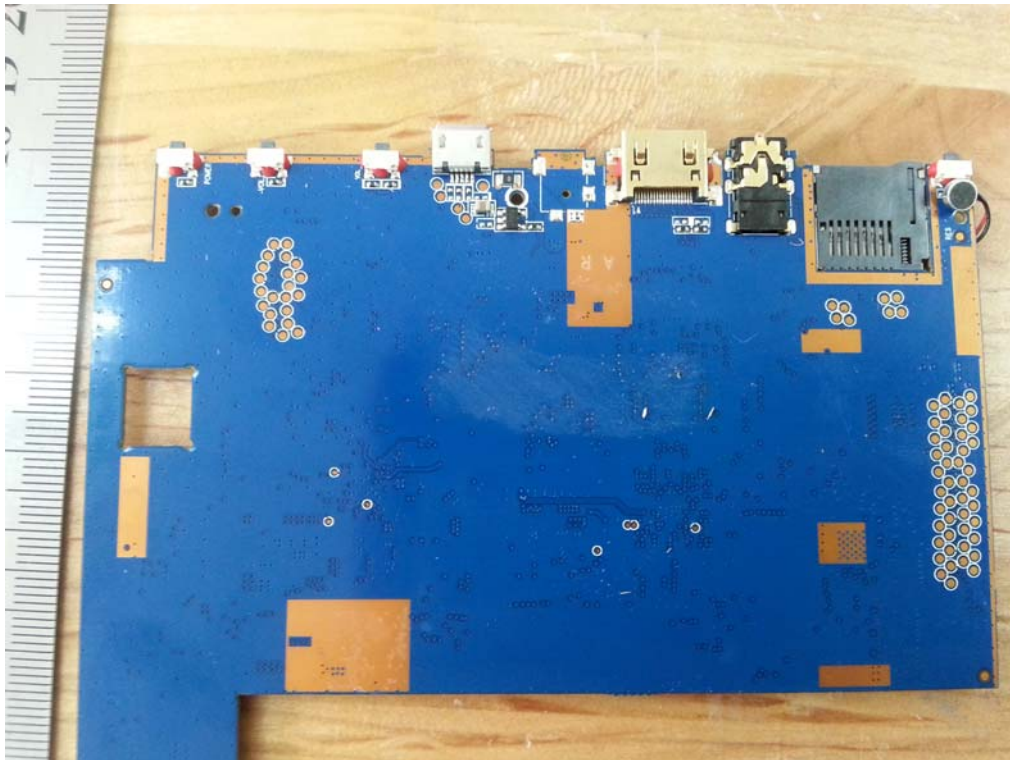







\*\*\*\*\*THE END\*\*\*\*\*