

IMPORTANT SAFETY INSTRUCTIONS

- Do not use this apparatus near water.
- Do not place near any heat sources such as radiators, heat registers, stoves, or other apparatus (including amplifiers) that produce heat.
- Only use attachments/accessories specified by the manufacturer.
- Apparatus shall not be exposed to dripping or splashing and no objects filled with liquids, such as vase, shall be placed on the apparatus.
- The batteries (battery pack & batteries installed) shall not be exposed to excessive heat such as sunshine, fire or the like.
- Do not place any naked flame sources, such as lighted candles, on the apparatus.
- The battery used in this product must be properly recycled or disposed of. Please contact your local recycling center for proper battery handling and disposal instructions.
Please charge your unit when it is:
 - The battery icon indicates the power is lower.
 - The unit shuts off suddenly, even if restart again.
 - Tapping any button has no response.Please use the supplied AC power adaptor to charge the unit; otherwise, using other adaptors may damage your unit.
- When the player is formatting, uploading or downloading, do not disconnect the connection. It may cause program error if you do this.
- We are not responsible for the memory loss caused by product damage, repairmen or other reasons. Please operate strictly following these instructions.
- Clean only with dry cloth. Do not use aerosol cleaners, benzene, anti-static liquids or any other solvents for cleaning
- Refer all servicing to qualified service personnel.
- Turn off the unit or use airplane mode when use is prohibited, such as traveling in the aircraft.
- The supplied USB cable is used for data transmission only.
- Non-waterproof.

Illustrations contained within this user manual are for representation only and subject to change.

PRODUCT OVERVIEW

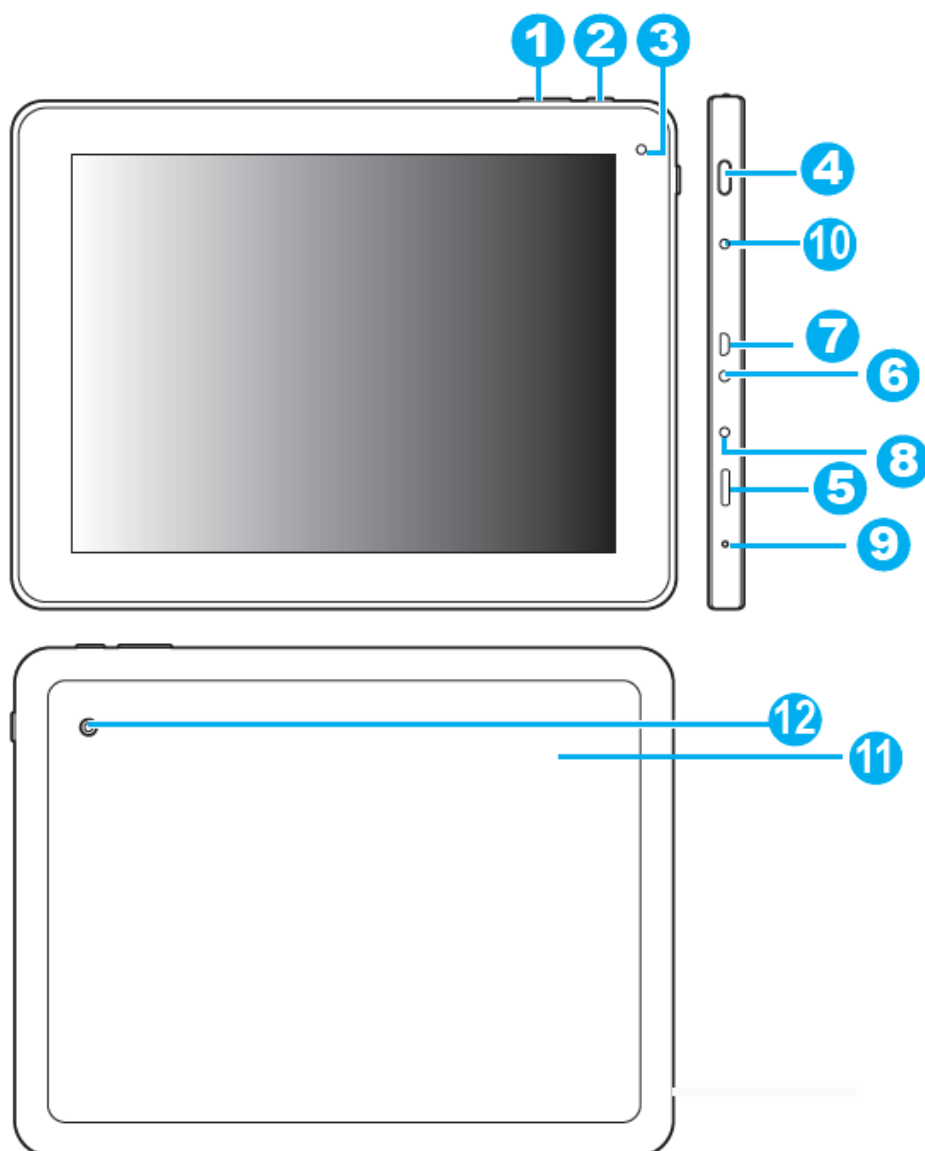

PRODUCT OVERVIEW

- 1 Volume+/- buttons**
Press to increase or decrease the volume level.
- 2 ↶ (Return) button**
Press to go back to the main screen.
- 3 Front camera**
Take a photo or record a video.
- 4 ⏻ (Power) button**
 - Press and hold to turn on/off the unit.
 - Press to wake up the screen.
 - Press to lock the screen.
- 5 TF card slot**
Insert a flash card to extend the memory.
- 6 Reset**
Reset the unit
- 7 🔌 Micro USB port**
Connect through USB cable to your PC for transferring data.
- 8 ⏻ (DC IN) jack**
Connect to AC adaptor for charging.
- 9 🎤 (Microphone)**
Uses for video conference, talking, and sound recording.
- 10 🎧 (Earphone) jack**
Outputs audio to earphone, speakers and amplifier.
- 11 Speakers**
Outputs high-definition sound.
- 12 Rear camera**
Take a photo or record a video.

CHARGING THE BATTERY

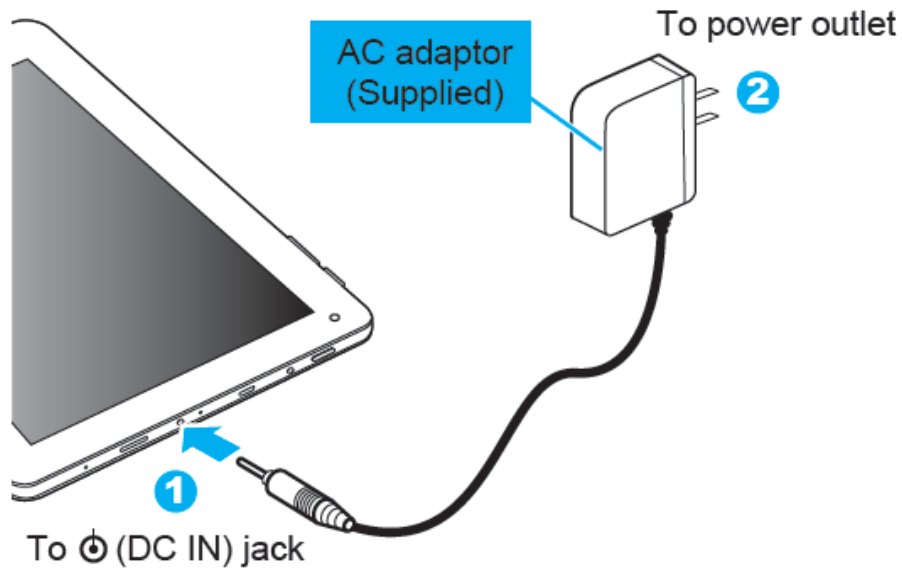

CAUTION!

Please charge the battery fully when use the unit at the first time.

Notes:

- Please charge only using the supplied AC power adaptor.
- Charge your unit at least for 10 hours at the initial two charges. After then you can charge just for 7 hours.

EXPLORING THE MAIN SCREEN

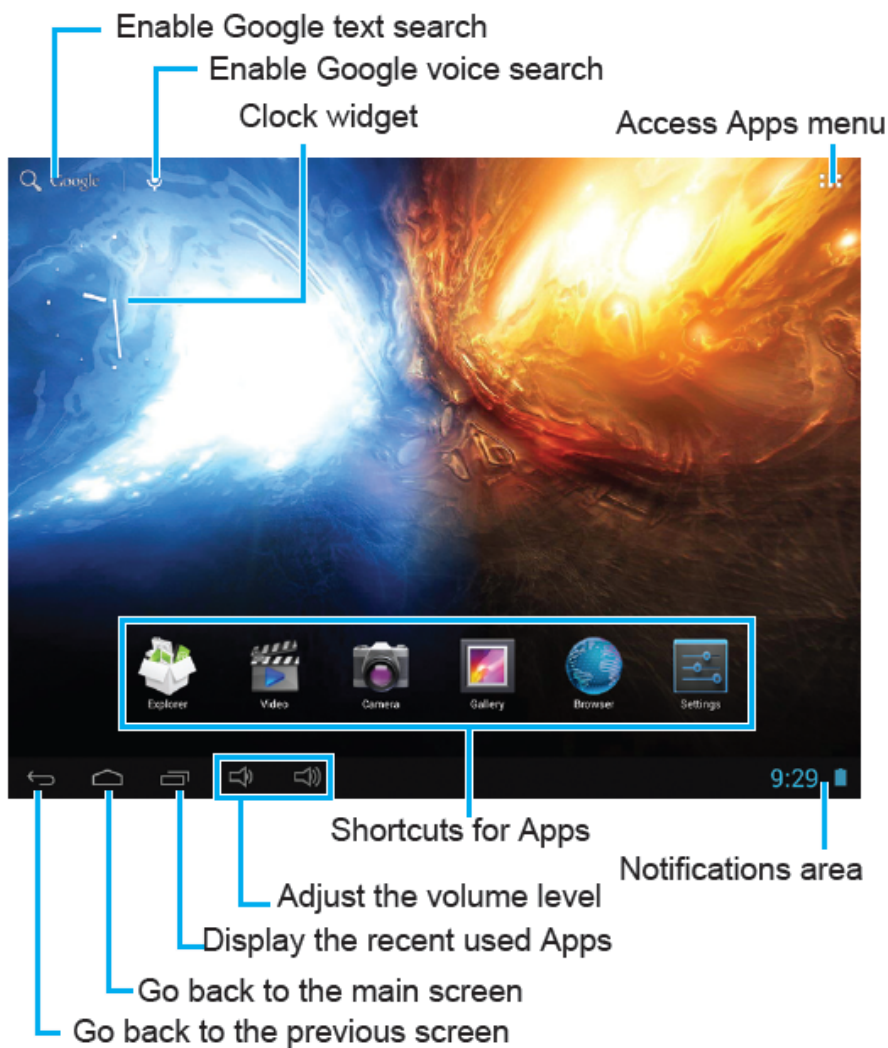

ANDROID APPS AND WIDGETS

Tap the  button on the main screen to enter the Apps menu.



Notes:

- Tap and hold an App or a widget, and drag it to a desired screen.
- Tap and hold an App or a widget on the main screen until **X** appears, then drag it to touch the **X** to remove from the screen.

NOTIFICATIONS PANEL



Note:

- After operating, tap any other area on the screen to turn off the Notifications panel.

BASIC OPERATION

OPERATING ACTIONS

- Tap:** Tap an item or App once to select the item or launch the App.
- Long-tap:** Tap and hold the current operating interface or area until the relevant items appear, then release.
- Slide:** Slide up/down/left/right to switch between different screens conveniently.
- Drag:** Tap and hold an icon on the desktop and drag to other position.
- Pinch & Spread:** Use two fingers to tap the screen, and adjust the distance between them to zoom in/out the current photo or web contents.

INFORMATION INPUT

When you need to input texts, tap the text input box, the keyboard will appear automatically. After input, tap the ✓ button to close the keyboard.

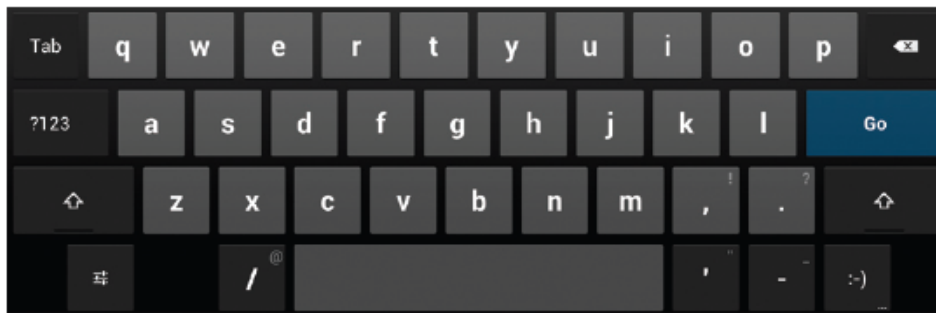

CONNECTIONS

CONNECTING TO PC

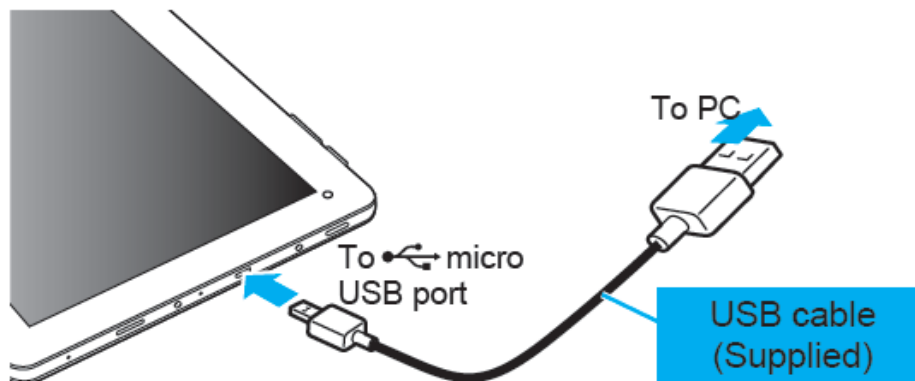

WARNING!

- When connecting to PC, please follow the computer prompts strictly to avoid any data loss.
- Do not disconnect the USB connection during data transferring; otherwise it will cause data damage or loss.

1 Connect the one end of the USB cable (supplied) to the unit, and the other end of the USB cable (supplied) to your PC.

2 Tap **Turn on USB storage** to transfer files.

CONNECTIONS

CONNECTING TO EARPHONE

You can connect an earphone to the earphone jack for personal listening.

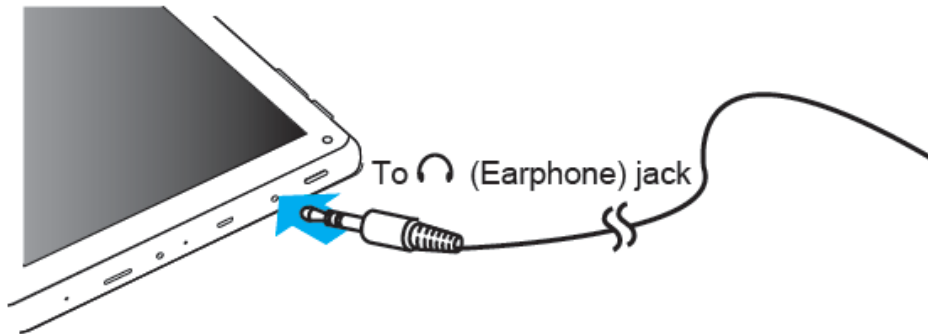

For protecting your hearing, always turn the volume down before plugging the earphones and use only the minimum volume setting necessary to hear your conversation or music.

MUSIC

Tap the  in the Apps menu to listen to your favorite music with the music player.

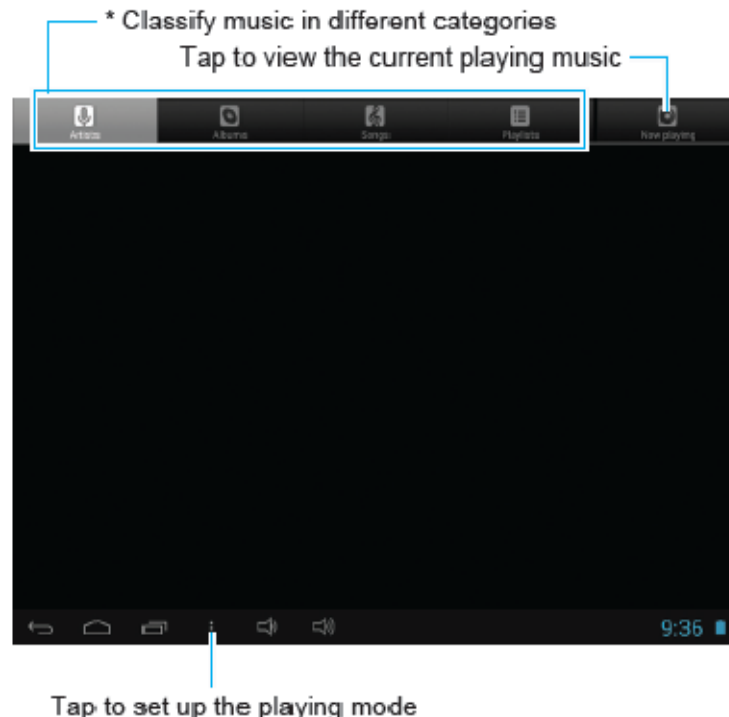

** You can use these categories to find your preferred music conveniently.*

GALLERY

Tap the  on the main screen or in the Apps menu to view photos and videos stored in your unit or TF flash card.

Classify photo and video files in different categories

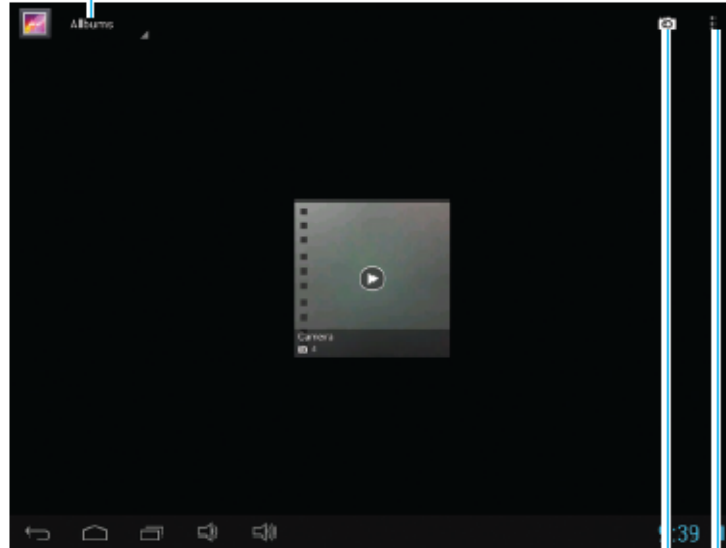

Tap to turn on the camera

Tap to select files, set file to make available offline, and refresh the Gallery

Note:

- You can choose to view a photo, and use the toolbar on the upper-right corner to share, delete, edit it, and view its detailed information.

CAMERA

Tap the  on the main screen or in the Apps menu to take photos or record using the camera. The photos and videos will be stored into the Gallery automatically.

Tap to switch between front camera and rear camera

Tap to take photo or start recording

Slide to adjust the focus

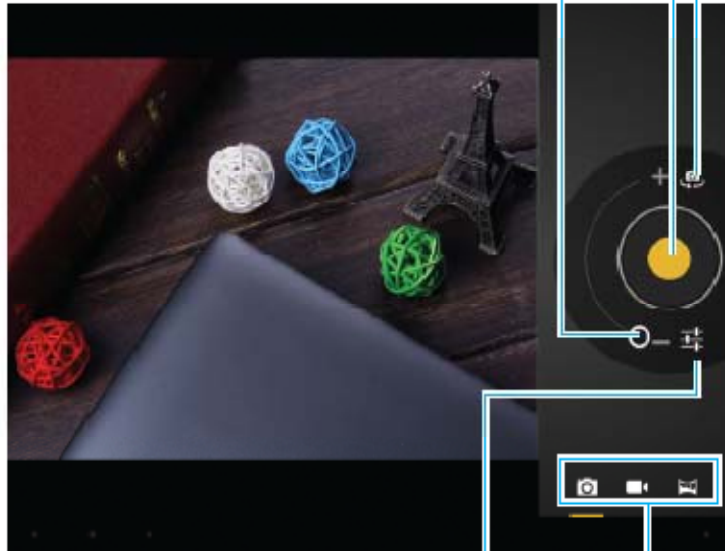

Tap to customize the camera settings

Tap to select among taking photos, recording videos, and capturing panorama

Wi-Fi CONNECTION

Before creating the Wi-Fi connection, please ensure that your WLAN network has been configured correctly.

- 1 Tap the  on the main screen or in the Apps menu to enter the settings menu.
- 2 Tap to select Wi-Fi item and switch it to **ON**. The unit will scan the available networks automatically.
- 3 Tap the desired network, and input the password if necessary. Then tap **Connect**.

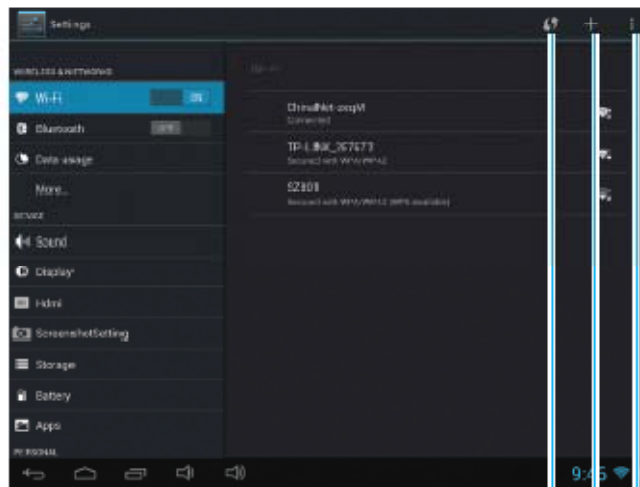

Tap to activate WLAN protected setup

Tap to add a network with Network SSID

Tap to view more information about Wi-Fi

ANDROID MARKET

You can use your Google account to download various Apps from the Android Market. Set up your own account first to access the Android Market.

- 1 Tap the  in the Apps menu.
- 2 Add a Google account to the unit.

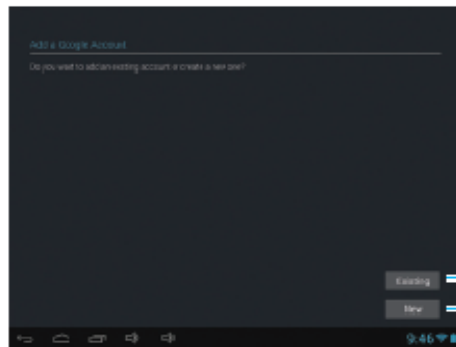

Tap to sign in if you have an account before

Tap to create a new account

- 3 After signing in, you can download your desired Apps from the Android Market.

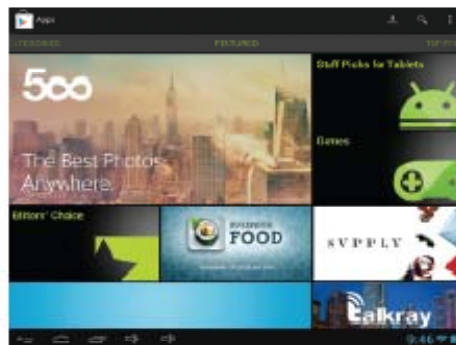

Tip:
Because some Apps are not free, you need to pay for them via your credit card for downloading.

SETTINGS

In the Settings menu, you can configure the unit, set app options, add accounts, and set other preferences.

- 1 Tap the  on the main screen or in the Apps menu to enter the settings menu.



- 2 Tap and select an option and configure it according to the screen prompts.

TROUBLESHOOTING

Check this list for a possible troubleshooting solution.

Cannot power on

- Check the battery power if it is too low.
- Connect the adaptor and power on again.

After powering on, the screen starts blinking and power off suddenly

- Battery power is low, please charge in time.

No sound output

- Check the volume setting, and adjust the volume level by tapping Volume+/- buttons.
- Check if the audio file is damaged; try to choose another audio to play.

Cannot copy files or play audio files

- Check if the connection is available.
- Check if the unit has enough storage memory.

System has errors

- Power off the unit and then power on again by holding and pressing the  (Power) button.
 - Restore the system to factory default.
-

FCC Statement

This equipment has been tested and found to comply with the limits for a Class B digital device, pursuant to part 15 of FCC Rules. These limits are designed to provide reasonable protection against harmful interference in a residential installation. This equipment generates and can radiate radio frequency energy and, if not installed and used in accordance with the instructions, may cause harmful interference to radio communications. However, there is no guarantee that interference will not occur in a particular installation. If this equipment does cause harmful interference to radio or television reception, which can be determined by turning the equipment off and on, the user is encouraged to try to correct the interference by one or more of the following measures:

- Reorient or relocate the receiving antenna.
- Increase the separation between the equipment and receiver.
- Connect the equipment into an outlet on a circuit different from that to which the receiver is connected.
- Consult the dealer or an experienced radio/TV technician for help.

This device complies with Part 15 of FCC Rules. Operation is subject to the following two conditions: (1) This device may not cause harmful interference, and (2) This device must accept any interference received, including interference that may cause undesired operation.

Note: The manufacturer is not responsible for any radio or TV interference caused by unauthorized modifications to this equipment. Such modifications could void the user's authority to operate this equipment.

Any changes or modifications not expressly approved by the party responsible for compliance could void the user's authority to operate the equipment.

SAR Statement

This device is measured RF output power is less than the SAR exclusion threshold value for human head and body . Therefore, SAR test is not necessary.



User Manual



Please read all instructions carefully before use and keep for future reference.

The design and features are subject to change without notice.



For more products please visit: www.tabletexpress.com
Customer Service: cs@tabletexpress.com