



**Shenzhen GTI Technology Co., Ltd.**

1F,2 Block, Jiaquan Building, Guanlan High-tech Park Baoan District,  
Shenzhen, Guangdong, China.

Tel: +86-755-27559792

Fax: +86-755-86116468

Report No.: GTI20140505F-1

Page 1 of 51

# TEST REPORT

**Product name**.....: Tablet PC

**Trademark** .....: Dragon Touch

**Model/Type reference** .....: A93

**Listed Model(s)** .....: /

**FCC ID**.....: S5V-D09A93

**Test Standards** .....: **FCC Part 15.247: Operation within the bands 902-928 MHz, 2400-2483.5 MHz and 5725-5850 MHz**

**Applicant** .....: Proexpress Distributor LLC

**Address of applicant** .....: 15726 Crabbs Branch Way, Derwood, MD 20855 USA

**Date of Receipt** .....: Oct. 27, 2014

**Date of Test Date**.....: Oct. 27, 2014 – Nov. 12, 2014

**Data of issue.** .....: Nov. 13, 2014

<b>Test result</b>	<b>Pass *</b>
--------------------	---------------

\* In the configuration tested, the EUT complied with the standards specified above

GENERAL DESCRIPTION OF EUT	
Equipment:	Tablet PC
Model Name:	A93
Manufacturer:	SHENZHEN BAMBOO FOREST TECHNOLOGY CO.,LTD.
Manufacturer Address:	Room 702,Rujun Building, Banxuegang Rd., Bantian subdistrict, Longgang ,Shenzhen Guangdong, China
Power Source:	DC 3.7V form Li-ion battery
Power Rating:	5V---2000mA

Testing Engineer :



(Allen Wang)

Reviewed By: :

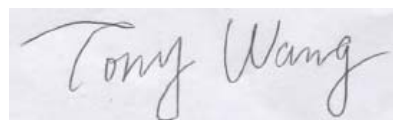

(Tony Wang)

Approved Signatory :

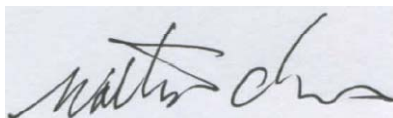

(Walter Chen)

This test report consists of 51pages in total. It may be duplicated completely for legal use with the approval of the applicant. It should not be reproduced except in full, without the written approval of our laboratory. The client should not use it to claim product endorsement by GTI. The test results in the report only apply to the tested sample. The test report shall be invalid without all the signatures of testing engineers, reviewer and approver. Any objections must be raised to GTI within 15 days since the date when the report is received. It will not be taken into consideration beyond this limit.



**Table of Contents**

**Page**

<b>1. SUMMARY.....</b>	<b>4</b>
1.1. TEST STANDARDS.....	4
1.2. TEST DESCRIPTION.....	4
1.3. TEST FACILITY .....	5
1.4. MEASUREMENT UNCERTAINTY .....	5
<b>2. GENERAL INFORMATION.....</b>	<b>6</b>
2.1. ENVIRONMENTAL CONDITIONS .....	6
2.2. GENERAL DESCRIPTION OF EUT .....	6
2.3. DESCRIPTION OF TEST MODES .....	6
2.4. MEASUREMENT INSTRUMENTS LIST .....	7
<b>3. TEST CONDITIONS AND RESULTS .....</b>	<b>9</b>
3.1. CONDUCTED EMISSION (AC MAIN) .....	9
3.2. RADIATED EMISSION .....	12
3.3. MAXIMUM PEAK OUTPUT POWER .....	17
3.4. POWER SPECTRAL DENSITY .....	18
3.5. 6dB BANDWIDTH.....	21
3.6. BAND EDGE COMPLIANCE OF RF EMISSION .....	24
3.7. SPURIOUS RF CONDUCTED EMISSION.....	32
3.8. ANTENNA REQUIREMENT.....	45
<b>4. EUT TEST PHOTO .....</b>	<b>46</b>
<b>5. PHOTOGRAPHS OF EUT CONSTRUCTIONAL .....</b>	<b>47</b>

# 1. SUMMARY

## 1.1. Test Standards

The tests were performed according to following standards:

FCC Rules Part 15.247: Frequency Hopping, Direct Spread Spectrum and Hybrid Systems that are in operation within the bands of 902-928 MHz, 2400-2483.5 MHz, and 5725-5850 MHz

ANSI C63.10: American National Standard for Testing Unlicensed Wireless Devices

KDB558074 D01 V03r02: Guidance for Performing Compliance Measurements on Digital Transmission Systems (DTS) Operating Under §15.247

## 1.2. Test Description

FCC PART 15 15.247		
FCC Part 15.207	AC Power Conducted Emission	PASS
FCC Part 15.247(a)(2)	6dB Bandwidth	PASS
FCC Part 15.247(d)	Spurious RF Conducted Emission	PASS
FCC Part 15.247(b)	Maximum Peak Output Power	PASS
FCC Part 15.247(e)	Power Spectral Density	PASS
FCC Part 15.109/ 15.205/ 15.209	Radiated Emissions	PASS
FCC Part 15.247(d)	Band Edge	PASS
FCC Part 15.203/15.247 (b)	Antenna Requirement	PASS

Remark: The measurement uncertainty is not included in the test result.

## 1.3. Test Facility

### 1.3.1 Address of the test laboratory

#### Shenzhen General Testing & Inspection Technology Co., Ltd.

Add: 1F, 2 Block, Jiaquan Building, Guanlan High-tech Park Baoan District, Shenzhen, Guangdong, China

### 1.3.2 Laboratory accreditation

The test facility is recognized, certified, or accredited by the following organizations:

#### IC Registration No.: 9783A

The 3m alternate test site of Shenzhen GTI Technology Co., Ltd. EMC Laboratory has been registered by Certification and Engineer Bureau of Industry Canada for the performance of with Registration NO.: 9783A on Aug, 2011.

#### FCC-Registration No.: 214666

Shenzhen GTI Technology Co., Ltd. EMC Laboratory has been registered and fully described in a report filed with the (FCC) Federal Communications Commission. The acceptance letter from the FCC is maintained in our files. Registration 214666, Sep 19, 2011

## 1.4. Measurement Uncertainty

The data and results referenced in this document are true and accurate. The reader is cautioned that there may be errors within the calibration limits of the equipment and facilities. The measurement uncertainty was calculated for all measurements listed in this test report acc. to CISPR 16 - 4 Specification for radio disturbance and immunity measuring apparatus and methods – Part 4: Uncertainty in EMC Measurements and is documented in the Shenzhen General Testing & Inspection Technology Co., Ltd quality system acc. to DIN EN ISO/IEC 17025. Furthermore, component and process variability of devices similar to that tested may result in additional deviation. The manufacturer has the sole responsibility of continued compliance of the device.

Hereafter the best measurement capability for General Testing & Inspection laboratory is reported:

Test Items	Measurement Uncertainty	Notes
Transmitter power conducted	0.57 dB	(1)
Transmitter power Radiated	2.20 dB	(1)
Conducted spurious emission 9KHz-40 GHz	1.60 dB	(1)
Radiated spurious emission 9KHz-40 GHz	2.20 dB	(1)
Conducted Emission 9KHz-30MHz	3.39 dB	(1)
Radiated Emission 30~1000MHz	4.24 dB	(1)
Radiated Emission 1~18GHz	5.16 dB	(1)
Radiated Emission 18-40GHz	5.54 dB	(1)

(1) This uncertainty represents an expanded uncertainty expressed at approximately the 95% confidence level using a coverage factor of k=1.96.

## 2. GENERAL INFORMATION

### 2.1. Environmental conditions

During the measurement the environmental conditions were within the listed ranges:

Temperature:	15~35°C
Relative Humidity:	30~60 %
Air Pressure:	950~1050mba

### 2.2. General Description of EUT

Product Name:	Tablet PC
Model/Type reference:	A93
Listed Model(s):	/
Power supply:	DC 3.7V form Li-ion battery
Adapter information:	Model:HLT-003-0502000U Input: AC 100-240V 50/60Hz 0.35A Output:5.0V---2000mA
Hardware version:	E98B_MB_U V2.2
Software version:	Android 4.2.2
<b>WIFI :</b>	
Supported type:	802.11b/802.11g/802.11n(H20)/802.11n(H40)
Modulation:	802.11b: DSSS 802.11g/802.11n(H20)/802.11n(H40):OFDM
Operation frequency:	802.11b/802.11g/802.11n(H20): 2412MHz~2462MHz 802.11n(H40): 2422MHz~2452MHz
Channel number:	802.11b/802.11g/802.11n(H20): 11 802.11n(H40): 7
Channel separation:	5MHz
Antenna type:	FPCB Antenna
Antenna gain:	2.0 dBi

Note: For a more detailed features description, please refer to the manufacturer's specifications or the User's Manual.

### 2.3. Description of Test Modes

The Applicant provides communication tools software to control the EUT for staying in continuous transmitting (Duty Cycle more than 98%) and receiving mode for testing.

#### WIFI Operation Frequency :

Channel	Frequency(MHz)	Channel	Frequency(MHz)
1	2412	8	2447
2	2417	9	2452
3	2422	10	2457
4	2427	11	2462
5	2432		
6	2437		
7	2442		

**Data Rate Used:**

Preliminary tests were performed in different data rate to find the worst radiated emission. The data rate shown in the table below is the worst-case rate with respect to the specific test item. Investigation has been done on all the possible configurations for searching the worst cases. The following table is a list of the test modes shown in this test report.

Test Items	Mode	Data Rate	Channel
Maximum Peak Conducted Output Power Power Spectral Density 6dB Bandwidth Spurious RF conducted emission Radiated Emission 9kHz~1GHz& Radiated Emission 1GHz~10th Harmonic	11b/DSSS	1 Mbps	1/6/11
	11g/OFDM	6 Mbps	1/6/11
	11n(20MHz)/OFDM	6.5Mbps	1/6/11
	11n(40MHz)/OFDM	13.5 Mbps	3/6/9
Band Edge	11b/DSSS	1 Mbps	1/11
	11g/OFDM	6 Mbps	1/11
	11n(20MHz)/OFDM	6.5Mbps	1/11
	11n(40MHz)/OFDM	13.5 Mbps	3//9

**2.4. Measurement Instruments List**

Maximum Peak Output Power					
Item	Test Equipment	Manufacturer	Model No.	Serial No.	Calibrated until
1	Power Meter	Anritsu	ML2487B	110553	July 10,2015
2	Power Sensor	Anritsu	MA2411B	100345	July 10,2015

Power Spectral Density / 6dB Bandwidth / Band Edge Compliance of RF Emission / Spurious RF Conducted Emission					
Item	Test Equipment	Manufacturer	Model No.	Serial No.	Calibrated until
1	Spectrum Analyzer	Rohde&Schwarz	FSU	100105	Oct 25,2015

Conducted Emission					
Item	Test Equipment	Manufacturer	Model No.	Serial No.	Calibrate until
1	LISN	R&S	ENV216	101112	Dec. 26, 2014
2	LISN	R&S	ENV216	101113	Dec. 26, 2014
3	EMI Test Receiver	R&S	ESCI	100920	Dec. 26, 2014
4	Cable	Schwarzbeck	Cable001	--	Dec. 26, 2014

Radiated Emission					
Item	Test Equipment	Manufacturer	Model No.	Serial No.	Calibrated until
1	EMI Test Receiver	R&S	ESCI	100658	Dec 26,2014
2	High pass filter	Compliance Direction systems	BSU-6	34202	Oct 25,2015
3	Log-Bicon Antenna	Schwarzbeck	CBL6141A	4180	Dec 27,2014
4	Ultra-Broadband Antenna	ShwarzBeck	BBHA9170	25841	Dec 27,2014



5	Loop Antenna	LAPLAC	RF300	9138	Nov 15,2014
6	Spectrum Analyzer	HP	8563E	02052	Dec 27,2014
7	Horn Antenna	Schwarzbeck	BBHA 9120D	648	Dec 27,2014
8	Pre-Amplifier	HP	8447D	1937A03050	Dec 26,2014
9	Pre-Amplifier	EMCI	EMC05183 5	980075	Dec 27,2014
10	Antenna Mast	UC	UC3000	N/A	N/A
11	Turn Table	UC	UC3000	N/A	N/A
12	Cable	Schwarzbeck	Cable002	--	Dec. 26,2014
13	Cable	Schwarzbeck	Cable003	--	Dec. 26,2014

Note: 1. The Cal.Interval was one year.

2. The cable loss has calculated in test result which connection between each test instruments.



### 3. TEST CONDITIONS AND RESULTS

#### 3.1. Conducted Emission (AC Main)

##### LIMIT

FCC CFR Title 47 Part 15 Subpart C Section 15.207

Frequency range (MHz)	Limit (dBuV)	
	Quasi-peak	Average
0.15-0.5	66 to 56*	56 to 46*
0.5-5	56	46
5-30	60	50

\* Decreases with the logarithm of the frequency.

##### TEST CONFIGURATION

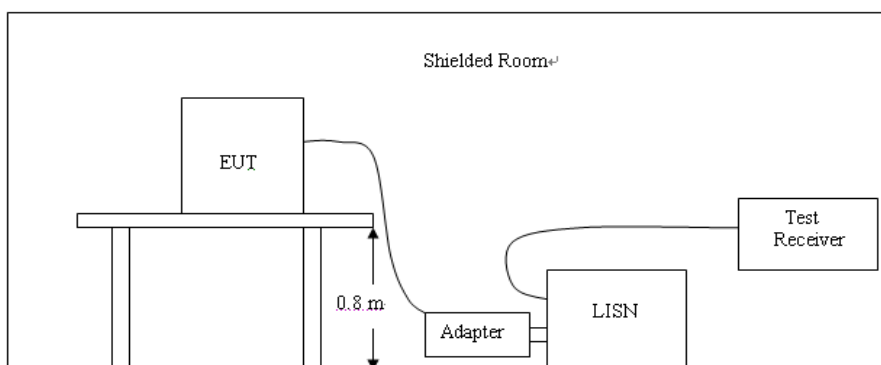

##### TEST PROCEDURE

1. The equipment was set up as per the test configuration to simulate typical actual usage per the user's manual. The EUT is a tabletop system; a wooden table with a height of 0.8 meters is used and is placed on the ground plane as per ANSI C63.10-2009.
2. Support equipment, if needed, was placed as per ANSI C63.10-2009
3. All I/O cables were positioned to simulate typical actual usage as per ANSI C63.10-2009
4. The EUT received DC5V power from the adapter, the adapter received AC120V/60Hz power through a Line Impedance Stabilization Network (LISN) which supplied power source and was grounded to the ground plane.
5. All support equipments received AC power from a second LISN, if any.
6. The EUT test program was started. Emissions were measured on each current carrying line of the EUT using a spectrum Analyzer / Receiver connected to the LISN powering the EUT. The LISN has two monitoring points: Line 1 (Hot Side) and Line 2 (Neutral Side). Two scans were taken: one with Line 1 connected to Analyzer / Receiver and Line 2 connected to a 50 ohm load; the second scan had Line 1 connected to a 50 ohm load and Line 2 connected to the Analyzer / Receiver.
7. Analyzer / Receiver scanned from 150 KHz to 30MHz for emissions in each of the test modes.
8. During the above scans, the emissions were maximized by cable manipulation.

**TEST RESULTS**

LINE	L
------	---

**SCAN TABLE: "Voltage (9K-30M) FIN1"**  
 Short Description: 150K-30M Voltage

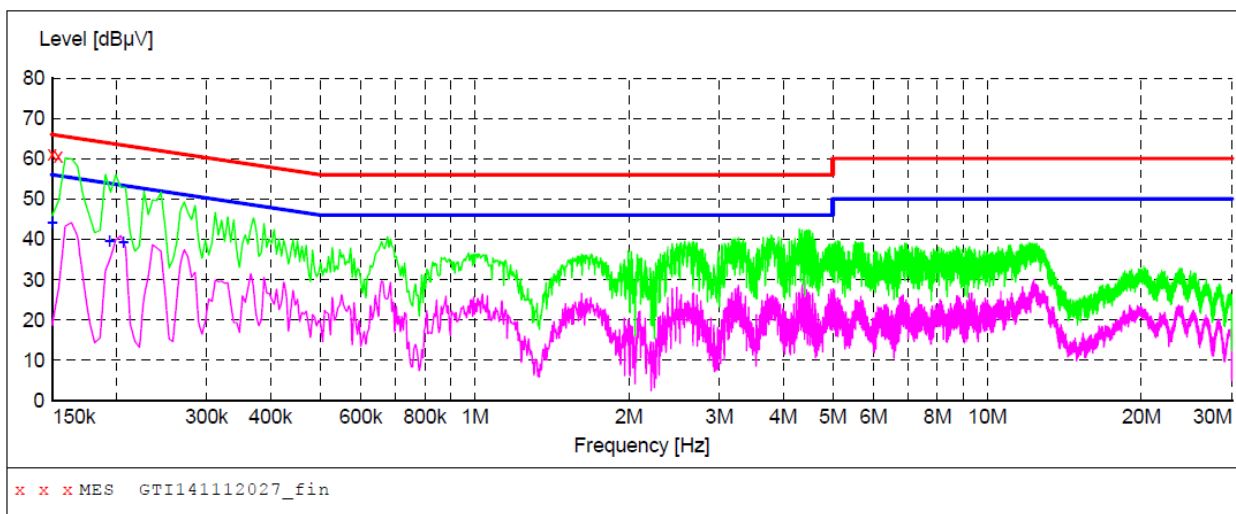

**MEASUREMENT RESULT: "GTI141112027\_fin"**

11/12/2014 3:20PM

Frequency MHz	Level dBµV	Transd dB	Limit dBµV	Margin dB	Detector	Line	PE
0.150000	61.10	9.9	66	4.9	QP	L1	GND
0.154000	60.70	9.9	66	5.1	QP	L1	GND

**MEASUREMENT RESULT: "GTI141112027\_fin2"**

11/12/2014 3:20PM

Frequency MHz	Level dBµV	Transd dB	Limit dBµV	Margin dB	Detector	Line	PE
0.150000	44.20	9.9	56	11.8	AV	L1	GND
0.194000	39.50	9.9	54	14.4	AV	L1	GND
0.206000	39.30	9.9	53	14.1	AV	L1	GND

LINE

N

**SCAN TABLE: "Voltage (9K-30M) FIN1"**

Short Description: 150K-30M Voltage

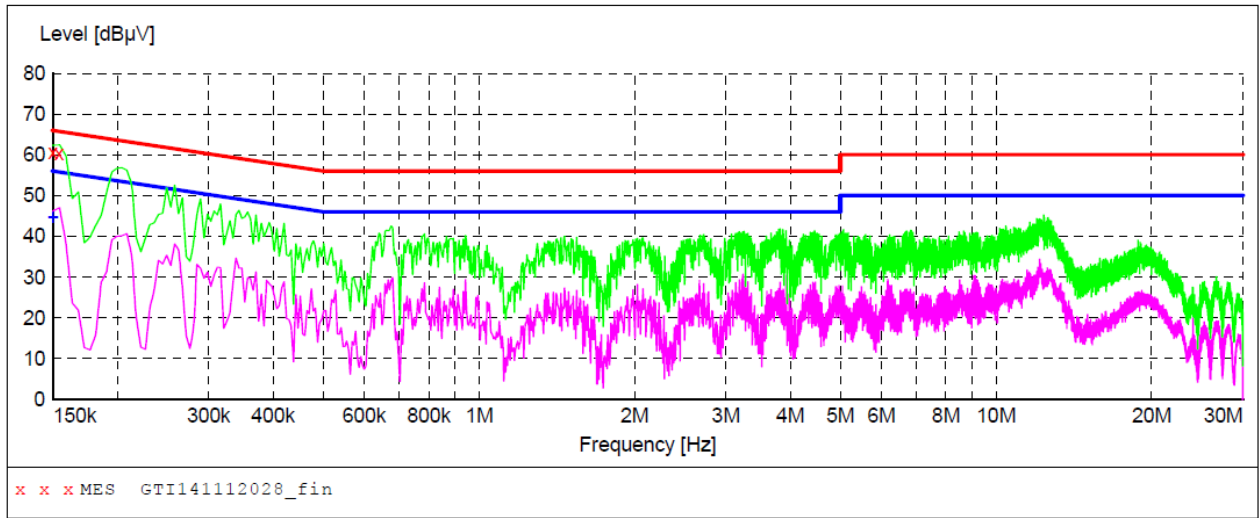

**MEASUREMENT RESULT: "GTI141112028\_fin"**

11/12/2014 3:24PM

Frequency MHz	Level dBµV	Transd dB	Limit dBµV	Margin dB	Detector	Line	PE
0.150000	60.70	9.9	66	5.3	QP	N	GND
0.154000	60.30	9.9	66	5.5	QP	N	GND

**MEASUREMENT RESULT: "GTI141112028\_fin2"**

11/12/2014 3:24PM

Frequency MHz	Level dBµV	Transd dB	Limit dBµV	Margin dB	Detector	Line	PE
0.150000	44.70	9.9	56	11.3	AV	N	GND

### 3.2. Radiated Emission

#### Limit

For intentional device, according to § 15.209(a), the general requirement of field strength of radiated emission from intentional radiators at a distance of 3 meters shall not exceed the following table. According to § 15.247(d), in any 100kHz bandwidth outside the frequency band in which the EUT is operating, the radio frequency power that is produced by the intentional radiator shall be at least 20dB below that in the 100kHz bandwidth within the band that contains the highest level of desired power.

The frequency spectrum above 1 GHz for Transmitter was investigated. All emission not reported are much lower than the prescribed limits. Set the RBW=1MHz, VBW=3MHz for Peak Detector while the RBW=1MHz, VBW=10Hz for Average Detector, Readings are both peak and average values. The pre-test have done for the EUT in three axes and found the worst emission at position shown in test setup photos.

Frequency (MHz)	Distance (Meters)	Radiated (dBuV/m)	Radiated (µV/m)
0.009-0.49	3	$20\log(2400/F(\text{KHz}))+40\log(300/3)$	$2400/F(\text{KHz})$
0.49-1.705	3	$20\log(24000/F(\text{KHz}))+40\log(30/3)$	$24000/F(\text{KHz})$
1.705-30	3	$20\log(30)+40\log(30/3)$	30
30-88	3	40.0	100
88-216	3	43.5	150
216-960	3	46.0	200
Above 960	3	54.0	500

#### Test Procedure

1. The EUT was placed on a turn table which is 0.8m above ground plane.
2. Maximum procedure was performed by raising the receiving antenna from 1m to 4m and rotating the turn table from 0°C to 360°C to acquire the highest emissions from EUT
3. And also, each emission was to be maximized by changing the polarization of receiving antenna both horizontal and vertical.
4. Repeat above procedures until all frequency measurements have been completed.

#### Field Strength Calculation

The field strength is calculated by adding the Antenna Factor and Cable Factor and subtracting the Amplifier Gain and Duty Cycle Correction Factor (if any) from the measured reading. The basic equation with a sample calculation is as follows:

$$FS = RA + AF + CL - AG$$

Where	FS = Field Strength	CL = Cable Attenuation Factor (Cable Loss)
	RA = Reading Amplitude	AG = Amplifier Gain
	AF = Antenna Factor	

For example

Frequency (MHz)	FS (dBµV/m)	RA (dBµV/m)	AF (dB)	CL (dB)	AG (dB)	Transd (dB)
150.00	40	58.1	12.2	1.6	31.90	-18.1

$$\text{Transd} = \text{AF} + \text{CL} - \text{AG}$$

**Test Configuration**

Frequency range 9KHz – 30MHz

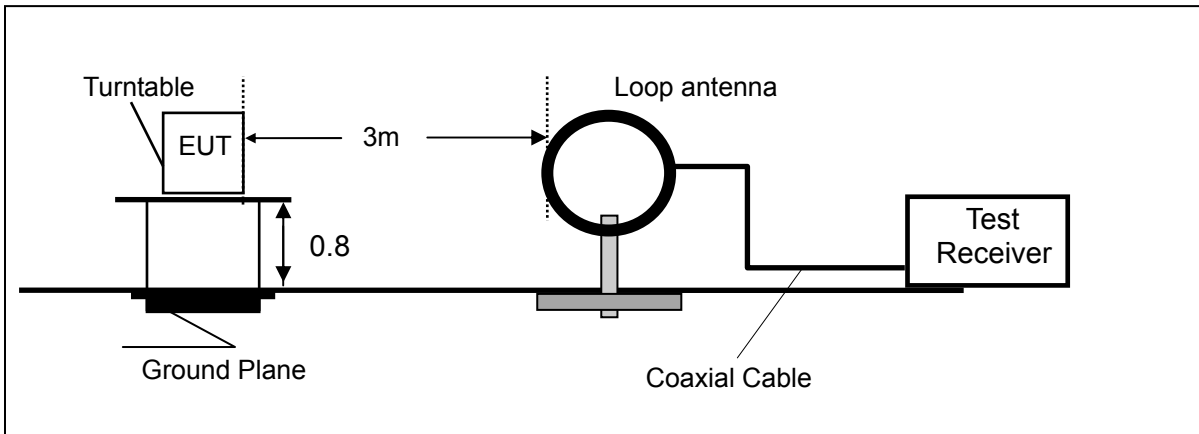

Frequency range 30MHz – 1000MHz

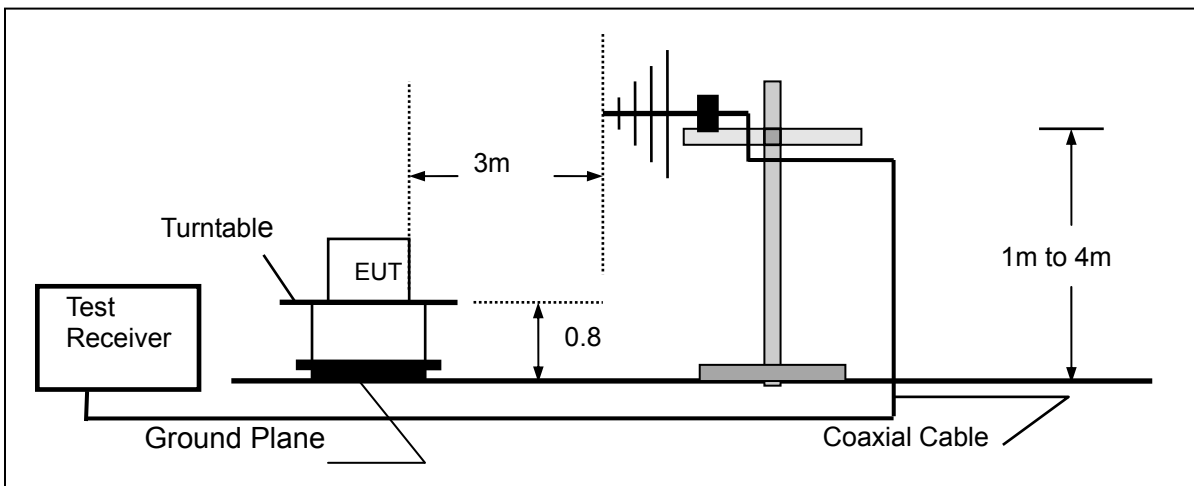

Frequency range above 1GHz-25GHz

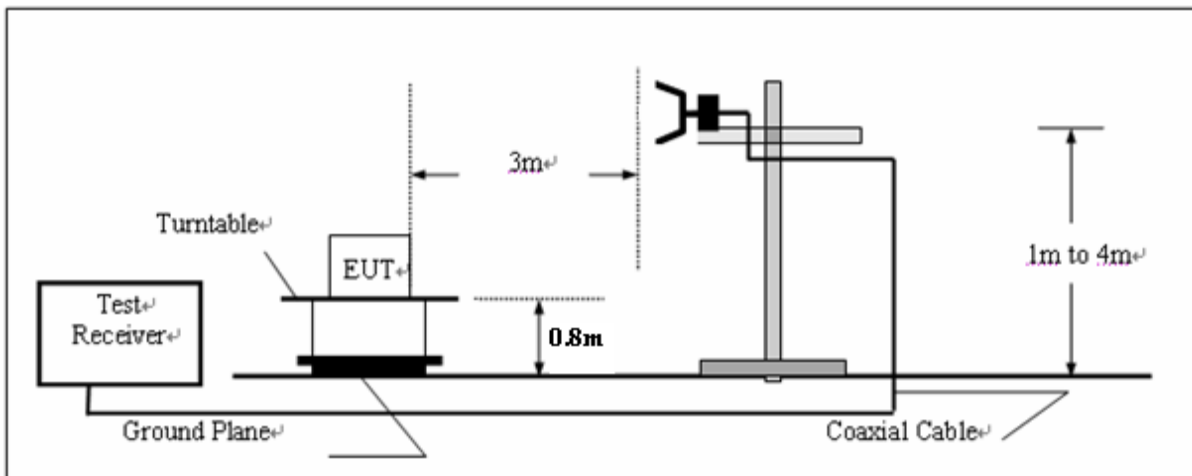

**Test Results**

Remark:

1. We tested three channels for each mode of WIFI and recorded worst case at low channel at 802.11b mode below 1GHz.
2. We tested three channels for each mode of WIFI and recorded worst case at 802.11b mode above 1GHz.

For 9 KHz-30MHz

Frequency (MHz)	Corrected Reading (dBuV/m)@3m	FCC Limit (dBuV/m) @3m	Margin (dB)	Detector	Result
0.35	48.62	96.72	48.10	QP	PASS
1.66	55.36	63.20	7.84	QP	PASS
20.45	59.74	69.54	9.80	QP	PASS
25.78	41.20	69.54	28.34	QP	PASS

For 30MHz-1GHz

Horizontal

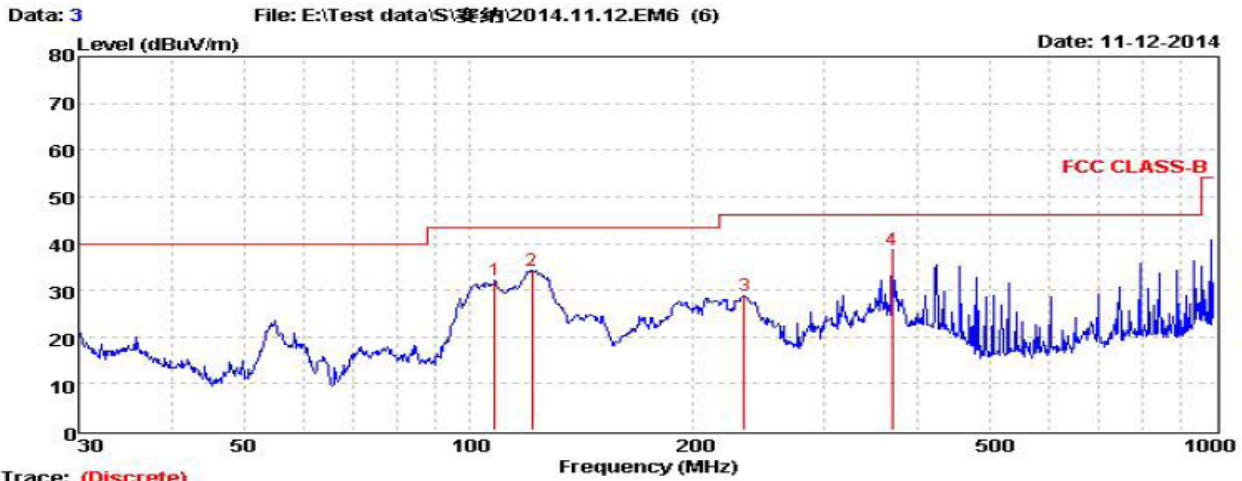

Mark	Frequency MHz	Level dBm	Factor dB	Reading dBm	Limit dB	Margin dB	Polarization	Detector
1	108.27	32.16	-19.08	51.24	43.50	11.34	HORIZONTAL	Peak
2	121.55	34.30	-18.69	52.99	43.50	9.20	HORIZONTAL	Peak
3	234.17	28.97	-17.68	46.65	46.00	17.03	HORIZONTAL	Peak
4	369.40	38.80	-14.44	53.24	46.00	7.20	HORIZONTAL	Peak

Vertical

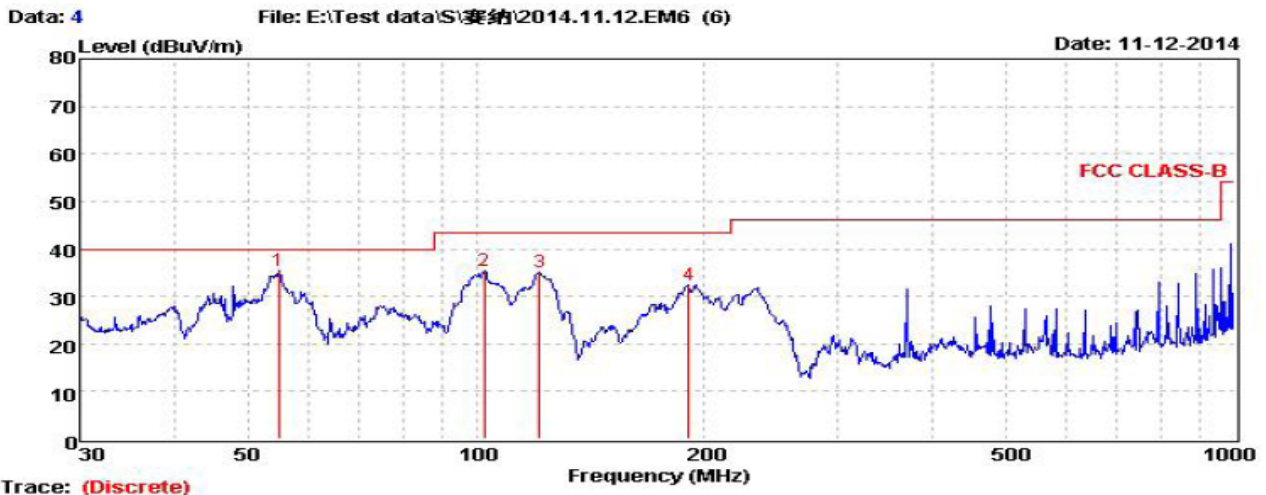

Mark	Frequency MHz	Level dBm	Factor dB	Reading dBm	Limit dB	Margin dB	Polarization	Detector
1	54.83	35.37	-17.33	52.70	40.00	4.63	VERTICAL	Peak
2	102.36	35.28	-19.29	54.57	43.50	8.22	VERTICAL	Peak
3	121.12	34.95	-18.69	53.64	43.50	8.55	VERTICAL	Peak
4	190.41	32.46	-18.83	51.29	43.50	11.04	VERTICAL	Peak



For 1GHz to 25GHz

802.11b Mode (above 1GHz)

Frequency(MHz):			2412			Polarity:			HORIZONTAL		
No.	Frequency (MHz)	Emission Level (dBUV/m)	Limit (dBUV/m)	Margin (dB)	Antenna Height (m)	Table Angle (Degree)	Raw Value (dBUV)	Antenna Factor (dB/m)	Cable Factor (dB)	Pre-amplifier (dB)	Correction Factor (dB/m)
1	4873.00	60.25 PK	74	13.75	1.00	45	58.25	31.60	6.90	36.50	2.00
1	4873.00	47.68 AV	54	6.32	1.00	45	45.68	31.60	6.90	36.50	2.00
2	7312.00	58.33 PK	74	15.67	1.00	130	47.50	37.33	8.80	35.30	10.83
2	7312.00	41.47 AV	54	12.53	1.00	130	30.64	37.33	8.80	35.30	10.83

Frequency(MHz):			2412			Polarity:			VERTICAL		
No.	Frequency (MHz)	Emission Level (dBUV/m)	Limit (dBUV/m)	Margin (dB)	Antenna Height (m)	Table Angle (Degree)	Raw Value (dBUV)	Antenna Factor (dB/m)	Cable Factor (dB)	Pre-amplifier (dB)	Correction Factor (dB/m)
1	4873.00	60.30 PK	74	13.70	1.00	250	58.30	31.60	6.90	36.50	2.00
1	4873.00	47.47 AV	54	6.53	1.00	250	45.47	31.60	6.90	36.50	2.00
2	7312.00	57.23 PK	74	16.77	1.00	135	46.40	37.33	8.80	35.30	10.83
2	7312.00	40.52 AV	54	13.48	1.00	135	29.69	37.33	8.80	35.30	10.83

Frequency(MHz):			2437			Polarity:			HORIZONTAL		
No.	Frequency (MHz)	Emission Level (dBUV/m)	Limit (dBUV/m)	Margin (dB)	Antenna Height (m)	Table Angle (Degree)	Raw Value (dBUV)	Antenna Factor (dB/m)	Cable Factor (dB)	Pre-amplifier (dB)	Correction Factor (dB/m)
1	4875.00	59.47 PK	74.00	14.53	1.00	210	57.35	31.02	7.60	36.50	2.12
1	4875.00	47.36 AV	54.00	6.64	1.00	210	45.24	31.02	7.60	36.50	2.12
2	7313.00	57.48 PK	74.00	16.52	1.00	190	46.40	37.28	8.60	34.80	11.08
2	7313.00	40.41 AV	54.00	13.59	1.00	190	29.33	37.28	8.60	34.80	11.08

Frequency(MHz):			2437			Polarity:			VERTICAL		
No.	Frequency (MHz)	Emission Level (dBUV/m)	Limit (dBUV/m)	Margin (dB)	Antenna Height (m)	Table Angle (Degree)	Raw Value (dBUV)	Antenna Factor (dB/m)	Cable Factor (dB)	Pre-amplifier (dB)	Correction Factor (dB/m)
1	4875.00	60.14 PK	74.00	13.86	1.00	125	58.02	31.02	7.60	36.50	2.12
1	4875.00	48.30 AV	54.00	5.70	1.00	125	46.18	31.02	7.60	36.50	2.12
2	7313.00	57.47 PK	74.00	16.53	1.00	45	46.39	37.28	8.60	34.80	11.08
2	7313.00	41.20 AV	54.00	12.80	1.00	45	30.12	37.28	8.60	34.80	11.08

Frequency(MHz):			2462			Polarity:			HORIZONTAL		
No.	Frequency (MHz)	Emission Level (dBUV/m)	Limit (dBUV/m)	Margin (dB)	Antenna Height (m)	Table Angle (Degree)	Raw Value (dBUV)	Antenna Factor (dB/m)	Cable Factor (dB)	Pre-amplifier (dB)	Correction Factor (dB/m)
1	4925.00	58.36 PK	74.00	15.64	1.00	300	55.98	31.58	7.00	36.20	2.38
1	4925.00	48.20 AV	54.00	5.80	1.00	300	45.82	31.58	7.00	36.20	2.38
2	7387.00	56.47 PK	74.00	17.53	1.00	120	44.76	38.51	8.50	35.30	11.71
2	7387.00	40.33 AV	54.00	13.67	1.00	120	28.62	38.51	8.50	35.30	11.71

Frequency(MHz):			2462			Polarity:			VERTICAL		
No.	Frequency (MHz)	Emission Level (dBUV/m)	Limit (dBUV/m)	Margin (dB)	Antenna Height (m)	Table Angle (Degree)	Raw Value (dBUV)	Antenna Factor (dB/m)	Cable Factor (dB)	Pre-amplifier (dB)	Correction Factor (dB/m)
1	4925.00	60.47 PK	74.00	13.53	1.00	125	58.09	31.58	7.00	36.20	2.38
1	4925.00	48.33 AV	54.00	5.67	1.00	125	45.95	31.58	7.00	36.20	2.38
2	7387.00	56.85 PK	74.00	17.15	1.00	200	45.14	38.51	8.50	35.30	11.71
2	7387.00	41.22 AV	54.00	12.78	1.00	200	29.51	38.51	8.50	35.30	11.71



REMARKS:

1. Emission level (dBuV/m) =Raw Value (dBuV)+Correction Factor (dB/m)
2. Correction Factor (dB/m) = Antenna Factor (dB/m)+Cable Factor (dB)-Pre-amplifier Factor
3. Margin value = Limit value- Emission level.
4. -- Mean the PK detector measured value is below average limit.
5. The other emission levels were very low against the limit.



### 3.3. Maximum Peak Output Power

**Limit**

The Maximum Peak Output Power Measurement is 30dBm.

**Test Procedure**

Remove the antenna from the EUT and then connect a low loss RF cable from the antenna port to the power sensor.

**Test Configuration**



**Test Results**

WIFI				
Type	Channel	Output power (dBm)	Limit (dBm)	Result
802.11b	01	9.43	30.00	Pass
	06	9.28		
	11	9.17		
802.11g	01	8.64	30.00	Pass
	06	8.74		
	11	8.64		
802.11n(H20)	01	8.55	30.00	Pass
	06	8.47		
	11	8.76		
802.11n(H40)	03	8.01	30.00	Pass
	06	8.11		
	09	8.15		

Note: 1.The test results including the cable lose.

### 3.4. Power Spectral Density

#### Limit

For digitally modulated systems, the power spectral density conducted from the intentional radiator to the antenna shall not be greater than 8 dBm in any 3 kHz band during any time interval of continuous transmission.

#### Test Procedure

1. Use this procedure when the maximum peak conducted output power in the fundamental emission is used to demonstrate compliance.
2. Set the RBW  $\geq$  3 kHz.
3. Set the VBW  $\geq$  3 $\times$  RBW.
4. Set the span to 1.5 times the DTS channel bandwidth.
5. Detector = peak.
6. Sweep time = auto couple.
7. Trace mode = max hold.
8. Allow trace to fully stabilize.
9. Use the peak marker function to determine the maximum power level.
10. If measured value exceeds limit, reduce RBW (no less than 3 kHz) and repeat.
11. The resulting peak PSD level must be 8dBm.

#### Test Configuration

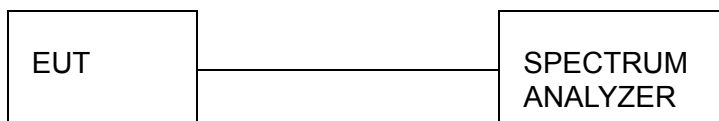

#### Test Results

WIFI				
Type	Channel	Power Spectral Density (dBm/3KHz)	Limit (dBm/3KHz)	Result
802.11b	01	-24.47	8.00	Pass
	06	-25.21		
	11	-25.83		
802.11g	01	-30.09	8.00	Pass
	06	-31.32		
	11	-30.11		
802.11n(HT20)	01	-29.94	8.00	Pass
	06	-30.83		
	11	-31.34		
802.11n(HT40)	03	-35.43	8.00	Pass
	06	-34.03		
	09	-34.52		

Test plot as follows:

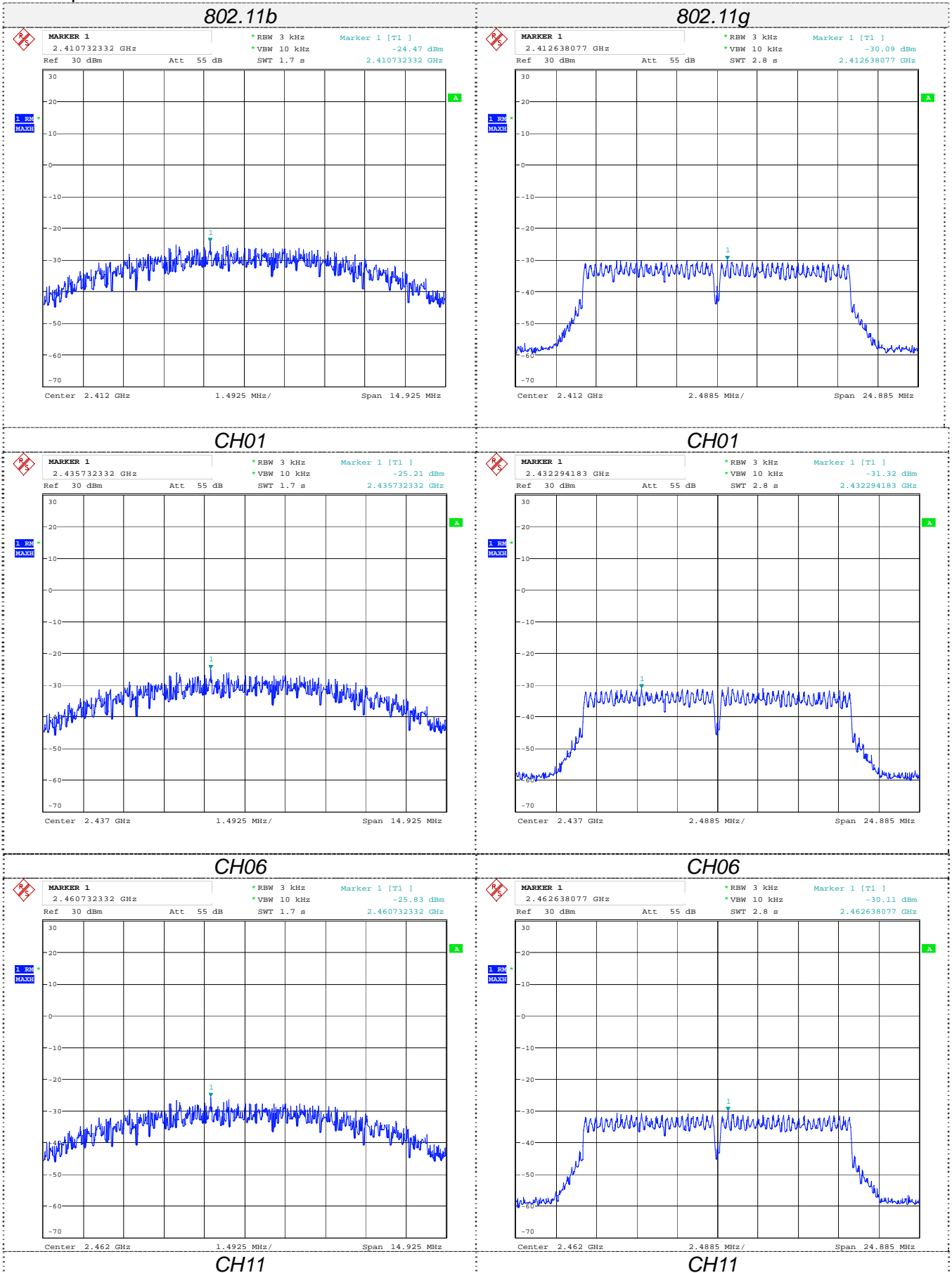

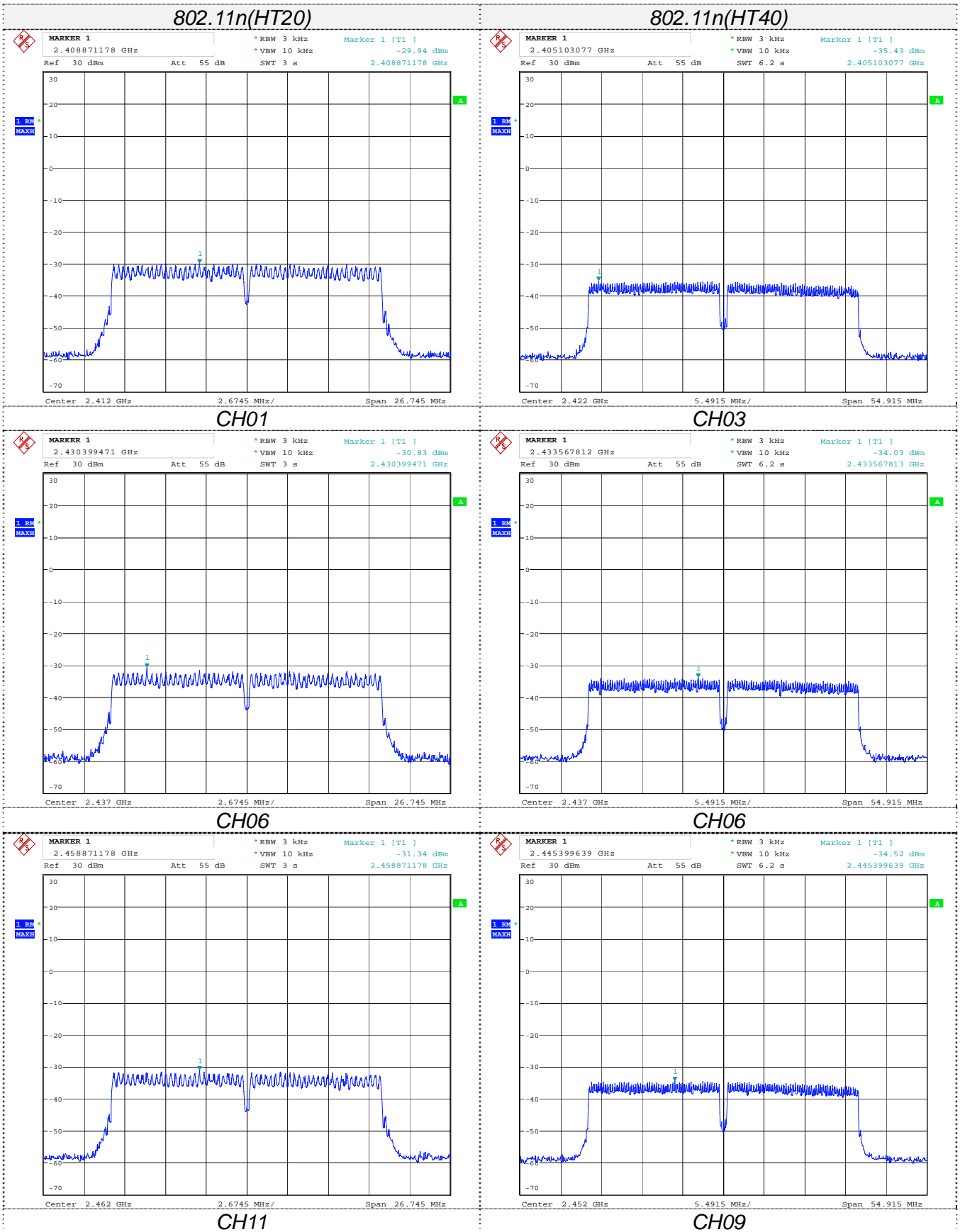

### 3.5. 6dB Bandwidth

**Limit**

For digital modulation systems, the minimum 6 dB bandwidth shall be at least 500 kHz

**Test Procedure**

The transmitter output was connected to the spectrum analyzer through an attenuator. The bandwidth of the fundamental frequency was measured by spectrum analyzer with 100 KHz RBW and 300 KHz VBW. The 6dB bandwidth is defined as the total spectrum the power of which is higher than peak power minus 6dB.

**Test Configuration**

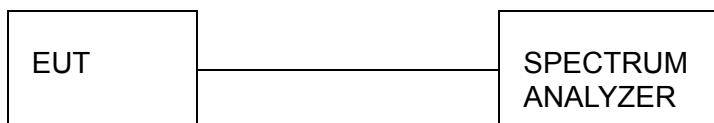

**Test Results**

WIFI				
Type	Channel	6dB Bandwidth (MHz)	Limit (KHz)	Result
802.11b	01	9.95	≥500	Pass
	06	9.90		
	11	9.80		
802.11g	01	16.59	≥500	Pass
	06	16.59		
	11	16.40		
802.11n(HT20)	01	17.83	≥500	Pass
	06	17.88		
	11	17.88		
802.11n(HT40)	03	36.62	≥500	Pass
	06	36.60		
	09	36.58		

Test plot as follows:

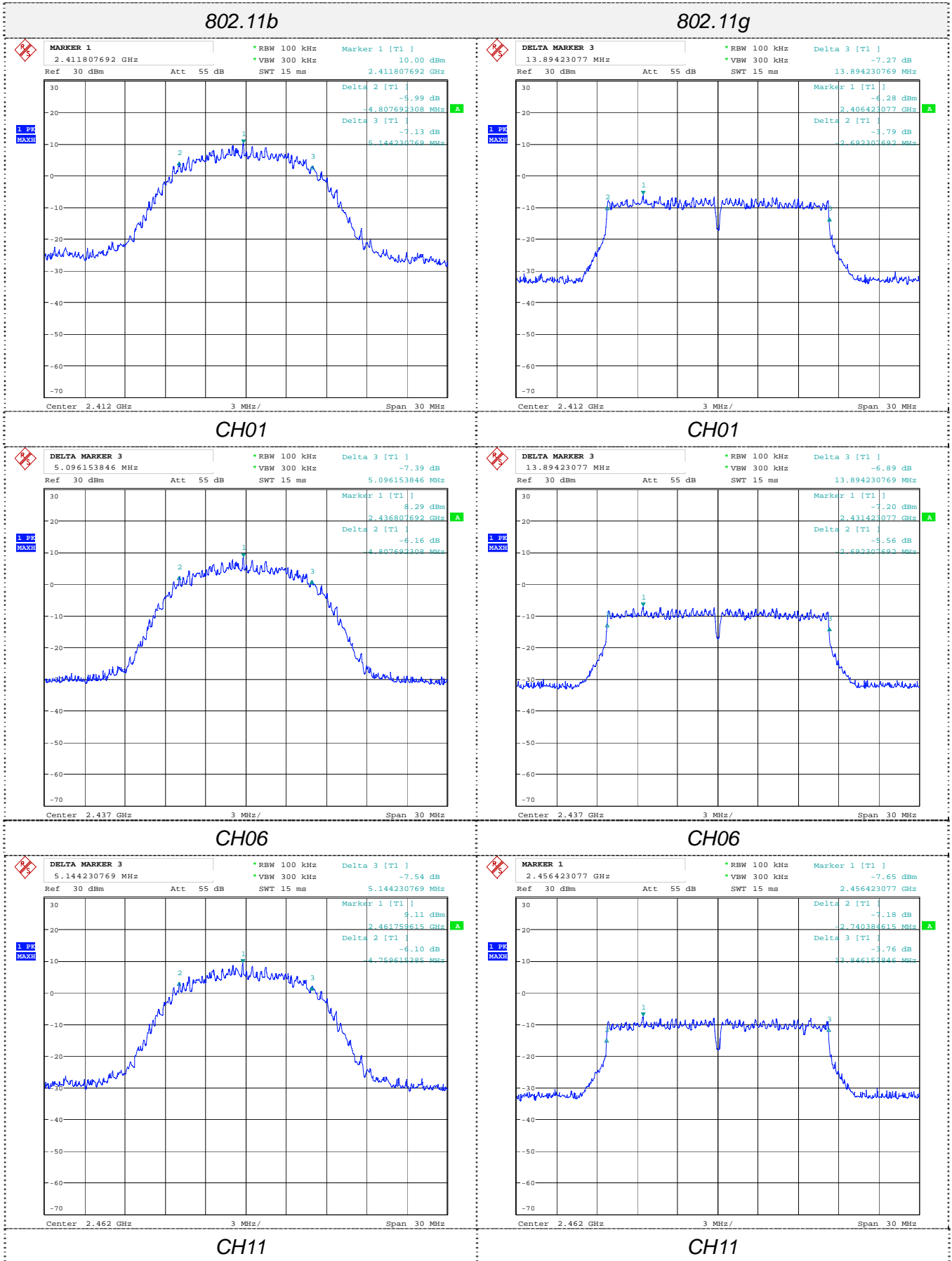

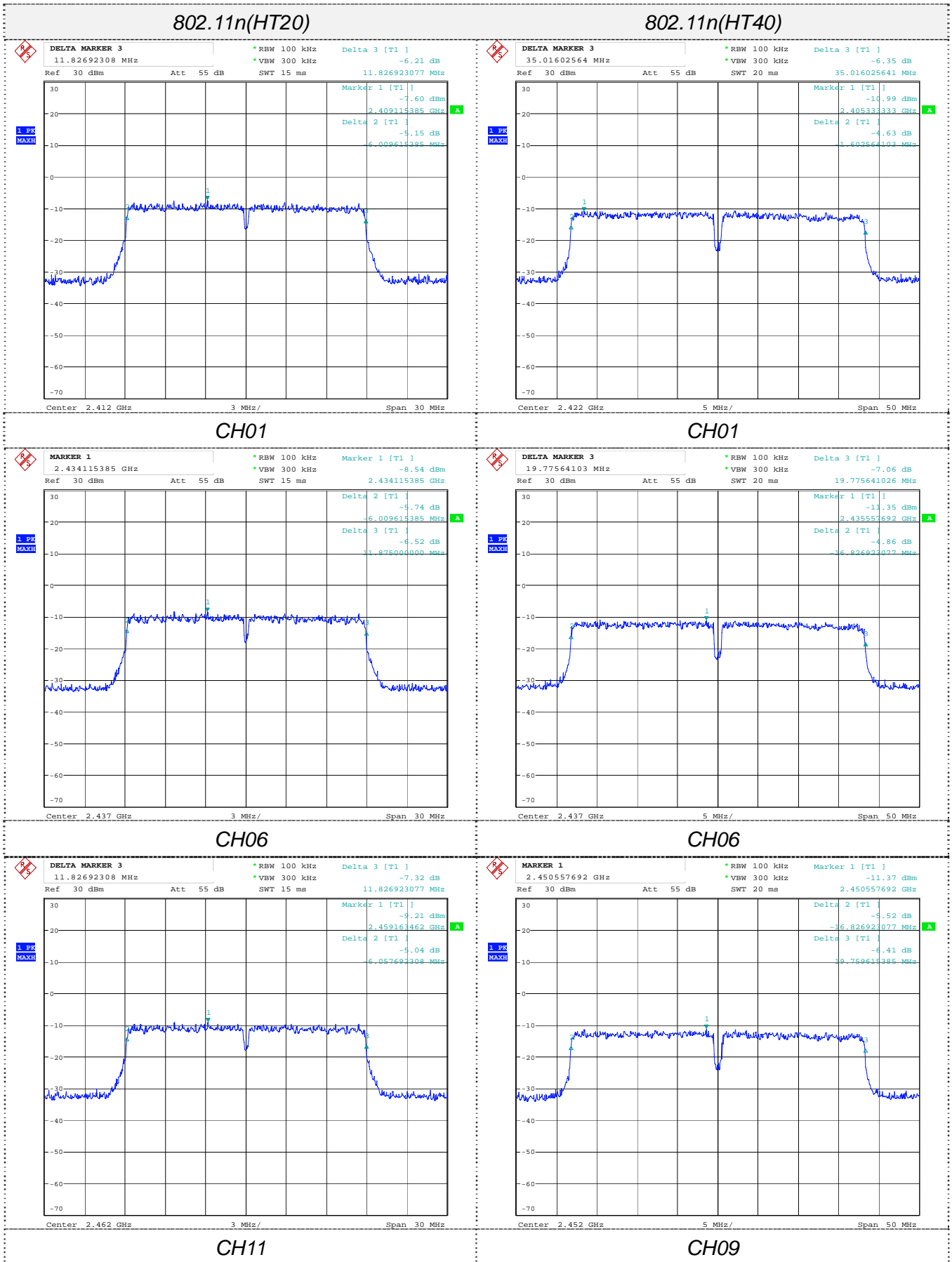

### 3.6. Band Edge Compliance of RF Emission

#### Limit

In any 100 kHz bandwidth outside the frequency band in which the spread spectrum or digitally modulated intentional radiator is operating, the radio frequency power that is produced by the intentional radiator shall be at least 20 dB below that in the 100 kHz bandwidth within the band that contains the highest level of the desired power, based on either an RF conducted or a radiated measurement, provided the transmitter demonstrates compliance with the peak conducted power limits. If the transmitter complies with the conducted power limits based on the use of RMS averaging over a time interval, as permitted under paragraph (b)(3) of this section, the attenuation required under this paragraph shall be 30 dB instead of 20 dB. Attenuation below the general limits specified in §15.209(a) is not required. In addition, radiated emissions which fall in the restricted bands, as defined in §15.205(a), must also comply with the radiated emission limits specified in §15.209(a) (see §15.205(c)).

Below -20dB of the highest emission level in operating band.

Radiated emissions which fall in the restricted bands, as defined in § 15.205(a), must also comply with the radiated emission limits specified in § 15.209(a)

#### Test Procedure

According to KDB 558074 D01 V03 for Antenna-port conducted measurement. Antenna-port conducted measurements may also be used as an alternative to radiated measurements for demonstrating compliance in the restricted frequency bands. If conducted measurements are performed, then proper impedance matching must be ensured and an additional radiated test for cabinet/case spurious emissions is required.

1. Check the calibration of the measuring instrument using either an internal calibrator or a known signal from an external generator.
2. Remove the antenna from the EUT and then connect to a low loss RF cable from the antenna port to a EMI test receiver, then turn on the EUT and make it operate in transmitting mode. Then set it to Low Channel and High Channel within its operating range, and make sure the instrument is operated in its linear range
3. Set both RBW and VBW of spectrum analyzer to 100 kHz with a convenient frequency span including 100kHz bandwidth from band edge, for Radiated emissions restricted band RBW=1MHz, VBW=3MHz for peak detector and RBW=1MHz, VBW=10Hz for average detector.
4. Measure the highest amplitude appearing on spectral display and set it as a reference level. Plot the graph with marking the highest point and edge frequency.
5. Repeat above procedures until all measured frequencies were complete.
6. Measure the conducted output power (in dBm) using the detector specified by the appropriate regulatory agency (see 12.2.2, 12.2.3, and 12.2.4 for guidance regarding measurement procedures for determining quasi-peak, peak, and average conducted output power, respectively).
7. Add the maximum transmit antenna gain (in dBi) to the measured output power level to determine the EIRP level (see 12.2.5 for guidance on determining the applicable antenna gain)
8. Add the appropriate maximum ground reflection factor to the EIRP level (6 dB for frequencies  $\leq$  30 MHz, 4.7 dB for frequencies between 30 MHz and 1000 MHz, inclusive and 0 dB for frequencies > 1000 MHz).
9. For devices with multiple antenna-ports, measure the power of each individual chain and sum the EIRP of all chains in linear terms (e.g., Watts, mW).
10. Convert the resultant EIRP level to an equivalent electric field strength using the following



relationship:

$$E = \text{EIRP} - 20\log D + 104.8$$

Where:

E = electric field strength in dBuV/m,

EIRP = equivalent isotropic radiated power in dBm

D = specified measurement distance in meters.

Compare the resultant electric field strength level to the applicable regulatory limit. Perform radiated spurious emission test

### Test Configuration

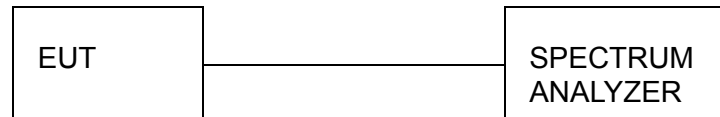

### Test Results

**A. Conducted Emission Band Edge**

802.11b						
Frequency (MHz)	Conducted Power (dBm)	Antenna Gain (dBi)	Ground reflection factor(dBi)	Covert Radiated E Level At 3m (dBuV/m)	Detector	Limit (dBuV/m)
2390.00	-42.81	2.00	0	54.45	PK	74.00
2390.00	-53.67	2.00	0	43.59	AV	54.00
2483.50	-44.69	2.00	0	52.57	PK	74.00
2483.50	-56.41	2.00	0	40.85	AV	54.00

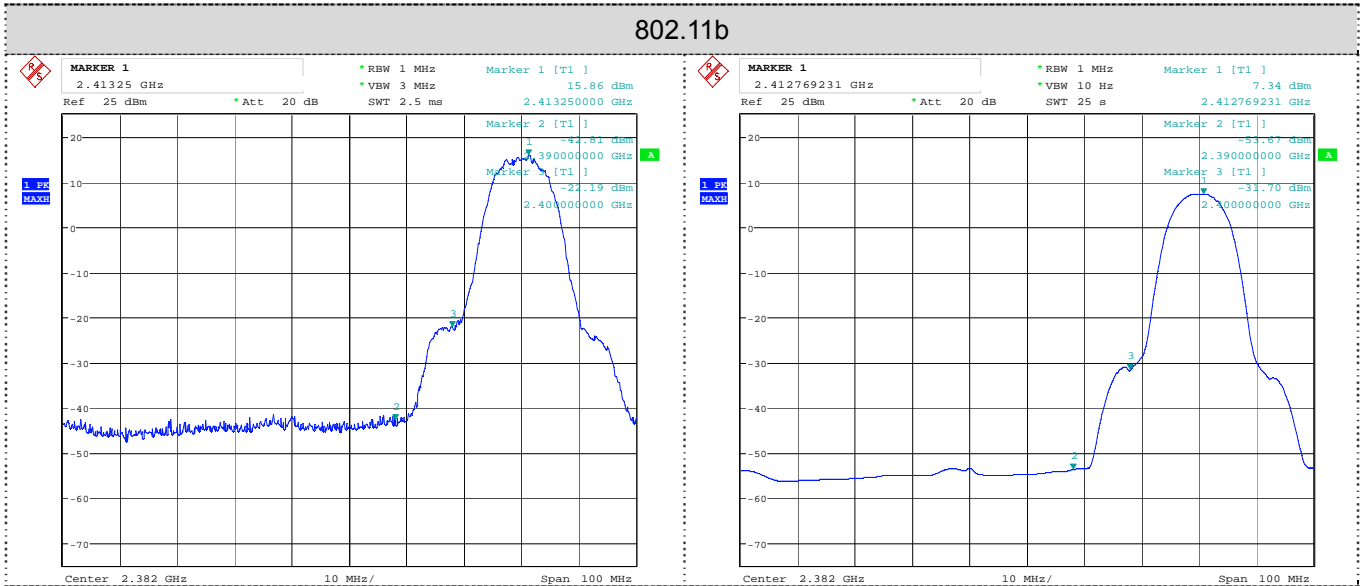

**CH 01**

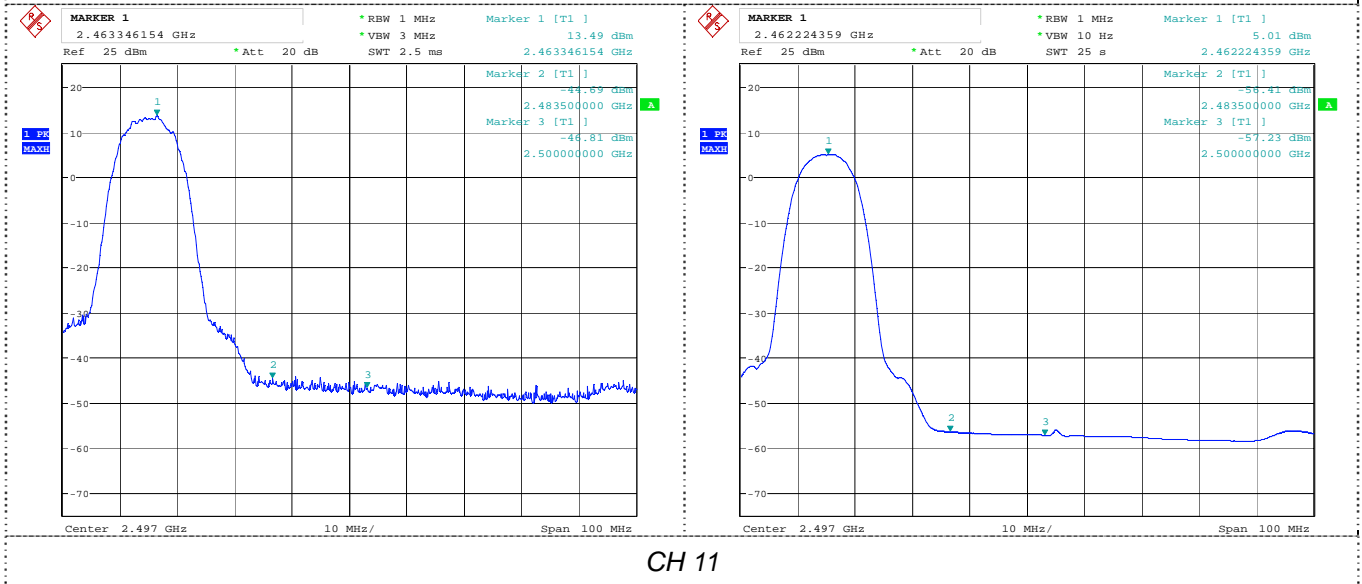

**CH 11**

802.11g						
Frequency (MHz)	Conducted Power (dBm)	Antenna Gain (dBi)	Ground reflection factor(dBi)	Covert Radiated E Level At 3m (dBuV/m)	Detector	Limit (dBuV/m)
2390.00	-50.64	2.00	0	46.62	PK	74.00
2390.00	-60.70	2.00	0	36.56	AV	54.00
2483.50	-49.55	2.00	0	47.71	PK	74.00
2483.50	-61.79	2.00	0	35.47	AV	54.00

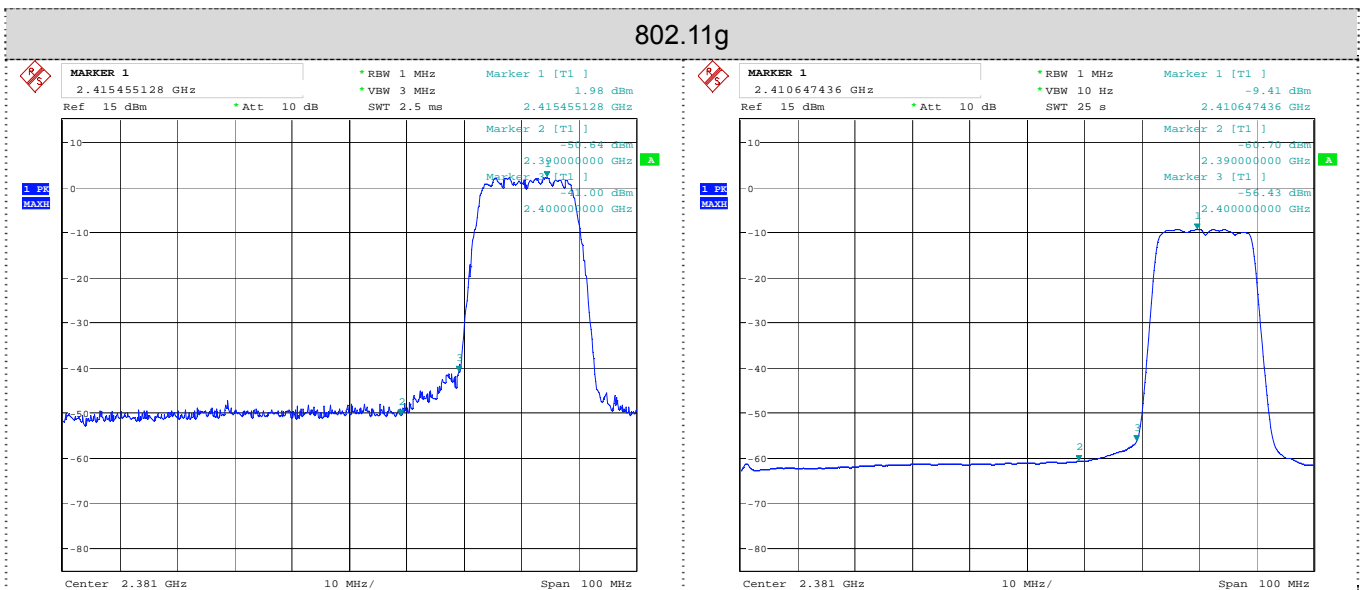

CH 01

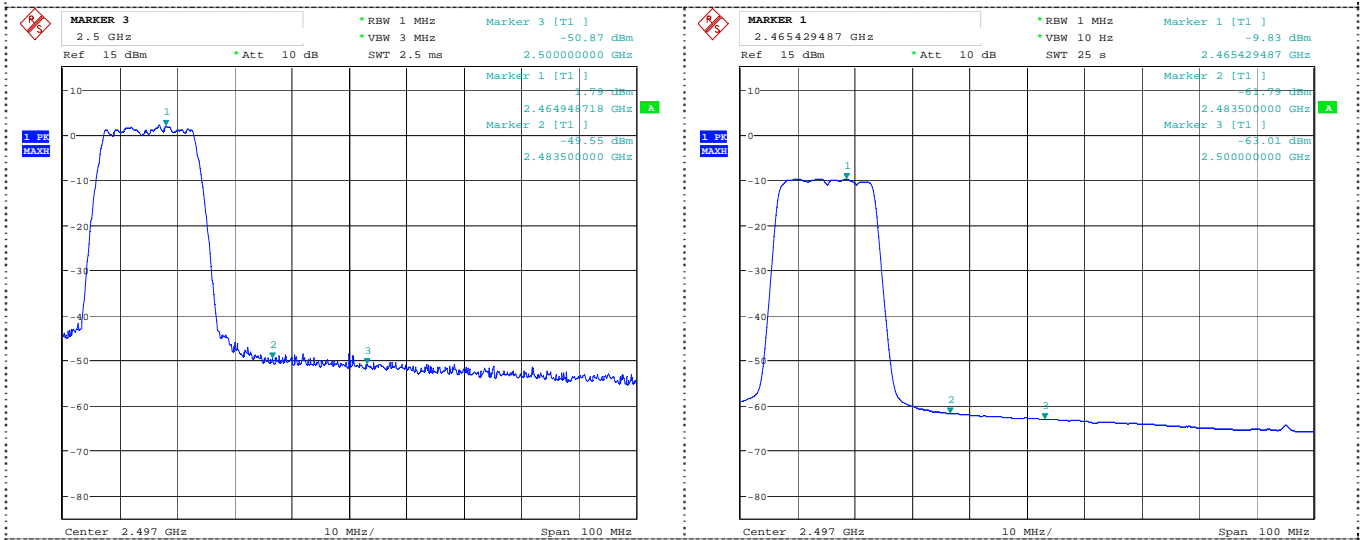

CH 11

802.11n(HT20)						
Frequency (MHz)	Conducted Power (dBm)	Antenna Gain (dBi)	Ground reflection factor(dBi)	Covert Radiated E Level At 3m (dBuV/m)	Detector	Limit (dBuV/m)
2390.00	-48.16	2.00	0	49.10	PK	74.00
2390.00	-60.52	2.00	0	36.74	AV	54.00
2483.50	-49.21	2.00	0	48.05	PK	74.00
2483.50	-63.01	2.00	0	34.25	AV	54.00

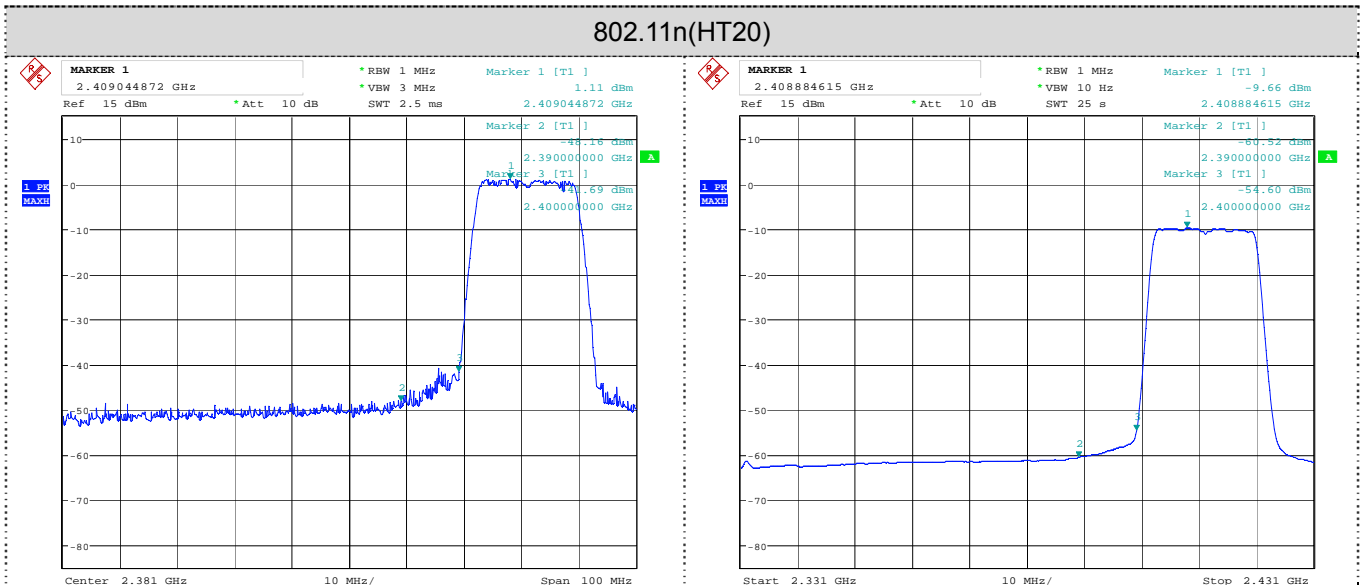

CH 01

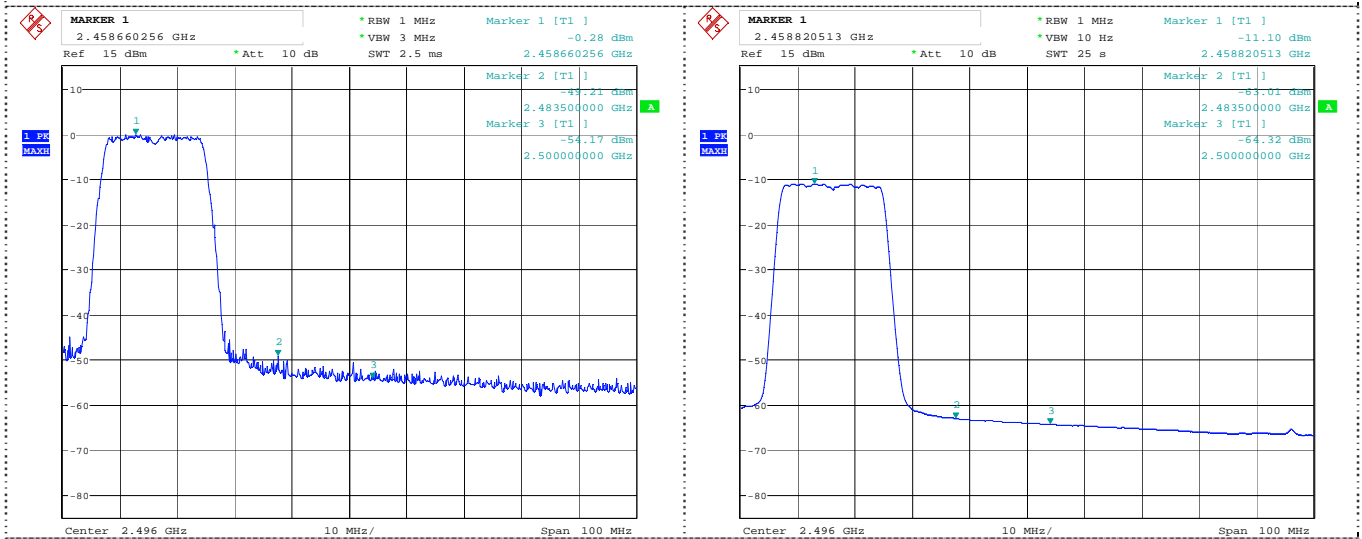

CH 11

802.11n(HT40)						
Frequency (MHz)	Conducted Power (dBm)	Antenna Gain (dBi)	Ground reflection factor(dBi)	Covert Radiated E Level At 3m (dBuV/m)	Detector	Limit (dBuV/m)
2390.00	-48.95	2.00	0	48.31	PK	74.00
2390.00	-60.32	2.00	0	36.94	AV	54.00
2483.50	-53.24	2.00	0	44.02	PK	74.00
2483.50	-63.05	2.00	0	34.21	AV	54.00

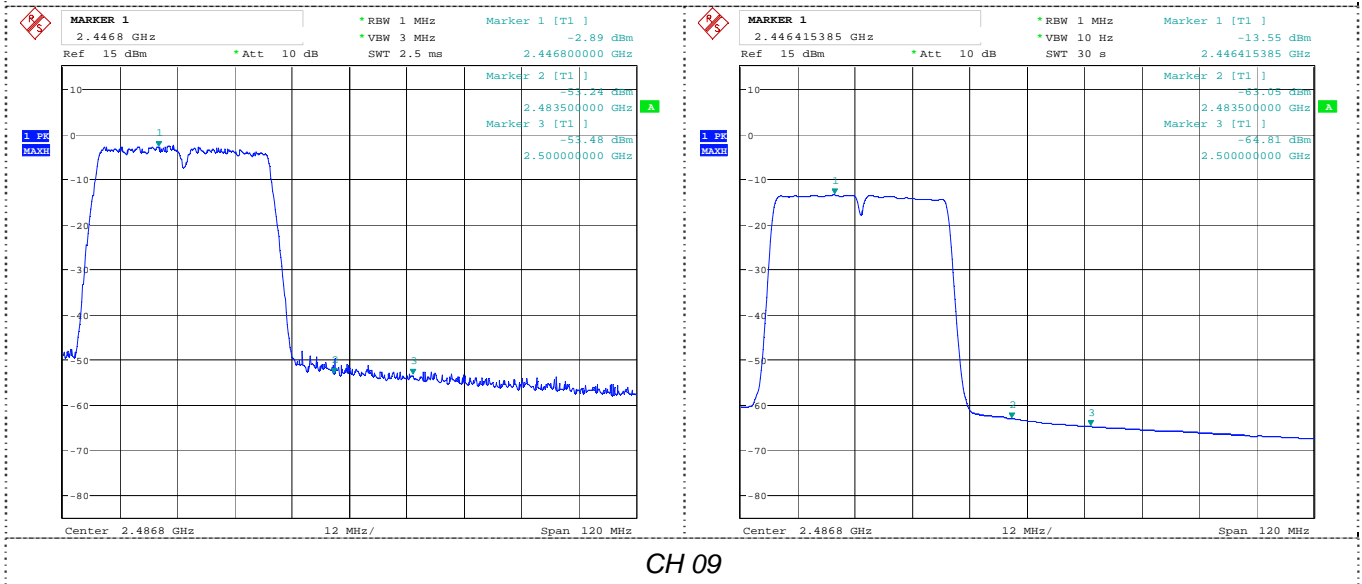
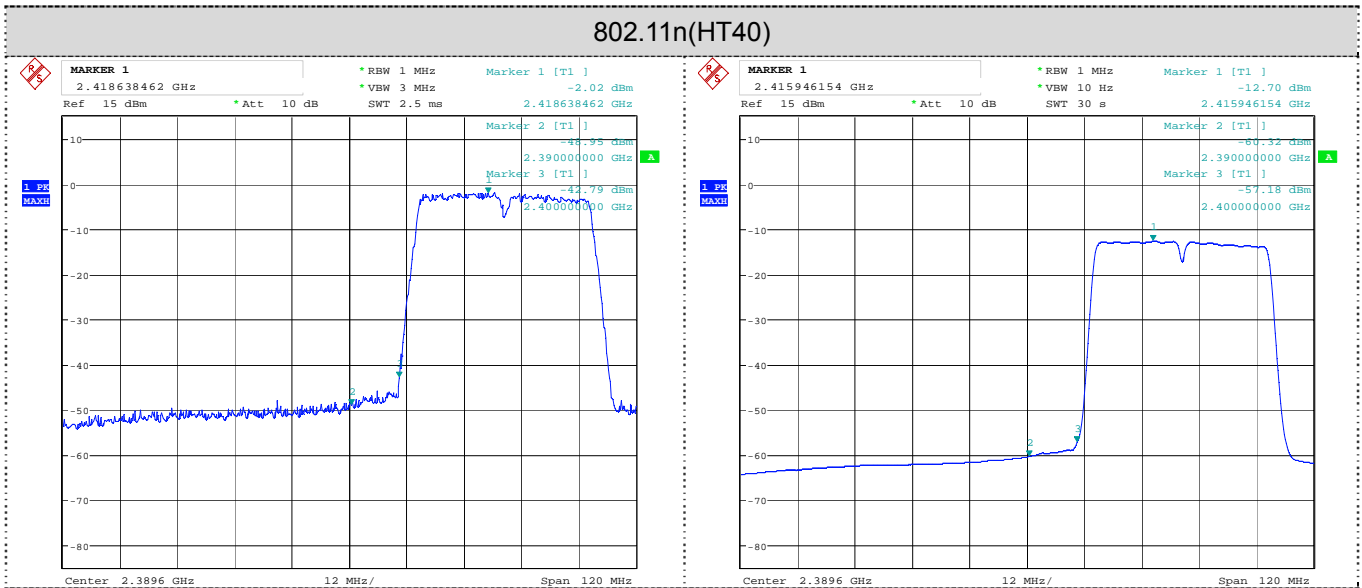

**B. Radiated Emission Band Edge**

**802.11b**

Frequency(MHz):			2412			Polarity:			HORIZONTAL		
Frequency (MHz)	Emission Level (dBuV/m)		Limit (dBuV/m)	Margin (dB)	Antenna Height (m)	Table Angle (Degree)	Raw Value (dBuV)	Antenna Factor (dB/m)	Cable Factor (dB)	Pre-amplifier (dB)	Correction Factor (dB/m)
2390.00	59.26	PK	74.00	14.74	1.00	110	64.57	27.49	3.32	36.12	-5.31
2390.00	43.26	AV	54.00	10.74	1.00	110	48.57	27.49	3.32	36.12	-5.31
Frequency(MHz):			2412			Polarity:			VERTICAL		
Frequency (MHz)	Emission Level (dBuV/m)		Limit (dBuV/m)	Margin (dB)	Antenna Height (m)	Table Angle (Degree)	Raw Value (dBuV)	Antenna Factor (dB/m)	Cable Factor (dB)	Pre-amplifier (dB)	Correction Factor (dB/m)
2390.00	59.79	PK	74.00	14.21	1.00	50	65.10	27.49	3.32	36.12	-5.31
2390.00	45.33	AV	54.00	8.67	1.00	50	50.64	27.49	3.32	36.12	-5.31
Frequency(MHz):			2462			Polarity:			HORIZONTAL		
Frequency (MHz)	Emission Level (dBuV/m)		Limit (dBuV/m)	Margin (dB)	Antenna Height (m)	Table Angle (Degree)	Raw Value (dBuV)	Antenna Factor (dB/m)	Cable Factor (dB)	Pre-amplifier (dB)	Correction Factor (dB/m)
2483.50	59.15	PK	74.00	14.85	1.00	109	64.87	27.45	3.38	36.55	-5.72
2483.50	43.56	AV	54.00	10.44	1.00	109	49.28	27.45	3.38	36.55	-5.72
Frequency(MHz):			2462			Polarity:			VERTICAL		
Frequency (MHz)	Emission Level (dBuV/m)		Limit (dBuV/m)	Margin (dB)	Antenna Height (m)	Table Angle (Degree)	Raw Value (dBuV)	Antenna Factor (dB/m)	Cable Factor (dB)	Pre-amplifier (dB)	Correction Factor (dB/m)
2483.50	59.68	PK	74.00	14.32	1.00	40	65.40	27.45	3.38	36.55	-5.72
2483.50	45.41	AV	54.00	8.59	1.00	40	51.13	27.45	3.38	36.55	-5.72

**802.11g**

Frequency(MHz):			2412			Polarity:			HORIZONTAL		
Frequency (MHz)	Emission Level (dBuV/m)		Limit (dBuV/m)	Margin (dB)	Antenna Height (m)	Table Angle (Degree)	Raw Value (dBuV)	Antenna Factor (dB/m)	Cable Factor (dB)	Pre-amplifier (dB)	Correction Factor (dB/m)
2390.00	65.32	PK	74.00	8.68	1.00	135	70.63	27.49	3.32	36.12	-5.31
2390.00	47.36	AV	54.00	6.64	1.00	135	52.67	27.49	3.32	36.12	-5.31
Frequency(MHz):			2412			Polarity:			VERTICAL		
Frequency (MHz)	Emission Level (dBuV/m)		Limit (dBuV/m)	Margin (dB)	Antenna Height (m)	Table Angle (Degree)	Raw Value (dBuV)	Antenna Factor (dB/m)	Cable Factor (dB)	Pre-amplifier (dB)	Correction Factor (dB/m)
2390.00	66.25	PK	74.00	7.75	1.00	27	71.56	27.49	3.32	36.12	-5.31
2390.00	48.41	AV	54.00	5.59	1.00	27	53.72	27.49	3.32	36.12	-5.31
Frequency(MHz):			2462			Polarity:			HORIZONTAL		
Frequency (MHz)	Emission Level (dBuV/m)		Limit (dBuV/m)	Margin (dB)	Antenna Height (m)	Table Angle (Degree)	Raw Value (dBuV)	Antenna Factor (dB/m)	Cable Factor (dB)	Pre-amplifier (dB)	Correction Factor (dB/m)
2483.50	65.23	PK	74.00	8.77	1.00	49	70.95	27.45	3.38	36.55	-5.72
2483.50	47.15	AV	54.00	6.85	1.00	49	52.87	27.45	3.38	36.55	-5.72
Frequency(MHz):			2462			Polarity:			VERTICAL		
Frequency (MHz)	Emission Level (dBuV/m)		Limit (dBuV/m)	Margin (dB)	Antenna Height (m)	Table Angle (Degree)	Raw Value (dBuV)	Antenna Factor (dB/m)	Cable Factor (dB)	Pre-amplifier (dB)	Correction Factor (dB/m)
2483.50	66.35	PK	74.00	7.65	1.00	125	72.07	27.45	3.38	36.55	-5.72
2483.50	48.47	AV	54.00	5.53	1.00	125	54.19	27.45	3.38	36.55	-5.72

**802.11n20**

Frequency(MHz):			2412			Polarity:			HORIZONTAL		
Frequency (MHz)	Emission Level (dBuV/m)		Limit (dBuV/m)	Margin (dB)	Antenna Height (m)	Table Angle (Degree)	Raw Value (dBuV)	Antenna Factor (dB/m)	Cable Factor (dB)	Pre-amplifier (dB)	Correction Factor (dB/m)
2390.00	65.35	PK	74.00	8.65	1.00	140	70.66	27.49	3.32	36.12	-5.31
2390.00	46.98	AV	54.00	7.02	1.00	140	52.29	27.49	3.32	36.12	-5.31
Frequency(MHz):			2412			Polarity:			VERTICAL		
Frequency (MHz)	Emission Level (dBuV/m)		Limit (dBuV/m)	Margin (dB)	Antenna Height (m)	Table Angle (Degree)	Raw Value (dBuV)	Antenna Factor (dB/m)	Cable Factor (dB)	Pre-amplifier (dB)	Correction Factor (dB/m)
2390.00	67.58	PK	74.00	6.42	1.00	55	72.89	27.49	3.32	36.12	-5.31
2390.00	49.65	AV	54.00	4.35	1.00	55	54.96	27.49	3.32	36.12	-5.31
Frequency(MHz):			2462			Polarity:			HORIZONTAL		
Frequency (MHz)	Emission Level (dBuV/m)		Limit (dBuV/m)	Margin (dB)	Antenna Height (m)	Table Angle (Degree)	Raw Value (dBuV)	Antenna Factor (dB/m)	Cable Factor (dB)	Pre-amplifier (dB)	Correction Factor (dB/m)
2483.50	66.32	PK	74.00	7.68	1.00	135	72.04	27.45	3.38	36.55	-5.72
2483.50	47.57	AV	54.00	6.43	1.00	135	53.29	27.45	3.38	36.55	-5.72
Frequency(MHz):			2462			Polarity:			VERTICAL		
Frequency (MHz)	Emission Level (dBuV/m)		Limit (dBuV/m)	Margin (dB)	Antenna Height (m)	Table Angle (Degree)	Raw Value (dBuV)	Antenna Factor (dB/m)	Cable Factor (dB)	Pre-amplifier (dB)	Correction Factor (dB/m)
2483.50	66.40	PK	74.00	7.60	1.00	44	72.12	27.45	3.38	36.55	-5.72
2483.50	47.89	AV	54.00	6.11	1.00	44	53.61	27.45	3.38	36.55	-5.72

**802.11n40**

Frequency(MHz):			2422			Polarity:			HORIZONTAL		
Frequency (MHz)	Emission Level (dBuV/m)		Limit (dBuV/m)	Margin (dB)	Antenna Height (m)	Table Angle (Degree)	Raw Value (dBuV)	Antenna Factor (dB/m)	Cable Factor (dB)	Pre-amplifier (dB)	Correction Factor (dB/m)
2390.00	65.45	PK	74.00	6.42	1.00	138	72.89	27.49	3.32	36.12	-5.31
2390.00	46.74	AV	54.00	4.35	1.00	138	54.96	27.49	3.32	36.12	-5.31
Frequency(MHz):			2422			Polarity:			VERTICAL		
Frequency (MHz)	Emission Level (dBuV/m)		Limit (dBuV/m)	Margin (dB)	Antenna Height (m)	Table Angle (Degree)	Raw Value (dBuV)	Antenna Factor (dB/m)	Cable Factor (dB)	Pre-amplifier (dB)	Correction Factor (dB/m)
2390.00	66.39	PK	74.00	7.61	1.00	115	71.70	27.49	3.32	36.12	-5.31
2390.00	48.14	AV	54.00	5.86	1.00	115	53.45	27.49	3.32	36.12	-5.31
Frequency(MHz):			2452			Polarity:			HORIZONTAL		
Frequency (MHz)	Emission Level (dBuV/m)		Limit (dBuV/m)	Margin (dB)	Antenna Height (m)	Table Angle (Degree)	Raw Value (dBuV)	Antenna Factor (dB/m)	Cable Factor (dB)	Pre-amplifier (dB)	Correction Factor (dB/m)
2483.50	66.45	PK	74.00	7.55	1.00	35	72.17	27.45	3.38	36.55	-5.72
2483.50	47.58	AV	54.00	6.42	1.00	35	53.30	27.45	3.38	36.55	-5.72
Frequency(MHz):			2452			Polarity:			VERTICAL		
Frequency (MHz)	Emission Level (dBuV/m)		Limit (dBuV/m)	Margin (dB)	Antenna Height (m)	Table Angle (Degree)	Raw Value (dBuV)	Antenna Factor (dB/m)	Cable Factor (dB)	Pre-amplifier (dB)	Correction Factor (dB/m)
2483.50	66.52	PK	74.00	7.48	1.00	150	72.24	27.45	3.38	36.55	-5.72
2483.50	47.74	AV	54.00	6.26	1.00	150	53.46	27.45	3.38	36.55	-5.72

### 3.7. Spurious RF Conducted Emission

#### Limit

1. Below -20dB of the highest emission level in operating band.
2. Fall in the restricted bands listed in section 15.205. The maximum permitted average field strength is listed in section 15.209.

#### Test Procedure

The Spurious RF conducted emissions compliance of RF radiated emission should be measured by following the guidance in ANSI C63.10-2009 with respect to maximizing the emission by rotating the EUT, measuring the emission while the EUT is situated in three orthogonal planes (if appropriate), adjusting the measurement antenna height and polarization etc. Set RBW=100 kHz and VBM= 300 KHz to measure the peak field strength, and measured frequency range from 30MHz to 26.5GHz.

#### Test Configuration

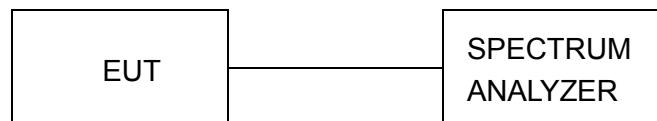

#### Test Results

Remark: The measurement frequency range is from 30MHz to the 10th harmonic of the fundamental frequency. The lowest, middle and highest channels are tested to verify the spurious emissions and bandage measurement data.

Test plot as follows:



**Test Mode:** 802.11b **Test channel :** 01

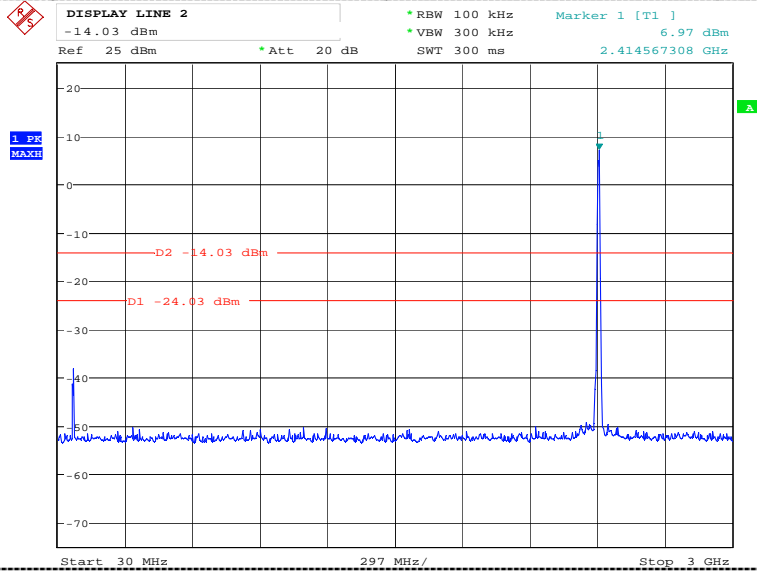

**30MHz~3GHz**

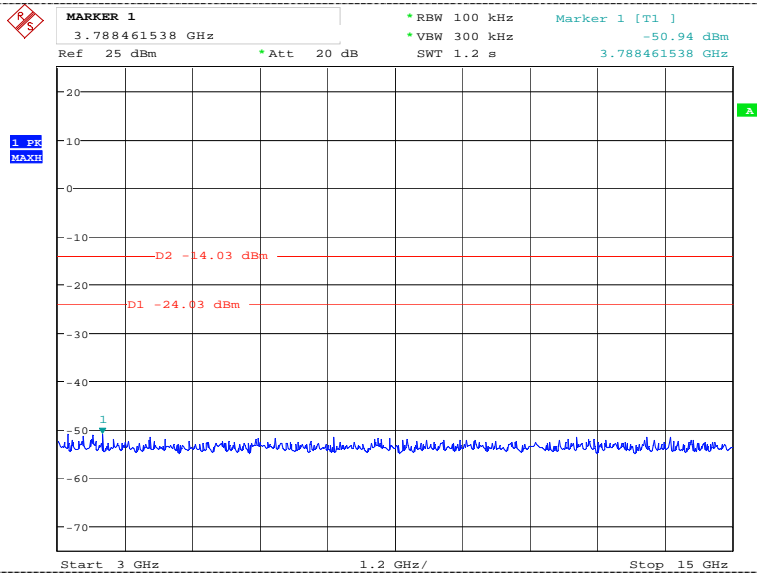

**3GHz~15GHz**

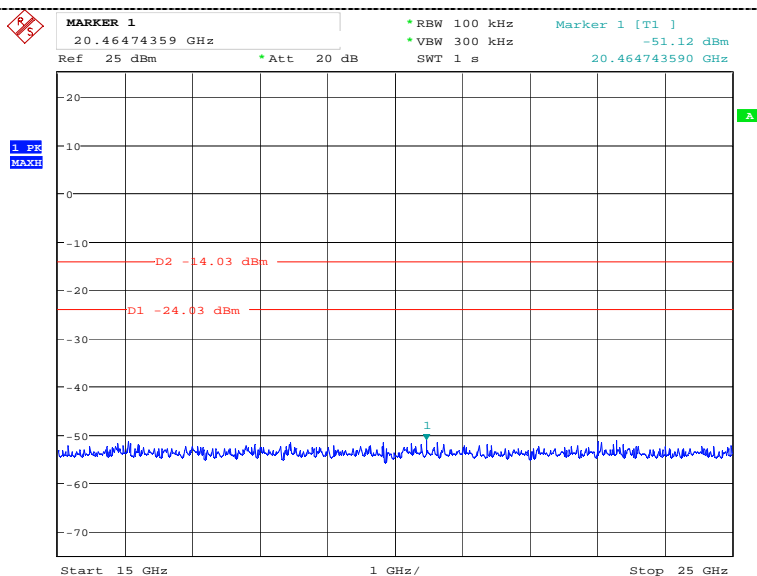

**15GHz~25GHz**



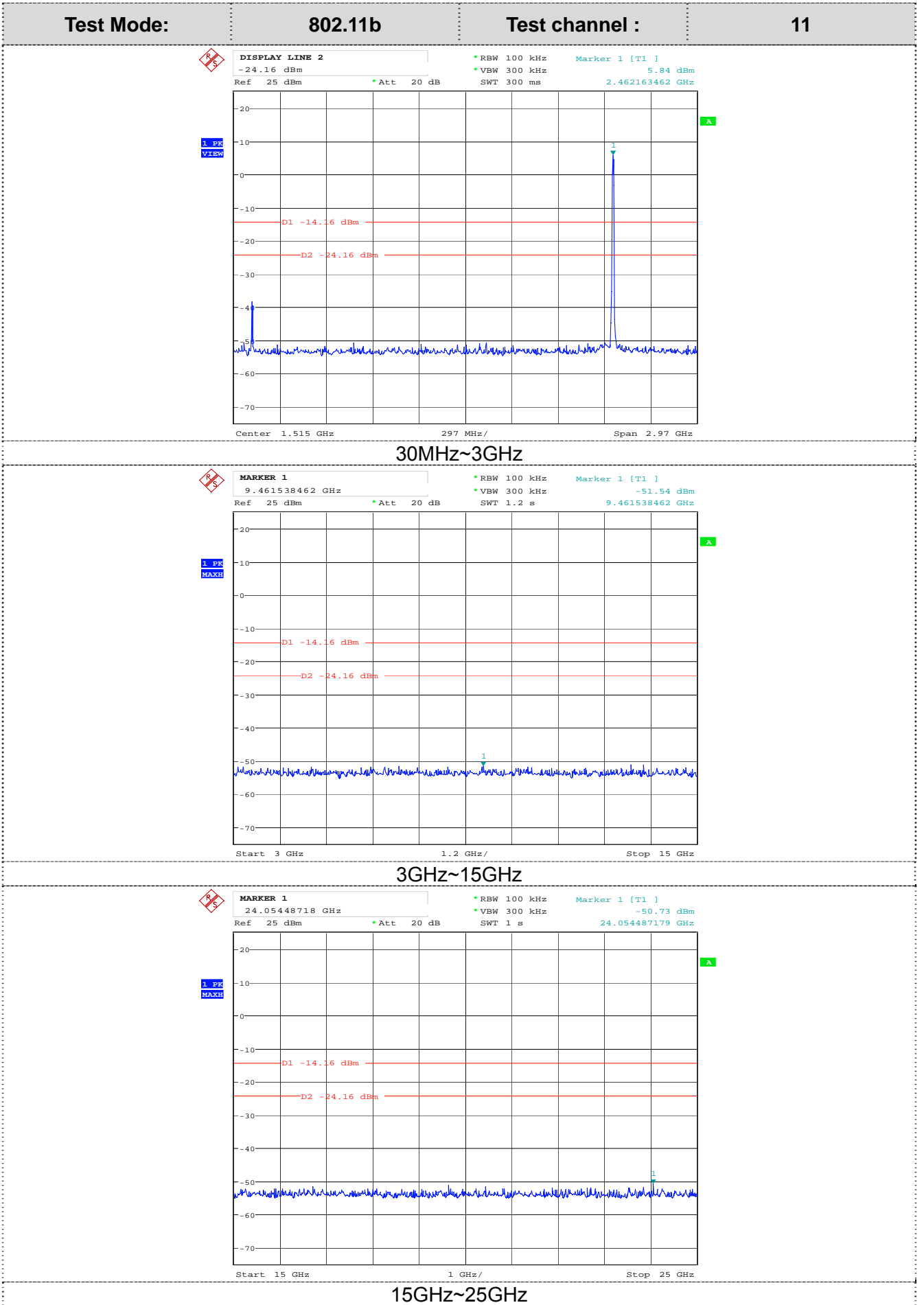

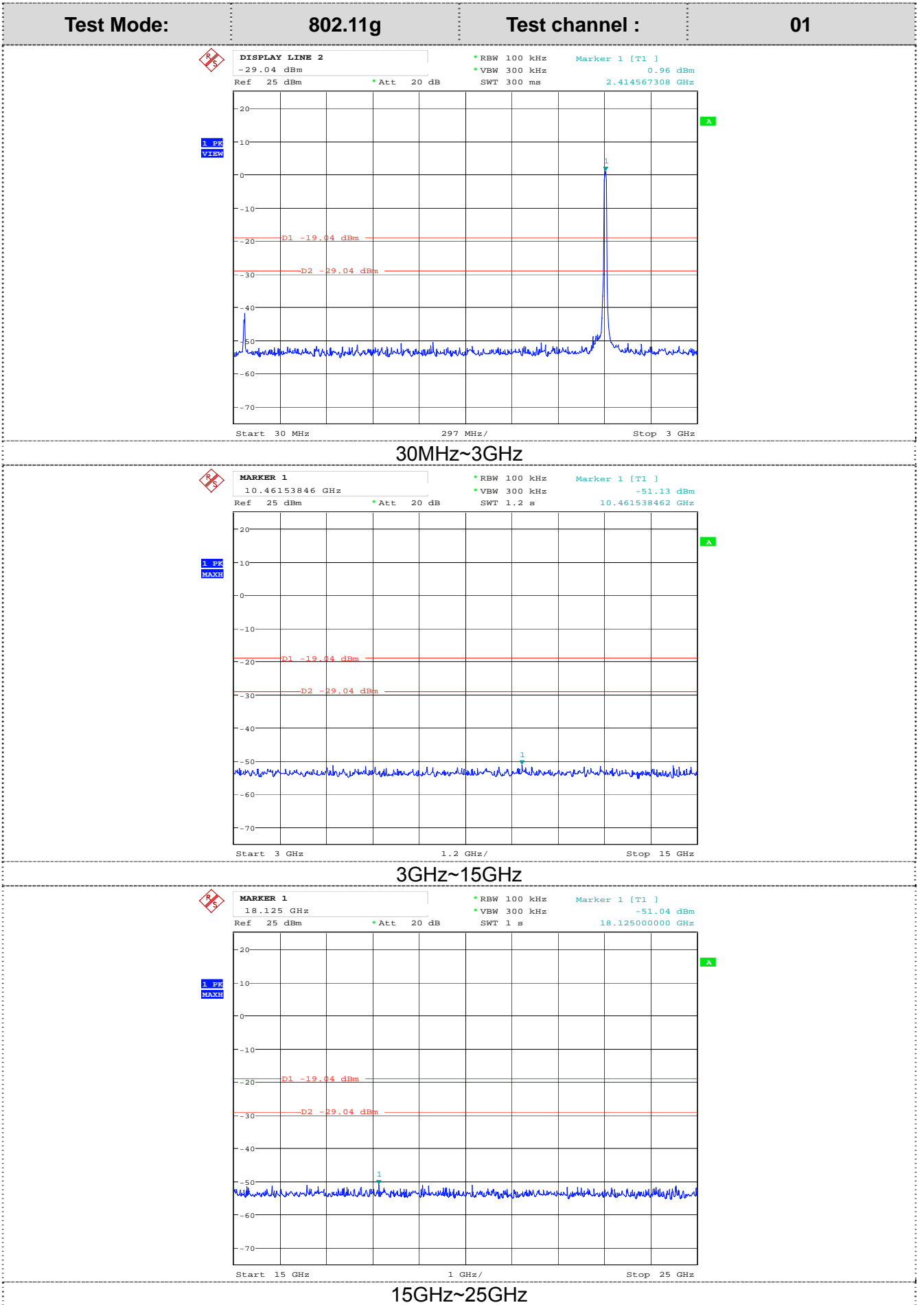

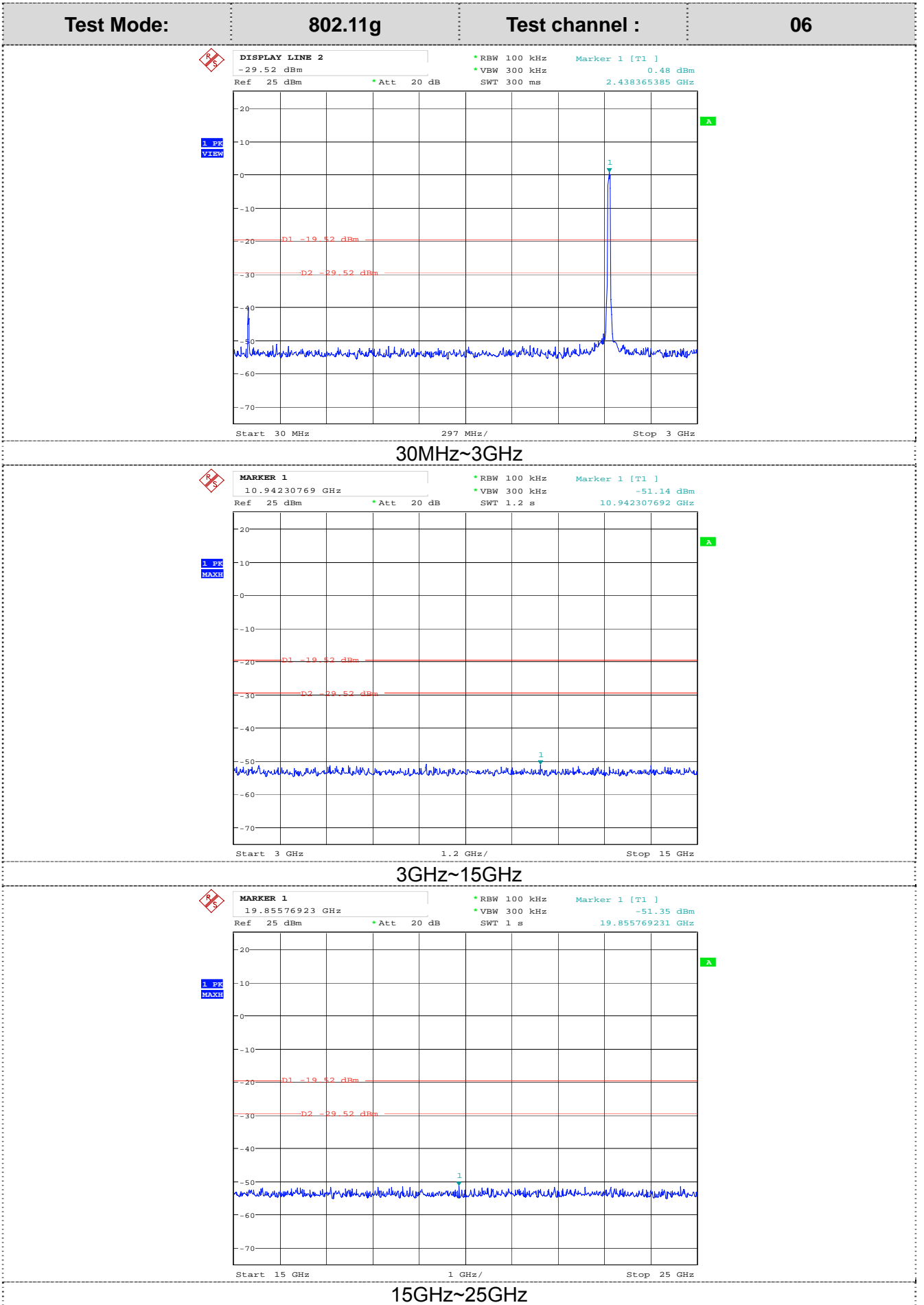

Test Mode:

802.11g

Test channel :

11

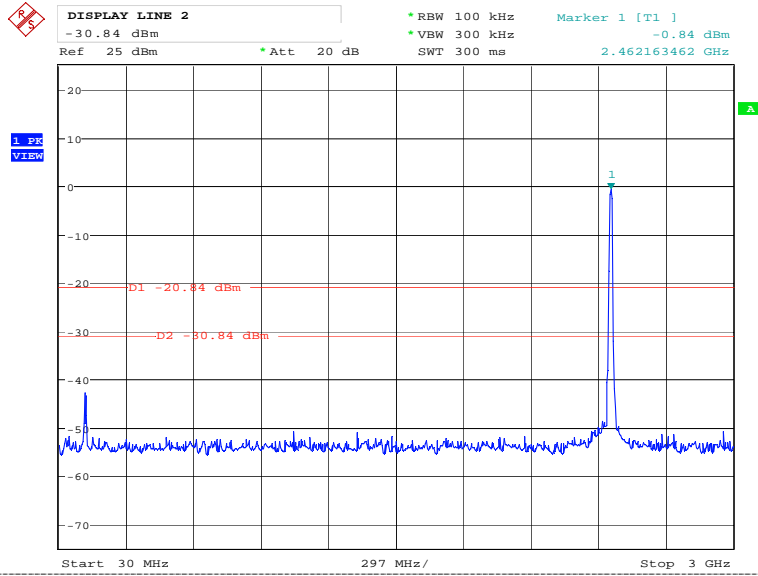

30MHz~3GHz

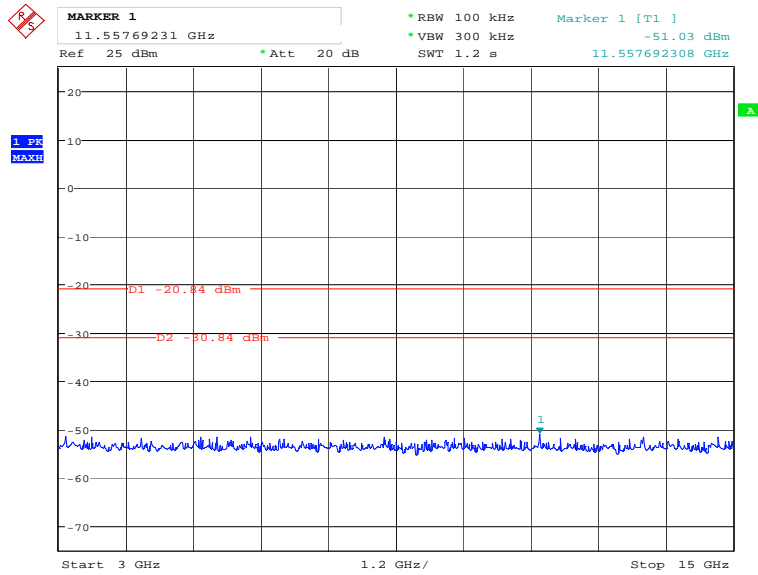

3GHz~15GHz

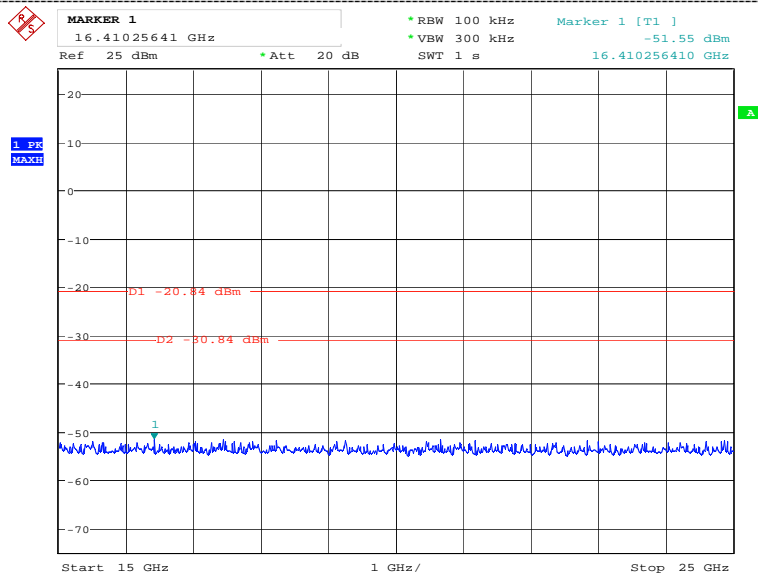

15GHz~25GHz

Test Mode:

802.11n(HT20)

Test channel :

01

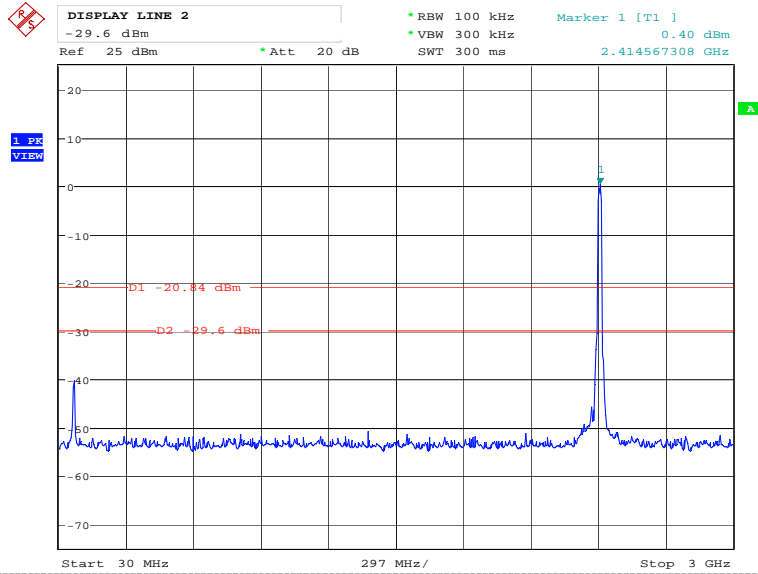

30MHz~3GHz

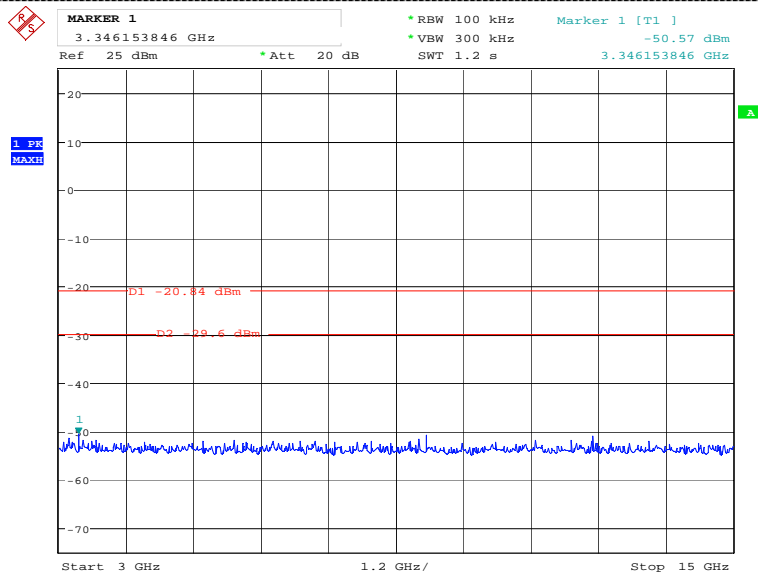

3GHz~15GHz

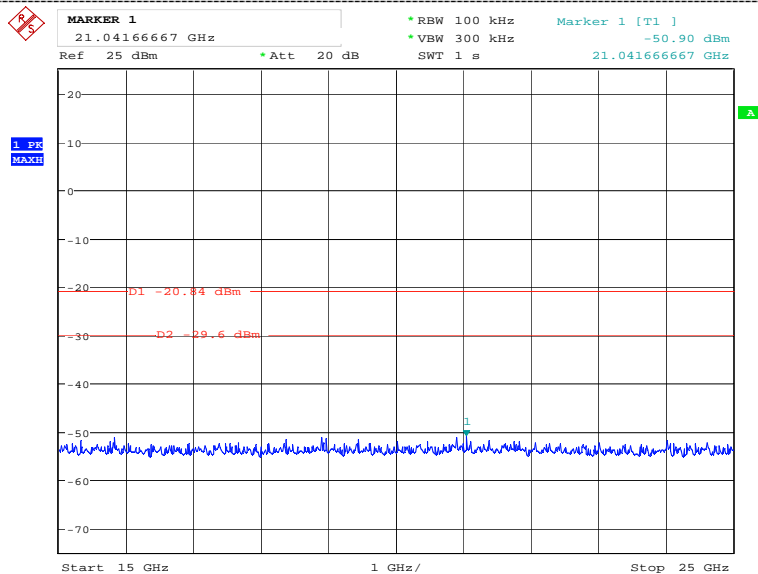

15GHz~25GHz

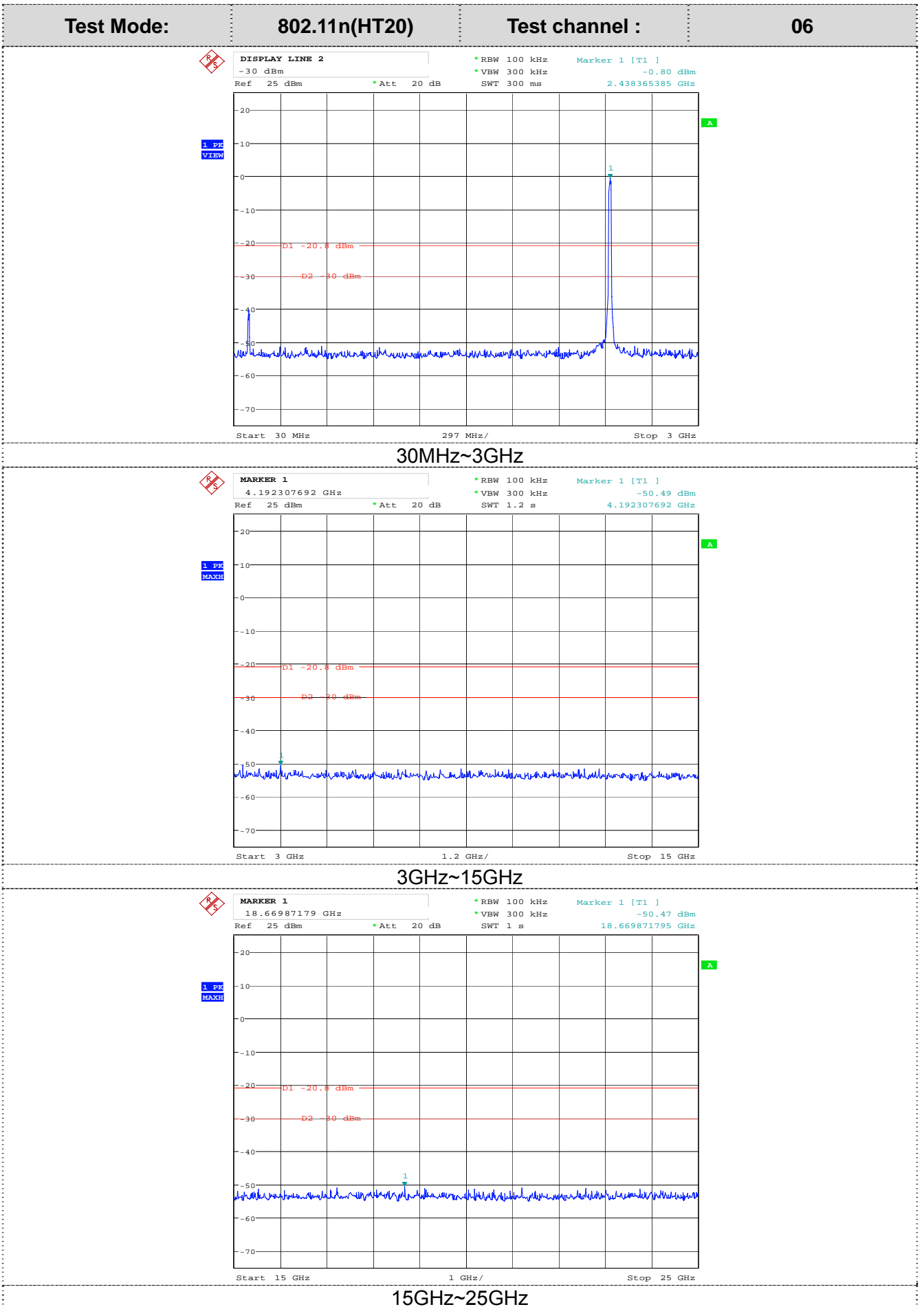



Test Mode:

802.11n(HT20)

Test channel :

11

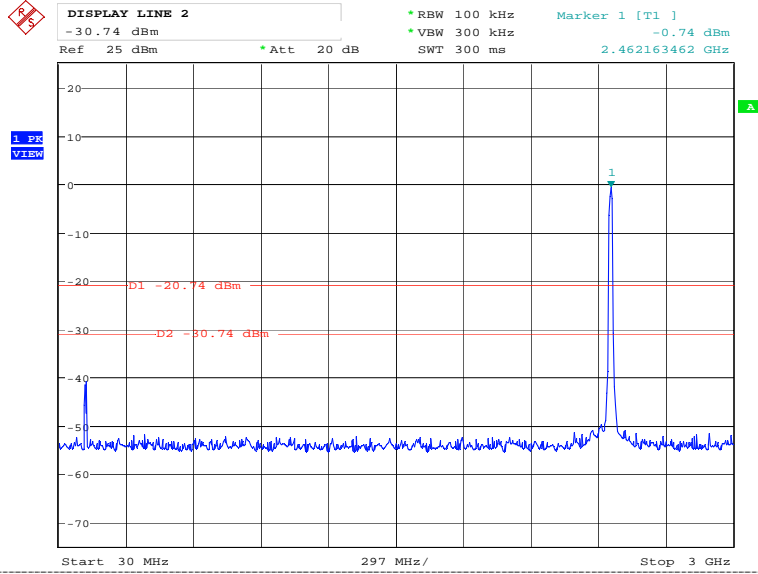

30MHz~3GHz

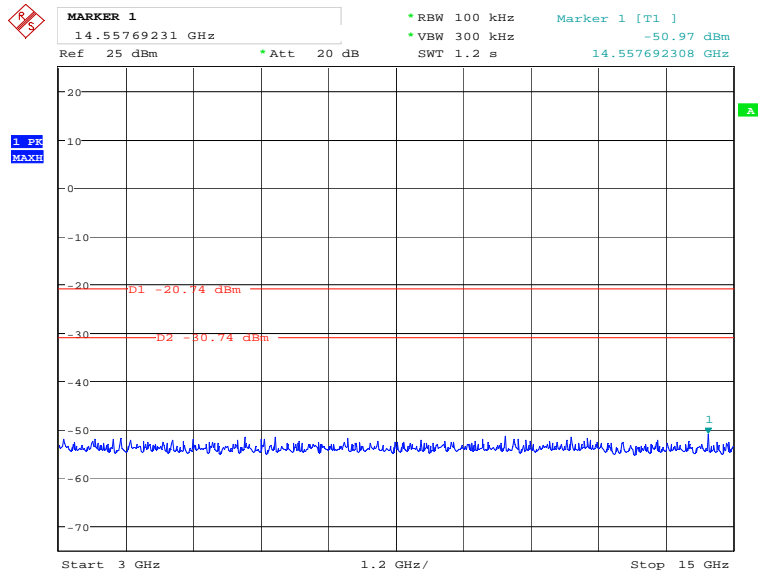

3GHz~15GHz

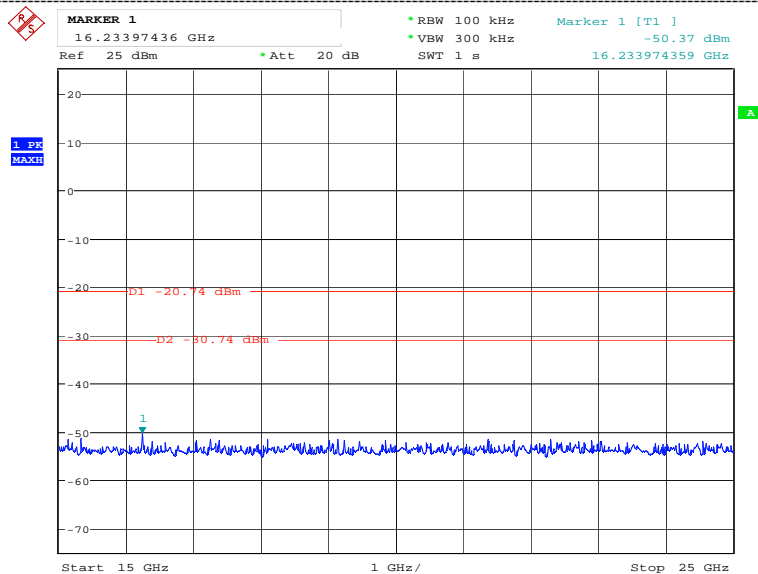

15GHz~25GHz

Test Mode:

802.11n(HT40)

Test channel :

03

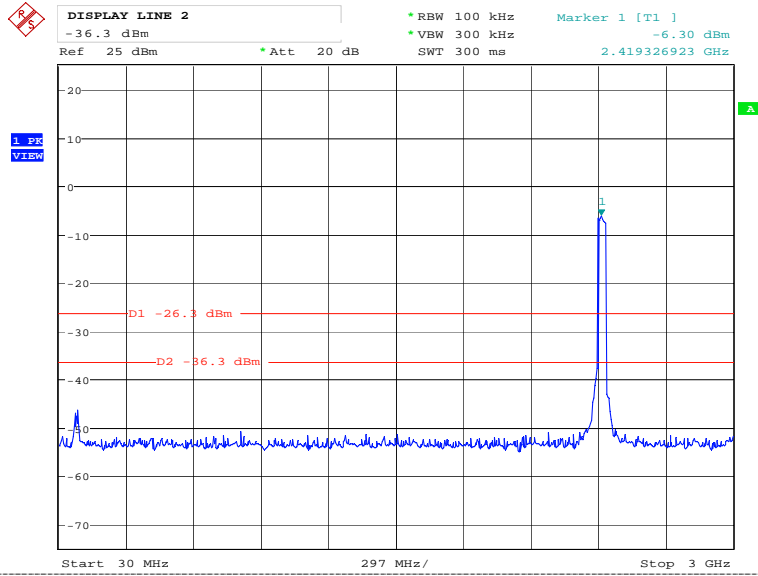

30MHz~3GHz

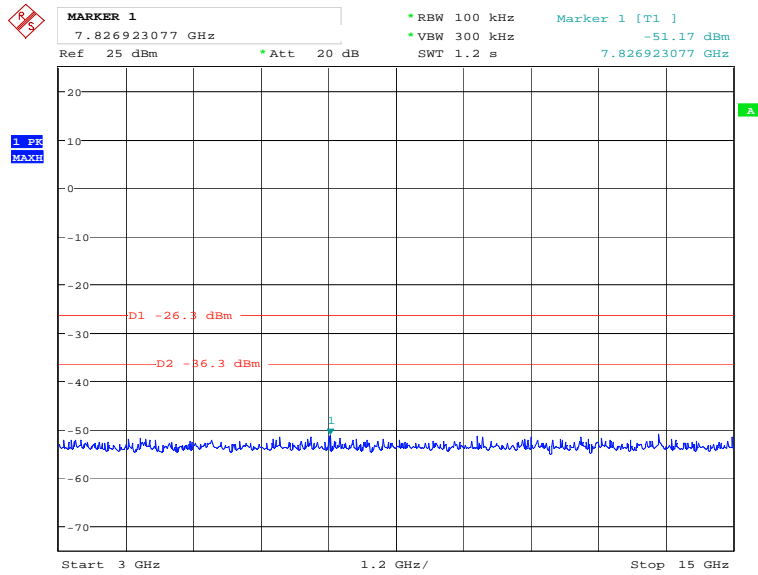

3GHz~15GHz

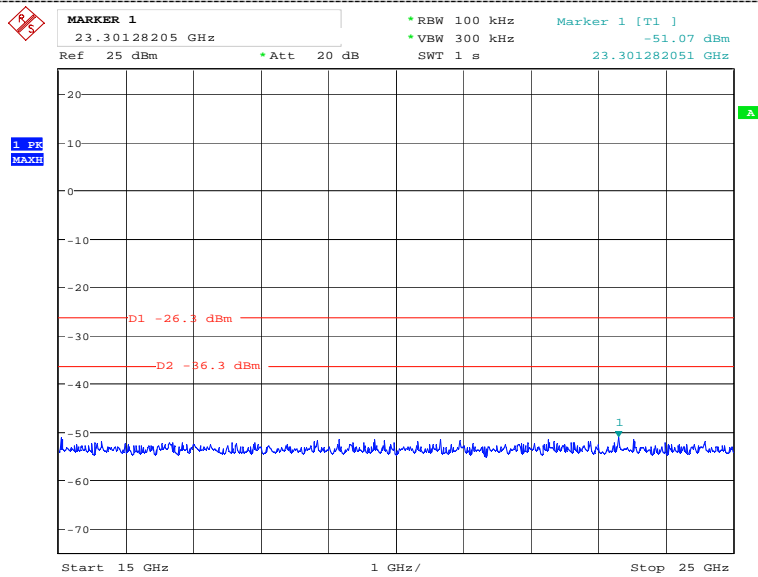

15GHz~25GHz

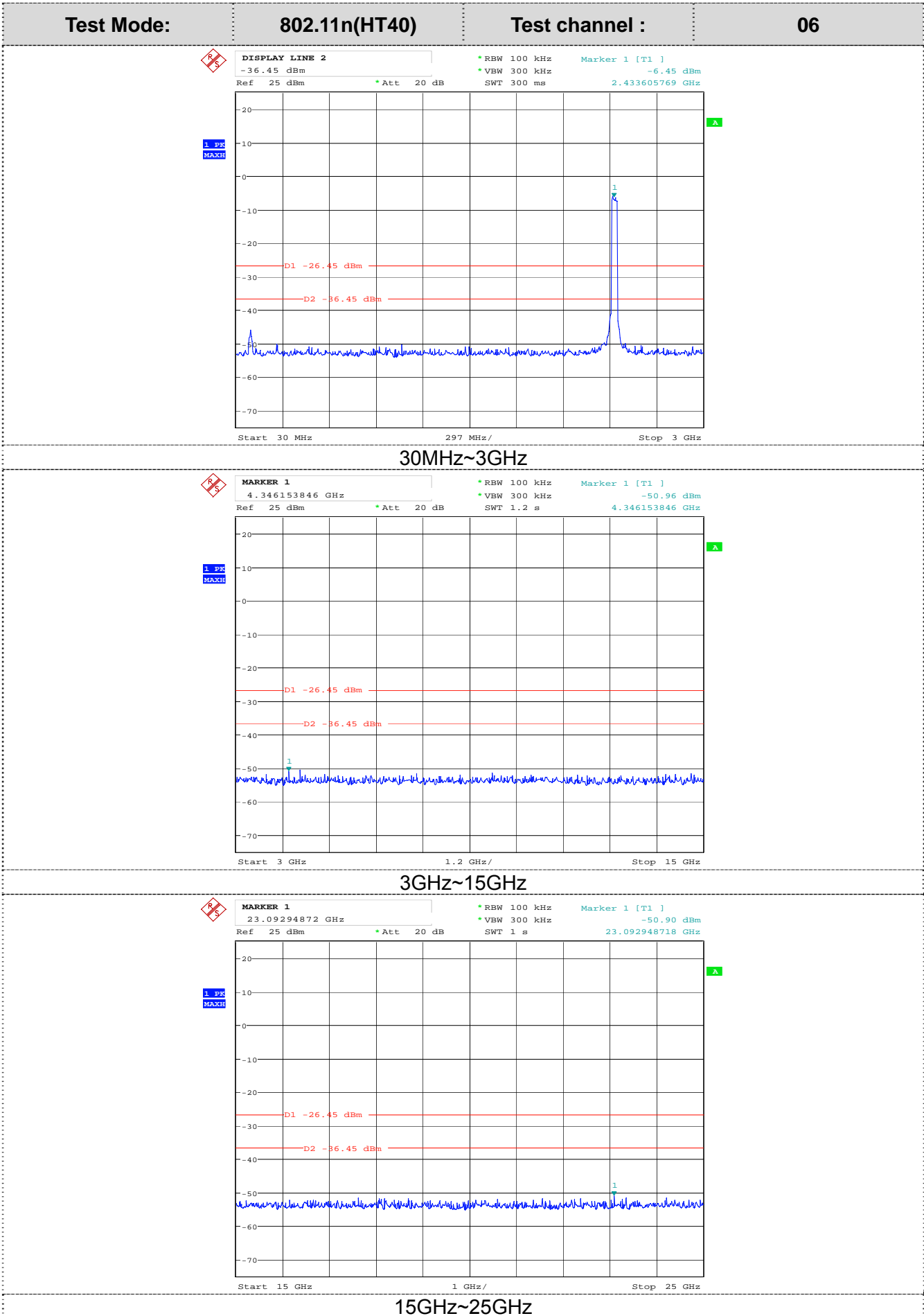

Test Mode:

802.11n(HT40)

Test channel :

09

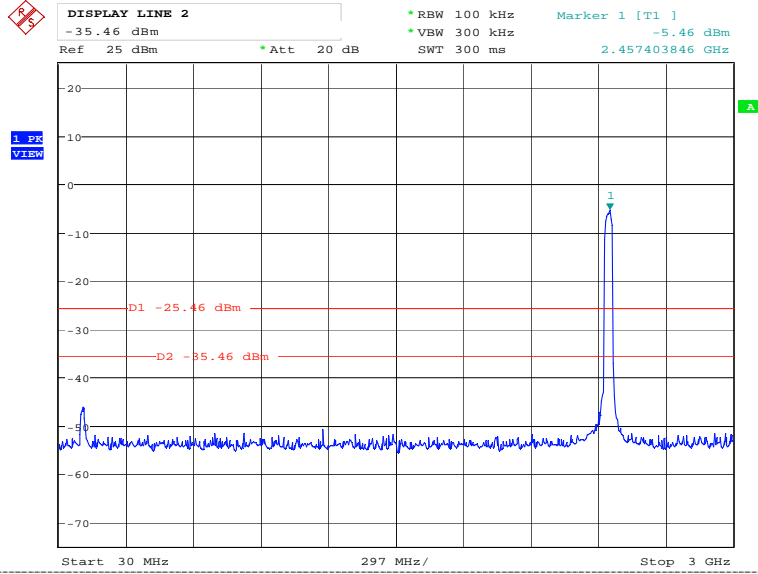

30MHz~3GHz

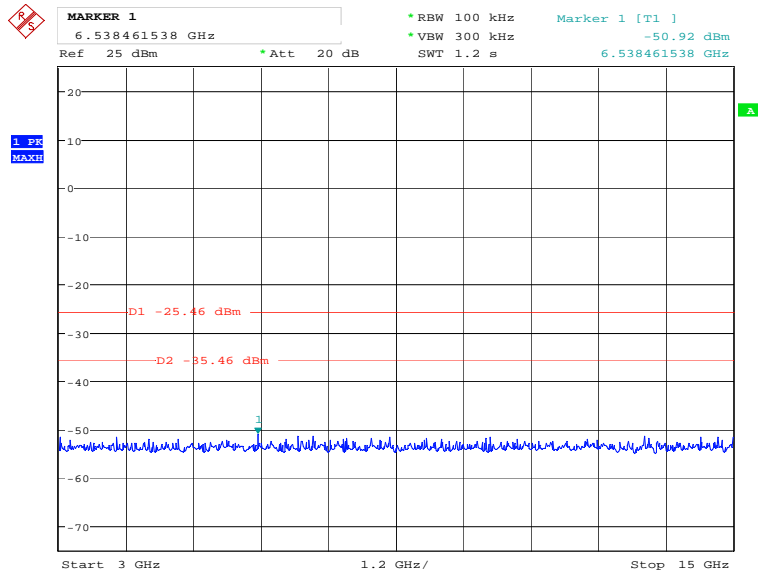

3GHz~15GHz

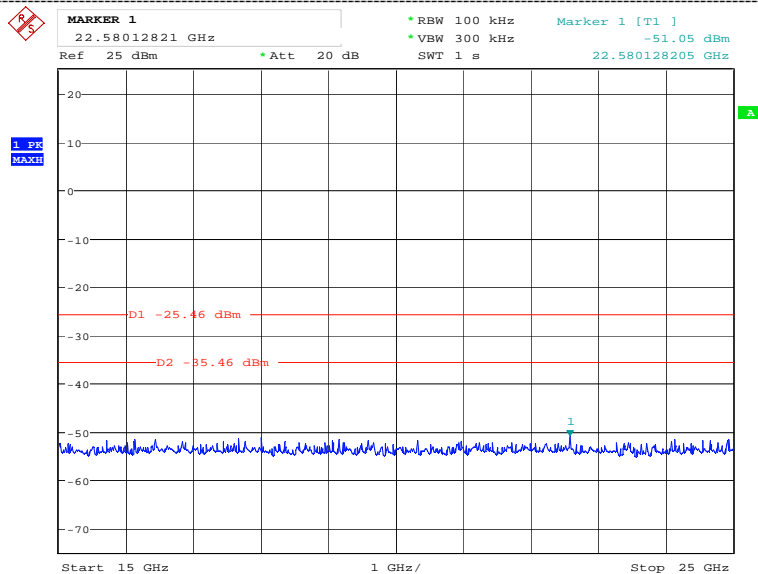

15GHz~25GHz

### 3.8. Antenna Requirement

#### Standard Applicable

**For intentional device, according to FCC 47 CFR Section 15.203:**

An intentional radiator shall be designed to ensure that no antenna other than that furnished by the responsible party shall be used with the device. The use of a permanently attached antenna or of an antenna that uses a unique coupling to the intentional radiator, the manufacturer may design the unit so that a broken antenna can be replaced by the user, but the use of a standard antenna jack or electrical connector is prohibited

**FCC CFR Title 47 Part 15 Subpart C Section 15.247(c) (1) (I):**

(i) Systems operating in the 2400-2483.5 MHz band that is used exclusively for fixed. Point-to-point operations may employ transmitting antennas with directional gain greater than 6dBi provided the maximum conducted output power of the intentional radiator is reduced by 1 dB for every 3 dB that the directional gain of the antenna exceeds 6dBi.

#### Test Result:

The antenna is FPCB antenna; the best case gain of the antenna is 2.0dBi



## 4. EUT TEST PHOTO

Radiated Emission (30MHz-1GHz)



Radiated Emission (1GHz-25GHz)

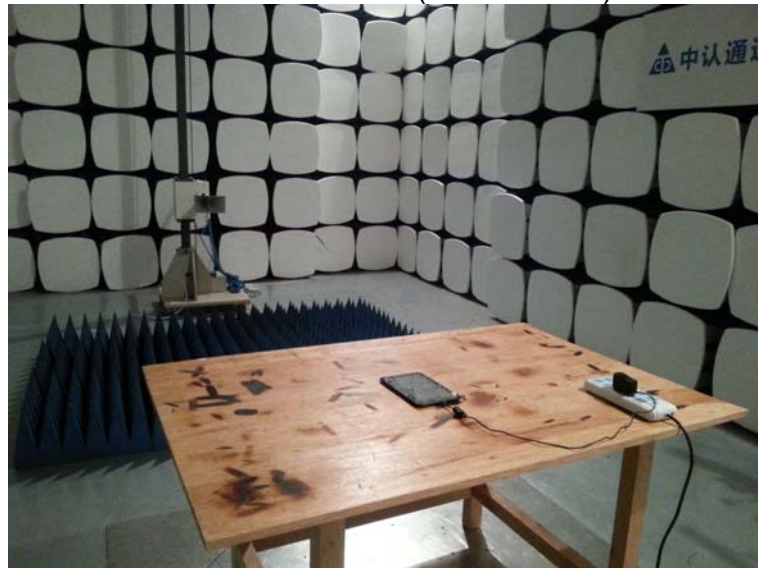

Conducted Emission





# 5. PHOTOGRAPHS OF EUT CONSTRUCTIONAL

## External Photos of EUT









### Internal Photos of EUT

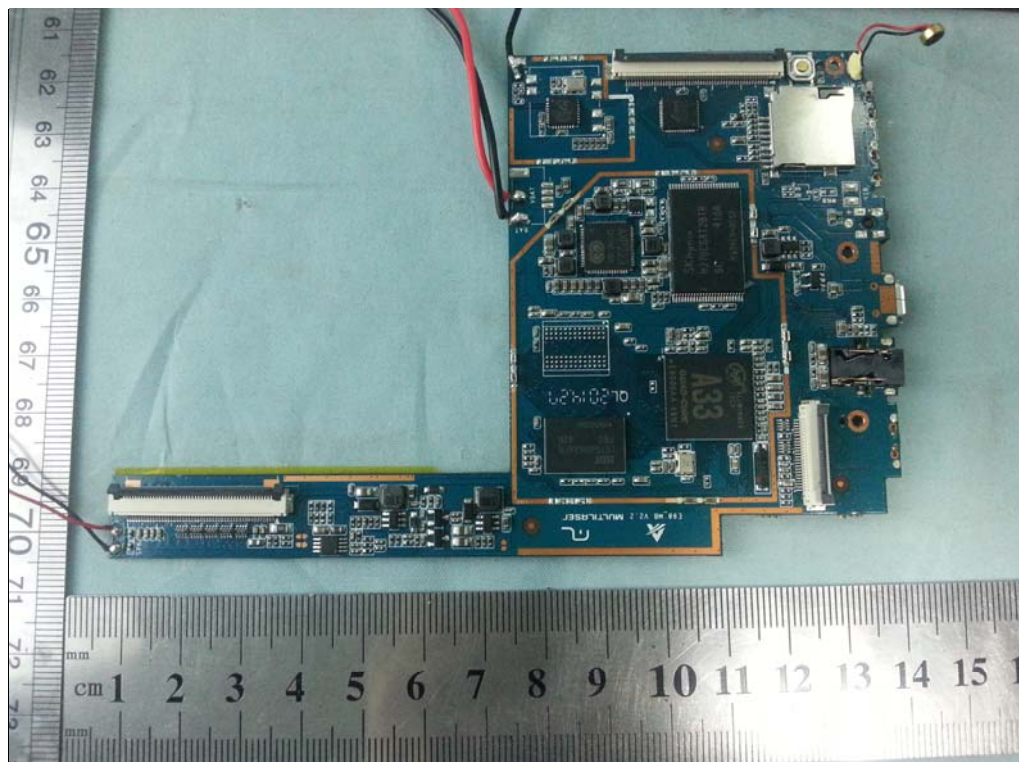
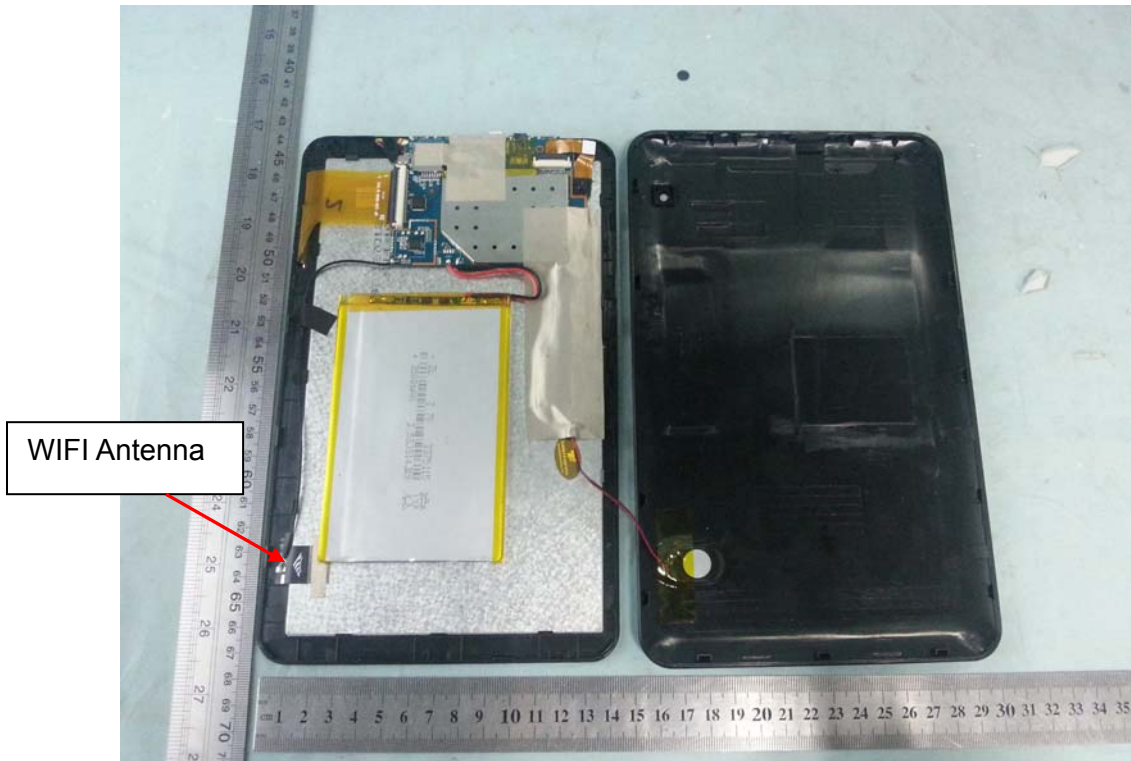

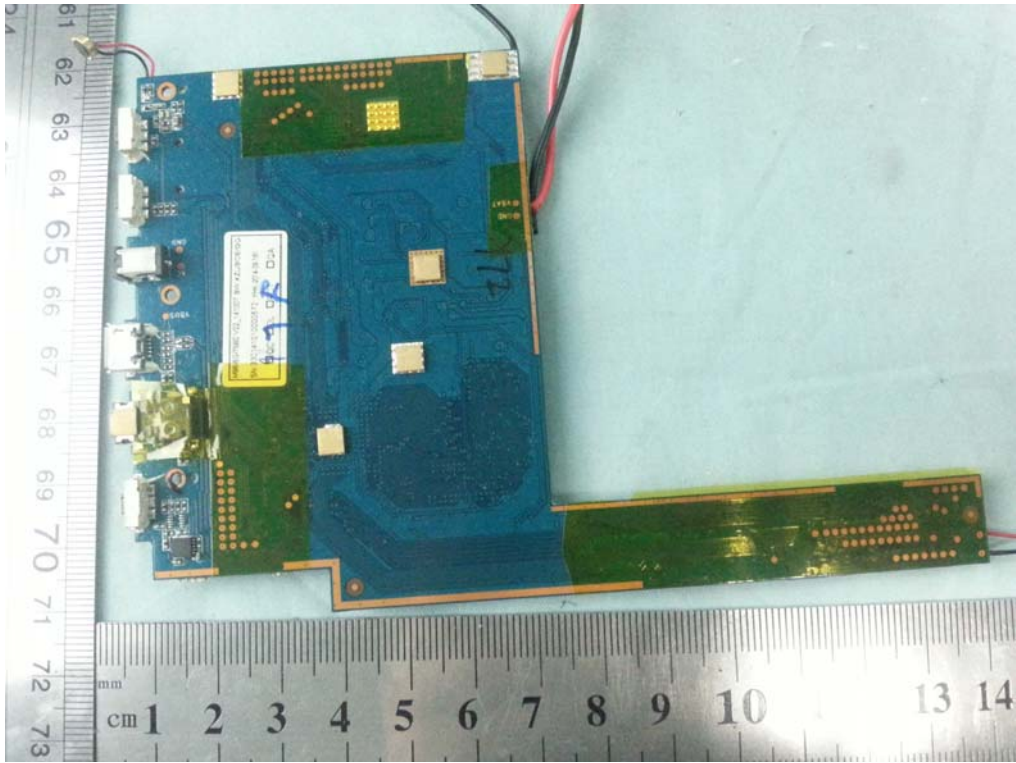

\*\*\*\*\*THE END\*\*\*\*\*