

TEST REPORT

Product : 7.85"Tablet PC
Trade mark : DragonTouch, KINGPAD, KINGSLIM, AKASO
Model/Type reference : X80, X8, X80 PLUS, X80 PRO, X8 PLUS,
X8 PRO, X8 KIDS, X80 KIDS
Serial Number : N/A
Report Number : EED32I00298702
FCC ID : S5V-D08X80
Date of Issue : Feb. 08, 2017
Test Standards : 47 CFR Part 15 Subpart C (2015)
Test result : PASS

Prepared for:

Proexpress Distributor LLC

**11011 Greenwood Ave N 11011 Greenwood Ave N, Seattle Washington
United States**

Prepared by:

**Centre Testing International Group Co., Ltd.
Hongwei Industrial Zone, Bao'an 70 District,
Shenzhen, Guangdong, China**

TEL: +86-755-3368 3668

FAX: +86-755-3368 3385

Compiled by:

Ware Xin

Reviewed by:

Jon King

Approved by:

Sheek Luo

Date:

Feb. 08, 2017

Sheek Luo

Lab supervisor

Check No.: 2496574422



2 Version

Version No.	Date	Description
00	Feb. 08, 2017	Original

3 Test Summary

Test Item	Test Requirement	Test method	Result
Antenna Requirement	47 CFR Part 15 Subpart C Section 15.203/15.247 (c)	ANSI C63.10-2013	PASS
AC Power Line Conducted Emission	47 CFR Part 15 Subpart C Section 15.207	ANSI C63.10-2013	PASS
Conducted Peak Output Power	47 CFR Part 15 Subpart C Section 15.247 (b)(3)	ANSI C63.10-2013	PASS
6dB Occupied Bandwidth	47 CFR Part 15 Subpart C Section 15.247 (a)(2)	ANSI C63.10-2013	PASS
Power Spectral Density	47 CFR Part 15 Subpart C Section 15.247 (e)	ANSI C63.10-2013	PASS
Band-edge for RF Conducted Emissions	47 CFR Part 15 Subpart C Section 15.247(d)	ANSI C63.10-2013	PASS
RF Conducted Spurious Emissions	47 CFR Part 15 Subpart C Section 15.247(d)	ANSI C63.10-2013	PASS
Radiated Spurious Emissions	47 CFR Part 15 Subpart C Section 15.205/15.209	ANSI C63.10-2013	PASS
Restricted bands around fundamental frequency (Radiated Emission)	47 CFR Part 15 Subpart C Section 15.205/15.209	ANSI C63.10-2013	PASS

Remark:

Test according to ANSI C63.4-2014 & ANSI C63.10-2013.

The tested sample and the sample information are provided by the client.

Model No.: X80, X8, X80 PLUS, X80 PRO, X8 PLUS, X8 PRO, X8 KIDS, X80 KIDS

Only the model X80 was tested, since the PCB, Schematic, Hardware etc were identical for the above models, X80, X8, X80 PLUS, X80 PRO, X8 PLUS, X8 PRO, X8 KIDS, X80 KIDS are named differently due to difference agent and marketing purposes.

4 Content

1 COVER PAGE	1
2 VERSION	2
3 TEST SUMMARY	3
4 CONTENT	4
5 TEST REQUIREMENT	5
5.1 TEST SETUP.....	5
5.1.1 For Conducted test setup.....	5
5.1.2 For Radiated Emissions test setup.....	5
5.1.3 For Conducted Emissions test setup.....	6
5.2 TEST ENVIRONMENT.....	6
5.3 TEST CONDITION.....	6
6 GENERAL INFORMATION	8
6.1 CLIENT INFORMATION.....	8
6.2 GENERAL DESCRIPTION OF EUT.....	8
6.3 PRODUCT SPECIFICATION SUBJECTIVE TO THIS STANDARD.....	8
6.4 DESCRIPTION OF SUPPORT UNITS.....	9
6.5 TEST LOCATION.....	9
6.6 TEST FACILITY.....	9
6.7 DEVIATION FROM STANDARDS.....	10
6.8 ABNORMALITIES FROM STANDARD CONDITIONS.....	10
6.9 OTHER INFORMATION REQUESTED BY THE CUSTOMER.....	10
6.10 MEASUREMENT UNCERTAINTY (95% CONFIDENCE LEVELS, K=2).....	10
7 EQUIPMENT LIST	11
8 RADIO TECHNICAL REQUIREMENTS SPECIFICATION	13
Appendix A): Conducted Peak Output Power.....	14
Appendix B): 6dB Occupied Bandwidth.....	19
Appendix C): Band-edge for RF Conducted Emissions.....	24
Appendix D): RF Conducted Spurious Emissions.....	27
Appendix E): Power Spectral Density.....	36
Appendix F): Antenna Requirement.....	41
Appendix G): AC Power Line Conducted Emission.....	42
Appendix H): Restricted bands around fundamental frequency (Radiated).....	45
Appendix I): Radiated Spurious Emissions.....	54
PHOTOGRAPHS OF TEST SETUP	63
PHOTOGRAPHS OF EUT CONSTRUCTIONAL DETAILS	65

5 Test Requirement

5.1 Test setup

5.1.1 For Conducted test setup

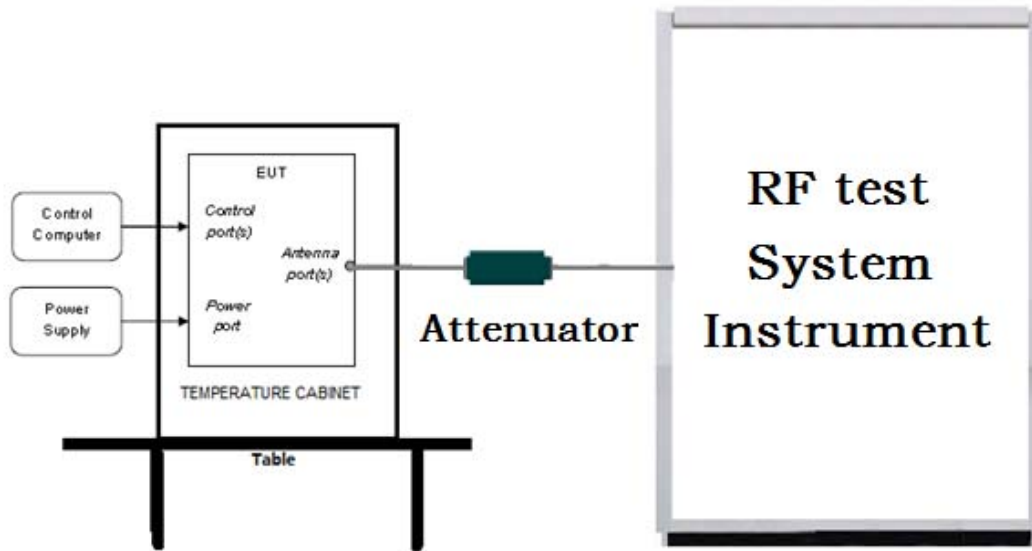

5.1.2 For Radiated Emissions test setup

Radiated Emissions setup:

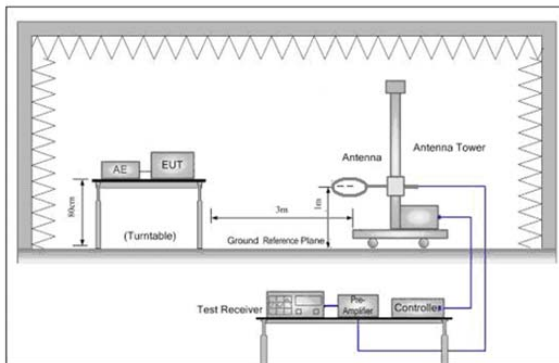

Figure 1. Below 30MHz

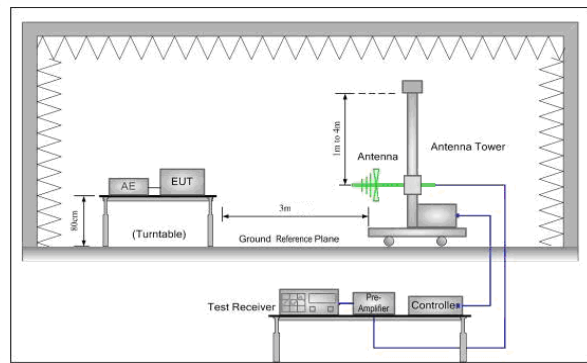

Figure 2. 30MHz to 1GHz

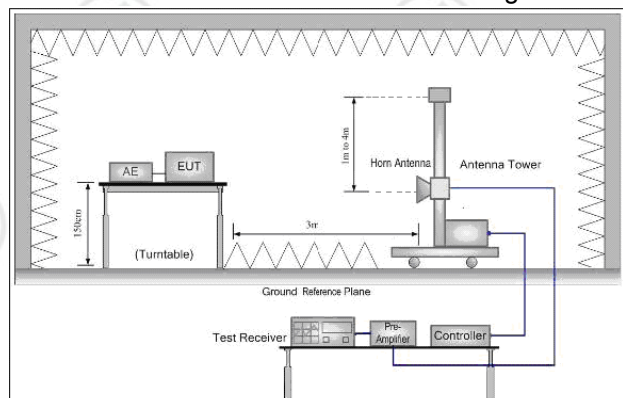
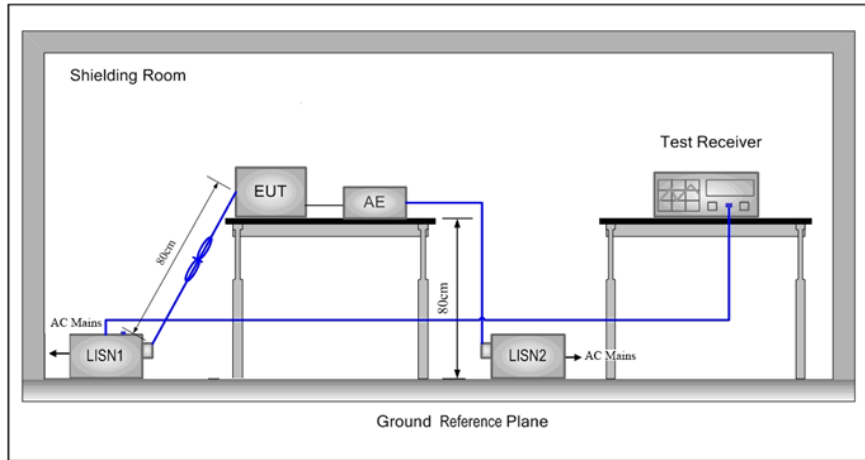

Figure 3. Above 1GHz

5.1.3 For Conducted Emissions test setup

Conducted Emissions setup



5.2 Test Environment

Operating Environment:	
Temperature:	23 °C
Humidity:	54% RH
Atmospheric Pressure:	1010mbar

5.3 Test Condition

Test channel:

Test Mode	Tx	RF Channel		
		Low(L)	Middle(M)	High(H)
802.11b/g/n(HT20)	2412MHz ~2462 MHz	Channel 1	Channel 6	Channel11
		2412MHz	2437MHz	2462MHz
802.11n(HT40)	2422MHz ~2452 MHz	Channel 1	Channel 4	Channel7
		2422MHz	2437MHz	2452MHz
Transmitting mode:	Keep the EUT in transmitting mode with all kind of modulation and all kind of data rate.			

Test mode:

Pre-scan under all rate at lowest channel 1

Mode	802.11b				X				
Data Rate	1Mbps	2Mbps	5.5Mbps	11Mbps					
Power(dBm)	9.03	9.56	9.58	9.59					
Mode	802.11g								
Data Rate	6Mbps	9Mbps	12Mbps	18Mbps	24Mbps	36Mbps	48Mbps	54Mbps	
Power(dBm)	8.74	8.65	8.52	8.50	8.49	8.46	8.32	8.29	
Mode	802.11n (HT20)								
Data Rate	6.5Mbps	13Mbps	19.5Mbps	26Mbps	39Mbps	52Mbps	58.5Mbps	65Mbps	
Power(dBm)	8.63	8.62	8.58	8.54	8.41	8.32	8.29	8.22	
Mode	802.11n (HT40)								
Data Rate	13.5Mbps	27Mbps	40.5Mbps	54Mbps	81Mbps	108Mbps	121.5Mbps	135Mbps	
Power(dBm)	7.68	7.52	7.50	7.48	7.43	7.39	7.35	7.32	

Through Pre-scan, 11Mbps of rate is the worst case of 802.11b; 6Mbps of rate is the worst case of 802.11g; 6.5Mbps of rate is the worst case of 802.11n(HT20); 13.5Mbps of rate is the worst case of 802.11n(HT40).

6 General Information

6.1 Client Information

Applicant:	Proexpress Distributor LLC
Address of Applicant:	11011 Greenwood Ave N 11011 Greenwood Ave N, Seattle Washington United States
Manufacturer:	Proexpress Distributor LLC
Address of Manufacturer:	11011 Greenwood Ave N 11011 Greenwood Ave N, Seattle Washington United States
Factory:	Proexpress Distributor LLC
Address of Factory:	11011 Greenwood Ave N 11011 Greenwood Ave N, Seattle Washington United States

6.2 General Description of EUT

Product Name:	7.85"Tablet PC
Model No.:	X80, X8, X80 PLUS, X80 PRO, X8 PLUS, X8 PRO, X8 KIDS, X80 KIDS
Test Model No.:	X80
Trade Mark:	DragonTouch, KINGPAD, KINGSLIM, AKASO
EUT Supports Radios application:	Wlan 2.4GHz 802.11b/g/n(HT20and HT40), Bluetooth V3.0+EDR
AC adapter:	Model: GS-0500200A Input: 100-240VAC 50/60Hz Output: DC5V $\overline{\text{---}}$ 2000mA
Sample Received Date:	Nov.18, 2016
Sample tested Date:	Nov.18, 2016 to Jan. 24, 2017

6.3 Product Specification subjective to this standard

Operation Frequency:	IEEE 802.11b/g/n(HT20): 2412MHz to 2462MHz IEEE 802.11n(HT40): 2422MHz to 2452MHz
Channel Numbers:	IEEE 802.11b/g, IEEE 802.11n HT20: 11 Channels IEEE 802.11n HT40: 7 Channels
Channel Separation:	5MHz
Type of Modulation:	IEEE for 802.11b: DSSS(CCK,DQPSK,DBPSK) IEEE for 802.11g :OFDM(64QAM, 16QAM, QPSK, BPSK) IEEE for 802.11n(HT20 and HT40) : OFDM (64QAM, 16QAM, QPSK,BPSK)
Sample Type:	Portable production
Test Power Grade:	802.11b: 10; 802.11g: 4; 802.11n(HT20&HT40): 3 (manufacturer declare)
Test Software of EUT:	SoFia RFTTestTool V1.1 (manufacturer declare)
Antenna Type:	PIFA antenna
Antenna Gain:	0dBi
Test Voltage:	AC 120V/60Hz

Operation Frequency each of channel(802.11b/g/n HT20)							
Channel	Frequency	Channel	Frequency	Channel	Frequency	Channel	Frequency
1	2412MHz	4	2427MHz	7	2442MHz	10	2457MHz
2	2417MHz	5	2432MHz	8	2447MHz	11	2462MHz
3	2422MHz	6	2437MHz	9	2452MHz		

Operation Frequency each of channel(802.11n HT40)					
Channel	Frequency	Channel	Frequency	Channel	Frequency
1	2422MHz	4	2437MHz	7	2452MHz
2	2427MHz	5	2442MHz		
3	2432MHz	6	2447MHz		

6.4 Description of Support Units

The EUT has been tested independently.

6.5 Test Location

All tests were performed at:

Centre Testing International Group Co., Ltd.

Hongwei Industrial Zone, Bao'an 70 District, Shenzhen, Guangdong, China 518101

Telephone: +86 (0) 755 3368 3668 Fax:+86 (0) 755 3368 3385

No tests were sub-contracted.

6.6 Test Facility

The test facility is recognized, certified, or accredited by the following organizations:

CNAS-Lab Code: L1910

Centre Testing International Group Co., Ltd. has been assessed and proved to be in compliance with CNAS-CL01 Accreditation Criteria for Testing and Calibration Laboratories (identical to ISO/IEC 17025: 2005 General Requirements) for the Competence of Testing and Calibration Laboratories..

A2LA-Lab Cert. No. 3061.01

Centre Testing International Group Co., Ltd. EMC Laboratory has been accredited by A2LA for technical competence in the field of electrical testing, and proved to be in compliance with ISO/IEC 17025: 2005 General Requirements for the Competence of Testing and Calibration Laboratories and any additional program requirements in the identified field of testing.

FCC-Registration No.: 886427

Centre Testing International Group Co., Ltd. EMC Laboratory has been registered and fully described in a report filed with the FCC (Federal Communications Commission). The acceptance letter from the FCC is maintained in our files. Registration 886427.

IC-Registration No.: 7408A-2

The 3m Alternate Test Site of Centre Testing International Group Co., Ltd. has been registered by Certification and Engineering Bureau of Industry Canada for the performance of radiated measurements with Registration No. 7408A-2 .

IC-Registration No.: 7408B-1

The 10m Alternate Test Site of Centre Testing International Group Co., Ltd. has been registered by Certification and Engineering Bureau of Industry Canada for the performance of radiated measurements with Registration No. 7408B-1.

NEMKO-Aut. No.: ELA503

Centre Testing International Group Co., Ltd. has been assessed the quality assurance system, the testing facilities, qualifications and testing practices of the relevant parts of the organization. The quality assurance system of the Laboratory has been validated against ISO/IEC 17025 or equivalent. The laboratory also fulfils the conditions described in Nemko Document NLA-10.

VCCI

The Radiation 3 &10 meters site of Centre Testing International Group Co., Ltd. has been registered in accordance with the Regulations for Voluntary Control Measures with Registration No.: R-4096.

Main Ports Conducted Interference Measurement of Centre Testing International Group Co., Ltd. has been registered in accordance with the Regulations for Voluntary Control Measures with Registration No.: C-4563.

Telecommunication Ports Conducted Disturbance Measurement of Centre Testing International Group Co., Ltd. has been registered in accordance with the Regulations for Voluntary Control Measures with Registration No.: T-2146.

The Radiation 3 meters site of Centre Testing International Group Co., Ltd. has been registered in accordance with the Regulations for Voluntary Control Measures with Registration No.: G-758

6.7 Deviation from Standards

None.

6.8 Abnormalities from Standard Conditions

None.

6.9 Other Information Requested by the Customer

None.

6.10 Measurement Uncertainty (95% confidence levels, k=2)

No.	Item	Measurement Uncertainty
1	Radio Frequency	7.9 x 10 ⁻⁸
2	RF power, conducted	0.31dB (30MHz-1GHz)
		0.57dB (1GHz-18GHz)
3	Radiated Spurious emission test	4.5dB (30MHz-1GHz)
		4.8dB (>1GHz)
4	Conduction emission	3.6dB (9kHz to 150kHz)
		3.2dB (150kHz to 30MHz)
5	Temperature test	0.64°C
6	Humidity test	2.8%
7	DC power voltages	0.025%

7 Equipment List

RF test system					
Equipment	Manufacturer	Mode No.	Serial Number	Cal. Date (mm-dd-yyyy)	Cal. Due date (mm-dd-yyyy)
Signal Generator	Keysight	E8257D	MY53401106	04-01-2016	03-31-2017
Spectrum Analyzer	Keysight	N9010A	MY54510339	04-01-2016	03-31-2017
Signal Generator	Keysight	N5182B	MY53051549	04-01-2016	03-31-2017
DC Power	Keysight	E3642A	MY54436035	04-01-2016	03-31-2017
PC-1	Lenovo	R4960d	---	04-01-2016	03-31-2017
BT&WI-FI Automatic control	R&S	OSP120	101374	04-01-2016	03-31-2017
RF control unit	JS Tonscend	JS0806-2	158060006	04-01-2016	03-31-2017
BT&WI-FI Automatic test software	JS Tonscend	JS1120-2	---	04-01-2016	03-31-2017

Conducted disturbance Test					
Equipment	Manufacturer	Mode No.	Serial Number	Cal. date (mm-dd-yyyy)	Cal. Due date (mm-dd-yyyy)
Receiver	R&S	ESCI	100009	06-16-2016	06-15-2017
Temperature/ Humidity Indicator	TAYLOR	1451	1905	04-27-2016	04-26-2017
LISN	R&S	ENV216	100098	06-16-2016	06-15-2017
LISN	schwarzbeck	NNLK8121	8121-529	06-16-2016	06-15-2017
Voltage Probe	R&S	ESH2-Z3	--	07-09-2014	07-07-2017
Current Probe	R&S	EZ17	100106	06-16-2016	06-15-2017
ISN	TESEQ GmbH	ISN T800	30297	01-29-2017	01-27-2019

3M Semi/full-anechoic Chamber					
Equipment	Manufacturer	Mode No.	Serial Number	Cal. date (mm-dd-yyyy)	Cal. Due date (mm-dd-yyyy)
3M Chamber & Accessory Equipment	TDK	SAC-3	---	06-05-2016	06-05-2019
TRILOG Broadband Antenna	SCHWARZBECK	VULB9163	9163-484	05-23-2016	05-22-2017
Microwave Preamplifier	Agilent	8449B	3008A02425	02-04-2017	02-03-2018
Horn Antenna	ETS-LINDGREN	3117	00057407	07-20-2015	07-18-2018
Loop Antenna	ETS	6502	00071730	07-30-2015	07-28-2017
Spectrum Analyzer	R&S	FSP40	100416	06-16-2016	06-15-2017
Receiver	R&S	ESCI	100435	06-16-2016	06-15-2017
Multi device Controller	matur	NCD/070/10711 112	---	01-10-2017	01-09-2018
LISN	schwarzbeck	NNBM8125	81251547	06-16-2016	06-15-2017
LISN	schwarzbeck	NNBM8125	81251548	06-16-2016	06-15-2017
Signal Generator	Agilent	E4438C	MY45095744	04-01-2016	03-31-2017
Signal Generator	Keysight	E8257D	MY53401106	04-01-2016	03-31-2017
Temperature/ Humidity Indicator	TAYLOR	1451	1905	04-27-2016	04-26-2017
Cable line	Fulai(7M)	SF106	5219/6A	01-10-2017	01-09-2018
Cable line	Fulai(6M)	SF106	5220/6A	01-10-2017	01-09-2018
Cable line	Fulai(3M)	SF106	5216/6A	01-10-2017	01-09-2018
Cable line	Fulai(3M)	SF106	5217/6A	01-10-2017	01-09-2018
High-pass filter	Sinoscite	FL3CX03WG18 NM12-0398-002	---	01-10-2017	01-09-2018
High-pass filter	MICRO-TRONICS	SPA-F-63029-4	---	01-10-2017	01-09-2018
band rejection filter	Sinoscite	FL5CX01CA09 CL12-0395-001	---	01-10-2017	01-09-2018
band rejection filter	Sinoscite	FL5CX01CA08 CL12-0393-001	---	01-10-2017	01-09-2018
band rejection filter	Sinoscite	FL5CX02CA04 CL12-0396-002	---	01-10-2017	01-09-2018
band rejection filter	Sinoscite	FL5CX02CA03 CL12-0394-001	---	01-10-2017	01-09-2018

8 Radio Technical Requirements Specification

Reference documents for testing:

No.	Identity	Document Title
1	FCC Part15C (2015)	Subpart C-Intentional Radiators
2	ANSI C63.10-2013	American National Standard for Testing Unlicensed Wireless Devices

Test Results List:

Test Requirement	Test method	Test item	Verdict	Note
Part15C Section 15.247 (b)(3)	ANSI C63.10	Conducted Peak Output Power	PASS	Appendix A)
Part15C Section 15.247 (a)(2)	ANSI C63.10	6dB Occupied Bandwidth	PASS	Appendix B)
Part15C Section 15.247(d)	ANSI C63.10	Band-edge for RF Conducted Emissions	PASS	Appendix C)
Part15C Section 15.247(d)	ANSI C63.10	RF Conducted Spurious Emissions	PASS	Appendix D)
Part15C Section 15.247 (e)	ANSI C63.10	Power Spectral Density	PASS	Appendix E)
Part15C Section 15.203/15.247 (c)	ANSI C63.10	Antenna Requirement	PASS	Appendix F)
Part15C Section 15.207	ANSI C63.10	AC Power Line Conducted Emission	PASS	Appendix G)
Part15C Section 15.205/15.209	ANSI C63.10	Restricted bands around fundamental frequency (Radiated Emission)	PASS	Appendix H)
Part15C Section 15.205/15.209	ANSI C63.10	Radiated Spurious Emissions	PASS	Appendix I)



Appendix A): Conducted Output Power

Result Table

Mode	Channel	Conducted Output Power [dBm]	Verdict	Remark
11B	LCH	9.03	PASS	RMS detector
11B	MCH	9.58	PASS	
11B	HCH	9.59	PASS	
11G	LCH	8.74	PASS	
11G	MCH	9.4	PASS	
11G	HCH	9.32	PASS	
11N20SISO	LCH	8.63	PASS	
11N20SISO	MCH	9.19	PASS	
11N20SISO	HCH	9.27	PASS	
11N40SISO	LCH	7.68	PASS	
11N40SISO	MCH	8.33	PASS	
11N40SISO	HCH	8.2	PASS	

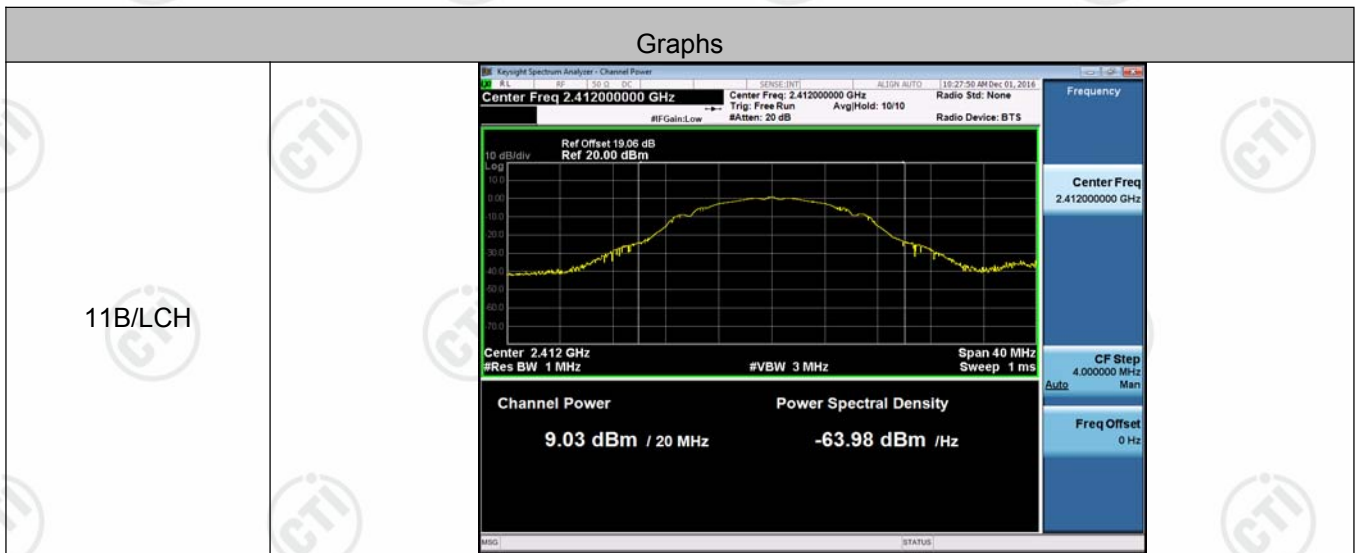
Test Graph

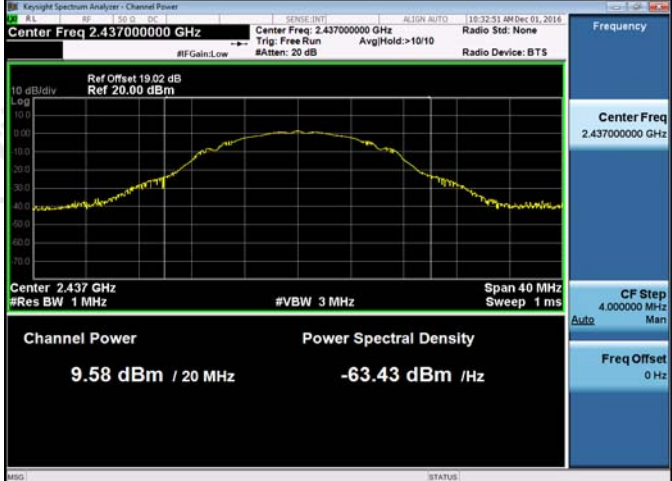

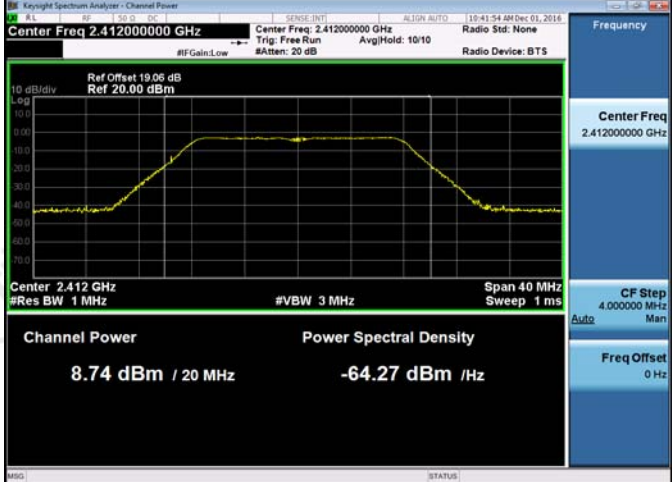
<p>11B/MCH</p>	 <p>Keysight Spectrum Analyzer - Channel Power</p> <p>Center Freq: 2.437000000 GHz</p> <p>Channel Power: 9.58 dBm / 20 MHz</p> <p>Power Spectral Density: -63.43 dBm / Hz</p>
<p>11B/HCH</p>	 <p>Keysight Spectrum Analyzer - Channel Power</p> <p>Center Freq: 2.462000000 GHz</p> <p>Channel Power: 9.59 dBm / 20 MHz</p> <p>Power Spectral Density: -63.42 dBm / Hz</p>
<p>11G/LCH</p>	 <p>Keysight Spectrum Analyzer - Channel Power</p> <p>Center Freq: 2.412000000 GHz</p> <p>Channel Power: 8.74 dBm / 20 MHz</p> <p>Power Spectral Density: -64.27 dBm / Hz</p>

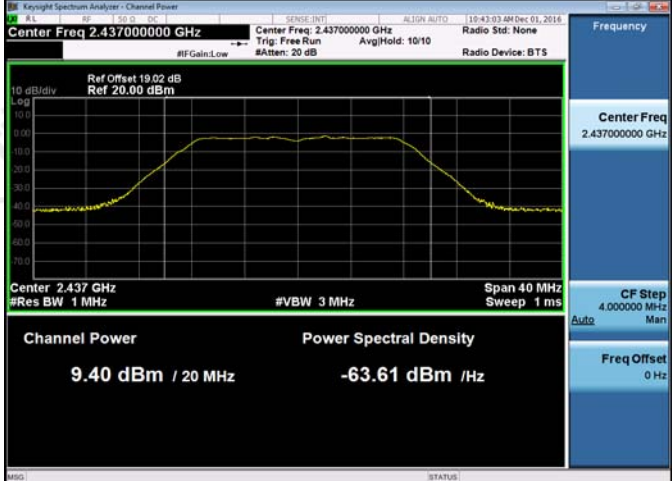
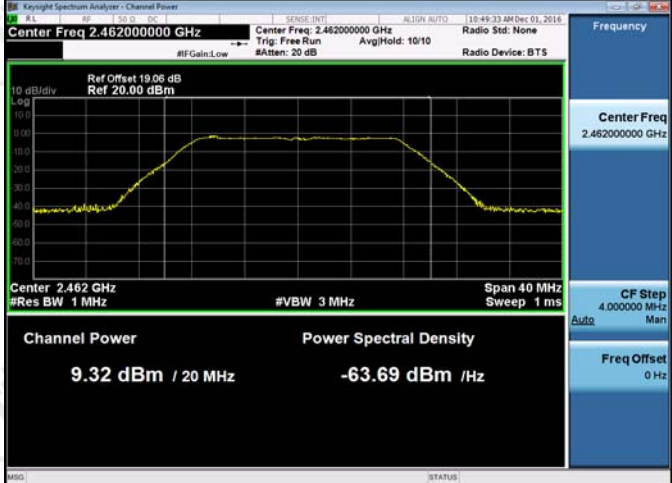
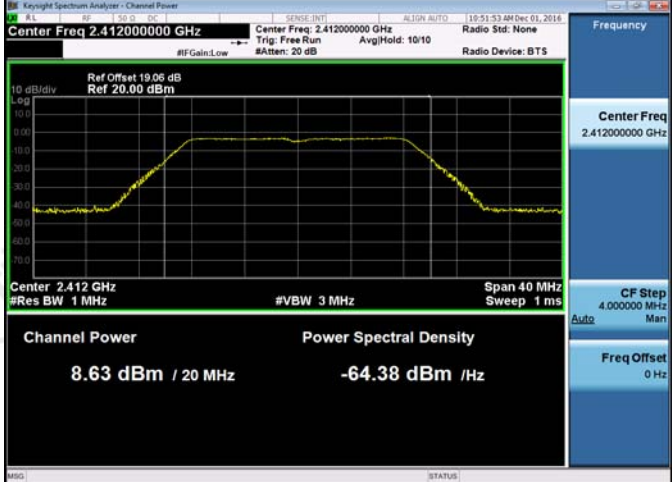
<p>11G/MCH</p>	 <p>Keysight Spectrum Analyzer - Channel Power</p> <p>Center Freq: 2.437000000 GHz</p> <p>Channel Power: 9.40 dBm / 20 MHz</p> <p>Power Spectral Density: -63.61 dBm /Hz</p>
<p>11G/HCH</p>	 <p>Keysight Spectrum Analyzer - Channel Power</p> <p>Center Freq: 2.462000000 GHz</p> <p>Channel Power: 9.32 dBm / 20 MHz</p> <p>Power Spectral Density: -63.69 dBm /Hz</p>
<p>11N20SISO/LCH</p>	 <p>Keysight Spectrum Analyzer - Channel Power</p> <p>Center Freq: 2.412000000 GHz</p> <p>Channel Power: 8.63 dBm / 20 MHz</p> <p>Power Spectral Density: -64.38 dBm /Hz</p>

<p>11N20SISO/MCH</p>	 <p>Keysight Spectrum Analyzer - Channel Power</p> <p>Center Freq: 2.437000000 GHz</p> <p>Channel Power: 9.19 dBm / 20 MHz</p> <p>Power Spectral Density: -63.82 dBm / Hz</p> <p>Center Freq: 2.437 GHz</p> <p>#Res BW: 1 MHz</p> <p>#VBW: 3 MHz</p> <p>Span: 40 MHz</p> <p>Sweep: 1 ms</p>
<p>11N20SISO/HCH</p>	 <p>Keysight Spectrum Analyzer - Channel Power</p> <p>Center Freq: 2.462000000 GHz</p> <p>Channel Power: 9.27 dBm / 20 MHz</p> <p>Power Spectral Density: -63.74 dBm / Hz</p> <p>Center Freq: 2.462 GHz</p> <p>#Res BW: 1 MHz</p> <p>#VBW: 3 MHz</p> <p>Span: 40 MHz</p> <p>Sweep: 1 ms</p>
<p>11N40SISO/LCH</p>	 <p>Keysight Spectrum Analyzer - Channel Power</p> <p>Center Freq: 2.422000000 GHz</p> <p>Channel Power: 7.68 dBm / 40 MHz</p> <p>Power Spectral Density: -68.34 dBm / Hz</p> <p>Center Freq: 2.422 GHz</p> <p>#Res BW: 1 MHz</p> <p>#VBW: 3 MHz</p> <p>Span: 80 MHz</p> <p>Sweep: 1 ms</p>

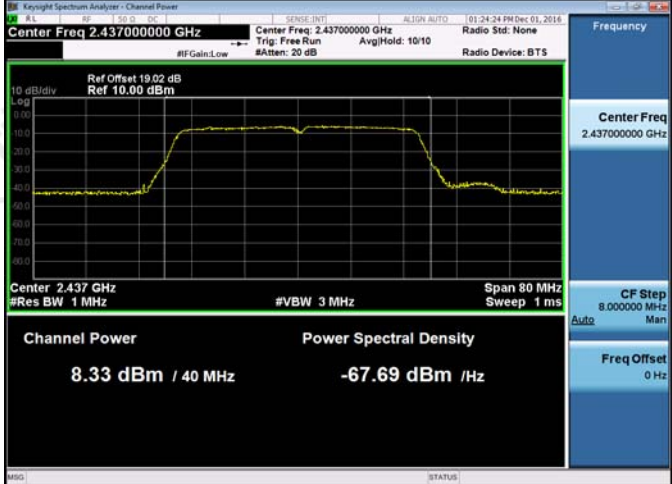
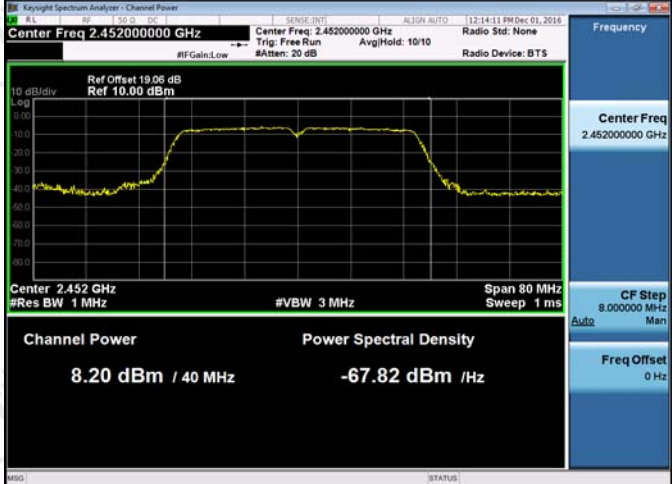
<p>11N40SISO/MCH</p>	 <p>Keysight Spectrum Analyzer - Channel Power</p> <p>Center Freq: 2.437000000 GHz</p> <p>Ref Offset: 19.02 dB Ref: 10.00 dBm</p> <p>Channel Power: 8.33 dBm / 40 MHz</p> <p>Power Spectral Density: -67.69 dBm / Hz</p> <p>Center Freq: 2.437 GHz</p> <p>#Res BW: 1 MHz</p> <p>#VBW: 3 MHz</p> <p>Span: 80 MHz</p> <p>Sweep: 1 ms</p>
<p>11N40SISO/HCH</p>	 <p>Keysight Spectrum Analyzer - Channel Power</p> <p>Center Freq: 2.452000000 GHz</p> <p>Ref Offset: 19.06 dB Ref: 10.00 dBm</p> <p>Channel Power: 8.20 dBm / 40 MHz</p> <p>Power Spectral Density: -67.82 dBm / Hz</p> <p>Center Freq: 2.452 GHz</p> <p>#Res BW: 1 MHz</p> <p>#VBW: 3 MHz</p> <p>Span: 80 MHz</p> <p>Sweep: 1 ms</p>

Appendix B): 6dB Occupied Bandwidth

Result Table

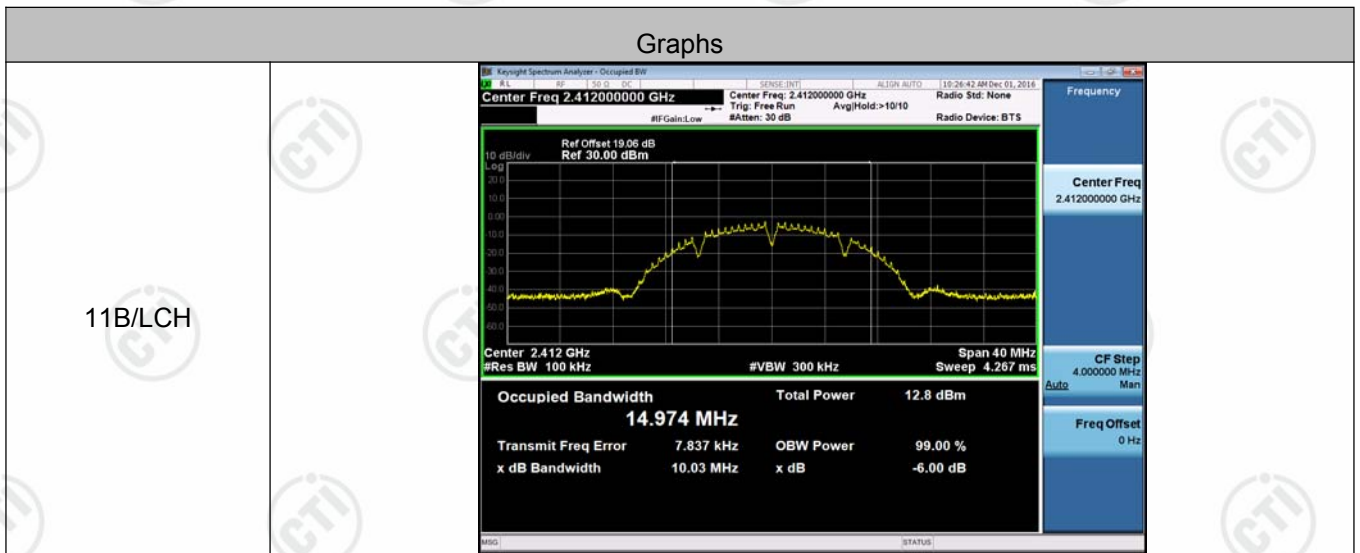

Mode	Channel	6dB Bandwidth [MHz]	99% OBW [MHz]	Verdict	Remark
11B	LCH	10.03	14.974	PASS	Peak detector
11B	MCH	10.00	14.970	PASS	
11B	HCH	10.04	14.990	PASS	
11G	LCH	16.41	16.571	PASS	
11G	MCH	16.35	16.586	PASS	
11G	HCH	16.37	16.578	PASS	
11N20SISO	LCH	17.58	17.722	PASS	
11N20SISO	MCH	17.58	17.691	PASS	
11N20SISO	HCH	17.58	17.724	PASS	
11N40SISO	LCH	35.55	36.229	PASS	
11N40SISO	MCH	34.19	36.321	PASS	
11N40SISO	HCH	35.07	36.253	PASS	

Test Graph

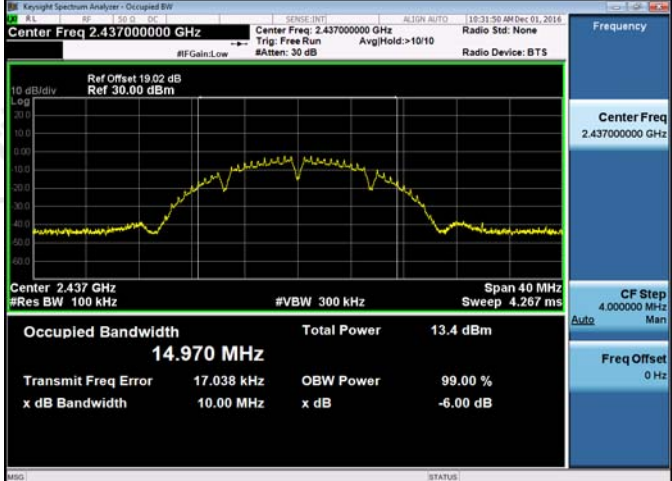
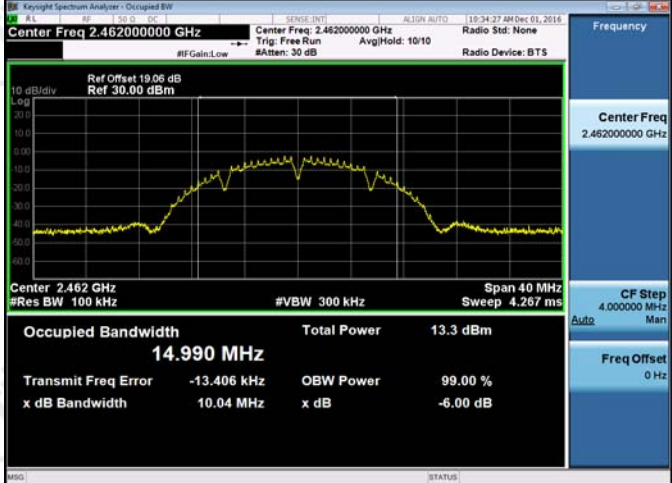
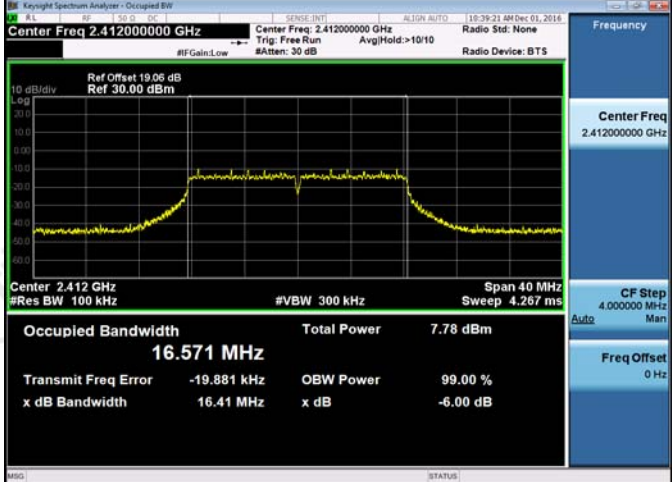

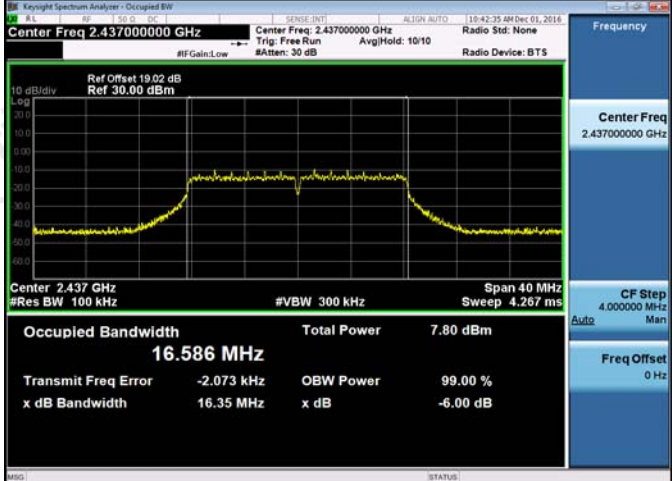
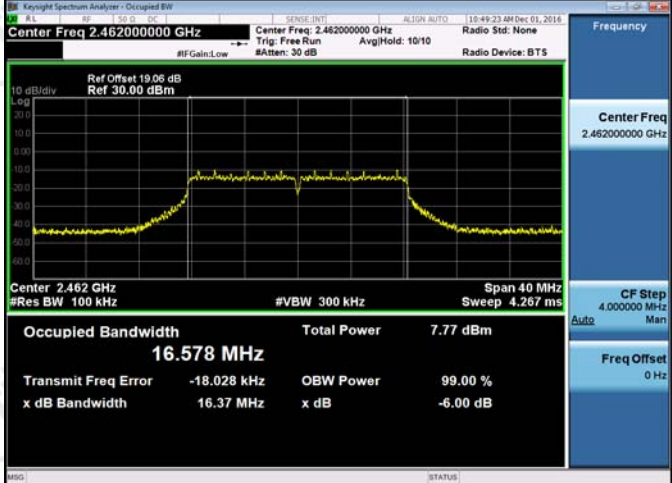
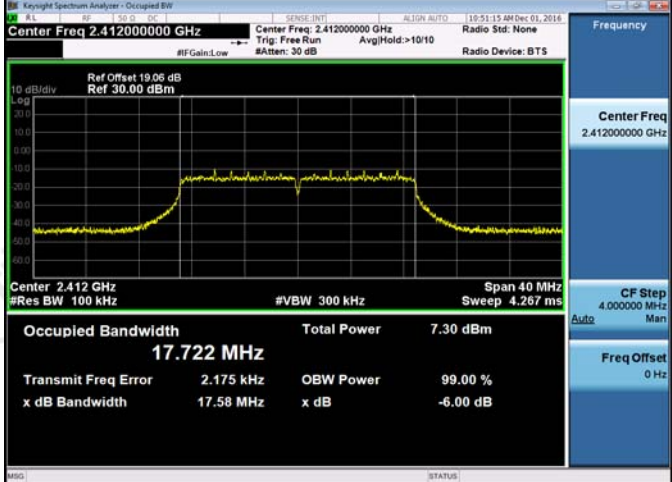
<p>11B/MCH</p>	 <p>KeySight Spectrum Analyzer - Occupied BW</p> <p>Center Freq 2.437000000 GHz</p> <p>Center Freq: 2.437000000 GHz</p> <p>Trig: Free Run Avg/Hold: >10/10</p> <p>Radio Std: None</p> <p>Radio Device: BTS</p> <p>Ref Offset 19.02 dB</p> <p>Ref 30.00 dBm</p> <p>Center 2.437 GHz</p> <p>#Res BW 100 kHz</p> <p>#VBW 300 kHz</p> <p>Span 40 MHz</p> <p>Sweep 4.267 ms</p> <p>Occupied Bandwidth 14.970 MHz</p> <p>Total Power 13.4 dBm</p> <p>Transmit Freq Error 17.038 kHz</p> <p>OBW Power 99.00 %</p> <p>x dB Bandwidth 10.00 MHz</p> <p>x dB -6.00 dB</p> <p>Frequency</p> <p>Center Freq 2.437000000 GHz</p> <p>CF Step 4.000000 MHz</p> <p>Auto Man</p> <p>Freq Offset 0 Hz</p>
<p>11B/HCH</p>	 <p>KeySight Spectrum Analyzer - Occupied BW</p> <p>Center Freq 2.462000000 GHz</p> <p>Center Freq: 2.462000000 GHz</p> <p>Trig: Free Run Avg/Hold: 10/10</p> <p>Radio Std: None</p> <p>Radio Device: BTS</p> <p>Ref Offset 19.06 dB</p> <p>Ref 30.00 dBm</p> <p>Center 2.462 GHz</p> <p>#Res BW 100 kHz</p> <p>#VBW 300 kHz</p> <p>Span 40 MHz</p> <p>Sweep 4.267 ms</p> <p>Occupied Bandwidth 14.990 MHz</p> <p>Total Power 13.3 dBm</p> <p>Transmit Freq Error -13.406 kHz</p> <p>OBW Power 99.00 %</p> <p>x dB Bandwidth 10.04 MHz</p> <p>x dB -6.00 dB</p> <p>Frequency</p> <p>Center Freq 2.462000000 GHz</p> <p>CF Step 4.000000 MHz</p> <p>Auto Man</p> <p>Freq Offset 0 Hz</p>
<p>11G/LCH</p>	 <p>KeySight Spectrum Analyzer - Occupied BW</p> <p>Center Freq 2.412000000 GHz</p> <p>Center Freq: 2.412000000 GHz</p> <p>Trig: Free Run Avg/Hold: >10/10</p> <p>Radio Std: None</p> <p>Radio Device: BTS</p> <p>Ref Offset 19.06 dB</p> <p>Ref 30.00 dBm</p> <p>Center 2.412 GHz</p> <p>#Res BW 100 kHz</p> <p>#VBW 300 kHz</p> <p>Span 40 MHz</p> <p>Sweep 4.267 ms</p> <p>Occupied Bandwidth 16.571 MHz</p> <p>Total Power 7.78 dBm</p> <p>Transmit Freq Error -19.881 kHz</p> <p>OBW Power 99.00 %</p> <p>x dB Bandwidth 16.41 MHz</p> <p>x dB -6.00 dB</p> <p>Frequency</p> <p>Center Freq 2.412000000 GHz</p> <p>CF Step 4.000000 MHz</p> <p>Auto Man</p> <p>Freq Offset 0 Hz</p>

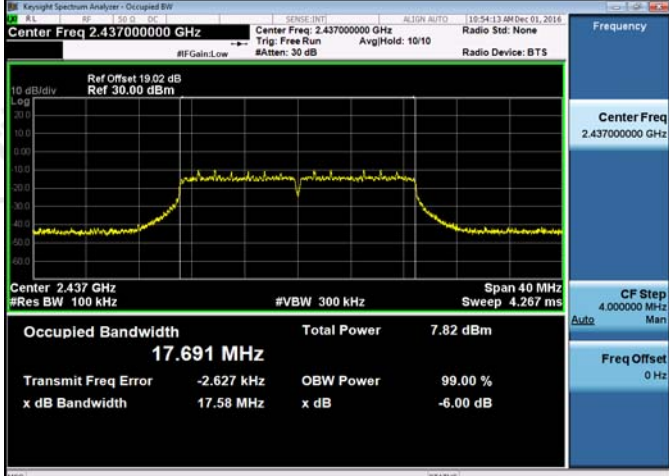
<p>11G/MCH</p>	 <p>Keysight Spectrum Analyzer - Occupied BW</p> <p>Center Freq 2.437000000 GHz</p> <p>Center Freq: 2.437000000 GHz</p> <p>Trig: Free Run Avg/Hold: 10/10</p> <p>Radio Std: None</p> <p>Radio Device: BTS</p> <p>Ref Offset 19.02 dB</p> <p>Ref 30.00 dBm</p> <p>Center 2.437 GHz</p> <p>#Res BW 100 kHz</p> <p>#VBW 300 kHz</p> <p>Span 40 MHz</p> <p>Sweep 4.267 ms</p> <p>Occupied Bandwidth 16.586 MHz</p> <p>Total Power 7.80 dBm</p> <p>Transmit Freq Error -2.073 kHz</p> <p>OBW Power 99.00 %</p> <p>x dB Bandwidth 16.35 MHz</p> <p>x dB -6.00 dB</p> <p>Frequency</p> <p>Center Freq 2.437000000 GHz</p> <p>CF Step 4.000000 MHz</p> <p>Auto Man</p> <p>Freq Offset 0 Hz</p>
<p>11G/HCH</p>	 <p>Keysight Spectrum Analyzer - Occupied BW</p> <p>Center Freq 2.462000000 GHz</p> <p>Center Freq: 2.462000000 GHz</p> <p>Trig: Free Run Avg/Hold: 10/10</p> <p>Radio Std: None</p> <p>Radio Device: BTS</p> <p>Ref Offset 19.06 dB</p> <p>Ref 30.00 dBm</p> <p>Center 2.462 GHz</p> <p>#Res BW 100 kHz</p> <p>#VBW 300 kHz</p> <p>Span 40 MHz</p> <p>Sweep 4.267 ms</p> <p>Occupied Bandwidth 16.578 MHz</p> <p>Total Power 7.77 dBm</p> <p>Transmit Freq Error -18.028 kHz</p> <p>OBW Power 99.00 %</p> <p>x dB Bandwidth 16.37 MHz</p> <p>x dB -6.00 dB</p> <p>Frequency</p> <p>Center Freq 2.462000000 GHz</p> <p>CF Step 4.000000 MHz</p> <p>Auto Man</p> <p>Freq Offset 0 Hz</p>
<p>11N20SISO/LCH</p>	 <p>Keysight Spectrum Analyzer - Occupied BW</p> <p>Center Freq 2.412000000 GHz</p> <p>Center Freq: 2.412000000 GHz</p> <p>Trig: Free Run Avg/Hold: >10/10</p> <p>Radio Std: None</p> <p>Radio Device: BTS</p> <p>Ref Offset 19.06 dB</p> <p>Ref 30.00 dBm</p> <p>Center 2.412 GHz</p> <p>#Res BW 100 kHz</p> <p>#VBW 300 kHz</p> <p>Span 40 MHz</p> <p>Sweep 4.267 ms</p> <p>Occupied Bandwidth 17.722 MHz</p> <p>Total Power 7.30 dBm</p> <p>Transmit Freq Error 2.175 kHz</p> <p>OBW Power 99.00 %</p> <p>x dB Bandwidth 17.58 MHz</p> <p>x dB -6.00 dB</p> <p>Frequency</p> <p>Center Freq 2.412000000 GHz</p> <p>CF Step 4.000000 MHz</p> <p>Auto Man</p> <p>Freq Offset 0 Hz</p>

<p>11N20SISO/MCH</p>	 <p>Keyight Spectrum Analyzer - Occupied BW</p> <p>Center Freq: 2.437000000 GHz</p> <p>Center Freq: 2.437000000 GHz</p> <p>Trig: Free Run</p> <p>Avg/Hold: 10/10</p> <p>Radio Std: None</p> <p>Radio Device: BTS</p> <p>Ref Offset 19.02 dB</p> <p>Ref 30.00 dBm</p> <p>Center 2.437 GHz</p> <p>#Res BW 100 kHz</p> <p>#VBW 300 kHz</p> <p>Span 40 MHz</p> <p>Sweep 4.267 ms</p> <p>Occupied Bandwidth 17.691 MHz</p> <p>Total Power 7.82 dBm</p> <p>Transmit Freq Error -2.627 kHz</p> <p>OBW Power 99.00 %</p> <p>x dB Bandwidth 17.58 MHz</p> <p>x dB -6.00 dB</p> <p>Frequency</p> <p>Center Freq 2.437000000 GHz</p> <p>CF Step 4.000000 MHz</p> <p>Freq Offset 0 Hz</p>
<p>11N20SISO/HCH</p>	 <p>Keyight Spectrum Analyzer - Occupied BW</p> <p>Center Freq: 2.462000000 GHz</p> <p>Center Freq: 2.462000000 GHz</p> <p>Trig: Free Run</p> <p>Avg/Hold: >10/10</p> <p>Radio Std: None</p> <p>Radio Device: BTS</p> <p>Ref Offset 19.05 dB</p> <p>Ref 30.00 dBm</p> <p>Center 2.462 GHz</p> <p>#Res BW 100 kHz</p> <p>#VBW 300 kHz</p> <p>Span 40 MHz</p> <p>Sweep 4.267 ms</p> <p>Occupied Bandwidth 17.724 MHz</p> <p>Total Power 7.74 dBm</p> <p>Transmit Freq Error -19.998 kHz</p> <p>OBW Power 99.00 %</p> <p>x dB Bandwidth 17.58 MHz</p> <p>x dB -6.00 dB</p> <p>Frequency</p> <p>Center Freq 2.462000000 GHz</p> <p>CF Step 4.000000 MHz</p> <p>Freq Offset 0 Hz</p>
<p>11N40SISO/LCH</p>	 <p>Keyight Spectrum Analyzer - Occupied BW</p> <p>Center Freq: 2.422000000 GHz</p> <p>Center Freq: 2.422000000 GHz</p> <p>Trig: Free Run</p> <p>Avg/Hold: 10/10</p> <p>Radio Std: None</p> <p>Radio Device: BTS</p> <p>Ref Offset 18.9 dB</p> <p>Ref 30.00 dBm</p> <p>Center 2.422 GHz</p> <p>#Res BW 100 kHz</p> <p>#VBW 300 kHz</p> <p>Span 80 MHz</p> <p>Sweep 8 ms</p> <p>Occupied Bandwidth 36.229 MHz</p> <p>Total Power 6.22 dBm</p> <p>Transmit Freq Error 18.232 kHz</p> <p>OBW Power 99.00 %</p> <p>x dB Bandwidth 35.55 MHz</p> <p>x dB -6.00 dB</p> <p>Frequency</p> <p>Center Freq 2.422000000 GHz</p> <p>CF Step 8.000000 MHz</p> <p>Freq Offset 0 Hz</p>

<p>11N40SISO/MCH</p>	<p>KeySight Spectrum Analyzer - Occupied BW</p> <p>Center Freq 2.437000000 GHz</p> <p>Ref Offset 19.02 dB Ref 30.00 dBm</p> <p>Center 2.437 GHz #Res BW 100 kHz</p> <p>Occupied Bandwidth 36.321 MHz</p> <p>Total Power 5.23 dBm</p> <p>Transmit Freq Error 5.284 kHz</p> <p>x dB Bandwidth 34.19 MHz</p>
<p>11N40SISO/HCH</p>	<p>KeySight Spectrum Analyzer - Occupied BW</p> <p>Center Freq 2.452000000 GHz</p> <p>Ref Offset 19.06 dB Ref 30.00 dBm</p> <p>Center 2.452 GHz #Res BW 100 kHz</p> <p>Occupied Bandwidth 36.253 MHz</p> <p>Total Power 6.00 dBm</p> <p>Transmit Freq Error 918 Hz</p> <p>x dB Bandwidth 35.07 MHz</p>

Appendix C): Band-edge for RF Conducted Emissions

Result Table

Mode	Channel	Carrier Power[dBm]	Max.Spurious Level [dBm]	Limit [dBm]	Verdict
11B	LCH	-3.266	-50.186	-33.27	PASS
11B	HCH	-2.666	-49.318	-32.67	PASS
11G	LCH	-9.837	-50.824	-39.84	PASS
11G	HCH	-9.803	-49.604	-39.8	PASS
11N20SISO	LCH	-10.614	-50.523	-40.61	PASS
11N20SISO	HCH	-9.971	-50.185	-39.97	PASS
11N40SISO	LCH	-14.486	-50.878	-44.49	PASS
11N40SISO	HCH	-13.688	-50.567	-43.69	PASS

Test Graph

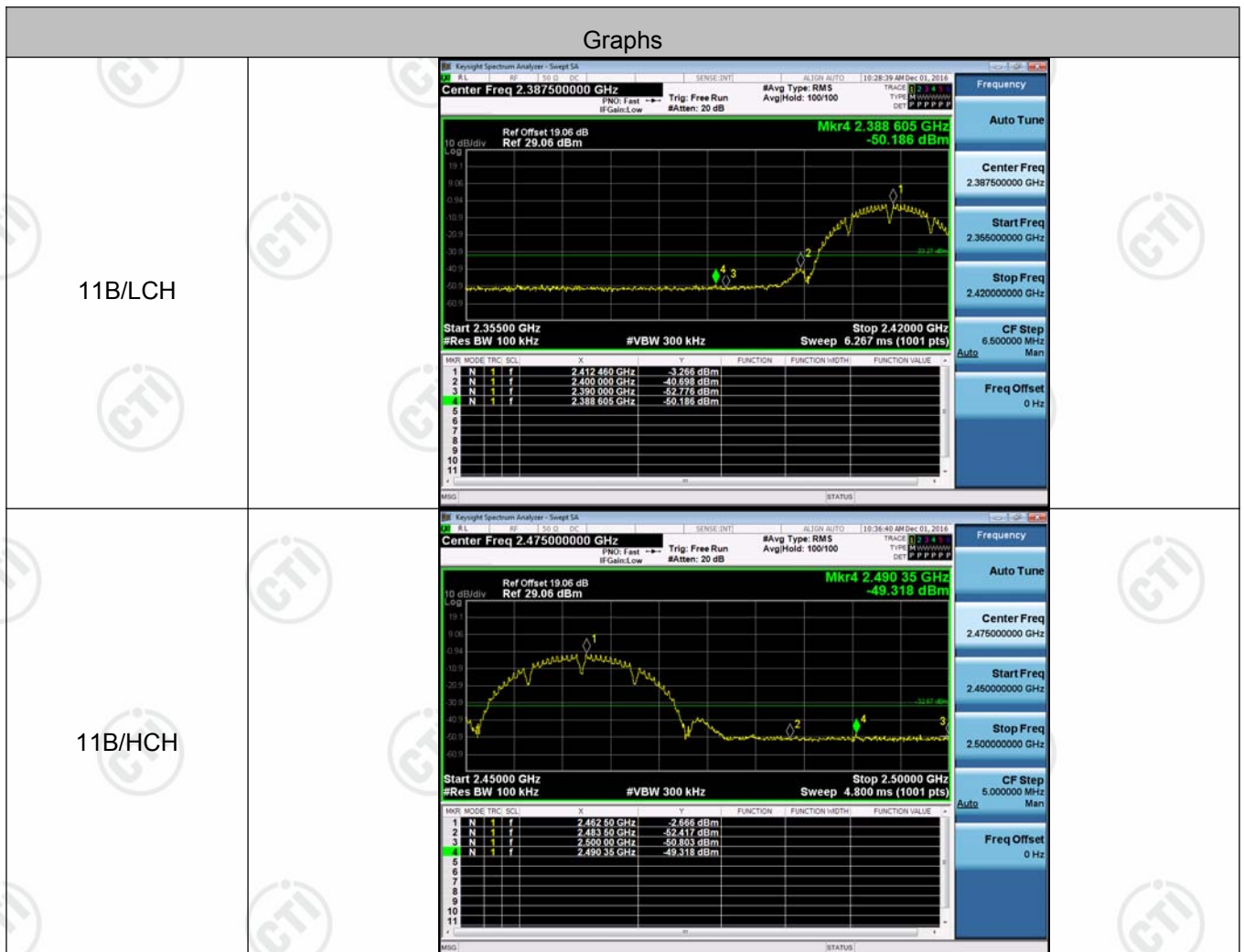

<p>11G/LCH</p>	<p>Center Freq 2.387500000 GHz</p> <p>Mkr4 2.373 720 GHz -50.824 dBm</p> <p>Start 2.35500 GHz #Res BW 100 kHz</p> <p>Stop 2.42000 GHz #VBW 300 kHz Sweep 6.267 ms (1001 pts)</p> <table border="1"> <thead> <tr> <th>MNR</th> <th>MODE</th> <th>TRC</th> <th>SCL</th> <th>X</th> <th>Y</th> <th>FUNCTION</th> <th>FUNCTION METH</th> <th>FUNCTION VALUE</th> </tr> </thead> <tbody> <tr> <td>1</td> <td>N</td> <td>1</td> <td>f</td> <td>2.419 480 GHz</td> <td>-9.837 dBm</td> <td></td> <td></td> <td></td> </tr> <tr> <td>2</td> <td>N</td> <td>1</td> <td>f</td> <td>2.400 000 GHz</td> <td>-46.869 dBm</td> <td></td> <td></td> <td></td> </tr> <tr> <td>3</td> <td>N</td> <td>1</td> <td>f</td> <td>2.390 000 GHz</td> <td>-54.325 dBm</td> <td></td> <td></td> <td></td> </tr> <tr> <td>4</td> <td>N</td> <td>1</td> <td>f</td> <td>2.373 720 GHz</td> <td>-50.824 dBm</td> <td></td> <td></td> <td></td> </tr> </tbody> </table>	MNR	MODE	TRC	SCL	X	Y	FUNCTION	FUNCTION METH	FUNCTION VALUE	1	N	1	f	2.419 480 GHz	-9.837 dBm				2	N	1	f	2.400 000 GHz	-46.869 dBm				3	N	1	f	2.390 000 GHz	-54.325 dBm				4	N	1	f	2.373 720 GHz	-50.824 dBm			
MNR	MODE	TRC	SCL	X	Y	FUNCTION	FUNCTION METH	FUNCTION VALUE																																						
1	N	1	f	2.419 480 GHz	-9.837 dBm																																									
2	N	1	f	2.400 000 GHz	-46.869 dBm																																									
3	N	1	f	2.390 000 GHz	-54.325 dBm																																									
4	N	1	f	2.373 720 GHz	-50.824 dBm																																									
<p>11G/HCH</p>	<p>Center Freq 2.475000000 GHz</p> <p>Mkr4 2.489 75 GHz -49.604 dBm</p> <p>Start 2.45000 GHz #Res BW 100 kHz</p> <p>Stop 2.50000 GHz #VBW 300 kHz Sweep 4.800 ms (1001 pts)</p> <table border="1"> <thead> <tr> <th>MNR</th> <th>MODE</th> <th>TRC</th> <th>SCL</th> <th>X</th> <th>Y</th> <th>FUNCTION</th> <th>FUNCTION METH</th> <th>FUNCTION VALUE</th> </tr> </thead> <tbody> <tr> <td>1</td> <td>N</td> <td>1</td> <td>f</td> <td>2.483 25 GHz</td> <td>-9.803 dBm</td> <td></td> <td></td> <td></td> </tr> <tr> <td>2</td> <td>N</td> <td>1</td> <td>f</td> <td>2.483 50 GHz</td> <td>-53.176 dBm</td> <td></td> <td></td> <td></td> </tr> <tr> <td>3</td> <td>N</td> <td>1</td> <td>f</td> <td>2.500 00 GHz</td> <td>-61.841 dBm</td> <td></td> <td></td> <td></td> </tr> <tr> <td>4</td> <td>N</td> <td>1</td> <td>f</td> <td>2.489 75 GHz</td> <td>-49.604 dBm</td> <td></td> <td></td> <td></td> </tr> </tbody> </table>	MNR	MODE	TRC	SCL	X	Y	FUNCTION	FUNCTION METH	FUNCTION VALUE	1	N	1	f	2.483 25 GHz	-9.803 dBm				2	N	1	f	2.483 50 GHz	-53.176 dBm				3	N	1	f	2.500 00 GHz	-61.841 dBm				4	N	1	f	2.489 75 GHz	-49.604 dBm			
MNR	MODE	TRC	SCL	X	Y	FUNCTION	FUNCTION METH	FUNCTION VALUE																																						
1	N	1	f	2.483 25 GHz	-9.803 dBm																																									
2	N	1	f	2.483 50 GHz	-53.176 dBm																																									
3	N	1	f	2.500 00 GHz	-61.841 dBm																																									
4	N	1	f	2.489 75 GHz	-49.604 dBm																																									
<p>11N20SISO/LCH</p>	<p>Center Freq 2.387500000 GHz</p> <p>Mkr4 2.387 045 GHz -50.523 dBm</p> <p>Start 2.35500 GHz #Res BW 100 kHz</p> <p>Stop 2.42000 GHz #VBW 300 kHz Sweep 6.267 ms (1001 pts)</p> <table border="1"> <thead> <tr> <th>MNR</th> <th>MODE</th> <th>TRC</th> <th>SCL</th> <th>X</th> <th>Y</th> <th>FUNCTION</th> <th>FUNCTION METH</th> <th>FUNCTION VALUE</th> </tr> </thead> <tbody> <tr> <td>1</td> <td>N</td> <td>1</td> <td>f</td> <td>2.414 475 GHz</td> <td>-10.614 dBm</td> <td></td> <td></td> <td></td> </tr> <tr> <td>2</td> <td>N</td> <td>1</td> <td>f</td> <td>2.400 000 GHz</td> <td>-44.708 dBm</td> <td></td> <td></td> <td></td> </tr> <tr> <td>3</td> <td>N</td> <td>1</td> <td>f</td> <td>2.390 000 GHz</td> <td>-64.732 dBm</td> <td></td> <td></td> <td></td> </tr> <tr> <td>4</td> <td>N</td> <td>1</td> <td>f</td> <td>2.387 045 GHz</td> <td>-50.523 dBm</td> <td></td> <td></td> <td></td> </tr> </tbody> </table>	MNR	MODE	TRC	SCL	X	Y	FUNCTION	FUNCTION METH	FUNCTION VALUE	1	N	1	f	2.414 475 GHz	-10.614 dBm				2	N	1	f	2.400 000 GHz	-44.708 dBm				3	N	1	f	2.390 000 GHz	-64.732 dBm				4	N	1	f	2.387 045 GHz	-50.523 dBm			
MNR	MODE	TRC	SCL	X	Y	FUNCTION	FUNCTION METH	FUNCTION VALUE																																						
1	N	1	f	2.414 475 GHz	-10.614 dBm																																									
2	N	1	f	2.400 000 GHz	-44.708 dBm																																									
3	N	1	f	2.390 000 GHz	-64.732 dBm																																									
4	N	1	f	2.387 045 GHz	-50.523 dBm																																									

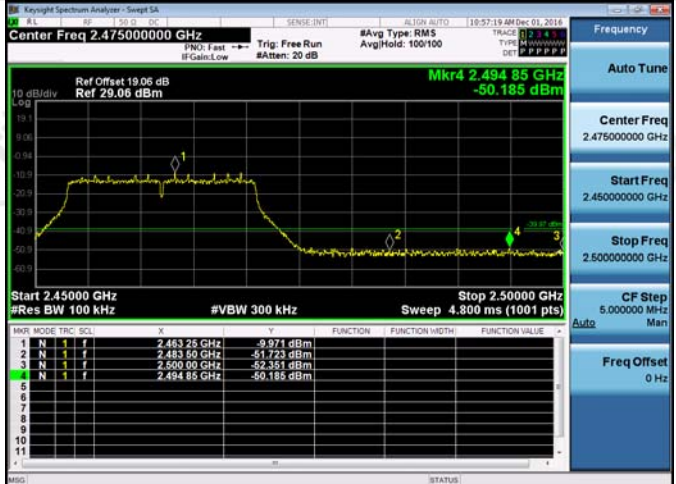
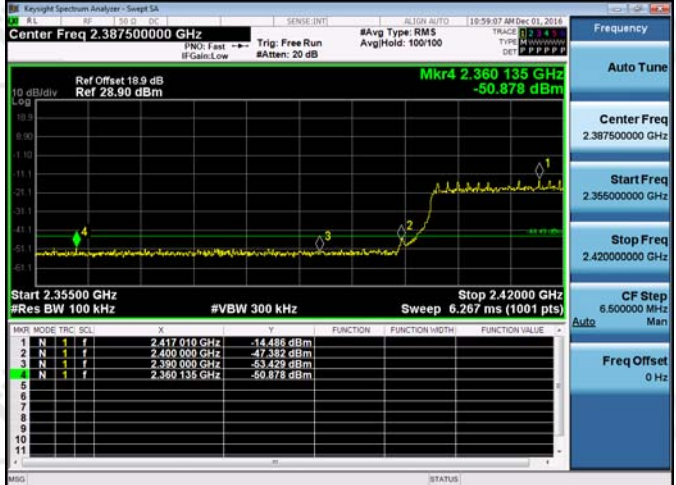
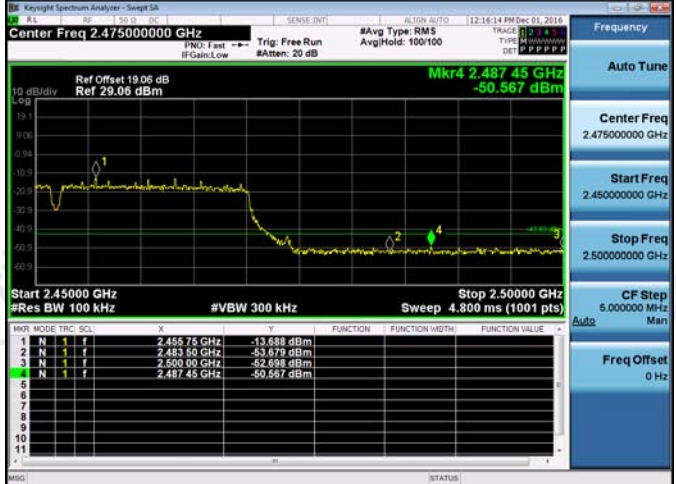
<p>11N20SISO/HCH</p>	
<p>11N40SISO/LCH</p>	
<p>11N40SISO/HCH</p>	

Appendix D): RF Conducted Spurious Emissions

Result Table

Mode	Channel	Pref [dBm]	Puw[dBm]	Verdict
11B	LCH	-3.157	<Limit	PASS
11B	MCH	-2.704	<Limit	PASS
11B	HCH	-2.634	<Limit	PASS
11G	LCH	-11.05	<Limit	PASS
11G	MCH	-9.85	<Limit	PASS
11G	HCH	-9.74	<Limit	PASS
11N20SISO	LCH	-10.256	<Limit	PASS
11N20SISO	MCH	-9.562	<Limit	PASS
11N20SISO	HCH	-9.987	<Limit	PASS
11N40SISO	LCH	-14.19	<Limit	PASS
11N40SISO	MCH	-14.54	<Limit	PASS
11N40SISO	HCH	-13.564	<Limit	PASS

Test Graph

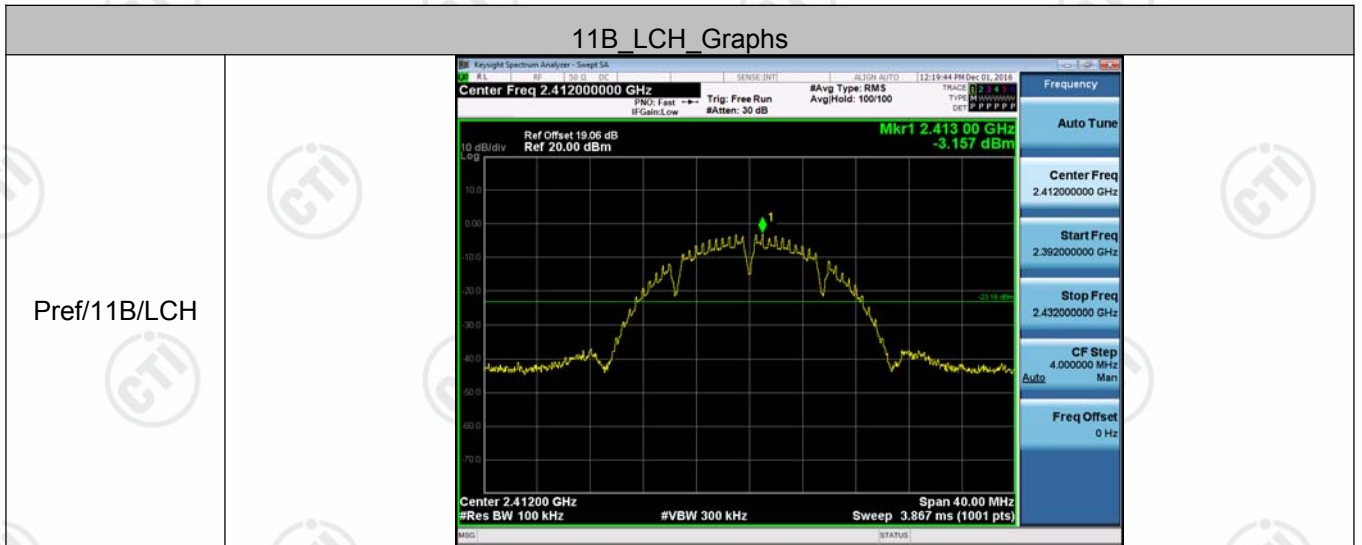

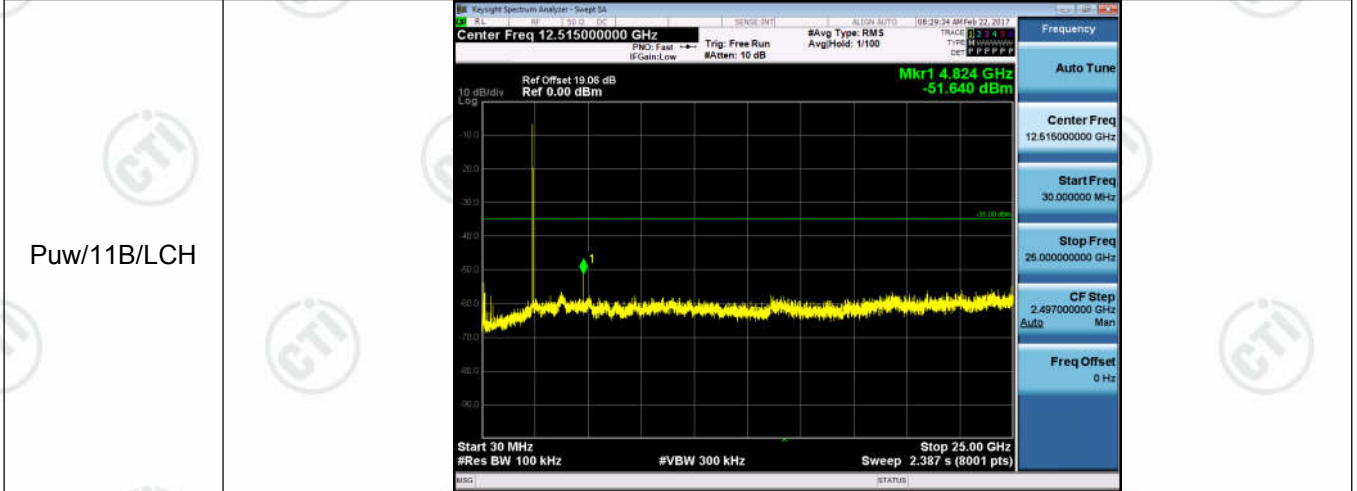

11B_MCH_Graphs

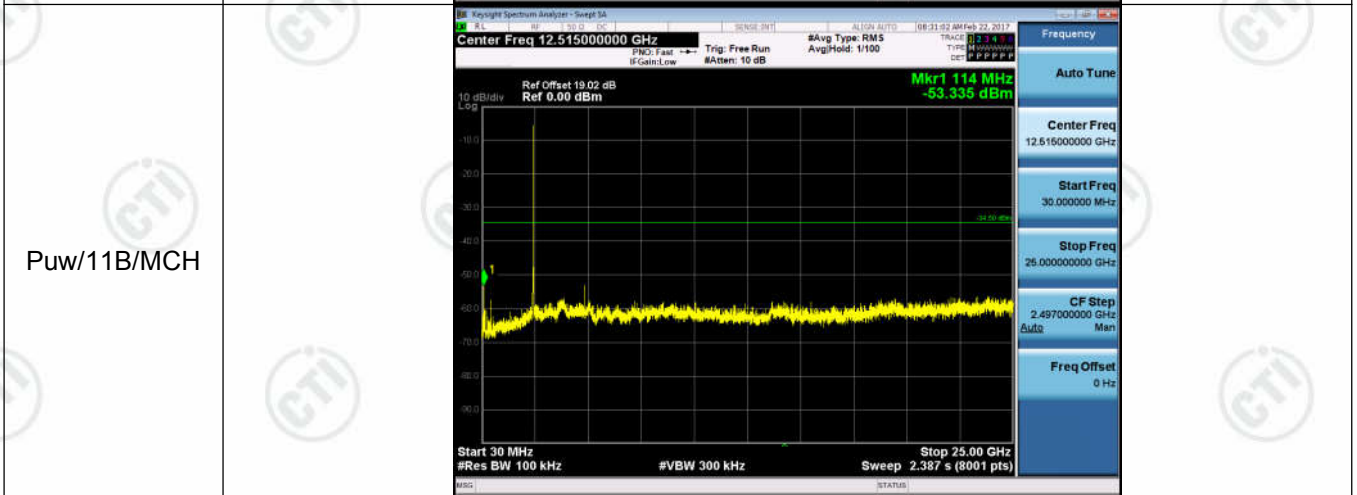
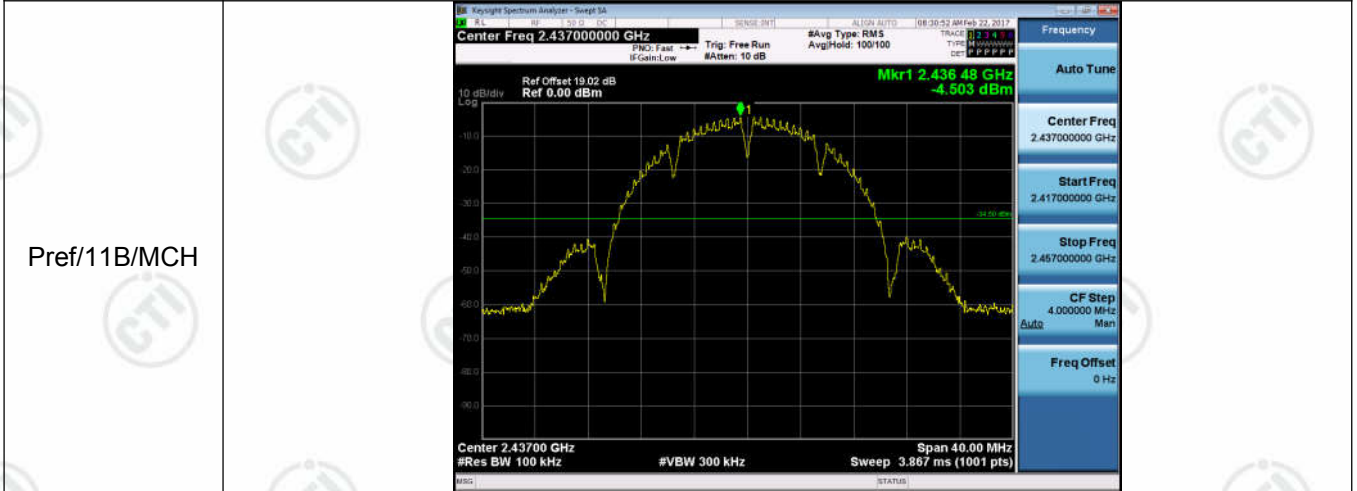

11B_HCH_Graphs

Pref/11B/HCH

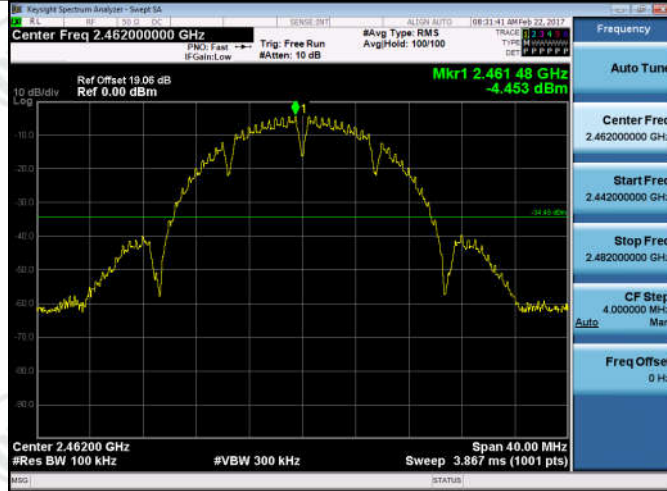

Puw/11B/HCH

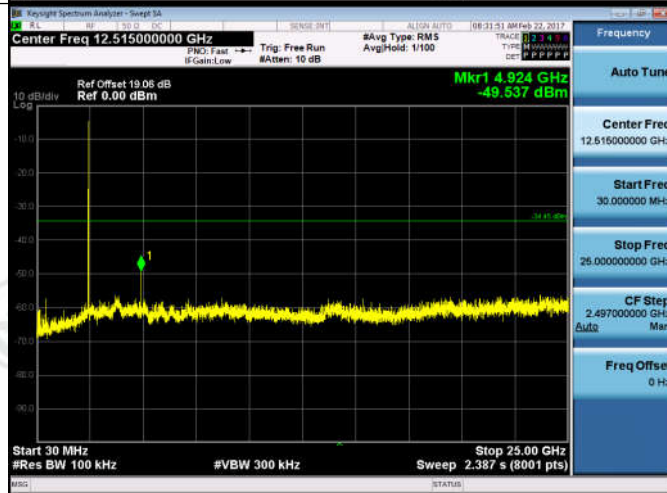

11G_LCH_Graphs

Pref/11G/LCH

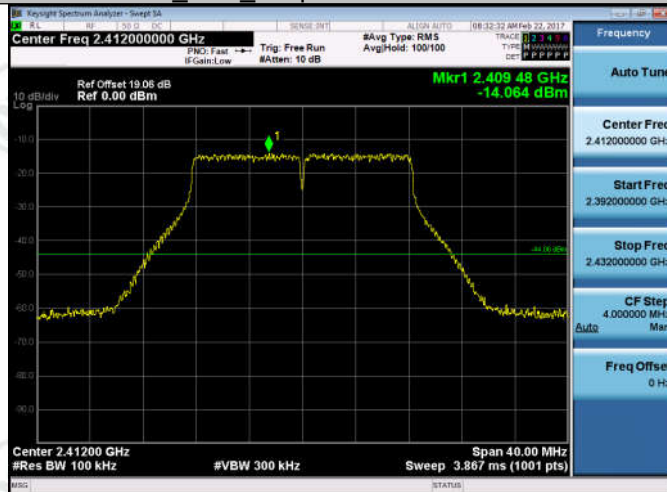

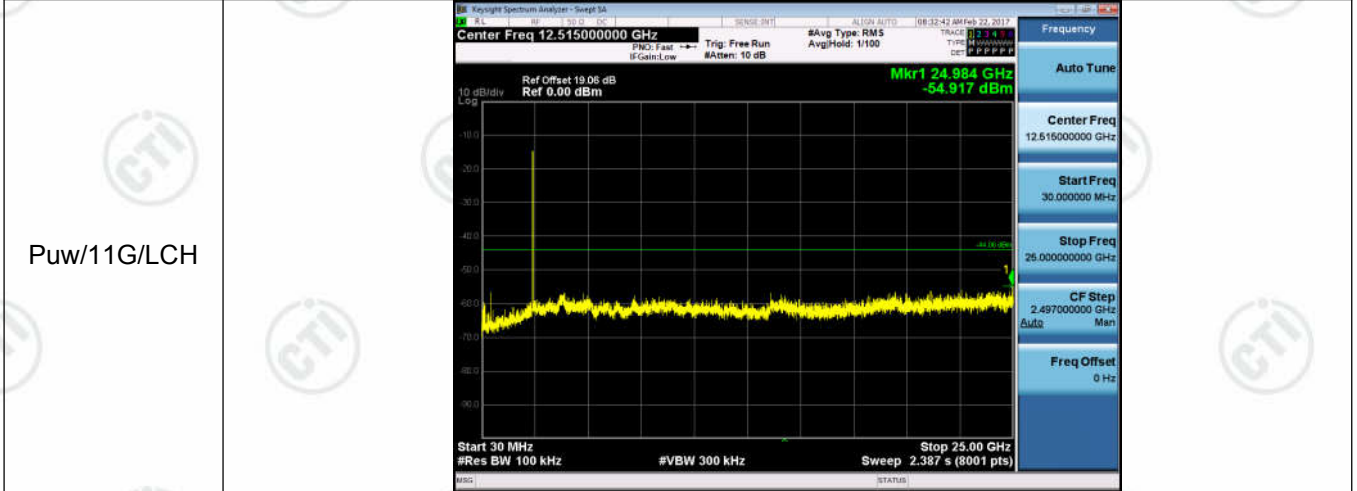

11G_MCH_Graphs

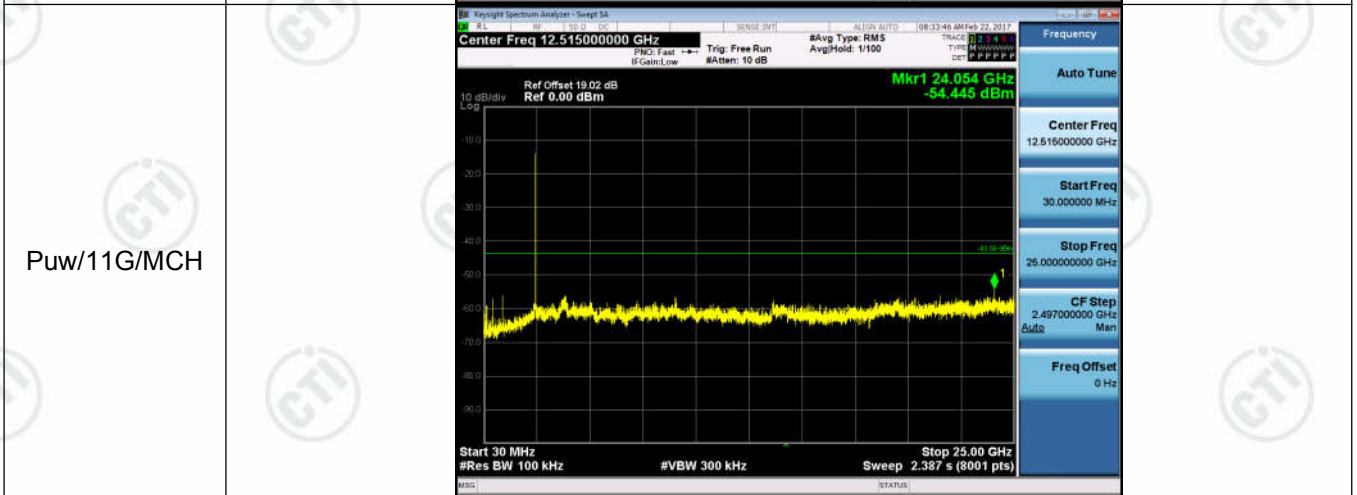
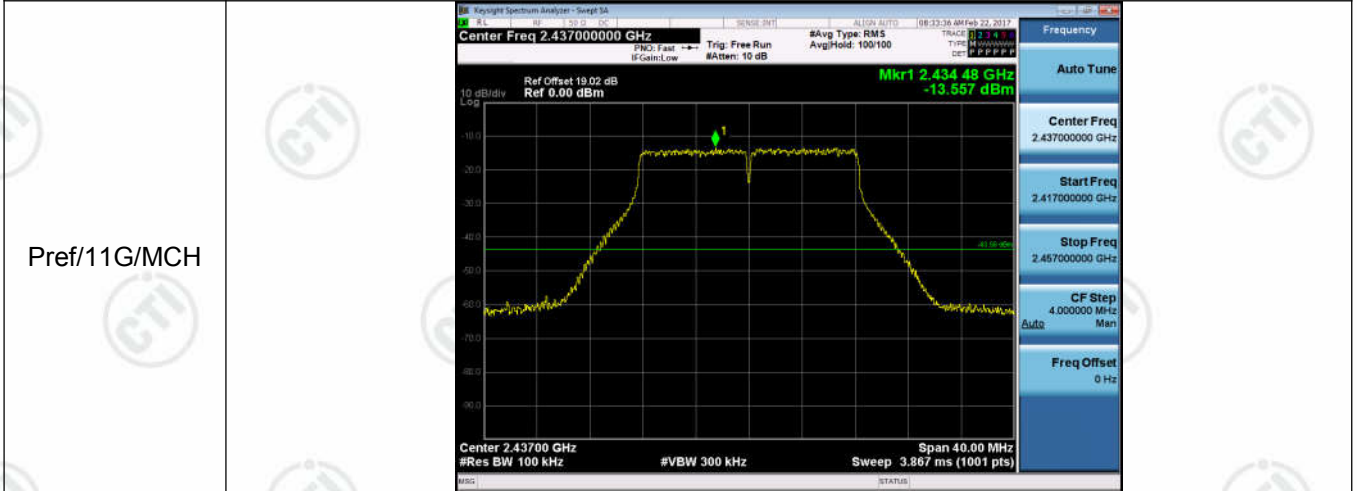

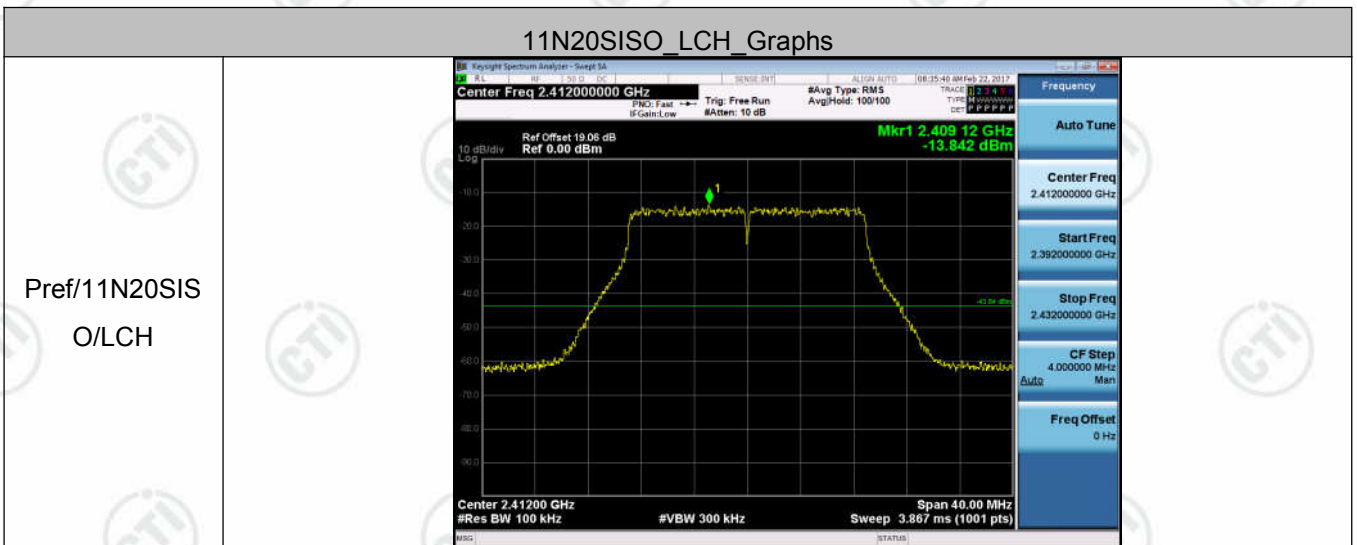
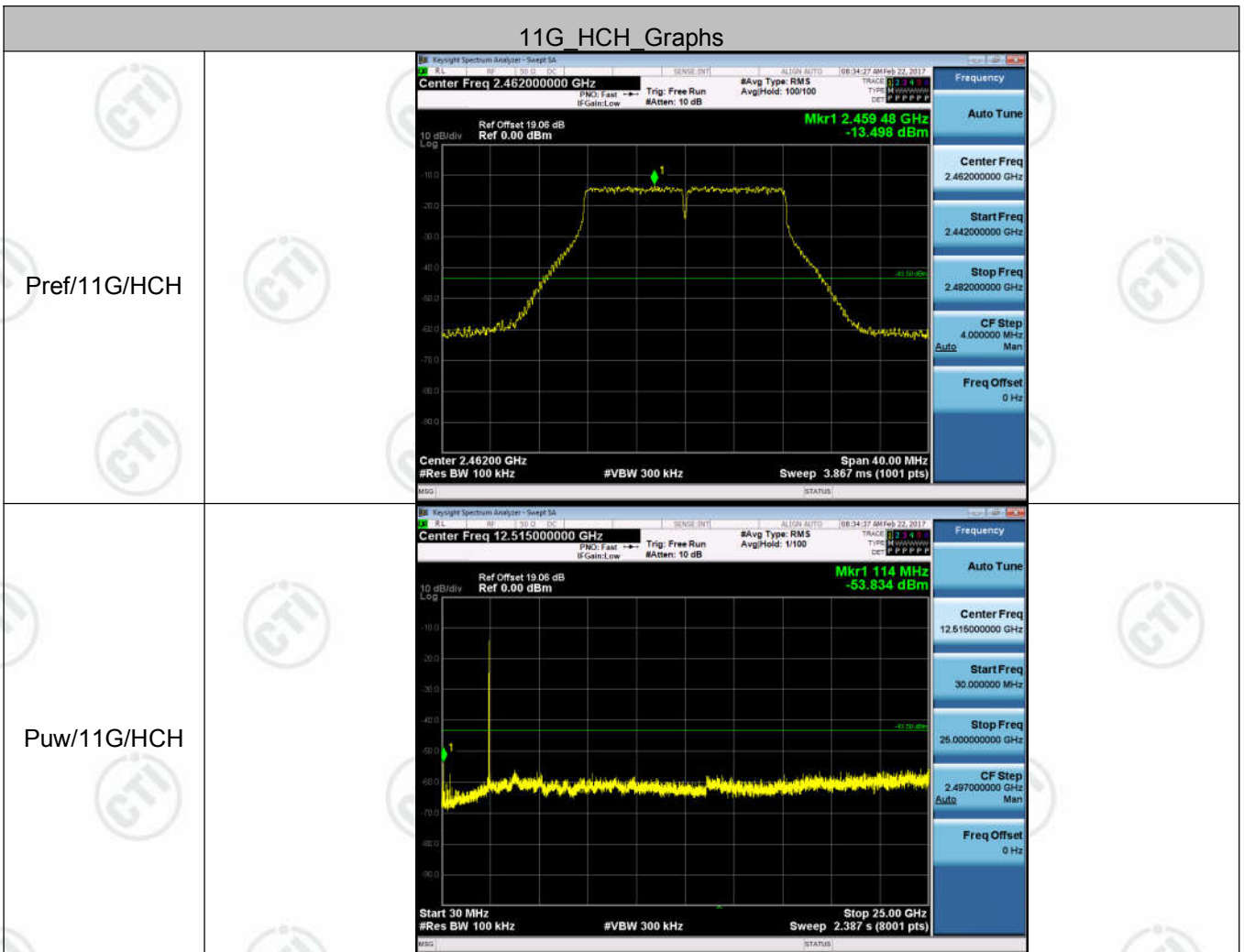

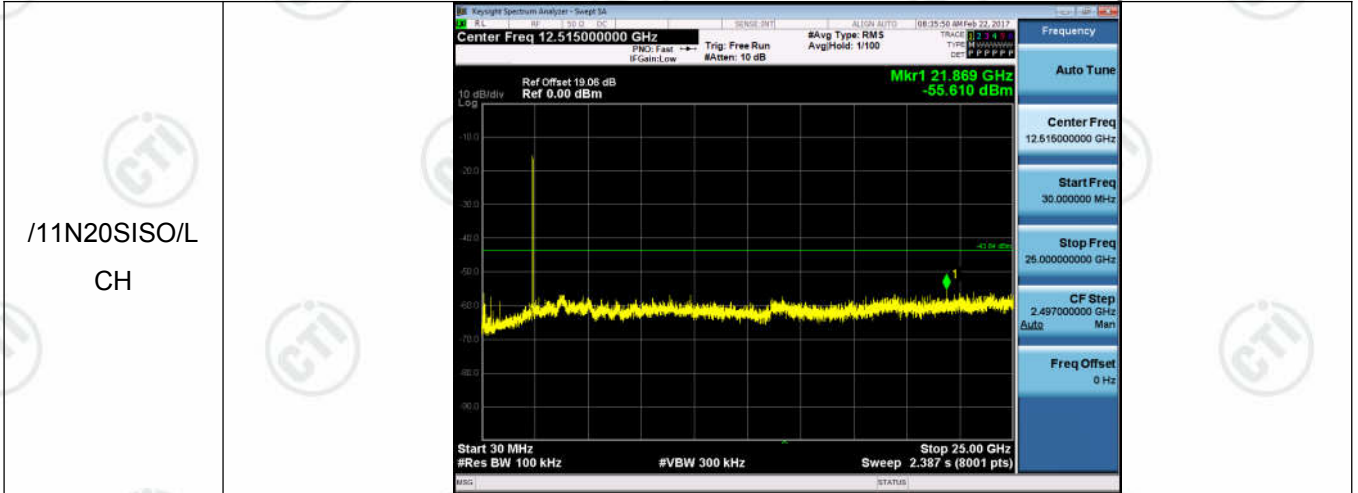

11N20SISO_MCH_Graphs

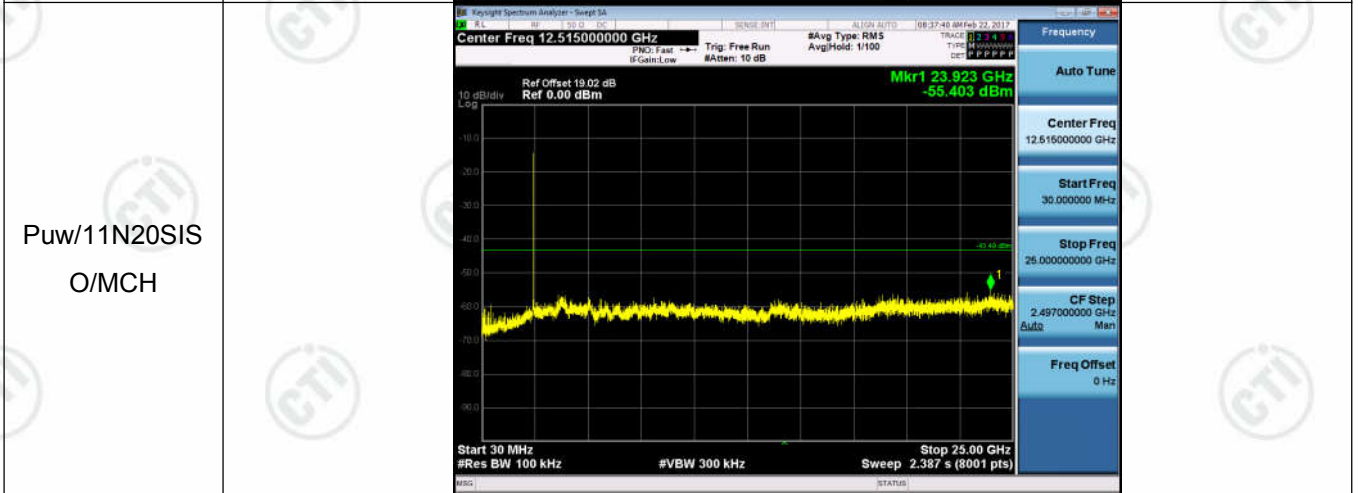
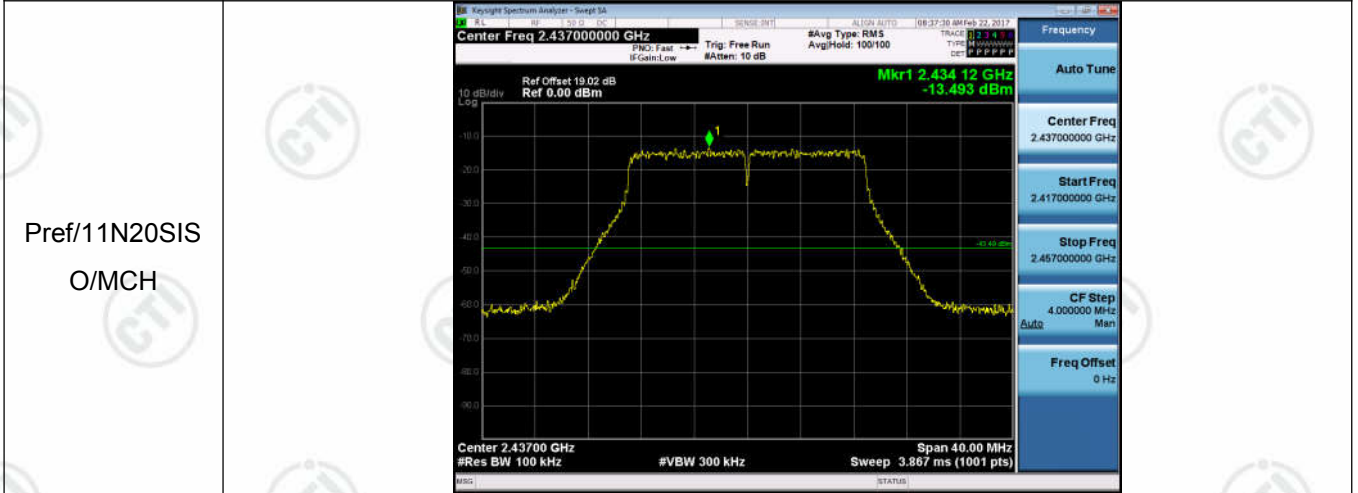

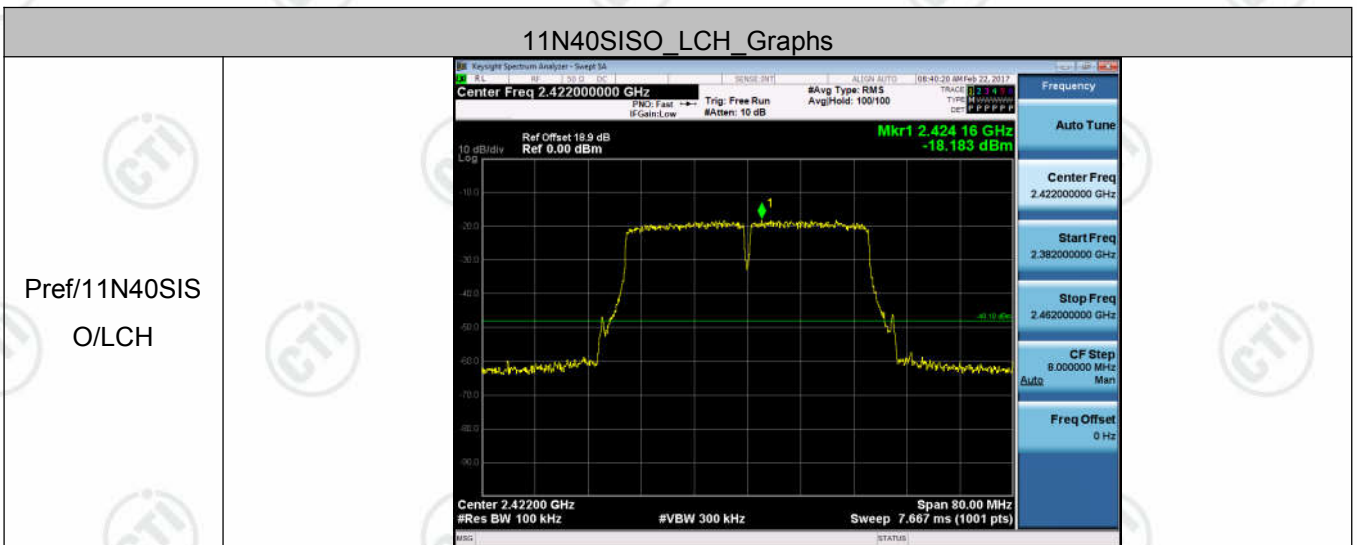
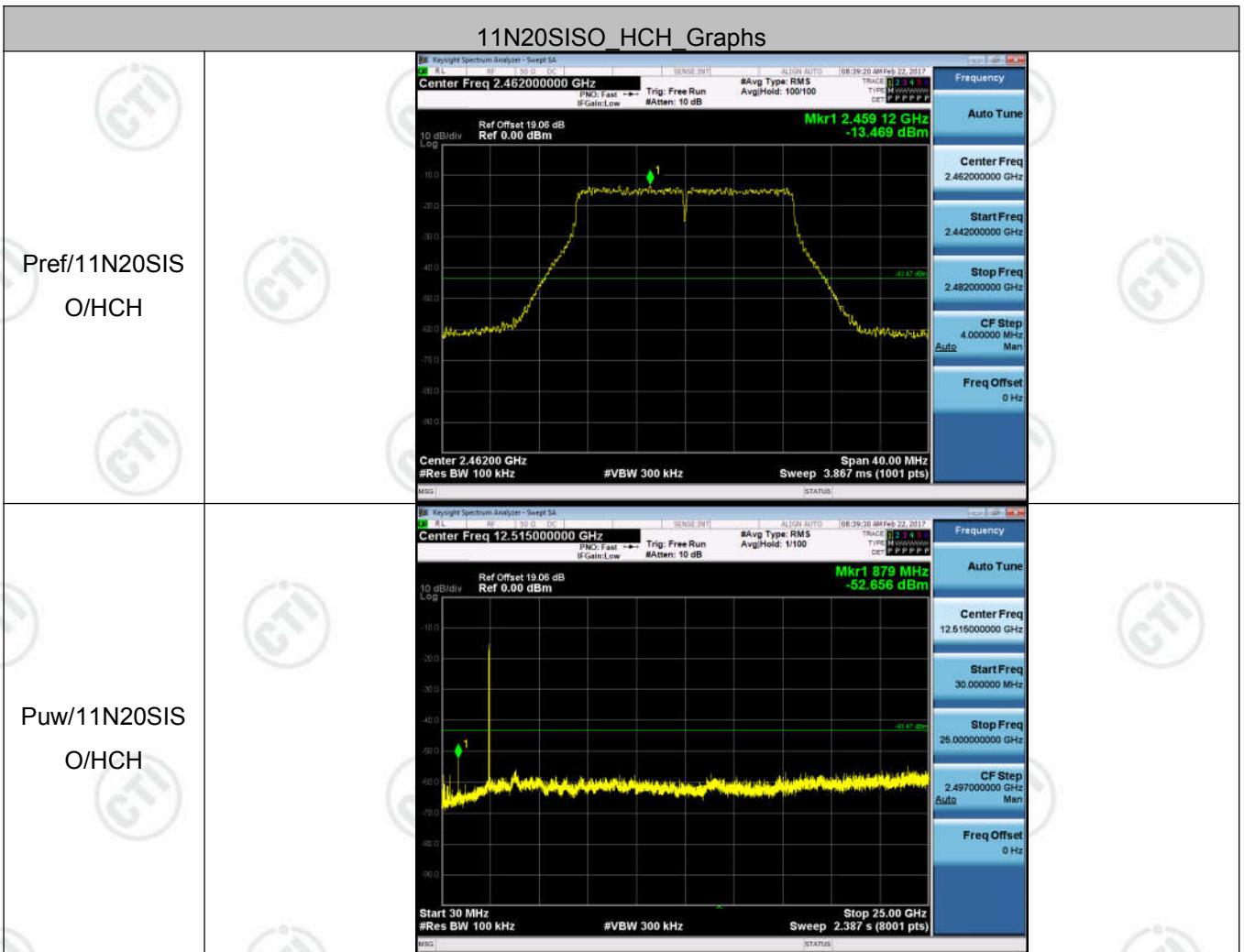

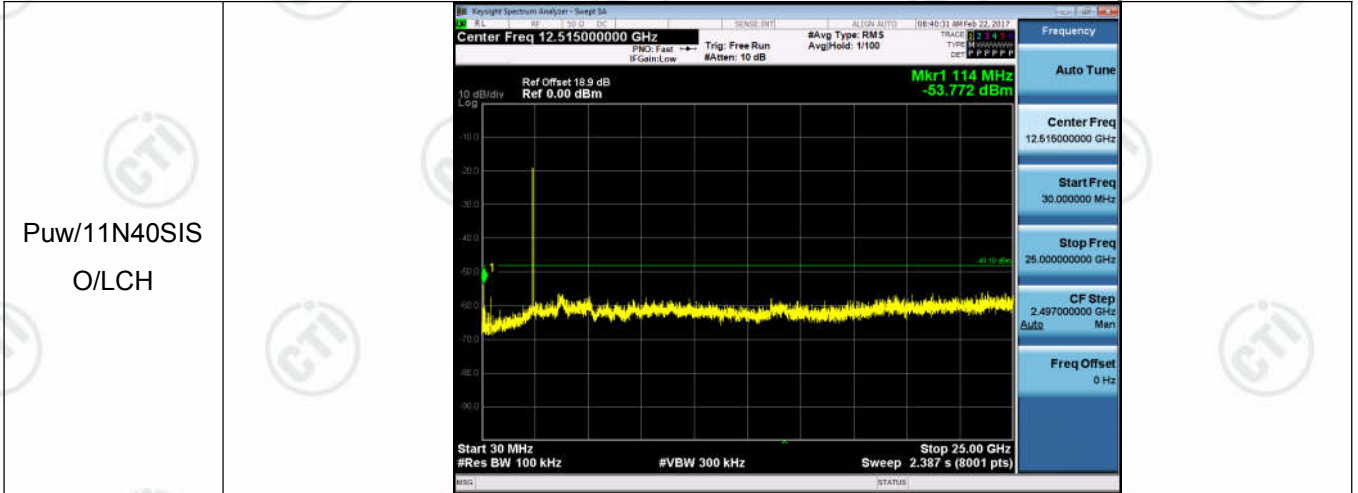

11N40SISO_MCH_Graphs

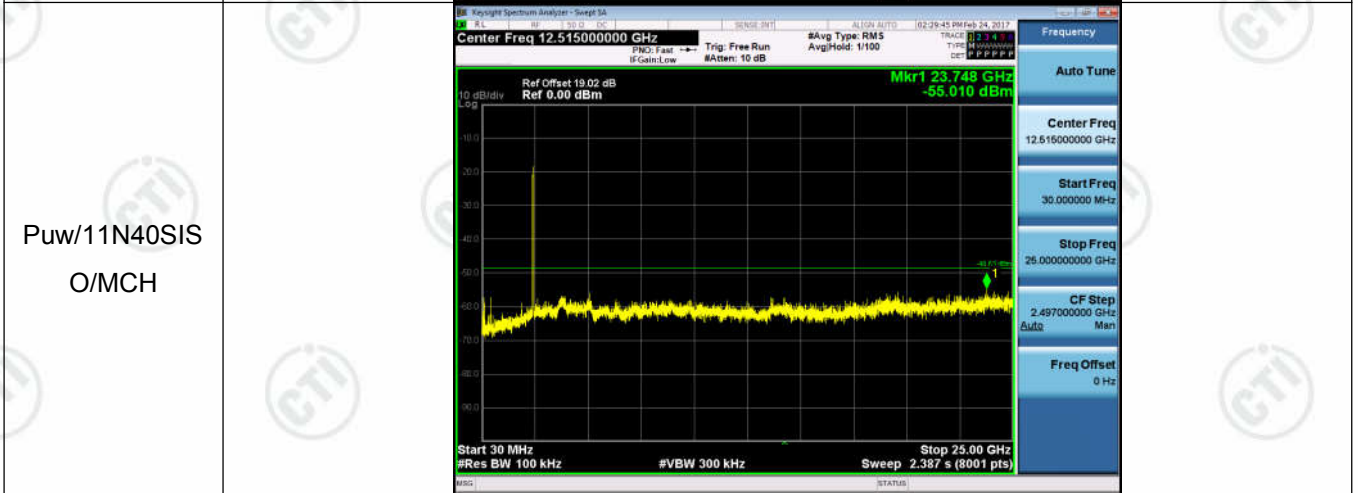
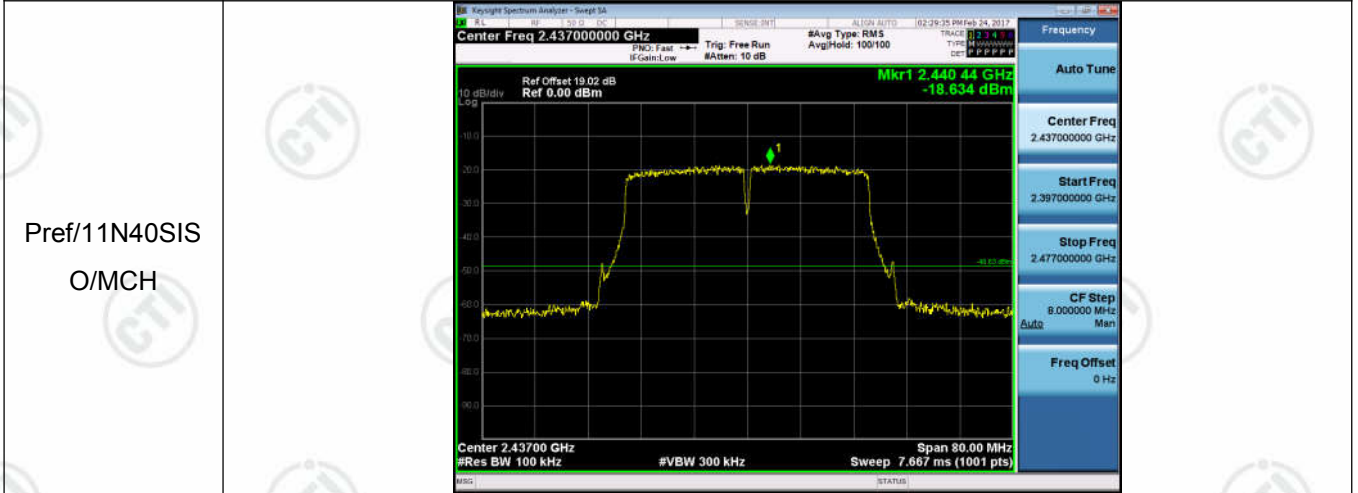

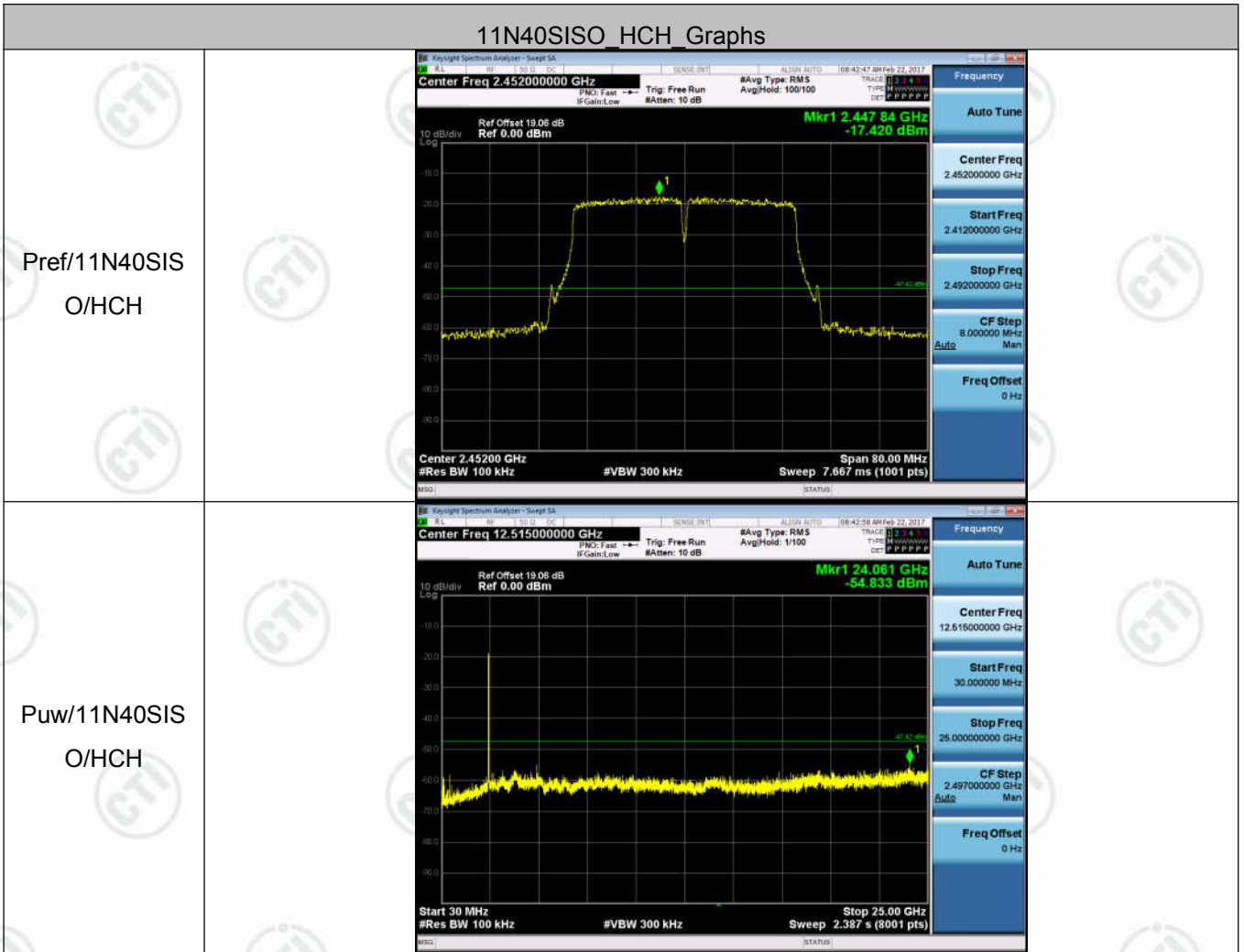

Appendix E): Power Spectral Density

Result Table

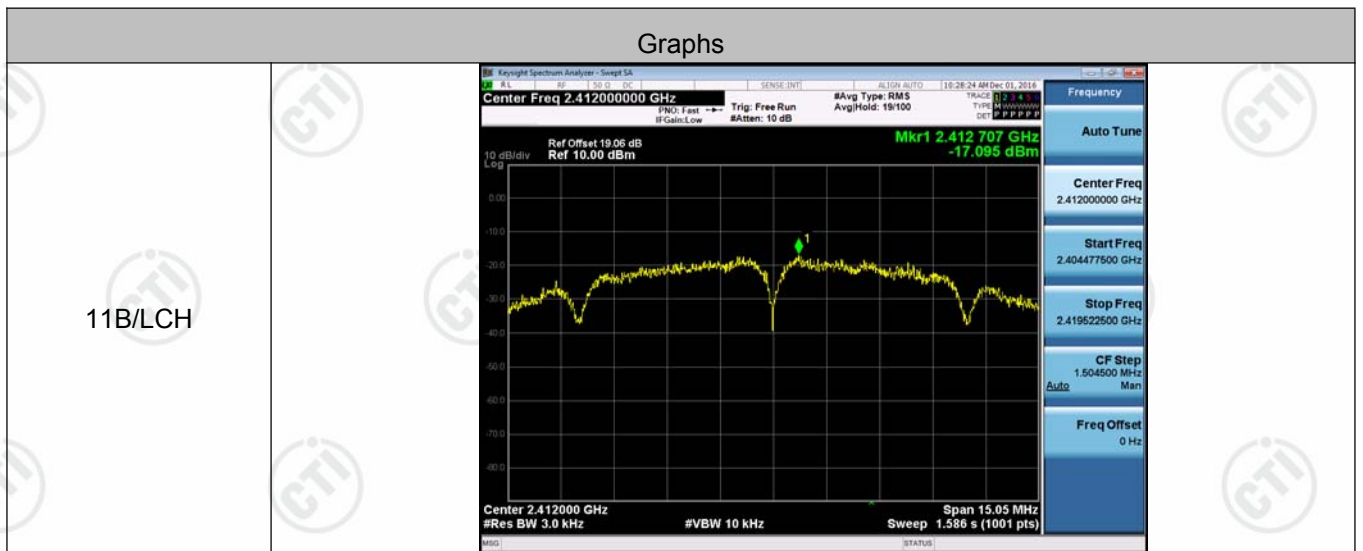

Mode	Channel	Power Spectral Density [dBm]	Verdict
11B	LCH	-17.095	PASS
11B	MCH	-16.444	PASS
11B	HCH	-15.935	PASS
11G	LCH	-24.233	PASS
11G	MCH	-24.563	PASS
11G	HCH	-23.742	PASS
11N20SISO	LCH	-25.000	PASS
11N20SISO	MCH	-23.689	PASS
11N20SISO	HCH	-22.782	PASS
11N40SISO	LCH	-28.488	PASS
11N40SISO	MCH	-28.129	PASS
11N40SISO	HCH	-28.510	PASS

Test Graph

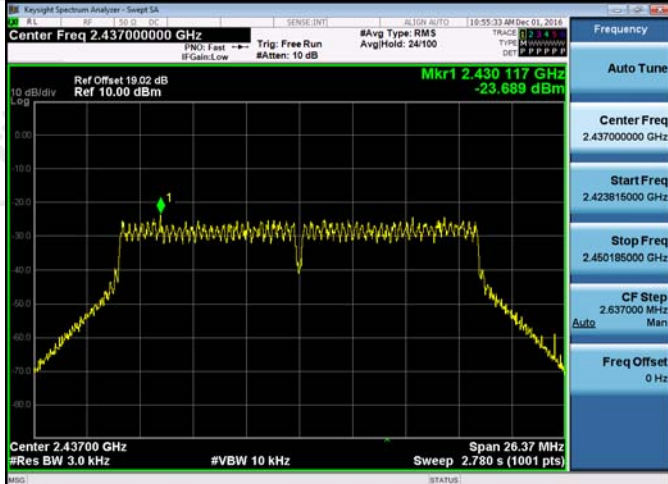
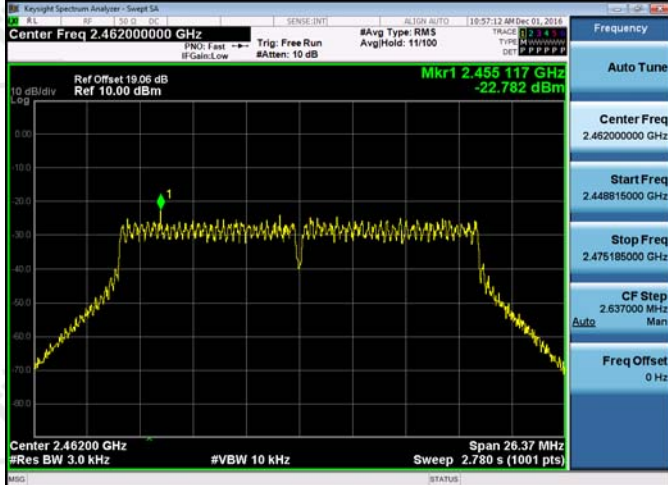

<p>11B/MCH</p>	
<p>11B/HCH</p>	
<p>11G/LCH</p>	

<p>11G/MCH</p>	
<p>11G/HCH</p>	
<p>11N20SISO/LCH</p>	

<p>11N20SISO/MCH</p>	 <p>Center Freq 2.43700000 GHz</p> <p>Mkr1 2.430 117 GHz -23.689 dBm</p> <p>Center 2.43700 GHz #Res BW 3.0 kHz #VBW 10 kHz Span 26.37 MHz Sweep 2.780 s (1001 pts)</p>
<p>11N20SISO/HCH</p>	 <p>Center Freq 2.46200000 GHz</p> <p>Mkr1 2.455 117 GHz -22.782 dBm</p> <p>Center 2.46200 GHz #Res BW 3.0 kHz #VBW 10 kHz Span 26.37 MHz Sweep 2.780 s (1001 pts)</p>
<p>11N40SISO/LCH</p>	 <p>Center Freq 2.42200000 GHz</p> <p>Mkr1 2.435 49 GHz -28.488 dBm</p> <p>Center 2.42200 GHz #Res BW 3.0 kHz #VBW 10 kHz Span 53.54 MHz Sweep 5.645 s (1001 pts)</p>

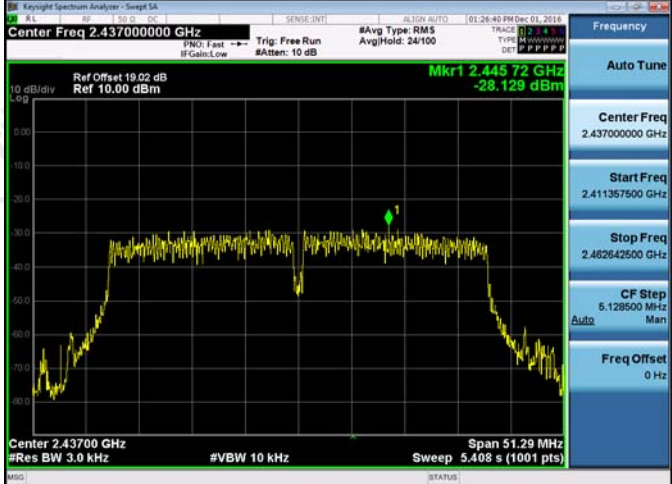
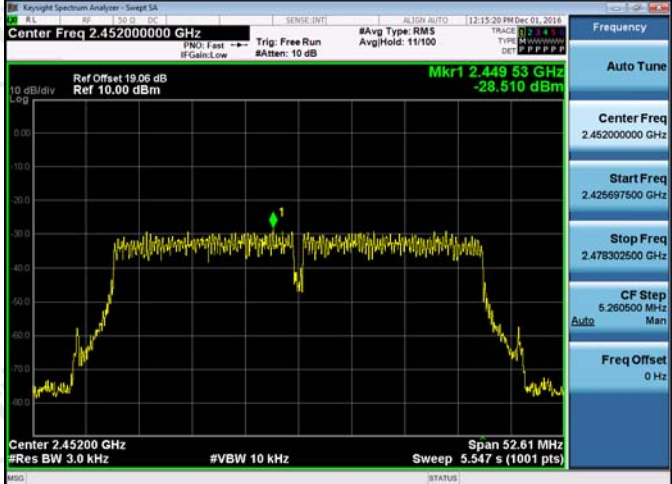
<p>11N40SISO/MCH</p>	
<p>11N40SISO/HCH</p>	

Appendix F): Antenna Requirement

15.203 requirement:

An intentional radiator shall be designed to ensure that no antenna other than that furnished by the responsible party shall be used with the device. The use of a permanently attached antenna or of an antenna that uses a unique coupling to the intentional radiator, the manufacturer may design the unit so that a broken antenna can be replaced by the user, but the use of a standard antenna jack or electrical connector is prohibited.

15.247(b) (4) requirement:

The conducted output power limit specified in paragraph (b) of this section is based on the use of antennas with directional gains that do not exceed 6 dBi. Except as shown in paragraph (c) of this section, if transmitting antennas of directional gain greater than 6 dBi are used, the conducted output power from the intentional radiator shall be reduced below the stated values in paragraphs (b)(1), (b)(2), and (b)(3) of this section, as appropriate, by the amount in dB that the directional gain of the antenna exceeds 6 dBi.

EUT Antenna:

The antenna is PIFA antenna and no consideration of replacement. The best case gain of the antenna is 0dBi.



Appendix G): AC Power Line Conducted Emission

<p>Test Procedure:</p>	<p>Test frequency range :150KHz-30MHz</p> <ol style="list-style-type: none"> 1)The mains terminal disturbance voltage test was conducted in a shielded room. 2) The EUT was connected to AC power source through a LISN 1 (Line Impedance Stabilization Network) which provides a 50Ω/50μH + 5Ω linear impedance. The power cables of all other units of the EUT were connected to a second LISN 2, which was bonded to the ground reference plane in the same way as the LISN 1 for the unit being measured. A multiple socket outlet strip was used to connect multiple power cables to a single LISN provided the rating of the LISN was not exceeded. 3)The tabletop EUT was placed upon a non-metallic table 0.8m above the ground reference plane. And for floor-standing arrangement, the EUT was placed on the horizontal ground reference plane, 4) The test was performed with a vertical ground reference plane. The rear of the EUT shall be 0.4 m from the vertical ground reference plane. The vertical ground reference plane was bonded to the horizontal ground reference plane. The LISN 1 was placed 0.8 m from the boundary of the unit under test and bonded to a ground reference plane for LISNs mounted on top of the ground reference plane. This distance was between the closest points of the LISN 1 and the EUT. All other units of the EUT and associated equipment was at least 0.8 m from the LISN 2. 5) In order to find the maximum emission, the relative positions of equipment and all of the interface cables must be changed according to ANSI C63.10 on conducted measurement. 														
<p>Limit:</p>	<table border="1" data-bbox="464 1061 1331 1279"> <thead> <tr> <th rowspan="2">Frequency range (MHz)</th> <th colspan="2">Limit (dBμV)</th> </tr> <tr> <th>Quasi-peak</th> <th>Average</th> </tr> </thead> <tbody> <tr> <td>0.15-0.5</td> <td>66 to 56*</td> <td>56 to 46*</td> </tr> <tr> <td>0.5-5</td> <td>56</td> <td>46</td> </tr> <tr> <td>5-30</td> <td>60</td> <td>50</td> </tr> </tbody> </table> <p>* The limit decreases linearly with the logarithm of the frequency in the range 0.15 MHz to 0.50 MHz. NOTE : The lower limit is applicable at the transition frequency</p>	Frequency range (MHz)	Limit (dBμV)		Quasi-peak	Average	0.15-0.5	66 to 56*	56 to 46*	0.5-5	56	46	5-30	60	50
Frequency range (MHz)	Limit (dBμV)														
	Quasi-peak	Average													
0.15-0.5	66 to 56*	56 to 46*													
0.5-5	56	46													
5-30	60	50													

Measurement Data

An initial pre-scan was performed on the live and neutral lines with peak detector.

Quasi-Peak and Average measurement were performed at the frequencies with maximized peak emission were detected.

Live line:

80.0 dBuV

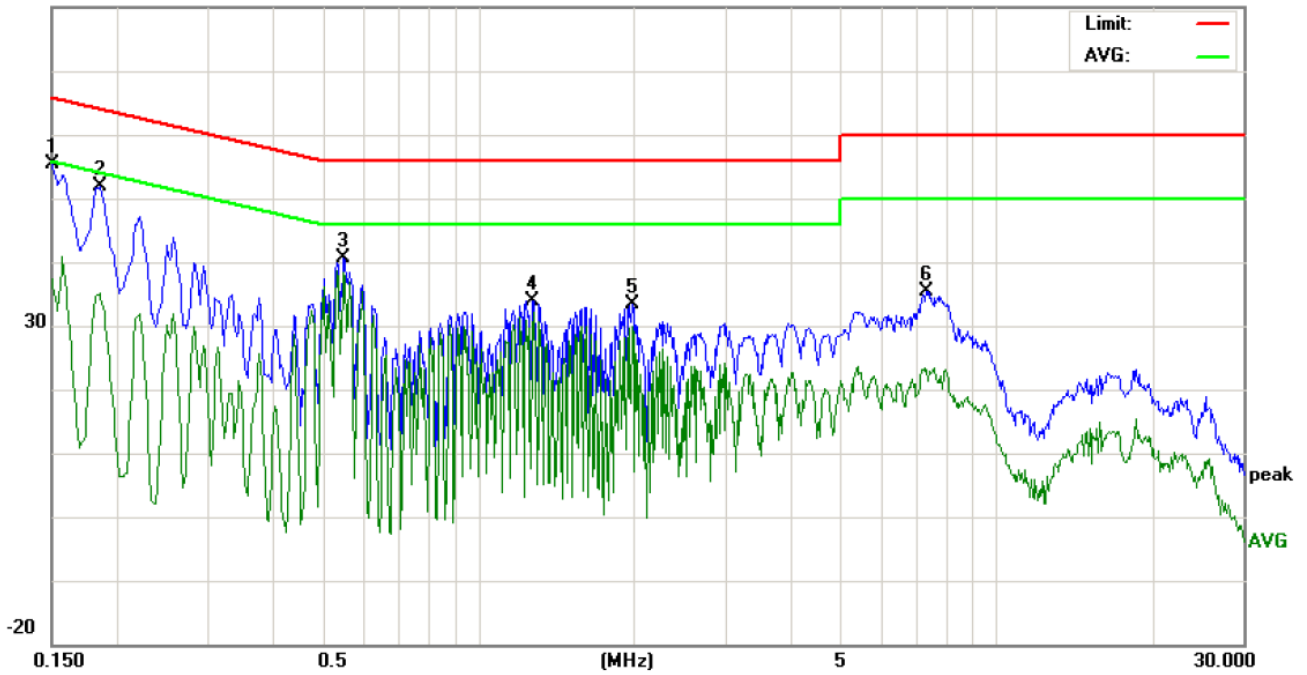

No.	Freq. MHz	Reading_Level (dBuV)			Correct Factor dB	Measurement (dBuV)			Limit (dBuV)		Margin (dB)		P/F	Comment
		Peak	QP	AVG		peak	QP	AVG	QP	AVG	QP	AVG		
1	0.1500	45.66		27.61	9.80	55.46		37.41	65.99	55.99	-10.53	-18.58	P	
2	0.1860	42.08		25.23	9.80	51.88		35.03	64.21	54.21	-12.33	-19.18	P	
3	0.5500	30.62		28.51	9.90	40.52		38.41	56.00	46.00	-15.48	-7.59	P	
4	1.2740	24.16		19.36	9.78	33.94		29.14	56.00	46.00	-22.06	-16.86	P	
5	1.9900	23.37		19.81	10.00	33.37		29.81	56.00	46.00	-22.63	-16.19	P	
6	7.3460	25.29		13.02	10.00	35.29		23.02	60.00	50.00	-24.71	-26.98	P	

Neutral line:

80.0 dBuV

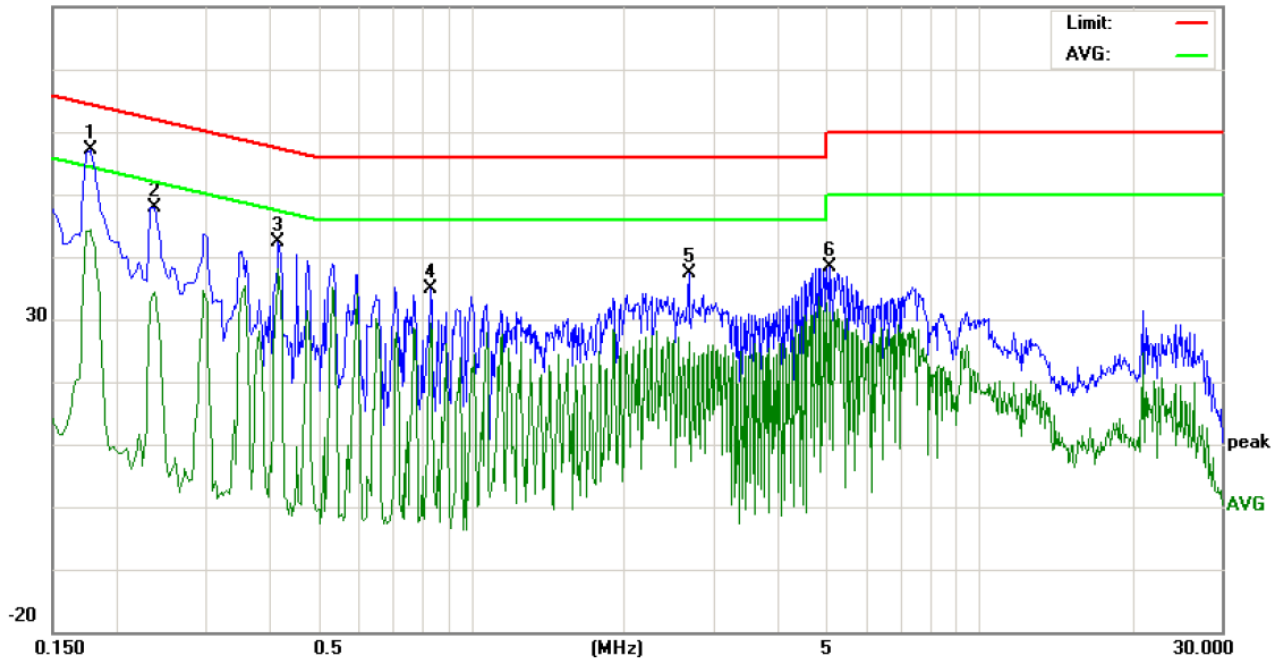

No.	Freq. MHz	Reading_Level (dBuV)			Correct Factor dB	Measurement (dBuV)			Limit (dBuV)		Margin (dB)		P/F	Comment
		Peak	QP	AVG		peak	QP	AVG	QP	AVG	QP	AVG		
1	0.1780	47.44		34.48	9.80	57.24	44.28	64.57	54.57	-7.33	-10.29	P		
2	0.2380	38.02		24.47	9.80	47.82	34.27	62.16	52.16	-14.34	-17.89	P		
3	0.4180	32.39		28.14	9.90	42.29	38.04	57.49	47.49	-15.20	-9.45	P		
4	0.8340	25.14		19.53	9.83	34.97	29.36	56.00	46.00	-21.03	-16.64	P		
5	2.6820	27.46		16.31	10.00	37.46	26.31	56.00	46.00	-18.54	-19.69	P		
6	5.0700	28.26		21.01	10.00	38.26	31.01	60.00	50.00	-21.74	-18.99	P		

Notes:

1. The following Quasi-Peak and Average measurements were performed on the EUT:
2. Final Test Level = Receiver Reading + LISN Factor + Cable Loss.

Appendix H): Restricted bands around fundamental frequency (Radiated)

Receiver Setup:	<table border="1"> <thead> <tr> <th>Frequency</th> <th>Detector</th> <th>RBW</th> <th>VBW</th> <th>Remark</th> </tr> </thead> <tbody> <tr> <td>30MHz-1GHz</td> <td>Quasi-peak</td> <td>120kHz</td> <td>300kHz</td> <td>Quasi-peak</td> </tr> <tr> <td rowspan="2">Above 1GHz</td> <td>Peak</td> <td>1MHz</td> <td>3MHz</td> <td>Peak</td> </tr> <tr> <td>RMS</td> <td>1MHz</td> <td>3MHz</td> <td>Average</td> </tr> </tbody> </table>	Frequency	Detector	RBW	VBW	Remark	30MHz-1GHz	Quasi-peak	120kHz	300kHz	Quasi-peak	Above 1GHz	Peak	1MHz	3MHz	Peak	RMS	1MHz	3MHz	Average	
Frequency	Detector	RBW	VBW	Remark																	
30MHz-1GHz	Quasi-peak	120kHz	300kHz	Quasi-peak																	
Above 1GHz	Peak	1MHz	3MHz	Peak																	
	RMS	1MHz	3MHz	Average																	
Test Procedure:	<p>Below 1GHz test procedure as below:</p> <ol style="list-style-type: none"> The EUT was placed on the top of a rotating table 0.8 meters above the ground at a 3 meter semi-anechoic chamber. The table was rotated 360 degrees to determine the position of the highest radiation. The EUT was set 3 meters away from the interference-receiving antenna, which was mounted on the top of a variable-height antenna tower. The antenna height is varied from one meter to four meters above the ground to determine the maximum value of the field strength. Both horizontal and vertical polarizations of the antenna are set to make the measurement. For each suspected emission, the EUT was arranged to its worst case and then the antenna was tuned to heights from 1 meter to 4 meters and the rotatable was turned from 0 degrees to 360 degrees to find the maximum reading. The test-receiver system was set to Peak Detect Function and Specified Bandwidth with Maximum Hold Mode. Place a marker at the end of the restricted band closest to the transmit frequency to show compliance. Also measure any emissions in the restricted bands. Save the spectrum analyzer plot. Repeat for each power and modulation for lowest and highest channel <p>Above 1GHz test procedure as below:</p> <ol style="list-style-type: none"> Different between above is the test site, change from Semi- Anechoic Chamber to fully Anechoic Chamber change form table 0.8 meter to 1.5 meter(Above 18GHz the distance is 1 meter and table is 1.5 meter). Test the EUT in the lowest channel , the Highest channel The radiation measurements are performed in X, Y, Z axis positioning for Transmitting mode, and found the X axis positioning which it is worse case. Repeat above procedures until all frequencies measured was complete. 																				
Limit:	<table border="1"> <thead> <tr> <th>Frequency</th> <th>Limit (dBμV/m @3m)</th> <th>Remark</th> </tr> </thead> <tbody> <tr> <td>30MHz-88MHz</td> <td>40.0</td> <td>Quasi-peak Value</td> </tr> <tr> <td>88MHz-216MHz</td> <td>43.5</td> <td>Quasi-peak Value</td> </tr> <tr> <td>216MHz-960MHz</td> <td>46.0</td> <td>Quasi-peak Value</td> </tr> <tr> <td>960MHz-1GHz</td> <td>54.0</td> <td>Quasi-peak Value</td> </tr> <tr> <td rowspan="2">Above 1GHz</td> <td>54.0</td> <td>Average Value</td> </tr> <tr> <td>74.0</td> <td>Peak Value</td> </tr> </tbody> </table>	Frequency	Limit (dB μ V/m @3m)	Remark	30MHz-88MHz	40.0	Quasi-peak Value	88MHz-216MHz	43.5	Quasi-peak Value	216MHz-960MHz	46.0	Quasi-peak Value	960MHz-1GHz	54.0	Quasi-peak Value	Above 1GHz	54.0	Average Value	74.0	Peak Value
Frequency	Limit (dB μ V/m @3m)	Remark																			
30MHz-88MHz	40.0	Quasi-peak Value																			
88MHz-216MHz	43.5	Quasi-peak Value																			
216MHz-960MHz	46.0	Quasi-peak Value																			
960MHz-1GHz	54.0	Quasi-peak Value																			
Above 1GHz	54.0	Average Value																			
	74.0	Peak Value																			

Test plot as follows:

Worse case mode:	802.11b (11Mbps)		
Frequency: 2390.0MHz	Test channel: Lowest	Polarization: Horizontal	Remark: Peak

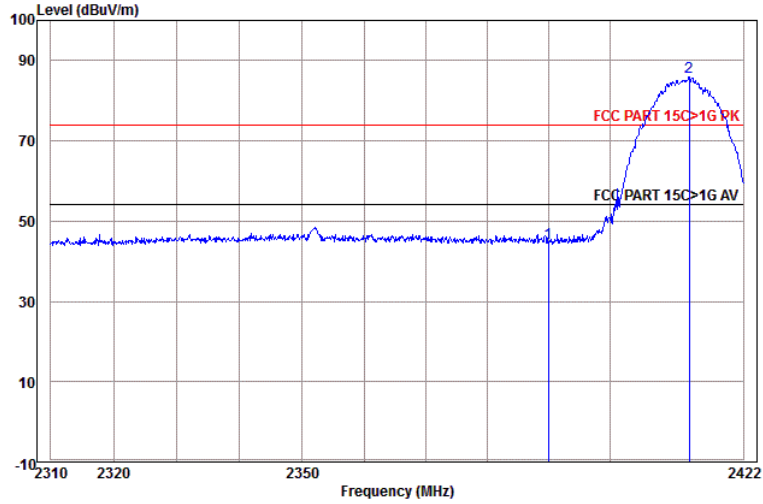

	Ant Freq	Cable Factor	Preamp Loss	Read Level	Limit Level	Over Limit	Pol/Phase	Remark
	MHz	dB/m	dB	dB	dBuV	dBuV/m	dB	
1	2390.000	32.53	4.28	34.39	42.07	44.49	74.00	-29.51 Horizontal
2 pp	2413.072	32.58	4.34	34.39	83.45	85.98	74.00	11.98 Horizontal

Worse case mode:	802.11b (11Mbps)		
Frequency: 2390.0MHz	Test channel: Lowest	Polarization: Vertical	Remark: Peak

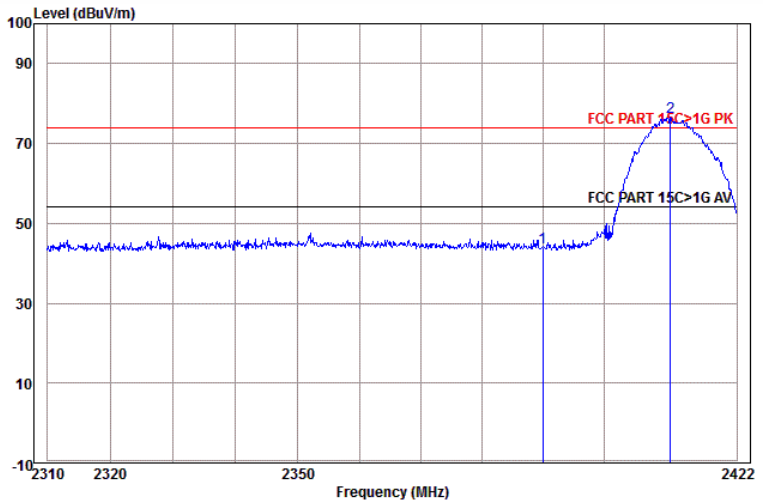

	Ant Freq	Cable Factor	Preamp Loss	Read Level	Limit Level	Over Limit	Pol/Phase	Remark
	MHz	dB/m	dB	dB	dBuV	dBuV/m	dB	
1	2390.000	32.53	4.28	34.39	41.43	43.85	74.00	-30.15 Vertical
2 pp	2411.016	32.58	4.33	34.39	73.99	76.51	74.00	2.51 Vertical

Worse case mode:	802.11b (11Mbps)		
Frequency: 2483.5MHz	Test channel: Highest	Polarization: Horizontal	Remark: Peak

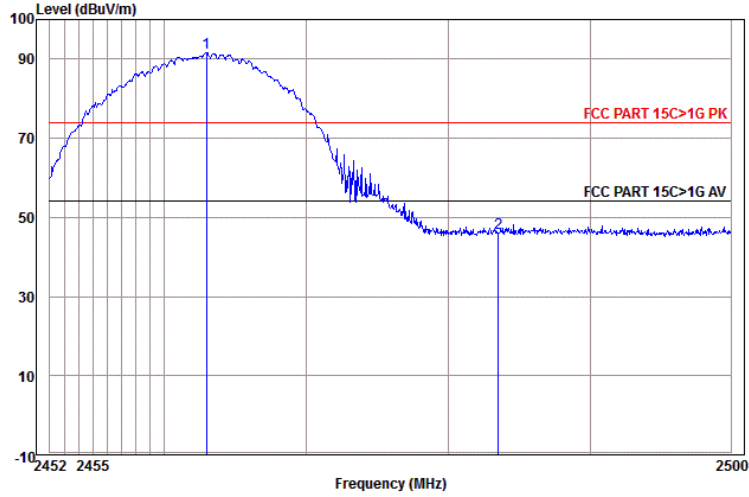

	Ant Freq	Cable Factor	Preamp Factor	Read Level	Limit Level	Over Limit	Pol/Phase	Remark
	MHz	dB/m	dB	dB	dBuV	dBuV/m	dB	
1 pp	2462.958	32.68	4.46	34.40	88.91	91.65	74.00	17.65 Horizontal
2	2483.500	32.71	4.51	34.41	43.38	46.19	74.00	-27.81 Horizontal

Worse case mode:	802.11b (11Mbps)		
Frequency: 2483.5MHz	Test channel: Highest	Polarization: Vertical	Remark: Peak

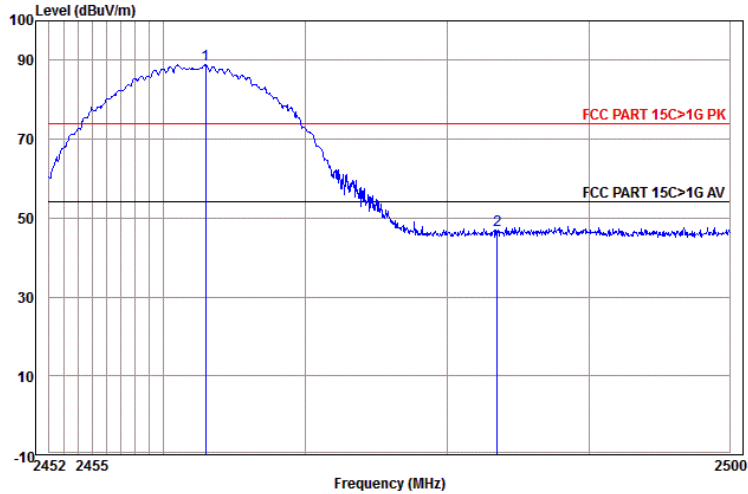

	Ant Freq	Cable Factor	Preamp Factor	Read Level	Limit Level	Over Limit	Pol/Phase	Remark
	MHz	dB/m	dB	dB	dBuV	dBuV/m	dB	
1 pp	2462.958	32.68	4.46	34.40	86.12	88.86	74.00	14.86 Vertical
2	2483.500	32.71	4.51	34.41	44.03	46.84	74.00	-27.16 Vertical

Worse case mode:	802.11g (6Mbps)		
Frequency: 2390.0MHz	Test channel: Lowest	Polarization: Horizontal	Remark: Peak

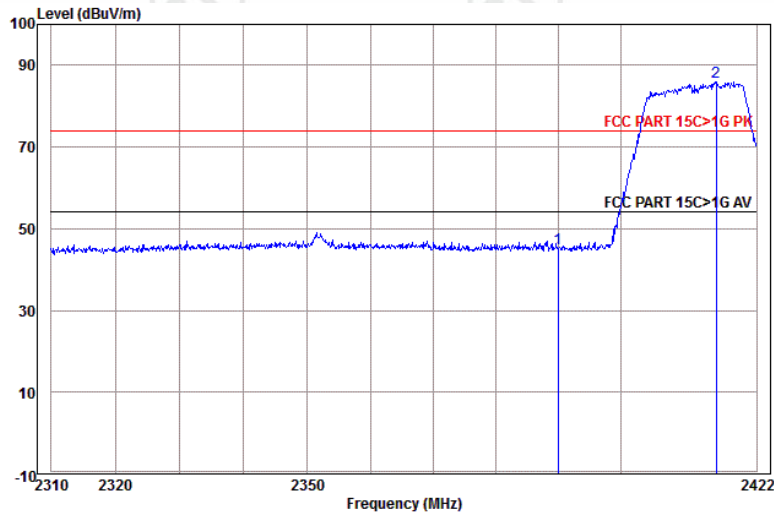

	Ant Freq	Cable Factor	Preamp Loss	Preamp Factor	Read Level	Level	Limit Line	Over Limit	Pol/Phase	Remark
	MHz	dB/m	dB	dB	dBuV	dBuV/m	dBuV/m	dB		
1	2390.000	32.53	4.28	34.39	42.77	45.19	74.00	-28.81	Horizontal	
2 pp	2415.472	32.58	4.34	34.39	83.51	86.04	74.00	12.04	Horizontal	

Worse case mode:	802.11g (6Mbps)		
Frequency: 2390.0MHz	Test channel: Lowest	Polarization: Vertical	Remark: Peak

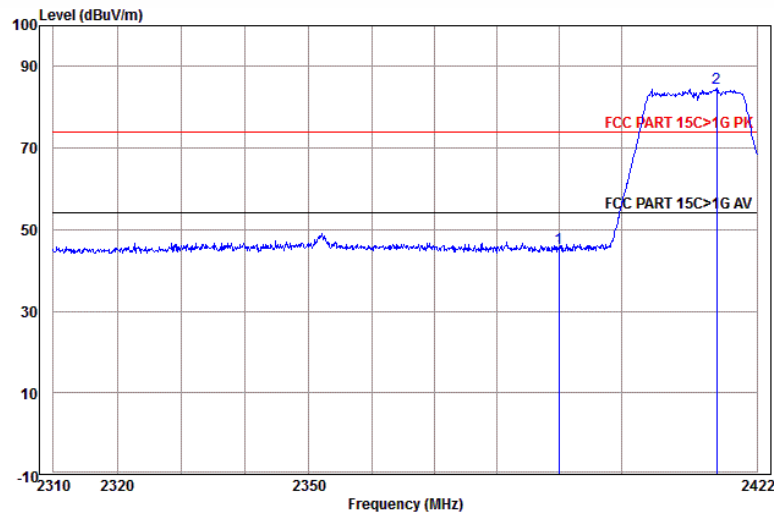

	Ant Freq	Cable Factor	Preamp Loss	Preamp Factor	Read Level	Level	Limit Line	Over Limit	Pol/Phase	Remark
	MHz	dB/m	dB	dB	dBuV	dBuV/m	dBuV/m	dB		
1	2390.000	32.53	4.28	34.39	42.94	45.36	74.00	-28.64	Vertical	
2 pp	2415.472	32.58	4.34	34.39	82.17	84.70	74.00	10.70	Vertical	

Worse case mode:	802.11g (6Mbps)		
Frequency: 2483.5MHz	Test channel: Highest	Polarization: Horizontal	Remark: Peak

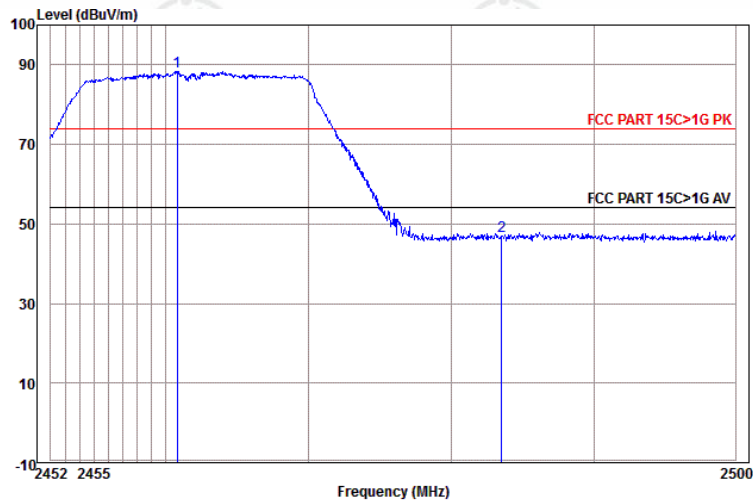

	Ant Freq	Ant Factor	Cable Loss	Preamp Factor	Read Level	Level	Limit Line	Over Limit	Pol/Phase	Remark
	MHz	dB/m	dB	dB	dBuV	dBuV/m	dBuV/m	dB		
1 pp	2460.810	32.67	4.45	34.40	85.64	88.36	74.00	14.36	Horizontal	
2	2483.500	32.71	4.51	34.41	44.09	46.90	74.00	-27.10	Horizontal	

Worse case mode:	802.11g (6Mbps)		
Frequency: 2483.5MHz	Test channel: Highest	Polarization: Vertical	Remark: Peak

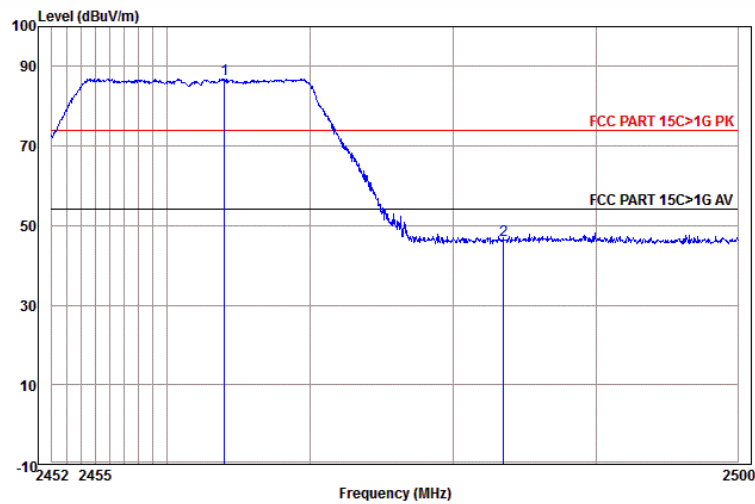

	Ant Freq	Ant Factor	Cable Loss	Preamp Factor	Read Level	Level	Limit Line	Over Limit	Pol/Phase	Remark
	MHz	dB/m	dB	dB	dBuV	dBuV/m	dBuV/m	dB		
1 pp	2464.009	32.68	4.46	34.40	84.14	86.88	74.00	12.88	Vertical	
2	2483.500	32.71	4.51	34.41	43.61	46.42	74.00	-27.58	Vertical	

Worse case mode:	802.11n(HT20) (6.5Mbps)		
Frequency: 2390.0MHz	Test channel: Lowest	Polarization: Horizontal	Remark: Peak

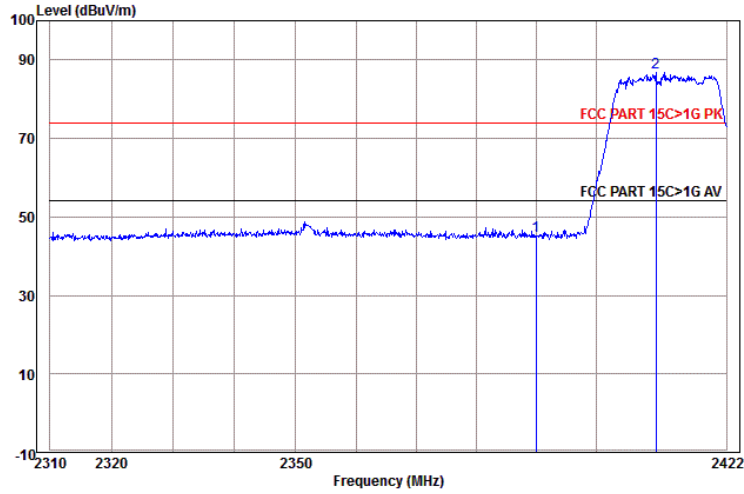

	Freq	Ant Factor	Cable Loss	Preamp Factor	Read Level	Limit Level	Over Limit	Pol/Phase	Remark
	MHz	dB/m	dB	dB	dBuV	dBuV/m	dBuV/m	dB	
1	2390.000	32.53	4.28	34.39	42.67	45.09	74.00	-28.91	Horizontal
2 pp	2410.104	32.57	4.33	34.39	84.20	86.71	74.00	12.71	Horizontal

Worse case mode:	802.11n(HT20) (6.5Mbps)		
Frequency: 2390.0MHz	Test channel: Lowest	Polarization: Vertical	Remark: Peak

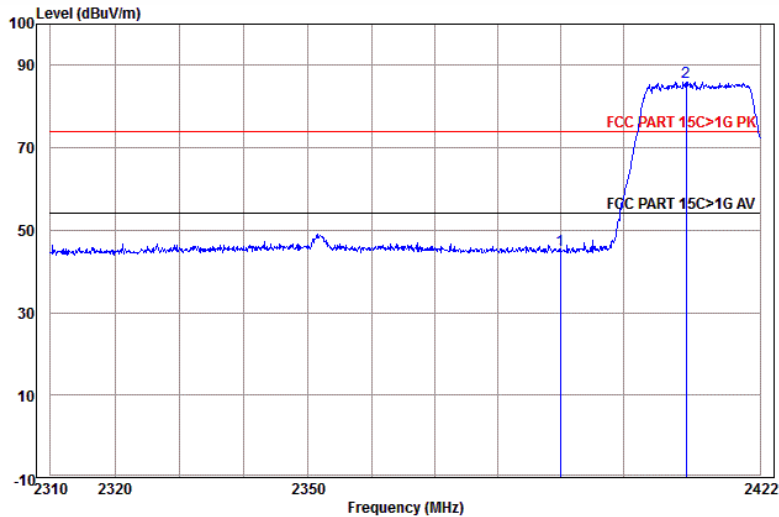

	Freq	Ant Factor	Cable Loss	Preamp Factor	Read Level	Limit Level	Over Limit	Pol/Phase	Remark
	MHz	dB/m	dB	dB	dBuV	dBuV/m	dBuV/m	dB	
1	2390.000	32.53	4.28	34.39	42.76	45.18	74.00	-28.82	Vertical
2 pp	2410.104	32.57	4.33	34.39	83.50	86.01	74.00	12.01	Vertical

Worse case mode:	802.11n(HT20) (6.5Mbps)		
Frequency: 2483.5MHz	Test channel: Highest	Polarization: Horizontal	Remark: Peak

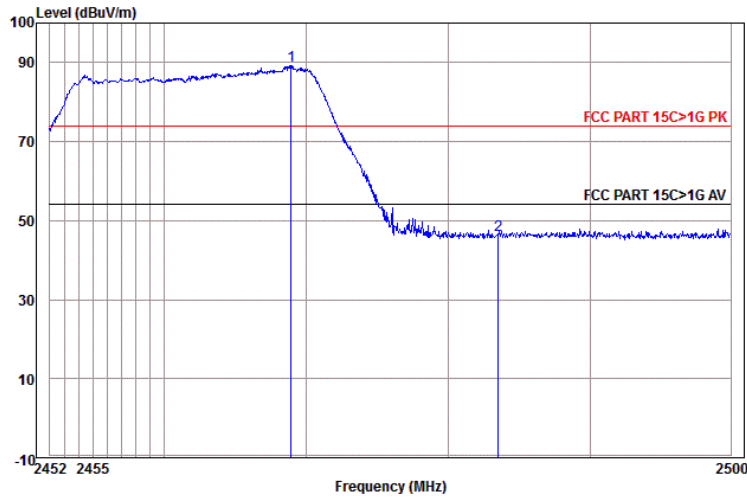

	Ant Freq	Ant Factor	Cable Loss	Preamp Factor	Read Level	Level	Limit Line	Over Limit	Pol/Phase	Remark
	MHz	dB/m	dB	dB	dBuV	dBuV/m	dBuV/m	dB		
1 pp	2468.886	32.69	4.47	34.40	86.52	89.28	74.00	15.28	Horizontal	
2	2483.500	32.71	4.51	34.41	43.61	46.42	74.00	-27.58	Horizontal	

Worse case mode:	802.11n(HT20) (6.5Mbps)		
Frequency: 2483.5MHz	Test channel: Highest	Polarization: Vertical	Remark: Peak

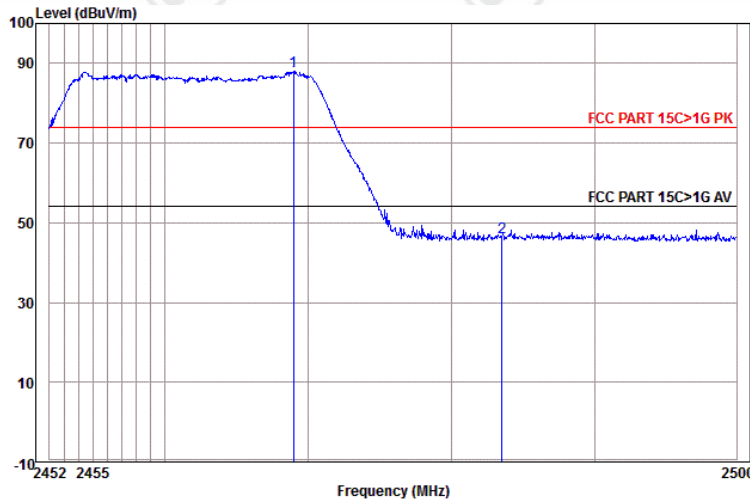

	Ant Freq	Ant Factor	Cable Loss	Preamp Factor	Read Level	Level	Limit Line	Over Limit	Pol/Phase	Remark
	MHz	dB/m	dB	dB	dBuV	dBuV/m	dBuV/m	dB		
1 pp	2468.934	32.69	4.47	34.40	85.29	88.05	74.00	14.05	Vertical	
2	2483.500	32.71	4.51	34.41	43.40	46.21	74.00	-27.79	Vertical	

Worse case mode:	802.11n(HT40) (13..5Mbps)		
Frequency: 2390.0MHz	Test channel: Lowest	Polarization: Horizontal	Remark: Peak

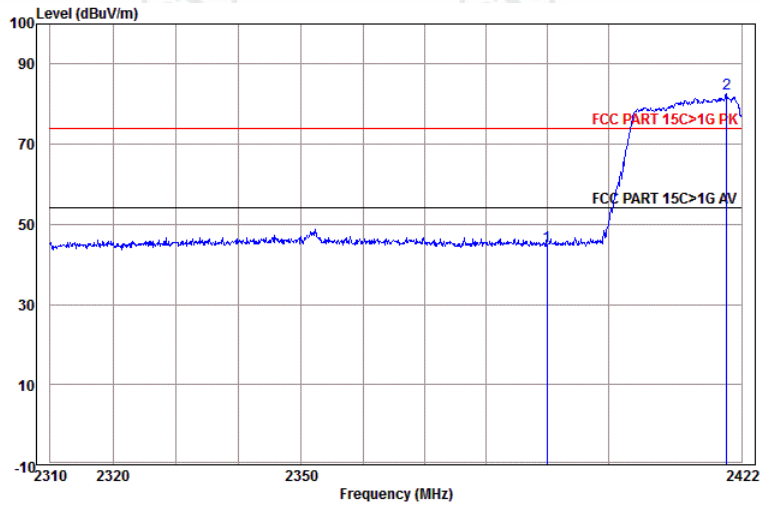

	Ant Freq	Cable Factor	Preamp Loss	Read Level	Level	Limit Line	Over Limit	Pol/Phase	Remark
	MHz	dB/m	dB	dB	dBuV	dBuV/m	dBuV/m	dB	
1	2390.000	32.53	4.28	34.39	42.12	44.54	74.00	-29.46	Horizontal
2 pp	2419.593	32.59	4.35	34.39	80.12	82.67	74.00	8.67	Horizontal

Worse case mode:	802.11n(HT40) (13..5Mbps)		
Frequency: 2390.0MHz	Test channel: Lowest	Polarization: Vertical	Remark: Peak

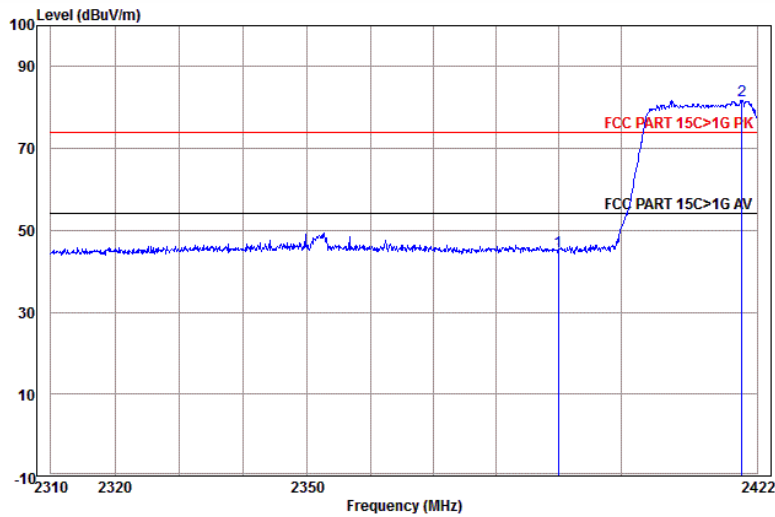

	Ant Freq	Cable Factor	Preamp Loss	Read Level	Level	Limit Line	Over Limit	Pol/Phase	Remark
	MHz	dB/m	dB	dB	dBuV	dBuV/m	dBuV/m	dB	
1	2390.000	32.53	4.28	34.39	42.44	44.86	74.00	-29.14	Vertical
2 pp	2419.593	32.59	4.35	34.39	79.27	81.82	74.00	7.82	Vertical

Worse case mode:	802.11n(HT40) (13..5Mbps)		
Frequency: 2483.5MHz	Test channel: Highest	Polarization: Horizontal	Remark: Peak

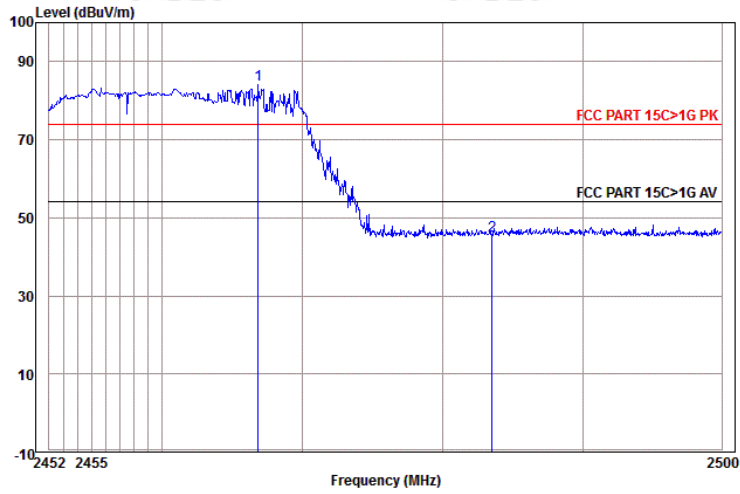

	Ant Freq	Cable Factor	Preamp Loss	Read Level	Limit Line	Over Limit	Pol/Phase	Remark
	MHz	dB/m	dB	dBuV	dBuV/m	dBuV/m	dB	
1 pp	2466.828	32.68	4.47	34.40	81.23	83.98	74.00	9.98 Horizontal
2	2483.500	32.71	4.51	34.41	42.76	45.57	74.00	-28.43 Horizontal

Worse case mode:	802.11n(HT40) (13..5Mbps)		
Frequency: 2483.5MHz	Test channel: Highest	Polarization: Vertical	Remark: Peak

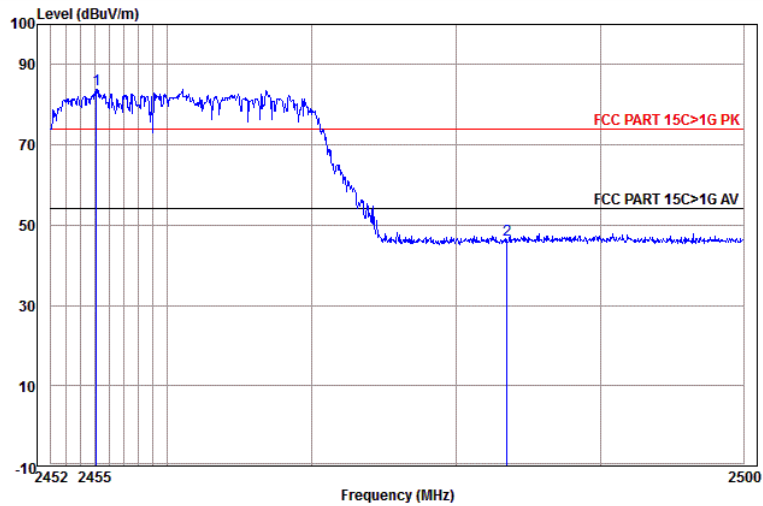

	Ant Freq	Cable Factor	Preamp Loss	Read Level	Limit Line	Over Limit	Pol/Phase	Remark
	MHz	dB/m	dB	dBuV	dBuV/m	dBuV/m	dB	
1 pp	2455.139	32.66	4.44	34.40	81.11	83.81	74.00	9.81 Vertical
2	2483.500	32.71	4.51	34.41	43.68	46.49	74.00	-27.51 Vertical

Remark:

1) Through Pre-scan transmitter mode with all kind of modulation and data rate, find the 11Mbps of rate is the worst case of 802.11b; 6Mbps of rate is the worst case of 802.11g; 6.5Mbps of rate is the worst case of 802.11n(HT20), and then Only the worst case is recorded in the report.

2) The field strength is calculated by adding the Antenna Factor, Cable Factor & Pre-amplifier. The basic equation with a sample calculation is as follows:

Final Test Level = Receiver Reading - Correct Factor

Correct Factor = Pre-amplifier Factor - Antenna Factor - Cable Factor

Appendix I): Radiated Spurious Emissions

Receiver Setup:	Frequency	Detector	RBW	VBW	Remark
	0.009MHz-0.090MHz	Peak	10kHz	30kHz	Peak
	0.009MHz-0.090MHz	Average	10kHz	30kHz	Average
	0.090MHz-0.110MHz	Quasi-peak	10kHz	30kHz	Quasi-peak
	0.110MHz-0.490MHz	Peak	10kHz	30kHz	Peak
	0.110MHz-0.490MHz	Average	10kHz	30kHz	Average
	0.490MHz -30MHz	Quasi-peak	10kHz	30kHz	Quasi-peak
	30MHz-1GHz	Quasi-peak	120kHz	300kHz	Quasi-peak
	Above 1GHz	Peak	1MHz	3MHz	Peak
RMS		1MHz	3MHz	Average	
Test Procedure:					
Below 1GHz test procedure as below:					
<p>a. The EUT was placed on the top of a rotating table 0.8 meters above the ground at a 3 meter semi-anechoic chamber. The table was rotated 360 degrees to determine the position of the highest radiation.</p> <p>b. The EUT was set 3 meters away from the interference-receiving antenna, which was mounted on the top of a variable-height antenna tower.</p> <p>c. The antenna height is varied from one meter to four meters above the ground to determine the maximum value of the field strength. Both horizontal and vertical polarizations of the antenna are set to make the measurement.</p> <p>d. For each suspected emission, the EUT was arranged to its worst case and then the antenna was tuned to heights from 1 meter to 4 meters (for the test frequency of below 30MHz, the antenna was tuned to heights 1 meter) and the rotatable was turned from 0 degrees to 360 degrees to find the maximum reading.</p> <p>e. The test-receiver system was set to Peak Detect Function and Specified Bandwidth with Maximum Hold Mode.</p> <p>f. If the emission level of the EUT in peak mode was 10dB lower than the limit specified, then testing could be stopped and the peak values of the EUT would be reported. Otherwise the emissions that did not have 10dB margin would be re-tested one by one using peak, quasi-peak or average method as specified and then reported in a data sheet.</p>					
Above 1GHz test procedure as below:					
<p>g. Different between above is the test site, change from Semi- Anechoic Chamber to fully Anechoic Chamber and change form table 0.8 meter to 1.5 meter(Above 18GHz the distance is 1 meter and table is 1.5 meter)..</p> <p>h. Test the EUT in the lowest channel ,the middle channel ,the Highest channel</p> <p>i. The radiation measurements are performed in X, Y, Z axis positioning for Transmitting mode, and found the X axis positioning which it is worse case.</p> <p>j. Repeat above procedures until all frequencies measured was complete.</p>					
Limit:	Frequency	Field strength (microvolt/meter)	Limit (dBµV/m)	Remark	Measurement distance (m)
	0.009MHz-0.490MHz	2400/F(kHz)	-	-	300
	0.490MHz-1.705MHz	24000/F(kHz)	-	-	30
	1.705MHz-30MHz	30	-	-	30
	30MHz-88MHz	100	40.0	Quasi-peak	3
	88MHz-216MHz	150	43.5	Quasi-peak	3
	216MHz-960MHz	200	46.0	Quasi-peak	3
	960MHz-1GHz	500	54.0	Quasi-peak	3
	Above 1GHz	500	54.0	Average	3
<p>Note: 15.35(b), Unless otherwise specified, the limit on peak radio frequency emissions is 20dB above the maximum permitted average emission limit applicable to the equipment under test. This peak limit applies to the total peak emission level radiated by the device.</p>					

Radiated Spurious Emissions test Data:
Radiated Emission below 1GHz

30MHz~1GHz (QP)		
Test mode:	Transmitting	Horizontal

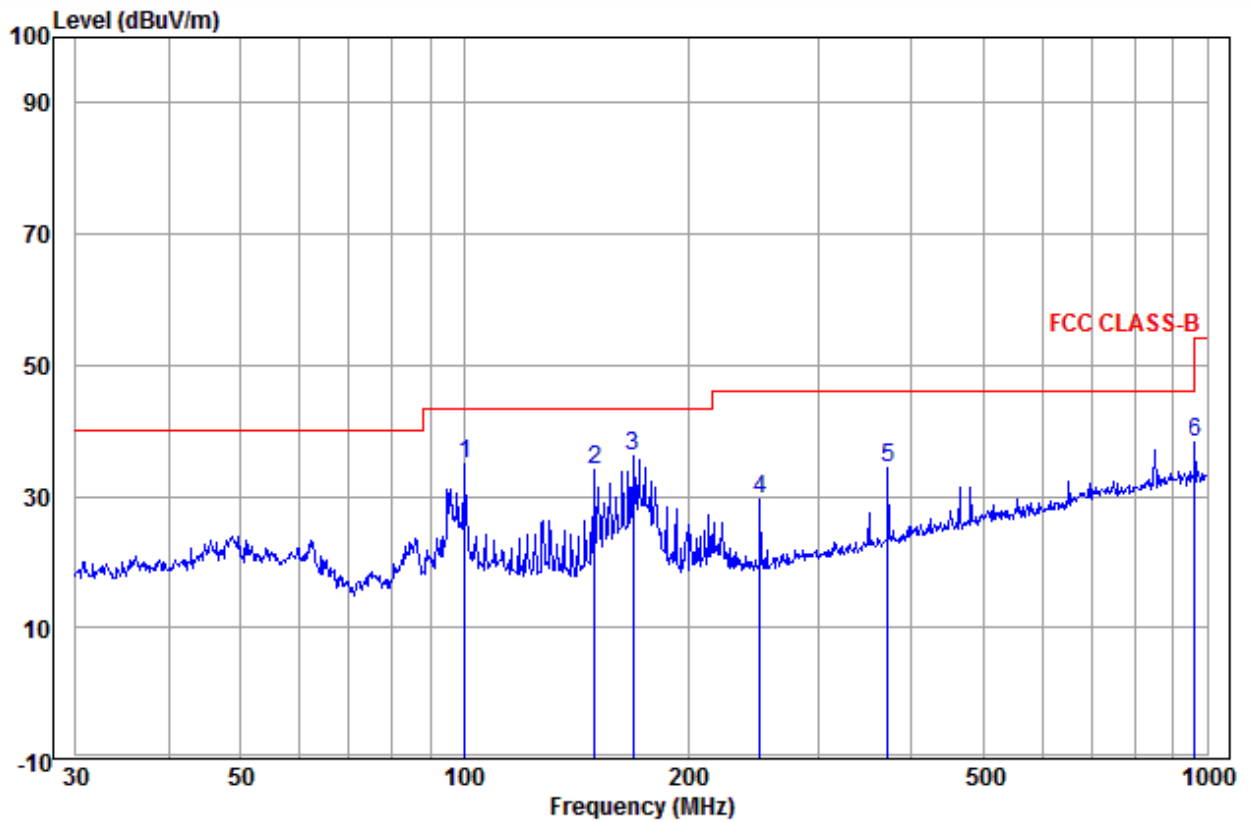

	Ant Freq	Ant Factor	Cable Loss	Read Level	Level	Limit Line	Over Limit	Pol/Phase	Remark
	MHz	dB/m	dB	dBuV	dBuV/m	dBuV/m	dB		
1	100.229	13.18	1.57	20.30	35.05	43.50	-8.45	Horizontal	
2	150.011	9.70	1.58	22.64	33.92	43.50	-9.58	Horizontal	
3 pp	169.005	10.49	1.84	23.88	36.21	43.50	-7.29	Horizontal	
4	250.301	12.41	2.35	14.66	29.42	46.00	-16.58	Horizontal	
5	372.005	15.48	2.75	16.12	34.35	46.00	-11.65	Horizontal	
6	962.162	22.40	4.40	11.58	38.38	54.00	-15.62	Horizontal	

Test mode:	Transmitting	Vertical
------------	--------------	----------

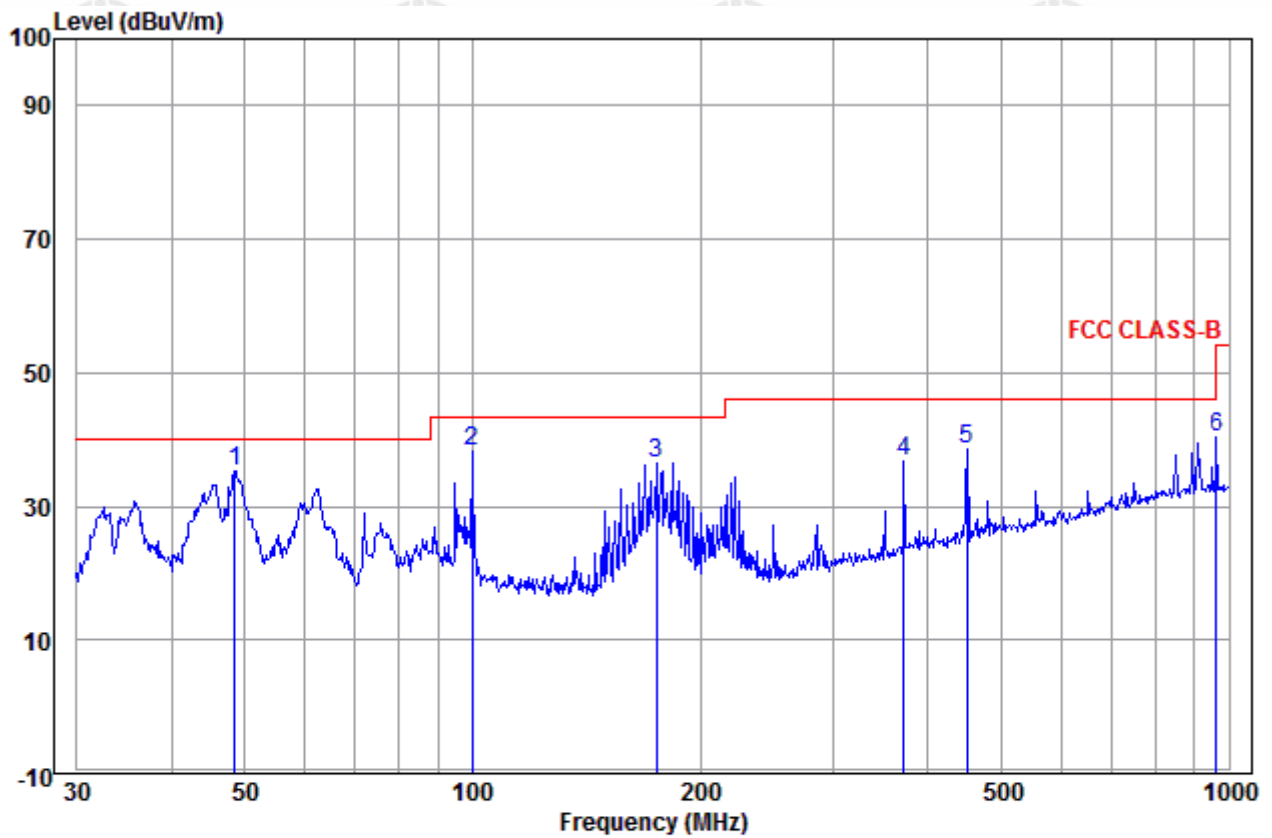

	Ant Freq	Ant Factor	Cable Loss	Read Level	Limit Level	Over Limit	Pol/Phase	Remark
	MHz	dB/m	dB	dBuV	dBuV/m	dBuV/m	dB	
1 pp	48.502	14.98	1.28	18.99	35.25	40.00	-4.75	Vertical
2	99.878	13.18	1.57	23.64	38.39	43.50	-5.11	Vertical
3	175.037	10.72	1.92	23.77	36.41	43.50	-7.09	Vertical
4	372.005	15.48	2.75	18.51	36.74	46.00	-9.26	Vertical
5	451.135	17.13	2.99	18.37	38.49	46.00	-7.51	Vertical
6	962.162	22.40	4.40	13.53	40.33	54.00	-13.67	Vertical

Transmitter Emission above 1GHz

Test mode: 802.11b(11Mbps)			Test Frequency: 2412MHz			Remark: Peak			
Frequency (MHz)	Antenna Factor (dB/m)	Cable Loss (dB)	Preamp Gain (dB)	Read Level (dBμV)	Level (dBμV/m)	Limit (dBμV/m)	Over Limit (dB)	Result	Antenna Polaxis
1173.943	30.16	2.48	34.99	47.01	44.66	74.00	-29.34	Pass	Horizontal
1506.563	30.88	2.83	34.67	47.63	46.67	74.00	-27.33	Pass	Horizontal
1943.292	31.62	3.19	34.34	45.89	46.36	74.00	-27.64	Pass	Horizontal
4824.000	34.73	5.10	34.35	45.38	50.86	74.00	-23.14	Pass	Horizontal
7236.000	36.42	6.69	34.90	40.08	48.29	74.00	-25.71	Pass	Horizontal
9648.000	37.93	7.70	35.07	38.94	49.50	74.00	-24.50	Pass	Horizontal
1176.935	30.17	2.49	34.99	46.86	44.53	74.00	-29.47	Pass	Vertical
1498.912	30.87	2.83	34.67	46.65	45.68	74.00	-28.32	Pass	Vertical
1823.477	31.43	3.10	34.42	46.84	46.95	74.00	-27.05	Pass	Vertical
4824.000	34.73	5.10	34.35	42.79	48.27	74.00	-25.73	Pass	Vertical
7236.000	36.42	6.69	34.90	39.08	47.29	74.00	-26.71	Pass	Vertical
9648.000	37.93	7.70	35.07	38.85	49.41	74.00	-24.59	Pass	Vertical

Test mode: 802.11b(11Mbps)			Test Frequency: 2437MHz			Remark: Peak			
Frequency (MHz)	Antenna Factor (dB/m)	Cable Loss (dB)	Preamp Gain (dB)	Read Level (dBμV)	Level (dBμV/m)	Limit (dBμV/m)	Over Limit (dB)	Result	Antenna Polaxis
1170.959	30.16	2.48	35.00	47.40	45.04	74.00	-28.96	Pass	Horizontal
1498.912	30.87	2.83	34.67	47.11	46.14	74.00	-27.86	Pass	Horizontal
1828.125	31.44	3.10	34.42	46.23	46.35	74.00	-27.65	Pass	Horizontal
4874.000	34.84	5.09	34.33	44.45	50.05	74.00	-23.95	Pass	Horizontal
7311.000	36.43	6.76	34.90	38.39	46.68	74.00	-27.32	Pass	Horizontal
9748.000	38.03	7.61	35.05	38.70	49.29	74.00	-24.71	Pass	Horizontal
1173.943	30.16	2.48	34.99	47.13	44.78	74.00	-29.22	Pass	Vertical
1487.509	30.85	2.82	34.68	47.69	46.68	74.00	-27.32	Pass	Vertical
1818.842	31.43	3.10	34.42	46.79	46.90	74.00	-27.10	Pass	Vertical
4874.000	34.84	5.09	34.33	40.74	46.34	74.00	-27.66	Pass	Vertical
7311.000	36.43	6.76	34.90	37.85	46.14	74.00	-27.86	Pass	Vertical
9748.000	38.03	7.61	35.05	38.58	49.17	74.00	-24.83	Pass	Vertical

Test mode: 802.11b(11Mbps)			Test Frequency: 2462MHz			Remark: Peak			
Frequency (MHz)	Antenna Factor (dB/m)	Cable Loss (dB)	Preamp Gain (dB)	Read Level (dBμV)	Level (dBμV/m)	Limit (dBμV/m)	Over Limit (dB)	Result	Antenna Polaxis
1173.943	30.16	2.48	34.99	47.35	45.00	74.00	-29.00	Pass	Horizontal
1518.111	30.90	2.84	34.66	46.64	45.72	74.00	-28.28	Pass	Horizontal
1832.785	31.45	3.11	34.41	46.95	47.10	74.00	-26.90	Pass	Horizontal
4924.000	34.94	5.07	34.32	40.17	45.86	74.00	-28.14	Pass	Horizontal
7386.000	36.44	6.83	34.90	39.49	47.86	74.00	-26.14	Pass	Horizontal
9848.000	38.14	7.53	35.03	38.74	49.38	74.00	-24.62	Pass	Horizontal
1182.943	30.18	2.50	34.98	46.96	44.66	74.00	-29.34	Pass	Vertical
1668.044	31.18	2.98	34.54	46.96	46.58	74.00	-27.42	Pass	Vertical
2124.374	31.98	3.59	34.33	46.15	47.39	74.00	-26.61	Pass	Vertical
4924.000	34.94	5.07	34.32	41.42	47.11	74.00	-26.89	Pass	Vertical
7386.000	36.44	6.83	34.90	40.08	48.45	74.00	-25.55	Pass	Vertical
9848.000	38.14	7.53	35.03	39.31	49.95	74.00	-24.05	Pass	Vertical

Test mode: 802.11g(6Mbps)			Test Frequency: 2412MHz			Remark: Peak			
Frequency (MHz)	Antenna Factor (dB/m)	Cable Loss (dB)	Preamp Gain (dB)	Read Level (dBμV)	Level (dBμV/m)	Limit (dBμV/m)	Over Limit (dB)	Result	Antenna Polaxis
1173.943	30.16	2.48	34.99	47.20	44.85	74.00	-29.15	Pass	Horizontal
1506.563	30.88	2.83	34.67	46.49	45.53	74.00	-28.47	Pass	Horizontal
1823.477	31.43	3.10	34.42	46.47	46.58	74.00	-27.42	Pass	Horizontal
4824.000	34.73	5.10	34.35	41.53	47.01	74.00	-26.99	Pass	Horizontal
7236.000	36.42	6.69	34.90	39.28	47.49	74.00	-26.51	Pass	Horizontal
9648.000	37.93	7.70	35.07	39.56	50.12	74.00	-23.88	Pass	Horizontal
1176.935	30.17	2.49	34.99	46.60	44.27	74.00	-29.73	Pass	Vertical
1514.252	30.90	2.84	34.66	46.55	45.63	74.00	-28.37	Pass	Vertical
1828.125	31.44	3.10	34.42	46.37	46.49	74.00	-27.51	Pass	Vertical
4824.000	34.73	5.10	34.35	40.30	45.78	74.00	-28.22	Pass	Vertical
7236.000	36.42	6.69	34.90	39.70	47.91	74.00	-26.09	Pass	Vertical
9648.000	37.93	7.70	35.07	38.84	49.40	74.00	-24.60	Pass	Vertical

Test mode: 802.11g(6Mbps)			Test Frequency: 2437MHz			Remark: Peak			
Frequency (MHz)	Antenna Factor (dB/m)	Cable Loss (dB)	Preamp Gain (dB)	Read Level (dBμV)	Level (dBμV/m)	Limit (dBμV/m)	Over Limit (dB)	Result	Antenna Polaxis
1185.958	30.19	2.50	34.98	46.35	44.06	74.00	-29.94	Pass	Horizontal
1518.111	30.90	2.84	34.66	47.06	46.14	74.00	-27.86	Pass	Horizontal
1968.184	31.65	3.21	34.32	46.07	46.61	74.00	-27.39	Pass	Horizontal
4874.000	34.84	5.09	34.33	42.80	48.40	74.00	-25.60	Pass	Horizontal
7311.000	36.43	6.76	34.90	39.36	47.65	74.00	-26.35	Pass	Horizontal
9748.000	38.03	7.61	35.05	40.08	50.67	74.00	-23.33	Pass	Horizontal
1185.958	30.19	2.50	34.98	47.35	45.06	74.00	-28.94	Pass	Vertical
1525.860	30.92	2.85	34.65	46.66	45.78	74.00	-28.22	Pass	Vertical
1832.785	31.45	3.11	34.41	46.73	46.88	74.00	-27.12	Pass	Vertical
4874.000	34.84	5.09	34.33	41.72	47.32	74.00	-26.68	Pass	Vertical
7311.000	36.43	6.76	34.90	38.04	46.33	74.00	-27.67	Pass	Vertical
9748.000	38.03	7.61	35.05	39.20	49.79	74.00	-24.21	Pass	Vertical

Test mode: 802.11g(6Mbps)			Test Frequency: 2462MHz			Remark: Peak			
Frequency (MHz)	Antenna Factor (dB/m)	Cable Loss (dB)	Preamp Gain (dB)	Read Level (dBμV)	Level (dBμV/m)	Limit (dBμV/m)	Over Limit (dB)	Result	Antenna Polaxis
1162.051	30.13	2.47	35.00	46.72	44.32	74.00	-29.68	Pass	Horizontal
1487.509	30.85	2.82	34.68	46.98	45.97	74.00	-28.03	Pass	Horizontal
1832.785	31.45	3.11	34.41	45.84	45.99	74.00	-28.01	Pass	Horizontal
4924.000	34.94	5.07	34.32	40.37	46.06	74.00	-27.94	Pass	Horizontal
7386.000	36.44	6.83	34.90	40.43	48.80	74.00	-25.20	Pass	Horizontal
9848.000	38.14	7.53	35.03	40.17	50.81	74.00	-23.19	Pass	Horizontal
1185.958	30.19	2.50	34.98	47.30	45.01	74.00	-28.99	Pass	Vertical
1502.732	30.88	2.83	34.67	46.71	45.75	74.00	-28.25	Pass	Vertical
1814.218	31.42	3.09	34.43	46.34	46.42	74.00	-27.58	Pass	Vertical
4924.000	34.94	5.07	34.32	39.86	45.55	74.00	-28.45	Pass	Vertical
7386.000	36.44	6.83	34.90	40.38	48.75	74.00	-25.25	Pass	Vertical
9848.000	38.14	7.53	35.03	40.10	50.74	74.00	-23.26	Pass	Vertical

Test mode: 802.11n(HT20)(6.5Mbps)			Test Frequency: 2412MHz			Remark: Peak			
Frequency (MHz)	Antenna Factor (dB/m)	Cable Loss (dB)	Preamp Gain (dB)	Read Level (dBμV)	Level (dBμV/m)	Limit (dBμV/m)	Over Limit (dB)	Result	Antenna Polaxis
1188.980	30.20	2.50	34.98	47.06	44.78	74.00	-29.22	Pass	Horizontal
1510.402	30.89	2.84	34.66	46.27	45.34	74.00	-28.66	Pass	Horizontal
1988.327	31.68	3.22	34.31	46.07	46.66	74.00	-27.34	Pass	Horizontal
4824.000	34.73	5.10	34.35	40.79	46.27	74.00	-27.73	Pass	Horizontal
7236.000	36.42	6.69	34.90	38.90	47.11	74.00	-26.89	Pass	Horizontal
9648.000	37.93	7.70	35.07	38.78	49.34	74.00	-24.66	Pass	Horizontal
1162.051	30.13	2.47	35.00	47.20	44.80	74.00	-29.20	Pass	Vertical
1823.477	31.43	3.10	34.42	45.92	46.03	74.00	-27.97	Pass	Vertical
4321.837	33.60	5.30	34.50	42.85	47.25	74.00	-26.75	Pass	Vertical
4824.000	34.73	5.10	34.35	40.57	46.05	74.00	-27.95	Pass	Vertical
7236.000	36.42	6.69	34.90	40.34	48.55	74.00	-25.45	Pass	Vertical
9648.000	37.93	7.70	35.07	39.63	50.19	74.00	-23.81	Pass	Vertical

Test mode: 802.11n(HT20)(6.5Mbps)			Test Frequency: 2437MHz			Remark: Peak			
Frequency (MHz)	Antenna Factor (dB/m)	Cable Loss (dB)	Preamp Gain (dB)	Read Level (dBμV)	Level (dBμV/m)	Limit (dBμV/m)	Over Limit (dB)	Result	Antenna Polaxis
1176.935	30.17	2.49	34.99	47.31	44.98	74.00	-29.02	Pass	Horizontal
1498.912	30.87	2.83	34.67	46.30	45.33	74.00	-28.67	Pass	Horizontal
1832.785	31.45	3.11	34.41	46.82	46.97	74.00	-27.03	Pass	Horizontal
4874.000	34.84	5.09	34.33	41.62	47.22	74.00	-26.78	Pass	Horizontal
7311.000	36.43	6.76	34.90	39.34	47.63	74.00	-26.37	Pass	Horizontal
9748.000	38.03	7.61	35.05	40.30	50.89	74.00	-23.11	Pass	Horizontal
1170.959	30.16	2.48	35.00	46.63	44.27	74.00	-29.73	Pass	Vertical
1498.912	30.87	2.83	34.67	47.58	46.61	74.00	-27.39	Pass	Vertical
1988.327	31.68	3.22	34.31	46.35	46.94	74.00	-27.06	Pass	Vertical
4874.000	34.84	5.09	34.33	41.40	47.00	74.00	-27.00	Pass	Vertical
7311.000	36.43	6.76	34.90	38.73	47.02	74.00	-26.98	Pass	Vertical
9748.000	38.03	7.61	35.05	39.76	50.35	74.00	-23.65	Pass	Vertical

Test mode: 802.11n(HT20)(6.5Mbps)			Test Frequency: 2462MHz			Remark: Peak			
Frequency (MHz)	Antenna Factor (dB/m)	Cable Loss (dB)	Preamp Gain (dB)	Read Level (dBμV)	Level (dBμV/m)	Limit (dBμV/m)	Over Limit (dB)	Result	Antenna Polaxis
1185.958	30.19	2.50	34.98	46.63	44.34	74.00	-29.66	Pass	Horizontal
1498.912	30.87	2.83	34.67	46.78	45.81	74.00	-28.19	Pass	Horizontal
1814.218	31.42	3.09	34.43	46.57	46.65	74.00	-27.35	Pass	Horizontal
4924.000	34.94	5.07	34.32	40.31	46.00	74.00	-28.00	Pass	Horizontal
7386.000	36.44	6.83	34.90	39.43	47.80	74.00	-26.20	Pass	Horizontal
9848.000	38.14	7.53	35.03	39.78	50.42	74.00	-23.58	Pass	Horizontal
1182.943	30.18	2.50	34.98	46.97	44.67	74.00	-29.33	Pass	Vertical
1506.563	30.88	2.83	34.67	46.19	45.23	74.00	-28.77	Pass	Vertical
1968.184	31.65	3.21	34.32	46.03	46.57	74.00	-27.43	Pass	Vertical
4924.000	34.94	5.07	34.32	39.54	45.23	74.00	-28.77	Pass	Vertical
7386.000	36.44	6.83	34.90	40.28	48.65	74.00	-25.35	Pass	Vertical
9848.000	38.14	7.53	35.03	39.98	50.62	74.00	-23.38	Pass	Vertical

Test mode: 802.11n(HT40)(13.5Mbps)			Test Frequency: 2422MHz			Remark: Peak			
Frequency (MHz)	Antenna Factor (dB/m)	Cable Loss (dB)	Preamp Gain (dB)	Read Level (dBμV)	Final test level (dBμV/m)	Limit (dBμV/m)	Over Limit (dB)	Result	Antenna Polaxis
1176.935	30.17	2.49	34.99	46.82	44.49	74.00	-29.51	Pass	Horizontal
1506.563	30.88	2.83	34.67	47.32	46.36	74.00	-27.64	Pass	Horizontal
1814.218	31.42	3.09	34.43	46.16	46.24	74.00	-27.76	Pass	Horizontal
4844.000	34.77	5.10	34.34	41.56	47.09	74.00	-26.91	Pass	Horizontal
7266.000	36.43	6.72	34.90	41.08	49.33	74.00	-24.67	Pass	Horizontal
9688.000	37.97	7.66	35.06	38.63	49.20	74.00	-24.80	Pass	Horizontal
1173.943	30.16	2.48	34.99	46.66	44.31	74.00	-29.69	Pass	Vertical
1498.912	30.87	2.83	34.67	46.19	45.22	74.00	-28.78	Pass	Vertical
1818.842	31.43	3.10	34.42	46.77	46.88	74.00	-27.12	Pass	Vertical
4844.000	34.77	5.10	34.34	41.76	47.29	74.00	-26.71	Pass	Vertical
7266.000	36.43	6.72	34.90	41.10	49.35	74.00	-24.65	Pass	Vertical
9688.000	37.97	7.66	35.06	39.89	50.46	74.00	-23.54	Pass	Vertical

Test mode: 802.11n(HT40)(13.5Mbps)			Test Frequency: 2437MHz			Remark: Peak			
Frequency (MHz)	Antenna Factor (dB/m)	Cable Loss (dB)	Preamp Gain (dB)	Read Level (dBμV)	Final test level (dBμV/m)	Limit (dBμV/m)	Over Limit (dB)	Result	Antenna Polaxis
1185.958	30.19	2.50	34.98	47.44	45.15	74.00	-28.85	Pass	Horizontal
1655.354	31.15	2.97	34.55	46.19	45.76	74.00	-28.24	Pass	Horizontal
1818.842	31.43	3.10	34.42	46.69	46.80	74.00	-27.20	Pass	Horizontal
4874.000	34.84	5.09	34.33	40.84	46.44	74.00	-27.56	Pass	Horizontal
7311.000	36.43	6.76	34.90	39.53	47.82	74.00	-26.18	Pass	Horizontal
9748.000	38.03	7.61	35.05	39.65	50.24	74.00	-23.76	Pass	Horizontal
1176.935	30.17	2.49	34.99	46.62	44.29	74.00	-29.71	Pass	Vertical
1663.803	31.17	2.97	34.54	45.52	45.12	74.00	-28.88	Pass	Vertical
1973.201	31.66	3.21	34.32	45.89	46.44	74.00	-27.56	Pass	Vertical
4874.000	34.84	5.09	34.33	41.04	46.64	74.00	-27.36	Pass	Vertical
7311.000	36.43	6.76	34.90	38.31	46.60	74.00	-27.40	Pass	Vertical
9748.000	38.03	7.61	35.05	38.67	49.26	74.00	-24.74	Pass	Vertical

Test mode: 802.11n(HT40)(13.5Mbps)			Test Frequency: 2452MHz			Remark: Peak			
Frequency (MHz)	Antenna Factor (dB/m)	Cable Loss (dB)	Preamp Gain (dB)	Read Level (dBμV)	Final test level (dBμV/m)	Limit (dBμV/m)	Over Limit (dB)	Result	Antenna Polaxis
1195.049	30.21	2.51	34.97	46.86	44.61	74.00	-29.39	Pass	Horizontal
1491.300	30.85	2.82	34.68	46.08	45.07	74.00	-28.93	Pass	Horizontal
1968.184	31.65	3.21	34.32	45.15	45.69	74.00	-28.31	Pass	Horizontal
4904.000	34.90	5.07	34.33	39.20	44.84	74.00	-29.16	Pass	Horizontal
7356.000	36.44	6.80	34.90	40.84	49.18	74.00	-24.82	Pass	Horizontal
9808.000	38.10	7.56	35.04	40.21	50.83	74.00	-23.17	Pass	Horizontal
1353.804	30.57	2.68	34.81	46.84	45.28	74.00	-28.72	Pass	Vertical
1828.125	31.44	3.10	34.42	46.35	46.47	74.00	-27.53	Pass	Vertical
4310.849	33.57	5.31	34.50	42.73	47.11	74.00	-26.89	Pass	Vertical
4904.000	34.90	5.07	34.33	40.24	45.88	74.00	-28.12	Pass	Vertical
7356.000	36.44	6.80	34.90	39.89	48.23	74.00	-25.77	Pass	Vertical
9808.000	38.10	7.56	35.04	40.18	50.80	74.00	-23.20	Pass	Vertical

Remark:

- 1) Through Pre-scan transmitting mode with all kind of modulation and data rate, Only the worst case is recorded in the report.
- 2) The field strength is calculated by adding the Antenna Factor, Cable Factor & Preamplifier. The basic equation with a sample calculation is as follows:
 Final Test Level =Receiver Reading - Correct Factor
 Correct Factor = Preamplifier Factor– Antenna Factor–Cable Factor
- 3) Scan from 9kHz to 25GHz, the disturbance above 13GHz and below 30MHz was very low, and the above harmonics were the highest point could be found when testing, so only the above harmonics had been displayed. The amplitude of spurious emissions from the radiator which are attenuated more than 20dB below the limit need not be reported.

PHOTOGRAPHS OF TEST SETUP

Test Model No.: X80



Radiated spurious emission Test Setup-1(Below 1GHz)



Radiated spurious emission Test Setup-2(Above 1GHz)

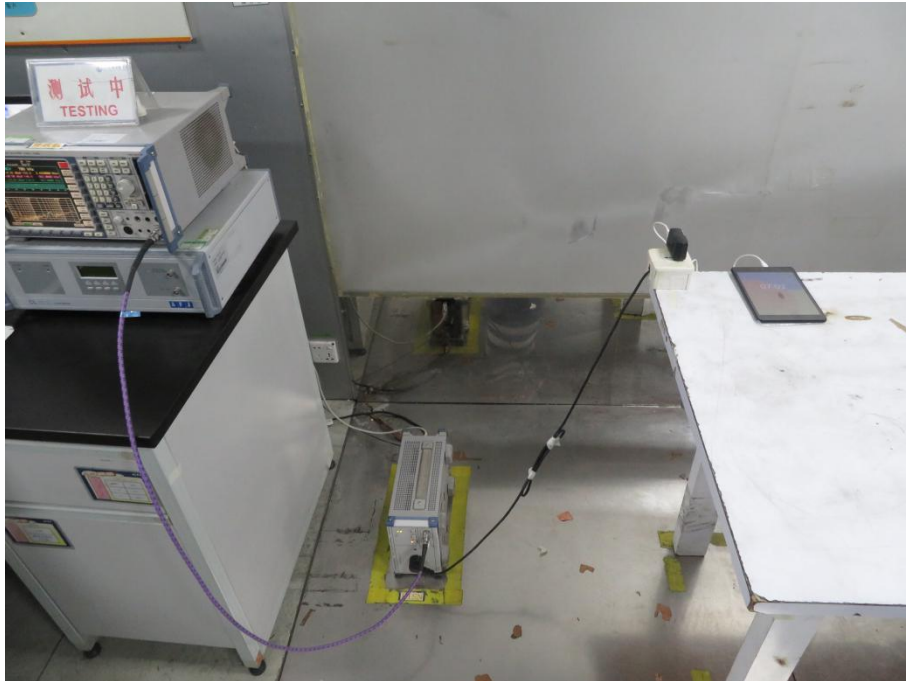

Conducted Emissions Test Setup

PHOTOGRAPHS OF EUT Constructional Details

Refer to Report No.EED32100298701 for EUT external and internal photos.

*** End of Report ***

The test report is effective only with both signature and specialized stamp, The result(s) shown in this report refer only to the sample(s) tested. Without written approval of CTI, this report can't be reproduced except in full.