

TEST REPORT

Product : 8" Tablet PC
Trade mark : Dragon Touch, KINGPAD,
KINGSLIM, AKASO
Model/Type reference : i8 Pro, i8, i8X, i8D, i8X Pro, i88,
i80, i80X, i8 Plus, i8X Plus,
i8 hybrid
Serial Number : N/A
Report Number : EED32H00215002
FCC ID : S5V-D080W1
Date of Issue : Dec. 22, 2015
Test Standards : 47 CFR Part 15 Subpart C (2014)
Test result : PASS

Prepared for:

Proexpress Distributor LLC
11011 GREENWOOD AVE. N APT5, SEATTLE, WA 98103.

Prepared by:

Centre Testing International Group Co., Ltd.
Hongwei Industrial Zone, Bao'an 70 District,
Shenzhen, Guangdong, China
TEL: +86-755-3368 3668
FAX: +86-755-3368 3385

Compiled by:

Kevin Tang

Reviewed by:

Ermen-li

Approved by:

Sheek Luo

Date:

Dec. 22, 2015



Sheek Luo
Lab supervisor

Check No.: 2212834822

2 Version

Version No.	Date	Description
00	Dec. 22, 2015	Original

3 Test Summary

Test Item	Test Requirement	Test method	Result
Antenna Requirement	47 CFR Part 15, Subpart C Section 15.203/15.247 (c)	ANSI C63.10-2013	PASS
AC Power Line Conducted Emission	47 CFR Part 15, Subpart C Section 15.207	ANSI C63.10-2013	PASS
Conducted Peak Output Power	47 CFR Part 15, Subpart C Section 15.247 (b)(3)	ANSI C63.10-2013	PASS
6dB Occupied Bandwidth	47 CFR Part 15, Subpart C Section 15.247 (a)(2)	ANSI C63.10-2013	PASS
Power Spectral Density	47 CFR Part 15, Subpart C Section 15.247 (e)	ANSI C63.10-2013	PASS
Band-edge for RF Conducted Emissions	47 CFR Part 15, Subpart C Section 15.247(d)	ANSI C63.10-2013	PASS
RF Conducted Spurious Emissions	47 CFR Part 15, Subpart C Section 15.247(d)	ANSI C63.10-2013	PASS
Radiated Spurious Emissions	47 CFR Part 15, Subpart C Section 15.205/15.209	ANSI C63.10-2013	PASS
Restricted bands around fundamental frequency (Radiated Emission)	47 CFR Part 15, Subpart C Section 15.205/15.209	ANSI C63.10-2013	PASS

Remark:

Test according to ANSI C63.4-2014 & ANSI C63.10-2013.

The tested sample(s) and the sample information are provided by the client.

Model No.: i8 Pro, i8, i8X, i8D, i8X Pro, i88, i80, i80X, i8 Plus, i8X Plus, i8 hybrid

Only the Model i8 Pro was tested, since the electrical circuit design, layout, components used and internal wiring were identical for all above models. Only different on agent and marketing purposes.

4 Content

1 COVER PAGE	1
2 VERSION	2
3 TEST SUMMARY	3
4 CONTENT	4
5 TEST REQUIREMENT	5
5.1 TEST SETUP.....	5
5.1.1 For Conducted test setup.....	5
5.1.2 For Radiated Emissions test setup.....	5
5.1.3 For Conducted Emissions test setup.....	6
5.2 TEST ENVIRONMENT.....	6
5.3 TEST CONDITION.....	6
6 GENERAL INFORMATION	7
6.1 CLIENT INFORMATION.....	7
6.2 GENERAL DESCRIPTION OF EUT.....	7
6.3 PRODUCT SPECIFICATION SUBJECTIVE TO THIS STANDARD.....	7
6.4 DESCRIPTION OF SUPPORT UNITS.....	8
6.5 TEST LOCATION.....	8
6.6 TEST FACILITY.....	8
6.7 DEVIATION FROM STANDARDS.....	9
6.8 ABNORMALITIES FROM STANDARD CONDITIONS.....	9
6.9 OTHER INFORMATION REQUESTED BY THE CUSTOMER.....	9
6.10 MEASUREMENT UNCERTAINTY(95% CONFIDENCE LEVELS, K=2).....	9
7 EQUIPMENT LIST	10
8 RADIO TECHNICAL REQUIREMENTS SPECIFICATION	12
Appendix A) 6dB Occupied Bandwidth.....	13
Appendix B) Conducted Peak Output Power.....	15
Appendix C) Band-edge for RF Conducted Emissions.....	17
Appendix D) RF Conducted Spurious Emissions.....	18
Appendix E) Power Spectral Density.....	21
Appendix F) Antenna Requirement.....	23
Appendix G) AC Power Line Conducted Emission.....	24
Appendix H) Restricted bands around fundamental frequency (Radiated).....	27
Appendix I) Radiated Spurious Emissions.....	29
PHOTOGRAPHS OF TEST SETUP	34
PHOTOGRAPHS OF EUT CONSTRUCTIONAL DETAILS	36

5 Test Requirement

5.1 Test setup

5.1.1 For Conducted test setup

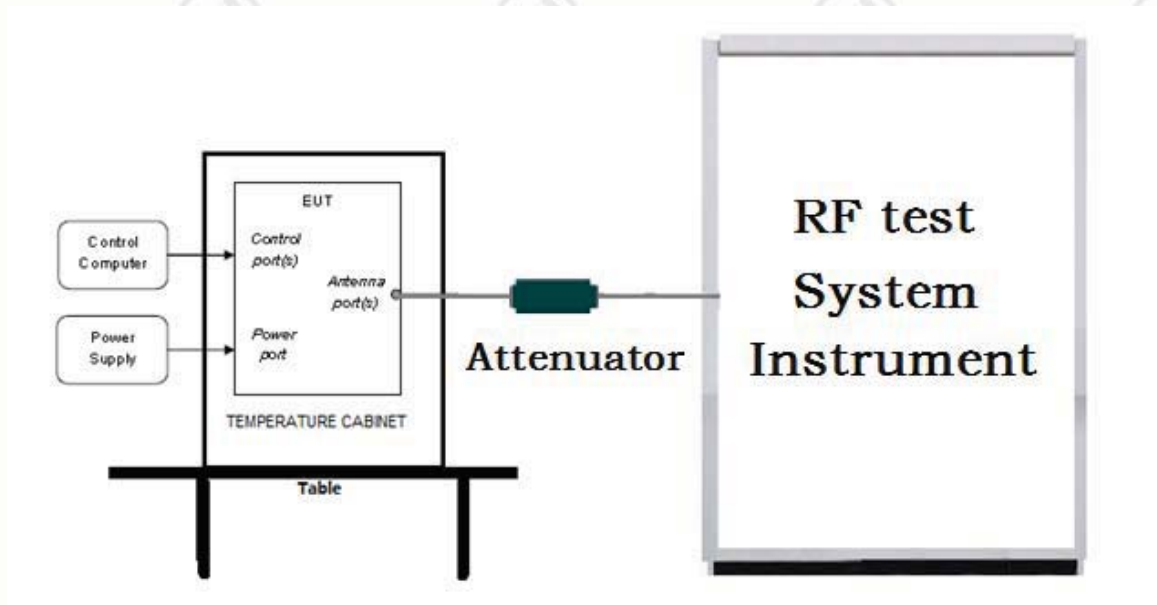

5.1.2 For Radiated Emissions test setup

Radiated Emissions setup:

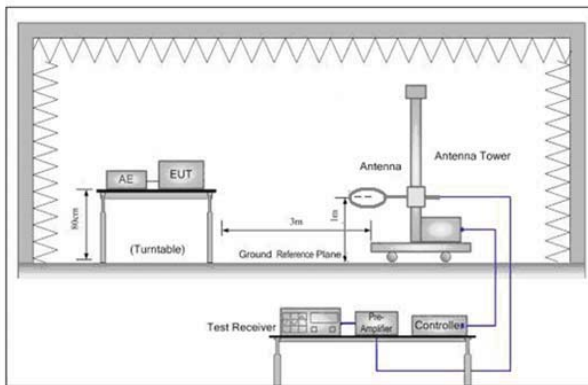

Figure 1. Below 30MHz

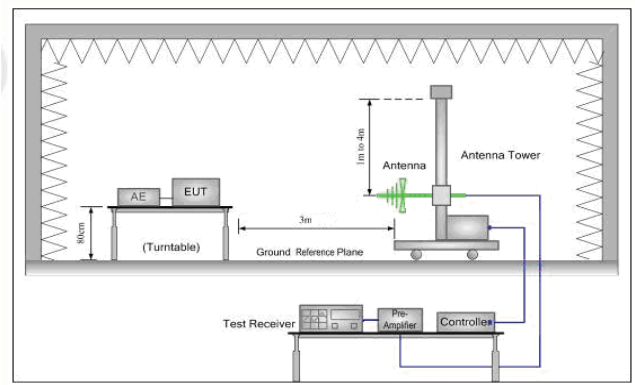

Figure 2. 30MHz to 1GHz

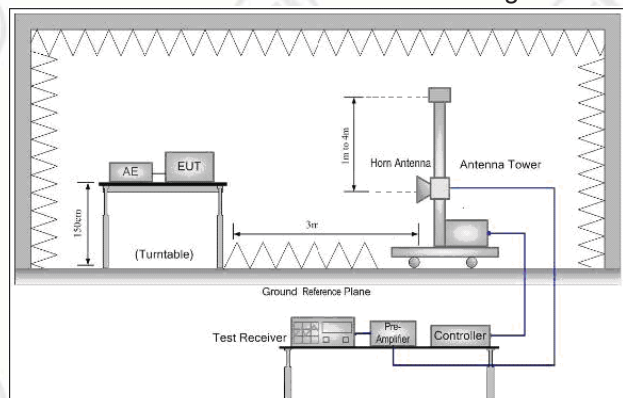
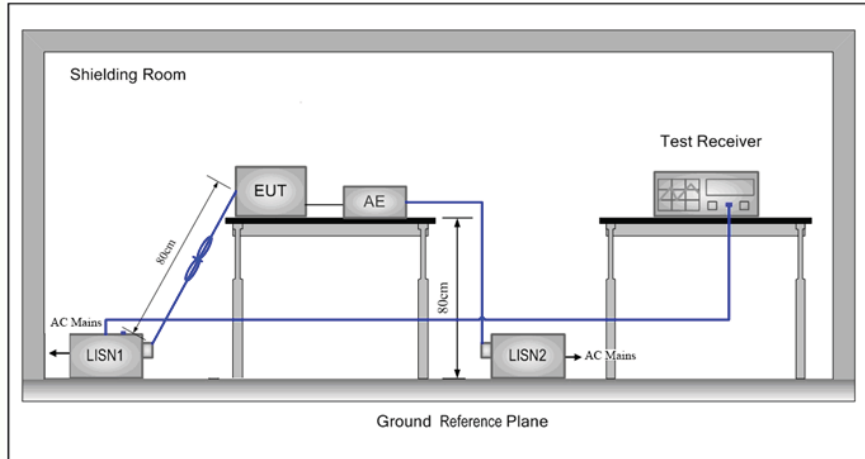

Figure 3. Above 1GHz

5.1.3 For Conducted Emissions test setup Conducted Emissions setup



5.2 Test Environment

Operating Environment:	
Temperature:	24 °C
Humidity:	50 % RH
Atmospheric Pressure:	1010mbar

5.3 Test Condition

Test channel:

Test Mode	Tx/Rx	RF Channel		
		Low(L)	Middle(M)	High(H)
GFSK	2402MHz ~2480 MHz	Channel 1	Channel 20	Channel40
		2402MHz	2440MHz	2480MHz
Transmitting mode:	The EUT transmitted the continuous modulation test signal at the specific channel(s)			

6 General Information

6.1 Client Information

Applicant:	Proexpress Distributor LLC
Address of Applicant:	11011 GREENWOOD AVE. N APT5, SEATTLE, WA 98103.
Manufacturer:	Proexpress Distributor LLC
Address of Manufacturer:	11011 GREENWOOD AVE. N APT5, SEATTLE, WA 98103.

6.2 General Description of EUT

Product Name:	8" Tablet PC	
Model No.:	i8 Pro, i8, i8X, i8D, i8X Pro, i88, i80, i80X, i8 Plus, i8X Plus, i8 hybrid	
Test Model No.:	i8 Pro	
Trade mark:	Dragon Touch, KINGPAD, KINGSLIM, AKASO	
EUT Supports Radios application:	Bluetooth V4.0 BLE	
Power Supply:	Adapter:	AC 100-240V, 50/60Hz Output: DC 5.0V, 2000mA
	Battery:	DC 3.7V, 4000mA
AC Adapter line:	120cm(Unshielded)	
Sample Received Date:	Nov. 11, 2015	
Sample tested Date:	Nov. 11, 2015 to Dec. 07, 2015	

6.3 Product Specification subjective to this standard

Operation Frequency:	2402MHz~2480MHz
Bluetooth Version:	4.0
Modulation Type:	GFSK
Number of Channel:	40
Sample Type:	Portable production
Test Power Grade:	N/A
Test Software of EUT:	RTLBTAPP (manufacturer declare)
Antenna Type and Gain::	Type: Internal antenna Gain:2.2dBi
Test Voltage:	AC 120V/60Hz

Operation Frequency each of channel

Channel	Frequency	Channel	Frequency	Channel	Frequency	Channel	Frequency
1	2402MHz	11	2422MHz	21	2442MHz	31	2462MHz
2	2404MHz	12	2424MHz	22	2444MHz	32	2464MHz
3	2406MHz	13	2426MHz	23	2446MHz	33	2466MHz
4	2408MHz	14	2428MHz	24	2448MHz	34	2468MHz
5	2410MHz	15	2430MHz	25	2450MHz	35	2470MHz
6	2412MHz	16	2432MHz	26	2452MHz	36	2472MHz
7	2414MHz	17	2434MHz	27	2454MHz	37	2474MHz
8	2416MHz	18	2436MHz	28	2456MHz	38	2476MHz

9	2418MHz	19	2438MHz	29	2458MHz	39	2478MHz
10	2420MHz	20	2440MHz	30	2460MHz	40	2480MHz

6.4 Description of Support Units

The EUT has been tested with associated equipment below.

Description	Manufacturer	Model No.	Certification	Supplied by
Mobile Phone	SAMSUNG	GT-I9082i	FCC DOC	CTI
Router	TP-Link	TL-WR340G+	FCC DOC	CTI

6.5 Test Location

All tests were performed at:

Centre Testing International Group Co., Ltd.

Hongwei Industrial Zone, Bao'an 70 District, Shenzhen, Guangdong, China518101

Telephone: +86 (0) 755 33683668 Fax:+86 (0) 755 33683385

No tests were sub-contracted.

6.6 Test Facility

The test facility is recognized, certified, or accredited by the following organizations:

CNAS-Lab Code: L1910

Centre Testing International Group Co., Ltd. has been assessed and proved to be in compliance with CNAS-CL01 Accreditation Criteria for Testing and Calibration Laboratories (identical to ISO/IEC 17025: 2005 General Requirements) for the Competence of Testing and Calibration Laboratories..

A2LA-Lab Cert. No. 3061.01

Centre Testing International Group Co., Ltd. EMC Laboratory has been accredited by A2LA for technical competence in the field of electrical testing, and proved to be in compliance with ISO/IEC 17025: 2005 General Requirements for the Competence of Testing and Calibration Laboratories and any additional program requirements in the identified field of testing.

FCC-Registration No.: 565659

Centre Testing International Group Co., Ltd. EMC Laboratory has been registered and fully described in a report filed with the FCC (Federal Communications Commission). The acceptance letter from the FCC is maintained in our files. Registration 565659.

IC-Registration No.: 7408A

The 3m Alternate Test Site of Centre Testing International Group Co., Ltd. has been registered by Certification and Engineering Bureau of Industry Canada for the performance of radiated measurements with Registration No. 7408A .

IC-Registration No.: 7408B

The 10m Alternate Test Site of Centre Testing International Group Co., Ltd. has been registered by Certification and Engineering Bureau of Industry Canada for the performance of radiated measurements with Registration No. 7408B.

NEMKO-Aut. No.: ELA503

Centre Testing International Group Co., Ltd. has been assessed the quality assurance system, the testing facilities, qualifications and testing practices of the relevant parts of the organization. The quality assurance system of the Laboratory has been validated against ISO/IEC 17025 or equivalent. The laboratory also fulfils the conditions described in Nemko Document NLA-10.

VCCI

The Radiation 3 & 10 meters site of Centre Testing International Group Co., Ltd. has been registered in accordance with the Regulations for Voluntary Control Measures with Registration No.: R-4096.

Main Ports Conducted Interference Measurement of Centre Testing International Group Co., Ltd. has been registered in accordance with the Regulations for Voluntary Control Measures with Registration No.: C-4563.

Telecommunication Ports Conducted Disturbance Measurement of Centre Testing International Group Co., Ltd. has been registered in accordance with the Regulations for Voluntary Control Measures with Registration No.: T-2146.

The Radiation 3 meters site of Centre Testing International Group Co., Ltd. has been registered in accordance with the Regulations for Voluntary Control Measures with Registration No.: G-758

6.7 Deviation from Standards

None.

6.8 Abnormalities from Standard Conditions

None.

6.9 Other Information Requested by the Customer

None.

6.10 Measurement Uncertainty(95% confidence levels, k=2)

No.	Item	Measurement Uncertainty
1	Radio Frequency	7.9×10^{-8}
2	RF power, conducted	0.31dB (30MHz-1GHz)
		0.57dB(1GHz-18GHz)
3	Radiated Spurious emission test	4.5dB (30MHz-1GHz)
		4.8dB(1GHz-12.75GHz)
4	Conduction emission	3.6dB (9kHz to 150kHz)
		3.2dB (150kHz to 30MHz)
5	Temperature test	0.64°C
6	Humidity test	2.8%
7	DC power voltages	0.025%

7 Equipment List

RF test system					
Equipment	Manufacturer	Mode No.	Serial Number	Cal. Date (mm-dd-yyyy)	Cal. Due date (mm-dd-yyyy)
Signal Generator	Keysight	E8257D	MY53401106	04-14-2015	04-13-2016
Communication test set test set	Agilent	N4010A	MY47230124	04-02-2015	04-01-2016
Spectrum Analyzer	Keysight	N9010A	MY54510339	04-01-2015	03-31-2016
Attenuator	HuaXiang	SHX370	15040701	04-01-2015	03-31-2016
Signal Generator	Keysight	N5182B	MY53051549	03-31-2015	03-30-2016
High-pass filter(3-18GHz)	Sinoscite	FL3CX03WG18 NM12-0398-002	---	01-13-2015	01-12-2016
High-pass filter(5-18GHz)	MICRO-TRONICS	SPA-F-63029-4	---	01-13-2015	01-12-2016
band rejection filter (GSM900)	Sinoscite	FL5CX01CA09C L12-0395-001	---	01-13-2015	01-12-2016
band rejection filter (GSM850)	Sinoscite	FL5CX01CA08C L12-0393-001	---	01-13-2015	01-12-2016
band rejection filter (GSM1800)	Sinoscite	FL5CX02CA04C L12-0396-002	---	01-13-2015	01-12-2016
band rejection filter (GSM1900)	Sinoscite	FL5CX02CA03C L12-0394-001	---	01-13-2015	01-12-2016
DC Power	Keysight	E3642A	MY54436035	03-31-2015	03-30-2016
PC-1	Lenovo	R4960d	---	04-01-2015	03-31-2016
BT&WI-FI Automatic control	R&S	OSPB157	101374	04-01-2015	03-31-2016
RF control unit	JS Tonscend	JS0806-2	2015860006	04-01-2015	03-31-2016
BT&WI-FI Automatic test software	JS Tonscend	JSTS1120-2	---	04-01-2015	03-31-2016

Conducted disturbance Test					
Equipment	Manufacturer	Mode No.	Serial Number	Cal. date (mm-dd-yyyy)	Cal. Due date (mm-dd-yyyy)
Receiver	R&S	ESCI	100435	06-30-2015	06-28-2016
Receiver	R&S	ESCI	100009	06-30-2015	06-28-2016
Temperature/ Humidity Indicator	Belida	TT-512	101	07-09-2015	07-07-2016
Communication test set	Agilent	E5515C	GB47050533	01-13-2015	01-12-2016
Communication test set	R&S	CMW500	152394	04-19-2015	04-18-2016
LISN	R&S	ENV216	100098	06-30-2015	06-28-2016
LISN	schwarzbeck	NNLK8121	8121-529	06-30-2015	06-28-2016
Voltage Probe	R&S	ESH2-Z3	100042	07-09-2014	07-08-2017
Current Probe	R&S	EZ17	100106	07-09-2014	07-08-2017
ISN	TESEQ GmbH	ISN T800	30297	01-29-2015	01-27-2017

3M Semi/full-anechoic Chamber					
Equipment	Manufacturer	Mode No.	Serial Number	Cal. date (mm-dd-yyyy)	Cal. Due date (mm-dd-yyyy)
3M Chamber	TDK	SAC-3	---	06-02-2013	06-01-2016
TRILOG Broadband Antenna	schwarzbeck	VULB9163	9163-617	07-31-2015	07-29-2016
Microwave Preamplifier	Agilent	8449B	3008A02425	02-05-2015	02-04-2016
Horn Antenna	ETS-LINDGREN	3117	00057410	06-30-2015	06-28-2018
Loop Antenna	ETS	6502	00071730	07-30-2015	07-28-2017
Spectrum Analyzer	R&S	FSP40	100416	06-30-2015	06-28-2016
Receiver	R&S	ESCI	100435	06-30-2015	06-28-2016
Multi device Controller	maturro	NCD/070/10711112	---	01-13-2015	01-12-2016
LISN	schwarzbeck	NNBM8125	81251547	06-30-2015	06-28-2016
LISN	schwarzbeck	NNBM8125	81251548	06-30-2015	06-28-2016
Signal Generator	Agilent	E4438C	MY45095744	04-19-2015	04-18-2016
Signal Generator	Keysight	E8257D	MY53401106	04-14-2015	04-13-2016
Temperature/ Humidity Indicator	TAYLOR	1451	1905	07- 08-2015	07-06-2016
Communication test set	Agilent	E5515C	GB47050533	01-13-2015	01-12-2016
Cable line	Fulai(7M)	SF106	5219/6A	01-13-2015	01-12-2016
Cable line	Fulai(6M)	SF106	5220/6A	01-13-2015	01-12-2016
Cable line	Fulai(3M)	SF106	5216/6A	01-13-2015	01-12-2016
Cable line	Fulai(3M)	SF106	5217/6A	01-13-2015	01-12-2016
Communication test set	R&S	CMW500	152394	04-19-2015	04-18-2016
High-pass filter(3-18GHz)	Sinoscite	FL3CX03WG18NM 12-0398-002	---	01-13-2015	01-12-2016
High-pass filter(5-18GHz)	MICRO-TRONICS	SPA-F-63029-4	---	01-13-2015	01-12-2016
band rejection filter	Sinoscite	FL5CX01CA09CL1 2-0395-001	---	01-13-2015	01-12-2016
band rejection filter	Sinoscite	FL5CX01CA08CL1 2-0393-001	---	01-13-2015	01-12-2016
band rejection filter	Sinoscite	FL5CX02CA04CL1 2-0396-002	---	01-13-2015	01-12-2016
band rejection filter	Sinoscite	FL5CX02CA03CL1 2-0394-001	---	01-13-2015	01-12-2016

8 Radio Technical Requirements Specification

Reference documents for testing:

No.	Identity	Document Title
1	FCC Part15C (2014)	Subpart C-Intentional Radiators
2	ANSI C63.10-2013	American National Standard for Testing Unlicensed Wireless Devices

Test Results List:

Test Requirement	Test method	Test item	Verdict	Note
Part15C Section 15.247 (a)(2)	ANSI C63.10	6dB Occupied Bandwidth	PASS	Appendix A)
Part15C Section 15.247 (b)(3)	ANSI C63.10	Conducted Peak Output Power	PASS	Appendix B)
Part15C Section 15.247(d)	ANSI C63.10	Band-edge for RF Conducted Emissions	PASS	Appendix C)
Part15C Section 15.247(d)	ANSI C63.10	RF Conducted Spurious Emissions	PASS	Appendix D)
Part15C Section 15.247 (e)	ANSI C63.10	Power Spectral Density	PASS	Appendix E)
Part15C Section 15.203/15.247 (c)	ANSI C63.10	Antenna Requirement	PASS	Appendix F)
Part15C Section 15.207	ANSI C63.10	AC Power Line Conducted Emission	PASS	Appendix G)
Part15C Section 15.205/15.209	ANSI C63.10	Restricted bands around fundamental frequency (Radiated Emission)	PASS	Appendix H)
Part15C Section 15.205/15.209	K ANSI C63.10	Radiated Spurious Emissions	PASS	Appendix I)

Appendix A) 6dB Occupied Bandwidth

Test Result

Mode	Channel	6dB Bandwidth [MHz]	99% OBW[MHz]	Verdict	Remark
BLE	LCH	0.6951	1.0647	PASS	Peak detector
BLE	MCH	0.6970	1.0738	PASS	
BLE	HCH	0.6989	1.0717	PASS	

Test Graphs

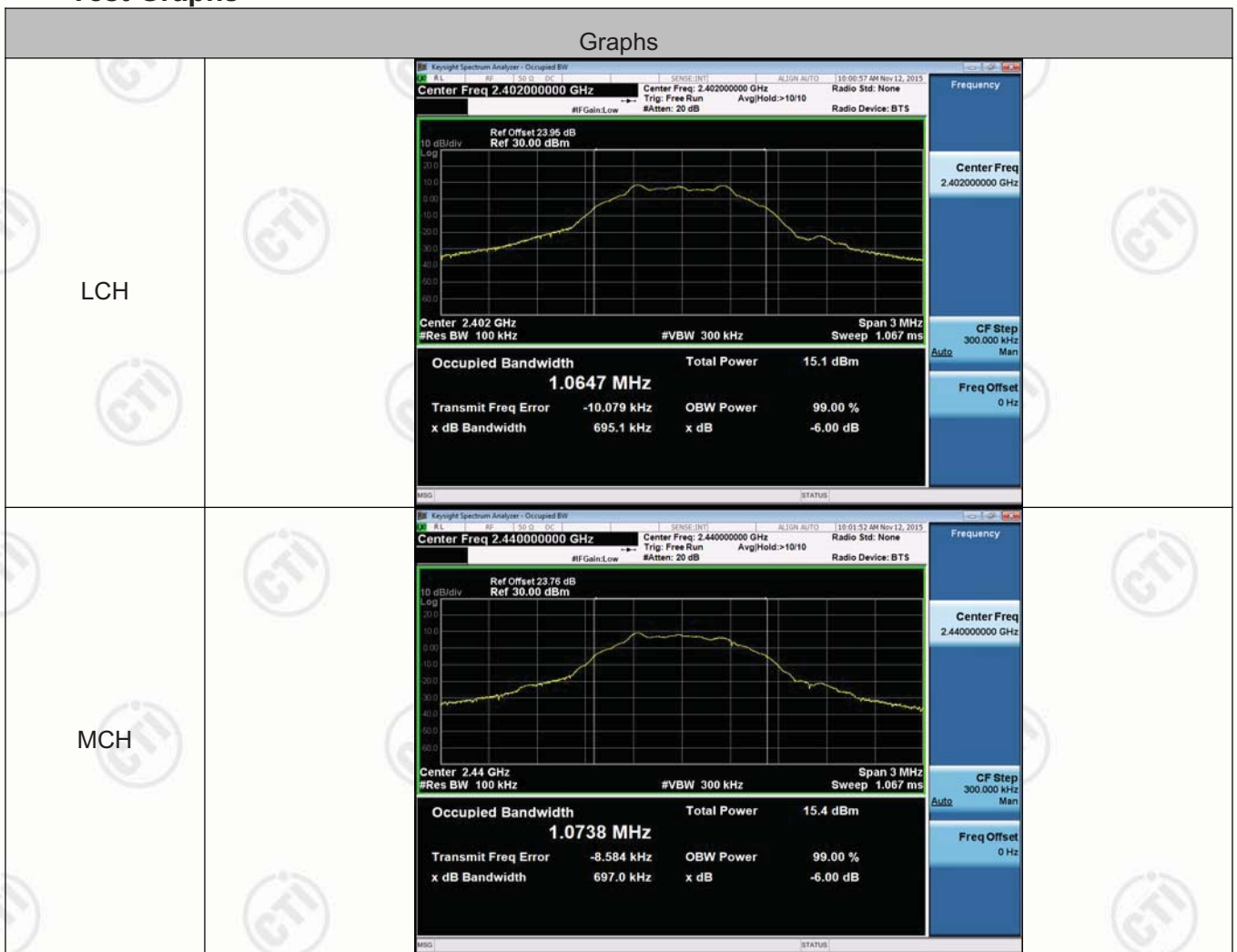

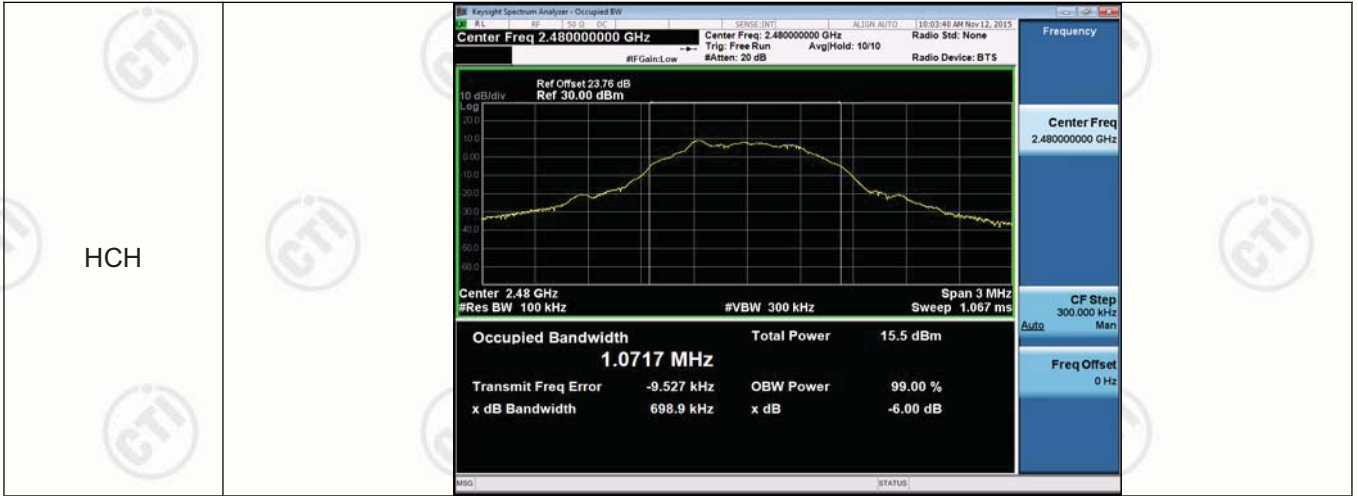

Appendix B) Conducted Peak Output Power

Test Result

Mode	Channel	Conduct Peak Power[dBm]	Verdict
BLE	LCH	8.913	PASS
BLE	MCH	9.524	PASS
BLE	HCH	9.594	PASS

Test Graphs

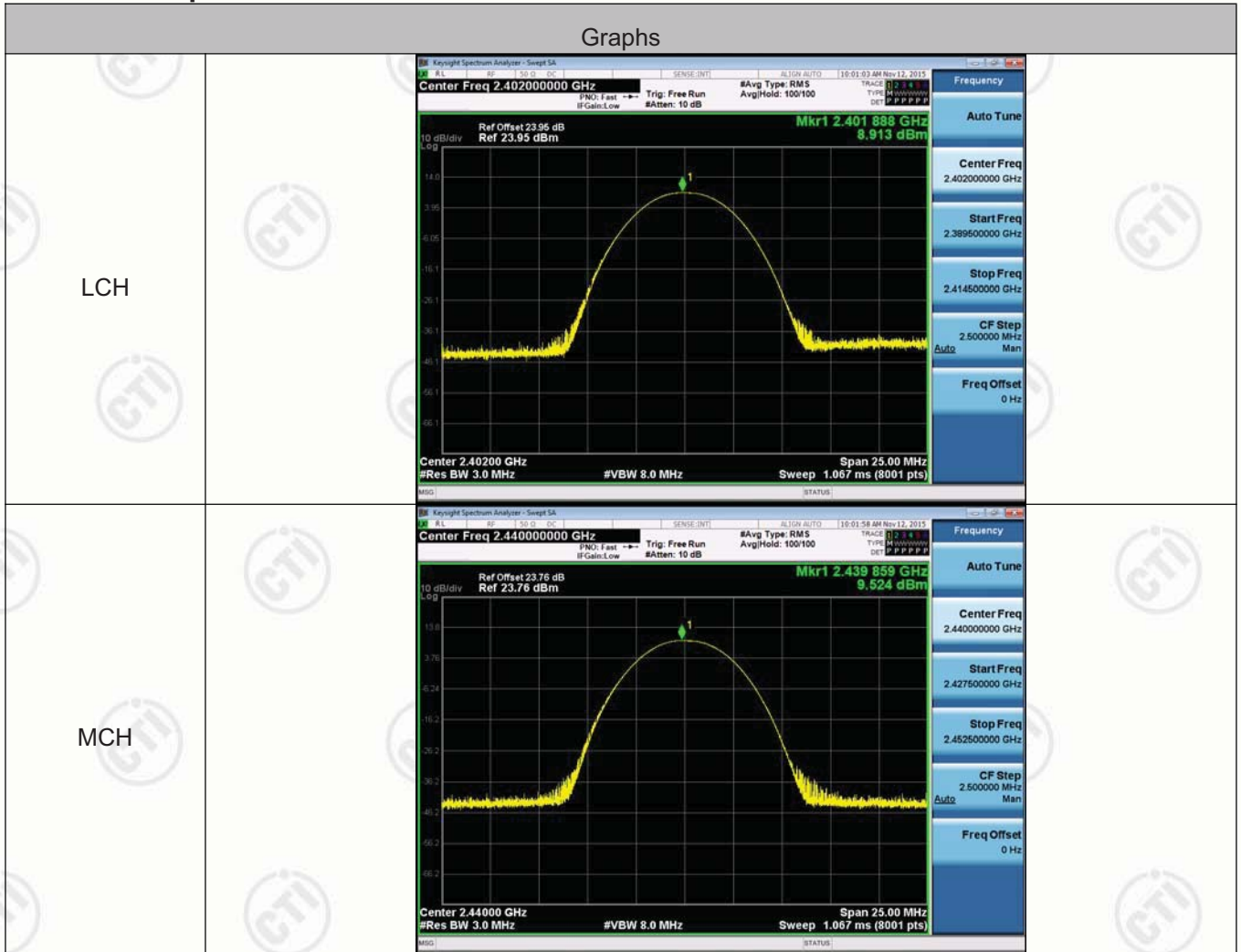

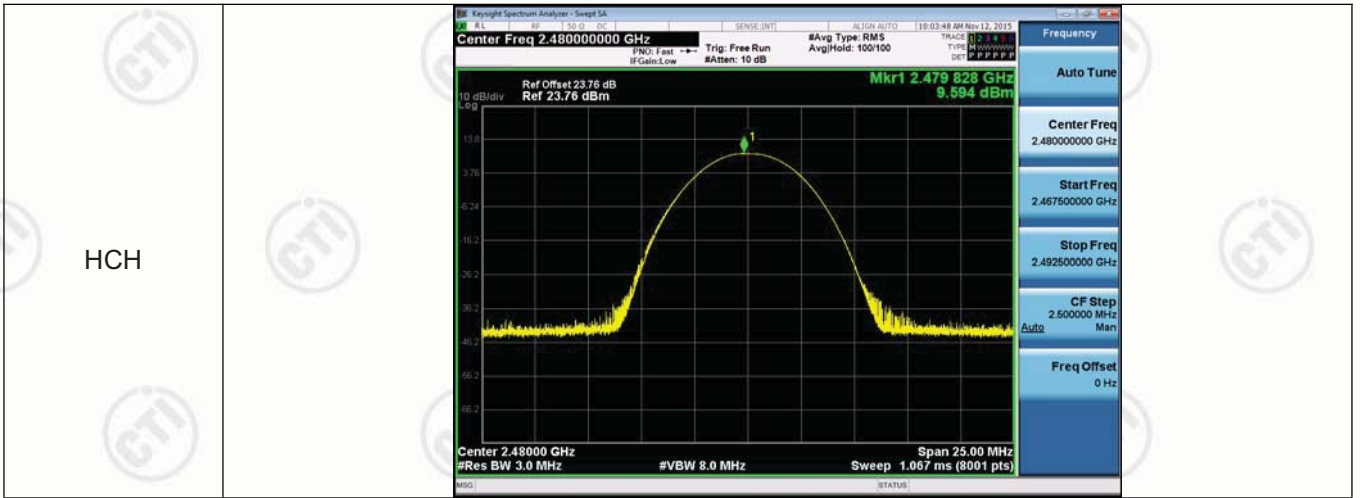

Appendix C) Band-edge for RF Conducted Emissions

Result Table

Mode	Channel	Carrier Power[dBm]	Max.Spurious Level [dBm]	Limit [dBm]	Verdict
BLE	LCH	8.548	-55.325	-11.45	PASS
BLE	HCH	9.194	-51.216	-10.81	PASS

Test Graphs

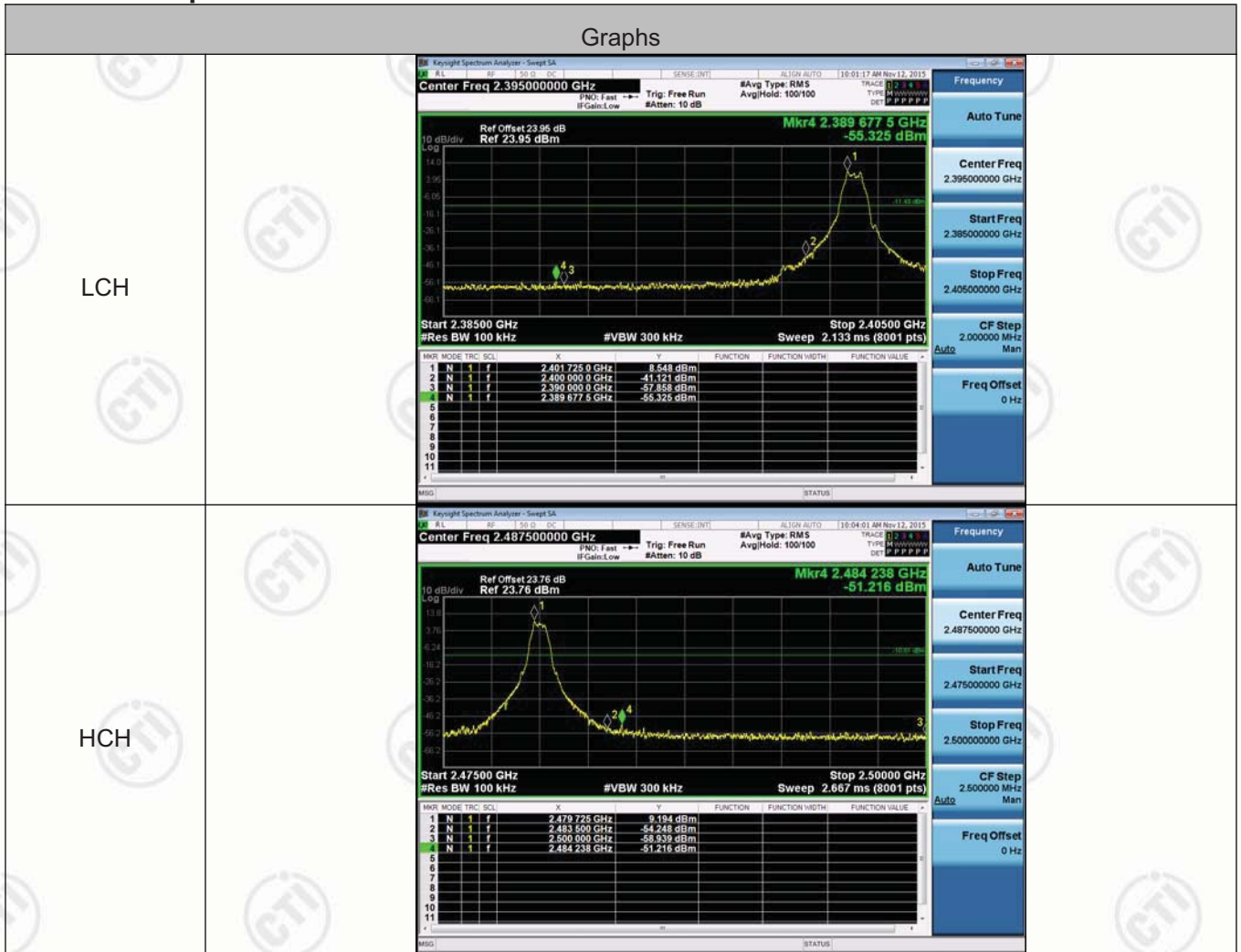

Appendix D) RF Conducted Spurious Emissions

Result Table

Mode	Channel	Pref [dBm]	Puw[dBm]	Verdict
BLE	LCH	8.536	<Limit	PASS
BLE	MCH	9.119	<Limit	PASS
BLE	HCH	9.146	<Limit	PASS

Test Graphs

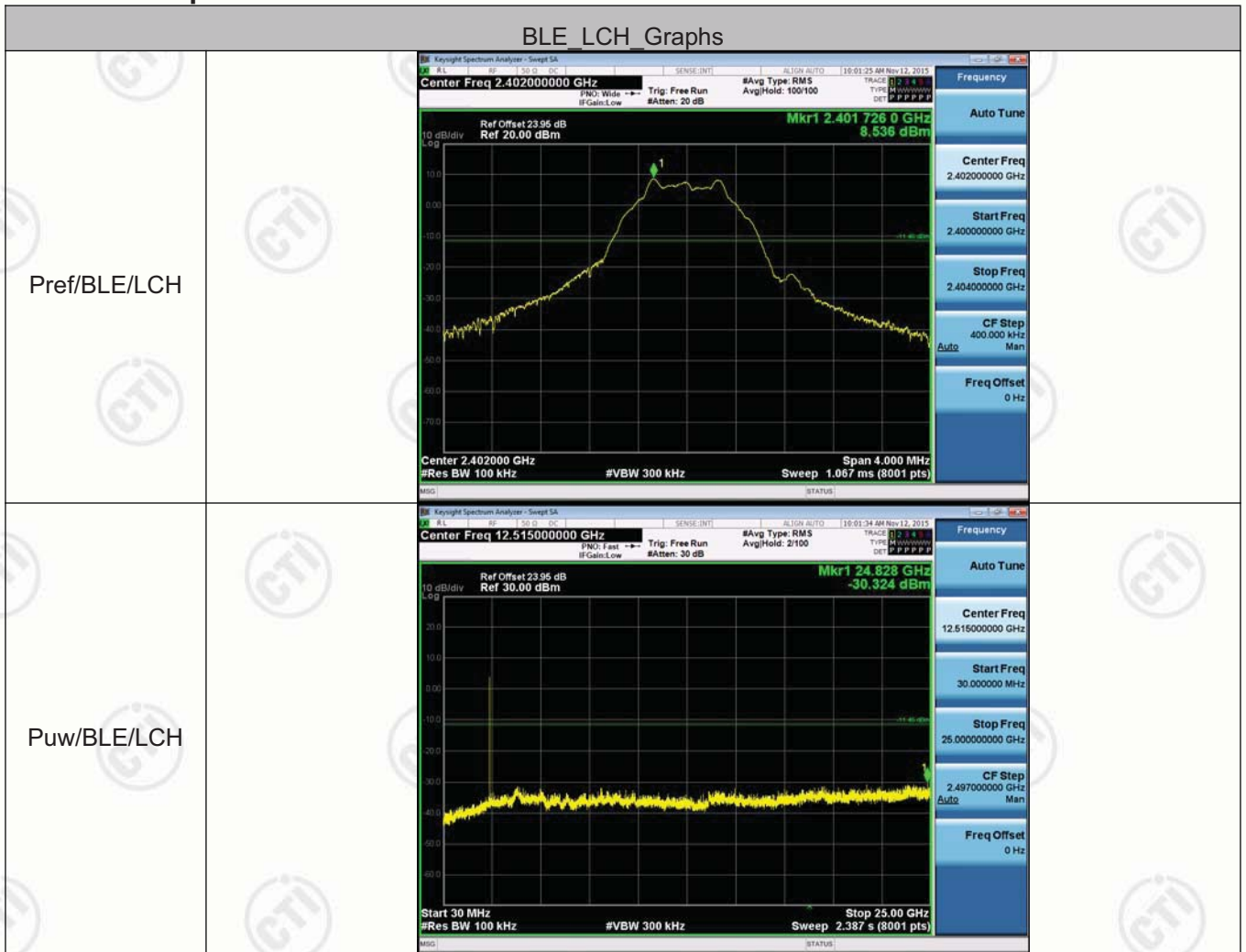

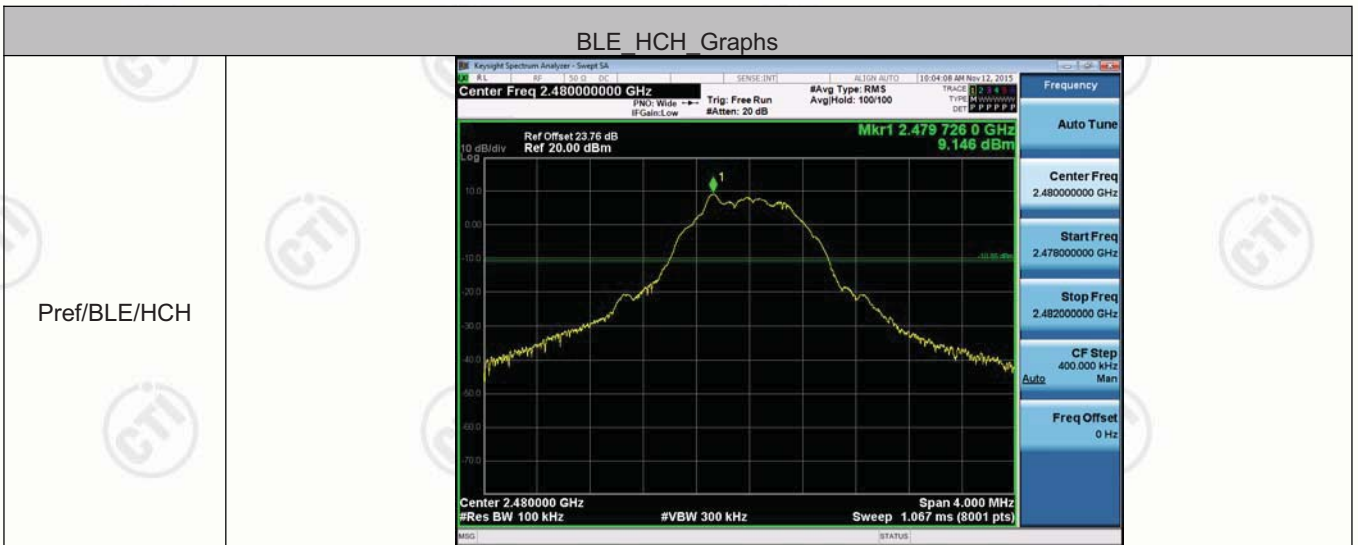
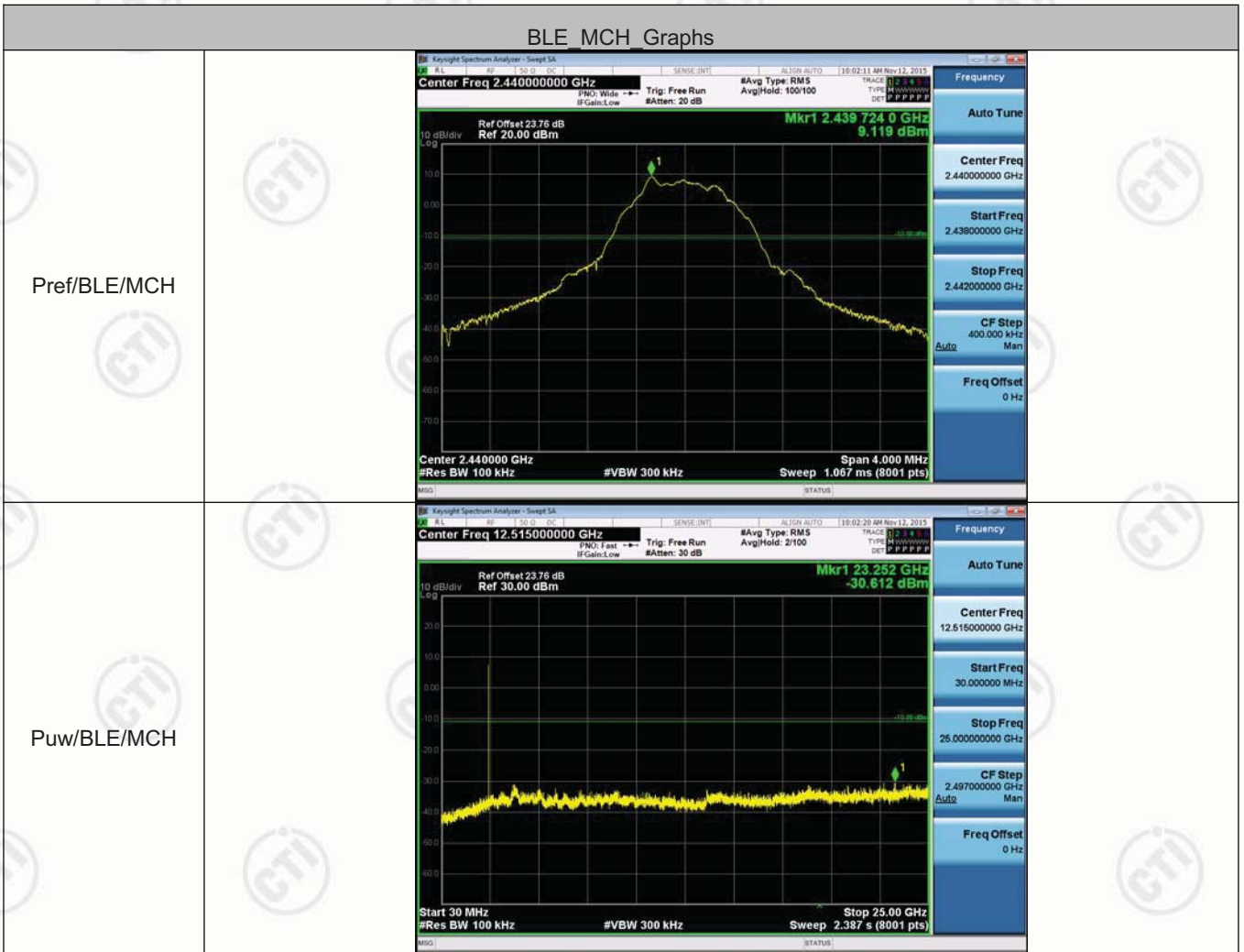

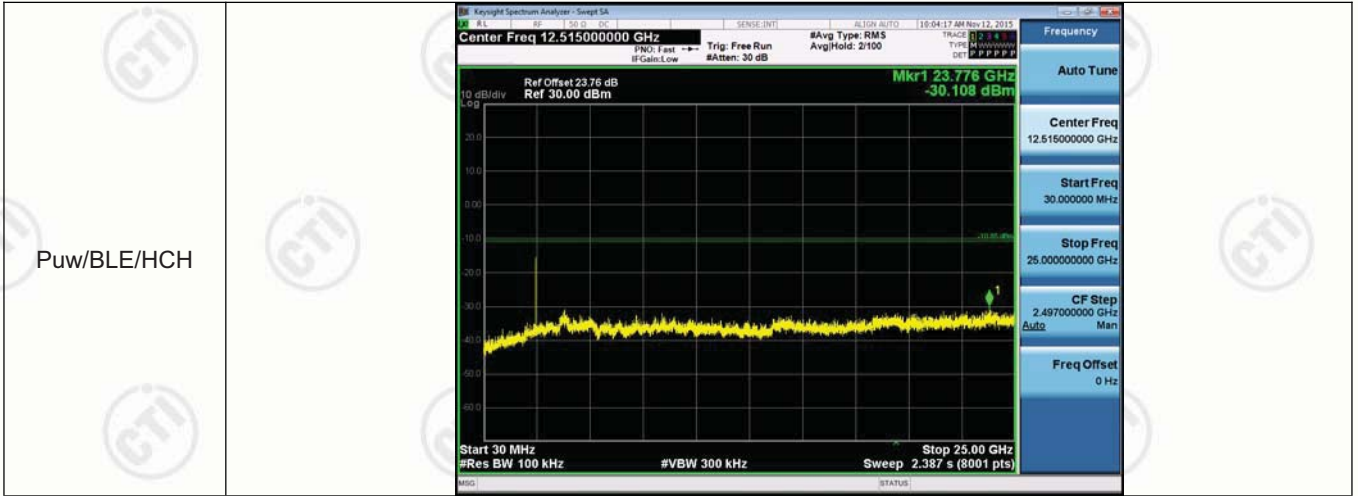

Appendix E) Power Spectral Density

Result Table

Mode	Channel	PSD [dBm]	Verdict
BLE	LCH	-7.613	PASS
BLE	MCH	-4.623	PASS
BLE	HCH	-6.436	PASS

Test Graphs

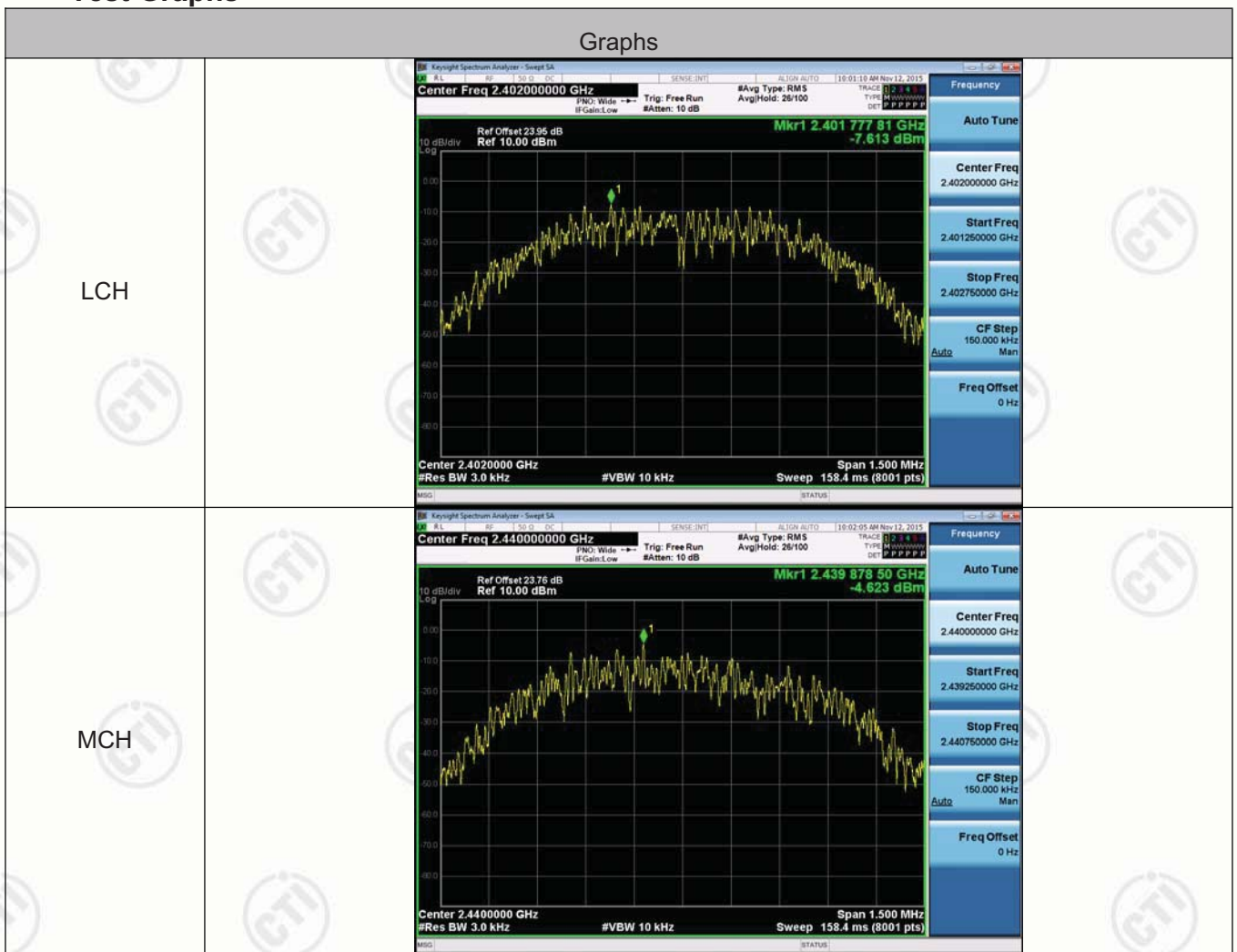

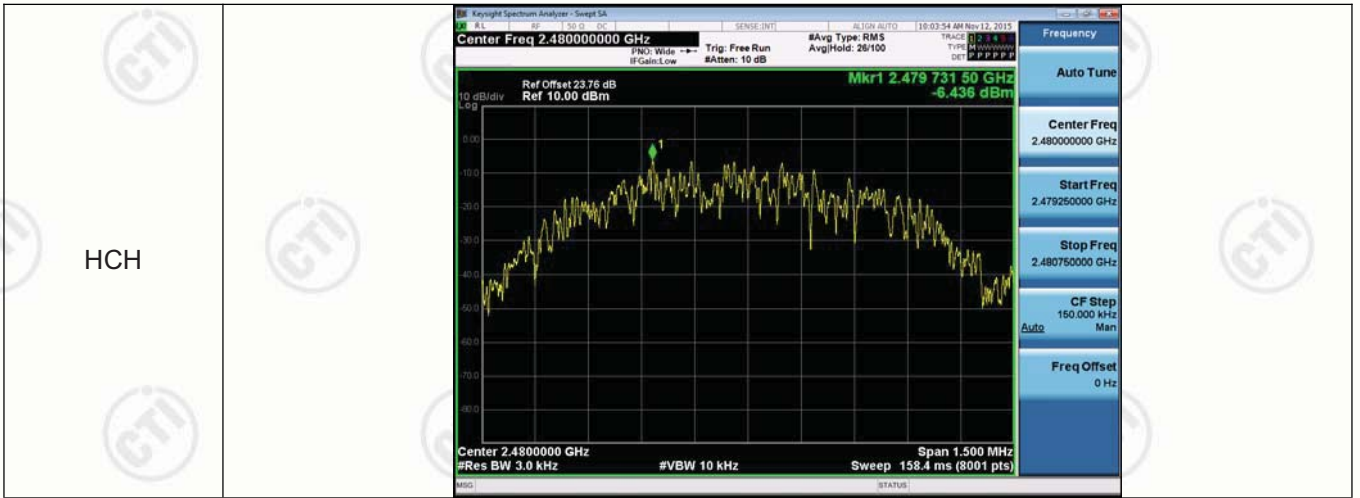

Appendix F) Antenna Requirement

15.203 requirement:

An intentional radiator shall be designed to ensure that no antenna other than that furnished by the responsible party shall be used with the device. The use of a permanently attached antenna or of an antenna that uses a unique coupling to the intentional radiator, the manufacturer may design the unit so that a broken antenna can be replaced by the user, but the use of a standard antenna jack or electrical connector is prohibited.

15.247(b) (4) requirement:

The conducted output power limit specified in paragraph (b) of this section is based on the use of antennas with directional gains that do not exceed 6 dBi. Except as shown in paragraph (c) of this section, if transmitting antennas of directional gain greater than 6 dBi are used, the conducted output power from the intentional radiator shall be reduced below the stated values in paragraphs (b)(1), (b)(2), and (b)(3) of this section, as appropriate, by the amount in dB that the directional gain of the antenna exceeds 6 dBi.

EUT Antenna:

The antenna is integrated on the main PCB and no consideration of replacement. The best case gain of the antenna is 2.2dBi.



Appendix G) AC Power Line Conducted Emission

<p>Test Procedure:</p>	<p>Test frequency range :150KHz-30MHz</p> <ol style="list-style-type: none"> 1) The mains terminal disturbance voltage test was conducted in a shielded room. 2) The EUT was connected to AC power source through a LISN 1 (Line Impedance Stabilization Network) which provides a 50Ω/50μH + 5Ω linear impedance. The power cables of all other units of the EUT were connected to a second LISN 2, which was bonded to the ground reference plane in the same way as the LISN 1 for the unit being measured. A multiple socket outlet strip was used to connect multiple power cables to a single LISN provided the rating of the LISN was not exceeded. 3) The tabletop EUT was placed upon a non-metallic table 0.8m above the ground reference plane. And for floor-standing arrangement, the EUT was placed on the horizontal ground reference plane, 4) The test was performed with a vertical ground reference plane. The rear of the EUT shall be 0.4 m from the vertical ground reference plane. The vertical ground reference plane was bonded to the horizontal ground reference plane. The LISN 1 was placed 0.8 m from the boundary of the unit under test and bonded to a ground reference plane for LISNs mounted on top of the ground reference plane. This distance was between the closest points of the LISN 1 and the EUT. All other units of the EUT and associated equipment was at least 0.8 m from the LISN 2. 5) In order to find the maximum emission, the relative positions of equipment and all of the interface cables must be changed according to ANSI C63.10 on conducted measurement. 																
<p>Limit:</p>	<table border="1"> <thead> <tr> <th rowspan="2">Frequency range (MHz)</th> <th colspan="2">Limit (dBμV)</th> </tr> <tr> <th>Quasi-peak</th> <th>Average</th> </tr> </thead> <tbody> <tr> <td>0.15-0.5</td> <td>66 to 56*</td> <td>56 to 46*</td> </tr> <tr> <td>0.5-5</td> <td>56</td> <td>46</td> </tr> <tr> <td>5-30</td> <td>60</td> <td>50</td> </tr> </tbody> </table>	Frequency range (MHz)	Limit (dBμV)		Quasi-peak	Average	0.15-0.5	66 to 56*	56 to 46*	0.5-5	56	46	5-30	60	50		
Frequency range (MHz)	Limit (dBμV)																
	Quasi-peak	Average															
0.15-0.5	66 to 56*	56 to 46*															
0.5-5	56	46															
5-30	60	50															
<p>* The limit decreases linearly with the logarithm of the frequency in the range 0.15 MHz to 0.50 MHz.</p> <p>NOTE : The lower limit is applicable at the transition frequency</p>																	

Measurement Data

An initial pre-scan was performed on the live and neutral lines with peak detector.

Quasi-Peak and Average measurement were performed at the frequencies with maximized peak emission were detected.

Live line:

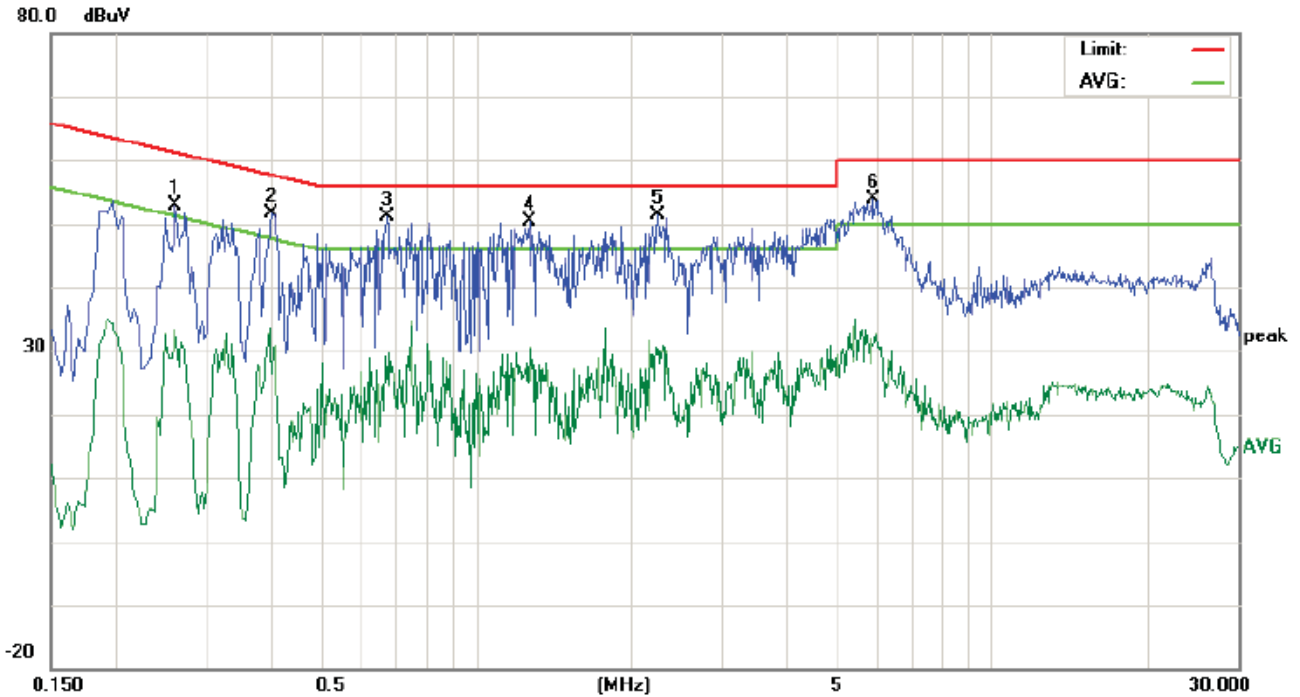

No.	Freq. MHz	Reading_Level (dBuV)			Correct Factor dB	Measurement (dBuV)			Limit (dBuV)		Margin (dB)		P/F	Comment
		Peak	QP	AVG		peak	QP	AVG	QP	AVG	QP	AVG		
1	0.2620	43.05	39.25	23.46	9.80	52.85	49.05	33.26	61.36	51.36	-12.31	-18.10	P	
2	0.4020	41.63	38.70	16.59	9.90	51.53	48.60	26.49	57.81	47.81	-9.21	-21.32	P	
3	0.6740	41.15	38.12	15.71	9.90	51.05	48.02	25.61	56.00	46.00	-7.98	-20.39	P	
4	1.2740	40.50	36.00	20.26	10.00	50.50	46.00	30.26	56.00	46.00	-10.00	-15.74	P	
5	2.2500	41.27	37.64	20.31	10.00	51.27	47.64	30.31	56.00	46.00	-8.36	-15.69	P	
6	5.8978	43.80	39.01	20.95	10.00	53.80	49.01	30.95	60.00	50.00	-10.99	-19.05	P	

Neutral line:

80.0 dBuV

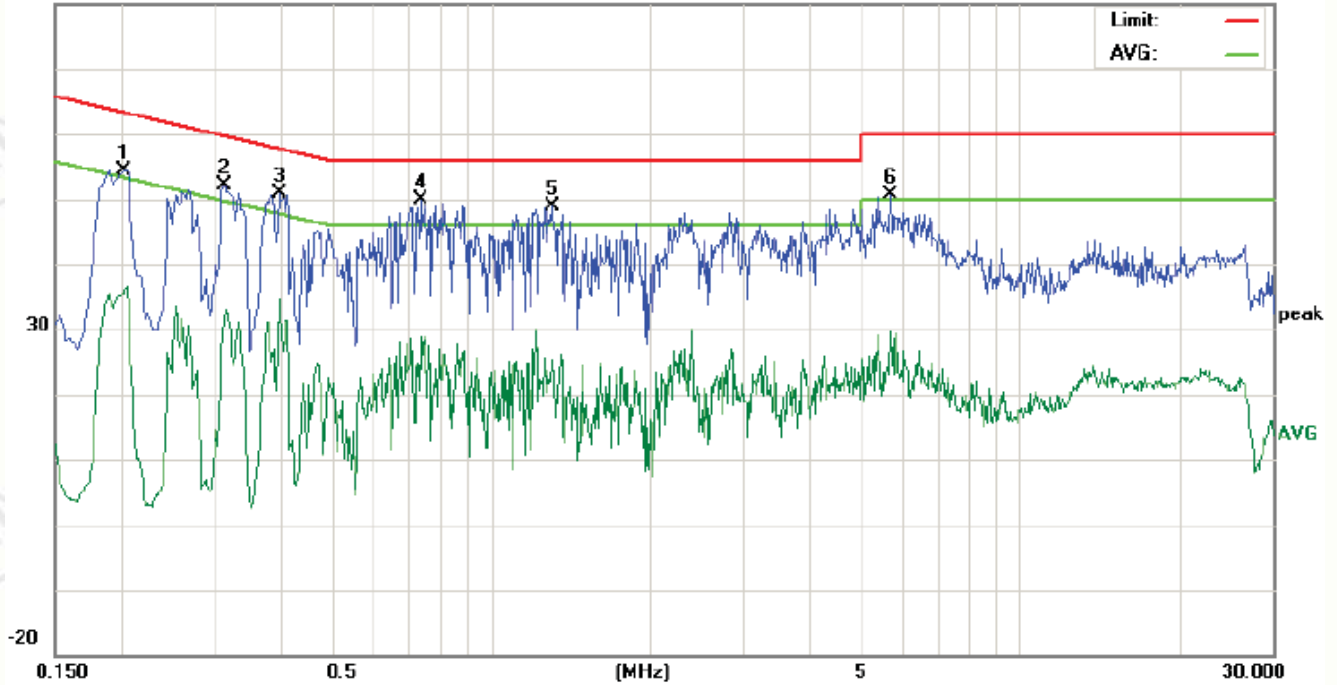

No.	Freq. MHz	Reading_Level (dBuV)			Correct Factor dB	Measurement (dBuV)			Limit (dBuV)		Margin (dB)		P/F	Comment
		Peak	QP	AVG		peak	QP	AVG	QP	AVG	QP	AVG		
1	0.2020	44.67	38.50	25.58	9.80	54.47	48.30	35.38	63.52	53.52	-15.22	-18.14	P	
2	0.3140	42.28	37.26	21.97	9.81	52.09	47.07	31.78	59.86	49.86	-12.79	-18.08	P	
3	0.3980	40.91	35.17	24.71	9.90	50.81	45.07	34.61	57.89	47.89	-12.82	-13.28	P	
4	0.7378	39.93	34.60	18.90	9.90	49.83	44.50	28.80	56.00	46.00	-11.50	-17.20	P	
5	1.3060	38.80	33.20	14.39	10.00	48.80	43.20	24.39	56.00	46.00	-12.80	-21.61	P	
6	5.7057	40.64	34.00	19.56	10.00	50.64	44.00	29.56	60.00	50.00	-16.00	-20.44	P	

Notes:

1. The following Quasi-Peak and Average measurements were performed on the EUT:
2. Final Test Level = Receiver Reading + LISN Factor + Cable Loss.

Appendix H) Restricted bands around fundamental frequency (Radiated)

Receiver Setup:	Frequency	Detector	RBW	VBW	Remark
	30MHz-1GHz	Quasi-peak	120 kHz	300kHz	Quasi-peak
	Above 1GHz	Peak	1MHz	3MHz	Peak
		Peak	1MHz	10Hz	Average
Test Procedure:	<p>Below 1GHz test procedure as below:</p> <ol style="list-style-type: none"> The EUT was placed on the top of a rotating table 0.8 meters above the ground at a 3 meter semi-anechoic chamber. The table was rotated 360 degrees to determine the position of the highest radiation. The EUT was set 3 meters away from the interference-receiving antenna, which was mounted on the top of a variable-height antenna tower. The antenna height is varied from one meter to four meters above the ground to determine the maximum value of the field strength. Both horizontal and vertical polarizations of the antenna are set to make the measurement. For each suspected emission, the EUT was arranged to its worst case and then the antenna was tuned to heights from 1 meter to 4 meters and the rotatable table was turned from 0 degrees to 360 degrees to find the maximum reading. The test-receiver system was set to Peak Detect Function and Specified Bandwidth with Maximum Hold Mode. Place a marker at the end of the restricted band closest to the transmit frequency to show compliance. Also measure any emissions in the restricted bands. Save the spectrum analyzer plot. Repeat for each power and modulation for lowest and highest channel! <p>Above 1GHz test procedure as below:</p> <ol style="list-style-type: none"> Different between above is the test site, change from Semi- Anechoic Chamber to fully Anechoic Chamber change form table 0.8 metre to 1.5 metre(Above 18GHz the distance is 1 meter and table is 1.5 metre). . Test the EUT in the lowest channel , the Highest channel The radiation measurements are performed in X, Y, Z axis positioning for Transmitting mode, and found the X axis positioning which it is worse case. Repeat above procedures until all frequencies measured was complete. 				
Limit:	Frequency	Limit (dB μ V/m @3m)	Remark		
	30MHz-88MHz	40.0	Quasi-peak Value		
	88MHz-216MHz	43.5	Quasi-peak Value		
	216MHz-960MHz	46.0	Quasi-peak Value		
	960MHz-1GHz	54.0	Quasi-peak Value		
	Above 1GHz	54.0	Average Value		
		74.0	Peak Value		

Test plot as follows:

Worse case mode:		GFSK								
Frequency (MHz)	Read Level (dBμV)	Level (dBμV/m)	Antenna Factor (dB/m)	Cable Loss (dB)	Preamplifier Factor (dB)	Limit (dBμV/m)	Over Limit (dB)	Antenna Polaxis	Remark	Test channel
2390.00	44.86	44.46	32.53	4.28	37.21	74	-29.54	H	PK	Lowest
2390.00	44.14	43.74	32.53	4.28	37.21	74	-30.26	V	PK	Lowest
2483.50	55.33	55.36	32.71	4.51	37.19	74	-18.64	H	PK	Highest
2483.50	36.81	36.84	32.71	4.51	37.19	54	-17.16	H	AV	Highest
2483.50	53.83	53.86	32.71	4.51	37.19	74	-20.14	V	PK	Highest

Note:

1) The field strength is calculated by adding the Antenna Factor, Cable Factor & Preamplifier. The basic equation with a sample calculation is as follows:

Final Test Level = Receiver Reading - Correct Factor

Correct Factor = Preamplifier Factor - Antenna Factor - Cable Factor

Appendix I) Radiated Spurious Emissions

Receiver Setup:					
Frequency	Detector	RBW	VBW	Remark	
0.009MHz-0.090MHz	Peak	10kHz	30kHz	Peak	
0.009MHz-0.090MHz	Average	10kHz	30kHz	Average	
0.090MHz-0.110MHz	Quasi-peak	10kHz	30kHz	Quasi-peak	
0.110MHz-0.490MHz	Peak	10kHz	30kHz	Peak	
0.110MHz-0.490MHz	Average	10kHz	30kHz	Average	
0.490MHz -30MHz	Quasi-peak	10kHz	30kHz	Quasi-peak	
30MHz-1GHz	Quasi-peak	120 kHz	300kHz	Quasi-peak	
Above 1GHz	Peak	1MHz	3MHz	Peak	
	Peak	1MHz	10Hz	Average	

Test Procedure:					
Below 1GHz test procedure as below:					
a. The EUT was placed on the top of a rotating table 0.8 meters above the ground at a 3 meter semi-anechoic chamber. The table was rotated 360 degrees to determine the position of the highest radiation. b. The EUT was set 3 meters away from the interference-receiving antenna, which was mounted on the top of a variable-height antenna tower. c. The antenna height is varied from one meter to four meters above the ground to determine the maximum value of the field strength. Both horizontal and vertical polarizations of the antenna are set to make the measurement. d. For each suspected emission, the EUT was arranged to its worst case and then the antenna was tuned to heights from 1 meter to 4 meters (for the test frequency of below 30MHz, the antenna was tuned to heights 1 meter) and the rotatable table was turned from 0 degrees to 360 degrees to find the maximum reading. e. The test-receiver system was set to Peak Detect Function and Specified Bandwidth with Maximum Hold Mode. f. If the emission level of the EUT in peak mode was 10dB lower than the limit specified, then testing could be stopped and the peak values of the EUT would be reported. Otherwise the emissions that did not have 10dB margin would be re-tested one by one using peak, quasi-peak or average method as specified and then reported in a data sheet.					
Above 1GHz test procedure as below:					
g. Different between above is the test site, change from Semi- Anechoic Chamber to fully Anechoic Chamber and change form table 0.8 metre to 1.5 metre(Above 18GHz the distance is 1 meter and table is 1.5 metre). h. Test the EUT in the lowest channel ,the middle channel ,the Highest channel i. The radiation measurements are performed in X, Y, Z axis positioning for Transmitting mode, and found the X axis positioning which it is worse case. j. Repeat above procedures until all frequencies measured was complete.					
Limit:	Frequency	Field strength (microvolt/meter)	Limit (dB μ V/m)	Remark	Measurement distance (m)
	0.009MHz-0.490MHz	2400/F(kHz)	-	-	300
	0.490MHz-1.705MHz	24000/F(kHz)	-	-	30
	1.705MHz-30MHz	30	-	-	30
	30MHz-88MHz	100	40.0	Quasi-peak	3
	88MHz-216MHz	150	43.5	Quasi-peak	3
	216MHz-960MHz	200	46.0	Quasi-peak	3
	960MHz-1GHz	500	54.0	Quasi-peak	3
	Above 1GHz	500	54.0	Average	3
Note: 15.35(b), Unless otherwise specified, the limit on peak radio frequency emissions is 20dB above the maximum permitted average emission limit applicable to the equipment under test. This peak limit applies to the total peak emission level radiated by the device.					

**Radiated Spurious Emissions test Data:
Radiated Emission below 1GHz**

30MHz~1GHz (QP)

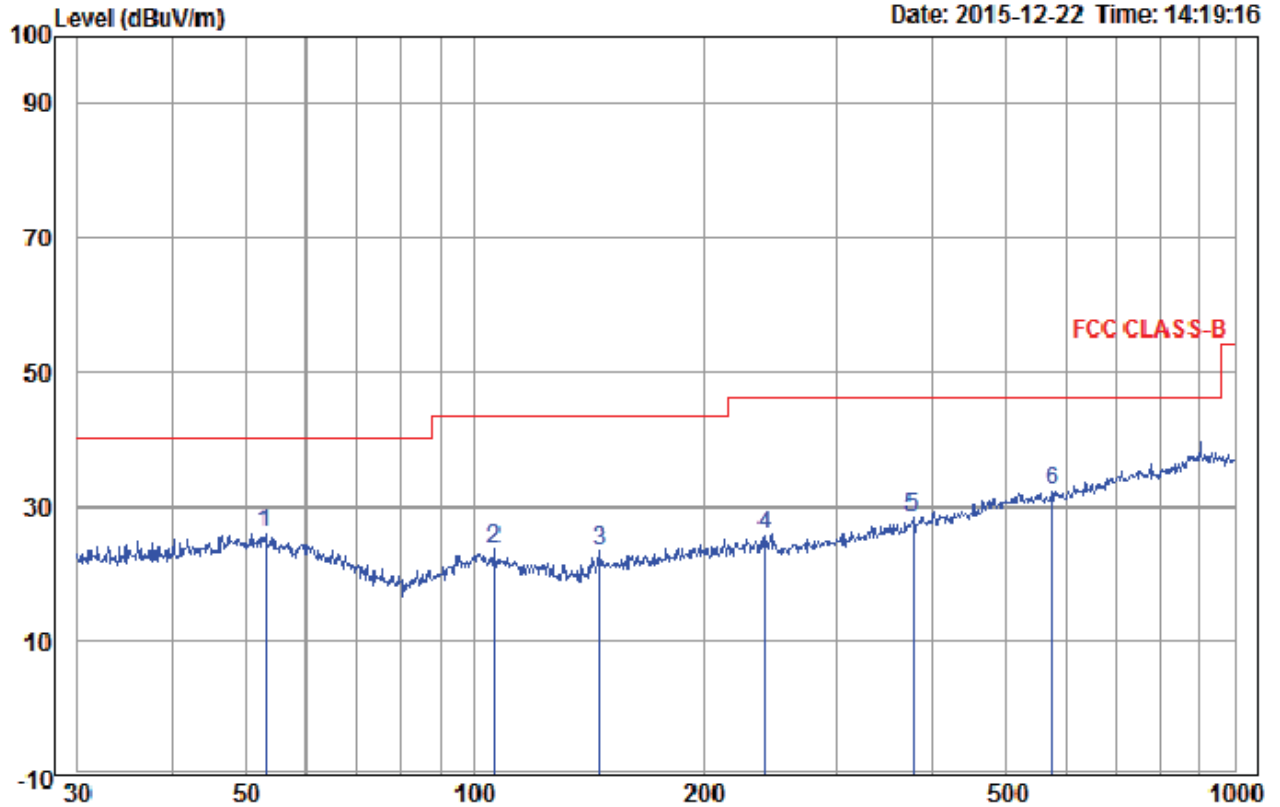

	Ant Freq	Cable Factor	Read Level	Limit Level	Over Limit	Pol/Phase	Remark
	MHz	dB/m	dB	dBuV	dBuV/m	dB	
1	52.95	14.69	1.41	9.92	26.02	40.00	-13.98 Horizontal
2	106.01	12.70	1.57	9.37	23.64	43.50	-19.86 Horizontal
3	146.37	9.91	1.58	11.85	23.34	43.50	-20.16 Horizontal
4	240.83	12.27	2.33	11.07	25.67	46.00	-20.33 Horizontal
5	377.26	15.64	2.76	9.85	28.25	46.00	-17.75 Horizontal
6 pp	576.64	18.71	3.37	10.21	32.29	46.00	-13.71 Horizontal

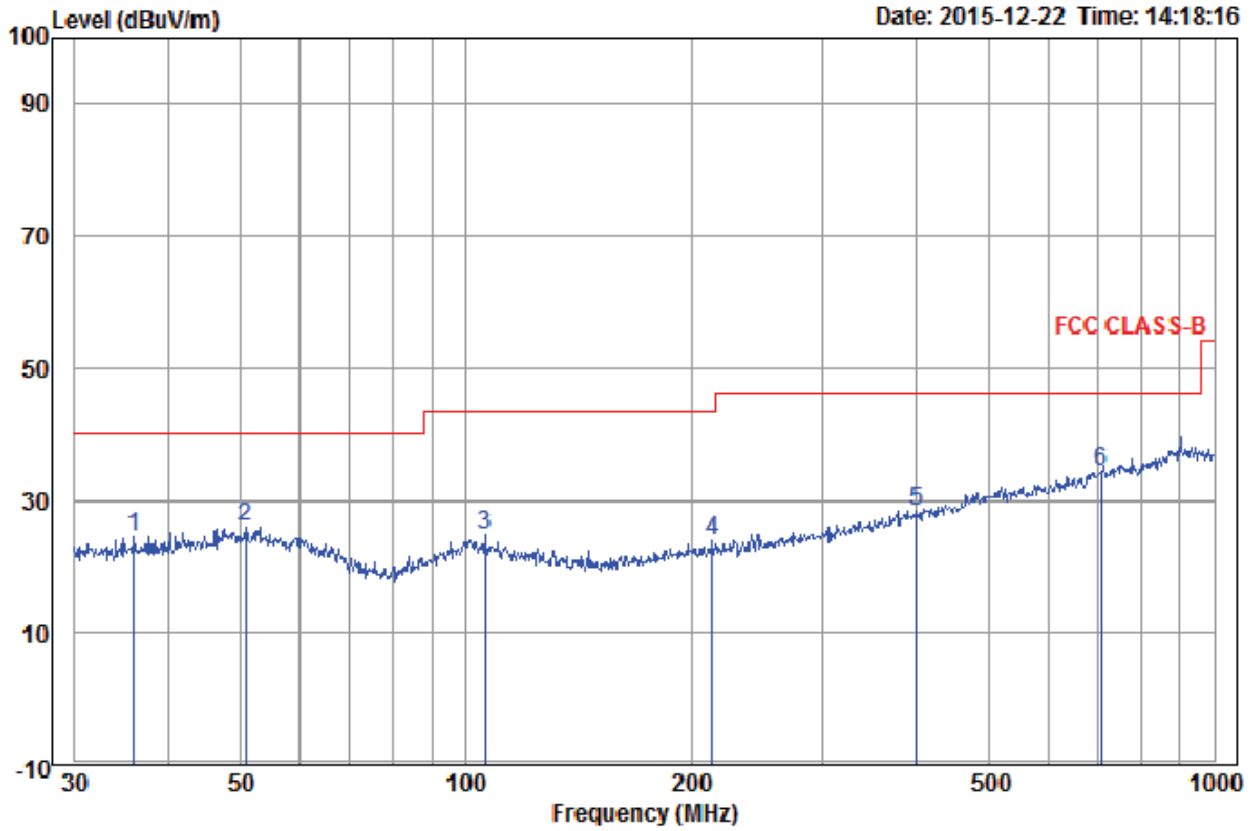

	Ant Freq	Cable Factor	Cable Loss	Read Level	Limit Level	Over Limit	Pol/Phase	Remark
	MHz	dB/m	dB	dBuV	dBuV/m	dBuV/m	dB	
1	36.00	13.58	0.77	10.25	24.60	40.00	-15.40	Vertical
2	50.76	14.99	1.40	9.62	26.01	40.00	-13.99	Vertical
3	106.01	12.70	1.57	10.37	24.64	43.50	-18.86	Vertical
4	213.76	11.84	2.25	9.89	23.98	43.50	-19.52	Vertical
5	400.43	16.31	2.80	9.31	28.42	46.00	-17.58	Vertical
6 pp	706.70	20.74	3.91	9.59	34.24	46.00	-11.76	Vertical

Transmitter Emission above 1GHz

Test mode:		GFSK		Test Frequency:		2402MHz		
Frequency (MHz)	Antenna Factor (dB/m)	Preamp Gain (dB)	Cable Loss (dB)	Read Level (dBμV)	PK Level (dBμV/m)	Limit Line (dBμV/m)	Over Limit (dB)	Antenna Polaxis
1472.44	30.82	38.01	2.80	46.24	41.85	74	-32.15	H
1865.735	31.50	37.46	3.13	45.25	42.42	74	-31.58	H
3216.838	33.41	37.05	5.58	46.25	48.19	74	-25.81	H
4804.000	34.69	36.82	5.11	42.85	45.83	74	-28.17	H
7206.000	36.42	37.46	6.66	42.63	48.25	74	-25.75	H
9608.000	37.88	37.82	7.73	43.99	51.78	74	-22.22	H
1518.111	30.90	37.94	2.84	45.61	41.41	74	-32.59	V
1668.044	31.18	37.72	2.98	44.97	41.41	74	-32.59	V
3274.672	33.36	37.04	5.57	45.37	47.26	74	-26.74	V
4804.000	34.69	36.82	5.11	42.87	45.85	74	-28.15	V
7206.000	36.42	37.46	6.66	42.65	48.27	74	-25.73	V
9608.000	37.88	37.82	7.73	43.79	51.58	74	-22.42	V

Test mode:		GFSK		Test Frequency:		2440MHz		
Frequency (MHz)	Antenna Factor (dB/m)	Preamp Gain (dB)	Cable Loss (dB)	Read Level (dBμV)	PK Level (dBμV/m)	Limit Line (dBμV/m)	Over Limit (dB)	Antenna Polaxis
1577.198	31.01	37.85	2.90	45.41	41.47	74	-32.53	H
1800.416	31.40	37.54	3.08	44.84	41.78	74	-32.22	H
3266.346	33.36	37.04	5.57	46.23	48.12	74	-25.88	H
4880.000	34.85	36.81	5.08	41.80	44.92	74	-29.08	H
7320.000	36.43	37.43	6.77	43.17	48.94	74	-25.06	H
9760.000	38.05	37.85	7.60	43.50	51.30	74	-22.70	H
1668.044	31.18	37.72	2.98	45.48	41.92	74	-32.08	V
1988.327	31.68	37.31	3.22	44.42	42.01	74	-31.99	V
3757.208	32.97	36.94	5.48	44.95	46.46	74	-27.54	V
4880.000	34.85	36.81	5.08	42.87	45.99	74	-28.01	V
7320.000	36.43	37.43	6.77	43.09	48.86	74	-25.14	V
9760.000	38.05	37.85	7.60	44.15	51.95	74	-22.05	V

Test mode:		GFSK		Test Frequency:		2480MHz		
Frequency (MHz)	Antenna Factor (dB/m)	Preamp Gain (dB)	Cable Loss (dB)	Read Level (dB μ V)	PK Level (dB μ V/m)	Limit Line (dB μ V/m)	Over Limit (dB)	Antenna Polaxis
1689.410	31.21	37.69	2.99	45.41	41.92	74	-32.08	H
1998.475	31.70	37.30	3.23	44.95	42.58	74	-31.42	H
3681.469	33.03	36.96	5.49	45.68	47.24	74	-26.76	H
4960.000	35.02	36.80	5.05	41.75	45.02	74	-28.98	H
7440.000	36.45	37.41	6.88	43.50	49.42	74	-24.58	H
9920.000	38.22	37.88	7.47	44.39	52.20	74	-21.80	H
1638.585	31.12	37.76	2.95	45.26	41.57	74	-32.43	V
1884.829	31.53	37.44	3.15	45.16	42.40	74	-31.60	V
3653.463	33.05	36.96	5.50	45.79	47.38	74	-26.62	V
4960.000	35.02	36.80	5.05	41.32	44.59	74	-29.41	V
7440.000	36.45	37.41	6.88	43.06	48.98	74	-25.02	V
9920.000	38.22	37.88	7.47	44.48	52.29	74	-21.71	V

Note:

1) The field strength is calculated by adding the Antenna Factor, Cable Factor & Preamplifier. The basic equation with a sample calculation is as follows:

Final Test Level = Receiver Reading - Correct Factor

Correct Factor = Preamplifier Factor - Antenna Factor - Cable Factor

2) Scan from 9kHz to 25GHz, the disturbance above 13GHz and below 30MHz was very low, and the above harmonics were the highest point could be found when testing, so only the above harmonics had been displayed. The amplitude of spurious emissions from the radiator which are attenuated more than 20dB below the limit need not be reported.

PHOTOGRAPHS OF TEST SETUP

Test mode No.: i8 Pro



Radiated spurious emission Test Setup-1(Below 1GHz)

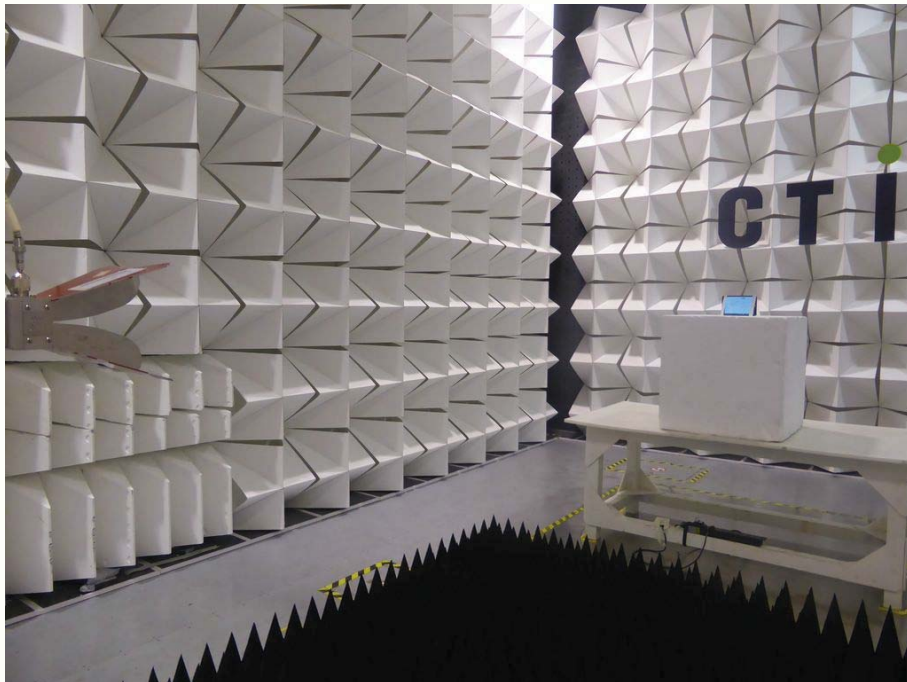

Radiated spurious emission Test Setup-2(Above 1GHz)



Conducted emission Test Setup

PHOTOGRAPHS OF EUT Constructional Details

Test mode No.: i8 Pro



View of product-1



View of product-2



View of product-3



View of product-4



View of product-5



View of product-6



View of product-7

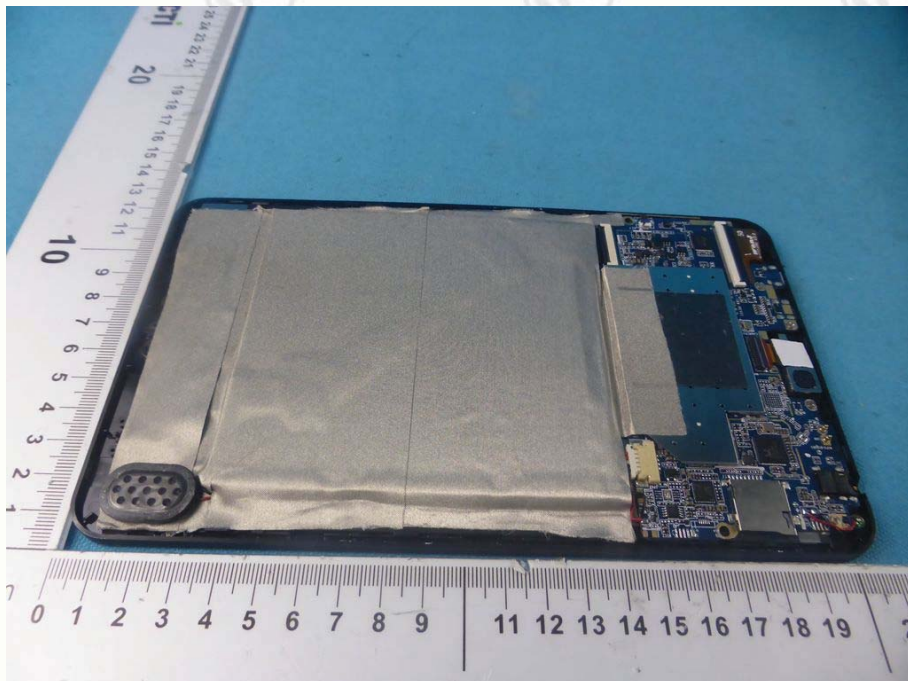

View of product-8



View of product-9

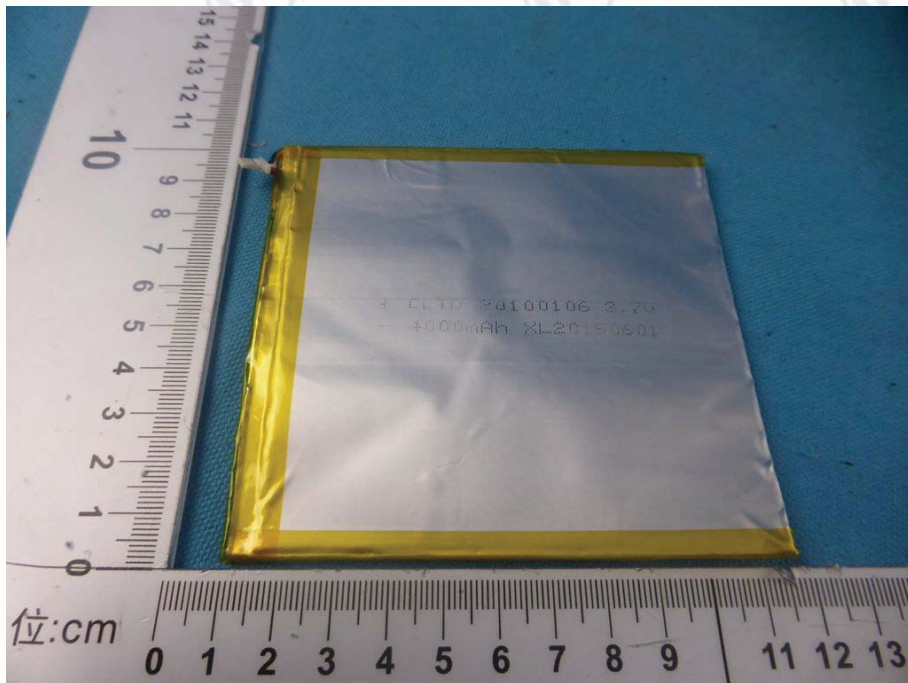

View of product-10

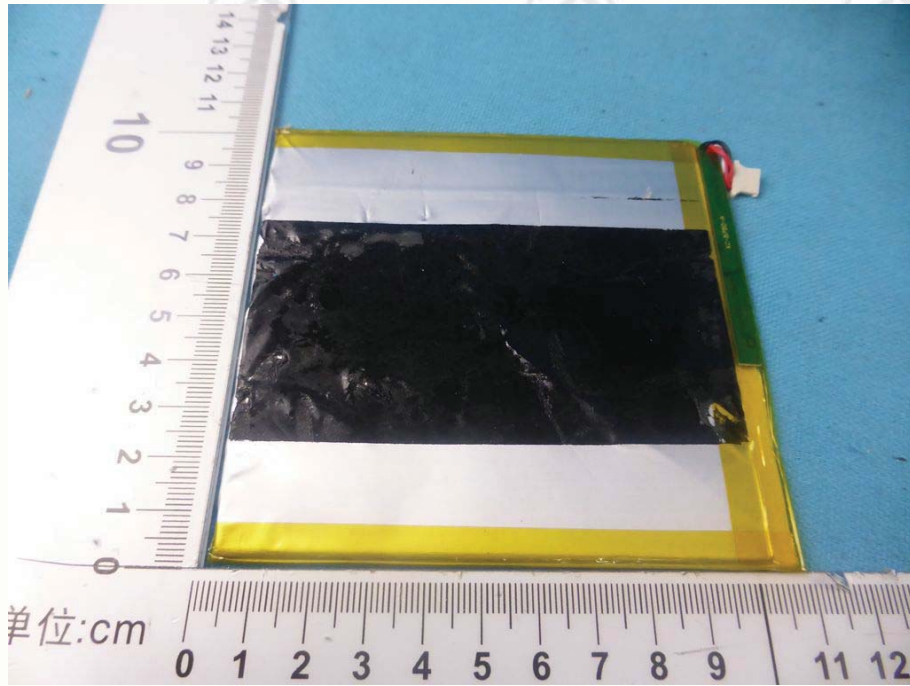

View of product-11

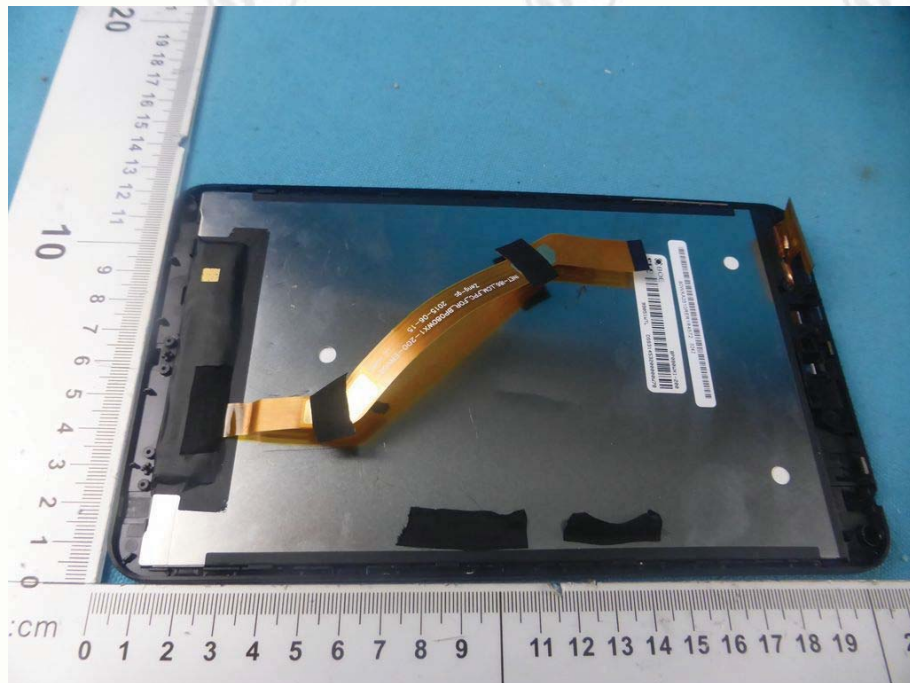

View of product-12



View of product-13



View of product-14

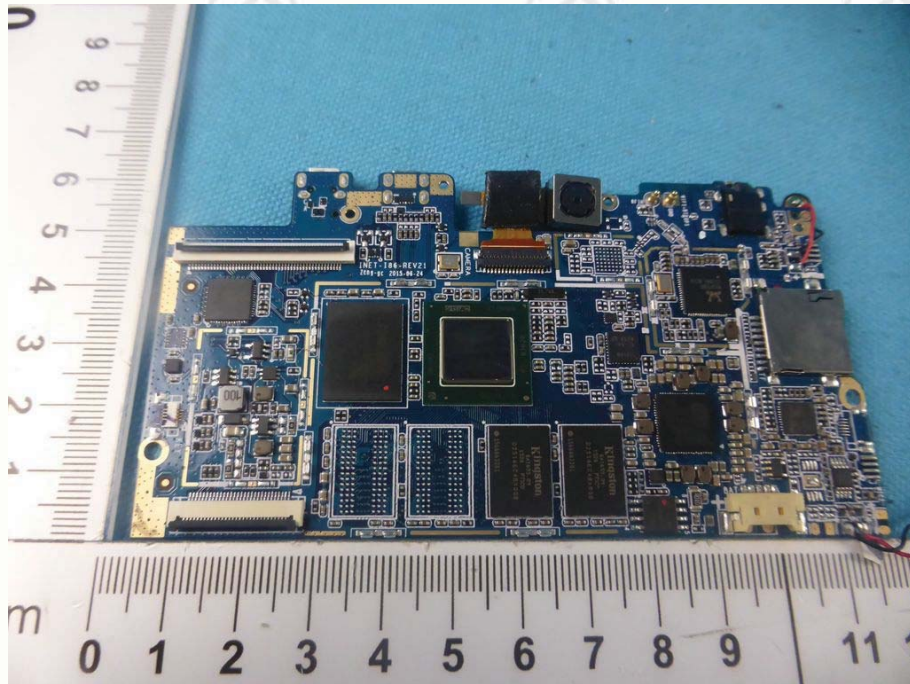

View of product-15



View of product-16



View of product-17



View of product-18

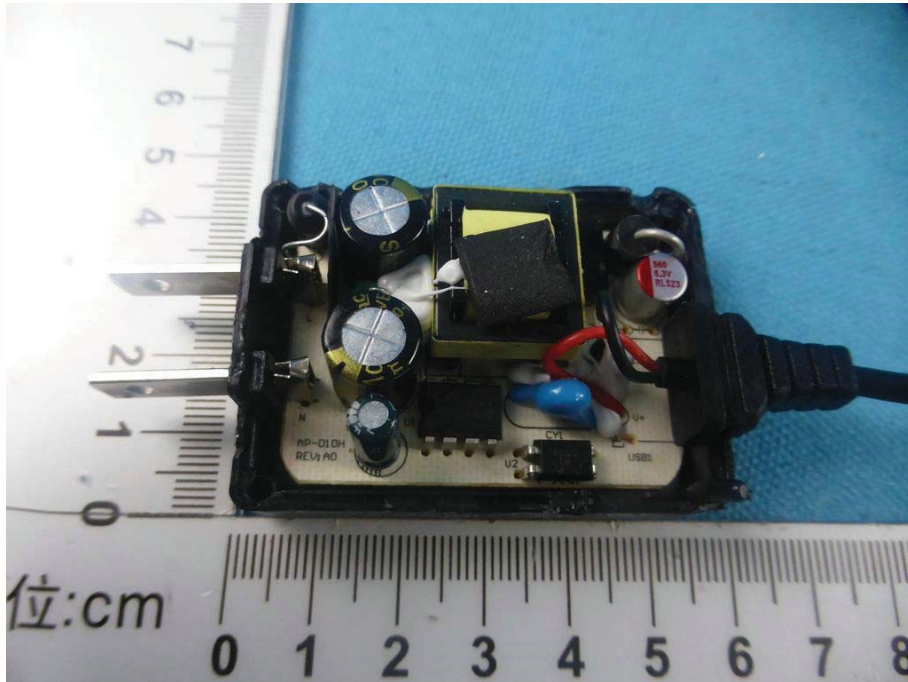

View of product-19

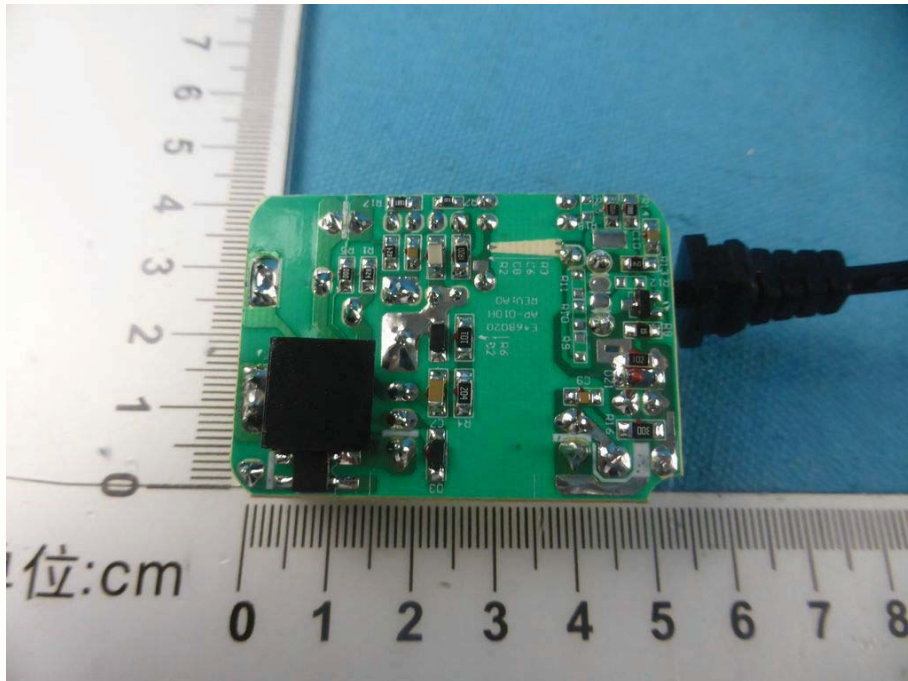

View of product-20

*** End of Report ***

The test report is effective only with both signature and specialized stamp, The result(s) shown in this report refer only to the sample(s) tested. Without written approval of CTI, this report can't be reproduced except in full.