

FCC SAR Test Report

APPLICANT : Mosby LLC
EQUIPMENT : Tablet PC
MODEL NAME : GX034QT
FCC ID : S5R-3490
STANDARD : FCC 47 CFR Part 2 (2.1093)
ANSI/IEEE C95.1-1992
IEEE 1528-2003

The product was testing completed on Sep. 24, 2013. We, SPORTON INTERNATIONAL INC., would like to declare that the tested sample has been evaluated in accordance with the procedures and shown the compliance with the applicable technical standards.

The test results in this report apply exclusively to the tested model / sample. Without written approval of SPORTON INTERNATIONAL INC., the test report shall not be reproduced except in full.

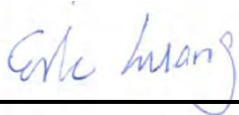

Reviewed by: Eric Huang / Deputy Manager



Approved by: Jones Tsai / Manager



SPORTON INTERNATIONAL INC.

No. 52, Hwa Ya 1st Rd., Hwa Ya Technology Park, Kwei-Shan Hsiang, Tao Yuan Hsien, Taiwan, R.O.C.

Table of Contents

1. Statement of Compliance	4
2. Administration Data	5
2.1 Testing Laboratory	5
2.2 Applicant	5
2.3 Application Details	5
3. General Information	6
3.1 Description of Equipment Under Test (EUT)	6
3.2 Maximum RF output power among production units	7
3.3 Applied Standard	10
3.4 Device Category and SAR Limits	10
3.5 Test Conditions	10
4. Sensor Trigger distance and power levels	11
5. Specific Absorption Rate (SAR)	16
5.1 Introduction	16
5.2 SAR Definition	16
6. SAR Measurement System	17
6.1 E-Field Probe	18
6.2 Data Acquisition Electronics (DAE)	19
6.4 Robot	20
6.5 Measurement Server	20
6.6 Phantom	21
6.7 Device Holder	22
6.8 Data Storage and Evaluation	23
6.9 Test Equipment List	25
7. Tissue Simulating Liquids	26
8. System Verification Procedures	28
8.1 Purpose of System Performance check	28
8.2 System Setup	28
8.3 SAR System Verification Results	29
9. EUT Testing Position	30
10. Measurement Procedures	30
10.1 Spatial Peak SAR Evaluation	30
10.2 Power Reference Measurement	31
10.3 Area & Zoom Scan Procedures	31
10.4 Volume Scan Procedures	32
10.5 SAR Averaged Methods	32
10.6 Power Drift Monitoring	32
11. Bluetooth Exclusions Applied	32
12. Conducted RF Output Power (Unit: dBm)	33
13. Exposure Position Conditions	52
14. SAR Test Results	53
14.1 Body SAR	54
14.2 Repeated SAR Measurement	60
15. Simultaneous Transmission Analysis	61
15.1 Body Exposure Conditions	62
15.2 SPLSR Evaluation and Analysis	66
16. Uncertainty Assessment	81
17. References	84
Appendix A. Plots of System Performance Check	
Appendix B. Plots of High SAR Measurement	
Appendix C. DASYS Calibration Certificate	

Revision History

REPORT NO.	VERSION	DESCRIPTION	ISSUED DATE
FA332727-06	Rev. 01	Initial issue of report	Oct. 01, 2013
FA332727-06	Rev. 02	<ol style="list-style-type: none"> 1. Revised GSM850 conducted power on page11 and page33. 2. Revised Bluetooth exclusions applied on page32. 3. Add WLAN (Ant1) + WLAN (Ant2) sum-SAR on page64 and add highest simultaneous transmission SAR on page4. 4. Add note3 in page53, prove the additional separation between EUT and the phantom surface introduced by the protrusion is <5mm. 	Oct. 17, 2013

1. Statement of Compliance

The maximum results of Specific Absorption Rate (SAR) found during testing for **Mosby LLC Tablet PC, GX034QT** are as follows.

<Highest SAR Summary>

Exposure Position	Frequency Band	Reported 1g-SAR (W/kg)	Equipment Class	Highest Reported 1g-SAR (W/kg)
Body	GSM850	1.19	PCB	1.19
	GSM1900	1.18		
	WCDMA Band V	1.17		
	WCDMA Band II	1.17		
	LTE Band 17	1.18		
	LTE Band 4	1.05		
	WLAN 2.4GHz Band	1.19	DTS	1.22
	WLAN 5.8GHz Band	1.22		
	WLAN 5.2GHz Band	1.28	NII	1.28
	WLAN 5.3GHz Band	1.14		
	WLAN 5.6GHz Band	1.19		

<Highest Simultaneous transmission SAR>

Exposure Position	Frequency Band	Equipment Class	Highest Reported Simultaneous Transmission 1g-SAR (W/kg)
Body	GSM1900	PCB	1.58
	Bluetooth	DSS	

Exposure Position	Frequency Band	Equipment Class	Highest Reported Simultaneous Transmission 1g-SAR (W/kg)
Body	WLAN5.8GHz (Ant1)	DTS	1.22
	WLAN5.8GHz (Ant2)	DTS	

Exposure Position	Frequency Band	Equipment Class	Highest Reported Simultaneous Transmission 1g-SAR (W/kg)
Body	WLAN5.3GHz (Ant1)	NII	1.34
	WLAN5.3GHz (Ant2)	NII	

This device is in compliance with Specific Absorption Rate (SAR) for general population/uncontrolled exposure limits (1.6 W/kg) specified in FCC 47 CFR part 2 (2.1093) and ANSI/IEEE C95.1-1992, and had been tested in accordance with the measurement methods and procedures specified in IEEE 1528-2003.

2. Administration Data

2.1 Testing Laboratory

Test Site	SPORTON INTERNATIONAL INC.
Test Site Location	No. 52, Hwa Ya 1 st Rd., Hwa Ya Technology Park, Kwei-Shan Hsiang, Tao Yuan Hsien, Taiwan, R.O.C. TEL: +886-3-327-3456 FAX: +886-3-328-4978

2.2 Applicant

Company Name	Mosby LLC
Address	2825 E. Cottonwood Parkway Suite 500 Salt Lake City, Utah 84121

2.3 Application Details

Date of Start during the Test	Jul. 25, 2013
Date of End during the Test	Sep. 24, 2013

3. General Information

3.1 Description of Equipment Under Test (EUT)

Product Feature & Specification	
EUT	Tablet PC
Model Name	GX034QT
FCC ID	S5R-3490
Wireless Technology and Frequency Range	GSM850: 824.2 MHz ~ 848.8 MHz GSM1900: 1850.2 MHz ~ 1909.8 MHz WCDMA Band V: 826.4 MHz ~ 846.6 MHz WCDMA Band II: 1852.4 MHz ~ 1907.6 MHz LTE Band 17: 706.5 MHz ~ 713.5 MHz LTE Band 4: 1710.7 MHz ~ 1754.3 MHz WLAN 2.4GHz Band: 2412 MHz ~ 2462 MHz WLAN 5.2GHz Band: 5180 MHz ~ 5240 MHz WLAN 5.3GHz Band: 5260 MHz ~ 5320 MHz WLAN 5.5GHz Band: 5500 MHz ~ 5580 MHz and 5660 MHz ~ 5700MHz WLAN 5.8GHz Band: 5745 MHz ~ 5825 MHz Bluetooth: 2402 MHz ~ 2480 MHz
Mode	<ul style="list-style-type: none"> • GPRS/EGPRS • WCDMA • HSDPA • HSUPA • LTE: QPSK, 16QAM • 802.11a/b/g/n HT20/HT40 • Bluetooth v3.0
Antenna Type	WWAN / LTE: Fixed Internal Antenna WLAN: Fixed Internal Antenna Bluetooth: Fixed Internal Antenna
Remark:	<ol style="list-style-type: none"> 1. The above EUT's information was declared by manufacturer. Please refer to the specifications or user's manual for more detailed description. 2. 802.11n-HT40 is not supported in WLAN2.4GHz. 3. WLAN5GHz operation in 5600 MHz ~ 5650 MHz is notched.

3.2 Maximum RF output power among production units

Band	Burst average power (dBm)	
	GSM 850	
Output Power Status	Full Power Mode	Reduced Power Mode
GPRS (GMSK, 1 Tx slot)	33.5	25.0
GPRS (GMSK, 2 Tx slots)	32.0	23.0
EDGE (8PSK, 1 Tx slot)	27.5	19.5
EDGE (8PSK, 2 Tx slots)	27.5	19.5

Band	Burst average power (dBm)	
	GSM 1900	
Output Power Status	Full Power Mode	Reduced Power Mode
GPRS (GMSK, 1 Tx slot)	30.5	26.5
GPRS (GMSK, 2 Tx slots)	29.0	25.0
EDGE (8PSK, 1 Tx slot)	26.5	22.5
EDGE (8PSK, 2 Tx slots)	26.5	22.5

Band	average power (dBm)	
	WCDMA V	
Output Power Status	Full Power Mode	Reduced Power Mode
RMC 12.2Kbps	23.5	18.0
HSDPA Subset 1	22.5	18.0
HSUPA Subset 5	22.5	18.0

Band	average power (dBm)	
	WCDMA II	
Output Power Status	Full Power Mode	Reduced Power Mode
RMC 12.2Kbps	23.5	18.5
HSDPA Subset 1	22.5	18.5
HSUPA Subset 5	22.5	18.5

Band / Mode	Average power(dBm)		
	1Mbps (GFSK)	2Mbps ($\pi/4$ -DQPSK)	3Mbps (8-DPSK)
2.4 GHz Bluetooth	5.5	5.5	5.5

Band / Mode	IEEE 802.11 average power(dBm)		
	Antenna 1	Antenna 2	Antenna 1+2
WLNA2.4GHz Band	16.0	16.0	19.0
WLNA5.2GHz Band	13.0	11.0	15.1
WLNA5.3GHz Band	13.0	8.5	14.3
WLNA5.5GHz Band	13.0	10.0	14.8
WLNA5.8GHz Band	13.0	13.0	16.0

LTE Band 17						
average power(dBm)						
Modulation	BW (MHz)	RB size	Full Power Mode (MPR)	Full power mode	Reduced power mode (MPR)	Reduced power mode
QPSK	10	≤ 12	0	23.5	0	18.5
QPSK	10	> 12	1	22.5	0	18.5
16QAM	10	≤ 12	1	22.5	0	18.5
16QAM	10	> 12	2	21.5	0	18.5
QPSK	5	≤ 8	0	23.5	0	18.5
QPSK	5	> 8	1	22.5	0	18.5
16QAM	5	≤ 8	1	22.5	0	18.5
16QAM	5	> 8	2	21.5	0	18.5

LTE Band 4						
average power(dBm)						
Modulation	BW (MHz)	RB size	Full Power Mode (MPR)	Full power mode	Reduced power mode (MPR)	Reduced power mode
QPSK	20	≤ 18	0	24.5	0	18.5
QPSK	20	> 18	1	23.5	0	18.5
16QAM	20	≤ 18	1	23.5	0	18.5
16QAM	20	> 18	2	22.5	0	18.5
QPSK	15	≤ 16	0	24.5	0	18.5
QPSK	15	> 16	1	23.5	0	18.5
16QAM	15	≤ 16	1	23.5	0	18.5
16QAM	15	> 16	2	22.5	0	18.5
QPSK	10	≤ 12	0	24.5	0	18.5
QPSK	10	> 12	1	23.5	0	18.5
16QAM	10	≤ 12	1	23.5	0	18.5
16QAM	10	> 12	2	22.5	0	18.5
QPSK	5	≤ 8	0	24.5	0	18.5
QPSK	5	> 8	1	23.5	0	18.5
16QAM	5	≤ 8	1	23.5	0	18.5
16QAM	5	> 8	2	22.5	0	18.5
QPSK	3	≤ 4	0	24.5	0	18.5
QPSK	3	> 4	1	23.5	0	18.5
16QAM	3	≤ 4	1	23.5	0	18.5
16QAM	3	> 4	2	22.5	0	18.5
QPSK	1.4	≤ 5	0	24.5	0	18.5
QPSK	1.4	> 5	1	23.5	0	18.5
16QAM	1.4	≤ 5	1	23.5	0	18.5
16QAM	1.4	> 5	2	22.5	0	18.5

Remark:

1. By design, maximum LTE RF power of smaller supported bandwidth does not exceed the RF power of largest supported bandwidth; the information is included in “tune-up procedure” exhibit

The table below summarized necessary items addressed in KDB 941225 D05 v02.

FCC ID	S5R-3490																																																	
EUT	Tablet PC																																																	
Operating Frequency Range of each LTE transmission band	LTE Band 17: 706.5 MHz ~ 713.5 MHz LTE Band 4: 1710.7 MHz ~ 1754.3 MHz																																																	
Channel Bandwidth	LTE Band 17: 5MHz, 10MHz LTE Band 4: 1.4MHz, 3MHz, 5MHz, 10MHz, 15MHz, 20MHz																																																	
Transmission (H, M, L) channel numbers and frequencies in each LTE band																																																		
Band 17																																																		
	Bandwidth 5 MHz						Bandwidth 10 MHz																																											
	Channel #			Frequency (MHz)			Channel #			Frequency (MHz)																																								
L	23755			706.5			23780			709																																								
M	23790			710			23790			710																																								
H	23825			713.5			23800			711																																								
LTE Band 4																																																		
	Bandwidth 1.4 MHz		Bandwidth 3 MHz		Bandwidth 5 MHz		Bandwidth 10 MHz		Bandwidth 15 MHz		Bandwidth 20 MHz																																							
	Ch. #	Freq. (MHz)	Ch. #	Freq. (MHz)	Ch. #	Freq. (MHz)	Ch. #	Freq. (MHz)	Ch. #	Freq. (MHz)	Ch. #	Freq. (MHz)																																						
L	19957	1710.7	19965	1711.5	19975	1712.5	20000	1715	20025	1717.5	20050	1720																																						
M	20175	1732.5	20175	1732.5	20175	1732.5	20175	1732.5	20175	1732.5	20175	1732.5																																						
H	20393	1754.3	20385	1753.5	20375	1752.5	20350	1750	20325	1747.5	20300	1745																																						
E category, uplink modulations used	Category 3, QPSK, and 16QAM																																																	
LTE transmitter and antenna implementation (standalone or sharing hardware components / antennas)	A primary antenna is used for LTE and other wireless interfaces (GSM/WCDMA) for transmitting and receiving. LTE and other wireless interfaces (GSM / WCDMA) share the same antenna, and cannot transmit simultaneously A 2 nd antenna is used for LTE and other wireless interfaces (GSM/WCDMA) for receiving only																																																	
LTE Voice / Data requirements	1. Data only																																																	
LTE MPR permanently built-in by design	Yes, per 3GPP TS 36.101 v11.0.0 Table 6.2.3-1: Maximum Power Reduction (MPR) for Power Class 3																																																	
	<table border="1" style="width: 100%; border-collapse: collapse;"> <thead> <tr> <th rowspan="2">Modulation</th> <th colspan="6">Channel bandwidth / Transmission bandwidth (RB)</th> <th rowspan="2">MPR (dB)</th> </tr> <tr> <th>1.4 MHz</th> <th>3.0 MHz</th> <th>5 MHz</th> <th>10 MHz</th> <th>15 MHz</th> <th>20 MHz</th> </tr> </thead> <tbody> <tr> <td>QPSK</td> <td>> 5</td> <td>> 4</td> <td>> 8</td> <td>> 12</td> <td>> 16</td> <td>> 18</td> <td>≤ 1</td> </tr> <tr> <td>16 QAM</td> <td>≤ 5</td> <td>≤ 4</td> <td>≤ 8</td> <td>≤ 12</td> <td>≤ 16</td> <td>≤ 18</td> <td>≤ 1</td> </tr> <tr> <td>16 QAM</td> <td>> 5</td> <td>> 4</td> <td>> 8</td> <td>> 12</td> <td>> 16</td> <td>> 18</td> <td>≤ 2</td> </tr> </tbody> </table>												Modulation	Channel bandwidth / Transmission bandwidth (RB)						MPR (dB)	1.4 MHz	3.0 MHz	5 MHz	10 MHz	15 MHz	20 MHz	QPSK	> 5	> 4	> 8	> 12	> 16	> 18	≤ 1	16 QAM	≤ 5	≤ 4	≤ 8	≤ 12	≤ 16	≤ 18	≤ 1	16 QAM	> 5	> 4	> 8	> 12	> 16	> 18	≤ 2
Modulation	Channel bandwidth / Transmission bandwidth (RB)						MPR (dB)																																											
	1.4 MHz	3.0 MHz	5 MHz	10 MHz	15 MHz	20 MHz																																												
QPSK	> 5	> 4	> 8	> 12	> 16	> 18	≤ 1																																											
16 QAM	≤ 5	≤ 4	≤ 8	≤ 12	≤ 16	≤ 18	≤ 1																																											
16 QAM	> 5	> 4	> 8	> 12	> 16	> 18	≤ 2																																											
LTE A-MPR	In the base station simulator configuration, Network Setting value is set to NS_01 to disable A-MPR during SAR testing.																																																	
Base station simulator used for Testing	Anritsu MT8820C																																																	
Power reduction applied to satisfy SAR compliance	Yes, proximity sensor.																																																	

3.3 Applied Standard

The Specific Absorption Rate (SAR) testing specification, method, and procedure for this device is in accordance with the following standards:

- FCC 47 CFR Part 2 (2.1093)
- ANSI/IEEE C95.1-1992
- IEEE 1528-2003
- FCC KDB 865664 D01 v01r01
- FCC KDB 447498 D01 v05r01
- FCC KDB 248227 D01 v01r02
- FCC KDB 616217 D04 v01r01
- FCC KDB 941225 D01 v02
- FCC KDB 941225 D02 v02r02
- FCC KDB 941225 D03 v01
- FCC KDB 941225 D05 v02r02

3.4 Device Category and SAR Limits

This device belongs to portable device category because its radiating structure is allowed to be used within 20 centimeters of the body of the user. Limit for General Population/Uncontrolled exposure should be applied for this device, it is 1.6 W/kg as averaged over any 1 gram of tissue.

3.5 Test Conditions

3.5.1 Ambient Condition

Ambient Temperature	20 to 24 °C
Humidity	< 60 %

3.5.2 Test Configuration

1. For WWAN SAR testing, the device was controlled by using a base station emulator. Communication between the device and the emulator was established by air link. The distance between the EUT and the antenna of the emulator is larger than 50 cm and the output power radiated from the emulator antenna is at least 30 dB smaller than the output power of EUT.
2. For WLAN SAR testing, WLAN engineering testing software installed on the EUT can provide continuous transmitting RF signal.
3. Full power mode SAR testing was performed at the distance smaller than the trigger distance; the test separation distance was used 13mm at Bottom Slant of Edge2, 11mm at Edge2. The detail proximity sensor trigger distance testing is reference operation description.

4. Sensor Trigger distance and power levels

Target Power reduction applied for each wireless mode and orientation

Exposure Position / wireless mode	Bottom Face ⁽¹⁾	Bottom Slant of Edge 2 ⁽¹⁾	Edge 1	Edge 2 ⁽¹⁾	Edge 3	Edge 4
GSM850 GPRS (GMSK 1 Tx slot)	8.5 dB	8.5 dB	0 dB	8.5 dB	0 dB	0 dB
GSM850 GPRS (GMSK 2 Tx slots)	9.0 dB	9.0 dB	0 dB	9.0 dB	0 dB	0 dB
GSM850 EDGE (8PSK 1 Tx slot)	8.0 dB	8.0 dB	0 dB	8.0 dB	0 dB	0 dB
GSM850 EDGE (8PSK 2 Tx slots)	8.0 dB	8.0 dB	0 dB	8.0 dB	0 dB	0 dB
GSM1900 GPRS (GMSK 1 Tx slot)	4.0 dB	4.0 dB	0 dB	4.0 dB	0 dB	0 dB
GSM1900 GPRS (GMSK 2 Tx slots)	4.0 dB	4.0 dB	0 dB	4.0 dB	0 dB	0 dB
GSM1900 EDGE (8PSK 1 Tx slot)	4.0 dB	4.0 dB	0 dB	4.0 dB	0 dB	0 dB
GSM1900 EDGE (8PSK 2 Tx slots)	4.0 dB	4.0 dB	0 dB	4.0 dB	0 dB	0 dB
WCDMA Band V	5.5 dB	5.5 dB	0 dB	5.5 dB	0 dB	0 dB
WCDMA Band II	5.0 dB	5.0 dB	0 dB	5.0 dB	0 dB	0 dB
LTE Band 17	5.0 dB	5.0 dB	0 dB	5.0 dB	0 dB	0 dB
LTE Band 4	6.0 dB	6.0 dB	0 dB	6.0 dB	0 dB	0 dB

General Note:

- ⁽¹⁾: Reduced maximum limit applied by activation of proximity sensor.
- Power reduction is not applicable for WLAN and Bluetooth.

Measurement on EUT:

Band/Mode	Ch	Measured power reduction (dBm)		Reduction Levels (dB)
		w/o power back-off	w/ power back-off	
GSM850 GPRS (GMSK 1 Tx slot)	251	32.5	25.0	7.5
GSM850 GPRS (GMSK 2 Tx slots)	251	31.9	22.9	9.0
GSM850 EDGE (8PSK 1 Tx slot)	251	26.8	19.3	7.5
GSM850 EDGE (8PSK 2 Tx slots)	251	26.7	19.2	7.5
GSM1900 GPRS (GMSK 1 Tx slot)	661	29.7	24.9	4.8
GSM1900 GPRS (GMSK 2 Tx slots)	661	28.9	24.8	4.1
GSM1900 EDGE (8PSK 1 Tx slot)	661	25.8	20.8	5.0
GSM1900 EDGE (8PSK 2 Tx slots)	661	25.8	20.8	5.0
WCDMA Band V	4233	22.8	17.9	4.9
WCDMA Band II	9400	23.1	18.3	4.8
LTE Band 17	23790	23.2	18.4	4.8
LTE Band 4	20175	24.4	17.7	6.7

Proximity Sensor for Bottom Slant of Edge 2

GSM850
Distance from the EUT (mm)

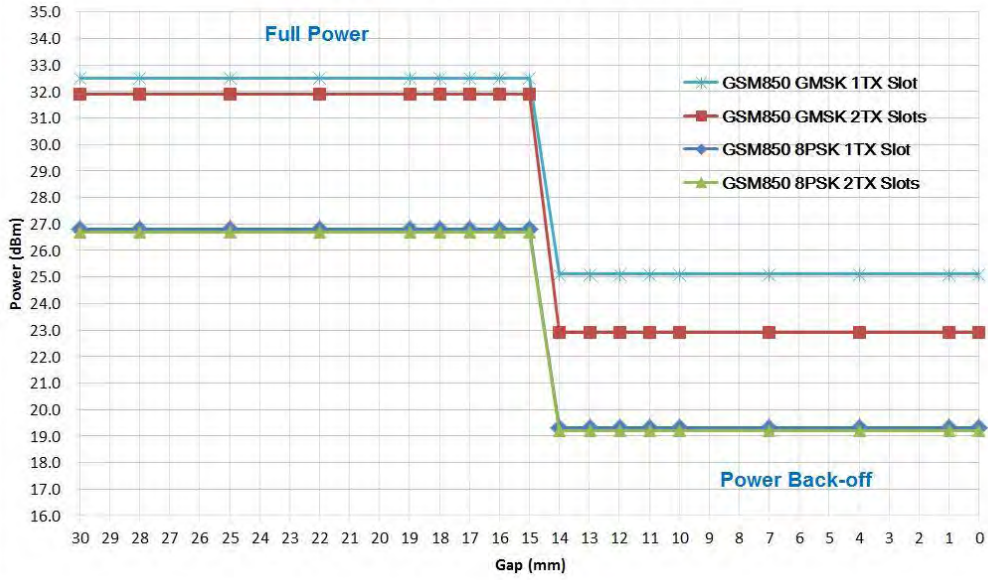

GSM1900
Distance from the EUT (mm)

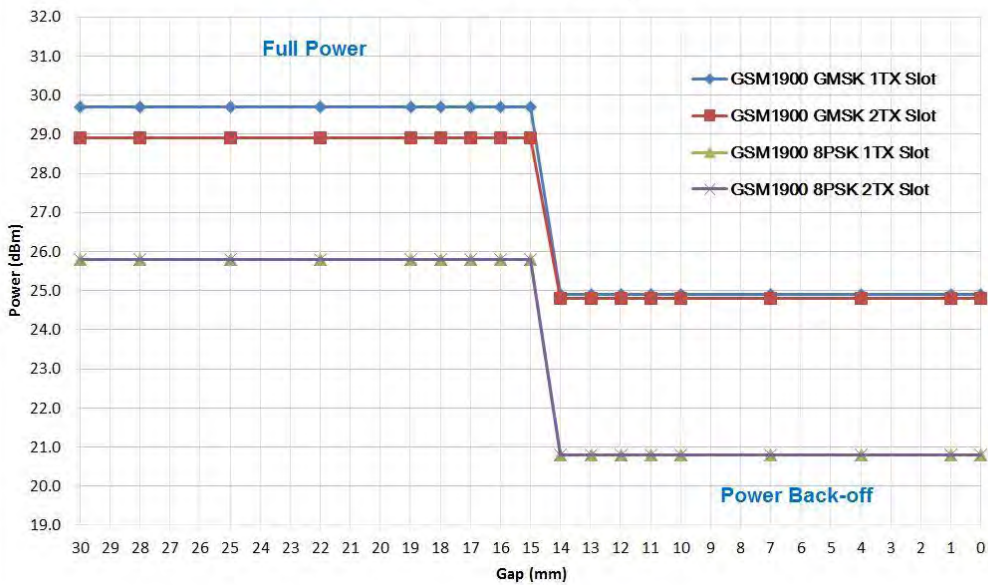

WCDAM and LTE Distance from the EUT (mm)



Proximity Sensor for Edge 2

GSM850
Distance from the EUT (mm)

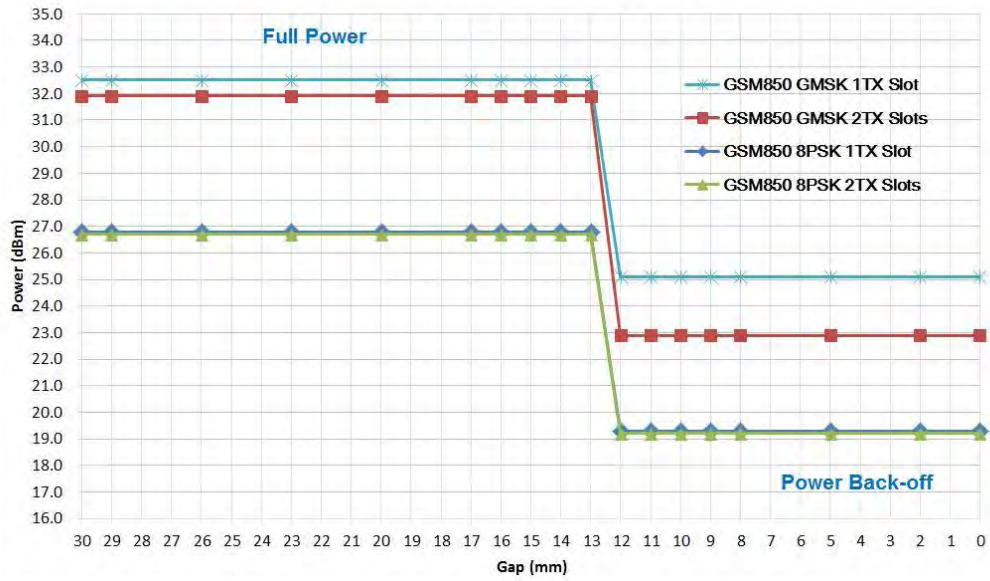

GSM1900
Distance from the EUT (mm)

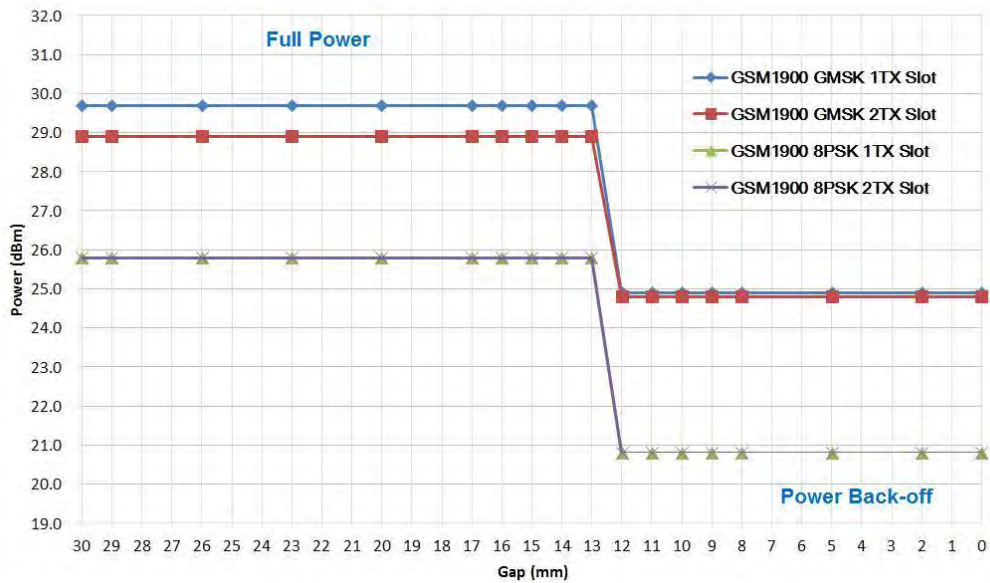

WCDAM and LTE Distance from the EUT (mm)



5. Specific Absorption Rate (SAR)

5.1 Introduction

SAR is related to the rate at which energy is absorbed per unit mass in an object exposed to a radio field. The SAR distribution in a biological body is complicated and is usually carried out by experimental techniques or numerical modeling. The standard recommends limits for two tiers of groups, occupational/controlled and general population/uncontrolled, based on a person's awareness and ability to exercise control over his or her exposure. In general, occupational/controlled exposure limits are higher than the limits for general population/uncontrolled.

5.2 SAR Definition

The SAR definition is the time derivative (rate) of the incremental energy (dW) absorbed by (dissipated in) an incremental mass (dm) contained in a volume element (dv) of a given density (ρ). The equation description is as below:

$$\mathbf{SAR} = \frac{d}{dt} \left(\frac{dW}{dm} \right) = \frac{d}{dt} \left(\frac{dW}{\rho dv} \right)$$

SAR is expressed in units of Watts per kilogram (W/kg)

SAR measurement can be either related to the temperature elevation in tissue by

$$\mathbf{SAR} = C \left(\frac{\delta T}{\delta t} \right)$$

Where: C is the specific heat capacity, δT is the temperature rise and δt is the exposure duration, or related to the electrical field in the tissue by

$$\mathbf{SAR} = \frac{\sigma |E|^2}{\rho}$$

Where: σ is the conductivity of the tissue, ρ is the mass density of the tissue and E is the RMS electrical field strength.

However for evaluating SAR of low power transmitter, electrical field measurement is typically applied.

6. SAR Measurement System

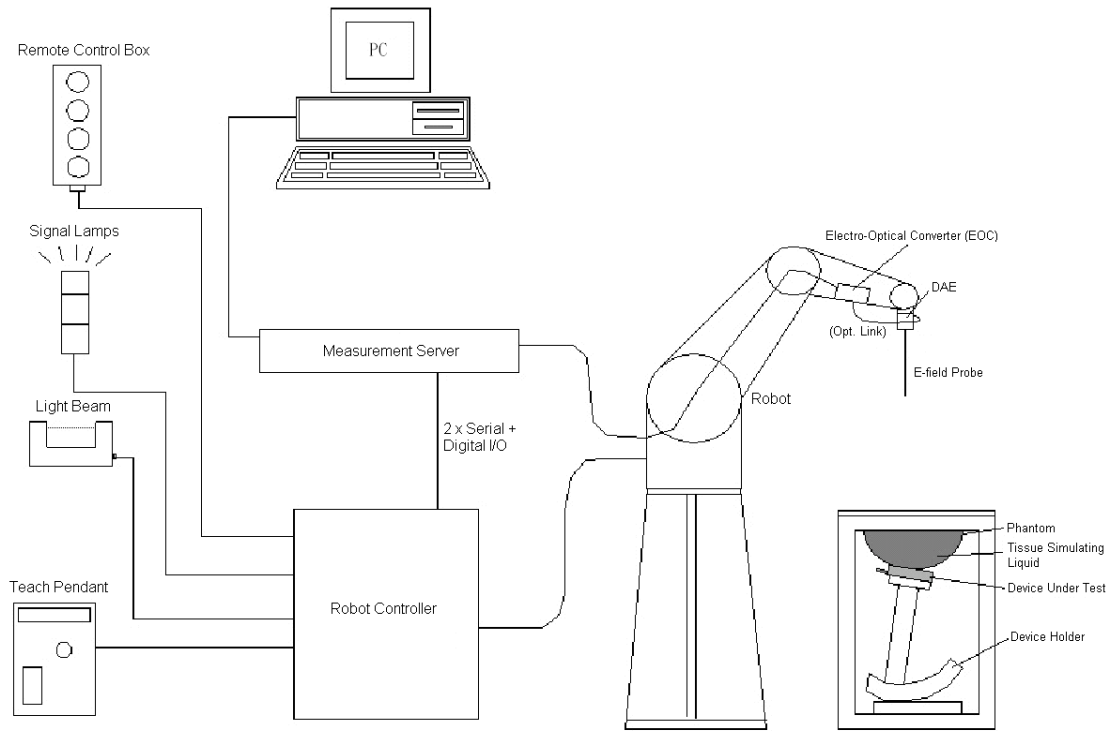

Fig 5.1 SPEAG DASY System Configurations

The DASY system for performance compliance tests is illustrated above graphically. This system consists of the following items:

- A standard high precision 6-axis robot with controller, a teach pendant and software
- A data acquisition electronic (DAE) attached to the robot arm extension
- A dosimetric probe equipped with an optical surface detector system
- The electro-optical converter (EOC) performs the conversion between optical and electrical signals
- A measurement server performs the time critical tasks such as signal filtering, control of the robot operation and fast movement interrupts.
- A probe alignment unit which improves the accuracy of the probe positioning
- A computer operating Windows XP
- DASY software
- Remove control with teach pendant and additional circuitry for robot safety such as warning lamps, etc.
- The SAM twin phantom
- A device holder
- Tissue simulating liquid
- Dipole for evaluating the proper functioning of the system

Component details are described in in the following sub-sections.

6.1 E-Field Probe

The SAR measurement is conducted with the dosimetric probe (manufactured by SPEAG). The probe is specially designed and calibrated for use in liquid with high permittivity. The dosimetric probe has special calibration in liquid at different frequency. This probe has a built in optical surface detection system to prevent from collision with phantom.

5.1.1 E-Field Probe Specification

<ET3DV6 Probe >

Construction	Symmetrical design with triangular core Built-in optical fiber for surface detection system. Built-in shielding against static charges. PEEK enclosure material (resistant to organic solvents, e.g., DGBE)
Frequency	10 MHz to 3 GHz; Linearity: ± 0.2 dB
Directivity	± 0.2 dB in HSL (rotation around probe axis) ± 0.4 dB in HSL (rotation normal to probe axis)
Dynamic Range	5 μ W/g to 100 mW/g; Linearity: ± 0.2 dB
Dimensions	Overall length: 330 mm (Tip: 16 mm) Tip diameter: 6.8 mm (Body: 12 mm) Distance from probe tip to dipole centers: 2.7 mm



Fig 5.2 Photo of ET3DV6

<ES3DV3 Probe >

Construction	Symmetrical design with triangular core Built-in optical fiber for surface detection system. Built-in shielding against static charges. PEEK enclosure material (resistant to organic solvents, e.g., DGBE)
Frequency	10 MHz to 3 GHz; Linearity: ± 0.2 dB
Directivity	± 0.2 dB in HSL (rotation around probe axis) ± 0.4 dB in HSL (rotation normal to probe axis)
Dynamic Range	5 μ W/g to 100 mW/g; Linearity: ± 0.2 dB
Dimensions	Overall length: 337 mm (Tip: 10 mm) Tip diameter: 4 mm (Body: 10 mm) Distance from probe tip to dipole centers: 3 mm



Fig 5.3 Photo of ES3DV3

<EX3DV4 Probe>

Construction	Symmetrical design with triangular core Built-in shielding against static charges PEEK enclosure material (resistant to organic solvents, e.g., DGBE)
Frequency	10 MHz to 6 GHz; Linearity: ± 0.2 dB
Directivity	± 0.3 dB in HSL (rotation around probe axis) ± 0.5 dB in tissue material (rotation normal to probe axis)
Dynamic Range	10 μ W/g to 100 mW/g; Linearity: ± 0.2 dB (noise: typically < 1 μ W/g)
Dimensions	Overall length: 330 mm (Tip: 20 mm) Tip diameter: 2.5 mm (Body: 12 mm) Typical distance from probe tip to dipole centers: 1 mm

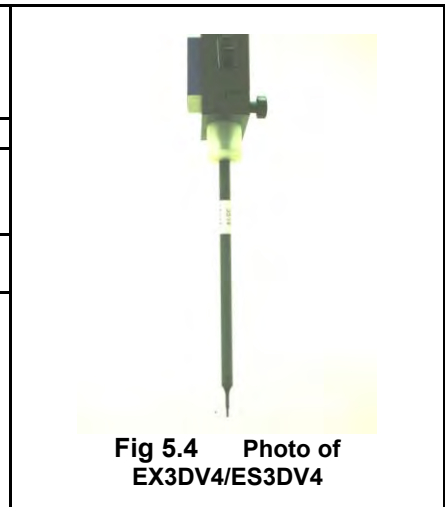

Fig 5.4 Photo of EX3DV4/ES3DV4

5.1.2 E-Field Probe Calibration

Each probe needs to be calibrated according to a dosimetric assessment procedure with accuracy better than $\pm 10\%$. The spherical isotropy shall be evaluated and within ± 0.25 dB. The sensitivity parameters (NormX, NormY, and NormZ), the diode compression parameter (DCP) and the conversion factor (ConvF) of the probe are tested. The calibration data can be referred to appendix C of this report.

6.2 Data Acquisition Electronics (DAE)

The data acquisition electronics (DAE) consists of a highly sensitive electrometer-grade preamplifier with auto-zeroing, a channel and gain-switching multiplexer, a fast 16 bit AD-converter and a command decoder and control logic unit. Transmission to the measurement server is accomplished through an optical downlink for data and status information as well as an optical uplink for commands and the clock. The input impedance of the DAE is 200 MOhm; the inputs are symmetrical and floating. Common mode rejection is above 80 dB.



Fig 5.5 Photo of DAE

6.4 Robot

The SPEAG DASY system uses the high precision robots (DASY4: RX90BL; DASY5: TX90XL) type from Stäubli SA (France). For the 6-axis controller system, the robot controller version (DASY4: CS7MB; DASY5: CS8c) from Stäubli is used. The Stäubli robot series have many features that are important for our application:

- High precision (repeatability ± 0.035 mm)
- High reliability (industrial design)
- Jerk-free straight movements
- Low ELF interference (the closed metallic construction shields against motor control fields)



Fig 5.6 Photo of DASY4



Fig 5.7 Photo of DASY5

6.5 Measurement Server

The measurement server is based on a PC/104 CPU board with CPU (DASY4: 166 MHz, Intel Pentium; DASY5: 400 MHz, Intel Celeron), chipdisk (DASY4: 32 MB; DASY5: 128 MB), RAM (DASY4: 64 MB, DASY5: 128 MB). The necessary circuits for communication with the DAE electronic box, as well as the 16 bit AD converter system for optical detection and digital I/O interface are contained on the DASY I/O board, which is directly connected to the PC/104 bus of the CPU board.

The measurement server performs all the real-time data evaluation for field measurements and surface detection, controls robot movements and handles safety operations.



Fig 5.8 Photo of Server for DASY4



Fig 5.9 Photo of Server for DASY5

6.6 Phantom

<SAM Twin Phantom>

Shell Thickness	2 ± 0.2 mm; Center ear point: 6 ± 0.2 mm	
Filling Volume	Approx. 25 liters	
Dimensions	Length: 1000 mm; Width: 500 mm; Height: adjustable feet	
Measurement Areas	Left Hand, Right Hand, Flat Phantom	

Fig 5.10 Photo of SAM Phantom

The bottom plate contains three pair of bolts for locking the device holder. The device holder positions are adjusted to the standard measurement positions in the three sections. A white cover is provided to tap the phantom during off-periods to prevent water evaporation and changes in the liquid parameters. On the phantom top, three reference markers are provided to identify the phantom position with respect to the robot.

<ELI4 Phantom>

Shell Thickness	2 ± 0.2 mm (sagging: <1%)	
Filling Volume	Approx. 30 liters	
Dimensions	Major ellipse axis: 600 mm Minor axis: 400 mm	

Fig 5.11 Photo of ELI4 Phantom

The ELI4 phantom is intended for compliance testing of handheld and body-mounted wireless devices in the frequency range of 30 MHz to 6 GHz. ELI4 is fully compatible with standard and all known tissue simulating liquids.

6.7 Device Holder

<Device Holder for SAM Twin Phantom>

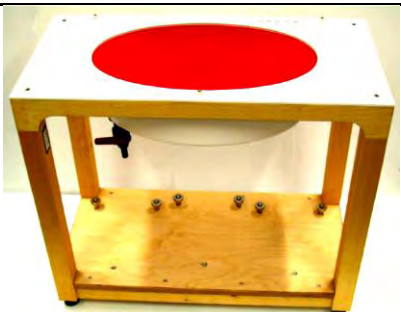
The SAR in the phantom is approximately inversely proportional to the square of the distance between the source and the liquid surface. For a source at 5 mm distance, a positioning uncertainty of ± 0.5 mm would produce a SAR uncertainty of ± 20 %. Accurate device positioning is therefore crucial for accurate and repeatable measurements. The positions in which the devices must be measured are defined by the standards.

The DASY device holder is designed to cope with different positions given in the standard. It has two scales for the device rotation (with respect to the body axis) and the device inclination (with respect to the line between the ear reference points). The rotation center for both scales is the ear reference point (ERP). Thus the device needs no repositioning when changing the angles.

The DASY device holder is constructed of low-loss POM material having the following dielectric parameters: relative permittivity $\epsilon = 3$ and loss tangent $\delta = 0.02$. The amount of dielectric material has been reduced in the closest vicinity of the device, since measurements have suggested that the influence of the clamp on the test results could thus be lowered.



Fig 5.12 Device Holder

<Laptop Extension Kit>

The extension is lightweight and made of POM, acrylic glass and foam. It fits easily on the upper part of the mounting device in place of the phone positioned. The extension is fully compatible with the SAM Twin and ELI phantoms.

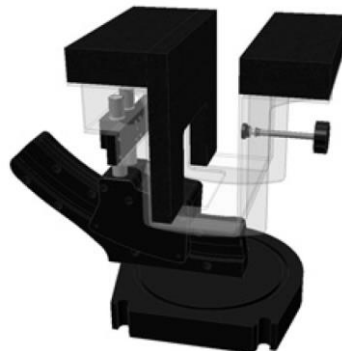

Fig 5.13 Laptop Extension Kit

6.8 Data Storage and Evaluation

5.7.1 Data Storage

The DASY software stores the assessed data from the data acquisition electronics as raw data (in microvolt readings from the probe sensors), together with all the necessary software parameters for the data evaluation (probe calibration data, liquid parameters and device frequency and modulation data) in measurement files. The post-processing software evaluates the desired unit and format for output each time the data is visualized or exported. This allows verification of the complete software setup even after the measurement and allows correction of erroneous parameter settings. For example, if a measurement has been performed with an incorrect crest factor parameter in the device setup, the parameter can be corrected afterwards and the data can be reevaluated.

The measured data can be visualized or exported in different units or formats, depending on the selected probe type (e.g., [V/m], [A/m], [mW/g]). Some of these units are not available in certain situations or give meaningless results, e.g., a SAR-output in a non-lose media, will always be zero. Raw data can also be exported to perform the evaluation with other software packages.

5.7.2 Data Evaluation

The DASY post-processing software (SEMCAD) automatically executes the following procedures to calculate the field units from the microvolt readings at the probe connector. The parameters used in the evaluation are stored in the configuration modules of the software :

Probe parameters :	- Sensitivity	Norm _i , a _{i0} , a _{i1} , a _{i2}
	- Conversion factor	ConvF _i
	- Diode compression point	dcpi
Device parameters :	- Frequency	f
	- Crest factor	cf
Media parameters :	- Conductivity	σ
	- Density	ρ

These parameters must be set correctly in the software. They can be found in the component documents or they can be imported into the software from the configuration files issued for the DASY components. In the direct measuring mode of the multi-meter option, the parameters of the actual system setup are used. In the scan visualization and export modes, the parameters stored in the corresponding document files are used.

The first step of the evaluation is a linearization of the filtered input signal to account for the compression characteristics of the detector diode. The compensation depends on the input signal, the diode type and the DC-transmission factor from the diode to the evaluation electronics. If the exciting field is pulsed, the crest factor of the signal must be known to correctly compensate for peak power.

The formula for each channel can be given as :

$$V_i = U_i + U_i^2 \cdot \frac{cf}{dcp_i}$$

with V_i = compensated signal of channel i, (i = x, y, z)
 U_i = input signal of channel i, (i = x, y, z)
 cf = crest factor of exciting field (DASY parameter)
 dcp_i = diode compression point (DASY parameter)

From the compensated input signals, the primary field data for each channel can be evaluated :

$$\text{E-field Probes : } E_i = \sqrt{\frac{V_i}{\text{Norm}_i \cdot \text{ConvF}}}$$

$$\text{H-field Probes : } H_i = \sqrt{V_i \cdot \frac{a_{i0} + a_{i1}f + a_{i2}f^2}{f}}$$

with V_i = compensated signal of channel i, (i = x, y, z)
 Norm_i = sensor sensitivity of channel i, (i = x, y, z), $\mu\text{V}/(\text{V/m})^2$ for E-field Probes
 ConvF = sensitivity enhancement in solution
 a_{ij} = sensor sensitivity factors for H-field probes
 f = carrier frequency [GHz]
 E_i = electric field strength of channel i in V/m
 H_i = magnetic field strength of channel i in A/m

The RSS value of the field components gives the total field strength (Hermitian magnitude) :

$$E_{\text{tot}} = \sqrt{E_x^2 + E_y^2 + E_z^2}$$

The primary field data are used to calculate the derived field units.

$$\text{SAR} = E_{\text{tot}}^2 \cdot \frac{\sigma}{\rho \cdot 1000}$$

with SAR = local specific absorption rate in mW/g
 E_{tot} = total field strength in V/m
 σ = conductivity in [mho/m] or [Siemens/m]
 ρ = equivalent tissue density in g/cm^3

Note that the density is set to 1, to account for actual head tissue density rather than the density of the tissue simulating liquid.

6.9 Test Equipment List

Manufacturer	Name of Equipment	Type/Model	Serial Number	Calibration	
				Last Cal.	Due Date
SPEAG	750MHz System Validation Kit	D750V3	1012	May. 28, 2013	May. 27, 2014
SPEAG	835MHz System Validation Kit	D835V2	499	Mar. 18, 2013	Mar. 17, 2014
SPEAG	1750MHz System Validation Kit	D1750V2	1068	Jun. 20, 2012	Jun. 19, 2014
SPEAG	1900MHz System Validation Kit	D1900V2	5d041	Mar. 20, 2013	Mar. 19, 2014
SPEAG	2450MHz System Validation Kit	D2450V2	869	Jun. 11, 2013	Jun. 10, 2014
SPEAG	5GHz System Validation Kit	D5GHzV2	1006	Dec. 11, 2012	Dec. 10, 2013
SPEAG	Data Acquisition Electronics	DAE3	577	May. 08, 2013	May. 07, 2014
SPEAG	Data Acquisition Electronics	DAE4	778	Aug. 21, 2013	Aug. 20, 2014
SPEAG	Data Acquisition Electronics	DAE3	495	May. 08, 2013	May. 07, 2014
SPEAG	Data Acquisition Electronics	DAE4	1279	Jan. 28, 2013	Jan. 27, 2014
SPEAG	Data Acquisition Electronics	DAE4	1338	May. 28, 2013	May. 27, 2014
SPEAG	Dosimetric E-Field Probe	ET3DV6R	1788	Oct. 23, 2012	Oct. 22, 2013
SPEAG	Dosimetric E-Field Probe	EX3DV4	3697	Sep. 28, 2012	Sep. 27, 2013
SPEAG	Dosimetric E-Field Probe	EX3DV4	3792	Jun. 04, 2013	Jun. 03, 2014
SPEAG	Dosimetric E-Field Probe	EX3DV4	3925	Jun. 12, 2013	Jun. 11, 2014
SPEAG	Dosimetric E-Field Probe	EX3DV4	3801	Jun. 20, 2013	Jun. 19, 2014
SPEAG	Dosimetric E-Field Probe	ES3DV3	3071	Jun. 18, 2013	Jun. 17, 2014
SPEAG	Dosimetric E-Field Probe	ES3DV3	3270	Sep. 28, 2012	Sep. 27, 2013
Wisewind	Thermometer	ETP-101	TM560	Nov. 13, 2012	Nov. 12, 2013
Wisewind	Thermometer	ETP-101	TM685	Nov. 13, 2012	Nov. 12, 2013
Wisewind	Thermometer	HTC-1	TM281	Nov. 13, 2012	Nov. 12, 2013
Anritsu	Radio Communication Analyzer	MT8820C	6201074414	Dec. 11, 2012	Dec. 10, 2014
Agilent	Wireless Communication Test Set	E5515C	MY50266977	May. 06, 2013	May. 05, 2015
R&S	Radio communication Tester	CMW500	116160	Jan. 09, 2013	Jan. 08, 2014
SPEAG	Device Holder	N/A	N/A	NCR	NCR
Agilent	ESG Vector Series Signal Generator	E4438C	MY49070755	Oct. 02, 2012	Oct. 01, 2013
SPEAG	Dielectric Probe Kit	DAK-3.5	1126	Jul. 23, 2013	Jul. 22, 2014
Agilent	ENA Network Analyzer	E5071C	MY46316648	Feb. 07, 2013	Feb. 06, 2014
Anritsu	Power Meter	ML2495A	1218006	Oct. 22, 2012	Oct. 21, 2013
Anritsu	Power Sensor	MA2411B	1207363	Oct. 24, 2012	Oct. 23, 2013
Agilent	Dual Directional Coupler	778D	50422	Note 4	
Woken	Attenuator 1	WK0602-XX	N/A	Note 4	
PE	Attenuator 2	PE7005-10	N/A	Note 4	
PE	Attenuator 3	PE7005- 3	N/A	Note 4	
AR	Power Amplifier	5S1G4M2	328767	Note 5	
R&S	Spectrum Analyzer	FSP 7	101131	Jul. 09, 2013	Jul. 08, 2014

Table 5.1 Test Equipment List

General Note:

1. The calibration certificate of DASY can be referred to appendix C of this report.
2. Referring to KDB 865664 D01v01r01, the dipole calibration interval can be extended to 3 years with justification. The dipoles are also not physically damaged, or repaired during the interval.
3. The justification data of dipole D1750V2, SN: 1068 can be found in appendix C. The return loss is < -20dB, within 20% of prior calibration, the impedance is within 5 ohm of prior calibration.
4. The Insertion Loss calibration of Dual Directional Coupler and Attenuator were characterized via the network analyzer and compensated during system check.
5. In system check we need to monitor the level on the power meter, and adjust the power amplifier level to have precise power level to the dipole; the measured SAR will be normalized to 1W input power according to the ratio of 1W to the input power to the dipole. For system check, the calibration of the power amplifier is deemed not critically required for correct measurement; the power meter is critical and we do have calibration for it
6. Attenuator 1 insertion loss is calibrated by the network Analyzer, which the calibration is valid, before system check.

7. Tissue Simulating Liquids

For the measurement of the field distribution inside the SAM phantom with DASY, the phantom must be filled with around 25 liters of homogeneous body tissue simulating liquid. For head SAR testing, the liquid height from the ear reference point (ERP) of the phantom to the liquid top surface is larger than 15 cm, which is shown in Fig. 6.1. For body SAR testing, the liquid height from the center of the flat phantom to the liquid top surface is larger than 15 cm, which is shown in Fig. 6.2.

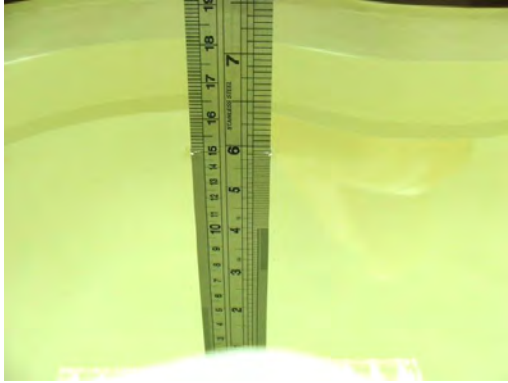

Fig 6.1 Photo of Liquid Height for Head SAR

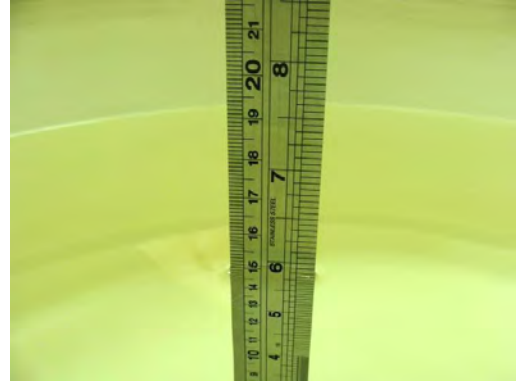

Fig 6.2 Photo of Liquid Height for Body SAR

The following table gives the recipes for tissue simulating liquid.

Frequency (MHz)	Water (%)	Sugar (%)	Cellulose (%)	Salt (%)	Preventol (%)	DGBE (%)	Conductivity (σ)	Permittivity (ϵ_r)
For Head								
750	41.1	57.0	0.2	1.4	0.2	0	0.89	41.9
835	40.3	57.9	0.2	1.4	0.2	0	0.90	41.5
900	40.3	57.9	0.2	1.4	0.2	0	0.97	41.5
1800, 1900, 2000	55.2	0	0	0.3	0	44.5	1.40	40.0
2450	55.0	0	0	0	0	45.0	1.80	39.2
For Body								
750	51.7	47.2	0	0.9	0.1	0	0.96	55.5
835	50.8	48.2	0	0.9	0.1	0	0.97	55.2
900	50.8	48.2	0	0.9	0.1	0	1.05	55.0
1800, 1900, 2000	70.2	0	0	0.4	0	29.4	1.52	53.3
2450	68.6	0	0	0	0	31.4	1.95	52.7

Table 6.1 Recipes of Tissue Simulating Liquid

Simulating Liquid for 5G, Manufactured by SPEAG

Ingredients	(% by weight)
Water	64~78%
Mineral oil	11~18%
Emulsifiers	9~15%
Additives and Salt	2~3%

The dielectric parameters of the liquids were verified prior to the SAR evaluation using an SPEAG DAK-3.5 Dielectric Probe Kit and an Agilent Network Analyzer.

The following table shows the measuring results for simulating liquid.

Frequency (MHz)	Liquid Type	Liquid Temp. (°C)	Conductivity (σ)	Permittivity (ϵ_r)	Conductivity Target (σ)	Permittivity Target (ϵ_r)	Delta (σ) (%)	Delta (ϵ_r) (%)	Limit (%)	Date
750	Body	22.5	0.972	54.965	0.96	55.50	1.25	-0.96	±5	2013/9/11
750	Body	22.2	0.963	54.233	0.96	55.50	0.31	-2.28	±5	2013/9/13
750	Body	22.6	0.973	54.284	0.96	55.50	1.35	-2.19	±5	2013/9/16
835	Body	22.5	0.995	54.886	0.97	55.20	2.58	-0.57	±5	2013/9/9
835	Body	22.6	0.988	54.880	0.97	55.20	1.86	-0.58	±5	2013/9/11
835	Body	22.4	0.998	55.923	0.97	55.20	2.89	1.31	±5	2013/9/13
835	Body	22.4	0.998	55.923	0.97	55.20	2.89	1.31	±5	2013/9/13
835	Body	22.6	0.996	55.380	0.97	55.20	2.68	0.33	±5	2013/9/16
1750	Body	22.5	1.538	52.117	1.52	53.30	1.18	-2.22	±5	2013/9/10
1750	Body	22.5	1.494	51.651	1.52	53.30	-1.71	-3.09	±5	2013/9/24
1900	Body	22.6	1.532	52.506	1.52	53.30	0.79	-1.49	±5	2013/9/11
1900	Body	22.6	1.526	52.813	1.52	53.30	0.39	-0.91	±5	2013/9/12
1900	Body	22.5	1.532	52.328	1.52	53.30	0.79	-1.82	±5	2013/9/13
1900	Body	22.6	1.530	52.859	1.52	53.30	0.66	-0.83	±5	2013/9/16
2450	Body	22.5	2.020	53.886	1.95	52.70	3.59	2.25	±5	2013/7/25
2450	Body	22.5	2.020	53.936	1.95	52.70	3.59	2.35	±5	2013/7/31
2450	Body	22.6	2.010	53.813	1.95	52.70	3.08	2.11	±5	2013/8/3
5200	Body	22.4	5.327	49.297	5.30	49.00	0.51	0.61	±5	2013/7/26
5200	Body	22.5	5.318	47.507	5.30	49.00	0.34	-3.05	±5	2013/8/1
5300	Body	22.4	5.469	49.105	5.42	48.88	0.90	0.46	±5	2013/7/26
5300	Body	22.5	5.457	47.242	5.42	48.88	0.68	-3.35	±5	2013/8/1
5600	Body	22.4	5.904	48.418	5.77	48.47	2.32	-0.11	±5	2013/7/26
5600	Body	22.5	5.881	46.699	5.77	48.47	1.92	-3.65	±5	2013/7/30
5600	Body	22.5	5.857	46.718	5.77	48.47	1.51	-3.61	±5	2013/8/1
5600	Body	22.3	5.849	47.666	5.77	48.47	1.37	-1.66	±5	2013/8/7
5800	Body	22.4	6.160	47.897	6.00	48.20	2.67	-0.63	±5	2013/7/26
5800	Body	22.6	6.217	46.407	6.00	48.20	3.62	-3.72	±5	2013/8/1

Table 6.2 Measuring Results for Simulating Liquid

8. System Verification Procedures

Each DASY system is equipped with one or more system validation kits. These units, together with the predefined measurement procedures within the DASY software, enable the user to conduct the system performance check and system validation. System validation kit includes a dipole, tripod holder to fix it underneath the flat phantom and a corresponding distance holder.

8.1 Purpose of System Performance check

The system performance check verifies that the system operates within its specifications. System and operator errors can be detected and corrected. It is recommended that the system performance check be performed prior to any usage of the system in order to guarantee reproducible results. The system performance check uses normal SAR measurements in a simplified setup with a well characterized source. This setup was selected to give a high sensitivity to all parameters that might fail or vary over time. The system check does not intend to replace the calibration of the components, but indicates situations where the system uncertainty is exceeded due to drift or failure.

8.2 System Setup

In the simplified setup for system evaluation, the EUT is replaced by a calibrated dipole and the power source is replaced by a continuous wave that comes from a signal generator. The calibrated dipole must be placed beneath the flat phantom section of the SAM twin phantom with the correct distance holder. The distance holder should touch the phantom surface with a light pressure at the reference marking and be oriented parallel to the long side of the phantom. The equipment setup is shown below:

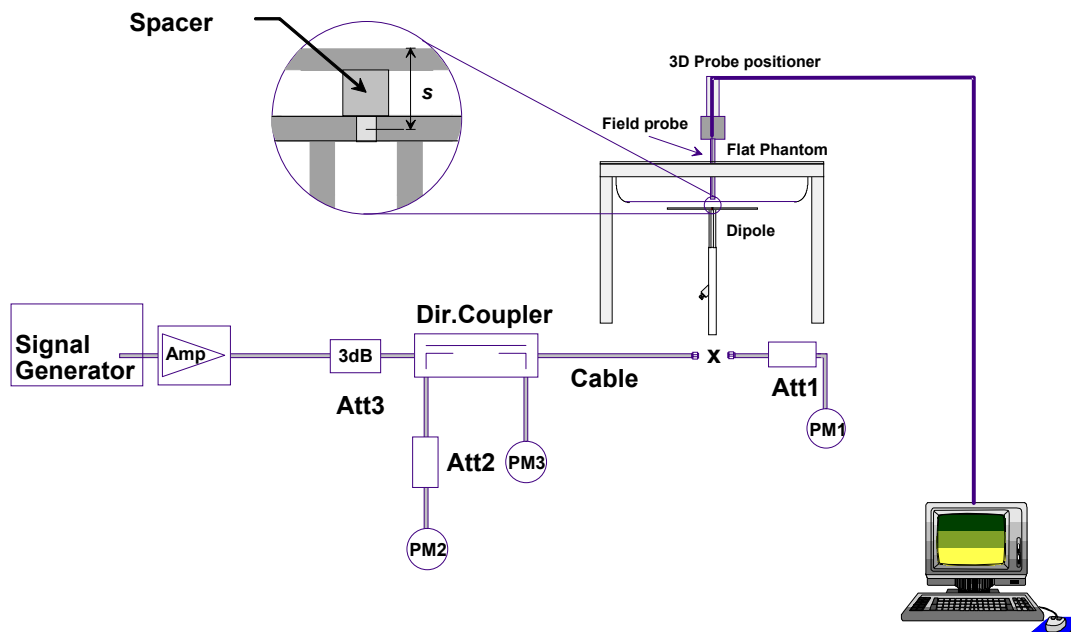

Fig 7.1 System Setup for System Evaluation

1. Signal Generator
2. Amplifier
3. Directional Coupler
4. Power Meter
5. Calibrated Dipole



Fig 7.2 Photo of Dipole Setup

8.3 SAR System Verification Results

Comparing to the original SAR value provided by SPEAG, the verification data should be within its specification of 10 %. Table 7.1 shows the target SAR and measured SAR after normalized to 1W input power. The table below indicates the system performance check can meet the variation criterion and the plots can be referred to Appendix A of this report.

Date	Frequency (MHz)	Liquid Type	Input Power (mW)	Dipole S/N	Probe S/N	DAE S/N	Measured SAR (W/kg)	Targeted SAR (W/kg)	Normalized SAR (W/kg)	Deviation (%)
2013/9/11	750	Body	250	1012	3697	1279	2.37	8.83	9.48	7.36
2013/9/13	750	Body	250	1012	3801	778	2.05	8.83	8.20	-7.13
2013/9/16	750	Body	250	1012	3071	1279	2.25	8.83	9.00	1.93
2013/9/9	835	Body	250	499	3792	1338	2.23	9.63	8.92	-7.37
2013/9/11	835	Body	250	499	3697	1279	2.50	9.63	10.00	3.84
2013/9/13	835	Body	250	499	1788	577	2.42	9.63	9.68	0.52
2013/9/13	835	Body	250	499	3801	788	2.49	9.63	9.96	3.43
2013/9/16	835	Body	250	499	3071	1279	2.47	9.63	9.88	2.60
2013/9/10	1750	Body	250	1068	3697	1279	9.58	36.8	38.32	4.13
2013/9/24	1750	Body	250	1068	3925	495	9.17	36.8	36.68	-0.33
2013/9/11	1900	Body	250	5d041	3697	1279	9.96	40.8	39.84	-2.35
2013/9/12	1900	Body	250	5d041	3697	1279	9.92	40.8	39.68	-2.75
2013/9/13	1900	Body	250	5d041	1788	577	9.50	40.8	38.00	-6.86
2013/9/16	1900	Body	250	5d041	1788	577	9.49	40.8	37.96	-6.96
2013/7/25	2450	Body	250	869	3270	778	12.30	51.5	49.20	-4.47
2013/7/31	2450	Body	250	869	3270	778	13.60	51.5	54.40	5.63
2013/8/3	2450	Body	250	869	3270	778	13.80	51.5	55.20	7.18
2013/7/26	5200	Body	100	1006	3697	778	6.87	71.4	68.70	-3.78
2013/8/1	5200	Body	100	1006	3792	1338	7.34	71.4	73.40	2.80
2013/7/26	5300	Body	100	1006	3697	778	7.00	73.5	70.00	-4.76
2013/8/1	5300	Body	100	1006	3792	1338	6.92	73.5	69.20	-5.85
2013/7/26	5600	Body	100	1006	3697	778	7.37	76.8	73.70	-4.04
2013/7/30	5600	Body	100	1006	3792	1338	8.15	76.8	81.50	6.12
2013/8/1	5600	Body	100	1006	3792	1338	7.61	76.8	76.10	-0.91
2013/8/7	5600	Body	100	1006	3697	1279	7.31	76.8	73.10	-4.82
2013/7/26	5800	Body	100	1006	3697	778	7.12	71.7	71.20	-0.70
2013/8/1	5800	Body	100	1006	3792	1338	7.47	71.7	74.70	4.18

Table 7.1 Target and Measurement SAR after Normalized

9. EUT Testing Position

Please refer to the test setup photos.

10. Measurement Procedures

The measurement procedures are as follows:

<Conducted power measurement>

- (a) For WWAN power measurement, use base station simulator to configure EUT WWAN transmission in conducted connection with RF cable, at maximum power in each supported wireless interface and frequency band.
- (b) Read the WWAN RF power level from the base station simulator.
- (c) For WLAN/BT power measurement, use engineering software to configure EUT WLAN/BT continuously transmission, at maximum RF power in each supported wireless interface and frequency band
- (d) Connect EUT RF port through RF cable to the power meter, and measure WLAN/BT output power

<SAR measurement>

- (a) Use base station simulator to configure EUT WWAN transmission in radiated connection, and engineering software to configure EUT WLAN/BT continuously transmission, at maximum RF power, in the highest power channel.
- (b) Place the EUT in the positions as Appendix D demonstrates.
- (c) Set scan area, grid size and other setting on the DASY software.
- (d) Measure SAR results for the highest power channel on each testing position.
- (e) Find out the largest SAR result on these testing positions of each band
- (f) Measure SAR results for other channels in worst SAR testing position if the reported SAR of highest power channel is larger than 0.8 W/kg

According to the test standard, the recommended procedure for assessing the peak spatial-average SAR value consists of the following steps:

- (a) Power reference measurement
- (b) Area scan
- (c) Zoom scan
- (d) Power drift measurement

10.1 Spatial Peak SAR Evaluation

The procedure for spatial peak SAR evaluation has been implemented according to the test standard. It can be conducted for 1g and 10g, as well as for user-specific masses. The DASY software includes all numerical procedures necessary to evaluate the spatial peak SAR value.

The base for the evaluation is a "cube" measurement. The measured volume must include the 1g and 10g cubes with the highest averaged SAR values. For that purpose, the center of the measured volume is aligned to the interpolated peak SAR value of a previously performed area scan.

The entire evaluation of the spatial peak values is performed within the post-processing engine (SEMCAD). The system always gives the maximum values for the 1g and 10g cubes. The algorithm to find the cube with highest averaged SAR is divided into the following stages:

- (a) Extraction of the measured data (grid and values) from the Zoom Scan
- (b) Calculation of the SAR value at every measurement point based on all stored data (A/D values and measurement parameters)
- (c) Generation of a high-resolution mesh within the measured volume
- (d) Interpolation of all measured values from the measurement grid to the high-resolution grid
- (e) Extrapolation of the entire 3-D field distribution to the phantom surface over the distance from sensor to surface
- (f) Calculation of the averaged SAR within masses of 1g and 10g

10.2 Power Reference Measurement

The Power Reference Measurement and Power Drift Measurements are for monitoring the power drift of the device under test in the batch process. The minimum distance of probe sensors to surface determines the closest measurement point to phantom surface. This distance cannot be smaller than the distance of sensor calibration points to probe tip as defined in the probe properties.

10.3 Area & Zoom Scan Procedures

First Area Scan is used to locate the approximate location(s) of the local peak SAR value(s). The measurement grid within an Area Scan is defined by the grid extent, grid step size and grid offset. Next, in order to determine the EM field distribution in a three-dimensional spatial extension, Zoom Scan is required. The Zoom Scan is performed around the highest E-field value to determine the averaged SAR-distribution over 10 g. Area scan and zoom scan resolution setting follows KDB 865664 D01v01r01 quoted below.

When the 1-g SAR of the highest peak is within 2 dB of the SAR limit, additional zoom scans are required for other peaks within 2 dB of the highest peak that have not been included in any zoom scan to ensure there is no increase in SAR.

		≤ 3 GHz	> 3 GHz
Maximum distance from closest measurement point (geometric center of probe sensors) to phantom surface		5 ± 1 mm	$\frac{1}{2} \cdot \delta \cdot \ln(2) \pm 0.5$ mm
Maximum probe angle from probe axis to phantom surface normal at the measurement location		$30^\circ \pm 1^\circ$	$20^\circ \pm 1^\circ$
Maximum area scan spatial resolution: Δx_{Area} , Δy_{Area}		≤ 2 GHz: ≤ 15 mm 2 – 3 GHz: ≤ 12 mm	3 – 4 GHz: ≤ 12 mm 4 – 6 GHz: ≤ 10 mm
		When the x or y dimension of the test device, in the measurement plane orientation, is smaller than the above, the measurement resolution must be \leq the corresponding x or y dimension of the test device with at least one measurement point on the test device.	
Maximum zoom scan spatial resolution: Δx_{Zoom} , Δy_{Zoom}		≤ 2 GHz: ≤ 8 mm 2 – 3 GHz: ≤ 5 mm*	3 – 4 GHz: ≤ 5 mm* 4 – 6 GHz: ≤ 4 mm*
Maximum zoom scan spatial resolution, normal to phantom surface	uniform grid: $\Delta z_{Zoom}(n)$	≤ 5 mm	3 – 4 GHz: ≤ 4 mm 4 – 5 GHz: ≤ 3 mm 5 – 6 GHz: ≤ 2 mm
	graded grid	$\Delta z_{Zoom}(1)$: between 1 st two points closest to phantom surface	≤ 4 mm
		$\Delta z_{Zoom}(n>1)$: between subsequent points	$\leq 1.5 \cdot \Delta z_{Zoom}(n-1)$
Minimum zoom scan volume	x, y, z	≥ 30 mm	3 – 4 GHz: ≥ 28 mm 4 – 5 GHz: ≥ 25 mm 5 – 6 GHz: ≥ 22 mm
<p>Note: δ is the penetration depth of a plane-wave at normal incidence to the tissue medium; see draft standard IEEE P1528-2011 for details.</p> <p>* When zoom scan is required and the <i>reported</i> SAR from the area scan based 1-g SAR estimation procedures of KDB 447498 is ≤ 1.4 W/kg, ≤ 8 mm, ≤ 7 mm and ≤ 5 mm zoom scan resolution may be applied, respectively, for 2 GHz to 3 GHz, 3 GHz to 4 GHz and 4 GHz to 6 GHz.</p>			

10.4 Volume Scan Procedures

The volume scan is used for assess overlapping SAR distributions for antennas transmitting in different frequency bands. It is equivalent to an oversized zoom scan used in standalone measurements. The measurement volume will be used to enclose all the simultaneous transmitting antennas. For antennas transmitting simultaneously in different frequency bands, the volume scan is measured separately in each frequency band. In order to sum correctly to compute the 1g aggregate SAR, the EUT remain in the same test position for all measurements and all volume scan use the same spatial resolution and grid spacing. When all volume scan were completed, the software, SEMCAD postprocessor can combine and subsequently superpose these measurement data to calculating the multiband SAR.

10.5 SAR Averaged Methods

In DASy, the interpolation and extrapolation are both based on the modified Quadratic Shepard's method. The interpolation scheme combines a least-square fitted function method and a weighted average method which are the two basic types of computational interpolation and approximation.

Extrapolation routines are used to obtain SAR values between the lowest measurement points and the inner phantom surface. The extrapolation distance is determined by the surface detection distance and the probe sensor offset. The uncertainty increases with the extrapolation distance. To keep the uncertainty within 1% for the 1 g and 10 g cubes, the extrapolation distance should not be larger than 5 mm.

10.6 Power Drift Monitoring

All SAR testing is under the EUT install full charged battery and transmit maximum output power. In DASy measurement software, the power reference measurement and power drift measurement procedures are used for monitoring the power drift of EUT during SAR test. Both these procedures measure the field at a specified reference position before and after the SAR testing. The software will calculate the field difference in dB. If the power drifts more than 5%, the SAR will be retested.

11. Bluetooth Exclusions Applied

Band / Mode	Maximum Average power(dBm)		
	1Mbps (GFSK)	2Mbps (π/4-DQPSK)	3Mbps (8-DPSK)
2.4 GHz Bluetooth	5.5	5.5	5.5

General Note:

- Per KDB 447498 D01v05r01, the 1-g and 10-g SAR test exclusion thresholds for 100 MHz to 6 GHz at *test separation distances* ≤ 50 mm are determined by:

$[(\text{max. power of channel, including tune-up tolerance, mW}) / (\text{min. test separation distance, mm})] \cdot [\sqrt{f(\text{GHz})}] \leq 3.0$ for 1-g SAR and ≤ 7.5 for 10-g extremity SAR

- f(GHz) is the RF channel transmit frequency in GHz
- Power and distance are rounded to the nearest mW and mm before calculation
- The result is rounded to one decimal place for comparison

Bluetooth Max Power (dBm)	Distance (mm)	Frequency (GHz)	exclusion thresholds
5.5	5	2.48	1.26

- Per KDB 447498 D01v05r01 exclusion thresholds is $1.26 < 3$, RF exposure evaluation is not required.

12. Conducted RF Output Power (Unit: dBm)

<GSM Conducted Power>

General Note:

- Per KDB 447498 D01v05r01, the maximum output power channel is used for SAR testing and for further SAR test reduction.
- Following KDB 941225 D03v01, for Body SAR testing, the EUT operating without power back-off was set in GPRS (2 Tx slots) and the EUT operating with power back-off was set in GPRS (2 Tx slots) due to its highest frame-average power.

Full Power Mode (Proximity Sensor Inactive)

Band GSM850 TX Channel	Burst Average Power (dBm)			Frame-Average Power (dBm)		
	128	189	251	128	189	251
Frequency (MHz)	824.2	836.4	848.8	824.2	836.4	848.8
GPRS (GMSK, 1 Tx slot) – CS1	32.3	32.4	32.5	23.3	23.4	23.5
GPRS (GMSK, 2 Tx slots) – CS1	31.7	31.8	31.9	25.7	25.8	25.9
EDGE (8PSK, 1 Tx slot) – MCS5	26.7	26.7	26.8	17.7	17.7	17.8
EDGE (8PSK, 2 Tx slots) – MCS5	26.6	26.6	26.7	20.6	20.6	20.7

Remark: The frame-averaged power is linearly scaled the maximum burst averaged power over 8 time slots.

The calculated method are shown as below:

Frame-averaged power = Maximum burst averaged power (1 Tx Slot) - 9 dB

Frame-averaged power = Maximum burst averaged power (2 Tx Slots) - 6 dB

Reduced Power Mode (Proximity Sensor active)

Band GSM850 TX Channel	Burst Average Power (dBm)			Frame-Average Power (dBm)		
	128	189	251	128	189	251
Frequency (MHz)	824.2	836.4	848.8	824.2	836.4	848.8
GPRS (GMSK, 1 Tx slot) – CS1	24.9	24.7	25.0	15.9	15.7	16.0
GPRS (GMSK, 2 Tx slots) – CS1	22.8	22.7	22.9	16.8	16.7	16.9
EDGE (8PSK, 1 Tx slot) – MCS5	19.1	19.2	19.3	10.1	10.2	10.3
EDGE (8PSK, 2 Tx slots) – MCS5	19.0	19.1	19.2	13.0	13.1	13.2

Remark: The frame-averaged power is linearly scaled the maximum burst averaged power over 8 time slots.

The calculated method are shown as below:

Frame-averaged power = Maximum burst averaged power (1 Tx Slot) - 9 dB

Frame-averaged power = Maximum burst averaged power (2 Tx Slots) - 6 dB

Full Power Mode (Proximity Sensor Inactive)

Band GSM1900 TX Channel	Burst Average Power (dBm)			Frame-Average Power (dBm)		
	512	661	810	512	661	810
Frequency (MHz)	1850.2	1880	1909.8	1850.2	1880	1909.8
GPRS (GMSK, 1 Tx slot) – CS1	29.5	29.7	29.6	20.5	20.7	20.6
GPRS (GMSK, 2 Tx slots) – CS1	28.7	28.9	28.8	22.7	22.9	22.8
EDGE (8PSK, 1 Tx slot) – MCS5	25.9	25.8	25.9	16.9	16.8	16.9
EDGE (8PSK, 2 Tx slots) – MCS5	25.8	25.8	25.8	19.8	19.8	19.8

Remark: The frame-averaged power is linearly scaled the maximum burst averaged power over 8 time slots.

The calculated method are shown as below:

Frame-averaged power = Maximum burst averaged power (1 Tx Slot) - 9 dB

Frame-averaged power = Maximum burst averaged power (2 Tx Slots) - 6 dB

Reduced Power Mode (Proximity Sensor active)

Band GSM1900 TX Channel	Burst Average Power (dBm)			Frame-Average Power (dBm)		
	512	661	810	512	661	810
Frequency (MHz)	1850.2	1880	1909.8	1850.2	1880	1909.8
GPRS (GMSK, 1 Tx slot) – CS1	24.7	24.9	24.8	15.7	15.9	15.8
GPRS (GMSK, 2 Tx slots) – CS1	24.7	24.8	24.8	18.7	18.8	18.8
EDGE (8PSK, 1 Tx slot) – MCS5	21.0	20.8	20.9	12.0	11.8	11.9
EDGE (8PSK, 2 Tx slots) – MCS5	21.0	20.8	20.9	15.0	14.8	14.9

Remark: The frame-averaged power is linearly scaled the maximum burst averaged power over 8 time slots.

The calculated method are shown as below:

Frame-averaged power = Maximum burst averaged power (1 Tx Slot) - 9 dB

Frame-averaged power = Maximum burst averaged power (2 Tx Slots) - 6 dB

<WCDMA Conducted Power>

The following tests were conducted according to the test requirements outlines in 3GPP TS 34.121 specification. A summary of these settings are illustrated below:

HSDPA Setup Configuration:

- a. The EUT was connected to Base Station Agilent E5515C referred to the Setup Configuration.
- b. The RF path losses were compensated into the measurements.
- c. A call was established between EUT and Base Station with following setting:
 - i. Set Gain Factors (β_c and β_d) and parameters were set according to each
 - ii. Specific sub-test in the following table, C10.1.4, quoted from the TS 34.121
 - iii. Set RMC 12.2Kbps + HSDPA mode.
 - iv. Set Cell Power = -86 dBm
 - v. Set HS-DSCH Configuration Type to FRC (H-set 1, QPSK)
 - vi. Select HSDPA Uplink Parameters
 - vii. Set Delta ACK, Delta NACK and Delta CQI = 8
 - viii. Set Ack-Nack Repetition Factor to 3
 - ix. Set CQI Feedback Cycle (k) to 4 ms
 - x. Set CQI Repetition Factor to 2
 - xi. Power Ctrl Mode = All Up bits
- d. The transmitted maximum output power was recorded.

Table C.10.1.4: β values for transmitter characteristics tests with HS-DPCCH

Sub-test	β_c	β_d	β_d (SF)	β_c/β_d	β_{HS} (Note 1, Note 2)	CM (dB) (Note 3)	MPR (dB) (Note 3)
1	2/15	15/15	64	2/15	4/15	0.0	0.0
2	12/15 (Note 4)	15/15 (Note 4)	64	12/15 (Note 4)	24/15	1.0	0.0
3	15/15	8/15	64	15/8	30/15	1.5	0.5
4	15/15	4/15	64	15/4	30/15	1.5	0.5

Note 1: Δ_{ACK} , Δ_{NACK} and $\Delta_{CQI} = 30/15$ with $\beta_{HS} = 30/15 * \beta_c$.

Note 2: For the HS-DPCCH power mask requirement test in clause 5.2C, 5.7A, and the Error Vector Magnitude (EVM) with HS-DPCCH test in clause 5.13.1A, and HSDPA EVM with phase discontinuity in clause 5.13.1AA, Δ_{ACK} and $\Delta_{NACK} = 30/15$ with $\beta_{HS} = 30/15 * \beta_c$, and $\Delta_{CQI} = 24/15$ with $\beta_{HS} = 24/15 * \beta_c$.

Note 3: CM = 1 for $\beta_c/\beta_d = 12/15$, $\beta_{HS}/\beta_c = 24/15$. For all other combinations of DPDCH, DPCCH and HS-DPCCH the MPR is based on the relative CM difference. This is applicable for only UEs that support HSDPA in release 6 and later releases.

Note 4: For subtest 2 the β_c/β_d ratio of 12/15 for the TFC during the measurement period (TF1, TF0) is achieved by setting the signalled gain factors for the reference TFC (TF1, TF1) to $\beta_c = 11/15$ and $\beta_d = 15/15$.

Setup Configuration

HSUPA Setup Configuration:

- a. The EUT was connected to Base Station Agilent E5515C referred to the Setup Configuration.
- b. The RF path losses were compensated into the measurements.
- c. A call was established between EUT and Base Station with following setting * :
 - i. Call Configs = 5.2B, 5.9B, 5.10B, and 5.13.2B with QPSK
 - ii. Set the Gain Factors (β_c and β_d) and parameters (AG Index) were set according to each specific sub-test in the following table, C11.1.3, quoted from the TS 34.121
 - iii. Set Cell Power = -86 dBm
 - iv. Set Channel Type = 12.2k + HSPA
 - v. Set UE Target Power
 - vi. Power Ctrl Mode= Alternating bits
 - vii. Set and observe the E-TFCl
 - viii. Confirm that E-TFCl is equal to the target E-TFCl of 75 for sub-test 1, and other subtest's E-TFCl
- d. The transmitted maximum output power was recorded.

Table C.11.1.3: β values for transmitter characteristics tests with HS-DPCCH and E-DCH

Sub-test	β_c	β_d	β_d (SF)	β_c/β_d	β_{HS} (Note 1)	β_{ec}	β_{ed} (Note 5) (Note 6)	β_{ed} (SF)	β_{ed} (Codes)	CM (dB) (Note 2)	MPR (dB) (Note 2)	AG Index (Note 6)	E-TFCl
1	11/15 (Note 3)	15/15 (Note 3)	64	11/15 (Note 3)	22/15	209/25	1309/225	4	1	1.0	0.0	20	75
2	6/15	15/15	64	6/15	12/15	12/15	94/75	4	1	3.0	2.0	12	67
3	15/15	9/15	64	15/9	30/15	30/15	$\beta_{ed1}: 47/15$ $\beta_{ed2}: 47/15$	4 4	2	2.0	1.0	15	92
4	2/15	15/15	64	2/15	4/15	2/15	56/75	4	1	3.0	2.0	17	71
5	15/15 (Note 4)	15/15 (Note 4)	64	15/15 (Note 4)	30/15	24/15	134/15	4	1	1.0	0.0	21	81

Note 1: $\Delta_{ACK}, \Delta_{NACK}$ and $\Delta_{CQI} = 30/15$ with $\beta_{hs} = 30/15 * \beta_c$.

Note 2: CM = 1 for $\beta_c/\beta_d = 12/15$, $\beta_{hs}/\beta_c = 24/15$. For all other combinations of DPDCH, DPCCH, HS-DPCCH, E-DPDCH and E-DPCCH the MPR is based on the relative CM difference.

Note 3: For subtest 1 the β_c/β_d ratio of 11/15 for the TFC during the measurement period (TF1, TF0) is achieved by setting the signalled gain factors for the reference TFC (TF1, TF1) to $\beta_c = 10/15$ and $\beta_d = 15/15$.

Note 4: For subtest 5 the β_c/β_d ratio of 15/15 for the TFC during the measurement period (TF1, TF0) is achieved by setting the signalled gain factors for the reference TFC (TF1, TF1) to $\beta_c = 14/15$ and $\beta_d = 15/15$.

Note 5: In case of testing by UE using E-DPDCH Physical Layer category 1, Sub-test 3 is omitted according to TS25.306 Table 5.1g.

Note 6: β_{ed} can not be set directly, it is set by Absolute Grant Value.

Setup Configuration

<WCDMA Conducted Power>

General Note:

- Per KDB 941225 D02v02r02, RMC 12.2kbps setting is used to evaluate SAR. If HSDPA/HSUPA output power is < 0.25dB higher than RMC12.2Kbps, or reported SAR with RMC 12.2kbps setting is $\leq 1.2W/kg$, HSDPA/HSUPA SAR evaluation can be excluded.

Full Power Mode (Proximity Sensor Inactive)

Band			WCDMA V			WCDMA II		
TX Channel			4132	4182	4233	9262	9400	9538
Frequency (MHz)			826.4	836.4	846.6	1852.4	1880	1907.6
MPR(dB)	3GPP Rel 99	RMC 12.2Kbps	22.7	22.7	22.8	23.0	23.1	23.1
0	3GPP Rel 6	HSDPA Subtest-1	21.8	21.8	21.9	22.2	22.5	22.2
0	3GPP Rel 6	HSDPA Subtest-2	21.7	21.7	21.8	22.1	22.3	22.1
0.5	3GPP Rel 6	HSDPA Subtest-3	21.3	21.2	21.3	21.8	22.0	21.7
0.5	3GPP Rel 6	HSDPA Subtest-4	21.3	21.3	21.3	21.7	21.9	21.7
0	3GPP Rel 6	HSUPA Subtest-1	21.2	21.4	21.5	22.2	22.4	22.4
2	3GPP Rel 6	HSUPA Subtest-2	21.0	21.2	21.3	21.7	21.8	21.9
1	3GPP Rel 6	HSUPA Subtest-3	21.0	21.1	21.2	21.7	21.8	21.9
2	3GPP Rel 6	HSUPA Subtest-4	21.1	21.3	21.5	21.9	22.1	22.1
0	3GPP Rel 6	HSUPA Subtest-5	21.4	21.6	21.7	22.4	22.5	22.5

Reduced Power Mode (Proximity Sensor active)

Band			WCDMA V			WCDMA II		
TX Channel			4132	4182	4233	9262	9400	9538
Frequency (MHz)			826.4	836.4	846.6	1852.4	1880	1907.6
MPR(dB)	3GPP Rel 99	RMC 12.2Kbps	17.8	17.7	17.9	18.4	18.3	18.3
0	3GPP Rel 6	HSDPA Subtest-1	16.8	16.8	17.0	17.6	17.7	17.5
0	3GPP Rel 6	HSDPA Subtest-2	16.7	16.7	16.9	17.5	17.6	17.4
0.5	3GPP Rel 6	HSDPA Subtest-3	16.5	16.4	16.4	17.0	17.1	17.0
0.5	3GPP Rel 6	HSDPA Subtest-4	16.4	16.4	16.5	17.0	17.1	16.9
0	3GPP Rel 6	HSUPA Subtest-1	16.5	16.5	16.6	17.5	17.4	17.4
2	3GPP Rel 6	HSUPA Subtest-2	15.6	15.7	15.9	16.8	16.8	16.9
1	3GPP Rel 6	HSUPA Subtest-3	15.8	15.9	16.0	17.1	17.2	17.1
2	3GPP Rel 6	HSUPA Subtest-4	15.8	15.9	16.0	16.8	16.9	16.9
0	3GPP Rel 6	HSUPA Subtest-5	16.7	16.9	17.0	17.5	17.7	17.6

<LTE Conducted Power>

Note:

1. Anritsu MT8820C base station simulator was used to setup the connection with EUT; the frequency band, channel bandwidth, RB allocation configuration, modulation type are set in the base station simulator to configure EUT transmitting at maximum power and at different configurations which are requested to be reported to FCC, for conducted power measurement and SAR testing.
2. Per KDB 941225 D05v02r02, when a properly configured base station simulator is used for the SAR and power measurements, spectrum plots for each RB allocation and offset configuration is not required.
3. Per KDB 941225 D05v02r02, start with the largest channel bandwidth and measure SAR for QPSK with 1 RB allocation, using the RB offset and required test channel combination with the highest maximum output power for RB offsets at the upper edge, middle and lower edge of each required test channel.
4. Per KDB 941225 D05v02r02, 50% RB allocation for QPSK SAR testing follows 1RB QPSK allocation procedure.
5. Per KDB 941225 D05v02r02, when reported SAR of 1RB and 50%RB allocation for QPSK $\leq 0.8\text{W/kg}$, and 100%RB with QPSK output power is less than 1RB and 50%RB, 100%RB allocation for QPSK is not required.
6. Per KDB 941225 D05v02r02, when reported SAR of 1RB and 50%RB allocation for QPSK $> 0.8\text{W/kg}$ for any exposure position, SAR testing of 100%RB allocation for QPSK is performed at the highest power channel.
7. 16QAM output power for each RB allocation configuration is $>$ not $\frac{1}{2}$ dB higher than the same configuration in QPSK and the reported SAR for the QPSK configuration is $\leq 1.45\text{ W/kg}$; Per KDB 941225 D05v02, 16QAM SAR testing is not required.
8. Smaller bandwidth output power for each RB allocation configuration is $>$ not $\frac{1}{2}$ dB higher than the same configuration in the largest supported bandwidth, and the reported SAR for the largest supported bandwidth is $\leq 1.45\text{ W/kg}$; Per KDB 941225 D05v02r02, smaller bandwidth SAR testing is not required.

<LTE Band 17 Conducted Power>

Maximum Average RF Power (Proximity Sensor Inactive)

BW [MHz]	Modulation	RB Size	RB Offset	Power Low Ch. / Freq.	Power Middle Ch. / Freq.	Power High Ch. / Freq.	MPR (dB)
Channel				23780	23790	23800	
Frequency (MHz)				709	710	711	
10	QPSK	1	0	23.1	23.2	23.1	0
10	QPSK	1	24	23.0	23.1	23.0	
10	QPSK	1	49	23.0	23.1	23.0	
10	QPSK	25	0	22.2	22.1	22.1	1
10	QPSK	25	12	22.1	22.1	22.1	
10	QPSK	25	24	22.2	22.1	22.2	
10	QPSK	50	0	21.4	21.5	21.4	1
10	16QAM	1	0	22.5	22.4	22.4	
10	16QAM	1	24	22.2	22.2	22.3	
10	16QAM	1	49	22.4	22.3	22.3	2
10	16QAM	25	0	21.2	21.0	21.0	
10	16QAM	25	12	21.1	21.1	21.2	
10	16QAM	25	24	21.2	21.1	21.1	2
10	16QAM	50	0	21.0	21.0	21.0	
Channel				23755	23790	23825	
Frequency (MHz)				706.5	710	713.5	
5	QPSK	1	0	23.0	23.1	22.9	0
5	QPSK	1	12	22.9	23.0	22.8	
5	QPSK	1	24	22.9	23.0	22.9	
5	QPSK	12	0	22.5	22.3	22.2	1
5	QPSK	12	6	22.4	22.2	22.4	
5	QPSK	12	11	22.2	22.1	22.3	
5	QPSK	25	0	21.8	22.0	22.0	1
5	16QAM	1	0	22.5	22.4	22.3	
5	16QAM	1	12	22.4	22.3	22.1	
5	16QAM	1	24	22.3	22.3	22.2	2
5	16QAM	12	0	21.0	21.1	21.0	
5	16QAM	12	6	21.2	21.3	21.3	
5	16QAM	12	11	21.3	21.2	21.2	2
5	16QAM	25	0	21.4	21.3	21.3	

<LTE Band 17 Conducted Power>
Reduced Average RF Power (Proximity Sensor active)

BW [MHz]	Modulation	RB Size	RB Offset	Power Low Ch. / Freq.	Power Middle Ch. / Freq.	Power High Ch. / Freq.	MPR (dB)
Channel				23780	23790	23800	
Frequency (MHz)				709	710	711	
10	QPSK	1	0	18.1	18.4	18.2	0
10	QPSK	1	24	18.0	18.3	18.3	
10	QPSK	1	49	18.0	18.0	18.0	
10	QPSK	25	0	17.9	18.4	18.3	0
10	QPSK	25	12	17.8	18.2	18.2	
10	QPSK	25	24	18.0	18.3	18.1	
10	QPSK	50	0	17.9	18.1	18.0	0
10	16QAM	1	0	18.2	18.3	18.0	
10	16QAM	1	24	18.0	18.2	18.2	
10	16QAM	1	49	17.9	18.1	18.1	0
10	16QAM	25	0	17.8	18.2	18.2	
10	16QAM	25	12	17.6	18.1	18.0	
10	16QAM	25	24	17.7	18.2	18.2	0
10	16QAM	50	0	17.6	18.1	18.1	
Channel				23755	23790	23825	
Frequency (MHz)				706.5	710	713.5	
5	QPSK	1	0	18.1	18.3	18.2	0
5	QPSK	1	12	18.0	18.3	18.1	
5	QPSK	1	24	17.9	18.3	18.2	
5	QPSK	12	0	17.8	18.2	18.1	0
5	QPSK	12	6	17.7	18.2	18.0	
5	QPSK	12	11	17.9	18.2	17.8	
5	QPSK	25	0	18.0	18.0	17.9	0
5	16QAM	1	0	18.0	18.1	18.1	
5	16QAM	1	12	17.9	18.1	18.2	
5	16QAM	1	24	17.7	18.0	18.0	0
5	16QAM	12	0	17.8	18.0	18.1	
5	16QAM	12	6	17.6	17.9	17.9	
5	16QAM	12	11	17.8	17.8	17.8	0
5	16QAM	25	0	17.8	17.9	17.7	

<LTE Band 4 Conducted Power>

Maximum Average RF Power (Proximity Sensor Inactive)

BW [MHz]	Modulation	RB Size	RB Offset	Power Low Ch. / Freq.	Power Middle Ch. / Freq.	Power High Ch. / Freq.	MPR (dB)
Channel				20050	20175	20300	
Frequency (MHz)				1720	1732.5	1745	
20	QPSK	1	0	24.2	24.4	24.1	0
20	QPSK	1	49	24.0	24.1	24.0	
20	QPSK	1	99	23.9	23.9	24.0	
20	QPSK	50	0	23.4	23.4	23.1	1
20	QPSK	50	24	23.3	23.3	23.2	
20	QPSK	50	49	23.3	23.3	23.3	
20	QPSK	100	0	23.3	23.3	23.3	1
20	16QAM	1	0	23.4	23.4	23.4	
20	16QAM	1	49	23.3	23.3	23.3	
20	16QAM	1	99	23.0	23.3	23.2	2
20	16QAM	50	0	21.9	22.0	22.1	
20	16QAM	50	24	21.8	22.1	22.2	
20	16QAM	50	49	21.8	22.2	22.2	2
20	16QAM	100	0	21.9	21.9	22.1	
Channel				20025	20175	20325	MPR (dB)
Frequency (MHz)				1717.5	1732.5	1747.5	
15	QPSK	1	0	24.2	24.3	24.0	0
15	QPSK	1	37	24.0	24.2	23.9	
15	QPSK	1	74	24.0	24.1	23.9	
15	QPSK	36	0	23.0	23.3	23.1	1
15	QPSK	36	18	23.0	23.2	23.2	
15	QPSK	36	37	23.0	23.2	23.1	
15	QPSK	75	0	23.0	23.3	23.2	1
15	16QAM	1	0	23.2	23.3	23.2	
15	16QAM	1	37	23.1	23.2	23.1	
15	16QAM	1	74	23.1	23.1	23.1	2
15	16QAM	36	0	22.0	22.3	22.0	
15	16QAM	36	18	21.9	22.3	22.1	
15	16QAM	36	37	21.9	22.1	22.0	2
15	16QAM	75	0	21.9	22.2	22.2	
Channel				20000	20175	20350	MPR (dB)
Frequency (MHz)				1715	1732.5	1750	
10	QPSK	1	0	24.2	24.3	24.0	0
10	QPSK	1	24	24.1	24.2	23.9	
10	QPSK	1	49	24.1	24.2	23.8	
10	QPSK	25	0	23.1	23.2	23.0	1
10	QPSK	25	12	23.1	23.1	23.2	
10	QPSK	25	24	23.0	23.1	23.1	
10	QPSK	50	0	22.9	23.2	23.2	1
10	16QAM	1	0	23.1	23.3	23.2	
10	16QAM	1	24	23.0	23.2	23.1	
10	16QAM	1	49	23.0	23.1	23.0	2
10	16QAM	25	0	22.1	22.3	22.0	
10	16QAM	25	12	22.0	22.3	22.2	
10	16QAM	25	24	22.0	22.2	22.1	2
10	16QAM	50	0	22.2	22.3	22.2	

Channel				19975	20175	20375	MPR (dB)
Frequency (MHz)				1712.5	1732.5	1752.5	
5	QPSK	1	0	24.2	24.3	24.0	0
5	QPSK	1	12	24.1	24.2	23.9	
5	QPSK	1	24	24.1	24.1	23.9	
5	QPSK	12	0	23.3	23.2	23.0	1
5	QPSK	12	6	23.3	23.3	23.0	
5	QPSK	12	11	23.1	23.2	23.0	
5	QPSK	25	0	23.0	23.2	23.0	1
5	16QAM	1	0	23.2	23.3	23.0	
5	16QAM	1	12	23.1	23.2	22.9	
5	16QAM	1	24	23.1	23.2	22.8	2
5	16QAM	12	0	22.2	22.2	22.2	
5	16QAM	12	6	22.2	22.3	22.1	
5	16QAM	12	11	22.1	22.3	22.1	2
5	16QAM	25	0	22.2	22.2	22.0	
Channel				19965	20175	20385	
Frequency (MHz)				1711.5	1732.5	1753.5	
3	QPSK	1	0	24.2	24.1	23.9	0
3	QPSK	1	7	24.1	24.0	23.8	
3	QPSK	1	14	24.1	24.0	23.8	
3	QPSK	8	0	23.3	23.1	22.9	1
3	QPSK	8	4	23.2	23.1	22.8	
3	QPSK	8	7	23.2	23.1	22.9	
3	QPSK	15	0	23.2	23.2	22.8	1
3	16QAM	1	0	23.2	23.2	22.9	
3	16QAM	1	7	23.1	23.1	22.8	
3	16QAM	1	14	23.1	23.0	22.8	2
3	16QAM	8	0	22.2	22.1	21.9	
3	16QAM	8	4	22.2	22.2	21.8	
3	16QAM	8	7	22.2	22.3	21.8	2
3	16QAM	8	0	22.2	22.2	21.8	
3	16QAM	15	0	22.2	22.2	21.8	
Channel				19957	20175	20393	MPR (dB)
Frequency (MHz)				1710.7	1732.5	1754.3	
1.4	QPSK	1	0	24.2	24.2	24.1	0
1.4	QPSK	1	2	24.1	24.1	23.9	
1.4	QPSK	1	5	24.1	24.0	23.9	
1.4	QPSK	3	0	24.0	24.0	24.0	
1.4	QPSK	3	1	24.0	24.0	24.0	
1.4	QPSK	3	2	24.0	24.0	24.0	
1.4	QPSK	6	0	23.0	23.0	23.0	1
1.4	16QAM	1	0	23.4	23.3	23.1	1
1.4	16QAM	1	2	23.3	23.2	22.9	
1.4	16QAM	1	5	23.3	23.2	22.8	
1.4	16QAM	3	0	23.0	23.0	23.0	
1.4	16QAM	3	1	23.0	23.0	23.0	
1.4	16QAM	3	2	23.0	23.0	23.0	
1.4	16QAM	6	0	22.0	22.0	22.0	2

<LTE Band 4 Conducted Power>

Reduced Average RF Power (Proximity Sensor active)

BW [MHz]	Modulation	RB Size	RB Offset	Power Low Ch. / Freq.	Power Middle Ch. / Freq.	Power High Ch. / Freq.	MPR (dB)
Channel				20050	20175	20300	
Frequency (MHz)				1720	1732.5	1745	
20	QPSK	1	0	17.6	17.7	17.6	0
20	QPSK	1	49	17.5	17.6	17.4	
20	QPSK	1	99	17.5	17.6	17.4	
20	QPSK	50	0	17.5	17.6	17.5	0
20	QPSK	50	24	17.4	17.5	17.4	
20	QPSK	50	49	17.4	17.5	17.4	
20	QPSK	100	0	17.4	17.5	17.3	0
20	16QAM	1	0	17.5	17.6	17.4	
20	16QAM	1	49	17.4	17.5	17.3	
20	16QAM	1	99	17.4	17.5	17.3	0
20	16QAM	50	0	17.3	17.5	17.3	
20	16QAM	50	24	17.4	17.4	17.2	
20	16QAM	50	49	17.4	17.4	17.3	0
20	16QAM	100	0	17.3	17.5	17.3	
Channel				20025	20175	20325	
Frequency (MHz)				1717.5	1732.5	1747.5	
15	QPSK	1	0	17.5	17.6	17.4	0
15	QPSK	1	37	17.4	17.5	17.3	
15	QPSK	1	74	17.4	17.5	17.3	
15	QPSK	36	0	17.4	17.4	17.2	0
15	QPSK	36	18	17.3	17.5	17.3	
15	QPSK	36	37	17.4	17.5	17.2	
15	QPSK	75	0	17.4	17.4	17.3	0
15	16QAM	1	0	17.4	17.5	17.3	
15	16QAM	1	37	17.3	17.4	17.2	
15	16QAM	1	74	17.3	17.4	17.2	0
15	16QAM	36	0	17.3	17.4	17.1	
15	16QAM	36	18	17.2	17.3	17.2	
15	16QAM	36	37	17.3	17.4	17.1	0
15	16QAM	75	0	17.3	17.3	17.0	
Channel				20000	20175	20350	
Frequency (MHz)				1715	1732.5	1750	
10	QPSK	1	0	17.4	17.5	17.3	0
10	QPSK	1	24	17.3	17.4	17.2	
10	QPSK	1	49	17.3	17.4	17.2	
10	QPSK	25	0	17.2	17.4	17.1	0
10	QPSK	25	12	17.3	17.3	17.2	
10	QPSK	25	24	17.2	17.4	17.1	
10	QPSK	50	0	17.3	17.4	17.2	0
10	16QAM	1	0	17.3	17.4	17.3	
10	16QAM	1	24	17.2	17.3	17.2	
10	16QAM	1	49	17.2	17.3	17.2	0
10	16QAM	25	0	17.1	17.3	17.1	
10	16QAM	25	12	17.2	17.2	17.2	
10	16QAM	25	24	17.2	17.3	17.1	0
10	16QAM	50	0	17.2	17.2	17.2	
10	16QAM	50	0	17.2	17.2	17.2	

Channel				19975	20175	20375	MPR (dB)
Frequency (MHz)				1712.5	1732.5	1752.5	
5	QPSK	1	0	17.3	17.4	17.3	0
5	QPSK	1	12	17.2	17.3	17.2	
5	QPSK	1	24	17.2	17.3	17.2	
5	QPSK	12	0	17.2	17.2	17.2	0
5	QPSK	12	6	17.1	17.3	17.1	
5	QPSK	12	11	17.2	17.2	17.2	
5	QPSK	25	0	17.2	17.3	17.1	
5	16QAM	1	0	17.3	17.3	17.3	0
5	16QAM	1	12	17.2	17.2	17.2	
5	16QAM	1	24	17.2	17.2	17.2	
5	16QAM	12	0	17.1	17.2	17.1	0
5	16QAM	12	6	17.2	17.1	17.2	
5	16QAM	12	11	17.2	17.2	17.1	
5	16QAM	25	0	17.2	17.1	17.2	
Channel				19965	20175	20385	MPR (dB)
Frequency (MHz)				1711.5	1732.5	1753.5	
3	QPSK	1	0	17.3	17.4	17.2	0
3	QPSK	1	7	17.2	17.3	17.1	
3	QPSK	1	14	17.2	17.3	17.0	
3	QPSK	8	0	17.1	17.2	17.1	0
3	QPSK	8	4	17.2	17.3	17.0	
3	QPSK	8	7	17.1	17.2	16.9	
3	QPSK	15	0	17.1	17.3	17.0	
3	16QAM	1	0	17.2	17.3	17.1	0
3	16QAM	1	7	17.1	17.2	17.0	
3	16QAM	1	14	17.1	17.2	17.0	
3	16QAM	8	0	17.1	17.1	17.0	0
3	16QAM	8	4	17.0	17.1	16.9	
3	16QAM	8	7	17.0	17.2	16.8	
3	16QAM	15	0	17.0	17.1	16.9	
Channel				19957	20175	20393	MPR (dB)
Frequency (MHz)				1710.7	1732.5	1754.3	
1.4	QPSK	1	0	17.2	17.3	17.1	0
1.4	QPSK	1	2	17.1	17.2	17.0	
1.4	QPSK	1	5	17.1	17.2	17.0	
1.4	QPSK	3	0	17.0	17.2	16.9	
1.4	QPSK	3	1	17.0	17.2	16.9	
1.4	QPSK	3	2	17.1	17.1	16.8	
1.4	QPSK	6	0	17.0	17.2	17.0	0
1.4	16QAM	1	0	17.1	17.2	17.0	0
1.4	16QAM	1	2	17.0	17.1	16.9	
1.4	16QAM	1	5	17.0	17.1	16.9	
1.4	16QAM	3	0	17.0	17.1	16.8	
1.4	16QAM	3	1	16.9	17.0	16.8	
1.4	16QAM	3	2	16.8	17.0	16.9	
1.4	16QAM	6	0	16.8	17.0	16.9	0

<WLAN 2.4GHz Conducted Power>

General Note:

1. Per KDB 248227 D01 v01r02, choose the highest output power channel to test SAR and determine further SAR exclusion
2. For each frequency band, testing at higher data rates and higher order modulations is not required when the maximum average output power for each of these configurations is less than 1/4dB higher than those measured at the lowest data rate
3. Apply the test exclusion rule in KDB 248227 D01 v01r02 11g, 11n-HT20 output power is less than 1/4dB higher than 11b mode, thus the SAR can be excluded.
4. The measured power of antenna 1 and antenna 2 is summed to a total power.

<Total power of Antenna 1+2>

WLAN 2.4GHz 802.11b Average Power (dBm)					
Power vs. Channel			Power vs. Data Rate		
Channel	Frequency (MHz)	Data Rate	2Mbps	5.5Mbps	11Mbps
		1Mbps			
CH 1	2412	19.0	18.9	18.8	18.8
CH 6	2437	18.9			
CH 11	2462	18.9			

WLAN 2.4GHz 802.11g Average Power (dBm)									
Power vs. Channel			Power vs. Data Rate						
Channel	Frequency (MHz)	Data Rate	9Mbps	12Mbps	18Mbps	24Mbps	36Mbps	48Mbps	54Mbps
		6Mbps							
CH 01	2412	13.4	17.8	17.8	17.7	14.6	14.7	14.6	14.4
CH 02	2417	15.3							
CH 06	2437	17.9							
CH 10	2457	16.1							
CH 11	2462	12.9							

WLAN 2.4GHz 802.11n-HT20 Average Power (dBm)									
Power vs. Channel			Power vs. MCS Index						
Channel	Frequency (MHz)	MCS Index	MCS1	MCS2	MCS3	MCS4	MCS5	MCS6	MCS7
		MCS0							
CH 01	2412	8.8	17.7	17.4	15.7	15.5	15.4	14.3	14.0
CH 02	2417	15.4							
CH 06	2437	17.8							
CH 10	2457	16.4							
CH 11	2462	9.4							

<Antenna 1>

WLAN 2.4GHz 802.11b Average Power (dBm)					
Power vs. Channel			Power vs. Data Rate		
Channel	Frequency (MHz)	Data Rate	2Mbps	5.5Mbps	11Mbps
		1Mbps			
CH 1	2412	16.0	15.9	15.8	15.8
CH 6	2437	15.8			
CH 11	2462	16.0			

WLAN 2.4GHz 802.11g Average Power (dBm)									
Power vs. Channel			Power vs. Data Rate						
Channel	Frequency (MHz)	Data Rate	9Mbps	12Mbps	18Mbps	24Mbps	36Mbps	48Mbps	54Mbps
		6Mbps							
CH 01	2412	10.2	14.8	14.8	14.8	11.6	11.8	11.6	11.4
CH 02	2417	12.2							
CH 06	2437	15.0							
CH 10	2457	13.5							
CH 11	2462	9.8							

WLAN 2.4GHz 802.11n-HT20 Average Power (dBm)									
Power vs. Channel			Power vs. MCS Index						
Channel	Frequency (MHz)	MCS Index	MCS1	MCS2	MCS3	MCS4	MCS5	MCS6	MCS7
		MCS0							
CH 01	2412	5.9	14.9	14.9	11.6	11.8	11.9	11.0	11.0
CH 02	2417	12.3							
CH 06	2437	15.0							
CH 10	2457	14.0							
CH 11	2462	6.5							

<Antenna 2>

WLAN 2.4GHz 802.11b Average Power (dBm)					
Power vs. Channel			Power vs. Data Rate		
Channel	Frequency (MHz)	Data Rate	2Mbps	5.5Mbps	11Mbps
		1Mbps			
CH 1	2412	16.0	15.8	15.7	15.7
CH 6	2437	15.9			
CH 11	2462	15.7			

WLAN 2.4GHz 802.11g Average Power (dBm)									
Power vs. Channel			Power vs. Data Rate						
Channel	Frequency (MHz)	Data Rate	9Mbps	12Mbps	18Mbps	24Mbps	36Mbps	48Mbps	54Mbps
		6Mbps							
CH 01	2412	10.6	14.8	14.8	14.6	11.6	11.5	11.6	11.3
CH 02	2417	12.3							
CH 06	2437	14.8							
CH 10	2457	12.6							
CH 11	2462	9.9							

WLAN 2.4GHz 802.11n-HT20 Average Power (dBm)									
Power vs. Channel			Power vs. MCS Index						
Channel	Frequency (MHz)	MCS Index	MCS1	MCS2	MCS3	MCS4	MCS5	MCS6	MCS7
		MCS0							
CH 01	2412	5.6	14.4	13.8	13.6	13.0	12.8	11.6	10.9
CH 02	2417	12.4							
CH 06	2437	14.5							
CH 10	2457	12.6							
CH 11	2462	6.2							

<WLAN 5GHz Conducted Power>

General Note:

1. Per KDB 248227 D01 v01r02, choose the highest output power channel to test SAR and determine further SAR exclusion
2. For each frequency band, testing at higher data rates and higher order modulations is not required when the maximum average output power for each of these configurations is less than 1/4dB higher than those measured at the lowest data rate
3. Apply the test exclusion rule in KDB 248227 D01 v01r02 11n-HT20 and 11n-HT40 output power is less than 1/4dB higher than 11a mode, thus the SAR can be excluded.
4. The measured power of antenna 1 and antenna 2 is summed to a total power.

<Total power of Antenna 1+2>

WLAN 5GHz 802.11a Average Power (dBm)									
Power vs. Channel			Power vs. Data Rate						
Channel	Frequency (MHz)	Data Rate 6Mbps	9Mbps	12Mbps	18Mbps	24Mbps	36Mbps	48Mbps	54Mbps
CH 36	5180	15.1	14.9	14.9	14.9	14.9	14.9	14.9	14.9
CH 40	5200	15.1							
CH 44	5220	15.0							
CH 48	5240	15.0							
CH 52	5260	14.3	14.0	14.1	14.2	14.1	14.1	14.0	14.0
CH 56	5280	14.3							
CH 60	5300	14.3							
CH 64	5320	14.3							
CH 100	5500	14.7							
CH 104	5520	14.8	14.7	14.6	14.5	14.5	14.7	14.6	14.6
CH 108	5540	14.2							
CH 112	5560	14.6							
CH 116	5580	14.8							
CH 132	5660	14.6							
CH 136	5680	14.8							
CH 140	5700	14.7							
CH 144	5720	14.6	15.7	15.9	15.9	12.4	12.6	12.5	12.4
CH 149	5745	16.0							
CH 153	5765	16.0							
CH 157	5785	16.0							
CH 161	5805	16.0							
CH 165	5825	15.9							

WLAN 5GHz 802.11n-HT20 Average Power (dBm)									
Power vs. Channel			Power vs. MCS Index						
Channel	Frequency (MHz)	MCS Index MCS0	MCS1	MCS2	MCS3	MCS4	MCS5	MCS6	MCS7
CH 36	5180	15.1	15.0	15.0	14.9	14.9	14.9	14.9	14.9
CH 40	5200	14.9							
CH 44	5220	14.9							
CH 48	5240	15.1							
CH 52	5260	14.3	14.1	14.1	14.1	14.1	14.1	14.0	14.1
CH 56	5280	14.1							
CH 60	5300	14.2							
CH 64	5320	14.1							
CH 100	5500	14.8							
CH 104	5520	14.6	14.4	14.4	14.5	14.7	14.5	14.6	14.7
CH 108	5540	14.3							
CH 112	5560	14.4							
CH 116	5580	14.4							
CH 132	5660	14.6							
CH 136	5680	14.6							
CH 140	5700	14.7							
CH 144	5720	14.5	15.8	15.8	15.0	13.7	13.6	12.4	12.4
CH 149	5745	16.0							
CH 153	5765	15.9							
CH 157	5785	16.0							
CH 161	5805	16.0							
CH 165	5825	15.7							

WLAN 5GHz 802.11n-HT40 Average Power (dBm)									
Power vs. Channel			Power vs. MCS Index						
Channel	Frequency (MHz)	MCS Index MCS0	MCS1	MCS2	MCS3	MCS4	MCS5	MCS6	MCS7
CH 38	5190	15.6	15.7	15.7	13.9	14.4	14.5	14.5	14.6
CH 46	5230	15.9							
CH 54	5270	14.0	13.9	13.8	13.1	13.3	13.4	13.3	13.2
CH 62	5310	14.0							
CH 102	5510	14.5							
CH 110	5550	14.6	14.4	14.4	13.6	13.6	13.6	13.6	13.7
CH 134	5670	14.7							
CH 142	5710	14.5							
CH 151	5755	16.0							
CH 159	5795	16.0	15.9	15.8	12.2	12.3	12.2	12.2	12.2

<Antenna 1>

WLAN 5GHz 802.11a Average Power (dBm)									
Power vs. Channel			Power vs. Data Rate						
Channel	Frequency (MHz)	Data Rate	9Mbps	12Mbps	18Mbps	24Mbps	36Mbps	48Mbps	54Mbps
		6Mbps							
CH 36	5180	13.0	12.7	12.8	12.8	12.7	12.7	12.6	12.7
CH 40	5200	13.0							
CH 44	5220	13.0							
CH 48	5240	13.0							
CH 52	5260	13.0	12.7	12.8	12.9	12.8	12.8	12.7	12.7
CH 56	5280	13.0							
CH 60	5300	13.0							
CH 64	5320	13.0							
CH 100	5500	12.9	13.0	12.8	12.7	12.8	12.9	12.8	12.8
CH 104	5520	13.0							
CH 108	5540	12.5							
CH 112	5560	12.9							
CH 116	5580	13.0							
CH 132	5660	12.9							
CH 136	5680	13.0							
CH 140	5700	12.9							
CH 144	5720	12.8							
CH 149	5745	13.0							
CH 153	5765	13.0							
CH 157	5785	13.0							
CH 161	5805	13.0							
CH 165	5825	13.0							

WLAN 5GHz 802.11n-HT20 Average Power (dBm)									
Power vs. Channel			Power vs. MCS Index						
Channel	Frequency (MHz)	MCS Index	MCS1	MCS2	MCS3	MCS4	MCS5	MCS6	MCS7
		MCS0							
CH 36	5180	13.0	12.8	12.9	12.7	12.8	12.7	12.7	12.7
CH 40	5200	12.7							
CH 44	5220	12.8							
CH 48	5240	13.0							
CH 52	5260	13.0	12.8	12.8	12.8	12.8	12.7	12.7	12.7
CH 56	5280	12.8							
CH 60	5300	13.0							
CH 64	5320	12.8							
CH 100	5500	13.0	12.7	12.6	12.8	12.9	12.7	12.8	12.9
CH 104	5520	12.7							
CH 108	5540	12.7							
CH 112	5560	12.8							
CH 116	5580	12.7							
CH 132	5660	13.0							
CH 136	5680	12.8							
CH 140	5700	13.0							
CH 144	5720	12.7							
CH 149	5745	12.9							
CH 153	5765	12.8							
CH 157	5785	12.9							
CH 161	5805	13.0							
CH 165	5825	12.8							

WLAN 5GHz 802.11n-HT40 Average Power (dBm)									
Power vs. Channel			Power vs. MCS Index						
Channel	Frequency (MHz)	MCS Index	MCS1	MCS2	MCS3	MCS4	MCS5	MCS6	MCS7
		MCS0							
CH 38	5190	12.4	12.7	12.6	11.6	11.8	11.8	11.8	11.8
CH 46	5230	12.9							
CH 54	5270	12.6	12.4	12.5	11.4	11.7	11.8	11.7	11.9
CH 62	5310	12.7							
CH 102	5510	12.8	12.7	12.6	11.8	11.8	11.7	11.8	11.8
CH 110	5550	12.8							
CH 134	5670	13.0							
CH 142	5710	12.8							
CH 151	5755	12.9							
CH 159	5795	12.9	12.8	12.8	8.8	8.9	8.8	8.8	8.9

<Antenna 2>

WLAN 5GHz 802.11a Average Power (dBm)									
Power vs. Channel			Power vs. Data Rate						
Channel	Frequency (MHz)	Data Rate	9Mbps	12Mbps	18Mbps	24Mbps	36Mbps	48Mbps	54Mbps
		6Mbps							
CH 36	5180	11.0	10.8	10.8	10.7	10.8	11.0	11.0	11.0
CH 40	5200	11.0							
CH 44	5220	10.7							
CH 48	5240	10.7							
CH 52	5260	8.5	8.3	8.4	8.3	8.3	8.2	8.2	8.3
CH 56	5280	8.5							
CH 60	5300	8.5							
CH 64	5320	8.3							
CH 100	5500	10.0	9.8	9.9	9.9	9.7	10.0	9.8	9.9
CH 104	5520	10.0							
CH 108	5540	9.4							
CH 112	5560	9.6							
CH 116	5580	10.0							
CH 132	5660	9.6							
CH 136	5680	10.0							
CH 140	5700	10.0							
CH 144	5720	10.0							
CH 149	5745	13.0							
CH 153	5765	13.0							
CH 157	5785	12.9							
CH 161	5805	13.0							
CH 165	5825	12.8							

WLAN 5GHz 802.11n-HT20 Average Power (dBm)									
Power vs. Channel			Power vs. MCS Index						
Channel	Frequency (MHz)	MCS Index MCS0	MCS1	MCS2	MCS3	MCS4	MCS5	MCS6	MCS7
CH 36	5180	11.0	11.0	10.8	10.8	10.8	10.9	11.0	10.9
CH 40	5200	11.0							
CH 44	5220	10.8							
CH 48	5240	10.9							
CH 52	5260	8.5	8.4	8.3	8.2	8.2	8.3	8.3	8.5
CH 56	5280	8.1							
CH 60	5300	8.0							
CH 64	5320	8.2							
CH 100	5500	10.0							
CH 104	5520	10.0	9.6	9.7	9.6	9.9	9.7	10.0	9.8
CH 108	5540	9.3							
CH 112	5560	9.3							
CH 116	5580	9.5							
CH 132	5660	9.4							
CH 136	5680	9.9							
CH 140	5700	9.8							
CH 144	5720	9.7							
CH 149	5745	13.0	12.7	12.7	12.8	10.6	10.4	9.2	9.3
CH 153	5765	13.0							
CH 157	5785	13.0							
CH 161	5805	13.0							
CH 165	5825	12.6							

WLAN 5GHz 802.11n-HT40 Average Power (dBm)									
Power vs. Channel			Power vs. MCS Index						
Channel	Frequency (MHz)	MCS Index MCS0	MCS1	MCS2	MCS3	MCS4	MCS5	MCS6	MCS7
CH 38	5190	12.7	12.7	12.7	10.0	11.0	11.1	11.2	11.3
CH 46	5230	12.8							
CH 54	5270	8.5	8.3	8.0	8.2	8.2	8.2	8.2	7.6
CH 62	5310	8.0							
CH 102	5510	9.7							
CH 110	5550	9.8	9.5	9.6	8.9	9.0	9.1	8.9	9.2
CH 134	5670	9.9							
CH 142	5710	9.6							
CH 151	5755	13.0							
CH 159	5795	13.0	12.9	12.8	9.6	9.6	9.5	9.5	9.5

13. Exposure Position Conditions

<Distance from the antenna to the edge>

General Note:

- The detail antenna locations please refer to setup photo.
- This device overall diagonal dimension is 272mm, and according to KDB 616217 D04v01r01, if the diagonal is greater than 200mm, SAR evaluation for the front surface of tablet display screens are generally not necessary.

Exposure Position	Bottom Face	Edge1	Edge2	Edge3	Edge4
WLAN Antenna1 to the Edge distance (mm)	< 5 mm	< 5 mm	163 mm	138 mm	49 mm
WLAN Antenna2 to the Edge distance (mm)	< 5 mm	116 mm	216 mm	21 mm	< 5 mm
WWAN Antenna to the Edge distance (mm)	< 5 mm	28 mm	< 5 mm	43 mm	216.4 mm

<SAR test exclusion table>

General Note:

- Maximum power is the source-based time-average power and represents the maximum RF output power among production units
- Per KDB 447498 D01v05r01, for larger devices, the test separation distance of adjacent edge configuration is determined by the closest separation between the antenna and the user.
- Per KDB 447498 D01v05r01, standalone SAR test exclusion threshold is applied; If the distance of the antenna to the user is < 5mm, 5mm is used to determine SAR exclusion threshold.
- Per KDB 447498 D01v05r01, the 1-g and 10-g SAR test exclusion thresholds for 100 MHz to 6 GHz at *test separation distances* ≤ 50 mm are determined by:
 - [(max. power of channel, including tune-up tolerance, mW)/(min. test separation distance, mm)] · [√f(GHz)] ≤ 3.0 for 1-g SAR and ≤ 7.5 for 10-g extremity SAR
 - f(GHz) is the RF channel transmit frequency in GHz
 - Power and distance are rounded to the nearest mW and mm before calculation
 - The result is rounded to one decimal place for comparison
 - For < 50 mm distance, we just calculate mW of the exclusion threshold value (3.0) to do compare. This formula is [3.0] / [√f(GHz)] · [(min. test separation distance, mm)] = exclusion threshold of mW.
- Per KDB 447498 D01v05r01, at 100 MHz to 6 GHz and for *test separation distances* > 50 mm, the SAR test exclusion threshold is determined according to the following
 - [Threshold at 50 mm in step 1) + (test separation distance - 50 mm) · (f(MHz)/150)] mW, at 100 MHz to 1500 MHz
 - [Threshold at 50 mm in step 1) + (test separation distance - 50 mm) · 10] mW at > 1500 MHz and ≤ 6 GHz

Exposure Position	Wireless Interface	GPRS 850 Class 10	GPRS 1900 Class 10	WCDMA Band V	WCDMA Band II	LTE Band 17	LTE Band 4	802.11b Ant 1	802.11b Ant 2	802.11a Ant 1	802.11a Ant 2
		Maximum power	26	23.5	24	24	23.5	24.5	16	16	13
	Maximum rated power(mW)	398.11	223.87	251.19	251.19	223.87	281.84	39.81	39.81	19.95	19.95
Bottom Face	Antenna to user (mm)	5						5	5	5	5
	SAR exclusion threshold	73.32	61.86	46.21	69.38	37.81	74.65	12.49	12.49	9.63	9.63
	SAR testing required?	Yes	Yes	Yes	Yes	Yes	Yes	Yes	Yes	Yes	Yes
Edge 1	Antenna to user (mm)	28						5	116	5	116
	SAR exclusion threshold	13.09	11.05	8.25	12.39	6.75	13.33	12.49	755.6	9.63	722.15
	SAR testing required?	Yes	Yes	Yes	Yes	Yes	Yes	Yes	No	Yes	No
Edge 2	Antenna to user (mm)	5						163	216	163	216
	SAR exclusion threshold	73.32	61.86	46.21	69.38	37.81	74.65	1225.6	1755.6	1192.15	1722.15
	SAR testing required?	Yes	Yes	Yes	Yes	Yes	Yes	No	No	No	No
Edge 3	Antenna to user (mm)	43						138	21	138	21
	SAR exclusion threshold	8.53	7.19	5.37	8.07	4.4	8.68	975.6	2.97	942.15	2.29
	SAR testing required?	Yes	Yes	Yes	Yes	Yes	Yes	No	No	No	No
Edge 4	Antenna to user (mm)	216.4						49	5	49	5
	SAR exclusion threshold	1103.60	1772.56	1101.58	1772.62	968.6	1777.26	1.27	12.49	0.98	9.63
	SAR testing required?	No	No	No	No	No	No	No	Yes	No	Yes

14. SAR Test Results

General Note:

1. Per KDB 447498 D01v05r01, the reported SAR is the measured SAR value adjusted for maximum tune-up tolerance.
 - a. Tune-up scaling Factor = tune-up limit power (mW) / EUT RF power (mW), where tune-up limit is the maximum rated power among all production units.
 - b. For WWAN/WLAN: Reported SAR(W/kg)= Measured SAR(W/kg)*Tune-up Scaling Factor
2. Per KDB 447498 D01v05r01, for each exposure position, testing of other required channels within the operating mode of a frequency band is not required when the reported 1-g or 10-g SAR for the mid-band or highest output power channel is:
 - ≤ 0.8 W/kg or 2.0 W/kg, for 1-g or 10-g respectively, when the transmission band is ≤ 100 MHz
 - ≤ 0.6 W/kg or 1.5 W/kg, for 1-g or 10-g respectively, when the transmission band is between 100 MHz and 200 MHz
 - ≤ 0.4 W/kg or 1.0 W/kg, for 1-g or 10-g respectively, when the transmission band is ≥ 200 MHz
3. During the SAR testing, the additional separation between EUT and the phantom surface introduced by the protrusion is <5 mm, and the reported SAR with the protrusions in place is < 1.2 W/kg, additional consideration of test setup is not required. Detailed information is included in the test setup photo exhibit.
4. Single antenna RF power in SISO mode is larger or equal to the single antenna RF power in MIMO mode, and for RF exposure assessment of MIMO mode simultaneous transmission exclusion analysis was performed with SAR test results of each antenna in SISO mode.
5. For the exposure positions that proximity sensor power reduction is applied for SAR compliance, additional SAR testing with EUT transmitting full power in normal mode was performed; 13mm for Bottom - Slant of Edge 2, 11mm for Edge 2

GSM Note:

1. Justification for reduced test configuration s per KDB 941225 D03v01, the source-based time-averaged output power was evaluated for all multi-slot operations. The multi-slot configuration with the highest frame averaged output power was evaluated for SAR Measurement.

UMTS Note:

1. Per KDB 941225 D02v02r02, RMC 12.2kbps setting is used to evaluate SAR. If HSDPA/HSUPA output power is < 0.25 dB higher than RMC12.2Kbps, or reported SAR with RMC 12.2kbps setting is ≤ 1.2 W/kg, HSDPA/HSUPA SAR evaluation can be excluded.

LTE Note:

1. Per KDB 941225 D05v02r02, when reported SAR of 1RB and 50%RB allocation for QPSK ≤ 0.8 W/kg, and 100%RB with QPSK output power is less than 1RB and 50%RB, 100%RB allocation for QPSK is not required.
2. Per KDB 941225 D05v02r02, when reported SAR of 1RB and 50%RB allocation for QPSK > 0.8 W/kg for any exposure position, SAR testing of 100%RB allocation for QPSK is performed at the highest power channel.
3. 16QAM output power for each RB allocation configuration is $>$ not $\frac{1}{2}$ dB higher than the same configuration in QPSK and the reported SAR for the QPSK configuration is ≤ 1.45 W/kg; Per KDB 941225 D05v02, 16QAM SAR testing is not required.
4. Smaller bandwidth output power for each RB allocation configuration is $>$ not $\frac{1}{2}$ dB higher than the same configuration in the largest supported bandwidth.

14.1 Body SAR

<GSM SAR>

Plot No.	Band	Mode	Test Position	Gap (cm)	Ch.	Freq. (MHz)	Power Back-off	Average Power (dBm)	Tune-Up Limit (dBm)	Tune-up Scaling Factor	Power Drift (dB)	Measured 1g SAR (W/kg)	Reported 1g SAR (W/kg)
01	GSM850	GPRS (2 Tx slots)	Bottom - Slant of Edge 2	1.3cm	251	848.8	OFF	31.9	32	1.023	-0.11	1.160	1.187
	GSM850	GPRS (2 Tx slots)	Bottom - Slant of Edge 2	1.3cm	128	824.2	OFF	31.7	32	1.072	-0.05	0.968	1.037
	GSM850	GPRS (2 Tx slots)	Bottom - Slant of Edge 2	1.3cm	189	836.4	OFF	31.8	32	1.047	-0.03	1.100	1.152
	GSM850	GPRS (2 Tx slots)	Edge 1	0cm	251	848.8	OFF	31.9	32	1.023	-0.06	0.305	0.312
	GSM850	GPRS (2 Tx slots)	Edge 2	1.1cm	251	848.8	OFF	31.9	32	1.023	-0.11	1.160	1.187
	GSM850	GPRS (2 Tx slots)	Edge 2	1.1cm	128	824.2	OFF	31.7	32	1.072	-0.07	0.977	1.047
	GSM850	GPRS (2 Tx slots)	Edge 2	1.1cm	189	836.4	OFF	31.8	32	1.047	-0.11	1.090	1.141
	GSM850	GPRS (2 Tx slots)	Edge 3	0cm	251	848.8	OFF	31.9	32	1.023	-0.08	0.226	0.231
	GSM850	GPRS (2 Tx slots)	Bottom - Slant of Edge 2	0cm	128	824.2	ON	22.8	23	1.047	0.03	0.711	0.745
	GSM850	GPRS (2 Tx slots)	Bottom - Slant of Edge 2	0cm	189	836.4	ON	22.7	23	1.072	-0.06	0.855	0.916
	GSM850	GPRS (2 Tx slots)	Bottom - Slant of Edge 2	0cm	251	848.8	ON	22.9	23	1.023	-0.09	1.080	1.105
	GSM850	GPRS (2 Tx slots)	Edge 2	0cm	251	848.8	ON	22.9	23	1.023	0	0.627	0.642
	GSM850	GPRS (2 Tx slots)	Bottom Face	0cm	251	848.8	ON	22.9	23	1.023	0.01	0.830	0.849
	GSM850	GPRS (2 Tx slots)	Bottom Face	0cm	128	824.2	ON	22.8	23	1.047	0.01	0.571	0.598
	GSM850	GPRS (2 Tx slots)	Bottom Face	0cm	189	836.4	ON	22.7	23	1.072	-0.03	0.695	0.745
	GSM1900	GPRS (2 Tx slots)	Bottom - Slant of Edge 2	1.3cm	661	1880	OFF	28.9	29	1.023	-0.04	0.256	0.262
	GSM1900	GPRS (2 Tx slots)	Edge 1	0cm	661	1880	OFF	28.9	29	1.023	-0.08	0.156	0.160
	GSM1900	GPRS (2 Tx slots)	Edge 2	1.1cm	661	1880	OFF	28.9	29	1.023	-0.07	0.205	0.210
	GSM1900	GPRS (2 Tx slots)	Edge 3	0cm	661	1880	OFF	28.9	29	1.023	-0.01	0.061	0.062
02	GSM1900	GPRS (2 Tx slots)	Bottom - Slant of Edge 2	0cm	661	1880	ON	24.8	25	1.047	0.18	1.130	1.183
	GSM1900	GPRS (2 Tx slots)	Bottom - Slant of Edge 2	0cm	512	1850.2	ON	24.7	25	1.072	-0.11	1.100	1.179
	GSM1900	GPRS (2 Tx slots)	Bottom - Slant of Edge 2	0cm	810	1909.8	ON	24.8	25	1.047	-0.12	1.130	1.183
	GSM1900	GPRS (2 Tx slots)	Edge 2	0cm	661	1880	ON	24.8	25	1.047	-0.05	0.307	0.321
	GSM1900	GPRS (2 Tx slots)	Bottom Face	0cm	661	1880	ON	24.8	25	1.047	-0.15	1.020	1.068
	GSM1900	GPRS (2 Tx slots)	Bottom Face	0cm	512	1850.2	ON	24.7	25	1.072	-0.16	1.050	1.125
	GSM1900	GPRS (2 Tx slots)	Bottom Face	0cm	810	1909.8	ON	24.8	25	1.047	-0.16	1.090	1.141

<WCDMA SAR>

Plot No.	Band	Mode	Test Position	Gap (cm)	Ch.	Freq. (MHz)	Power Back-off	Average Power (dBm)	Tune-Up Limit (dBm)	Tune-up Scaling Factor	Power Drift (dB)	Measured 1g SAR (W/kg)	Reported 1g SAR (W/kg)
	WCDMA V	RMC12.2Kbps	Bottom - Slant of Edge 2	1.3cm	4233	846.6	OFF	22.8	23.5	1.175	-0.16	0.595	0.699
	WCDMA V	RMC12.2Kbps	Edge 1	0cm	4233	846.6	OFF	22.8	23.5	1.175	-0.14	0.143	0.168
	WCDMA V	RMC12.2Kbps	Edge 2	1.1cm	4233	846.6	OFF	22.8	23.5	1.175	-0.1	0.669	0.786
	WCDMA V	RMC12.2Kbps	Edge 3	0cm	4233	846.6	OFF	22.8	23.5	1.175	-0.08	0.046	0.054
03	WCDMA V	RMC 12.2Kbps	Bottom - Slant of Edge 2	0cm	4132	826.4	ON	17.8	18	1.047	-0.04	1.120	1.173
	WCDMA V	RMC 12.2Kbps	Bottom - Slant of Edge 2	0cm	4182	836.4	ON	17.7	18	1.072	0.05	0.924	0.990
	WCDMA V	RMC 12.2Kbps	Bottom - Slant of Edge 2	0cm	4233	846.6	ON	17.9	18	1.023	-0.02	1.140	1.167
	WCDMA V	RMC12.2Kbps	Edge 2	0cm	4233	846.6	ON	17.9	18	1.023	-0.04	0.711	0.728
	WCDMA V	RMC 12.2Kbps	Bottom Face	0cm	4233	846.6	ON	17.9	18	1.023	0.05	0.976	0.999
	WCDMA V	RMC 12.2Kbps	Bottom Face	0cm	4132	826.4	ON	17.8	18	1.047	-0.04	0.973	1.019
	WCDMA V	RMC 12.2Kbps	Bottom Face	0cm	4182	836.4	ON	17.7	18	1.072	0.03	0.807	0.865
	WCDMA II	RMC 12.2Kbps	Bottom - Slant of Edge 2	1.3cm	9262	1852.4	OFF	23	23.5	1.122	-0.06	0.287	0.322
	WCDMA II	RMC 12.2Kbps	Edge 1	0cm	9262	1852.4	OFF	23	23.5	1.122	-0.05	0.147	0.165
	WCDMA II	RMC12.2Kbps	Edge 2	1.1cm	9262	1852.4	OFF	23	23.5	1.122	-0.01	0.185	0.208
	WCDMA II	RMC 12.2Kbps	Edge 3	0cm	9262	1852.4	OFF	23	23.5	1.122	0.06	0.081	0.091
	WCDMA II	RMC 12.2Kbps	Bottom - Slant of Edge 2	0cm	9262	1852.4	ON	18.4	18.5	1.023	-0.15	1.080	1.105
	WCDMA II	RMC 12.2Kbps	Bottom - Slant of Edge 2	0cm	9400	1880	ON	18.3	18.5	1.047	-0.17	1.000	1.047
04	WCDMA II	RMC 12.2Kbps	Bottom - Slant of Edge 2	0cm	9538	1907.6	ON	18.3	18.5	1.047	-0.12	1.120	1.173
	WCDMA II	RMC 12.2Kbps	Edge 2	0cm	9262	1852.4	ON	18.4	18.5	1.023	-0.18	0.328	0.336
	WCDMA II	RMC12.2Kbps	Bottom Face	0cm	9262	1852.4	ON	18.4	18.5	1.023	-0.16	1.030	1.054
	WCDMA II	RMC12.2Kbps	Bottom Face	0cm	9400	1880	ON	18.3	18.5	1.047	-0.13	1.110	1.162
	WCDMA II	RMC12.2Kbps	Bottom Face	0cm	9538	1907.6	ON	18.3	18.5	1.047	-0.11	1.050	1.099

<LTE SAR>

Plot No.	Band	BW (MHz)	Mode	RB Size	RB offset	Test Position	Gap (cm)	Ch.	Freq. (MHz)	Power Back-off	Average Power (dBm)	Tune-Up Limit (dBm)	Tune-up Scaling Factor	Power Drift (dB)	Measured 1g SAR (W/kg)	Reported 1g SAR (W/kg)
	LTE Band 17	10M	QPSK	1	0	Bottom - Slant of Edge 2	1.3cm	23790	710	OFF	23.2	23.5	1.072	0	0.552	0.591
	LTE Band 17	10M	QPSK	25	0	Bottom - Slant of Edge 2	1.3cm	23780	709	OFF	22.2	22.5	1.072	0.04	0.465	0.498
	LTE Band 17	10M	QPSK	1	0	Edge 1	0cm	23790	710	OFF	23.2	23.5	1.072	0.12	0.175	0.188
	LTE Band 17	10M	QPSK	25	0	Edge 1	0cm	23780	709	OFF	22.2	22.5	1.072	0.07	0.171	0.183
	LTE Band 17	10M	QPSK	1	0	Edge 2	1.1cm	23790	710	OFF	23.2	23.5	1.072	-0.03	0.410	0.439
	LTE Band 17	10M	QPSK	25	0	Edge 2	1.1cm	23780	709	OFF	22.2	22.5	1.072	-0.04	0.401	0.430
	LTE Band 17	10M	QPSK	1	0	Edge 3	0cm	23790	710	OFF	23.2	23.5	1.072	-0.01	0.076	0.081
	LTE Band 17	10M	QPSK	25	0	Edge 3	0cm	23780	709	OFF	22.2	22.5	1.072	-0.07	0.077	0.083
	LTE Band 17	10M	QPSK	1	0	Bottom - Slant of Edge 2	0cm	23790	710	ON	18.4	18.5	1.023	-0.08	1.010	1.034
	LTE Band 17	10M	QPSK	1	0	Bottom - Slant of Edge 2	0cm	23780	709	ON	18.1	18.5	1.096	-0.03	0.917	1.005
	LTE Band 17	10M	QPSK	1	0	Bottom - Slant of Edge 2	0cm	23800	711	ON	18.2	18.5	1.072	-0.17	1.080	1.157
	LTE Band 17	10M	QPSK	25	0	Bottom - Slant of Edge 2	0cm	23790	710	ON	18.4	18.5	1.023	-0.07	1.100	1.126
	LTE Band 17	10M	QPSK	25	0	Bottom - Slant of Edge 2	0cm	23780	709	ON	17.9	18.5	1.148	-0.09	1.030	1.183
	LTE Band 17	10M	QPSK	25	0	Bottom - Slant of Edge 2	0cm	23800	711	ON	18.3	18.5	1.047	-0.05	1.130	1.183
05	LTE Band 17	10M	QPSK	50	0	Bottom - Slant of Edge 2	0cm	23800	711	ON	18.1	18.5	1.096	-0.07	1.080	1.184
	LTE Band 17	10M	QPSK	1	0	Edge 2	0cm	23790	710	ON	18.4	18.5	1.023	-0.01	0.791	0.809
	LTE Band 17	10M	QPSK	1	0	Edge 2	0cm	23780	709	ON	18.1	18.5	1.096	-0.04	0.735	0.806
	LTE Band 17	10M	QPSK	1	0	Edge 2	0cm	23800	711	ON	18.2	18.5	1.072	-0.04	0.859	0.920
	LTE Band 17	10M	QPSK	25	0	Edge 2	0cm	23790	710	ON	18.4	18.5	1.023	-0.07	0.816	0.835
	LTE Band 17	10M	QPSK	25	0	Edge 2	0cm	23780	709	ON	17.9	18.5	1.148	0.01	0.831	0.954
	LTE Band 17	10M	QPSK	25	0	Edge 2	0cm	23800	711	ON	18.3	18.5	1.047	-0.05	0.900	0.942
	LTE Band 17	10M	QPSK	50	0	Edge 2	0cm	23800	711	ON	18.1	18.5	1.096	-0.03	0.829	0.909
	LTE Band 17	10M	QPSK	1	0	Bottom Face	0cm	23790	710	ON	18.4	18.5	1.023	-0.04	0.858	0.878
	LTE Band 17	10M	QPSK	1	0	Bottom Face	0cm	23780	709	ON	18.1	18.5	1.096	-0.01	0.804	0.882
	LTE Band 17	10M	QPSK	1	0	Bottom Face	0cm	23800	711	ON	18.2	18.5	1.072	-0.06	0.946	1.014
	LTE Band 17	10M	QPSK	25	0	Bottom Face	0cm	23790	710	ON	18.4	18.5	1.023	-0.14	0.977	1.000
	LTE Band 17	10M	QPSK	25	0	Bottom Face	0cm	23780	709	ON	17.9	18.5	1.148	-0.15	0.927	1.064
	LTE Band 17	10M	QPSK	25	0	Bottom Face	0cm	23800	711	ON	18.3	18.5	1.047	-0.11	1.030	1.079
	LTE Band 17	10M	QPSK	50	0	Bottom Face	0cm	23800	711	ON	18.1	18.5	1.096	-0.17	0.978	1.072

Plot No.	Band	BW (MHz)	Mode	RB Size	RB offset	Test Position	Gap (cm)	Ch.	Freq. (MHz)	Power Back-off	Average Power (dBm)	Tune-Up Limit (dBm)	Tune-up Scaling Factor	Power Drift (dB)	Measured 1g SAR (W/kg)	Reported 1g SAR (W/kg)
	LTE Band 4	20M	QPSK	1	0	Bottom - Slant of Edge 2	1.3cm	20175	1732.5	OFF	24.4	24.5	1.023	-0.1	0.603	0.617
	LTE Band 4	20M	QPSK	50	0	Bottom - Slant of Edge 2	1.3cm	20175	1732.5	OFF	23.4	23.5	1.023	-0.02	0.478	0.489
	LTE Band 4	20M	QPSK	1	0	Edge 1	0cm	20175	1732.5	OFF	24.4	24.5	1.023	-0.17	0.262	0.268
	LTE Band 4	20M	QPSK	50	0	Edge 1	0cm	20175	1732.5	OFF	23.4	23.5	1.023	-0.06	0.217	0.222
	LTE Band 4	20M	QPSK	1	0	Edge 2	1.1cm	20175	1732.5	OFF	24.4	24.5	1.023	-0.14	0.262	0.268
	LTE Band 4	20M	QPSK	50	0	Edge 2	1.1cm	20175	1732.5	OFF	23.4	23.5	1.023	-0.1	0.216	0.221
	LTE Band 4	20M	QPSK	1	0	Edge 3	0cm	20175	1732.5	OFF	24.4	24.5	1.023	0.13	0.124	0.127
	LTE Band 4	20M	QPSK	50	0	Edge 3	0cm	20175	1732.5	OFF	23.4	23.5	1.023	-0.13	0.105	0.107
	LTE Band 4	20M	QPSK	1	0	Bottom - Slant of Edge 2	0cm	20175	1732.5	ON	17.7	18.5	1.202	-0.03	0.771	0.927
	LTE Band 4	20M	QPSK	1	0	Bottom - Slant of Edge 2	0cm	20050	1720	ON	17.6	18.5	1.230	-0.01	0.761	0.936
	LTE Band 4	20M	QPSK	1	0	Bottom - Slant of Edge 2	0cm	20300	1745	ON	17.6	18.5	1.230	-0.02	0.811	0.998
	LTE Band 4	20M	QPSK	50	0	Bottom - Slant of Edge 2	0cm	20175	1732.5	ON	17.6	18.5	1.230	0.02	0.761	0.936
	LTE Band 4	20M	QPSK	50	0	Bottom - Slant of Edge 2	0cm	20050	1720	ON	17.5	18.5	1.259	0.02	0.766	0.964
06	LTE Band 4	20M	QPSK	50	0	Bottom - Slant of Edge 2	0cm	20300	1745	ON	17.5	18.5	1.259	0	0.831	1.046
	LTE Band 4	20M	QPSK	100	0	Bottom - Slant of Edge 2	0cm	20050	1720	ON	17.5	18.5	1.259	0	0.749	0.943
	LTE Band 4	20M	QPSK	1	0	Edge 2	0cm	20175	1732.5	ON	17.7	18.5	1.202	0.15	0.208	0.250
	LTE Band 4	20M	QPSK	50	0	Edge 2	0cm	20175	1732.5	ON	17.6	18.5	1.230	0.15	0.221	0.272
	LTE Band 4	20M	QPSK	1	0	Bottom Face	0cm	20175	1732.5	ON	17.7	18.5	1.202	0.09	0.727	0.874
	LTE Band 4	20M	QPSK	1	0	Bottom Face	0cm	20050	1720	ON	17.6	18.5	1.230	0.05	0.752	0.925
	LTE Band 4	20M	QPSK	1	0	Bottom Face	0cm	20300	1745	ON	17.6	18.5	1.230	0.1	0.820	1.009
	LTE Band 4	20M	QPSK	50	0	Bottom Face	0cm	20175	1732.5	ON	17.6	18.5	1.230	0.01	0.830	1.021
	LTE Band 4	20M	QPSK	50	0	Bottom Face	0cm	20050	1720	ON	17.5	18.5	1.259	0.09	0.754	0.949
	LTE Band 4	20M	QPSK	50	0	Bottom Face	0cm	20300	1745	ON	17.5	18.5	1.259	0.12	0.802	1.010
	LTE Band 4	20M	QPSK	100	0	Bottom Face	0cm	20050	1720	ON	17.5	18.5	1.259	0.08	0.753	0.948

<WLAN SAR-DTS>

Plot No.	Band	Mode	Test Position	Gap (cm)	Antenna	Ch.	Freq. (MHz)	Average Power (dBm)	Tune-Up Limit (dBm)	Tune-up Scaling Factor	Power Drift (dB)	Measured 1g SAR (W/kg)	Reported 1g SAR (W/kg)
	WLAN2.4GHz	802.11b 1Mbps	Bottom Face	0cm	Ant 1	1	2412	16.0	16	1.000	0.02	1.150	1.150
	WLAN2.4GHz	802.11b 1Mbps	Bottom Face	0cm	Ant 1	6	2437	15.8	16	1.047	0.11	0.937	0.981
	WLAN2.4GHz	802.11b 1Mbps	Bottom Face	0cm	Ant 1	11	2462	16.0	16	1.000	-0.13	1.080	1.080
07	WLAN2.4GHz	802.11b 1Mbps	Bottom - Slant of Edge 1	0cm	Ant 1	1	2412	16.0	16	1.000	0.05	1.190	1.190
	WLAN2.4GHz	802.11b 1Mbps	Bottom - Slant of Edge 1	0cm	Ant 1	6	2437	15.8	16	1.047	0.12	0.958	1.003
	WLAN2.4GHz	802.11b 1Mbps	Bottom - Slant of Edge 1	0cm	Ant 1	11	2462	16.0	16	1.000	0.06	1.180	1.180
	WLAN2.4GHz	802.11b 1Mbps	Edge 1	0cm	Ant 1	1	2412	16.0	16	1.000	0.03	0.843	0.843
	WLAN2.4GHz	802.11b 1Mbps	Edge 1	0cm	Ant 1	6	2437	15.8	16	1.047	0.19	0.662	0.693
	WLAN2.4GHz	802.11b 1Mbps	Edge 1	0cm	Ant 1	11	2462	16.0	16	1.000	0.01	0.857	0.857
	WLAN5GHz	802.11a 6Mbps	Bottom Face	0cm	Ant 1	161	5805	13.0	13	1.000	-0.01	0.535	0.535
	WLAN5GHz	802.11a 6Mbps	Bottom - Slant of Edge 1	0cm	Ant 1	161	5805	13.0	13	1.000	-0.09	0.637	0.637
	WLAN5GHz	802.11a 6Mbps	Bottom - Slant of Edge 1	0cm	Ant 1	153	5765	13.0	13	1.000	-0.07	0.675	0.675
	WLAN5GHz	802.11a 6Mbps	Bottom - Slant of Edge 1	0cm	Ant 1	157	5785	13.0	13	1.000	-0.14	0.647	0.647
	WLAN5GHz	802.11a 6Mbps	Edge 1	0cm	Ant 1	161	5805	13.0	13	1.000	0.03	0.116	0.116

Plot No.	Band	Mode	Test Position	Gap (cm)	Antenna	Ch.	Freq. (MHz)	Average Power (dBm)	Tune-Up Limit (dBm)	Tune-up Scaling Factor	Power Drift (dB)	Measured 1g SAR (W/kg)	Reported 1g SAR (W/kg)
	WLAN2.4GHz	802.11b 1Mbps	Bottom Face	0cm	Ant 2	1	2412	16.0	16	1.000	-0.05	0.999	0.999
	WLAN2.4GHz	802.11b 1Mbps	Bottom Face	0cm	Ant 2	6	2437	15.9	16	1.023	0.12	0.939	0.961
	WLAN2.4GHz	802.11b 1Mbps	Bottom Face	0cm	Ant 2	11	2462	15.7	16	1.072	-0.16	0.972	1.042
	WLAN2.4GHz	802.11b 1Mbps	Bottom - Slant of Edge 4	0cm	Ant 2	1	2412	16.0	16	1.000	-0.06	0.951	0.951
	WLAN2.4GHz	802.11b 1Mbps	Bottom - Slant of Edge 4	0cm	Ant 2	6	2437	15.9	16	1.023	-0.02	0.801	0.820
	WLAN2.4GHz	802.11b 1Mbps	Bottom - Slant of Edge 4	0cm	Ant 2	11	2462	15.7	16	1.072	0	0.927	0.993
	WLAN2.4GHz	802.11b 1Mbps	Edge 4	0cm	Ant 2	1	2412	16.0	16	1.000	-0.1	0.872	0.872
	WLAN2.4GHz	802.11b 1Mbps	Edge 4	0cm	Ant 2	6	2437	15.9	16	1.023	-0.07	0.739	0.756
	WLAN2.4GHz	802.11b 1Mbps	Edge 4	0cm	Ant 2	11	2462	15.7	16	1.072	0.15	0.883	0.946
	WLAN5GHz	802.11a 6Mbps	Bottom Face	0cm	Ant 2	161	5805	13.0	13	1.000	-0.06	0.573	0.573
	WLAN5GHz	802.11a 6Mbps	Bottom - Slant of Edge 4	0cm	Ant 2	161	5805	13.0	13	1.000	-0.15	1.100	1.100
	WLAN5GHz	802.11a 6Mbps	Bottom - Slant of Edge 4	0cm	Ant 2	153	5765	13.0	13	1.000	-0.19	1.140	1.140
08	WLAN5GHz	802.11a 6Mbps	Bottom - Slant of Edge 4	0cm	Ant 2	157	5785	12.9	13	1.023	-0.19	1.190	1.218
	WLAN5GHz	802.11a 6Mbps	Edge 4	0cm	Ant 2	161	5805	13.0	13	1.000	-0.12	0.504	0.504

<WLAN SAR-NII>

Plot No.	Band	Mode	Test Position	Gap (cm)	Antenna	Ch.	Freq. (MHz)	Average Power (dBm)	Tune-Up Limit (dBm)	Tune-up Scaling Factor	Power Drift (dB)	Measured 1g SAR (W/kg)	Reported 1g SAR (W/kg)
	WLAN5GHz	802.11a 6Mbps	Bottom Face	0cm	Ant 1	40	5200	13.0	13	1.000	-0.01	0.762	0.762
	WLAN5GHz	802.11a 6Mbps	Bottom - Slant of Edge 1	0cm	Ant 1	40	5200	13.0	13	1.000	-0.14	0.657	0.657
	WLAN5GHz	802.11a 6Mbps	Edge 1	0cm	Ant 1	40	5200	13.0	13	1.000	0.09	0.446	0.446
	WLAN5GHz	802.11a 6Mbps	Bottom Face	0cm	Ant 1	60	5300	13.0	13	1.000	0.07	0.747	0.747
	WLAN5GHz	802.11a 6Mbps	Bottom - Slant of Edge 1	0cm	Ant 1	60	5300	13.0	13	1.000	-0.09	0.734	0.734
	WLAN5GHz	802.11a 6Mbps	Edge 1	0cm	Ant 1	60	5300	13.0	13	1.000	0	0.530	0.530
	WLAN5GHz	802.11a 6Mbps	Bottom Face	0cm	Ant 1	116	5580	13.0	13	1.000	0.08	1.040	1.040
	WLAN5GHz	802.11a 6Mbps	Bottom Face	0cm	Ant 1	104	5520	13.0	13	1.000	-0.05	1.150	1.150
	WLAN5GHz	802.11a 6Mbps	Bottom Face	0cm	Ant 1	136	5680	13.0	13	1.000	-0.04	0.904	0.904
	WLAN5GHz	802.11a 6Mbps	Bottom - Slant of Edge 1	0cm	Ant 1	116	5580	13.0	13	1.000	-0.13	1.090	1.090
09	WLAN5GHz	802.11a 6Mbps	Bottom - Slant of Edge 1	0cm	Ant 1	104	5520	13.0	13	1.000	-0.14	1.190	1.190
	WLAN5GHz	802.11a 6Mbps	Bottom - Slant of Edge 1	0cm	Ant 1	136	5680	13.0	13	1.000	-0.01	0.927	0.927
	WLAN5GHz	802.11a 6Mbps	Edge 1	0cm	Ant 1	116	5580	13.0	13	1.000	0.11	0.349	0.349

Plot No.	Band	Mode	Test Position	Gap (cm)	Antenna	Ch.	Freq. (MHz)	Average Power (dBm)	Tune-Up Limit (dBm)	Tune-up Scaling Factor	Power Drift (dB)	Measured 1g SAR (W/kg)	Reported 1g SAR (W/kg)
	WLAN5GHz	802.11a 6Mbps	Bottom Face	0cm	Ant 2	40	5200	11.0	11	1.000	-0.09	0.570	0.570
	WLAN5GHz	802.11a 6Mbps	Bottom - Slant of Edge 4	0cm	Ant 2	40	5200	11.0	11	1.000	-0.04	1.070	1.070
10	WLAN5GHz	802.11a 6Mbps	Bottom - Slant of Edge 4	0cm	Ant 2	44	5220	10.7	11	1.072	-0.12	1.190	1.275
	WLAN5GHz	802.11a 6Mbps	Edge 4	0cm	Ant 2	40	5200	11.0	11	1.000	-0.04	0.678	0.678
	WLAN5GHz	802.11a 6Mbps	Bottom Face	0cm	Ant 2	60	5300	8.5	8.5	1.000	-0.02	0.588	0.588
11	WLAN5GHz	802.11a 6Mbps	Bottom - Slant of Edge 4	0cm	Ant 2	60	5300	8.5	8.5	1.000	-0.08	1.140	1.140
	WLAN5GHz	802.11a 6Mbps	Bottom - Slant of Edge 4	0cm	Ant 2	52	5260	8.5	8.5	1.000	-0.11	1.130	1.130
	WLAN5GHz	802.11a 6Mbps	Edge 4	0cm	Ant 2	60	5300	8.5	8.5	1.000	-0.07	0.522	0.522
	WLAN5GHz	802.11a 6Mbps	Bottom Face	0cm	Ant 2	116	5580	10.0	10	1.000	-0.08	0.619	0.619
	WLAN5GHz	802.11a 6Mbps	Bottom Face	0cm	Ant 2	104	5520	10.0	10	1.000	-0.15	0.541	0.541
	WLAN5GHz	802.11a 6Mbps	Bottom Face	0cm	Ant 2	136	5680	10.0	10	1.000	-0.15	0.631	0.631
	WLAN5GHz	802.11a 6Mbps	Bottom - Slant of Edge 4	0cm	Ant 2	116	5580	10.0	10	1.000	-0.09	1.060	1.060
	WLAN5GHz	802.11a 6Mbps	Bottom - Slant of Edge 4	0cm	Ant 2	104	5520	10.0	10	1.000	0.07	1.080	1.080
	WLAN5GHz	802.11a 6Mbps	Bottom - Slant of Edge 4	0cm	Ant 2	136	5680	10.0	10	1.000	-0.15	1.080	1.080
	WLAN5GHz	802.11a 6Mbps	Edge 4	0cm	Ant 2	116	5580	10.0	10	1.000	-0.05	0.437	0.437
	WLAN5GHz	802.11a 6Mbps	Edge 4	0cm	Ant 2	104	5520	10.0	10	1.000	-0.16	0.399	0.399
	WLAN5GHz	802.11a 6Mbps	Edge 4	0cm	Ant 2	136	5680	10.0	10	1.000	-0.16	0.513	0.513

14.2 Repeated SAR Measurement

General Note:

1. Per KDB 865664 D01v01r01, for each frequency band, repeated SAR measurement is required only when the measured SAR is $\geq 0.8W/kg$
2. Per KDB 865664 D01v01r01, if the ratio among the repeated measurement is ≤ 1.2 and the measured SAR $< 1.45W/kg$, only one repeated measurement is required.
3. The ratio is the largest SAR to the smallest SAR among original and repeated measurement.
4. All measurement SAR result is scaled-up to account for tune-up tolerance and is compliant.

No.	Band	BW (MHz)	Modulation	RB Size	RB offset	Mode	Test Position	Gap (cm)	Ch.	Freq. (MHz)	Power Back-off	Average Power (dBm)	Tune-Up Limit (dBm)	Tune-up Scaling Factor	Power Drift (dB)	Measured 1g SAR (W/kg)	Ratio	Reported 1g SAR (W/kg)
1st	GSM850					GPRS (2 Tx slots)	Bottom - Slant of Edge 2	1.3cm	251	848.8	OFF	31.9	32	1.023	-0.11	1.160	-	1.187
2nd	GSM850					GPRS (2 Tx slots)	Bottom - Slant of Edge 2	1.3cm	251	848.8	OFF	31.9	32	1.023	-0.15	1.070	1.08	1.095
1st	GSM1900					GPRS (2 Tx slots)	Bottom - Slant of Edge 2	0cm	661	1880	ON	24.8	25	1.047	0.18	1.130	-	1.183
2nd	GSM1900					GPRS (2 Tx slots)	Bottom - Slant of Edge 2	0cm	661	1880	ON	24.8	25	1.047	-0.04	1.120	1.01	1.173
1st	LTE Band 17	10M	QPSK	25	0		Bottom - Slant of Edge 2	0cm	23800	711	ON	18.3	18.5	1.047	-0.05	1.130	-	1.183
2nd	LTE Band 17	10M	QPSK	25	0		Bottom - Slant of Edge 2	0cm	23800	711	ON	18.3	18.5	1.047	-0.03	1.080	1.08	1.131
1st	LTE Band 4	20M	QPSK	50	0		Bottom - Slant of Edge 2	0cm	20300	1745	ON	17.5	18.5	1.259	0	0.831	-	1.046
2nd	LTE Band 4	20M	QPSK	50	0		Bottom - Slant of Edge 2	0cm	20300	1745	ON	17.5	18.5	1.259	0	0.804	1.03	1.012

No.	Band	Mode	Test Position	Gap (cm)	Antenna	Ch.	Freq. (MHz)	Average Power (dBm)	Tune-Up Limit (dBm)	Tune-up Scaling Factor	Power Drift (dB)	Measured 1g SAR (W/kg)	Ratio	Reported 1g SAR (W/kg)
1st	WLAN2.4GHz	802.11b 1Mbps	Bottom Face - Slant of Edge 1	0cm	Ant 1	1	2412	16.0	16	1.000	0.05	1.190	-	1.190
2nd	WLAN2.4GHz	802.11b 1Mbps	Bottom Face - Slant of Edge 1	0cm	Ant 1	1	2412	16.0	16	1.005	-0.19	1.140	1.04	1.145
1st	WLAN5GHz	802.11a 6Mbps	Bottom Face - Slant of Edge 1	0cm	Ant 1	104	5520	13.0	13	1.000	-0.14	1.190	-	1.190
2nd	WLAN5GHz	802.11a 6Mbps	Bottom Face - Slant of Edge 1	0cm	Ant 1	104	5520	13.0	13	1.000	-0.13	1.050	1.13	1.050
1st	WLAN5GHz	802.11a 6Mbps	Bottom Face - Slant of Edge 4	0cm	Ant 2	44	5220	10.7	11	1.072	-0.12	1.190	-	1.275
2nd	WLAN5GHz	802.11a 6Mbps	Bottom Face - Slant of Edge 4	0cm	Ant 2	44	5220	10.7	11	1.072	-0.12	1.090	1.09	1.168
1st	WLAN5GHz	802.11a 6Mbps	Bottom Face - Slant of Edge 4	0cm	Ant 2	60	5300	8.5	8.5	1.000	-0.08	1.140	-	1.140
2nd	WLAN5GHz	802.11a 6Mbps	Bottom Face - Slant of Edge 4	0cm	Ant 2	60	5300	8.5	8.5	1.000	-0.19	1.080	1.06	1.080
1st	WLAN5GHz	802.11a 6Mbps	Bottom Face - Slant of Edge 4	0cm	Ant 2	157	5785	12.9	13	1.023	-0.19	1.190	-	1.218
2nd	WLAN5GHz	802.11a 6Mbps	Bottom Face - Slant of Edge 4	0cm	Ant 2	157	5785	12.9	13	1.023	-0.11	1.170	1.02	1.197

15. Simultaneous Transmission Analysis

NO.	Simultaneous Transmission Configurations	Supported
1.	WWAN + Bluetooth	Yes
2.	WWAN + WLAN Antenna 1 + WLAN Antenna 2	Yes
3.	WLAN Antenna 1 + WLAN Antenna 2	Yes

General Note:

- WLAN and Bluetooth share the same antenna, and cannot transmit simultaneously.
- This device does not support SISO mode operation.
- EUT will choose either WLAN 2.4GHz or WLAN 5GHz according to the network signal condition; therefore, 2.4GHz WLAN and 5GHz WLAN will not operate simultaneously at any moment.
- Hotspot operation is supported in 2.4GHz frequency band only. WiFi Direct (Group Owner/Group Client) is supported in 2.4GHz frequency band, and WiFi Direct (Group Client only) supported in 5GHz frequency band.
- The Scaled SAR summation is calculated based on the same configuration and test position.
- Per KDB 447498 D01v05r01, summation SAR is compliant if,
 - Scalar SAR summation < 1.6W/kg.
 - $SPLSR = (SAR_1 + SAR_2)^{1.5} / (min. \text{ separation distance, mm})$, and the peak separation distance is determined from the square root of $[(x_1-x_2)^2 + (y_1-y_2)^2 + (z_1-z_2)^2]$, where (x_1, y_1, z_1) and (x_2, y_2, z_2) are the coordinates of the extrapolated peak SAR locations in the zoom scan
If $SPLSR \leq 0.04$, Summation SAR measurement is not necessary
 - Summation SAR measurement, and the reported multi-band SAR < 1.6W/kg
- For simultaneous transmission analysis, Bluetooth SAR is estimated per KDB 447498 D01v05r01 based on the formula below.
 - $(max. \text{ power of channel, including tune-up tolerance, mW}) / (min. \text{ test separation distance, mm}) \cdot [\sqrt{f(\text{GHz})/x}] \text{ W/kg}$ for test separation distances $\leq 50 \text{ mm}$; where $x = 7.5$ for 1-g SAR, and $x = 18.75$ for 10-g SAR.
 - When the minimum separation distance is < 5mm, the distance is used 5mm to determine SAR test exclusion.
 - 0.4 W/kg for 1-g SAR and 1.0 W/kg for 10-g SAR, when the *test separation distances* is > 50 mm.

Bluetooth Max Power	Exposure Position	Bottom Face at 0mm	Edge 1 at 0mm	Edge 2 at 0mm	Bottom – Slant of Edge 2 at 0mm	Edge 3 at 0mm
	Antenna to user	< 5 mm	116 mm	216 mm	216 mm	21 mm
5.5 dBm	Estimated SAR (W/kg)	0.168 W/kg	0.400 W/kg	0.400 W/kg	0.400 W/kg	0.040 W/kg

15.1 Body Exposure Conditions

<WWAN + WLAN Antenna 1 + WLAN Antenna 2>

Position	WWAN		WLAN Ant 1		WLAN Ant 2		Summed SAR (W/kg)	SPLSR Results	Case No
	Band	SAR (W/kg)	Band	SAR (W/kg)	Band	SAR (W/kg)			
Bottom Face	GSM850	0.849	WLAN2.4GHz	1.150	WLAN2.4GHz	1.042	3.04	0.03	1
	GSM1900	1.141		1.150		1.042	3.33	0.03	2
	WCDMA V	1.019		1.150		1.042	3.21	0.03	3
	WCDMA II	1.162		1.150		1.042	3.35	0.03	4
	LTE Band 17	1.079		1.150		1.042	3.27	0.03	5
	LTE Band 4	1.021		1.150		1.042	3.21	0.03	6
	GSM850	0.849	WLAN5.2GHz	0.762	WLAN5.2GHz	0.570	2.18	0.01	7
	GSM1900	1.141		0.762		0.570	2.47	0.02	8
	WCDMA V	1.019		0.762		0.570	2.35	0.01	9
	WCDMA II	1.162		0.762		0.570	2.49	0.02	10
	LTE Band 17	1.079		0.762		0.570	2.41	0.01	11
	LTE Band 4	1.021		0.762		0.570	2.35	0.01	12
	GSM850	0.849	WLAN5.3GHz	0.747	WLAN5.3GHz	0.588	2.18	0.01	13
	GSM1900	1.141		0.747		0.588	2.48	0.02	14
	WCDMA V	1.019		0.747		0.588	2.35	0.01	15
	WCDMA II	1.162		0.747		0.588	2.50	0.02	16
	LTE Band 17	1.079		0.747		0.588	2.41	0.01	17
	LTE Band 4	1.021		0.747		0.588	2.36	0.01	18
	GSM850	0.849	WLAN5.5GHz	1.150	WLAN5.5GHz	0.619	2.62	0.02	19
	GSM1900	1.141		1.150		0.619	2.91	0.02	20
	WCDMA V	1.019		1.150		0.619	2.79	0.02	21
	WCDMA II	1.162		1.150		0.619	2.93	0.02	22
	LTE Band 17	1.079		1.150		0.619	2.85	0.02	23
	LTE Band 4	1.021		1.150		0.619	2.79	0.02	24
	GSM850	0.849	WLAN5.8GHz	0.535	WLAN5.8GHz	0.573	1.96	0.01	25
	GSM1900	1.141		0.535		0.573	2.25	0.01	26
	WCDMA V	1.019		0.535		0.573	2.13	0.01	27
	WCDMA II	1.162		0.535		0.573	2.27	0.01	28
	LTE Band 17	1.079		0.535		0.573	2.19	0.01	29
	LTE Band 4	1.021		0.535		0.573	2.13	0.01	30

Position	WWAN		WLAN Ant 1		WLAN Ant 2		Summed SAR (W/kg)	SPLSR Results	Case No
	Band	SAR (W/kg)	Band	SAR (W/kg)	Band	SAR (W/kg)			
Edge 1	GSM850	0.312	WLAN2.4GHz	0.857	WLAN2.4GHz		1.17		
	GSM1900	0.160		0.857			1.02		
	WCDMA V	0.168		0.857			1.03		
	WCDMA II	0.165		0.857			1.02		
	LTE Band 17	0.188		0.857			1.05		
	LTE Band 4	0.222		0.857			1.08		
	GSM850	0.312	WLAN5.2GHz	0.446	WLAN5.2GHz		0.76		
	GSM1900	0.160		0.446			0.61		
	WCDMA V	0.168		0.446			0.61		
	WCDMA II	0.165		0.446			0.61		
	LTE Band 17	0.188		0.446			0.63		
	LTE Band 4	0.222		0.446			0.67		
	GSM850	0.312	WLAN5.3GHz	0.530	WLAN5.3GHz		0.84		
	GSM1900	0.160		0.530			0.69		
	WCDMA V	0.168		0.530			0.70		
	WCDMA II	0.165		0.530			0.70		
	LTE Band 17	0.188		0.530			0.72		
	LTE Band 4	0.222		0.530			0.75		
	GSM850	0.312	WLAN5.5GHz	0.349	WLAN5.5GHz		0.66		
	GSM1900	0.160		0.349			0.51		
	WCDMA V	0.168		0.349			0.52		
	WCDMA II	0.165		0.349			0.51		
	LTE Band 17	0.188		0.349			0.54		
	LTE Band 4	0.222		0.349			0.57		
	GSM850	0.312	WLAN5.8GHz	0.116	WLAN5.8GHz		0.43		
	GSM1900	0.160		0.116			0.28		
	WCDMA V	0.168		0.116			0.28		
	WCDMA II	0.165		0.116			0.28		
	LTE Band 17	0.188		0.116			0.30		
	LTE Band 4	0.222		0.116			0.34		

<WLAN Antenna 1 + WLAN Antenna 2> (MIMO)

Position	WLAN Ant 1		WLAN Ant 2		Summed SAR (W/kg)	SPLSR Results	Case No
	Band	SAR (W/kg)	Band	SAR (W/kg)			
Bottom Face	WLAN2.4GHz	1.150	WLAN2.4GHz	1.042	2.19	0.03	Case 1
	WLAN5.2GHz	0.762	WLAN5.2GHz	0.570	1.33		
	WLAN5.3GHz	0.747	WLAN5.3GHz	0.588	1.34		
	WLAN5.5GHz	1.150	WLAN5.5GHz	0.619	1.77	0.02	Case 19
	WLAN5.8GHz	0.535	WLAN5.8GHz	0.573	1.11		
Bottom - Slant of Edge 1	WLAN2.4GHz	1.190	WLAN2.4GHz		1.19		
	WLAN5.2GHz	0.657	WLAN5.2GHz		0.66		
	WLAN5.3GHz	0.734	WLAN5.3GHz		0.73		
	WLAN5.5GHz	1.190	WLAN5.5GHz		1.19		
	WLAN5.8GHz	0.675	WLAN5.8GHz		0.68		
Edge 1	WLAN2.4GHz	0.857	WLAN2.4GHz		0.86		
	WLAN5.2GHz	0.446	WLAN5.2GHz		0.45		
	WLAN5.3GHz	0.530	WLAN5.3GHz		0.53		
	WLAN5.5GHz	0.349	WLAN5.5GHz		0.35		
	WLAN5.8GHz	0.116	WLAN5.8GHz		0.12		
Bottom - Slant of Edge 4	WLAN2.4GHz		WLAN2.4GHz	0.993	0.99		
	WLAN5.2GHz		WLAN5.2GHz	1.275	1.28		
	WLAN5.3GHz		WLAN5.3GHz	1.140	1.14		
	WLAN5.5GHz		WLAN5.5GHz	1.080	1.08		
	WLAN5.8GHz		WLAN5.8GHz	1.218	1.22		
Edge 4	WLAN2.4GHz		WLAN2.4GHz	0.946	0.95		
	WLAN5.2GHz		WLAN5.2GHz	0.678	0.68		
	WLAN5.3GHz		WLAN5.3GHz	0.522	0.52		
	WLAN5.5GHz		WLAN5.5GHz	0.513	0.51		
	WLAN5.8GHz		WLAN5.8GHz	0.504	0.50		

<WWAN + Bluetooth>

Position	WWAN		Bluetooth	Summed SAR (W/kg)	SPLSR Results	Case No
	Band	SAR (W/kg)	Estimated SAR (W/kg)			
Bottom Face at 0cm	GSM850	0.849	0.168	1.02		
	GSM1900	1.141	0.168	1.31		
	WCDMA V	1.019	0.168	1.19		
	WCDMA II	1.162	0.168	1.33		
	LTE Band 17	1.079	0.168	1.25		
	LTE Band 4	1.021	0.168	1.19		
Bottom - Slant of Edge 2 at 0cm	GSM850	1.105	0.400	1.51		
	GSM1900	1.183	0.400	1.58		
	WCDMA V	1.173	0.400	1.57		
	WCDMA II	1.173	0.400	1.57		
	LTE Band 17	1.184	0.400	1.58		
	LTE Band 4	1.046	0.400	1.45		
Edge 1 at 0cm	GSM850	0.262	0.400	0.66		
	GSM1900	0.699	0.400	1.10		
	WCDMA V	0.322	0.400	0.72		
	WCDMA II	0.498	0.400	0.90		
	LTE Band 17	0.617	0.400	1.02		
	LTE Band 4	0.312	0.400	0.71		
Edge 2 at 0cm	GSM850	0.160	0.400	0.56		
	GSM1900	0.168	0.400	0.57		
	WCDMA V	0.165	0.400	0.57		
	WCDMA II	0.188	0.400	0.59		
	LTE Band 17	0.222	0.400	0.62		
	LTE Band 4	0.642	0.400	1.04		
Edge 3 at 0cm	GSM850	0.321	0.400	0.72		
	GSM1900	0.728	0.400	1.13		
	WCDMA V	0.336	0.400	0.74		
	WCDMA II	0.954	0.400	1.35		
	LTE Band 17	0.272	0.400	0.67		
	LTE Band 4	1.187	0.400	1.59		

15.2 SPLSR Evaluation and Analysis

Case 1	Position	Band	SAR (W/kg)	Gap (cm)	SAR peak location (m)			3D distance (mm)	Pair SAR sum (W/kg)	SPLSR	Simultaneous SAR
					X	Y	Z				
Bottom Face		GSM850	0.849	0	0.0165	0.119	-0.181	182.1	2.00	0.02	Not required
		WLAN2.4GHz(Ant1)	1.150	0	0.0736	-0.0538	-0.176				
		GSM850	0.849	0	0.0165	0.119	-0.181	225.8	1.89	0.01	Not required
		WLAN2.4GHz(Ant2)	1.042	0	-0.0344	-0.101	-0.18				
		WLAN2.4GHz(Ant1)	1.150	0	0.0736	-0.0538	-0.176	117.9	2.19	0.03	Not required
		WLAN2.4GHz(Ant2)	1.042	0	-0.0344	-0.101	-0.18				

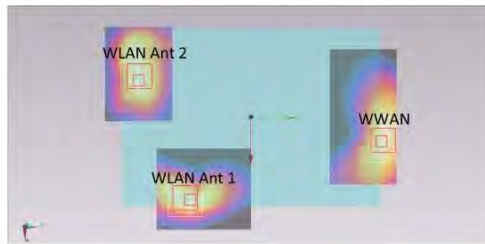

Case 2	Position	Band	SAR (W/kg)	Gap (cm)	SAR peak location (m)			3D distance (mm)	Pair SAR sum (W/kg)	SPLSR	Simultaneous SAR
					X	Y	Z				
Bottom Face		GSM1900	1.141	0	0.002	0.105	-0.175	174.2	2.29	0.02	Not required
		WLAN2.4GHz(Ant1)	1.150	0	0.0736	-0.0538	-0.176				
		GSM1900	1.141	0	0.002	0.105	-0.175	209.3	2.18	0.02	Not required
		WLAN2.4GHz(Ant2)	1.042	0	-0.0344	-0.101	-0.18				
		WLAN2.4GHz(Ant1)	1.150	0	0.0736	-0.0538	-0.176	117.9	2.19	0.03	Not required
		WLAN2.4GHz(Ant2)	1.042	0	-0.0344	-0.101	-0.18				



Case 3	Position	Band	SAR (W/kg)	Gap (cm)	SAR peak location (m)			3D distance (mm)	Pair SAR sum (W/kg)	SPLSR	Simultaneous SAR
					X	Y	Z				
Bottom Face		WCDMA V	1.019	0	0.0245	0.109	-0.177	170.0	2.17	0.02	Not required
		WLAN2.4GHz(Ant1)	1.150	0	0.0736	-0.0538	-0.176				
		WCDMA V	1.019	0	0.0245	0.109	-0.177	218.1	2.06	0.01	Not required
		WLAN2.4GHz(Ant2)	1.042	0	-0.0344	-0.101	-0.18				
		WLAN2.4GHz(Ant1)	1.150	0	0.0736	-0.0538	-0.176	117.9	2.19	0.03	Not required
		WLAN2.4GHz(Ant2)	1.042	0	-0.0344	-0.101	-0.18				

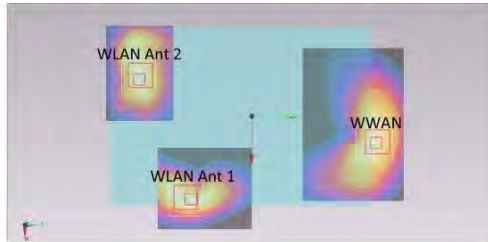

Case 4	Position	Band	SAR (W/kg)	Gap (cm)	SAR peak location (m)			3D distance (mm)	Pair SAR sum (W/kg)	SPLSR	Simultaneous SAR
					X	Y	Z				
Bottom Face		WCDMA II	1.162	0	0.013	0.105	-0.176	170.0	2.31	0.02	Not required
		WLAN2.4GHz(Ant1)	1.150	0	0.0736	-0.0538	-0.176				
		WCDMA II	1.162	0	0.013	0.105	-0.176	211.4	2.20	0.02	Not required
		WLAN2.4GHz(Ant2)	1.042	0	-0.0344	-0.101	-0.18				
		WLAN2.4GHz(Ant1)	1.150	0	0.0736	-0.0538	-0.176	117.9	2.19	0.03	Not required
		WLAN2.4GHz(Ant2)	1.042	0	-0.0344	-0.101	-0.18				



Case 5	Position	Band	SAR (W/kg)	Gap (cm)	SAR peak location (m)			3D distance (mm)	Pair SAR sum (W/kg)	SPLSR	Simultaneous SAR
					X	Y	Z				
Bottom Face	LTE Band 17	1.079	0	0.0275	0.111	-0.177	171.1	2.23	0.02	Not required	
	WLAN2.4GHz(Ant1)	1.150	0	0.0736	-0.0538	-0.176					
	LTE Band 17	1.079	0	0.0275	0.111	-0.177	220.9	2.12	0.01	Not required	
	WLAN2.4GHz(Ant2)	1.042	0	-0.0344	-0.101	-0.18					
	WLAN2.4GHz(Ant1)	1.150	0	0.0736	-0.0538	-0.176	117.9	2.19	0.03	Not required	
	WLAN2.4GHz(Ant2)	1.042	0	-0.0344	-0.101	-0.18					

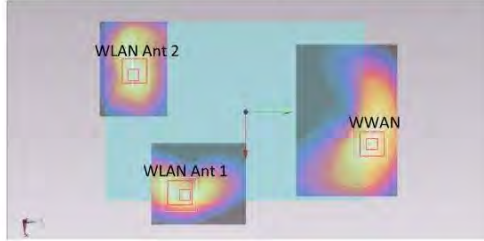

Case 6	Position	Band	SAR (W/kg)	Gap (cm)	SAR peak location (m)			3D distance (mm)	Pair SAR sum (W/kg)	SPLSR	Simultaneous SAR
					X	Y	Z				
Bottom Face	LTE Band 4	1.021	0	0.0135	0.102	-0.177	167.0	2.17	0.02	Not required	
	WLAN2.4GHz(Ant1)	1.150	0	0.0736	-0.0538	-0.176					
	LTE Band 4	1.021	0	0.0135	0.102	-0.177	208.6	2.06	0.01	Not required	
	WLAN2.4GHz(Ant2)	1.042	0	-0.0344	-0.101	-0.18					
	WLAN2.4GHz(Ant1)	1.150	0	0.0736	-0.0538	-0.176	117.9	2.19	0.03	Not required	
	WLAN2.4GHz(Ant2)	1.042	0	-0.0344	-0.101	-0.18					

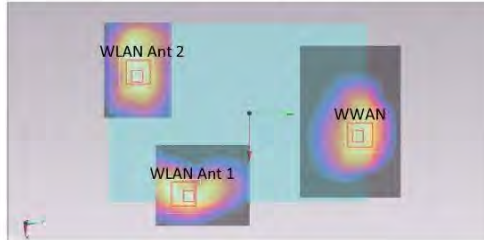

Case 7	Position	Band	SAR (W/kg)	Gap (cm)	SAR peak location (m)			3D distance (mm)	Pair SAR sum (W/kg)	SPLSR	Simultaneous SAR
					X	Y	Z				
Bottom Face		GSM850	0.849	0	0.0165	0.119	-0.181	177.7	1.61	0.01	Not required
		WLAN5.2GHz(Ant1)	0.762	0	0.068	-0.051	-0.178				
		GSM850	0.849	0	0.0165	0.119	-0.181	230.5	1.42	0.01	Not required
		WLAN5.2GHz(Ant2)	0.570	0	-0.049	-0.102	-0.177				
		WLAN5.2GHz(Ant1)	0.762	0	0.068	-0.051	-0.178	127.6	1.33	0.01	Not required
		WLAN5.2GHz(Ant2)	0.570	0	-0.049	-0.102	-0.177				

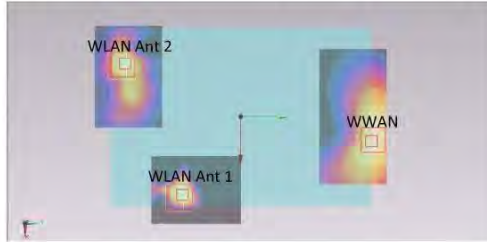

Case 8	Position	Band	SAR (W/kg)	Gap (cm)	SAR peak location (m)			3D distance (mm)	Pair SAR sum (W/kg)	SPLSR	Simultaneous SAR
					X	Y	Z				
Bottom Face		GSM1900	1.141	0	0.002	0.105	-0.175	169.4	1.90	0.02	Not required
		WLAN5.2GHz(Ant1)	0.762	0	0.068	-0.051	-0.178				
		GSM1900	1.141	0	0.002	0.105	-0.175	213.2	1.71	0.01	Not required
		WLAN5.2GHz(Ant2)	0.570	0	-0.049	-0.102	-0.177				
		WLAN5.2GHz(Ant1)	0.762	0	0.068	-0.051	-0.178	127.6	1.33	0.01	Not required
		WLAN5.2GHz(Ant2)	0.57	0	-0.049	-0.102	-0.177				

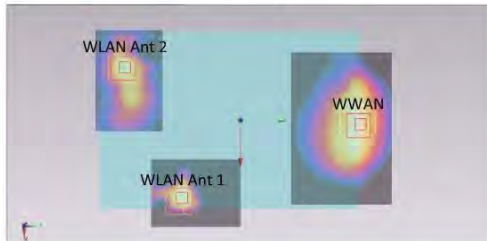

Case 9	Position	Band	SAR (W/kg)	Gap (cm)	SAR peak location (m)			3D distance (mm)	Pair SAR sum (W/kg)	SPLSR	Simultaneous SAR
					X	Y	Z				
Bottom Face	WCDMA V	1.019	0	0.0245	0.109	-0.177	165.8	1.78	0.01	Not required	
		0.762	0	0.068	-0.051	-0.178					
	WCDMA V	1.019	0	0.0245	0.109	-0.177	223.4	1.59	0.01	Not required	
		0.570	0	-0.049	-0.102	-0.177					
	WLAN5.2GHz(Ant1)	0.762	0	0.068	-0.051	-0.178	127.6	1.33	0.01	Not required	
		0.570	0	-0.049	-0.102	-0.177					

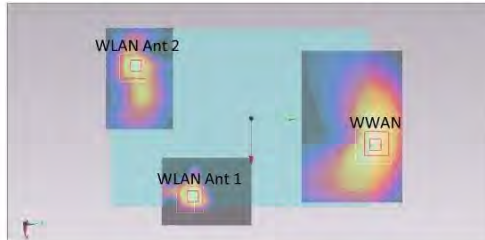

Case 10	Position	Band	SAR (W/kg)	Gap (cm)	SAR peak location (m)			3D distance (mm)	Pair SAR sum (W/kg)	SPLSR	Simultaneous SAR
					X	Y	Z				
Bottom Face	WCDMA II	1.162	0	0.013	0.105	-0.176	165.4	1.92	0.02	Not required	
		0.762	0	0.068	-0.051	-0.178					
	WCDMA II	1.162	0	0.013	0.105	-0.176	216.1	1.73	0.01	Not required	
		0.570	0	-0.049	-0.102	-0.177					
	WLAN5.2GHz(Ant1)	0.762	0	0.068	-0.051	-0.178	127.6	1.33	0.01	Not required	
		0.570	0	-0.049	-0.102	-0.177					

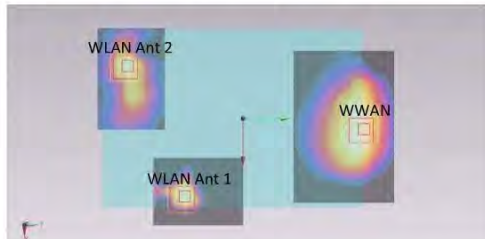

	Position	Band	SAR (W/kg)	Gap (cm)	SAR peak location (m)			3D distance (mm)	Pair SAR sum (W/kg)	SPLSR	Simultaneous SAR
					X	Y	Z				
Case 11	Bottom Face	LTE Band 17	1.079	0	0.0275	0.111	-0.177	167.0	1.84	0.01	Not required
		WLAN5.2GHz(Ant1)	0.762	0	0.068	-0.051	-0.178				
		LTE Band 17	1.079	0	0.0275	0.111	-0.177	226.3	1.65	0.01	Not required
		WLAN5.2GHz(Ant2)	0.57	0	-0.049	-0.102	-0.177				
		WLAN5.2GHz(Ant1)	0.762	0	0.068	-0.051	-0.178	127.6	1.33	0.01	Not required
		WLAN5.2GHz(Ant2)	0.57	0	-0.049	-0.102	-0.177				

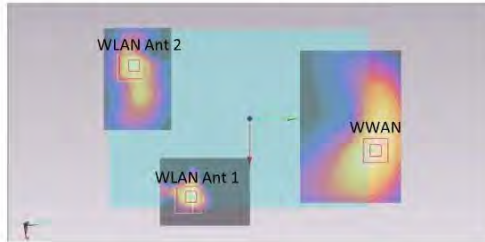

	Position	Band	SAR (W/kg)	Gap (cm)	SAR peak location (m)			3D distance (mm)	Pair SAR sum (W/kg)	SPLSR	Simultaneous SAR
					X	Y	Z				
Case 12	Bottom Face	LTE Band 4	1.021	0	0.0135	0.102	-0.177	162.4	1.78	0.01	Not required
		WLAN5.2GHz(Ant1)	0.762	0	0.068	-0.051	-0.178				
		LTE Band 4	1.021	0	0.0135	0.102	-0.177	213.4	1.59	0.01	Not required
		WLAN5.2GHz(Ant2)	0.57	0	-0.049	-0.102	-0.177				
		WLAN5.2GHz(Ant1)	0.762	0	0.068	-0.051	-0.178	127.6	1.33	0.01	Not required
		WLAN5.2GHz(Ant2)	0.57	0	-0.049	-0.102	-0.177				

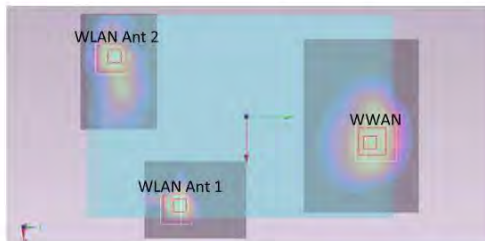

Case 13	Position	Band	SAR (W/kg)	Gap (cm)	SAR peak location (m)			3D distance (mm)	Pair SAR sum (W/kg)	SPLSR	Simultaneous SAR
					X	Y	Z				
Bottom Face		GSM850	0.849	0	0.0165	0.119	-0.181	178.6	1.60	0.01	Not required
		WLAN5.3GHz(Ant1)	0.747	0	0.068	-0.052	-0.178				
		GSM850	0.849	0	0.0165	0.119	-0.181	231.5	1.44	0.01	Not required
		WLAN5.3GHz(Ant2)	0.588	0	-0.049	-0.103	-0.177				
		WLAN5.3GHz(Ant1)	0.747	0	0.068	-0.052	-0.178	127.6	1.34	0.01	Not required
		WLAN5.3GHz(Ant2)	0.588	0	-0.049	-0.103	-0.177				

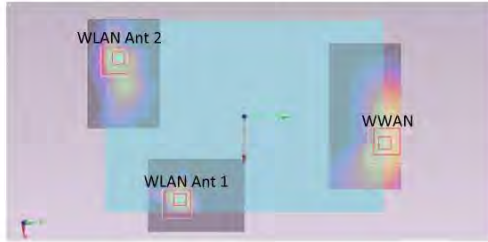

Case 14	Position	Band	SAR (W/kg)	Gap (cm)	SAR peak location (m)			3D distance (mm)	Pair SAR sum (W/kg)	SPLSR	Simultaneous SAR
					X	Y	Z				
Bottom Face		GSM1900	1.141	0	0.002	0.105	-0.175	170.3	1.89	0.02	Not required
		WLAN5.3GHz(Ant1)	0.747	0	0.068	-0.052	-0.178				
		GSM1900	1.141	0	0.002	0.105	-0.175	214.2	1.73	0.01	Not required
		WLAN5.3GHz(Ant2)	0.588	0	-0.049	-0.103	-0.177				
		WLAN5.3GHz(Ant1)	0.747	0	0.068	-0.052	-0.178	127.6	1.34	0.01	Not required
		WLAN5.3GHz(Ant2)	0.588	0	-0.049	-0.103	-0.177				

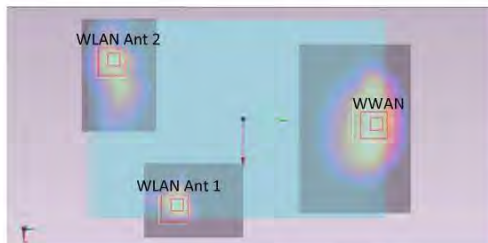

Case 15	Position	Band	SAR (W/kg)	Gap (cm)	SAR peak location (m)			3D distance (mm)	Pair SAR sum (W/kg)	SPLSR	Simultaneous SAR
					X	Y	Z				
Bottom Face	WCDMA V	1.019	0	0.0245	0.109	-0.177	166.8	1.77	0.01	Not required	
	WLAN5.3GHz(Ant1)	0.747	0	0.068	-0.052	-0.178					
	WCDMA V	1.019	0	0.0245	0.109	-0.177	224.4	1.61	0.01	Not required	
	WLAN5.3GHz(Ant2)	0.588	0	-0.049	-0.103	-0.177					
	WLAN5.3GHz(Ant1)	0.747	0	0.068	-0.052	-0.178	127.6	1.34	0.01	Not required	
	WLAN5.3GHz(Ant2)	0.588	0	-0.049	-0.103	-0.177					



Case 16	Position	Band	SAR (W/kg)	Gap (cm)	SAR peak location (m)			3D distance (mm)	Pair SAR sum (W/kg)	SPLSR	Simultaneous SAR
					X	Y	Z				
Bottom Face	WCDMA II	1.162	0	0.013	0.105	-0.176	166.4	1.91	0.02	Not required	
	WLAN5.3GHz(Ant1)	0.747	0	0.068	-0.052	-0.178					
	WCDMA II	1.162	0	0.013	0.105	-0.176	217.0	1.75	0.01	Not required	
	WLAN5.3GHz(Ant2)	0.588	0	-0.049	-0.103	-0.177					
	WLAN5.3GHz(Ant1)	0.747	0	0.068	-0.052	-0.178	127.6	1.34	0.01	Not required	
	WLAN5.3GHz(Ant2)	0.588	0	-0.049	-0.103	-0.177					

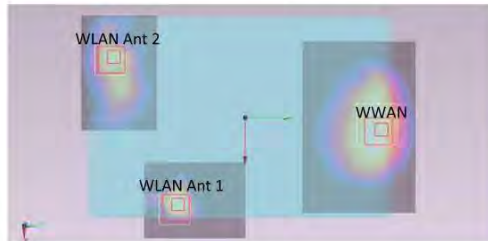

Case 17	Position	Band	SAR (W/kg)	Gap (cm)	SAR peak location (m)			3D distance (mm)	Pair SAR sum (W/kg)	SPLSR	Simultaneous SAR
					X	Y	Z				
Bottom Face	LTE Band 17	1.079	0	0.0275	0.111	-0.177	168.0	1.83	0.01	Not required	
	WLAN5.3GHz(Ant1)	0.747	0	0.068	-0.052	-0.178					
	LTE Band 17	1.079	0	0.0275	0.111	-0.177	227.3	1.67	0.01	Not required	
	WLAN5.3GHz(Ant2)	0.588	0	-0.049	-0.103	-0.177					
	WLAN5.3GHz(Ant1)	0.747	0	0.068	-0.052	-0.178	127.6	1.34	0.01	Not required	
	WLAN5.3GHz(Ant2)	0.588	0	-0.049	-0.103	-0.177					

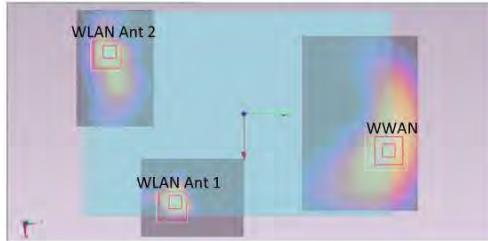

Case 18	Position	Band	SAR (W/kg)	Gap (cm)	SAR peak location (m)			3D distance (mm)	Pair SAR sum (W/kg)	SPLSR	Simultaneous SAR
					X	Y	Z				
Bottom Face	LTE Band 4	1.021	0	0.0135	0.102	-0.177	163.4	1.77	0.01	Not required	
	WLAN5.3GHz(Ant1)	0.747	0	0.068	-0.052	-0.178					
	LTE Band 4	1.021	0	0.0135	0.102	-0.177	214.3	1.61	0.01	Not required	
	WLAN5.3GHz(Ant2)	0.588	0	-0.049	-0.103	-0.177					
	WLAN5.3GHz(Ant1)	0.747	0	0.068	-0.052	-0.178	127.6	1.34	0.01	Not required	
	WLAN5.3GHz(Ant2)	0.588	0	-0.049	-0.103	-0.177					

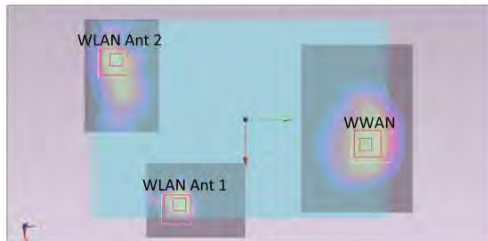

Case 19	Position	Band	SAR (W/kg)	Gap (cm)	SAR peak location (m)			3D distance (mm)	Pair SAR sum (W/kg)	SPLSR	Simultaneous SAR
					X	Y	Z				
Bottom Face		GSM850	0.849	0	0.0165	0.119	-0.181	180.5	2.00	0.02	Not required
		WLAN5.5GHz(Ant1)	1.150	0	0.068	-0.054	-0.177				
		GSM850	0.849	0	0.0165	0.119	-0.181	232.2	1.47	0.01	Not required
		WLAN5.5GHz(Ant2)	0.619	0	-0.048	-0.104	-0.177				
		WLAN5.5GHz(Ant1)	1.150	0	0.068	-0.054	-0.177	126.3	1.77	0.02	Not required
		WLAN5.5GHz(Ant2)	0.619	0	-0.048	-0.104	-0.177				



Case 20	Position	Band	SAR (W/kg)	Gap (cm)	SAR peak location (m)			3D distance (mm)	Pair SAR sum (W/kg)	SPLSR	Simultaneous SAR
					X	Y	Z				
Bottom Face		GSM1900	1.141	0	0.002	0.105	-0.175	172.2	2.29	0.02	Not required
		WLAN5.5GHz(Ant1)	1.15	0	0.068	-0.054	-0.177				
		GSM1900	1.141	0	0.002	0.105	-0.175	214.9	1.76	0.01	Not required
		WLAN5.5GHz(Ant2)	0.619	0	-0.048	-0.104	-0.177				
		WLAN5.5GHz(Ant1)	1.15	0	0.068	-0.054	-0.177	126.3	1.77	0.02	Not required
		WLAN5.5GHz(Ant2)	0.619	0	-0.048	-0.104	-0.177				

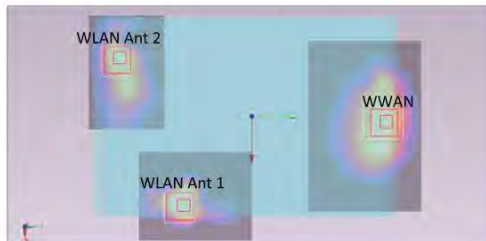

Case 21	Position	Band	SAR (W/kg)	Gap (cm)	SAR peak location (m)			3D distance (mm)	Pair SAR sum (W/kg)	SPLSR	Simultaneous SAR
					X	Y	Z				
Bottom Face	WCDMA V	1.019	0	0.0245	0.109	-0.177	168.7	2.17	0.02	Not required	
	WLAN5.5GHz(Ant1)	1.150	0	0.068	-0.054	-0.177					
	WCDMA V	1.019	0	0.0245	0.109	-0.177	225.0	1.64	0.01	Not required	
	WLAN5.5GHz(Ant2)	0.619	0	-0.048	-0.104	-0.177					
	WLAN5.5GHz(Ant1)	1.150	0	0.068	-0.054	-0.177	126.3	1.77	0.02	Not required	
	WLAN5.5GHz(Ant2)	0.619	0	-0.048	-0.104	-0.177					

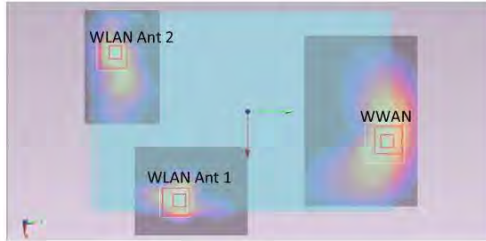

Case 22	Position	Band	SAR (W/kg)	Gap (cm)	SAR peak location (m)			3D distance (mm)	Pair SAR sum (W/kg)	SPLSR	Simultaneous SAR
					X	Y	Z				
Bottom Face	WCDMA II	1.162	0	0.013	0.105	-0.176	168.2	2.31	0.02	Not required	
	WLAN5.5GHz(Ant1)	1.150	0	0.068	-0.054	-0.177					
	WCDMA II	1.162	0	0.013	0.105	-0.176	217.7	1.78	0.01	Not required	
	WLAN5.5GHz(Ant2)	0.619	0	-0.048	-0.104	-0.177					
	WLAN5.5GHz(Ant1)	1.150	0	0.068	-0.054	-0.177	126.3	1.77	0.02	Not required	
	WLAN5.5GHz(Ant2)	0.619	0	-0.048	-0.104	-0.177					

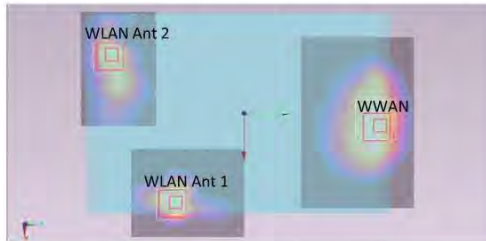

Case 23	Position	Band	SAR (W/kg)	Gap (cm)	SAR peak location (m)			3D distance (mm)	Pair SAR sum (W/kg)	SPLSR	Simultaneous SAR
					X	Y	Z				
Bottom Face	WLAN5.5GHz(Ant1)	1.079	0	0.0275	0.111	-0.177	169.9	2.23	0.02	Not required	
	WLAN5.5GHz(Ant2)	1.150	0	0.068	-0.054	-0.177					
	LTE Band 17	1.079	0	0.0275	0.111	-0.177	227.9	1.70	0.01	Not required	
	WLAN5.5GHz(Ant2)	0.619	0	-0.048	-0.104	-0.177					
	WLAN5.5GHz(Ant1)	1.150	0	0.068	-0.054	-0.177	126.3	1.77	0.02	Not required	
	WLAN5.5GHz(Ant2)	0.619	0	-0.048	-0.104	-0.177					



Case 24	Position	Band	SAR (W/kg)	Gap (cm)	SAR peak location (m)			3D distance (mm)	Pair SAR sum (W/kg)	SPLSR	Simultaneous SAR
					X	Y	Z				
Bottom Face	LTE Band 4	1.021	0	0.0135	0.102	-0.177	165.2	2.17	0.02	Not required	
	WLAN5.5GHz(Ant1)	1.15	0	0.068	-0.054	-0.177					
	LTE Band 4	1.021	0	0.0135	0.102	-0.177	215.0	1.64	0.01	Not required	
	WLAN5.5GHz(Ant2)	0.619	0	-0.048	-0.104	-0.177					
	WLAN5.5GHz(Ant1)	1.15	0	0.068	-0.054	-0.177	126.3	1.77	0.02	Not required	
	WLAN5.5GHz(Ant2)	0.619	0	-0.048	-0.104	-0.177					

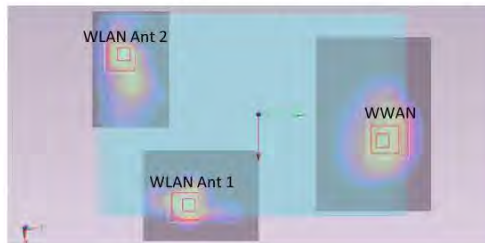

Case 25	Position	Band	SAR (W/kg)	Gap (cm)	SAR peak location (m)			3D distance (mm)	Pair SAR sum (W/kg)	SPLSR	Simultaneous SAR
					X	Y	Z				
Bottom Face	GSM850	0.849	0	0.0165	0.119	-0.181	178.9	1.38	0.01	Not required	
	WLAN5.8GHz(Ant1)	0.535	0	0.069	-0.052	-0.178					
	GSM850	0.849	0	0.0165	0.119	-0.181	231.9	1.42	0.01	Not required	
	WLAN5.8GHz(Ant2)	0.573	0	-0.047	-0.104	-0.177					
	WLAN5.8GHz(Ant1)	0.535	0	0.069	-0.052	-0.178	127.1	1.11	0.01	Not required	
	WLAN5.8GHz(Ant2)	0.573	0	-0.047	-0.104	-0.177					

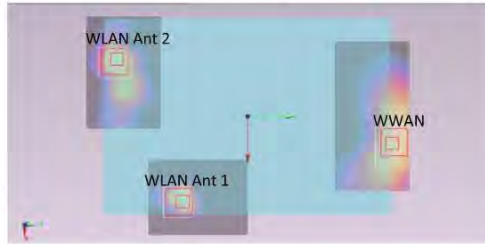

Case 26	Position	Band	SAR (W/kg)	Gap (cm)	SAR peak location (m)			3D distance (mm)	Pair SAR sum (W/kg)	SPLSR	Simultaneous SAR
					X	Y	Z				
Bottom Face	GSM1900	1.141	0	0.002	0.105	-0.175	170.7	1.68	0.01	Not required	
	WLAN5.8GHz(Ant1)	0.535	0	0.069	-0.052	-0.178					
	GSM1900	1.141	0	0.002	0.105	-0.175	214.7	1.71	0.01	Not required	
	WLAN5.8GHz(Ant2)	0.573	0	-0.047	-0.104	-0.177					
	WLAN5.8GHz(Ant1)	0.535	0	0.069	-0.052	-0.178	127.1	1.11	0.01	Not required	
	WLAN5.8GHz(Ant2)	0.573	0	-0.047	-0.104	-0.177					



Case 27	Position	Band	SAR (W/kg)	Gap (cm)	SAR peak location (m)			3D distance (mm)	Pair SAR sum (W/kg)	SPLSR	Simultaneous SAR
					X	Y	Z				
Bottom Face		WCDMA V	1.019	0	0.0245	0.109	-0.177	167.0	1.55	0.01	Not required
		WLAN5.8GHz(Ant1)	0.535	0	0.069	-0.052	-0.178				
		WCDMA V	1.019	0	0.0245	0.109	-0.177	224.7	1.59	0.01	Not required
		WLAN5.8GHz(Ant2)	0.573	0	-0.047	-0.104	-0.177				
		WLAN5.8GHz(Ant1)	0.535	0	0.069	-0.052	-0.178	127.1	1.11	0.01	Not required
		WLAN5.8GHz(Ant2)	0.573	0	-0.047	-0.104	-0.177				

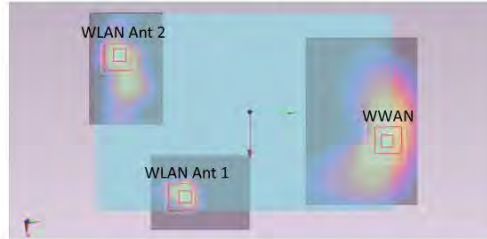

Case 28	Position	Band	SAR (W/kg)	Gap (cm)	SAR peak location (m)			3D distance (mm)	Pair SAR sum (W/kg)	SPLSR	Simultaneous SAR
					X	Y	Z				
Bottom Face		WCDMA II	1.162	0	0.013	0.105	-0.176	166.7	1.70	0.01	Not required
		WLAN5.8GHz(Ant1)	0.535	0	0.069	-0.052	-0.178				
		WCDMA II	1.162	0	0.013	0.105	-0.176	217.4	1.74	0.01	Not required
		WLAN5.8GHz(Ant2)	0.573	0	-0.047	-0.104	-0.177				
		WLAN5.8GHz(Ant1)	0.535	0	0.069	-0.052	-0.178	127.1	1.11	0.01	Not required
		WLAN5.8GHz(Ant2)	0.573	0	-0.047	-0.104	-0.177				



Case 29	Position	Band	SAR (W/kg)	Gap (cm)	SAR peak location (m)			3D distance (mm)	Pair SAR sum (W/kg)	SPLSR	Simultaneous SAR
					X	Y	Z				
Bottom Face	LTE Band 17	WLAN5.8GHz(Ant1)	1.079	0	0.0275	0.111	-0.177	168.2	1.61	0.01	Not required
		WLAN5.8GHz(Ant2)	0.535	0	0.069	-0.052	-0.178				
	WLAN5.8GHz(Ant1)	LTE Band 17	1.079	0	0.0275	0.111	-0.177	227.5	1.65	0.01	Not required
		WLAN5.8GHz(Ant2)	0.573	0	-0.047	-0.104	-0.177				
	WLAN5.8GHz(Ant1)	WLAN5.8GHz(Ant1)	0.535	0	0.069	-0.052	-0.178	127.1	1.11	0.01	Not required
		WLAN5.8GHz(Ant2)	0.573	0	-0.047	-0.104	-0.177				

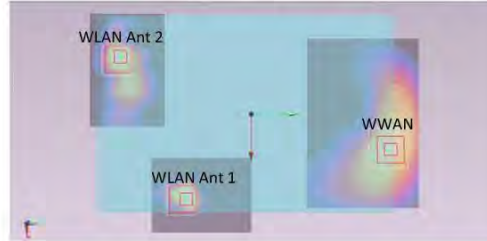

Case 30	Position	Band	SAR (W/kg)	Gap (cm)	SAR peak location (m)			3D distance (mm)	Pair SAR sum (W/kg)	SPLSR	Simultaneous SAR
					X	Y	Z				
Bottom Face	LTE Band 4	WLAN5.8GHz(Ant1)	1.021	0	0.0135	0.102	-0.177	163.7	1.56	0.01	Not required
		WLAN5.8GHz(Ant2)	0.535	0	0.069	-0.052	-0.178				
	WLAN5.8GHz(Ant1)	LTE Band 4	1.021	0	0.0135	0.102	-0.177	214.7	1.59	0.01	Not required
		WLAN5.8GHz(Ant2)	0.573	0	-0.047	-0.104	-0.177				
	WLAN5.8GHz(Ant1)	WLAN5.8GHz(Ant1)	0.535	0	0.069	-0.052	-0.178	127.1	1.11	0.01	Not required
		WLAN5.8GHz(Ant2)	0.573	0	-0.047	-0.104	-0.177				

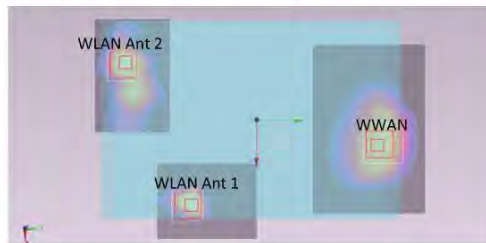

Test Engineer: Angelo Chang, Ken Lin, Ted Sun, Nick Yu, Jack Wu, Frank Wu, Tom Jiang, Aaron Chen, and Vic Yang

16. Uncertainty Assessment

The component of uncertainty may generally be categorized according to the methods used to evaluate them. The evaluation of uncertainty by the statistical analysis of a series of observations is termed a Type A evaluation of uncertainty. The evaluation of uncertainty by means other than the statistical analysis of a series of observation is termed a Type B evaluation of uncertainty. Each component of uncertainty, however evaluated, is represented by an estimated standard deviation, termed standard uncertainty, which is determined by the positive square root of the estimated variance.

A Type A evaluation of standard uncertainty may be based on any valid statistical method for treating data. This includes calculating the standard deviation of the mean of a series of independent observations; using the method of least squares to fit a curve to the data in order to estimate the parameter of the curve and their standard deviations; or carrying out an analysis of variance in order to identify and quantify random effects in certain kinds of measurement.

A type B evaluation of standard uncertainty is typically based on scientific judgment using all of the relevant information available. These may include previous measurement data, experience, and knowledge of the behavior and properties of relevant materials and instruments, manufacture’s specification, data provided in calibration reports and uncertainties assigned to reference data taken from handbooks. Broadly speaking, the uncertainty is either obtained from an outdoor source or obtained from an assumed distribution, such as the normal distribution, rectangular or triangular distributions indicated in Table 14.1

Uncertainty Distributions	Normal	Rectangular	Triangular	U-Shape
Multi-plying Factor ^(a)	1/k ^(b)	1/√3	1/√6	1/√2

(a) standard uncertainty is determined as the product of the multiplying factor and the estimated range of variations in the measured quantity

(b) κ is the coverage factor

Table 15.1. Standard Uncertainty for Assumed Distribution

The combined standard uncertainty of the measurement result represents the estimated standard deviation of the result. It is obtained by combining the individual standard uncertainties of both Type A and Type B evaluation using the usual “root-sum-squares” (RSS) methods of combining standard deviations by taking the positive square root of the estimated variances.

Expanded uncertainty is a measure of uncertainty that defines an interval about the measurement result within which the measured value is confidently believed to lie. It is obtained by multiplying the combined standard uncertainty by a coverage factor. Typically, the coverage factor ranges from 2 to 3. Using a coverage factor allows the true value of a measured quantity to be specified with a defined probability within the specified uncertainty range. For purpose of this document, a coverage factor two is used, which corresponds to confidence interval of about 95 %. The DASY uncertainty Budget is shown in the following tables.

Error Description	Uncertainty Value (±%)	Probability Distribution	Divisor	Ci (1g)	Ci (10g)	Standard Uncertainty (1g)	Standard Uncertainty (10g)
Measurement System							
Probe Calibration	6.0	Normal	1	1	1	± 6.0 %	± 6.0 %
Axial Isotropy	4.7	Rectangular	√3	0.7	0.7	± 1.9 %	± 1.9 %
Hemispherical Isotropy	9.6	Rectangular	√3	0.7	0.7	± 3.9 %	± 3.9 %
Boundary Effects	1.0	Rectangular	√3	1	1	± 0.6 %	± 0.6 %
Linearity	4.7	Rectangular	√3	1	1	± 2.7 %	± 2.7 %
System Detection Limits	1.0	Rectangular	√3	1	1	± 0.6 %	± 0.6 %
Readout Electronics	0.3	Normal	1	1	1	± 0.3 %	± 0.3 %
Response Time	0.8	Rectangular	√3	1	1	± 0.5 %	± 0.5 %
Integration Time	2.6	Rectangular	√3	1	1	± 1.5 %	± 1.5 %
RF Ambient Noise	3.0	Rectangular	√3	1	1	± 1.7 %	± 1.7 %
RF Ambient Reflections	3.0	Rectangular	√3	1	1	± 1.7 %	± 1.7 %
Probe Positioner	0.4	Rectangular	√3	1	1	± 0.2 %	± 0.2 %
Probe Positioning	2.9	Rectangular	√3	1	1	± 1.7 %	± 1.7 %
Max. SAR Eval.	1.0	Rectangular	√3	1	1	± 0.6 %	± 0.6 %
Test Sample Related							
Device Positioning	2.9	Normal	1	1	1	± 2.9 %	± 2.9 %
Device Holder	3.6	Normal	1	1	1	± 3.6 %	± 3.6 %
Power Drift	5.0	Rectangular	√3	1	1	± 2.9 %	± 2.9 %
Phantom and Setup							
Phantom Uncertainty	4.0	Rectangular	√3	1	1	± 2.3 %	± 2.3 %
Liquid Conductivity (Target)	5.0	Rectangular	√3	0.64	0.43	± 1.8 %	± 1.2 %
Liquid Conductivity (Meas.)	2.5	Normal	1	0.64	0.43	± 1.6 %	± 1.1 %
Liquid Permittivity (Target)	5.0	Rectangular	√3	0.6	0.49	± 1.7 %	± 1.4 %
Liquid Permittivity (Meas.)	2.5	Normal	1	0.6	0.49	± 1.5 %	± 1.2 %
Combined Standard Uncertainty						± 11.0 %	± 10.8 %
Coverage Factor for 95 %						K=2	
Expanded Uncertainty						± 22.0 %	± 21.5 %

Table 15.2. Uncertainty Budget for frequency range 300 MHz to 3 GHz

Error Description	Uncertainty Value (±%)	Probability Distribution	Divisor	Ci (1g)	Ci (10g)	Standard Uncertainty (1g)	Standard Uncertainty (10g)
Measurement System							
Probe Calibration	6.55	Normal	1	1	1	± 6.55 %	± 6.55 %
Axial Isotropy	4.7	Rectangular	√3	0.7	0.7	± 1.9 %	± 1.9 %
Hemispherical Isotropy	9.6	Rectangular	√3	0.7	0.7	± 3.9 %	± 3.9 %
Boundary Effects	2.0	Rectangular	√3	1	1	± 1.2 %	± 1.2 %
Linearity	4.7	Rectangular	√3	1	1	± 2.7 %	± 2.7 %
System Detection Limits	1.0	Rectangular	√3	1	1	± 0.6 %	± 0.6 %
Readout Electronics	0.3	Normal	1	1	1	± 0.3 %	± 0.3 %
Response Time	0.8	Rectangular	√3	1	1	± 0.5 %	± 0.5 %
Integration Time	2.6	Rectangular	√3	1	1	± 1.5 %	± 1.5 %
RF Ambient Noise	3.0	Rectangular	√3	1	1	± 1.7 %	± 1.7 %
RF Ambient Reflections	3.0	Rectangular	√3	1	1	± 1.7 %	± 1.7 %
Probe Positioner	0.8	Rectangular	√3	1	1	± 0.5 %	± 0.5 %
Probe Positioning	9.9	Rectangular	√3	1	1	± 5.7 %	± 5.7 %
Max. SAR Eval.	4.0	Rectangular	√3	1	1	± 2.3 %	± 2.3 %
Test Sample Related							
Device Positioning	2.9	Normal	1	1	1	± 2.9 %	± 2.9 %
Device Holder	3.6	Normal	1	1	1	± 3.6 %	± 3.6 %
Power Drift	5.0	Rectangular	√3	1	1	± 2.9 %	± 2.9 %
Phantom and Setup							
Phantom Uncertainty	4.0	Rectangular	√3	1	1	± 2.3 %	± 2.3 %
Liquid Conductivity (Target)	5.0	Rectangular	√3	0.64	0.43	± 1.8 %	± 1.2 %
Liquid Conductivity (Meas.)	2.5	Normal	1	0.64	0.43	± 1.6 %	± 1.1 %
Liquid Permittivity (Target)	5.0	Rectangular	√3	0.6	0.49	± 1.7 %	± 1.4 %
Liquid Permittivity (Meas.)	2.5	Normal	1	0.6	0.49	± 1.5 %	± 1.2 %
Combined Standard Uncertainty						± 12.8 %	± 12.6 %
Coverage Factor for 95 %						K=2	
Expanded Uncertainty						± 25.6 %	± 25.2 %

Table 15.3. Uncertainty Budget for frequency range 3 GHz to 6 GHz

17. References

- [1] FCC 47 CFR Part 2 “Frequency Allocations and Radio Treaty Matters; General Rules and Regulations”
- [2] ANSI/IEEE Std. C95.1-1992, “IEEE Standard for Safety Levels with Respect to Human Exposure to Radio Frequency Electromagnetic Fields, 3 kHz to 300 GHz”, September 1992
- [3] IEEE Std. 1528-2003, “Recommended Practice for Determining the Peak Spatial-Average Specific Absorption Rate (SAR) in the Human Head from Wireless Communications Devices: Measurement Techniques”, December 2003
- [4] SPEAG DASY System Handbook
- [5] FCC KDB 248227 D01 v01r02, “SAR Measurement Procedures for 802.11 a/b/g Transmitters”, May 2007
- [6] FCC KDB 447498 D01 v05r01, “Mobile and Portable Device RF Exposure Procedures and Equipment Authorization Policies”, May 2013
- [7] FCC KDB 941225 D03 v01, “Recommended SAR Test Reduction Procedures for GSM / GPRS / EDGE”, December 2008
- [8] FCC KDB 941225 D05 v02r02, “SAR Evaluation Considerations for LTE Devices”, May 2013
- [9] FCC KDB 941225 D01 v02, “SAR Measurement Procedures for 3G Devices – CDMA 2000 / Ev-Do / WCDMA / HSDPA / HSPA”, October 2007
- [10] FCC KDB 941225 D02 v02r02, “SAR Guidance for HSPA, HSPA+, DC-HSDPA and 1x-Advanced”, May 2013.
- [11] FCC KDB 616217 D04 v01r01, “SAR Evaluation Considerations for Laptop, Notebook, Netbook and Tablet Computers”, May 2013
- [12] FCC KDB 865664 D01 v01r01, “SAR Measurement Requirements for 100 MHz to 6 GHz”, May 2013.