

FCC RF Test Report

APPLICANT : Ailen LLC
EQUIPMENT : Digital Media Receiver
MODEL NAME : CL1130
FCC ID : S59-4891
STANDARD : FCC Part 15 Subpart C §15.247
CLASSIFICATION : (DTS) Digital Transmission System

The product was completely tested on Aug. 19, 2013. We, SPORTON INTERNATIONAL INC., would like to declare that the tested sample has been evaluated in accordance with the procedures and shown to be compliant with the applicable technical standards.

The test results in this report apply exclusively to the tested model / sample. Without written approval of SPORTON INTERNATIONAL INC., the test report shall not be reproduced except in full.



Reviewed by: Joseph Lin / Supervisor



Approved by: Jones Tsai / Manager



SPORTON INTERNATIONAL INC.

No. 52, Hwa Ya 1st Rd., Hwa Ya Technology Park, Kwei-Shan Hsiang, Tao Yuan Hsien, Taiwan, R.O.C.

Report No. : FR332717-02B
Report Version : Rev. 01
Page Number : 1 of 46

TABLE OF CONTENTS

REVISION HISTORY	3
SUMMARY OF TEST RESULT	4
1 GENERAL DESCRIPTION	5
1.1 Applicant	5
1.2 Feature of Equipment Under Test	5
1.3 Product Specification of Equipment Under Test.....	5
1.4 Modification of EUT	5
1.5 Testing Site.....	6
1.6 Applied Standards	6
2 TEST CONFIGURATION OF EQUIPMENT UNDER TEST	7
2.1 Descriptions of Test Mode.....	7
2.2 Test Mode.....	8
2.3 Connection Diagram of Test System.....	9
2.4 Support Unit used in test configuration and system	10
2.5 Description of RF Function Operation Test Setup.....	10
2.6 Measurement Results Explanation Example.....	10
3 TEST RESULT	11
3.1 6dB Bandwidth Measurement	11
3.2 Peak Output Power Measurement	14
3.3 Power Spectral Density Measurement	16
3.4 Conducted Band Edges and Spurious Emission Measurement	21
3.5 Radiated Band Edges and Spurious Emission Measurement	29
3.6 AC Conducted Emission Measurement.....	40
3.7 Antenna Requirements.....	44
4 LIST OF MEASURING EQUIPMENT	45
5 UNCERTAINTY OF EVALUATION	46

SUMMARY OF TEST RESULT

Report Section	FCC Rule	Description	Limit	Result	Remark
3.1	15.247(a)(2)	6dB Bandwidth	$\geq 0.5\text{MHz}$	Pass	-
3.2	15.247(b)(1)	Peak Output Power	$\leq 30\text{dBm}$	Pass	-
3.3	15.247(e)	Power Spectral Density	$\leq 8\text{dBm}$	Pass	-
3.4	15.247(d)	Conducted Band Edges and Spurious Emission	$\leq 20\text{dBc}$	Pass	-
3.5	15.247(d)	Radiated Band Edges and Spurious Emission	15.209(a) & 15.247(d)	Pass	Under limit 0.78 dB at 2384.000 MHz
3.6	15.207	AC Conducted Emission	15.207(a)	Pass	Under limit 8.10 dB at 0.502 MHz
3.7	15.203 & 15.247(b)	Antenna Requirement	N/A	Pass	-

1 General Description

1.1 Applicant

Ailen LLC
P.O. Box 8125
Wilmington, DE 19803

1.2 Feature of Equipment Under Test

Product Feature	
Equipment	Digital Media Receiver
Model Name	CL1130
FCC ID	S59-4891
EUT supports Radios application	WLAN 11abgn / Bluetooth 2.1/3.0/4.0

Remark: The above EUT's information was declared by manufacturer. Please refer to the specifications or user's manual for more detailed description.

1.3 Product Specification of Equipment Under Test

Product Specification subjective to this standard	
Tx/Rx Frequency Range	2402 MHz ~ 2480 MHz
Number of Channels	40
Carrier Frequency of Each Channel	40 Channel(37 hopping + 3 advertising channel)
Maximum Output Power to Antenna	2.26 dBm (0.0017 W)
Antenna Type	Fixed Internal Antenna with gain 1.80 dBi
Type of Modulation	Bluetooth 4.0 - LE : GFSK

1.4 Modification of EUT

No modifications are made to the EUT during all test items.

1.5 Testing Site

Test Site	SPORTON INTERNATIONAL INC.			
Test Site Location	No. 52, Hwa Ya 1 st Rd., Hwa Ya Technology Park, Kwei-Shan Hsiang, Tao Yuan Hsien, Taiwan, R.O.C. TEL: +886-3-3273456 / FAX: +886-3-3284978			
Test Site No.	Sporton Site No.			FCC/IC Registration No.
	TH02-HY	CO05-HY	03CH08-HY	636805/4086B

Note: The test site complies with ANSI C63.4 2003 requirement.

1.6 Applied Standards

According to the specifications of the manufacturer, the EUT must comply with the requirements of the following standards:

- FCC Part 15 Subpart C §15.247
- FCC KDB Publication No. 558074 D01 DTS Meas. Guidance v03r01
- ANSI C63.4-2003

Remark:

1. All test items were verified and recorded according to the standards and without any deviation during the test.
2. This EUT has also been tested and complied with the requirements of FCC Part 15, Subpart B, recorded in a separate test report.

2 Test Configuration of Equipment Under Test

2.1 Descriptions of Test Mode

The RF output power was recorded in the following table:

Channel	Frequency	Bluetooth 4.0 – LE RF Output Power
		Data Rate / Modulation
		GFSK
		1Mbps
Ch00	2402MHz	2.26 dBm
Ch19	2440MHz	2.02 dBm
Ch39	2480MHz	1.97 dBm

- a. The EUT has been associated with peripherals and configuration operated in a manner tended to maximize its emission characteristics in a typical application. Frequency range investigated: conduction (150 kHz to 30 MHz), radiation (9 kHz to the 10th harmonic of the highest fundamental frequency or to 40 GHz, whichever is lower). Pre-scanned tests, X, Y, Z in three orthogonal panels to determine the final configuration (Z plane as worst plane) from all possible combinations.
- b. AC power line Conducted Emission was tested under maximum output power.

2.2 Test Mode

The following summary table is showing all test modes to demonstrate in compliance with the standard.

Summary table of Test Cases	
Test Item	Data Rate / Modulation
	Bluetooth 4.0 – LE / GFSK
Conducted TCs	Mode 1: Bluetooth Tx CH00_2402 MHz_1Mbps Mode 2: Bluetooth Tx CH19_2440 MHz_1Mbps Mode 3: Bluetooth Tx CH39_2480 MHz_1Mbps
Radiated TCs	Mode 1: Bluetooth Tx CH00_2402 MHz_1Mbps Mode 2: Bluetooth Tx CH19_2440 MHz_1Mbps Mode 3: Bluetooth Tx CH39_2480 MHz_1Mbps
AC Conducted Emission	Mode 1 :WLAN (2.4G) Link + Bluetooth Link + HDMI Cable + RJ-45 Load + Audio Converter Load + Mouse + MPEG4 + Adapter Mode 2 : WLAN (5G) Link + Bluetooth Link + HDMI Cable + RJ-45 Load + Audio Converter Load + Mouse + MPEG4 + Adapter
Remark: The worst case of conducted emission is mode 1; only the test data of it was reported.	

2.3 Connection Diagram of Test System

<Bluetooth 4.0 – LE Tx Mode>

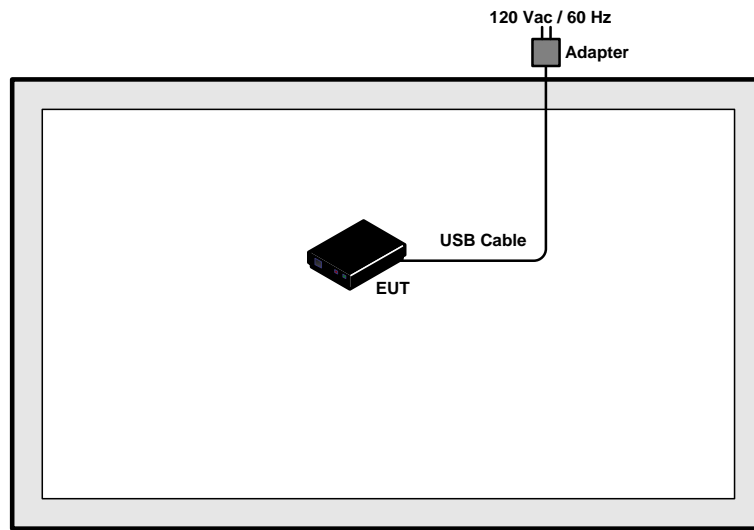

<AC Conducted Emission Mode>

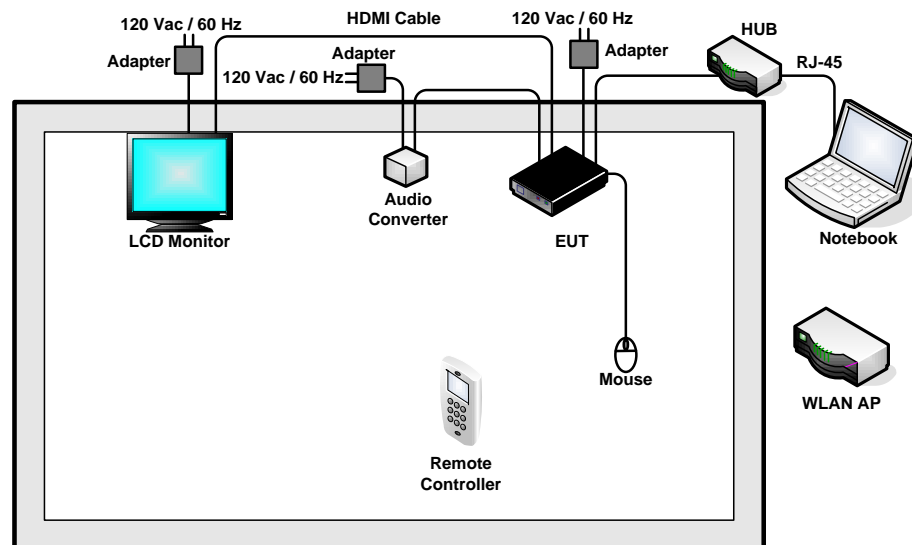

2.4 Support Unit used in test configuration and system

Item	Equipment	Trade Name	Model Name	FCC ID	Data Cable	Power Cord
1.	WLAN AP	D-Link	DIR-628	KA2DIR628A2	N/A	Unshielded, 1.8 m
2.	Mouse	Lenovo	SM-1035	FCC DoC	Shielded, 1.4 m	N/A
3.	Audio Converter	Upmost	1039-CA	FCC DoC	Shielded, 1.0 m	Unshielded, 1.8 m
4.	Notebook	DELL	Latitude E6320	FCC DoC	Unshielded, 3m	AC I/P: Unshielded, 1.2 m DC O/P: Shielded, 1.8 m
5.	LCD Monitor	DELL	U2410	FCC DoC	Shielded, 1.6 m	Unshielded, 1.8 m
6.	HUB	D-Link	DES-1005A	FCC DoC	Unshielded, 3m	Unshielded, 1.4m
7.	Adapter	Foxlink	RE54WE	Verification	N/A	Shielded, 1.5 m
8.	Remote controller	N/A	DU3560	Verification	N/A	N/A

2.5 Description of RF Function Operation Test Setup

For Bluetooth function, the RF utility, "ADB" was installed in notebook which was programmed in order to make the EUT get into the engineering modes for continuous transmitting and receiving signals.

2.6 Measurement Results Explanation Example

For all conducted test items:

The offset level is set in the spectrum analyzer to compensate the RF cable loss and attenuator factor between EUT conducted output port and spectrum analyzer. With the offset compensation, the spectrum analyzer reading level is exactly the EUT RF output level.

Example :

The spectrum analyzer offset is derived from RF cable loss and attenuator factor.

Offset = RF cable loss + attenuator factor.

Following shows an offset computation example with cable loss 4.2 dB and 10dB attenuator.

$$\begin{aligned} \text{Offset(dB)} &= \text{RF cable loss(dB)} + \text{attenuator factor(dB)}. \\ &= 4.2 + 10 = 14.2 \text{ (dB)} \end{aligned}$$

3 Test Result

3.1 6dB Bandwidth Measurement

3.1.1 Limit of 6dB Bandwidth

The minimum 6 dB bandwidth shall be at least 500 kHz.

3.1.2 Measuring Instruments

See list of measuring instruments of this test report.

3.1.3 Test Procedures

1. The testing follows FCC KDB Publication No. 558074 D01 DTS Meas. Guidance v03r01.
2. The RF output of EUT was connected to the spectrum analyzer by RF cable and attenuator. The path loss was compensated to the results for each measurement.
3. Set to the maximum power setting and enable the EUT transmit continuously.
4. Make the measurement with the spectrum analyzer's resolution bandwidth (RBW) = 100 kHz. Set the Video bandwidth (VBW) = 300 kHz. In order to make an accurate measurement. The 6 dB bandwidth must be greater than 500 kHz.
5. Measure and record the results in the test report.

3.1.4 Test Setup

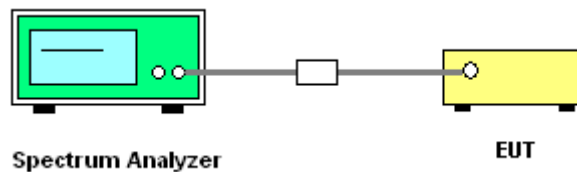

3.1.5 Test Result of 6dB Bandwidth

Test Mode :	Bluetooth 4.0 - LE	Temperature :	22~25°C
Test Engineer :	Reece Lee	Relative Humidity :	51~55%

Channel	Frequency (MHz)	6dB Bandwidth (MHz)	6dB Bandwidth Min. Limit (MHz)	Pass/Fail
00	2402	0.656	0.5	Pass
19	2440	0.652	0.5	Pass
39	2480	0.654	0.5	Pass

6 dB Bandwidth Plot on Channel 00

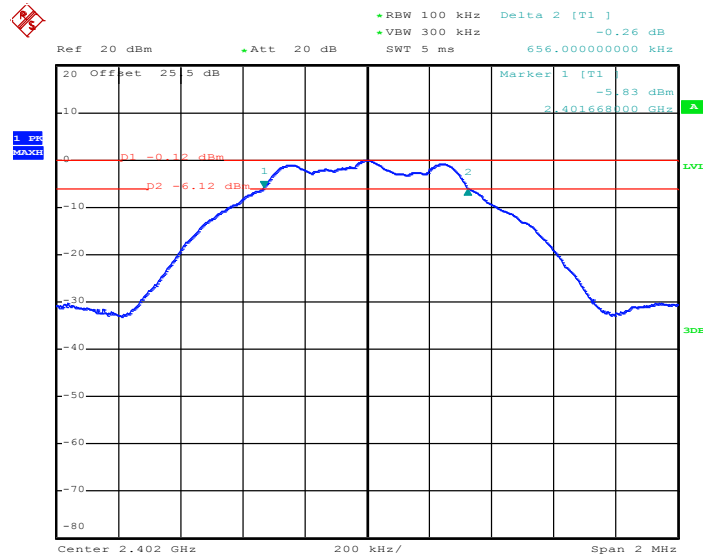

Date: 4.AUG.2013 09:04:34

6 dB Bandwidth Plot on Channel 19

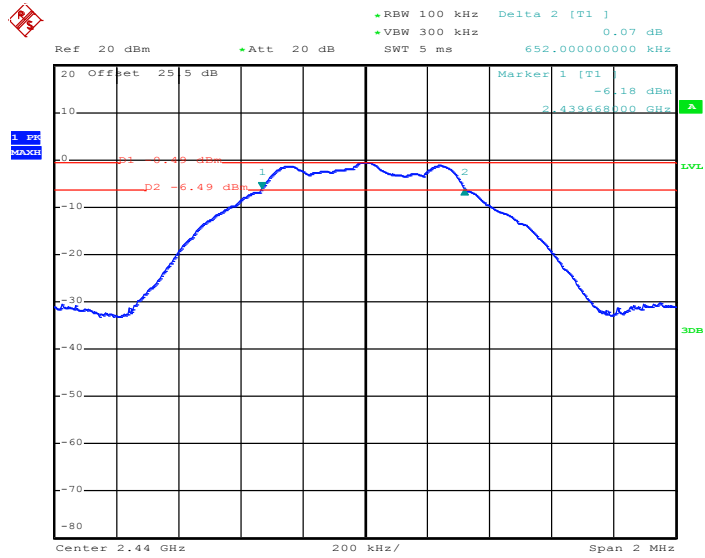

Date: 4.AUG.2013 09:07:51

6 dB Bandwidth Plot on Channel 39

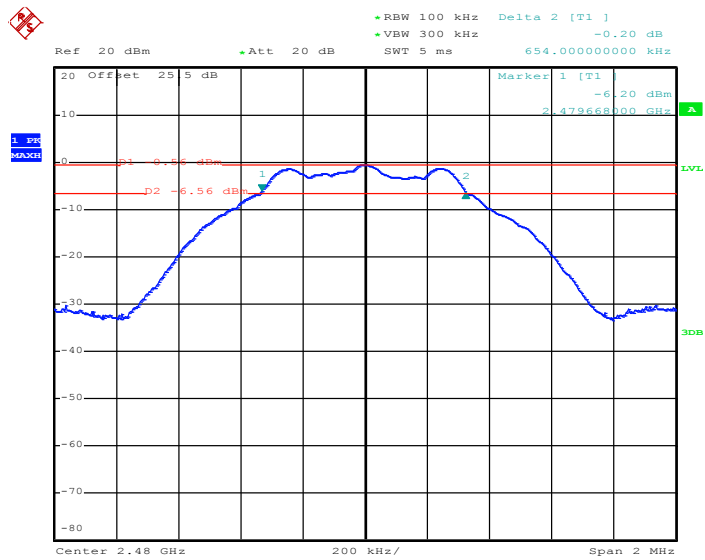

Date: 4.AUG.2013 09:10:42

3.2 Peak Output Power Measurement

3.2.1 Limit of Peak Output Power

For systems using digital modulation in the 2400-2483.5MHz, the limit for peak output power is 30dBm. If transmitting antenna of directional gain greater than 6dBi is used, the peak output power from the intentional radiator shall be reduced below the above stated value by the amount in dB that the directional gain of the antenna exceeds 6 dBi. In case of point-to-point operation, the limit has to be reduced by 1dB for every 3dB that the directional gain of the antenna exceeds 6dBi.

3.2.2 Measuring Instruments

See list of measuring instruments of this test report.

3.2.3 Test Procedures

1. The testing follows the Measurement Procedure of FCC KDB No. 558074 DTS D01 Meas. Guidance v03r01.
2. The RF output of EUT was connected to the power meter by RF cable and attenuator. The path loss was compensated to the results for each measurement.
3. Set to the maximum power setting and enable the EUT transmit continuously.
4. Measure the conducted output power and record the results in the test report.

3.2.4 Test Setup

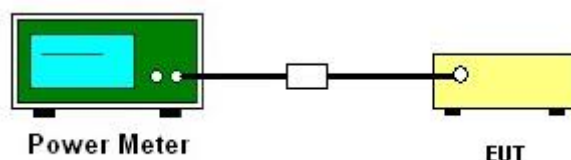

3.2.5 Test Result of Peak Output Power

Test Mode :	Bluetooth 4.0 - LE	Temperature :	22~25°C
Test Engineer :	Reece Lee	Relative Humidity :	51~55%

Channel	Frequency (MHz)	RF Power (dBm)		
		GFSK	Max. Limits (dBm)	Pass/Fail
		1 Mbps		
00	2402	2.26	30.00	Pass
19	2440	2.02	30.00	Pass
39	2480	1.97	30.00	Pass

3.3 Power Spectral Density Measurement

3.3.1 Limit of Power Spectral Density

The peak power spectral density shall not be greater than 8dBm in any 3kHz band at any time interval of continuous transmission.

3.3.2 Measuring Instruments

See list of measuring instruments of this test report.

3.3.3 Test Procedures

1. The testing follows Measurement Procedure 10.2 Method PKPSD of FCC KDB Publication No. 558074 D01 DTS Meas. Guidance v03r01
2. The RF output of EUT was connected to the spectrum analyzer by RF cable and attenuator. The path loss was compensated to the results for each measurement.
3. Set to the maximum power setting and enable the EUT transmit continuously.
4. Make the measurement with the spectrum analyzer's resolution bandwidth (RBW) = 3 kHz. Video bandwidth VBW = 10 kHz In order to make an accurate measurement, set the span to 1.5 times DTS Channel Bandwidth. (6dB BW)
5. Detector = peak, Sweep time = auto couple, Trace mode = max hold, Allow trace to fully stabilize. Use the peak marker function to determine the maximum power level.
6. Measure and record the results in the test report.
7. The Measured power density (dBm)/ 100kHz is a reference level and used as 20dBc down limit line for Conducted Band Edges and Conducted Spurious Emission.

3.3.4 Test Setup

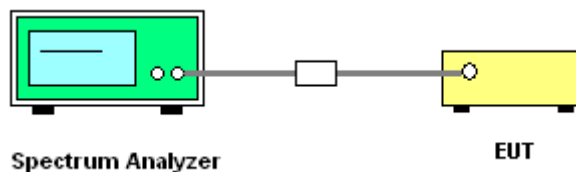

3.3.5 Test Result of Power Spectral Density

Test Mode :	Bluetooth 4.0 - LE	Temperature :	22~25°C
Test Engineer :	Reece Lee	Relative Humidity :	51~55%

Channel	Frequency (MHz)	Power Density		Max. Limits (dBm/3kHz)	Pass/Fail
		PSD/100kHz (dBm)	PSD/3kHz (dBm)		
00	2402	-0.12	-14.91	8	Pass
19	2440	-0.47	-15.35	8	Pass
39	2480	-0.56	-15.28	8	Pass

Note:

1. Measured power density (dBm) has offset with cable loss.
2. The Measured power density (dBm)/ 100kHz is reference level and used as 20dBc down for Conducted Band Edges and Conducted Spurious Emission limit line.

3.3.6 Test Result of Power Spectral Density Plots (100kHz)

PSD 100kHz Plot on Channel 00

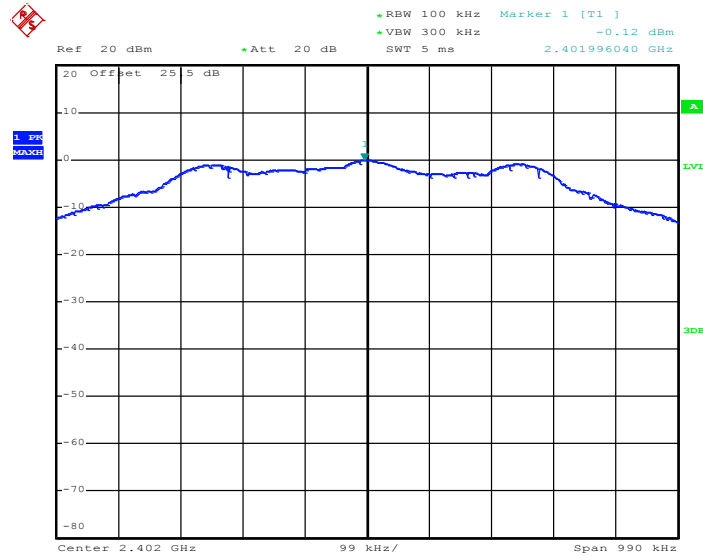

Date: 4.AUG.2013 09:05:06

PSD 100kHz Plot on Channel 19

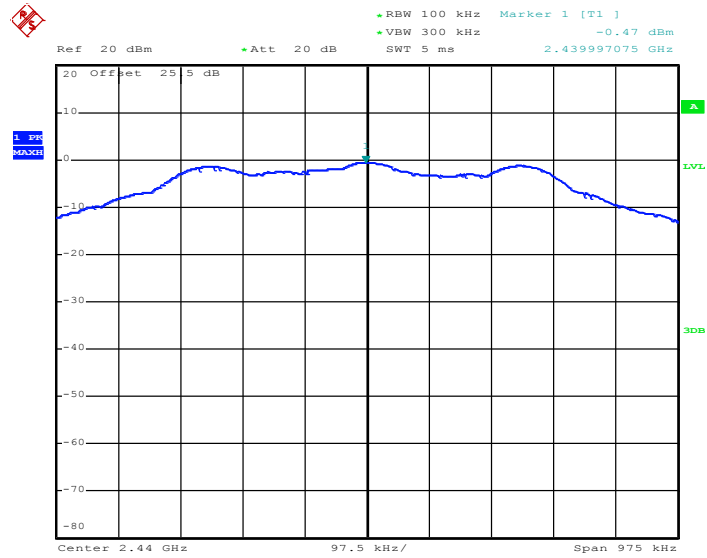

Date: 4.AUG.2013 09:08:22

PSD 100kHz Plot on Channel 39

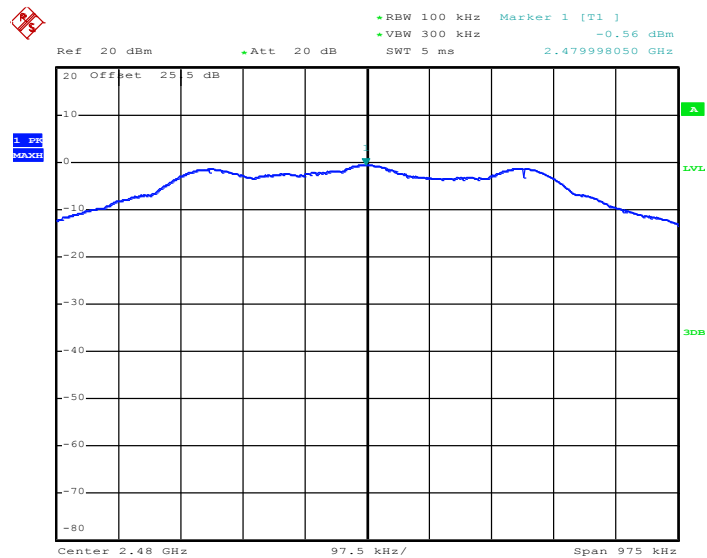

Date: 4.AUG.2013 09:11:21

3.3.7 Test Result of Power Spectral Density Plots (3kHz)

PSD 3kHz Plot on Channel 00

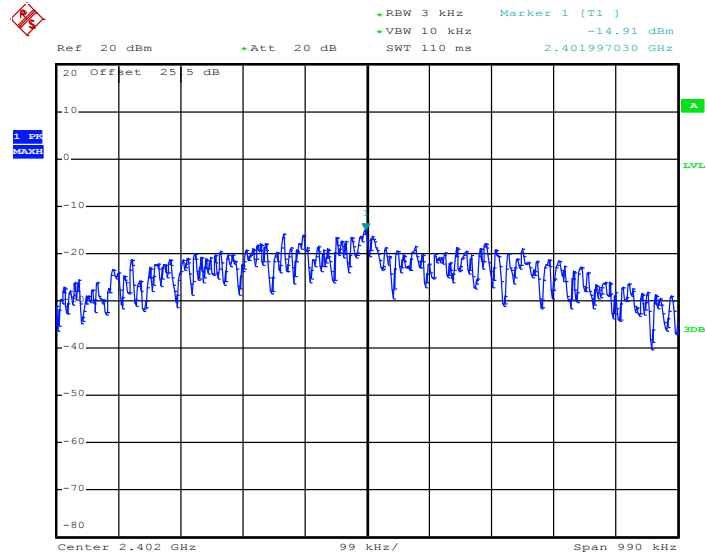

Date: 4.AUG.2013 09:04:57

PSD 3kHz Plot on Channel 19

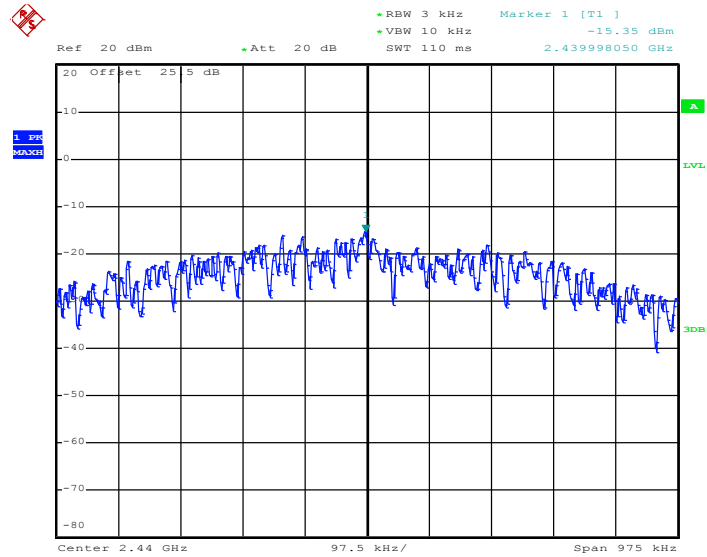

Date: 4.AUG.2013 09:08:12

PSD 3kHz Plot on Channel 39

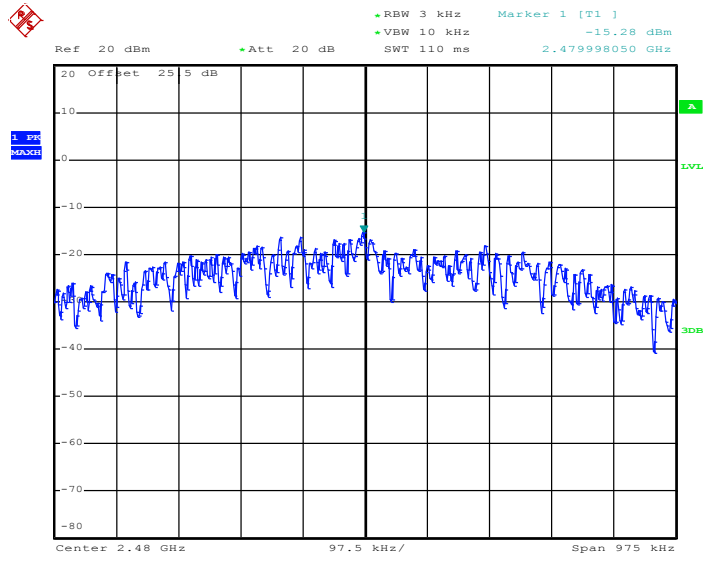

Date: 4.AUG.2013 09:11:03

3.4 Conducted Band Edges and Spurious Emission Measurement

3.4.1 Limit of Conducted Band Edges and Spurious Emission

All harmonics/spurious must be at least 20 dB down from the highest emission level within the authorized band.

3.4.2 Measuring Instruments

See list of measuring instruments of this test report.

3.4.3 Test Procedure

1. The testing follows FCC KDB Publication No. 558074 D01 DTS Meas. Guidance v03r01.
2. The RF output of EUT was connected to the spectrum analyzer by RF cable and attenuator. The path loss was compensated to the results for each measurement.
3. Set to the maximum power setting and enable the EUT transmit continuously.
4. Set RBW = 100 kHz, VBW=300 kHz, Peak Detector. Unwanted Emissions measured in any 100 kHz bandwidth outside of the authorized frequency band shall be attenuated by at least 20 dB relative to the maximum in-band peak PSD level in 100 kHz when maximum peak conducted output power procedure is used. If the transmitter complies with the conducted power limits based on the use of RMS averaging over a time interval, the attenuation required under this paragraph shall be 30 dB instead of 20 dB per 15.247(d).
5. Measure and record the results in the test report.
6. The RF fundamental frequency should be excluded against the limit line in the operating frequency band.

3.4.4 Test Setup

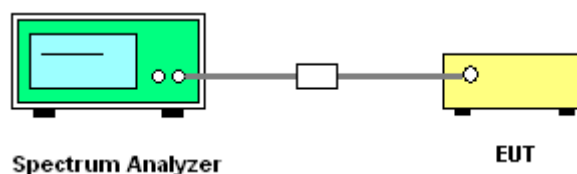

3.4.5 Test Result of Conducted Band Edges

Test Mode :	Bluetooth 4.0 - LE	Temperature :	22~25°C
Test Channel :	00 and 39	Relative Humidity :	51~55%
		Test Engineer :	Reece Lee

Low Band Edge Plot on Channel 00

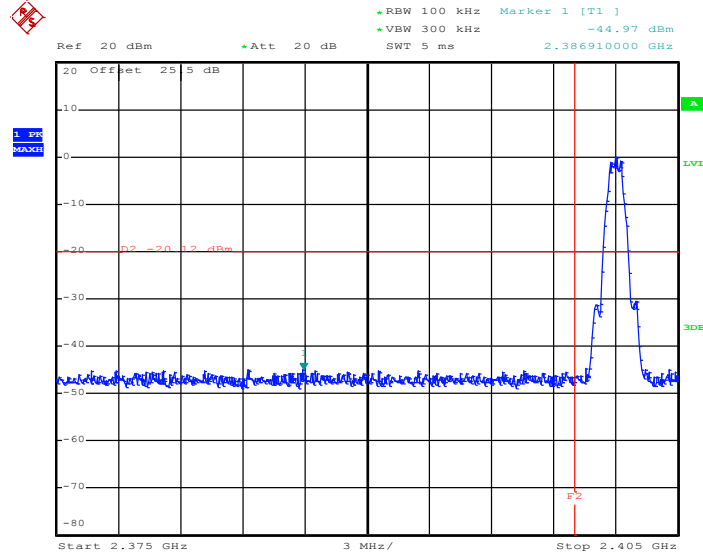

Date: 4.AUG.2013 09:05:25

High Band Edge Plot on Channel 39

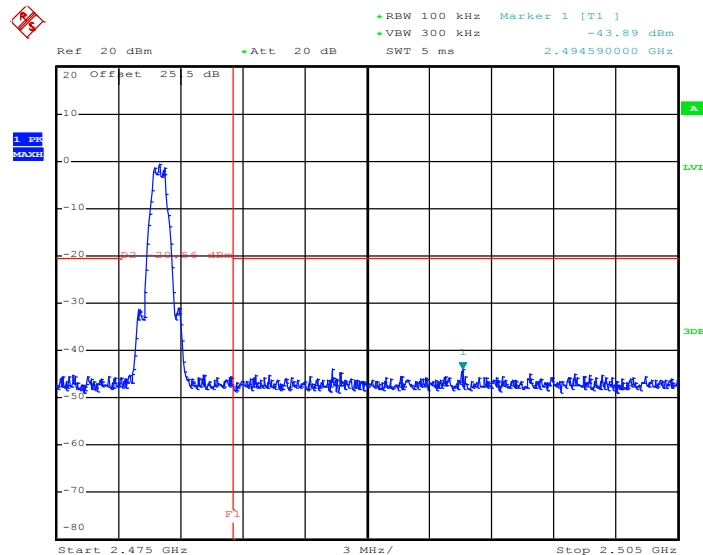

Date: 4.AUG.2013 09:11:42

3.4.6 Test Result of Conducted Spurious Emission

Test Mode :	Bluetooth 4.0 - LE	Temperature :	22~25°C
Test Channel :	00	Relative Humidity :	51~55%
		Test Engineer :	Reece Lee

Conducted Spurious Emission Plot on Bluetooth LE 1Mbps GFSK Channel 00

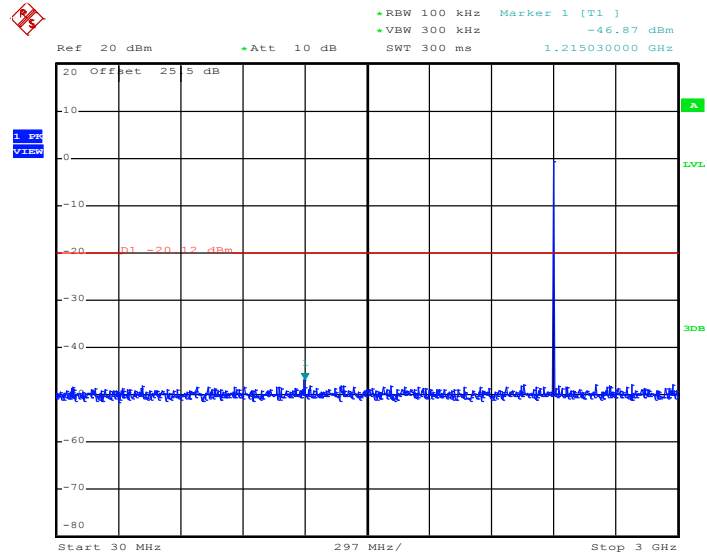

Date: 4.AUG.2013 09:05:56

Conducted Spurious Emission Plot on Bluetooth LE 1Mbps GFSK Channel 00

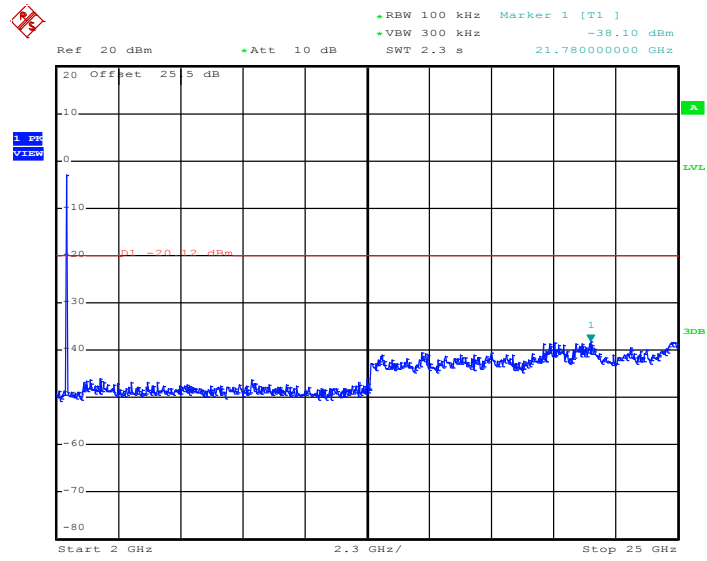

Date: 4.AUG.2013 09:06:15

Test Mode :	Bluetooth 4.0 - LE	Temperature :	22~25°C
Test Channel :	19	Relative Humidity :	51~55%
		Test Engineer :	Reece Lee

**Conducted Spurious Emission Plot on Bluetooth LE 1Mbps
GFSK Channel 19**

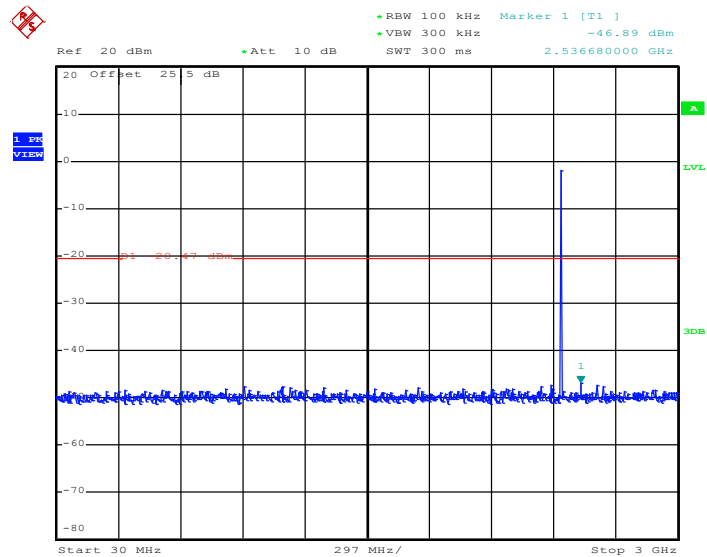

Date: 4.AUG.2013 09:08:45

Conducted Spurious Emission Plot on Bluetooth LE 1Mbps GFSK Channel 19

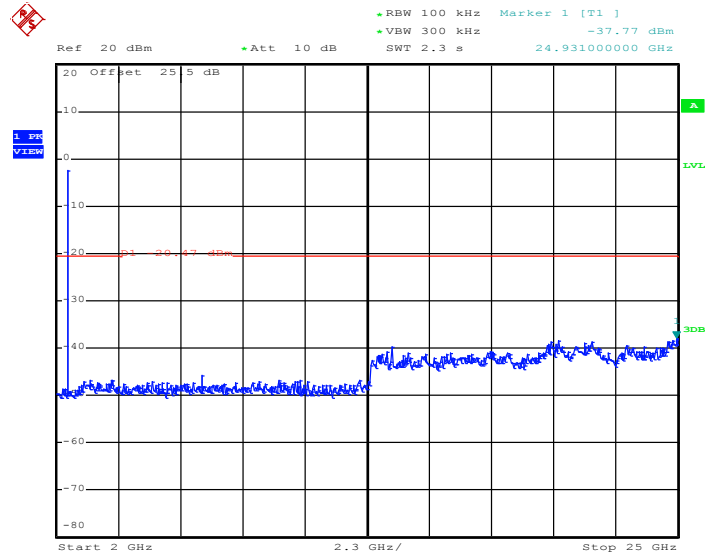

Date: 4.AUG.2013 09:09:04

Test Mode :	Bluetooth 4.0 - LE	Temperature :	22~25°C
Test Channel :	39	Relative Humidity :	51~55%
		Test Engineer :	Reece Lee

**Conducted Spurious Emission Plot on Bluetooth LE 1Mbps
GFSK Channel 39**

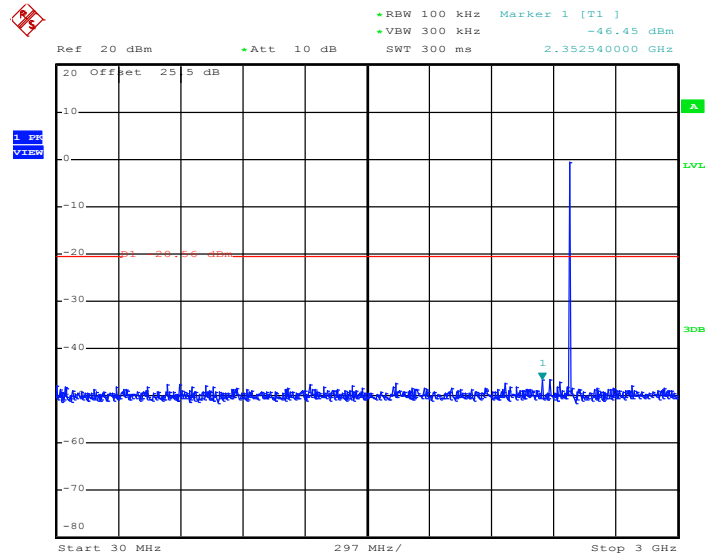

Date: 4.AUG.2013 09:12:03

Conducted Spurious Emission Plot on Bluetooth LE 1Mbps GFSK Channel 39

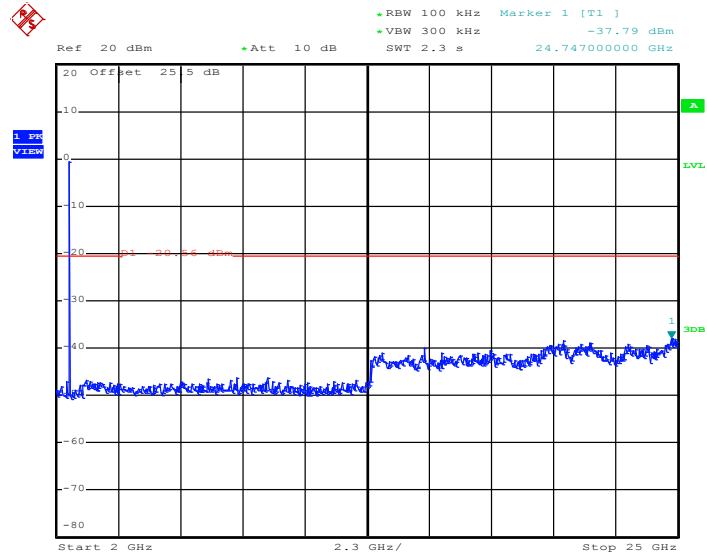

Date: 4.AUG.2013 09:12:22

3.5 Radiated Band Edges and Spurious Emission Measurement

3.5.1 Limit of Radiated Band Edges and Spurious Emission

In any 100 kHz bandwidth outside the intentional radiator frequency band, all harmonics/spurious must be at least 20 dB below the highest emission level within the authorized band. If the output power of this device was measured by spectrum analyzer, the attenuation under this paragraph shall be 30 dB instead of 20 dB. In addition, radiated emissions which fall in the restricted bands must also comply with the FCC section 15.209 limits as below.

Frequency (MHz)	Field Strength (microvolts/meter)	Measurement Distance (meters)
0.009 – 0.490	2400/F(kHz)	300
0.490 – 1.705	24000/F(kHz)	30
1.705 – 30.0	30	30
30 – 88	100	3
88 – 216	150	3
216 - 960	200	3
Above 960	500	3

3.5.2 Measuring Instruments

See list of measuring instruments of this test report.

3.5.3 Test Procedures

1. The testing follows FCC KDB Publication No. 558074 D01 DTS Meas. Guidance v03r01.
2. The EUT was arranged to its worst case and then tune the antenna tower (from 1 m to 4 m) and turntable (from 0 degree to 360 degrees) to find the maximum reading. A pre-amp and a high pass filter are used for the test in order to get better signal level.
3. The EUT was placed on a turntable with 0.8 meter above ground.
4. The EUT was set 3 meters from the interference receiving antenna, which was mounted on the top of a variable height antenna tower.
5. Corrected Reading: Antenna Factor + Cable Loss + Read Level - Preamp Factor = Level
6. For measurement below 1GHz, If the emission level of the EUT measured by the peak detector is 3 dB lower than the applicable limit, the peak emission level will be reported. Otherwise, the emission measurement will be repeated using the quasi-peak detector and reported.
7. Use the following spectrum analyzer settings:
 - (1) Span shall wide enough to fully capture the emission being measured;
 - (2) Set RBW=100 kHz for $f < 1$ GHz; $VBW \geq RBW$; Sweep = auto; Detector function = peak; Trace = max hold;
 - (3) Set RBW = 1 MHz, VBW= 3MHz for $f \geq 1$ GHz for peak measurement.
 For average measurement:
 - $VBW = 10$ Hz, when duty cycle is no less than 98 percent.
 - $VBW \geq 1/T$, when duty cycle is less than 98 percent where T is the minimum transmission duration over which the transmitter is on and is transmitting at its maximum power control level for the tested mode of operation.

Band	Duty Cycle(%)	T(μ s)	1/T(kHz)	VBW Setting
Bluetooth 4.0 - LE	65.19	412.00	2.43	3kHz

3.5.4 Test Setup

For radiated emissions below 30MHz

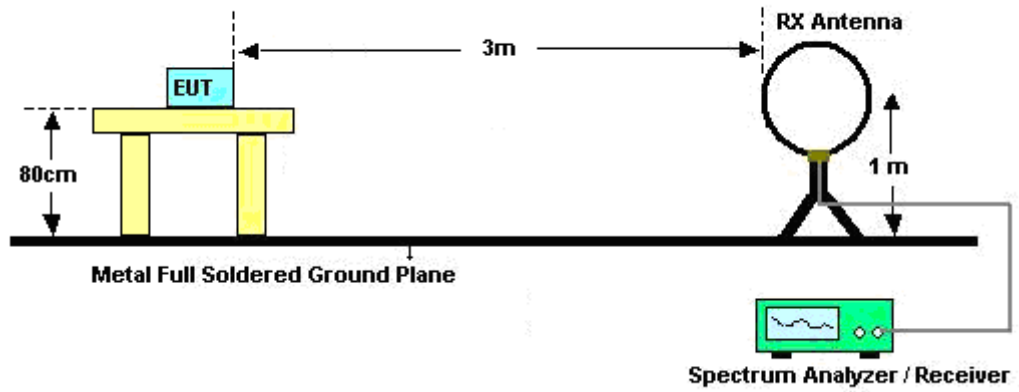

For radiated emissions from 30MHz to 1GHz

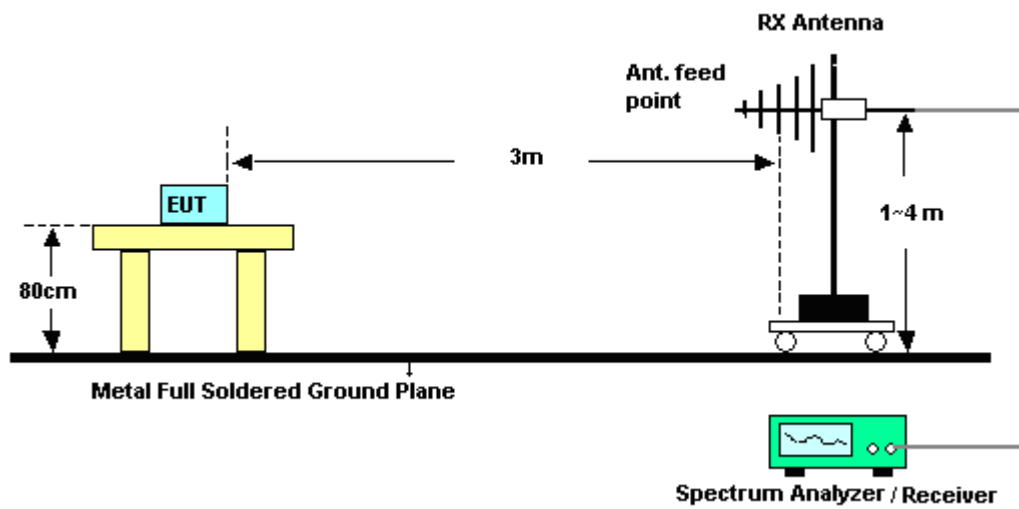

For radiated emissions above 1GHz

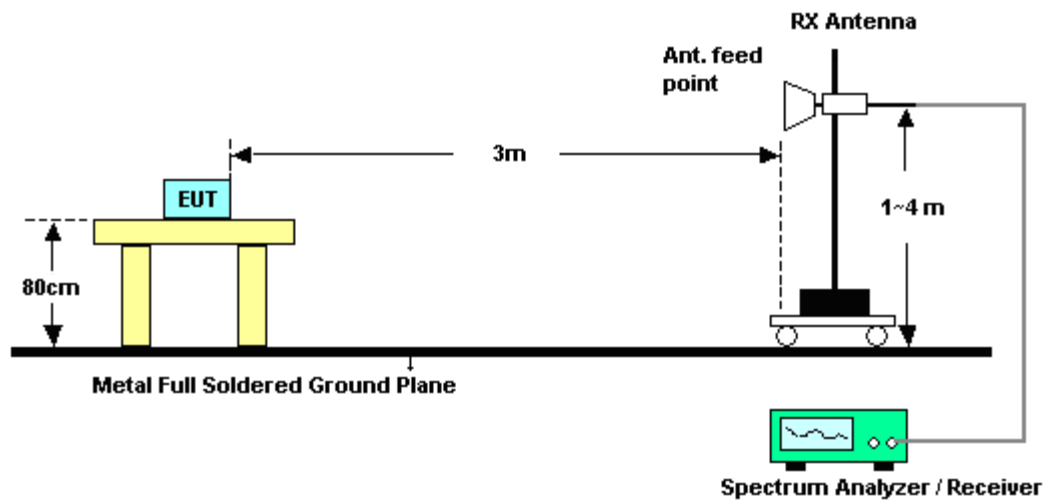

3.5.5 Test Results of Radiated Spurious Emissions (9 kHz ~ 30 MHz)

The low frequency, which started from 9 kHz to 30MHz, was pre-scanned and the result which was 20dB lower than the limit line per 15.31(o) was not reported.

3.5.6 Test Result of Radiated Spurious at Band Edges

Test Mode :	Mode 1	Temperature :	23~24°C
Test Channel :	00	Relative Humidity :	51~52%
		Test Engineer :	Jet Lui

ANTENNA POLARITY : HORIZONTAL										
Frequency (MHz)	Level (dB μ V / m)	Over Limit (dB)	Limit Line (dB μ V / m)	Read Level (dB μ V)	Antenna Factor (dB)	Cable Loss (dB)	Preamp Factor (dB)	Ant Pos (cm)	Table Pos (deg)	Remark
2353.74	59.2	-14.8	74	56.83	32.13	6.19	35.95	113	159	Peak
2354.1	50.93	-3.07	54	48.56	32.13	6.19	35.95	113	159	Average

ANTENNA POLARITY : VERTICAL										
Frequency (MHz)	Level (dB μ V / m)	Over Limit (dB)	Limit Line (dB μ V / m)	Read Level (dB μ V)	Antenna Factor (dB)	Cable Loss (dB)	Preamp Factor (dB)	Ant Pos (cm)	Table Pos (deg)	Remark
2353.56	58.39	-15.61	74	56.31	31.84	6.19	35.95	100	92	Peak
2354.28	46.82	-7.18	54	44.74	31.84	6.19	35.95	100	92	Average

Test Mode :	Mode 3	Temperature :	23~24°C
Test Channel :	39	Relative Humidity :	51~52%
		Test Engineer :	Jet Lui

ANTENNA POLARITY : HORIZONTAL										
Frequency (MHz)	Level (dB μ V / m)	Over Limit (dB)	Limit Line (dB μ V / m)	Read Level (dB μ V)	Antenna Factor (dB)	Cable Loss (dB)	Preamp Factor (dB)	Ant Pos (cm)	Table Pos (deg)	Remark
2484.19	58.62	-15.38	74	55.37	32.63	6.45	35.83	148	212	Peak
2483.5	46.81	-7.19	54	43.56	32.63	6.45	35.83	148	212	Average

ANTENNA POLARITY : VERTICAL										
Frequency (MHz)	Level (dB μ V / m)	Over Limit (dB)	Limit Line (dB μ V / m)	Read Level (dB μ V)	Antenna Factor (dB)	Cable Loss (dB)	Preamp Factor (dB)	Ant Pos (cm)	Table Pos (deg)	Remark
2494.81	57.46	-16.54	74	54.11	32.7	6.45	35.8	152	92	Peak
2483.65	46.22	-7.78	54	43.01	32.59	6.45	35.83	152	92	Average

3.5.7 Test Result of Radiated Spurious Emission (30MHz ~ 10th Harmonic)

Note: Pre-scanned all test modes and only choose the worst case mode recorded in the test report for radiated spurious emission below 1GHz.

Test Mode :	Mode 1	Temperature :	23~24°C
Test Channel :	00	Relative Humidity :	51~52%
Test Engineer :	Jet Lui	Polarization :	Horizontal
Remark :	<ol style="list-style-type: none"> 2402 MHz is fundamental signal which can be ignored. 7206 MHz is not within a restricted band, and its limit line is 20dB below the highest emission level. For example, 103.41 dB μ V/m - 20dB=83.41dB μ V/m. Average measurement was not performed if peak level went lower than the average limit. 		

Frequency (MHz)	Level (dB μ V/m)	Over Limit (dB)	Limit Line (dB μ V/m)	Read Level (dB μ V)	Antenna Factor (dB)	Cable Loss (dB)	Preamp Factor (dB)	Ant Pos (cm)	Table Pos (deg)	Remark
2402	102.05	-	-	99.46	32.27	6.22	35.9	113	159	Average
2402	103.41	-	-	100.82	32.27	6.22	35.9	113	159	Peak
2498	51.2	-2.8	54	47.85	32.7	6.45	35.8	113	159	Average
2498	59.15	-14.85	74	55.8	32.7	6.45	35.8	113	159	Peak
4804	44.75	-29.25	74	57.85	34.46	8	55.56	100	0	Peak
7206	47.19	-36.22	83.41	57.57	35.62	10.49	56.49	100	0	Peak

Note: Other harmonics are lower than background noise.

Test Mode :	Mode 1	Temperature :	23~24°C
Test Channel :	00	Relative Humidity :	51~52%
Test Engineer :	Jet Lui	Polarization :	Vertical
Remark :	<ol style="list-style-type: none"> 1. 2402 MHz is fundamental signal which can be ignored. 2. 7206 MHz is not within a restricted band, and its limit line is 20dB below the highest emission level. 3. Average measurement was not performed if peak level went lower than the average limit. 		

Frequency (MHz)	Level (dB μ V/m)	Over Limit (dB)	Limit Line (dB μ V/m)	Read Level (dB μ V)	Antenna Factor (dB)	Cable Loss (dB)	Preamp Factor (dB)	Ant Pos (cm)	Table Pos (deg)	Remark
2402	97.86	-	-	95.48	32.06	6.22	35.9	100	92	Average
2402	99.2	-	-	96.82	32.06	6.22	35.9	100	92	Peak
4804	45.38	-28.62	74	58.48	34.46	8	55.56	100	0	Peak
7206	46.73	-32.47	79.2	57.13	35.6	10.49	56.49	100	0	Peak

Note: Other harmonics are lower than background noise.

Test Mode :	Mode 2	Temperature :	23~24°C
Test Channel :	19	Relative Humidity :	51~52%
Test Engineer :	Jet Lui	Polarization :	Horizontal
Remark :	<ol style="list-style-type: none"> 1. 2440 MHz is fundamental signal which can be ignored. 2. 2392 MHz and 2536 MHz are not within a restricted band, and its limit line is 20dB below the highest emission level. 3. Average measurement was not performed if peak level went lower than the average limit. 		

Frequency (MHz)	Level (dBμV/m)	Over Limit (dB)	Limit Line (dBμV/m)	Read Level (dBμV)	Antenna Factor (dB)	Cable Loss (dB)	Preamp Factor (dB)	Ant Pos (cm)	Table Pos (deg)	Remark
2344	51.4	-2.6	54	49.1	32.06	6.19	35.95	110	160	Average
2344	58.97	-15.03	74	56.67	32.06	6.19	35.95	110	160	Peak
2392	60.07	-23.36	83.43	57.48	32.27	6.22	35.9	110	160	Peak
2440	102.14	-	-	99.19	32.49	6.34	35.88	110	160	Average
2440	103.43	-	-	100.48	32.49	6.34	35.88	110	160	Peak
2488	53.03	-0.97	54	49.71	32.7	6.45	35.83	110	160	Average
2488	60.18	-13.82	74	56.86	32.7	6.45	35.83	110	160	Peak
2536	59.08	-24.35	83.43	55.79	32.57	6.53	35.81	110	160	Peak
4881	44.46	-29.54	74	57.59	34.4	8.15	55.68	100	0	Peak
7320	48.74	-25.26	74	58.88	35.63	10.47	56.24	100	0	Peak

Note: Other harmonics are lower than background noise.

Test Mode :	Mode 2	Temperature :	23~24°C
Test Channel :	19	Relative Humidity :	51~52%
Test Engineer :	Jet Lui	Polarization :	Vertical
Remark :	1. 2440 MHz is fundamental signal which can be ignored.. 2. Average measurement was not performed if peak level went lower than the average limit.		

Frequency (MHz)	Level (dBμV/m)	Over Limit (dB)	Limit Line (dBμV/m)	Read Level (dBμV)	Antenna Factor (dB)	Cable Loss (dB)	Preamp Factor (dB)	Ant Pos (cm)	Table Pos (deg)	Remark
2440	99.16	-	-	96.32	32.38	6.34	35.88	121	265	Average
2440	100.45	-	-	97.61	32.38	6.34	35.88	121	265	Peak
4881	45.53	-28.47	74	58.66	34.4	8.15	55.68	100	0	Peak
7320	47.85	-26.15	74	58.08	35.54	10.47	56.24	100	0	Peak

Note: Other harmonics are lower than background noise.

Test Mode :	Mode 3	Temperature :	23~24°C
Test Channel :	39	Relative Humidity :	51~52%
Test Engineer :	Jet Lui	Polarization :	Horizontal
Remark :	1. 2480 MHz is fundamental signal which can be ignored. 2. 2528 MHz is not within a restricted band, and its limit line is 20dB below the highest emission level. 3. Average measurement was not performed if peak level went lower than the average limit.		

Frequency (MHz)	Level (dB μ V/m)	Over Limit (dB)	Limit Line (dB μ V/m)	Read Level (dB μ V)	Antenna Factor (dB)	Cable Loss (dB)	Preamp Factor (dB)	Ant Pos (cm)	Table Pos (deg)	Remark
66.72	14.53	-25.47	40	40.34	5.16	0.97	31.94	-	-	Peak
154.2	18.76	-24.74	43.5	39.36	9.74	1.46	31.8	-	-	Peak
252.48	28.62	-17.38	46	46.29	12.24	1.84	31.75	100	254	Peak
325.2	21.74	-24.26	46	37.66	13.7	2.09	31.71	-	-	Peak
748	20.49	-25.51	46	28.29	19.94	3.15	30.89	-	-	Peak
950.3	21.88	-24.12	46	27.89	20.94	3.57	30.52	-	-	Peak
2384	53.22	-0.78	54	50.72	32.2	6.22	35.92	109	33	Average
2384	59.22	-14.78	74	56.72	32.2	6.22	35.92	109	33	Peak
2480	103.77	-	-	100.52	32.63	6.45	35.83	109	33	Average
2480	104.99	-	-	101.74	32.63	6.45	35.83	109	33	Peak
2528	59.08	-25.91	84.99	55.79	32.57	6.53	35.81	109	33	Peak
4960	45.91	-28.09	74	59.16	34.33	8.26	55.84	100	0	Peak
7440	47.94	-26.06	74	57.79	35.68	10.47	56	100	0	Peak

Note: Other harmonics are lower than background noise.

Test Mode :	Mode 3	Temperature :	23~24°C
Test Channel :	39	Relative Humidity :	51~52%
Test Engineer :	Jet Lui	Polarization :	Vertical
Remark :	1. 2480 MHz is fundamental signal which can be ignored. 2. Average measurement was not performed if peak level went lower than the average limit.		

Frequency (MHz)	Level (dB μ V/m)	Over Limit (dB)	Limit Line (dB μ V/m)	Read Level (dB μ V)	Antenna Factor (dB)	Cable Loss (dB)	Preamp Factor (dB)	Ant Pos (cm)	Table Pos (deg)	Remark
30.27	27.54	-12.46	40	37.3	21.66	0.64	32.06	100	117	Peak
153.39	23.13	-20.37	43.5	42.54	10.93	1.46	31.8	-	-	Peak
268.95	19.87	-26.13	46	37.03	12.64	1.91	31.71	-	-	Peak
358.1	18.1	-27.9	46	32.97	14.67	2.18	31.72	-	-	Peak
673.1	22.77	-23.23	46	31.9	18.87	2.99	30.99	-	-	Peak
894.3	21.82	-24.18	46	28.24	20.73	3.48	30.63	-	-	Peak
2480	98.94	-	-	95.73	32.59	6.45	35.83	100	89	Average
2480	99.86	-	-	96.65	32.59	6.45	35.83	100	89	Peak
4960	47.27	-26.73	74	60.52	34.33	8.26	55.84	100	0	Peak
7440	47.45	-26.55	74	57.54	35.44	10.47	56	100	0	Peak

Note: Other harmonics are lower than background noise.

3.6 AC Conducted Emission Measurement

3.6.1 Limit of AC Conducted Emission

For equipment that is designed to be connected to the public utility (AC) power line, the radio frequency voltage that is conducted back onto the AC power line on any frequency or frequencies within the band 150 kHz to 30 MHz shall not exceed the limits in the following table.

Frequency of emission (MHz)	Conducted limit (dB μ V)	
	Quasi-peak	Average
0.15-0.5	66 to 56*	56 to 46*
0.5-5	56	46
5-30	60	50

*Decreases with the logarithm of the frequency.

3.6.2 Measuring Instruments

See list of measuring instruments of this test report.

3.6.3 Test Procedures

1. The EUT was placed 0.4 meter from the conducting wall of the shielding room was kept at least 80 centimeters from any other grounded conducting surface.
2. Connect EUT to the power mains through a line impedance stabilization network (LISN).
3. All the support units are connecting to the other LISN.
4. The LISN provides 50 ohm coupling impedance for the measuring instrument.
5. The FCC states that a 50 ohm, 50 microhenry LISN should be used.
6. Both sides of AC line were checked for maximum conducted interference.
7. The frequency range from 150 kHz to 30 MHz was searched.
8. Set the test-receiver system to Peak Detect Function and specified bandwidth with Maximum Hold Mode.

3.6.4 Test Setup

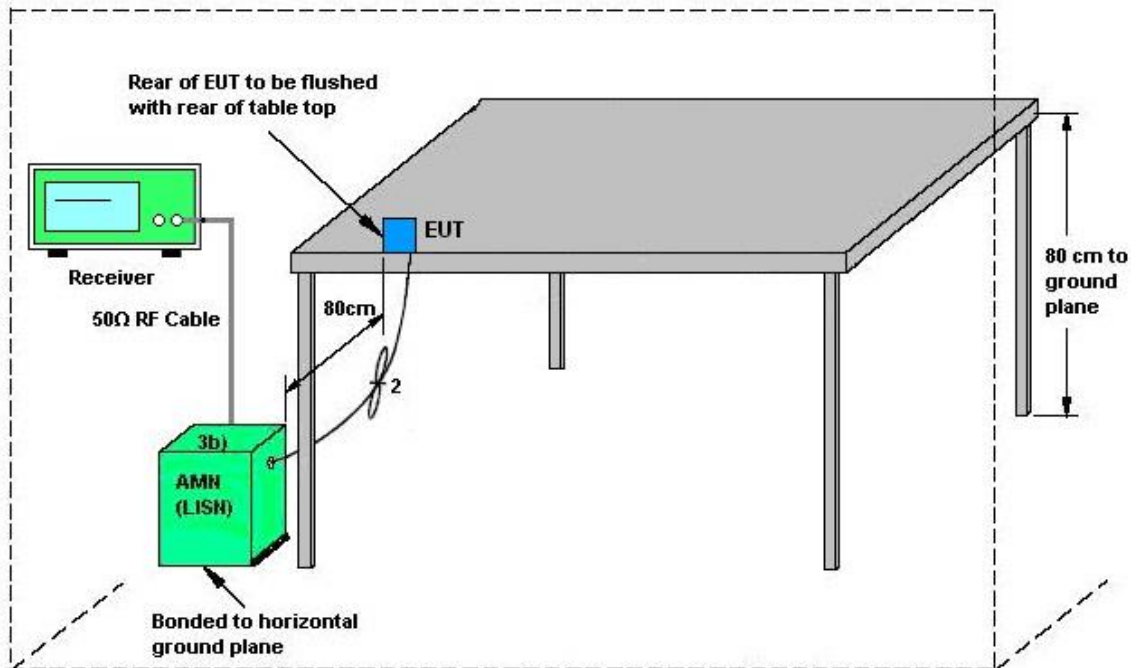

AMN = Artificial mains network (LISN)
AE = Associated equipment
EUT = Equipment under test
ISN = Impedance stabilization network

3.6.5 Test Result of AC Conducted Emission

Test Mode :	Mode 1	Temperature :	20~22°C
Test Engineer :	Kai-Chun Chu	Relative Humidity :	45~47%
Test Voltage :	120Vac / 60Hz	Phase :	Line
Function Type :	WLAN (2.4G) Link + Bluetooth Link + HDMI Cable + RJ-45 Load + Audio Converter Load + Mouse + MPEG4 + Adapter		

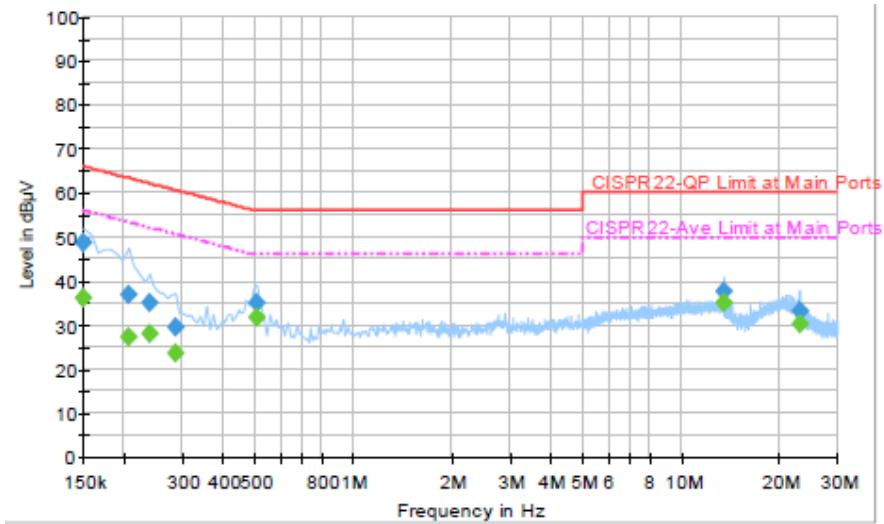

Final Result : Quasi-Peak

Frequency (MHz)	Quasi-Peak (dBµV)	Filter	Line	Corr. (dB)	Margin (dB)	Limit (dBµV)
0.150000	48.6	Off	L1	19.4	17.4	66.0
0.206000	37.0	Off	L1	19.4	26.4	63.4
0.238000	35.2	Off	L1	19.5	27.0	62.2
0.286000	29.6	Off	L1	19.4	31.0	60.6
0.510000	35.1	Off	L1	19.4	20.9	56.0
13.558000	37.5	Off	L1	19.8	22.5	60.0
23.126000	33.3	Off	L1	20.0	26.7	60.0

Final Result : Average

Frequency (MHz)	Average (dBµV)	Filter	Line	Corr. (dB)	Margin (dB)	Limit (dBµV)
0.150000	36.3	Off	L1	19.4	19.7	56.0
0.206000	27.3	Off	L1	19.4	26.1	53.4
0.238000	28.2	Off	L1	19.5	24.0	52.2
0.286000	23.7	Off	L1	19.4	26.9	50.6
0.510000	31.7	Off	L1	19.4	14.3	46.0
13.558000	34.9	Off	L1	19.8	15.1	50.0
23.126000	30.2	Off	L1	20.0	19.8	50.0

Test Mode :	Mode 1	Temperature :	20~22°C
Test Engineer :	Kai-Chun Chu	Relative Humidity :	45~47%
Test Voltage :	120Vac / 60Hz	Phase :	Neutral
Function Type :	WLAN (2.4G) Link + Bluetooth Link + HDMI Cable + RJ-45 Load + Audio Converter Load + Mouse + MPEG4 + Adapter		

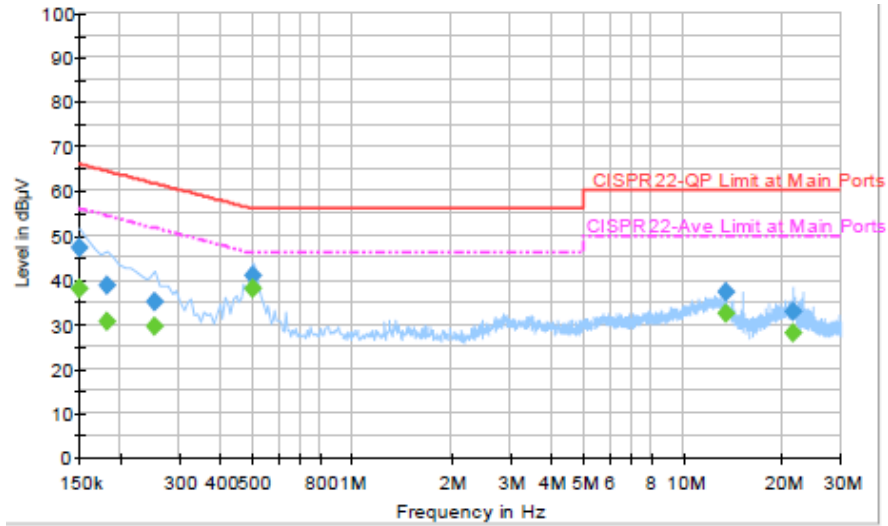

Final Result : Quasi-Peak

Frequency (MHz)	Quasi-Peak (dBµV)	Filter	Line	Corr. (dB)	Margin (dB)	Limit (dBµV)
0.150000	47.3	Off	N	19.4	18.7	66.0
0.182000	38.8	Off	N	19.4	25.6	64.4
0.254000	35.0	Off	N	19.5	26.6	61.6
0.502000	41.0	Off	N	19.4	15.0	56.0
13.558000	37.2	Off	N	19.9	22.8	60.0
21.662000	33.0	Off	N	20.0	27.0	60.0

Final Result : Average

Frequency (MHz)	Average (dBµV)	Filter	Line	Corr. (dB)	Margin (dB)	Limit (dBµV)
0.150000	38.2	Off	N	19.4	17.8	56.0
0.182000	30.4	Off	N	19.4	24.0	54.4
0.254000	29.6	Off	N	19.5	22.0	51.6
0.502000	37.9	Off	N	19.4	8.1	46.0
13.558000	32.3	Off	N	19.9	17.7	50.0
21.662000	28.2	Off	N	20.0	21.8	50.0

3.7 Antenna Requirements

3.7.1 Standard Applicable

If directional gain of transmitting antennas is greater than 6dBi, the power shall be reduced by the same level in dB comparing to gain minus 6dBi. The use of a permanently attached antenna or of an antenna that uses a unique coupling to the intentional radiator shall be considered sufficient to comply with the FCC rule.

3.7.2 Antenna Connected Construction

Non-standard connector used.

3.7.3 Antenna Gain

The antenna peak gain of EUT is less than 6 dBi. Therefore, it is not necessary to reduce maximum peak output power limit.

4 List of Measuring Equipment

Instrument	Manufacturer	Model No.	Serial No.	Characteristics	Calibration Date	Test Date	Due Date	Remark
Spectrum Analyzer	Rohde & Schwarz	FSP40	100055	9kHz~40GHz	Jun. 07, 2013	Aug. 02, 2013~ Aug. 04, 2013	Jun. 06, 2014	Conducted (TH02-HY)
Power Meter	Agilent	E4416A	GB41292344	300MHz~40GHz	Feb. 05, 2013	Aug. 02, 2013~ Aug. 04, 2013	Feb. 04, 2014	Conducted (TH02-HY)
Power Sensor	Agilent	E9327A	US40441548	300MHz~40GHz	Feb. 05, 2013	Aug. 02, 2013~ Aug. 04, 2013	Feb. 04, 2014	Conducted (TH02-HY)
EMI Test Receiver	Rohde & Schwarz	ESCS 30	100356	9kHz ~ 2.75GHz	Nov. 13, 2012	Jun. 27, 2013~ Jul. 25, 2013	Nov. 12, 2013	Conduction (CO05-HY)
Two-LISN (for auxiliary equipment)	Rohde & Schwarz	ENV216	100081	9kHz ~ 30MHz	Dec. 12, 2012	Jun. 27, 2013~ Jul. 25, 2013	Dec. 11, 2013	Conduction (CO05-HY)
Two-LISN	Rohde & Schwarz	ENV216	100080	9kHz ~ 30MHz	Dec. 06, 2012	Jun. 27, 2013~ Jul. 25, 2013	Dec. 05, 2013	Conduction (CO05-HY)
AC Power Source	APC	APC-1000W	N/A	N/A	N/A	Jun. 27, 2013~ Jul. 25, 2013	N/A	Conduction (CO05-HY)
Spectrum Analyzer	R&S	ESU26	100390	20Hz~26.5GHz	Dec. 14, 2012	Aug. 02, 2013~ Aug. 19, 2013	Dec. 13, 2013	Radiation (03CH08-HY)
Bilog Antenna	Schaffner	CBL6111C	2725	30MHz~2GHz	Oct. 06, 2012	Aug. 02, 2013~ Aug. 19, 2013	Oct. 05, 2013	Radiation (03CH08-HY)
Horn Antenna	ESCO	3117	66584	1GHz~18GHz	Aug. 10, 2012	Aug. 02, 2013~ Aug. 19, 2013	Aug. 09, 2013	Radiation (03CH08-HY)
Horn Antenna	ESCO	3117	66584	1GHz~18GHz	Aug. 07, 2013	Aug. 02, 2013~ Aug. 19, 2013	Aug. 06, 2014	Radiation (03CH08-HY)
SHF-EHF Horn Antenna	SCHWARZBECK	BBHA 9170	BBHA91702 51	15GHz ~ 40GHz	Sep. 28, 2012	Aug. 02, 2013~ Aug. 19, 2013	Sep. 27, 2013	Radiation (03CH08-HY)
Preamplifier	COM-POWER	PA-103	161075	10Hz~1000MHz Gain:32dB	Feb. 26, 2013	Aug. 02, 2013~ Aug. 19, 2013	Feb. 25, 2014	Radiation (03CH08-HY)
Pre Amplifier	Agilent	8449B	3008A02665	1GHz~26.5GHz	Aug. 28, 2012	Aug. 02, 2013~ Aug. 19, 2013	Aug. 27, 2013	Radiation (03CH08-HY)
Turn Table	HD	Deis HD 2000	420/611	0 ~ 360 degree	N/A	Aug. 02, 2013~ Aug. 19, 2013	N/A	Radiation (03CH08-HY)
Antenna Mast	HD	MA 240	240/666	1 m ~ 4 m	N/A	Aug. 02, 2013~ Aug. 19, 2013	N/A	Radiation (03CH08-HY)
Loop Antenna	Rohde & Schwarz	HFH2-Z2	860004/0001	9 kHz~30 MHz	Jul. 03, 2012	Aug. 02, 2013~ Aug. 19, 2013	Jul. 03, 2014	Radiation (03CH08-HY)

5 Uncertainty of Evaluation

Uncertainty of Conducted Emission Measurement (150 kHz ~ 30 MHz)

Measuring Uncertainty for a Level of Confidence of 95% ($U = 2Uc(y)$)	2.26
---	------

Uncertainty of Radiated Emission Measurement (30 MHz ~ 1000 MHz)

Measuring Uncertainty for a Level of Confidence of 95% ($U = 2Uc(y)$)	2.54
---	------

Uncertainty of Radiated Emission Measurement (1 GHz ~ 40 GHz)

Measuring Uncertainty for a Level of Confidence of 95% ($U = 2Uc(y)$)	4.72
---	------