

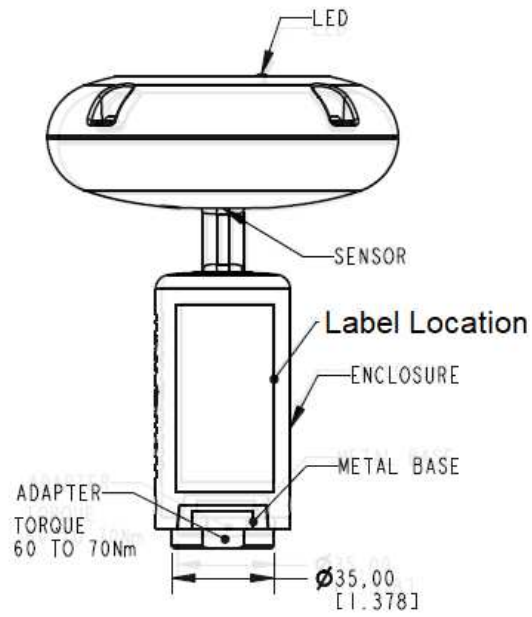

Equipment Photographs



(Label)





PRE REL					
ISS	REVISION & DATE	APPD			
B	DRAWING UPDATED ECN 2023-378	E374548			

PESO No.: P557419/2
IECEX CSA 22.0016X (Date: 02 DEC 2022)
Ex ia IIB T4 Ga

 CSA 22CA80116465X
Class I Division 1, Group C, D (I.S.)
Ex ia IIB T4 Ga
Class I Zone 0, AEx ia IIB T4 Ga

 0344  CSANe 22ATEX1072X
II1G - Ex ia IIB T4 Ga

 8505  CSAE 22UKEX1199X
II1G - Ex ia IIB T4 Ga



Tamb: -40°C to +70°C
IP66

FCC ID: S5751490045
CONTAINS FCC ID: 2APD9-RSL10SIP

HONEYWELL VERSATILIS™ SIGNAL SCOUT™
ASSEMBLY NO.: 50187700-100
MODEL NO: HVSS100-XXX-X-XX-X-X-0000
BLE MAC: AA:BB:CC:DD:EE:FF
DEVICE EUI: 00:11:AA:BB:CC:DD:EE:FF
SERIAL. NO: 10100000XXXXX



Honeywell
Honeywell International Inc.
512 Virginia Drive
Fort Washington, PA, 19034
Assembled In INDIA, WEEK/YEAR: WWYYYY

IC : 573W-51490045 HVIN: 51490045
CONTAINS IC : 23763-RSL10SIP Model: RSL10

 INSTALL PER INSTALLATION & USER'S GUIDE: 34-VT-25-02

35.00 REF
[1.378]

70.00 REF
[2.756]

NOTES:

1. FOR RELEASE APPROVALS SEE ECN 2022-3411.
2. THE CONTENT OF THE LABEL TO BE LASER PRINTED ON THE HVSS PRODUCT P/N 50187700.
3. ALL CHARACTERS AND SYMBOLS TO BE LASER PRINTED PER DRAWING.
4. QR CODE SHOULD CONTAIN THE BELOW PRODUCT INFORMATION:
HONEYWELL VERSATILIS - SIGNAL SCOUT I 50187700-100 I
AA:BB:CC:DD:EE:FF I 00:11:AA:BB:CC:DD:EE:FF I 10100000XXXXX

-100

COPYRIGHT [2022], HONEYWELL INTERNATIONAL INC. NEITHER THIS DOCUMENT NOR THE INFORMATION CONTAINED HEREIN SHALL BE REPRODUCED, USED OR DISCLOSED TO OTHERS WITHOUT THE WRITTEN AUTHORIZATION OF HONEYWELL. USE, DUPLICATION, OR DISCLOSURE OF THIS DOCUMENT IS SUBJECT TO THE RESTRICTIONS SET FORTH IN A WRITTEN AGREEMENT. NOTHING CONTAINED HEREIN SHALL BE CONSTRUED AS CONFERRING IMPLICATION, ESTOPPEL, OR OTHERWISE ANY LICENSE TO ANY PATENT, TRADEMARK, COPYRIGHT OR OTHER INTELLECTUAL PROPERTY RIGHT OF HONEYWELL OR ANY THIRD PARTY.

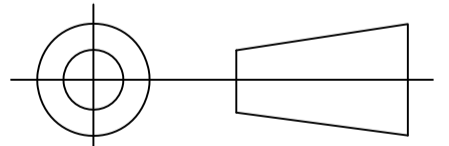
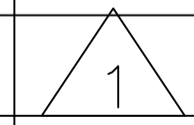
PROJECTION 	DRAWN	HV	101122
	CHECKED	JC	161122
LINEAR MEASURE INCH	DEV ENGR		
MATERIAL ---	MFG ENGR		
	QA ENGR MAT ENGR		
FINISH ---	TOLERANCE UNLESS NOTED		
	ANGULAR DIMENSION		

Honeywell	
HONEYWELL VERSATILIS SIGNAL SCOUT PRODUCT LABEL	
50187699	B/A3
SCALE 1:1	USED ON -
SHT 1 OF 1	

MASTER FILE TYPE: AUTOCAD

DO NOT SCALE DRAWING

50187699
B
CAD