



**ONWIRELESS**

**RELEASE 323**

## **Field Device Access Point User's Guide**

OWDOC-X256-en-323A

June 2022

---

---

## DISCLAIMER

This document contains Honeywell proprietary information.

Information contained herein is to be used solely for the purpose submitted, and no part of this document or its contents shall be reproduced, published, or disclosed to a third party without the express permission of Honeywell International Sàrl.

While this information is presented in good faith and believed to be accurate, Honeywell disclaims the implied warranties of merchantability and fitness for a purpose and makes no express warranties except as may be stated in its written agreement with and for its customer.

In no event is Honeywell liable to anyone for any direct, special, or consequential damages. The information and specifications in this document are subject to change without notice.

Copyright 2022- Honeywell International Sàrl

---

# Table of contents

<b>ABOUT THIS GUIDE .....</b>	<b>6</b>
Revision history.....	6
Intended audience.....	6
Prerequisite skills.....	6
How to use this guide.....	6
Related guides.....	6
<b>INTRODUCTION TO FDAP.....</b>	<b>8</b>
FDAP description.....	8
FDAP types.....	10
FDAP as backbone router.....	10
FDAP as field router.....	10
Physical description.....	11
FDAP Gen3 and FDAP Gen3 Anchor components.....	11
FDAP2 components.....	12
Features of FDAP.....	14
FDAP security.....	15
FDAP compliance information.....	17
<b>FDAP INSTALLATION .....</b>	<b>18</b>
Prerequisites.....	18
Inspect FDAP and associated hardware.....	18
Identify FDAP site locations.....	19
Connect antennas.....	19
FDAP Gen3 and FDAP Gen3 Anchor.....	19
FDAP2.....	22
Grounding.....	22
FDAP Gen3 and FDAP Gen3 Anchor.....	23
FDAP2.....	23
Mount the FDAP.....	23
FDAP Gen3 and FDAP Gen3 Anchor.....	23
Connect power cables.....	28
FDAP Gen3 and FDAP Gen3 Anchor.....	28
FDAP2.....	29
Ethernet wiring.....	32
Power on and startup.....	33

FDAP Gen3 and FDAP Gen3 Anchor .....	33
FDAP2 .....	36
<b>FDAP CONFIGURATION.....</b>	<b>37</b>
Establish connection between WDM and FDAP .....	37
Provision a FDAP .....	37
Description of FDAP parameters .....	38
<b>FIELD EXPANDABLE WIRELESS IO.....</b>	<b>49</b>
Overview .....	49
FEWIO solution .....	50
Converting FDAP Router to FEWIO device.....	51
Connecting Modbus TCP devices to FEWIO device.....	51
FDAP Gen3 and FDAP Gen 3 Anchor .....	51
FDAP2 .....	52
Connecting Modbus RTU devices to FEWIO device .....	53
FDAP Gen3 and FDAP Gen3 Anchor .....	53
FDAP2 .....	55
Configure FEWIO device in WDM .....	55
Configuring and viewing the Modbus Registers.....	58
Converting FEWIO device to FDAP Router.....	59
Integrating with Experion.....	60
<b>FDAP MONITORING.....</b>	<b>66</b>
Overview about monitoring .....	66
Verify connectivity using maps .....	66
Monitor using Provisioning Handheld device .....	67
Monitor using events .....	67
Monitor using reports .....	67
<b>FDAP MAINTENANCE AND TROUBLESHOOTING.....</b>	<b>68</b>
Replace an FDAP .....	68
Remove an FDAP .....	68
Firmware upgrade.....	68
Troubleshooting .....	68
System logs.....	68
Recovering from failures.....	69
<b>APPENDIX .....</b>	<b>70</b>
Technical Specifications .....	70
FDAP Gen3.....	70

---

FDAP Gen3 Anchor .....	77
FDAP2 .....	80
Dimension Drawing.....	83
FDAP Gen3 and FDAP Gen3 Anchor .....	83
FDAP2 .....	84
IS Control Drawing.....	85
FDAP Gen3 and FDAP Gen3 Anchor .....	85
FDAP2 (51202683).....	90
Label Drawing.....	92
FDAP Gen3.....	92
FDAP Gen3 Anchor .....	93
FDAP2 .....	102
<b>NOTICES .....</b>	<b>103</b>

## About this guide

This guide describes the procedures to install, configure, and operate the Field Device Access Point (FDAP2), Field Device Access Point Gen3 (FDAP Gen3), and Field Device Access Point Gen3 Anchor (FDAP Gen3 Anchor). FDAP is one of the components in the OneWireless Network solution for industrial control.

## Revision history

Revision	Supported Release	Date	Description
A	323	May 2022	Initial release of the document.

## Intended audience

This guide is intended for people who are responsible for planning, administering, and operating the OneWireless network. These people include Plant Managers, Process Engineers, and System Administrators.

## Prerequisite skills

It is assumed that you are familiar with the operation of OneWireless network, Experion system software and the plant processes which Experion controls, Microsoft Windows operating systems and network administration tasks.

## How to use this guide

This guide provides guidance on:

- FDAP description
- FDAP installation
- FDAP configuration
- FDAP monitoring
- FDAP maintenance and troubleshooting

## Related guides

The following guides and sources contain additional information required for deploying OneWireless network. It is recommended to have these guides readily available for reference.

Guide	Description
OneWireless Network Planning and Installation Guide (OWDOC-X253-en)	Provides information about planning, designing, and setting up the OneWireless network using WDM, FDAPs, and field devices.
OneWireless WDM User's Guide (OWDOC-X254-en)	Describes the procedures to provision, configure, operate, and monitor an ISA100 Wireless field device network using Wireless Device Manager (WDM).
OneWireless Wireless LAN Controller Configuration Guide (OWDOC-X255-en)	Provides information about planning, designing, setting up, and configuring a OneWireless network using WDM, FDAPs, Cisco 1552S APs, and field devices.
OneWireless Process Control Access Point User Guide (OWDOC-X718-en)	Describes the procedures to install, configure, and operate Process Control Access Point (PCAP).
FDAP Regulatory Compliance Guide	Describes the FDAP Regulatory Compliance information.
OneWireless Parameter Reference Dictionary (OWDOC-X260-en)	Provides information about the parameters associated with OneWireless devices.

To download the latest Honeywell documentation, go to <https://process.honeywell.com>.

# Introduction to FDAP

## FDAP description

Note that in this guide, a reference to wireless field devices includes ISA100 Wireless devices, WirelessHART devices, and Wired HART devices unless otherwise mentioned. Specific device type is mentioned as and when applicable.

The Field Device Access Point (FDAP) is a ruggedized industrial radio device intended for use in hazardous locations to provide wireless connectivity for Wireless compatible field devices. As an industrial meshing access point, FDAP provides secure and reliable wireless coverage for wireless field devices. It also serves as a routing access point for wireless field devices and is located between the wired DCS network and wireless field devices. Once deployed in the field, FDAPs self-discover and self-organize into a managed, secure, and redundant wireless field device mesh network. With FDAPs, wireless field devices do not have to route data from other field devices. The following figure illustrates how FDAPs are used in a OneWireless network.

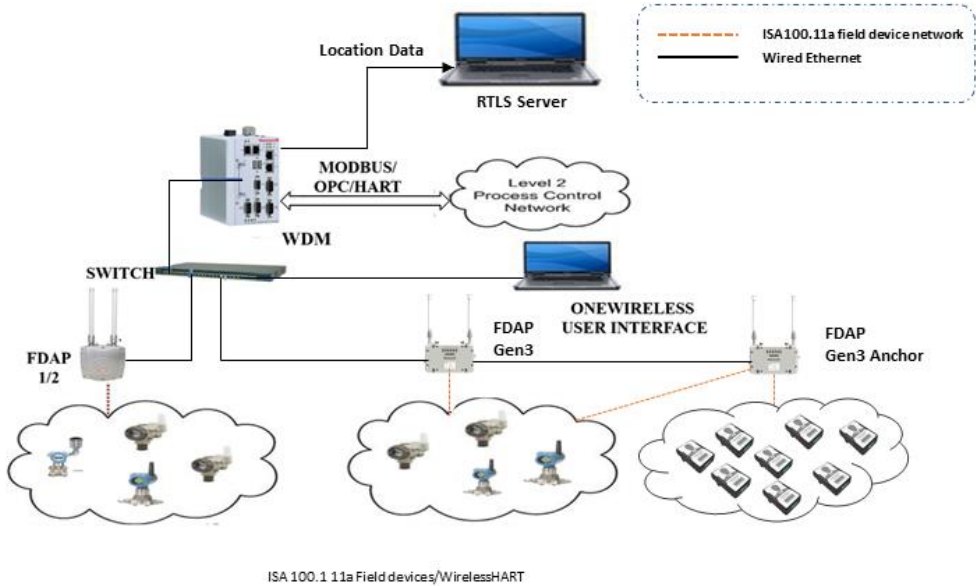


Fig. 1. OneWireless Network



---

### FDAP and FDAP Gen3:

The FDAP and FDAP Gen3 uses IEEE 802.15.4 standard based radio technology and combines spatial diversity with advanced error correction schemes to communicate in a complex multi-path environment and in large communication areas. It has an Ethernet interface for connection to the backbone network and a wireless compliant radio to connect to the wireless field device network. It is a standalone, pole mountable, intrinsically safe device, suitable for use in hazardous locations. It is normally installed in the same area where industrial field devices are installed. FDAP and FDAP Gen3 supports 10/100 Mbps Fast Ethernet and has spatial antenna diversity.

### FDAP Gen3 Anchor:

The FDAP Gen3 Anchor uses IEEE 802.15.4 standard based radio technology to communicate with ISA100.11a, WirelessHART devices and RTLS tags. FDAP Gen3 Anchor supports 10/100 Mbps Fast Ethernet interface for connection to the backbone network and a wireless compliant radio to connect to the wireless field device network. It is a standalone, pole mountable, intrinsically safe device, suitable for use in hazardous locations. It is normally installed in the same area where industrial field devices are installed.


**Table. 1. FDAP models**

Access Point type	Model numbers	Power options	Suitable for...
FDAP Gen3 certified for Class I Division 2, Zone 2 Areas	OW-FDAP32	24V DC, PoE Type -2 powered	Class I Division 2, Zone 2 and general-purpose applications
FDAP Gen3 Anchor certified for Class I Division 2, Zone 2 Areas	OW- FDAP32/3P	2.5 Watts@24VDC, PoE: 3W powered	Class I Division 2, Zone 2 and general-purpose applications
FDAP certified for Class I Division 1, Zone 0/1 Areas	FDAP1	18 - 30V DC	Intrinsic Safety (IS) source for Class I Division 1, Zone 0/1 applications
FDAP certified for Class I Division 2, Zone 2 Areas	FDAP2	90 - 264V AC Operating Range: 18 – 30 V DC Typical: 24 V	Class I Division 2, Zone 2 and general-purpose applications

## FDAP types

### FDAP as backbone router

The FDAP has a radio board and an autonomous power subsystem that operates within a range of AC/DC inputs. FDAP supports wireless radio communication, and it does not support Wi-Fi or other radio technologies. The FDAP may be used for Class I Division 2, Zone 2 and general-purpose applications.

 NOTE	AC is only supported in FDAP1/ FDAP2 models.
-------------------------------------------------------------------------------------------	----------------------------------------------

### FDAP as field router

The FDAP can be used as a Field Router (FR). If FDAP is not connected to the physical Ethernet, it functions as a line powered FR. The FDAP as a line powered FR option can be used for extending field mesh into hazardous environments where normal infrastructure nodes are not suitable. The FDAP may be used as a field router for Class 1 Division 1, Zone 0/1 applications that require IS protection methods and design techniques. This also supports RS-485 communication to transmit data from Modbus RS-485s over Wireless (FEWIO role).

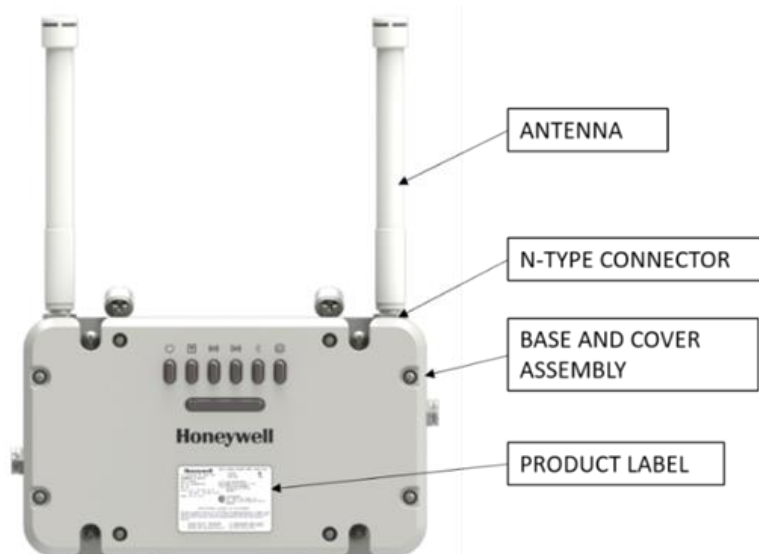
---

## Physical description

### FDAP Gen3 and FDAP Gen3 Anchor components

#### FDAP Gen3 and FDAP Gen3 Anchor enclosure

The FDAP Gen3 and FDAP Gen3 Anchor have a rugged die-cast aluminum enclosure for outdoor use. The enclosure and all auxiliary components are designed to meet IP66 and IP67 ratings for protection against dust and water ingress. The enclosure has two N-type bulkhead connectors for antenna spatial diversity in the FDAP radios. The two of the half-inch rigid conduit hub has a gasket to seal out water and dust. A rigid conduit hub, internal and external ground studs, and a removable cover are provided for field installation. It has an internal Bluetooth Low Energy (BLE) module, and this allows the device to be commissioned in the field. Six status LEDs provide information about power, device health, Bluetooth, RS-485 and Ethernet communication. The enclosure may be mounted on a pole or on a flat surface such as a wall using the available optional mounting brackets. The enclosure measures approximately 47 cm x 29 cm x 5 cm (L x W x H).



**Fig. 2.** FDAP Gen3 and FDAP Gen3 Anchor

#### Bluetooth Low Energy (BLE) Module

The FDAP Gen3 and FDAP Gen3 Anchor have an internal BLE module that is used for communicating with the Provisioning Handheld Android device. The Provisioning Handheld device is used for commissioning the FDAP Gen3 and FDAP Gen3 Anchor, reading, and setting the various FDAP Gen3 and FDAP Gen3 Anchor parameters. The BLE module has a range of 10-meter radius.

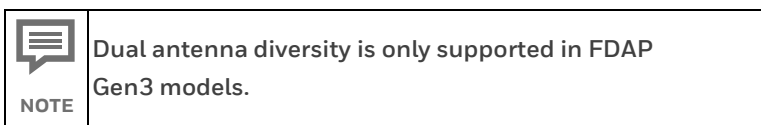
## Communication radio

The FDAP Gen3 has wireless compliant radios that operate in the 2.4 GHz ISM band. It uses spatial antenna diversity with sophisticated error correction schemes to improve communication and increase coverage in a typical industrial complex where multi-path propagation is prevalent.

The FDAP Gen3 Anchor has wireless compliant radios that operate in the 2.4 GHz ISM band. Communication Radio 1 used for process instrumentation communication with ISA100.11a and WirelessHart devices. Communication Radio 2 used for RTLS application to measure or find the distance between FDAP Gen3 Anchor and RTLS tags location.

## Antennas

The FDAP Gen3 uses dual antenna diversity to improve communication reliability in severe multi-path environment. This helps in improving radio coverage and provides robust communication links thereby reducing infrastructure cost and cost per wireless field device.



The FDAP Gen3 and FDAP Gen3 Anchor have an integral omni-directional antenna and it also supports a variety of high- and low-gain omni-directional antennas to provide flexibility in installation and to maximize performance of the wireless system. See the *FDAP Gen3 Regulatory Compliance Guide* for details about certified antennas and the allowable maximum RF output power.

The FDAP Gen3 and FDAP Gen3 Anchor have an option to integrate lightning Surge arrestors on the antenna ports. Lightning Surge arrestors are required for all outdoor installations or indoor installations where FDAP Gen3 may be subjected to lightning surge. Optional remote mounted lightning Surge arrestors are available for use in application where the remote antenna cable is exposed to lightning surge.

## LED indicators

The FDAP Gen3 and FDAP Gen3 Anchor have six LEDs for indicating the status and health of the device. For more information about LEDs, see "[Table 8: LED indicators](#)".

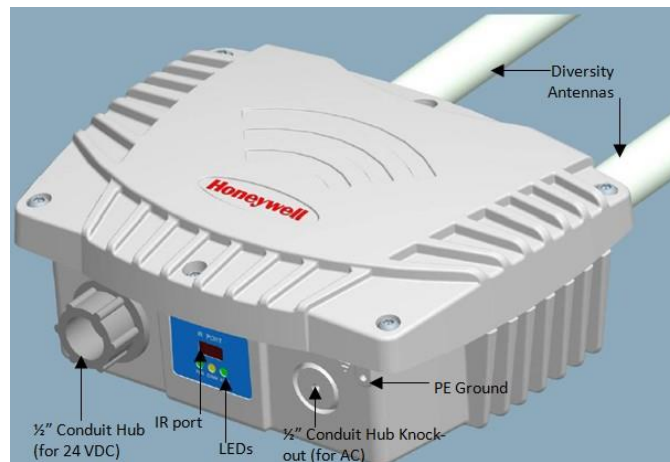
## FDAP2 components

### FDAP2 enclosure

The FDAP2 has a rugged die-cast aluminum enclosure for outdoor use. The enclosure and all auxiliary components are designed to meet IP66 and NEMA Type 4X (FM only) ratings for protection against dust and water ingress. The enclosure has two water-tight type N

---

bulkhead connectors for antenna spatial diversity in the FDAP2 radios. The half-inch rigid conduit hub has a gasket to seal out water and dust. A rigid conduit hub, internal and external ground studs, and a removable cover are provided for field installation. Externally accessible Infrared (IR) port allows the device to be commissioned in the field. Three status LEDs provide information about power, device health, and communication. The enclosure may be mounted on a pole or on a flat surface such as a wall using the available optional mounting brackets. The enclosure measures approximately 20 cm x 13 cm x 7 cm (L x W x H).



**Fig. 3. Physical description of FDAP**

#### IR port

The FDAP2 has an externally accessible IR port that is used for communicating with the Provisioning Handheld device. The Provisioning Handheld device is used for commissioning the FDAP2, reading, and setting the various FDAP2 parameters. The IR port has a range of 20 cm and a beam width of 20 degrees.

#### Communication radio

The FDAP2 has wireless compliant radios that operate in the 2.4 GHz ISM band. It uses spatial antenna diversity with sophisticated error correction schemes to improve communication and increase coverage in a typical industrial complex where multi-path propagation is prevalent.

#### Antennas

The FDAP2 uses dual antenna diversity to improve communication reliability in severe multi-path environments. This helps in improving radio coverage and provides robust communication links thereby reducing infrastructure costs and cost per wireless field device.

The FDAP2 has integral omni-directional antennas and it also supports a variety of high- and low-gain directional and omni-directional antennas to provide flexibility in installation

and to maximize performance of the wireless system. See the *FDAP Regulatory Compliance Guide* for details about certified antennas and the allowable maximum RF output power.

The FDAP2 has integrated lightning Surge arrestors on the antenna ports. The lightning Surge arrestors are permanently attached and do not require field maintenance.

Lightning Surge arrestors are required for all outdoor installations or indoor installations where FDAP2 may be subjected to lightning surge. Optional remote mounted lightning Surge arrestors are available for use in application where the remote antenna cable is exposed to lightning surge.

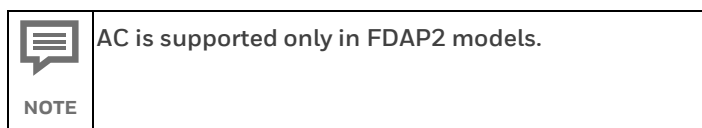
## LED indicators

The FDAP2 has three LEDs for indicating the status and health of the device. For more information about LEDs, see “[Table 9: LED indicators](#)”.

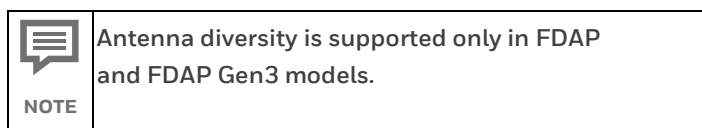
## Features of FDAP

The features of the FDAP are as follows:

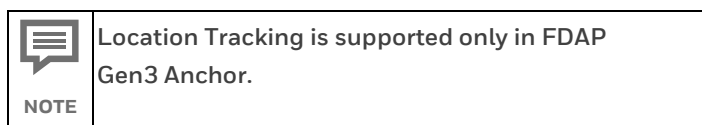
- **DC or Universal AC powered:** The FDAP operates at DC or AC and provides better latency than battery-based wireless field device mesh network. It enables the use of wireless field devices for applications requiring fast update rates (less than 10 seconds) and short latency (less than 250 milliseconds (ms)) and in areas where Wi-Fi radios are not allowed.



- **Antenna diversity:** The FDAP uses spatial antenna diversity to improve communication success rates and to improve coverage in multi-path environments. This is necessary for most of the industrial applications where there is no direct line of sight between field devices. Antenna diversity significantly improves data availability in such applications.



- **Location Tracking:** The FDAP Gen3 Anchor has capability to find the distance of Tags. Distance data will be used to compute the location of Tags.



- **Fast Ethernet:** The FDAP has 10/100 Mbps Fast Ethernet interface and can be integrated into any network that supports Ethernet communication.

- 
- **Field Mesh network:** Multiple FDAPs can form a self-forming, self-healing wireless mesh network. This extends the range and coverage of the wireless sensor network and provides redundant communication paths for improved data availability. Unlike battery-powered field devices, FDAPs are line powered and so can aggregate data from multiple field devices including other FDAPs without concerns about battery life.
  - **Reduced cost:** The FDAP reduces wireless field device cost, infrastructure cost, and cost per wireless I/O. It reduces the number of wireless routing devices and offers wireless coverage for wireless field devices. It has lesser installation cost than Access Points for sensor-only applications.
  - **Access points:** The FDAP acts as a routing access point for wireless field devices and it is designed for sensor-only network for monitoring application segment.
  - **IPv6 device:** The FDAP is an Internet Protocol version 4 (IPv4) device. The IPv4 protocol provides an end-to-end data transmission across multiple IP networks. The FDAP gets the IP address from DHCP Server in Field Device Network (FDN). You can ping an FDAP from the FDN network, however you cannot ping an FDAP from the Plant Control Network (PCN). Also, you cannot ping an FDAP when used as a Router.
  - **Backbone router:** The FDAP is a backbone router in a rugged industrial enclosure that acts as a bridge between the field device network and wireless backhaul network such as IEEE 802.11 WLAN.

## FDAP security

OneWireless network protects plant information and ensures safe operations with industry standard 128-bit encryption at the mesh, Wi-Fi and wireless field device level. The FDAP offers a robust embedded wireless security.

### FDAP Gen3 and FDAP Gen3 Anchor Authentication

In addition to data encryption, wireless standard requires each FDAP Gen3 and FDAP Gen3 Anchor to be authenticated before joining the network. OneWireless network relies on a more secured Bluetooth Low Energy (BLE) based authentication key distribution method as it requires users to be physically near to the FDAP Gen3 and FDAP Gen3 Anchor to add it to the network. The BLE has a range of 10-meter radius. The authentication keys are generated and managed by the WDM. A Provisioning Handheld device is used to download keys to FDAP Gen3 and FDAP Gen3 Anchor are using BLE. The keys are encrypted when distributed over the network. Once a key is deployed to an FDAP Gen3, it is validated by the WDM before the FDAP Gen3 and FDAP Gen3 Anchor can join the OneWireless network.

**NOTE**

The FDAP Gen3 and FDAP Gen3 Anchor have a default BLE key which is 192021 (6-digit key for pairing), once the FDAP Gen3 connects with WDM, it is mandatory to change the BLE pin using the WDM user interface. When the FDAP Gen3 and FDAP Gen3 Anchor are reset to default (when not connected to WDM), the BLE key changes back to the default key.

**FDAP1/ FDAP2 Authentication**

In addition to data encryption, wireless standard requires each FDAP1/ FDAP2 to be authenticated before joining the network. OneWireless network relies on a more secured IR authentication key distribution method as it requires users to be physically next to the FDAP1/ FDAP2 to add it to the network. The authentication keys are generated and managed by the WDM. A Provisioning Handheld device is used to upload the authentication keys from the WDM to Provisioning Handheld device and to download keys to FDAP1/ FDAP2 using IR media. The IR media is used to send an authentication key from the Provisioning Handheld device to the FDAP1/ FDAP2. Therefore, all Provisioning Handheld devices and FDAP1/ FDAP2 have IR ports for device commissioning. The keys are encrypted when distributed over the network. Once a key is deployed to an FDAP1/ FDAP2, it is validated by the WDM before the FDAP1/ FDAP2 can join the OneWireless network.

Key deployment is a one-time activity, that is, the devices can rejoin the network after power down or after any other service interruptions without re-keying the device. OneWireless supports a key rotation mechanism to enable a secure network. Once the devices join the network, a master key and a session key are assigned to each device, and the session key can be rotated on a periodic basis. The key rotation period can be configured from the OneWireless user interface. For best system performance, it is recommended to set the key rotation period as infinite.

Beginning with OneWireless R210, over-the-air provisioning is supported for all ISA100 devices. This allows the FDAPs to join the secure OneWireless network and establish communication with other devices and the WDM.

**Embedded wireless security**

To reduce security threats, wireless devices require all process data to be 128-bit encrypted. The data is encrypted at the source and decrypted at the destination to provide end-to-end security for the process data. The FDAPs self-discover other neighboring wireless routing devices, such as Access Points, and routing wireless field devices, to form a reliable and secure wireless mesh network.

Wireless routing algorithm enables an FDAP to dynamically identify the best route to send data to and from wireless field devices. This algorithm enables the field device mesh network to dynamically re-optimize itself when FDAPs are added to or removed from the network.



---

## FDAP compliance information

For information about FDAP Gen3 and FDAP Gen3 Anchor regulatory compliance information, see the latest *OneWireless Field Device Access Point Gen3 Specifications Guide* available at Honeywell Support Website.

For information about FDAP2 regulatory compliance information, see the latest *OneWireless Field Device Access Point Specifications Guide* available at Honeywell Support Website.

# FDAP installation

## Prerequisites

Complete the network planning before installing FDAP. For information about network planning, see the *Network Planning and Installation Guide (OWDOC-X253-en)*. Complete the following tasks before installing the FDAP in the wireless network.

- **Network site planning:** Complete site planning to understand how a wireless network can be built and supported for your application using OneWireless components.
- **RF site assessment:** Perform an RF site assessment when designing a large wireless network. The site assessment must at a minimum include the following tasks:
  - Conduct the site assessment when the plant is operating, so that maximum possible interference can be measured and addressed.
  - Conduct RF spectrum analysis on the 2.40-2.49 GHz band to detect any potential RF interference. Strong interference sources should be addressed (removed, avoided, or minimized) before the installation. Note that some frequencies may not be available for use in some locations and countries.
  - Arrange point-to-point mesh in various locations to measure the RF propagation ability in the site. Received Signal Strength Indicator (RSSI) can serve as an indicator of the RF environment. TCP/IP throughput testing and UDP/IP throughput and packet drop rate testing should be conducted in all selected locations to measure the signal strength quality in the site.
- **FDAP placement:** Determine FDAP placement after the completion of the network planning and RF assessment activities.
- **Power requirements:** Identify power requirements for the network. Determine wired cable runs to provide DC power to the FDAP.
- **Ethernet cable runs:** Determine Ethernet cable runs for FDAP and/or any other wired nodes in the network.

## Inspect FDAP and associated hardware

Ensure that all the hardware that are necessary for completing the installation for each FDAP are available. Examine whether the FDAP and the associated hardware like antennas and mounting brackets are not damaged.

---


## Identify FDAP site locations

The location of all FDAP should be determined to ensure optimum operation in a wireless network. After the completion of network site planning and RF assessment activities, the locations for FDAP are identified.

Locations can be mapped so that the site preparation for FDAP can be started. For more information about prerequisites, see "[Prerequisites](#)".


## Connect antennas

Antennas play a critical role in the setup and operation of wireless mesh systems. Depending upon the results of the site assessment and the requirements of the installed environment, proper antenna type (omni-directional versus directional, low-gain versus high-gains, fixed versus remote and so on) should be determined. The various types of antennas offered with FDAP Gen3 and FDAP Gen3 Anchor enhance the wireless coverage of the field devices in a multi-path environment. It is recommended to use the same antenna type and gain on both antennas for optimum performance.

 <b>ATTENTION</b>	<b>After the antennas are connected, the connections should be sealed to protect them from the external environment. In environments where conductive deposits can accumulate on antenna, such deposits must be removed to maintain optimum RF characteristics. The conduit openings at the bottom of the FDAP2 must be sealed.</b>
-------------------------------------------------------------------------------------------------------	-------------------------------------------------------------------------------------------------------------------------------------------------------------------------------------------------------------------------------------------------------------------------------------------------------------------------------------

## FDAP Gen3 and FDAP Gen3 Anchor

See the following image for connecting FDAP Gen3 and FDAP Gen3 Anchor antenna.

 <b>NOTE</b>	<b>The minimum torque required to meet IP66 and IP 67 ratings is shown in the following image.</b>
----------------------------------------------------------------------------------------------------	----------------------------------------------------------------------------------------------------

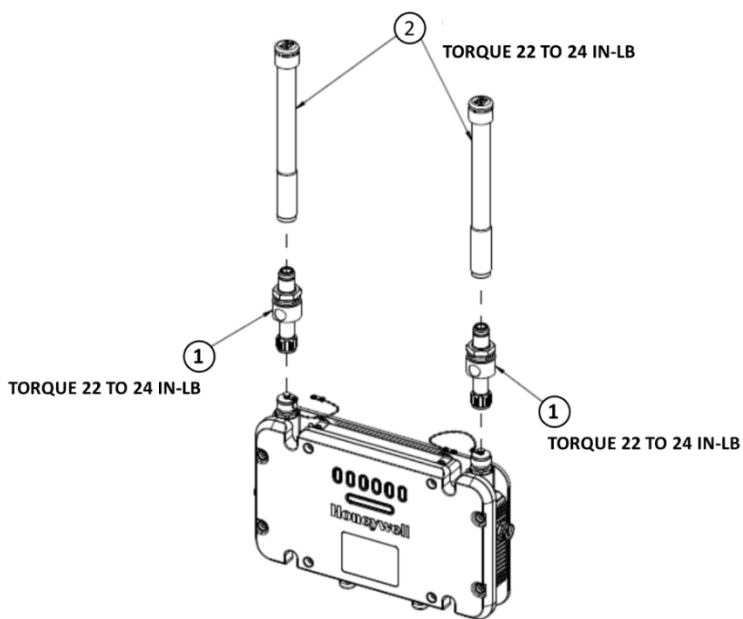



Fig. 4. FDAP Gen3 and FDAP Gen3 Anchor Antenna Connection

Table. 2. Part number description

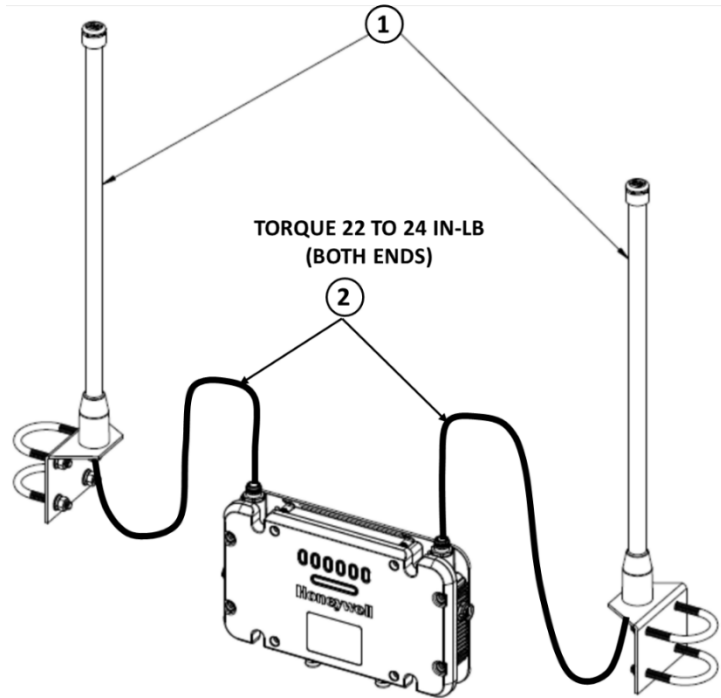
Item	Description
1	Lightning surge arrestor
2	5dBi/8dBi Integral omni antenna

 <b>CAUTION</b>	<p>Take precautions against electrostatic discharge when handling antenna.</p>
-------------------------------------------------------------------------------------------------------	--------------------------------------------------------------------------------

---

## Remote antenna connections

See the following image for connecting FDAP Gen3 and FDAP Gen3 Anchor antenna in remote.



**Fig. 5.** FDAP Gen3 and FDAP Gen3 Anchor Antenna Connection in remote

**Table 3.** Part number description


Item	Description
1	8dBi remote omni directional antenna
2	3m/10m coaxial cable assembly

## FDAP2

See the following image for connecting FDAP2 antenna.




**Fig. 6.** Antenna components

 <b>CAUTION</b>	<p><b>Take precautions against electrostatic discharge when handling antenna.</b></p>
-----------------------------------------------------------------------------------------------------	---------------------------------------------------------------------------------------

## Grounding

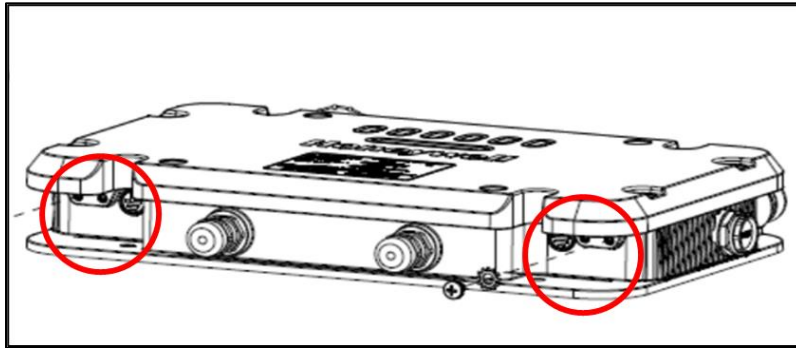
The FDAP provides internal and external grounding points to meet various local and regulatory grounding requirements. Ensure that the FDAP is grounded properly by a certified and authorized personnel, and that it conforms to all applicable codes and regulations. The materials required to provide a proper grounding is defined by local regulations and should be obtained locally to ensure that the correct safety environment is achieved.

 <b>ATTENTION</b>	<ol style="list-style-type: none"> <li>1. The recommended wire gauge of the ground cable from FDAP ground to the ground pit should be at least 12AWG or better.</li> <li>2. Ground pit should be maintained as per the NEC recommendation. The ground resistance should be less than 5 ohms so that it provides safety to FDAP under environmental transients such as lightning, sandstorm, and so on.</li> </ol>
---------------------------------------------------------------------------------------------------------	-------------------------------------------------------------------------------------------------------------------------------------------------------------------------------------------------------------------------------------------------------------------------------------------------------------------------------------------------------------------------------------------------------------------

---

## FDAP Gen3 and FDAP Gen3 Anchor

See the following figure for grounding points for FDAP Gen3 and FDAP Gen3 Anchor.



**Fig. 7.** Grounding points for FDAP Gen3 and FDAP Gen3 Anchor

Use one of the two grounding points marked in the image for grounding. Fasten the screws and washers with a torque value of 12 to 14 inch-pounds (in-lb).

## FDAP2

See the following figure for grounding points for FDAP2.



Ensure all your grounding connections terminate here

**Fig. 8.** Grounding points for FDAP 1/FADP2

## Mount the FDAP

### FDAP Gen3 and FDAP Gen3 Anchor

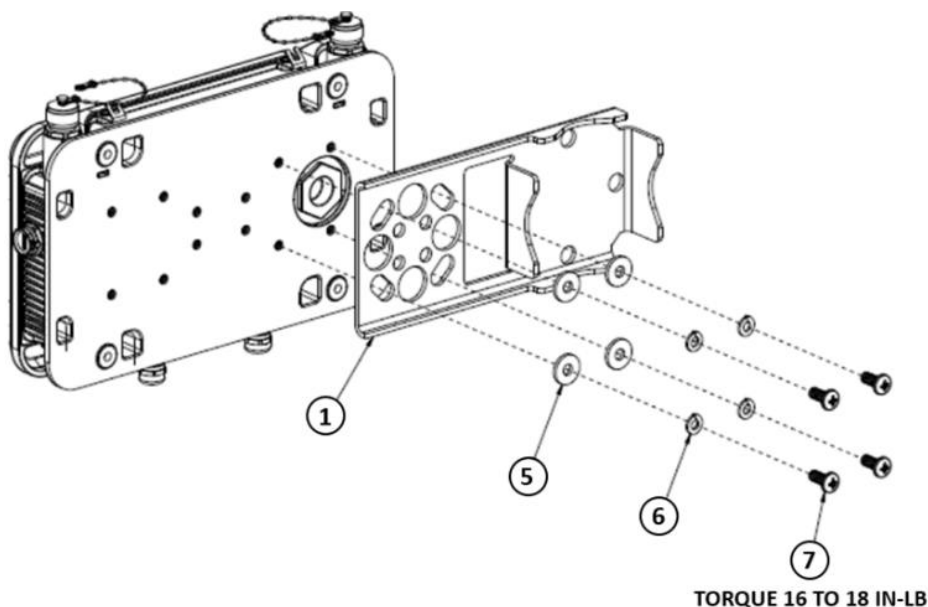
The assembled FDAP Gen3 and FDAP Gen3 Anchor, along with antennas and lightning suppressors (if required) can be mounted in the site location. The FDAP Gen3 and FDAP Gen3 Anchor enclosure can be mounted on a 2-inch pole or on a wall using the appropriate optional mounting kit that is available with the unit.

## Pole mounting

When pole mounting the FDAP Gen3 and FDAP Gen3 Anchor, you can assemble and install the mounting hardware at the site. The mounting kit includes the following items:

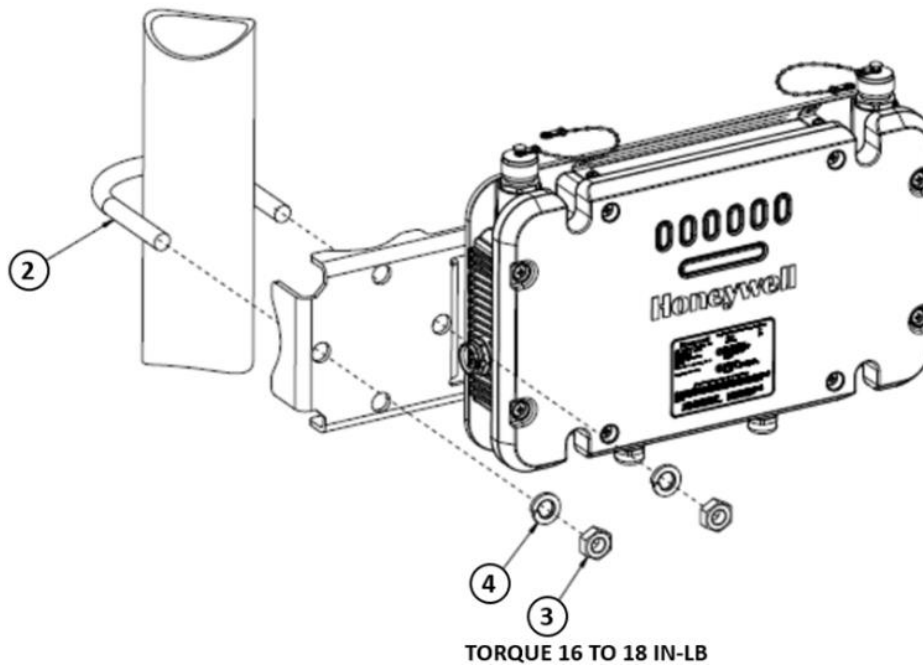
1. Mounting plate
2. U-bolts with nuts
3. Screws (to attach the FDAP Gen3 and FDAP Gen3 Anchor to the mounting plate)
4. Washers (split lock washer, flat lock washer, lock washer)

The pole mounting kit comprises of mounting plate, U-bolts with nuts, screws and washers as displayed in the following figures. When using the mounting plate for the pole installation, secure the FDAP Gen3 and FDAP Gen3 Anchor to the bracket using the screws supplied with the bracket kit. The FDAP Gen3 and FDAP Gen3 Anchor can be mounted to the left or to the right of the pole using the same mounting hardware. It can also be mounted in line with the pole. However, if the integral antennas are too close to the pole, it may cause RF communication problem. For inline mounting, the FDAP Gen3 and FDAP Gen3 Anchor integral antennas should be on the top of the mounting pole.



**Fig. 9.** Pole mounting bracket assembling on FDAP Gen3 and FDAP Gen3 Anchor





**Fig. 10.** Pole mounting of FDAP Gen3 and FDAP Gen3 Anchor

**Table 4.** Part number description

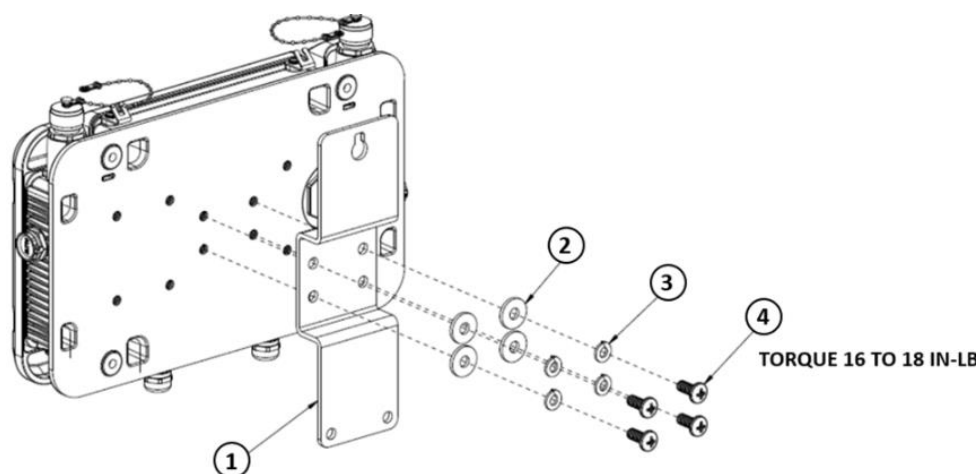
Item	Description
1	Flat style mounting bracket 316ss
2	"U" bolt m10 316ss
3	Hex nut, m10, 316ss
4	Lock washer, m10, 316ss
5	Flat lock washer, 1/4, 316ss
6	Split lock washer, 1/4, 316ss
7	Screw, 1/4-20 x 5/8, 316ss

### Wall or flat surface mounting

When wall mounting the FDAP Gen3 and FDAP Gen3 Anchor, you can assemble and install the mounting hardware at the site. The mounting kit includes the following items:

1. Mounting plate
2. Screws (to attach the FDAP Gen3 and FDAP Gen3 Anchor to the mounting plate)
3. Washers (split lock washer, flat lock washer)

Both mounting plates fasten to four threaded bosses on the back of the FDAP Gen3 and FDAP Gen3 Anchor. The FDAP Gen3 and FDAP Gen3 Anchor should not be mounted on metallic walls because the integral antennas are too close to the wall and may cause RF propagation problems.



**Fig. 11.** Wall mounting of FDAP Gen3 and FDAP Gen3 Anchor

**Table 5.** Part number description

Item	Description
1	Wall mounting bracket, 316ss
2	Flat lock washer, 1/4, 316ss
3	Split lock washer, 1 / 4, 316ss
4	Screw, 1/4-20 x 5/8 l, 316ss

## FDAP2

The assembled FDAP2, along with antennas and lightning suppressors (if required) can be mounted in the site location. The FDAP2 enclosure can be mounted on a 2-inch pole or on a wall using the appropriate optional mounting kit that is available with the unit.

### Pole mounting

When pole mounting the FDAP2, you can assemble and install the mounting hardware at the site. The mounting kit includes the following items:

1. Mounting plate
2. U-bolts with nuts
3. Screws (to attach the FDAP2 to the mounting plate)

When using the mounting plate for the pole installation, secure the FDAP2 to the bracket using the screws supplied with the bracket kit. The FDAP2 can be mounted to the left or to the right of the pole using the same mounting hardware. It can also be mounted in line with the pole. However, if the integral antennas are too close to the pole, it may cause RF communication problems. For inline mounting, the FDAP2 integral antennas should be on the top of the mounting pole.



**Fig. 12. Pole mounting of FDAP2**

#### Wall or flat surface mounting

The wall mounting kit comprises a wall mounting plate and four screws as displayed in the following figure. Both mounting plates fasten to four threaded bosses on the back of the FDAP2. The FDAP2 should not be mounted on metallic walls because the integral antennas are too close to the wall and may cause RF propagation problems.




**Fig. 13. Wall mounting of FDAP2**

## Connect power cables

### FDAP Gen3 and FDAP Gen3 Anchor

The FDAP Gen3 and FDAP Gen3 Anchor have one Ethernet cable and one power cable. Ethernet interconnection is limited to installations outside Class I Division 1, Zone 0/1 locations. You must construct conduit and cable runs for power and Ethernet. The FDAP Gen3 and FDAP Gen3 Anchor can be powered directly by external DC power supply such as, distributed DC source. Ensure that all wires inside the enclosure are routed and secured properly as displayed in the following figure. The FDAP Gen3 and FDAP Gen3 Anchor have integrated terminal blocks that allow field wiring to be directly terminated inside the FDAP Gen3 and FDAP Gen3 Anchor have one Ethernet cable and one power cable. without an additional external junction box. DC Power connection, Ethernet and Serial connections can be terminated outside the FDAP Gen3 and FDAP Gen3 Anchor have one Ethernet cable and one power cable. .

 <b>ATTENTION</b>	<p>It is recommended to use RS-485 or Ethernet one at a time to meet IP66 and IP67 requirements.</p>
-------------------------------------------------------------------------------------------------------	------------------------------------------------------------------------------------------------------

### DC power wiring

When powered from an external DC source, the power cable should be terminated to the two-position terminal block (E2) on the Power Board. The polarity of the connector is marked next to the connector on the Power Board. The power cable should be shielded, and the drain wire grounded inside the enclosure as displayed in the following figure 14 and figure 15.

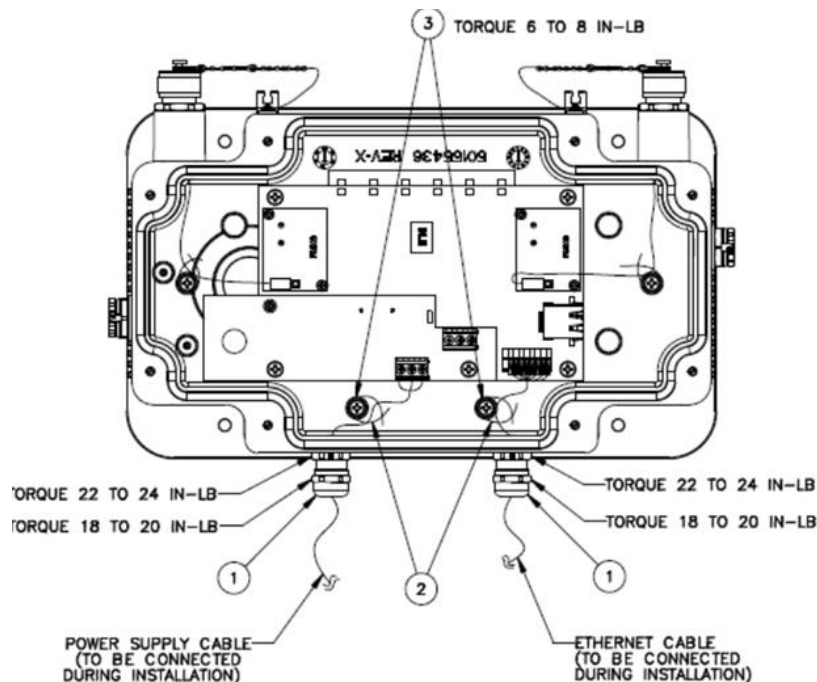
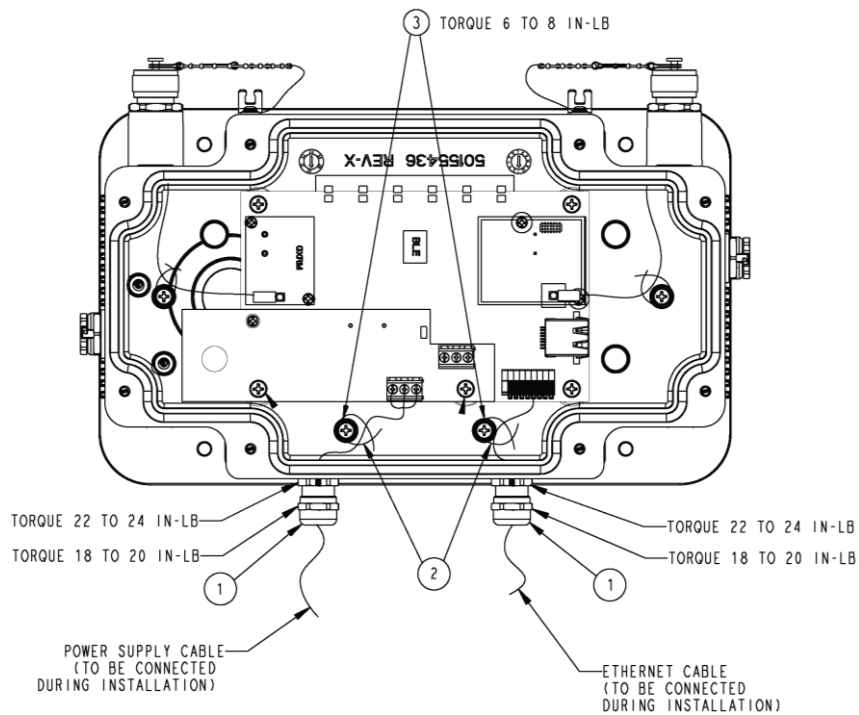


Fig. 14. FDAP Gen3 Ethernet and field DC power



**Fig. 15. FDAP Gen3 Anchor Ethernet and field DC power**

**Table 6. Part number description**

Item	Description
1	Cable gland assembly
2	Cable tie
3	Screw

The shield wire from cable must be secured on the chassis on the terminal power board.

 <b>ATTENTION</b>	<p>For installations that require CE-mark compliance, the DC power source must be a CE-mark approved power supply. In addition, the DC cable between the approved DC power source must be no more than 3 meters (9.8 feet) from the FDAP Gen3 and FDAP Gen3 Anchor.</p>
----------------------	-------------------------------------------------------------------------------------------------------------------------------------------------------------------------------------------------------------------------------------------------------------------------

## FDAP2

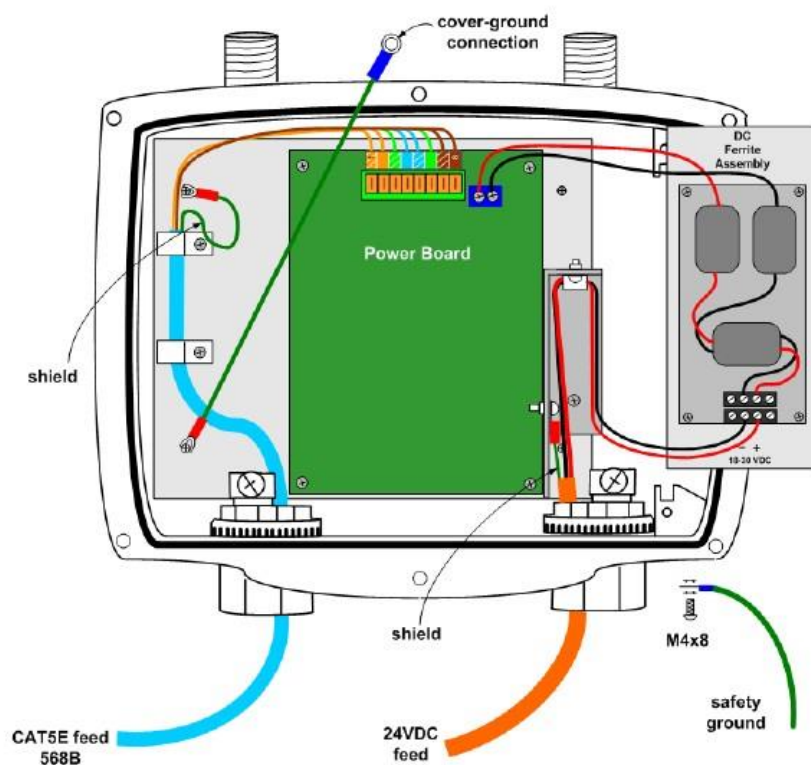
The FDAP2 has one Ethernet cable and one power cable. Ethernet interconnection is limited to installations outside Class I Division 1, Zone 0/1 locations. You must construct conduit and cable runs for power and Ethernet. The FDAP2 can be powered directly by universal AC power supply or by external DC power supply such as distributed DC source. Ensure that all wires inside the enclosure are routed and secured properly as displayed in the following figures. The FDAP2 has integrated terminal blocks that allow field wiring to

be directly terminated inside the FDAP2 without an additional external junction box. Power (both AC and DC) connection, Ethernet and Serial connections can be terminated inside the FDAP2.


## DC power wiring

When powered from an external DC source, the power cable should be terminated directly onto the terminal block of the DC Ferrite Assembly. Connected wires then pass through the mounted ferrites on the assembly board, which then connects to the two-position terminal block on the Power Board. The polarity of the connector is marked next to the connector on the Power Board. The power cable should be shielded, and the drain wire grounded inside the enclosure as displayed in the following figure.

Secure all connections and wires and connect the cover-ground connection lug to the enclosure cover to complete the wiring.




**Fig. 16. Ethernet and field DC power**

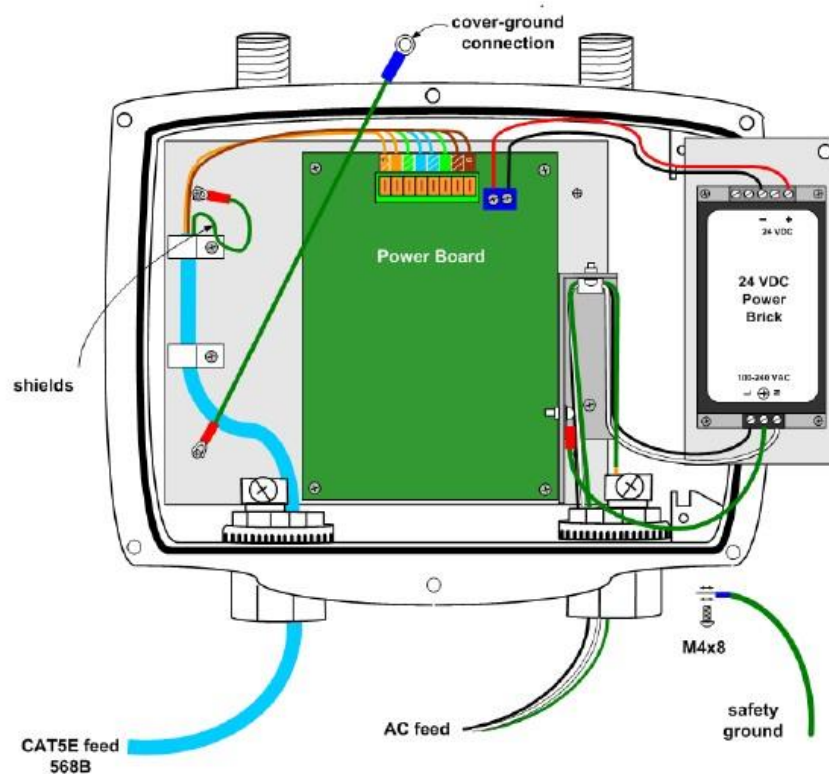
 <b>ATTENTION</b>	<p>For installations that require CE-mark compliance, the DC power source must be a CE-mark approved power supply. In addition, the DC cable between the approved DC power source must be no more than 3 meters (9.8 feet) from the FDAP2.</p>
---------------------------------------------------------------------------------------------------------	------------------------------------------------------------------------------------------------------------------------------------------------------------------------------------------------------------------------------------------------

## AC power wiring


When powered from an external AC source, the power cable should be terminated at the terminal block on the AC/DC conversion module, marked as 24 VDC Power Brick as displayed in the following figure.

1. To facilitate wiring, remove the Power Brick assembly from the enclosure by loosening the two retaining screws and sliding the brick assembly out.
2. Terminate the AC cables at the AC terminal block on the Power Brick module. The module has polarity markings for Live (L), Neutral (N) and Ground.
3. Ensure that all connections are secure and then slide the module back into the enclosure and secure it with the retaining screws.
4. Secure all connections and wires and connect the cover-ground connection lug to the enclosure cover to complete the wiring.

 <b>ATTENTION</b>	<p>If an AC power option is ordered from the factory, the DC output of the power conversion module should be pre-wired to the DC terminal block on the Power Board. Verify that the connection is secure and has the correct polarity as marked.</p>
-------------------------------------------------------------------------------------------------------	------------------------------------------------------------------------------------------------------------------------------------------------------------------------------------------------------------------------------------------------------



**Fig. 17. Ethernet and field AC power**

 <b>ATTENTION</b>	<p>Note that AC wiring only applies to the FDAP2, which is FM approved. AC wiring is not covered under IECEx certification.</p>
---------------------------------------------------------------------------------------------------------	---------------------------------------------------------------------------------------------------------------------------------


## Ethernet wiring

The FDAP has one Ethernet input for optional connection to a wired network or a wireless access point. If the FDAP is connected to a wired Ethernet, you should run the Ethernet cabling from the control system through the conduit to the FDAP site. You must install the FDAP based on the Ethernet connection. If the Ethernet cable is connected, it acts as an FDAP (access point) and if the Ethernet cable connection is removed it acts as a line powered FR (routing device). Ethernet interconnection is limited to installations outside Class I Division 1, Zone 0/1 locations. An 8-position Insulation Displacement Connector (IDC) terminal block allows a twisted pair Ethernet cable to be connected to the FDAP without stripping the wires or crimping on modular RJ-45 plugs. The drain wire from the CAT5E cable shield should be connected to the internal grounding point on the conduit hub. The cable should be of solid core type to ensure good signal quality and performance of up to 100 meters.

### Terminating the Ethernet cable







Perform the following procedure to terminates the Ethernet cable.

1. Strip the outer jacket of the CAT5e cable and connect the shield drain wire to the internal grounding lug on the conduit hub.








 <b>ATTENTION</b>	Do not strip the individual twisted pair wires.
--------------------------------------------------------------------------------------------------------	-------------------------------------------------

2. Connect the twisted pair wires to the IDC following the color chart marked next to the IDC. Note that the color chart on the FDAP Power and I/O board assumes that the cable conforms to EIA/TIA 568B color code which is the predominant color code for CAT5e cable. See the following table for the necessary adjustment if the older EIA/TIA 568A color coded cable is used. Most of the CAT5E cables conform to TIA/EIA 568B.

**Table 7. Ethernet IDC block pin-out**

PIN #	TIA/EIA 568A	TIA/EIA 568B	Data
1			Transmit+
2			Transmit-
3			Receive+



PIN #	TIA/EIA 568A	TIA/EIA 568B	Data
4			Unused
5			Unused
6			Receive-
7			Unused
8			Unused

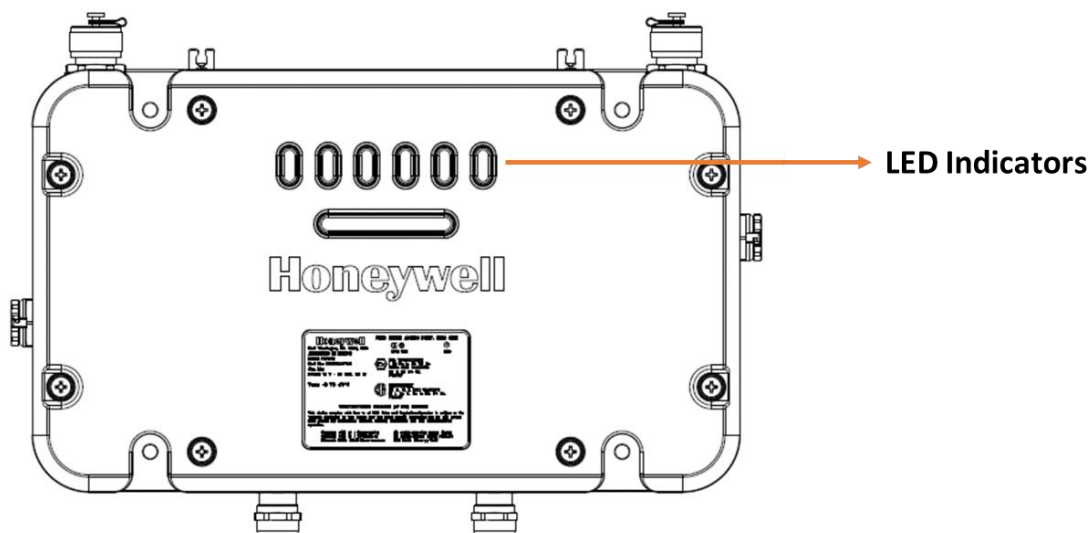
### Testing Ethernet connection for FDAP2

A standard RJ-45 modular jack is available on the FDAP2 Power and IO board. The RJ-45 jack may be used to test cable integrity after terminating the cable at the IDC connector. After terminating the field cable at the IDC, connect the cable tester to the RJ-45 jack. An end-to-end cable test can then be performed to ensure proper wiring at the IDC connector.

## Power on and startup

### FDAP Gen3 and FDAP Gen3 Anchor

The FDAP Gen3 and FDAP Gen3 Anchor have one Ethernet cable and one power cable. has six status LEDs to indicate the various stages of operation.



**Fig. 18.** LED indicators

The following table identifies the LEDs and describes the operating conditions of the unit when the LEDs are turned ON.

**Table 8. LED indicators**

LED	Description
Power LED (Red)	Indicates that the power is supplied to The FDAP Gen3 and FDAP Gen3 Anchor have one Ethernet cable and one power cable. When the FDAP Gen3 and FDAP Gen3 Anchor are powered ON, the Power LED turns ON automatically.
Ethernet Active LED (Green)	Indicates that FDAP Gen3 and FDAP Gen3 Anchor are connected to FDN network. When the FDAP Gen3 and FDAP Gen3 Anchor are connected to FDN Network, the Ethernet Active LED turns ON automatically.
Ethernet Link LED (Green)	Indicates the Ethernet link activity. The LED is steady when there is a valid Ethernet link but no data activity. The LED blinks when there is data activity on the Ethernet link.
Status LED/Heartbeat LED (Green)	Indicates the software status of FDAP Gen3 and FDAP Gen3 Anchor factory image. The Status LED blinks ON/OFF once every second to indicate that the FDAP Gen3 and FDAP Gen3 Anchor factory firmware is in the working condition.
BLE Status LED (Green)	<p>BLE Status LED provides the different states of BLE connection:</p> <ul style="list-style-type: none"> <li>• ALWAYS OFF - Advertisement off, controlled through WDM UI, typically done when FDAP has already joined the network</li> <li>• 10 seconds OFF, 1 second ON – FDAP Gen3 and FDAP Gen3 Anchor are in advertisement mode, waiting for connection from BLE Central (for example, Mobile App)</li> <li>• seconds OFF, 2 seconds ON – FDAP Gen3 and FDAP Gen3 Anchor are connected to BLE Central (for example, Mobile App). NOTE: Only connected, not yet BONDED</li> <li>• 1 second OFF, 1 second ON - FDAP Gen3 and FDAP Gen3 Anchor are bonded to BLE Central (for example, Mobile App)</li> <li>• ALWAYS ON - FDAP Gen3 and FDAP Gen3 Anchor are ready for secure data exchange with BLE Central (for example, Mobile App)</li> <li>• Special case of BLE module firmware download, where LED is toggled every 250ms (that is 250ms ON, 250ms OFF).</li> </ul> <p>NOTE: When BLE module firmware download is in progress, connection to FDAP Gen3 and FDAP Gen3 Anchor by BLE Central (for example, Mobile App) is not possible.</p>

LED	Description
RS-485 status (Green)	Indicates the RS-485 port's activity. The LED blinks when there is data activity on the RS-485 port.

## FDAP2

The FDAP2 has status LEDs to indicate the various stages of operation.



**Fig. 19.** LED indicators

The following table identifies the LEDs and describes the operating conditions of the unit when the LEDs are turned ON.

**Table. 9.** LED indicators

LED	Description
Power LED (Green)	Indicates that the power is supplied to FDAP2. When the FDAP2 is powered ON, the Power LED turns ON automatically.
Status LED/Heartbeat LED (Green)	Indicates the software status of FDAP2 factory image. The Status LED blinks ON/OFF once every second to indicate that the FDAP2 factory firmware is in the working condition.
Comm LED (Green)	Indicates the Ethernet link activity. The LED is steady when there is a valid Ethernet link but no data activity. The LED blinks when there is data activity on the Ethernet link.


---

## FDAP configuration

### Establish connection between WDM and FDAP


To establish connection between WDM and FDAP, power on the FDAP and connect FDAP to the WDM through the FDN port of WDM. If you are using multiple FDAPs, you can use an Ethernet switch to connect the FDAPs to the WDM. WDM enables you to commission, configure, and monitor the FDAPs connected to it from a centralized location. All FDAP configuration parameters are easily accessible from the WDM, which centralizes all key functions required to manage the field device network and wireless field devices.

Log on to the OneWireless user interface and configure the WDM using the First Time Configuration Wizard. The First Time Configuration wizard appears only for the first log on. For more information about First Time Configuration and OneWireless user interface details, see the *Wireless Device Manager User's Guide (OWDOC-X254-en)*.

 NOTE	<b>Physical access to critical devices</b> A malicious operation of critical WDM and access points results in system shutdown, starting the system unexpected system start up or restart, or impact process control. The critical WDM components include, Expansion Processor Module (EPM), Control Processor Module (CPM), network switches for I/O network and host communication network, I/O Modules, power supply modules, and simulator. Critical OneWireless modules include, WDM, FDAP, Access Point, WirelessHART field devices, Provisioning Handheld Device, and switches. For maximum security, the WDM must be placed in a cabinet or locked closet to protect against unauthorized access to the critical modules.
-------------------------------------------------------------------------------------------	-------------------------------------------------------------------------------------------------------------------------------------------------------------------------------------------------------------------------------------------------------------------------------------------------------------------------------------------------------------------------------------------------------------------------------------------------------------------------------------------------------------------------------------------------------------------------------------------------------------------------------------------------------------------------------------------------------------------------------------

### Provision a FDAP

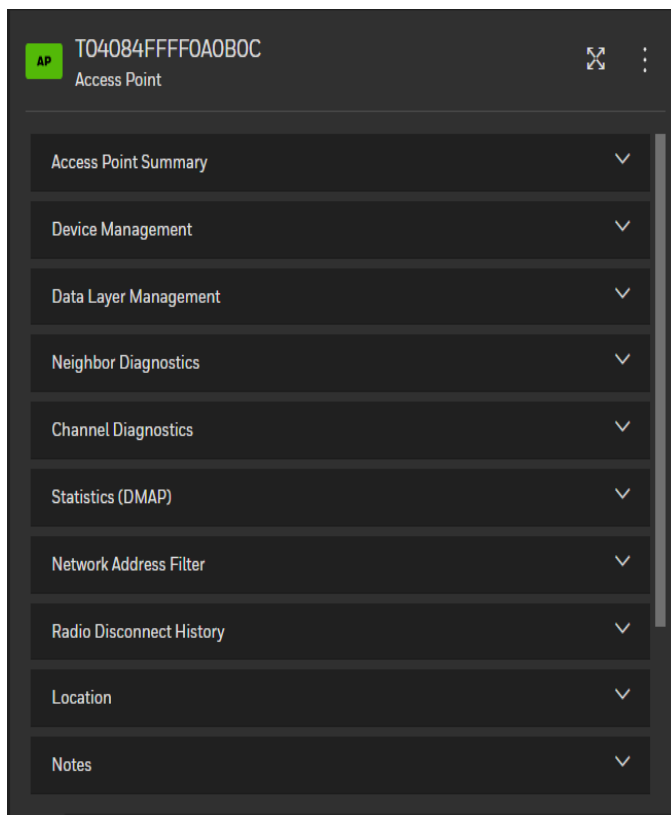
The FDAP should be given a unique authentication key to associate it with the wireless network in which it is installed and operated. The authentication keys are generated and managed by the WDM. You can provision an FDAP using over-the-air provisioning or using a Provisioning Handheld device. A Provisioning Handheld device is used to upload the authentication keys from the WDM to the Provisioning Handheld device, and then download the keys to FDAPs using IR media. The provisioning information (security, wireless) can be sent from a Provisioning Handheld device to the FDAP using the IR communication link. Once the unit is set up and the authentication is completed, the FDAP joins the network and starts communicating.

 ATTENTION	<b>Before provisioning an FDAP, ensure that you have configured the WDM using the First Time Configuration Wizard and the authentication keys are transferred to the Provisioning Handheld device from the WDM.</b>
--------------------------------------------------------------------------------------------------	---------------------------------------------------------------------------------------------------------------------------------------------------------------------------------------------------------------------

For more information about the procedure to provision an FDAP, see the *Wireless Device Manager User's Guide (OWDOC-X254-en)*.

## Description of FDAP parameters

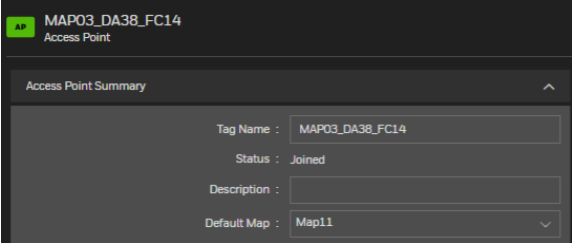
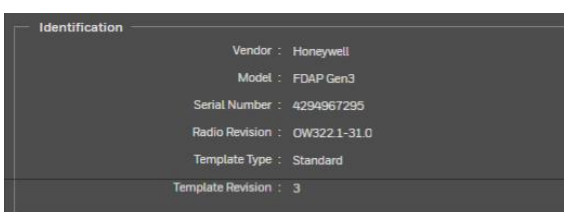
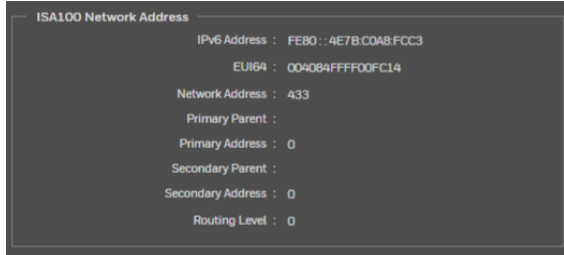

Once the FDAP joins the network, you can configure and monitor the FDAP by using OneWireless user interface. The Managed Devices in the OneWireless user interface provides a list of all the devices in the OneWireless network. The Property Panel in the Managed Devices of OneWireless user interface provides configuration properties of all the devices configured in the OneWireless network. Select the required FDAP from the list of devices from the Managed Devices and then view the FDAP parameter details in the Property Panel.

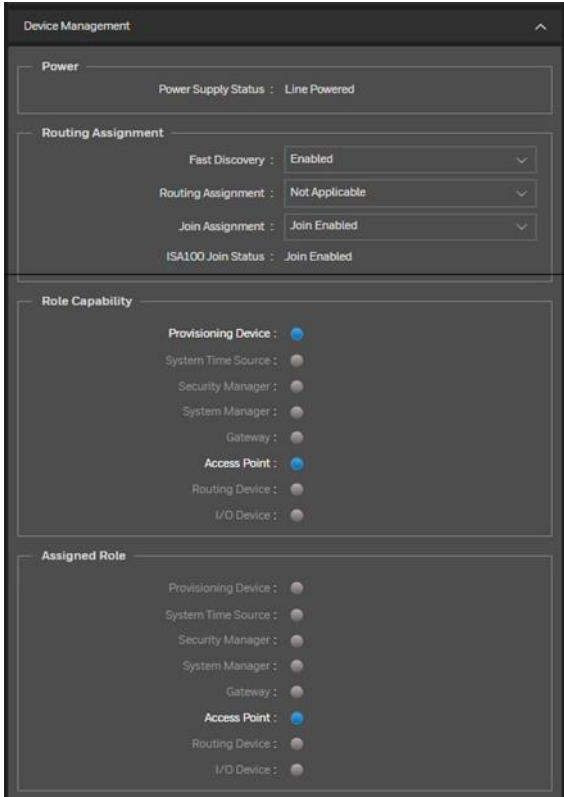


**Fig. 20.** FDAP Property Panel

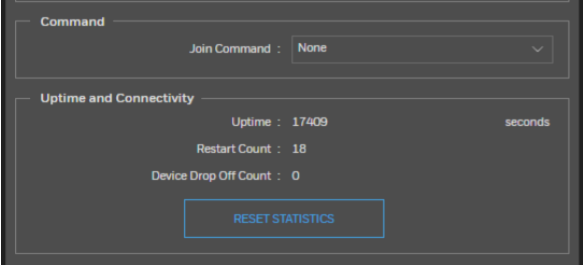
The following table describes the FDAP parameter details.

**Table 10. FDAP parameters in the selection panel**

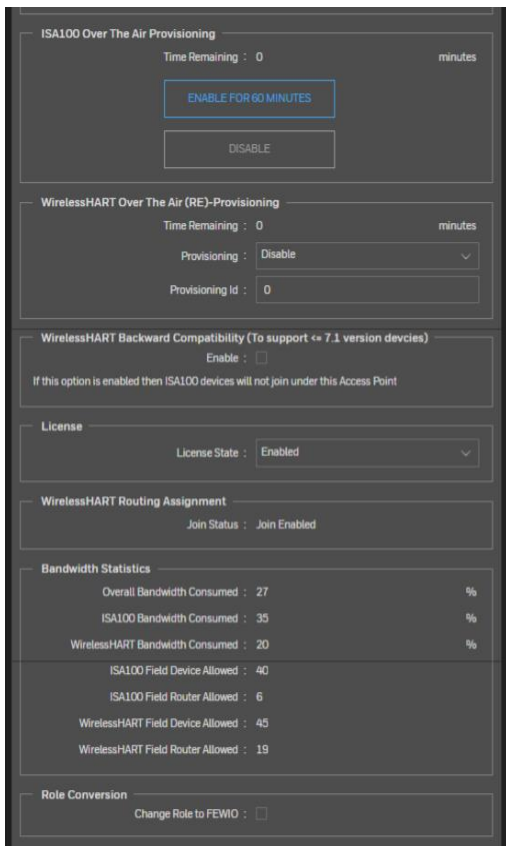
Panel	Group elements	Description
<p><b>Access Point Summary</b></p> 		<p>Tag Name: Displays the default device name. You can rename the device. Device name can be up to 16 alphanumeric characters long and it should begin with an alphabet.</p> <p>Status: Displays the device status as <b>Joined</b> or <b>Offline</b>.</p> <p>Default Map: You can select the required map on which the device must be placed.</p> <p>Description: Displays the entered description for the device. You can type the required description for the device.</p>
	Identification	Displays the identification details like Vendor, Model (device type), Serial Number (EU ID of the device), Radio Revision (firmware revision number), Template Type, and Template Revision.
	ISA100 Network Address	<p>Displays the network address details like IPv6 Address (128-bit network address), EUI64 (unique ID), Short Address (16-bit number assigned by system manager), and the Routing Level.</p> <p><b>NOTE:</b> When you move the mouse pointer over the partially visible data on the Property Panel, the complete data is visible.</p>
	ISA100 Time Synchronization	Displays the tag name and the 16-bit address of the time master of the device, and the time distribution level.

Device Management		
	Power	Displays the power supply status as Line Powered (for access points) or Battery Powered (for routing devices). By default, power status is always Line Powered.
	Routing Assignment	Displays the routing configuration of the device. The different types of configuration are Non-Routing Device, Routing Device, and Not Applicable. By default, Routing Assignment is not applicable for FDAP and it should not be changed.
	Role Capability	Displays the capable roles of a device. By default, FDAP can be an access point device, if you enable over-the-air provisioning then it can act as a provisioning device.  The different roles that can be configured are Provisioning Handheld device, System Time Source, Security Manager, System Manager, Gateway, Access Point, Routing Device, and I/O Device. If the Ethernet is plugged, it acts as an access point and if the Ethernet is unplugged, it acts as a routing device.
	Assigned Role	Displays the current assigned role of the device.

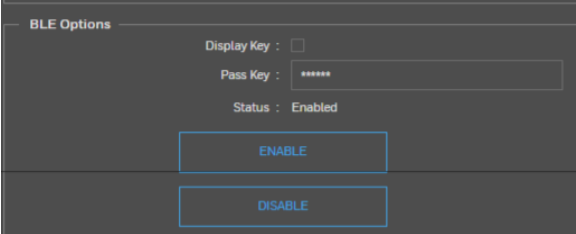
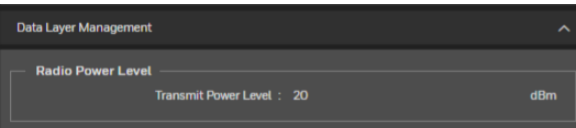
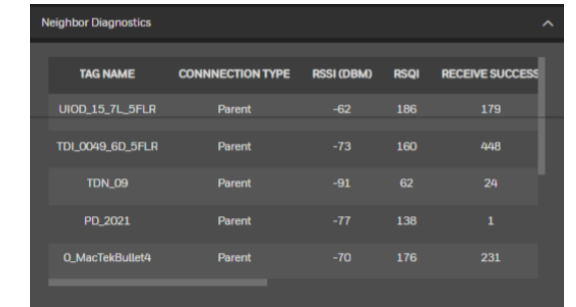


	<p>Command</p>	<p>Consists of the <b>Join Command</b> parameter which is used to restart a device or to reset a device to factory default state. Join Command parameter has the following options:</p> <ul style="list-style-type: none"> <li>• <b>None</b></li> <li>• <b>Warm Restart:</b> To restart a device. Warm Restart preserves static and constant attributes data</li> <li>• <b>Restart as Provisioned:</b> To reset the device to factory default state. Restart as Provisioned corresponds to the provisioned state of the device in which the device only retains the data received during its provisioning</li> </ul>
	<p>Uptime and Connectivity</p>	<p>Displays the uptime and connectivity details, which are as follows:</p> <ul style="list-style-type: none"> <li>• <b>Uptime:</b> Time (in seconds) during which the device is online</li> <li>• <b>Restart Count:</b> Number of times the device is restarted. The Restart Count begins from one when it is reset to default</li> <li>• <b>Device Drop Off Count:</b> Number of times the device is disconnected from the network</li> <li>• <b>Reset Statistics:</b> Resets only the Device Drop-off Count. Click to reset the Device Drop Off Count</li> </ul> <p><b>ATTENTION</b></p> <p><i>When a device is reset to default through a Provisioning Handheld device, the Restart Count and Device Drop-off Count are reset to 0.</i></p>

<p><b>Communication Redundancy</b></p> <p>Comm Redun State : Not Applicable</p> <p>Comm Redun Ratio : 0 percent</p> <p>Comm Redun Alarm : <input checked="" type="checkbox"/></p> <hr/> <p><b>ISA100 Protocol Version</b></p> <p>Version : STK-2.0</p>	<p>Communication Redundancy</p>	<ul style="list-style-type: none"> <li>• Displays the Communication Redundancy State, Communication Redundancy Ratio details</li> <li>• The <b>Communication Redundancy State</b> is the redundancy communication link between the primary and secondary parent</li> <li>• Select the <b>Communication Redundancy Alarm</b> check box to enable the "Non-Redundant Communication" alarm for the FDAP</li> </ul> <hr/> <p><b>ATTENTION</b></p> <p><i>This alarm is applicable only when the FDAP is acting as an FDAP router.</i></p>
	<p>ISA100 Protocol Version</p>	<p>Displays the supported version of ISA100 protocol.</p>
<p><b>Diagnostics</b></p> <p>Radio2 Comm Fail : <input type="radio"/></p> <p>Radio1 Comm Fail : <input type="radio"/></p> <p>Time Sync Redundancy Fail : <input type="radio"/></p> <hr/> <p><b>Network Time Protocol</b></p> <p>Time Master Preferred : TRUE</p> <p>Round Trip Time : 5 ticks</p> <p>Time Sync Drift : 1 ticks</p>	<p>Diagnostics</p>	<p>Displays the ISA100 Wireless radio diagnostics details.</p>
	<p>Network Time Protocol</p>	<p>Displays the Time Master Preferred, Round Trip Time, Time Sync Drift details.</p> <p><b>Time Master Preferred:</b> Time Master preferred is set if the Node/Device is NTP Sync capable or incapable.</p> <p><b>Time Sync Drift:</b> Time Sync Drift is the time drift of the Node/Device from its Parent in clock ticks.</p> <p><b>Round trip time:</b> The duration of the response of the ping from the system manager.</p>



Over-The-Air provisioning	Consists of the over-the-air provisioning parameters for enabling and disabling over-the-air provisioning. It also displays the time remaining for over-the-air provisioning.
WirelessHART Backward Compatibility	Check the <b>Enable</b> option if WDM supports WirelessHART.
License	Displays the status of the WDM license.
WirelessHART Routing Assignment	Displays the status of WirelessHART device joining is allowed or not.
Bandwidth Statistics	Display the bandwidth consumed by FDAP or FDAP Gen3 or FDAP Gen3 Anchor as router and approximate device can join under this FDAP or FDAP Gen3 or FDAP Gen3 Anchor as router.  Bandwidth statistics displays Overall bandwidth consumed and the breakup of ISA100 and WirelessHART device bandwidth consumed.  Approximate ISA100 device with 10sec or above publish rate can join the network  Approximate WirelessHART device with 8sec or above publish rate can join the network.
Role Conversion	FDAP or FDAP Gen3 or FDAP Gen3 Anchor as router can be converted to FEWIO role or vice versa.

	<p>BLE options</p>	<p><b>Display Key:</b> Select the Display Key check box and click apply option to view the Pass key.</p> <p><b>Pass key:</b> Pass key is a six-digit numeric key provided for Bluetooth pairing. Update the new key and click Apply option to change the pass key.</p> <p><b>Status:</b> Status of Bluetooth is shown in the Status field.</p> <p><b>Enable button</b> - Enables the Bluetooth module to be ready for connection.</p> <p><b>Disable button</b> - Once disabled you cannot discover the FDAP or FDAP Gen3 using the Provisioning handheld device.</p> <p><b>NOTE:</b> BLE Options are only applicable to FDAP Gen3 and FDAP Gen3 Anchor.</p>
<p><b>Data Layer Management</b></p> 	<p>Radio Power Level</p>	<p>Displays the transmission power level. The default power level is 16 dBm.</p>
<p><b>Neighbor Diagnostics</b></p> 		<p>Displays the neighboring devices diagnostics like the Device Tag Name, RSSI, RSQI, Transmit Fail, Transmit CCA Back off, Transmit NACK, and Clock Sigma.</p>

### Channel Diagnostics

CHANNEL	NO ACK	CCA BACKOFF
11	21	0
12	0	0
13	18	0
14	0	0
15	29	0

Displays the device's channel diagnostics like channel, No ACK, and CCA back off.

### Statistics (DMAP)

Read Message Totals  
Request :  
Response :  
Timeout :

Write Message Totals  
Request :  
Response :  
Timeout :

Execute Message Totals  
Request :  
Response :  
Timeout :

Availability  
Availability Since :  
Availability : %

RESET STATISTICS

Displays the details about the ISA100 Wireless data link layer statistics for a selected device. Displays the Read Message Totals, Write Message Totals, and Execute Message Totals details.

### Network Address Filter

NETWORK ADDRESS FILTER

0  
0  
0  
0  
0

Filter Enable :

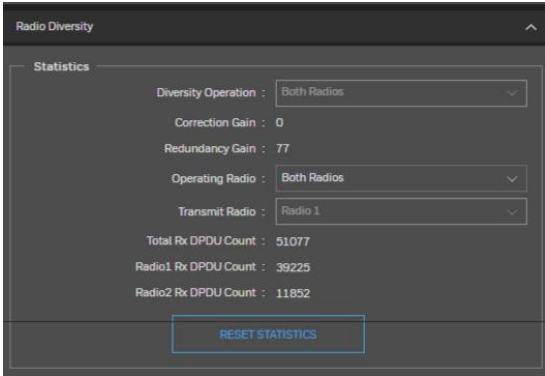
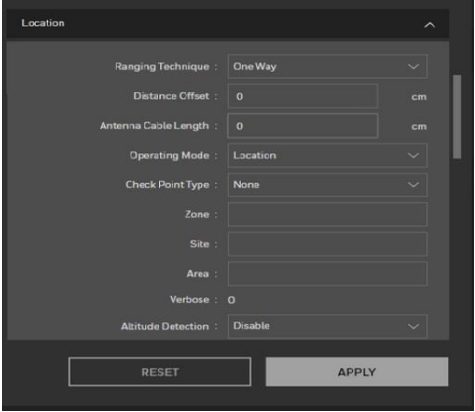
The Filter option allows you to customize the device list by filtering the devices.

### Radio Disconnect History

RADIO DISCONNECT HISTORY

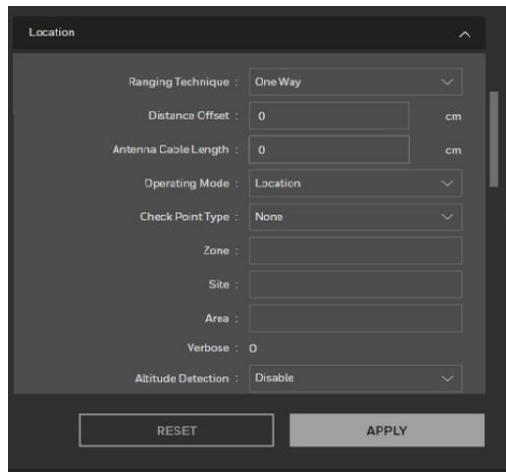
SysMngr Comm Timeout  
Power On  
Power On  
Power On

Displays the radio disconnect history details.

<p><b>Radio Diversity</b></p>	<p>Error Distribution Count</p>	<p>Displays the error distribution counter, which corresponds to the error packet counter for the number of bytes corrected. The error packet counter is the total count of error packets received on both antennas with the Cyclic Redundancy Check (CRC) error.</p>
	<p>Statistics</p>	<p><b>Diversity Operation:</b> Displays the FDAP or FDAP Gen3 antenna operational status. The status can be Both Radios, Radio 1 or Radio 2.</p> <p><b>Correction Gain:</b> Displays the correction gain, which is the total packet corrected by packet error correction algorithm.</p> <p><b>Redundancy Gain:</b> Displays the redundancy gain, which is the minimum value of total packets received by antenna 1 without any packet errors + minimum value of total packets received by antenna 2 without any packet errors / total packets received by antenna 1 and 2 without any packet errors.</p> <p>Reset Statistics: Resets all the radio diversity values. Click to reset all the radio diversity values.</p>
<p><b>Location</b></p> <p><b>NOTE:</b></p> <p>Location Options are only applicable to FDAP Gen3 Anchor.</p> 		<p><b>Ranging Technique:</b> Displays the Ranging technique used between Tag and FDAP Gen 3 Anchor. The following are the Ranging Techniques.</p> <ul style="list-style-type: none"> <li>• One way Ranging</li> <li>• Two way Ranging</li> <li>• Hybrid Ranging</li> </ul> <p><b>Hybrid Techniques</b> – Starts with One way Ranging, during retry it switches to Two way Ranging.</p> <p><b>Distance Offset:</b> Displays the minimum expected distance between tag and FDAP Gen 3 Anchor.</p>

**NOTE:**

Location Options are only applicable to FDAP Gen3 Anchor.



**Antenna Cable Length:** Displays the cable length of the antenna.

**Operating mode:**

- Location → Participates in trilateration to detect tag's location.
- Zone → Detects tag's presence and measures distance between tag and anchor.
- Checkpoint → Detects tag's presence.
- None → Does not participate in RTLS activities.

**Check Point Type:** Applicable when operating mode is in Checkpoint.

- None → No checkpoint configured.
- Login.
- Logout.
- Mustering.
- Restricted.
- Storage.

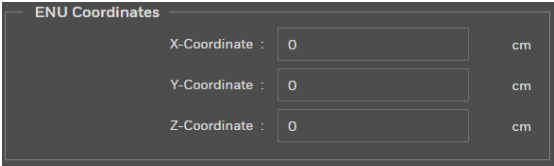
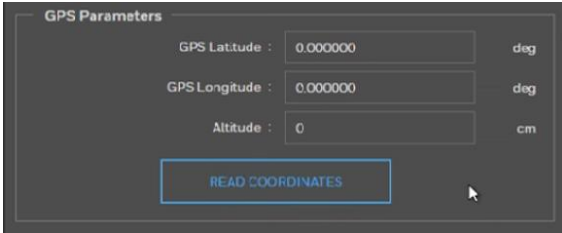
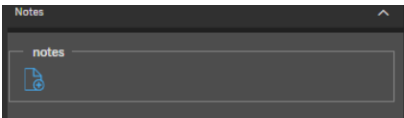
**Zone:** Zone name where FDAP Gen 3 Anchor is installed.

**Site:** Site name where FDAP Gen 3 Anchor is installed.

**Area:** Area name where FDAP Gen 3 Anchor is installed.

**Altitude Detection:** Enable/disable altitude detection in FDAP Gen 3 Anchor.

- 0 - Disable → Disable altitude detection in FDAP Gen 3 Anchor.
- 1 - Enable → Enable altitude detection in FDAP Gen 3 Anchor.

<p><b>NOTE:</b> Location Options are only applicable to FDAP Gen3 Anchor.</p>		<p><b>Altitude Reference:</b> Altitude computed with sea level as reference.</p> <ul style="list-style-type: none"> <li>• Absolute → Altitude computed from sea level.</li> <li>• Relative → Altitude computed relative to installation site.</li> </ul>
<p><b>NOTE:</b> Location Options are only applicable to FDAP Gen3 Anchor.</p> 	<p>ENU Coordinates</p>	<p><b>X Co-ordinate:</b> East North Up or local tangent plane X-axis co-ordinate. <b>Y Co-ordinate:</b> East North Up or local tangent plane Y-axis co-ordinate. <b>Z Co-ordinate:</b> East North Up or local tangent plane Z-axis co-ordinate.</p> <p>Units of X, Y, and Z Co-ordinates must be entered in cm.</p>
<p><b>NOTE:</b> Location Options are only applicable to FDAP Gen3 Anchor.</p> 	<p>GPS Parameters</p>	<p><b>GPS Latitude:</b> World Geodetic System 84 (WGS84) latitude. <b>GPS Longitude:</b> World Geodetic System 84 (WGS84) longitude. <b>Altitude:</b> Altitude or height or elevation in 'cm' units of anchor from Earth's sea level.</p> <p>GPS latitude and longitude are representing in deg with six digits after the decimal point.</p> <p><b>READ COORDINATES:</b> On clicking READ COORDINATES, WDM will read the current ENU Coordinates and GPS parameters values from the Anchors.</p>
<p><b>Notes</b></p> 		<p>Displays notes entered for the FDAP or FDAP Gen3 and FDAP Gen3 Anchor.</p>



---

# Field Expandable Wireless IO

## Overview

Field Expandable Wireless IO (FEWIO) is an innovative solution aimed to provide a method for integrating legacy Modbus devices into OneWireless system. FDAP is configured in a way that it can be used as an expandable wireless device that extracts the data from legacy Modbus devices, wirelessly. This is a licensed feature.

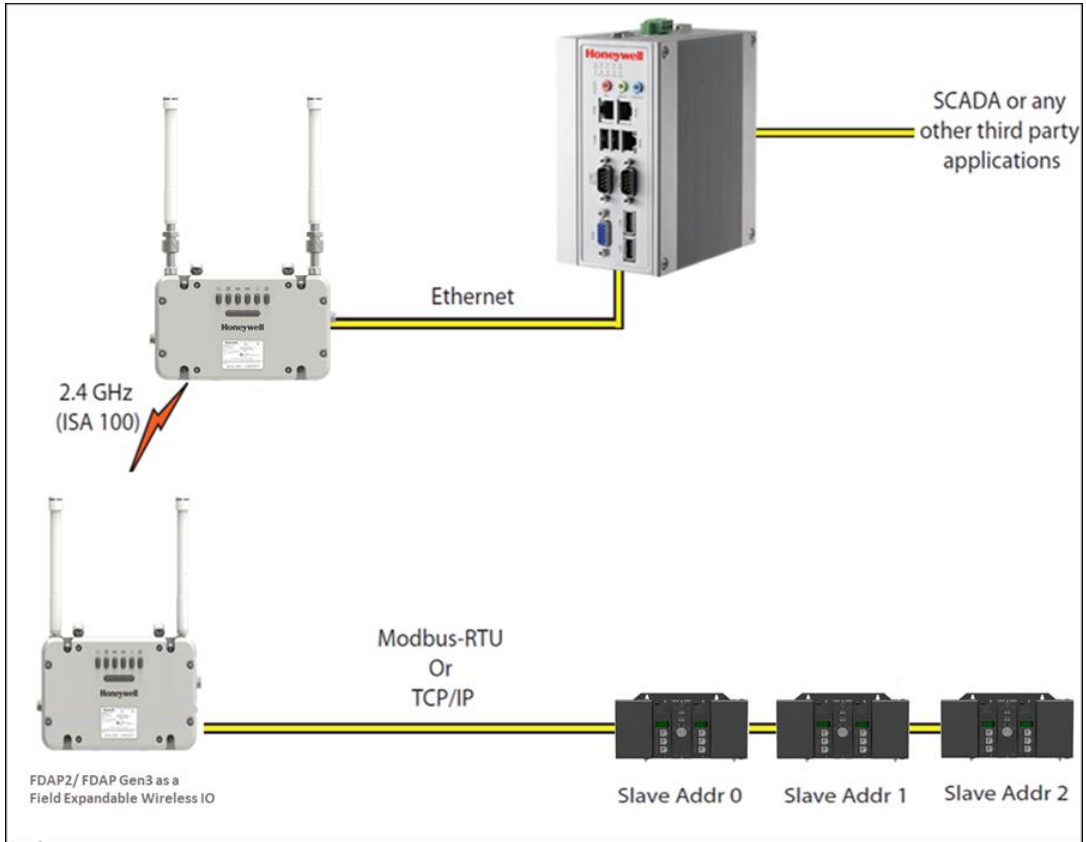
Typically, in a plant there are thousands of legacy wired Modbus devices and managing (monitoring, viewing, accessing data) them is a mammoth task. To wirelessly enable this, you can use the FEWIO solution. This solution gives huge cost savings (no wiring, switches are required) and makes the data easily accessible.

You can connect multiple Modbus devices to OneWireless network using the FDAP. The FDAP changes its role to FEWIO and extracts the data from Modbus (RTU/TCP) slave devices and converts it into the ISA100 environment. The legacy devices are connected to the FDAP using the RS-485 protocol or TCP/IP. The collected data in WDM can be accessed by SCADA or any other third-party applications.

FDAP acting as a field router can only be converted to FEWIO.

## FEWIO solution

The following figure shows a graphical overview of the FEWIO solution with FDAP Gen3.



**Fig. 21.** FDAP FEWIO Solution

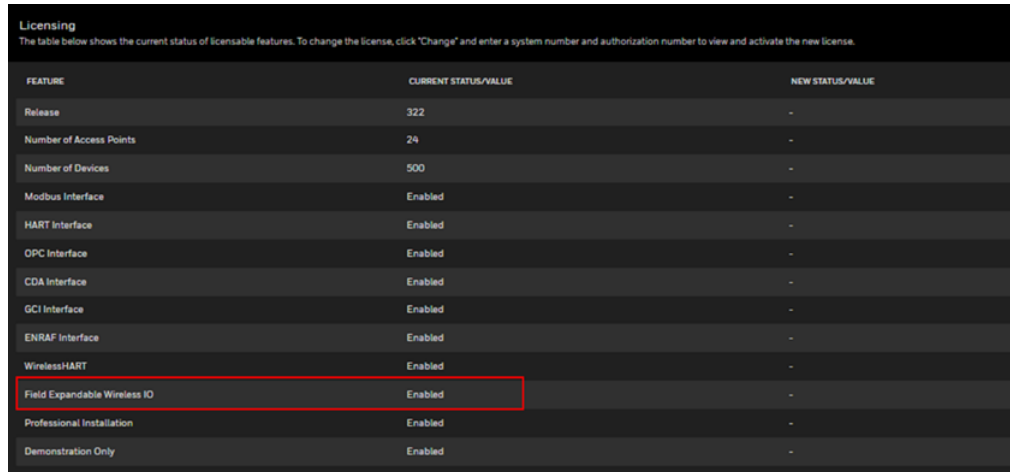
---

## Converting FDAP Router to FEWIO device

To convert FDAP Router to FEWIO:

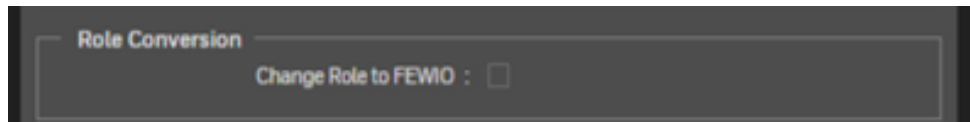
1. Ensure that you have the licensed version of WDM that includes FEWIO feature. Click **Manage Licenses** from the Menu bar.

The **Licensing** window appears.



FEATURE	CURRENT STATUS/VALUE	NEW STATUS/VALUE
Release	322	-
Number of Access Points	24	-
Number of Devices	500	-
Modbus Interface	Enabled	-
HART Interface	Enabled	-
OPC Interface	Enabled	-
CDA Interface	Enabled	-
GCI Interface	Enabled	-
ENRAF Interface	Enabled	-
WirelessHART	Enabled	-
Field Expandable Wireless IO	Enabled	-
Professional Installation	Enabled	-
Demonstration Only	Enabled	-

3. Select the FDAP router that needs to be converted as FEWIO from the section list.
4. Expand **Device Management** in the Property Panel from **Manage Devices**.  
Under Role Conversion, select the **Change Role to FEWIO** checkbox.



5. Click **Apply**.
6. The Confirm Field Expandable Wireless IO Change window appears, click **OK**.

The FDAP router drops out from the network and rejoins as Field device with FEWIO role.

## Connecting Modbus TCP devices to FEWIO device

### FDAP Gen3 and FDAP Gen 3 Anchor

The FDAP Gen3 and FDAP Gen3 Anchor router Ethernet cable should be connected to the Modbus Slave Ethernet port. The shield wire from cable must be secured on the chassis on the terminal power board.

FDAP2

The FDAP2 router Ethernet cable should be connected to the Modbus Slave Ethernet port as shown in the following figure.

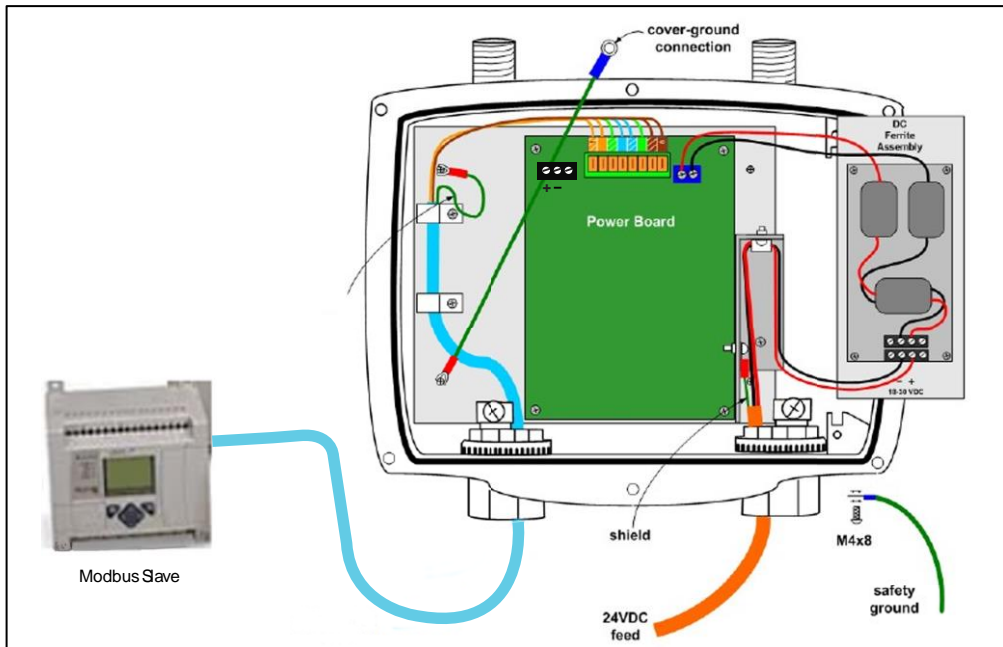


Fig. 22. FDAP2 Connecting Modbus

The FDAP router Ethernet cable should be connected through a Cisco Switch, if you have multiple TCP Modbus slaves as shown in the following figure.

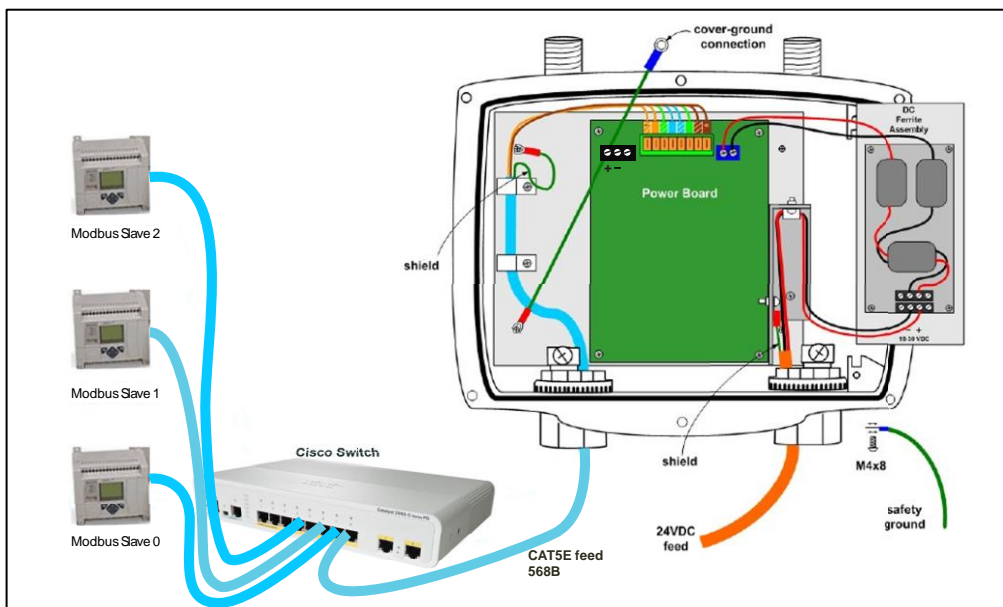


Fig. 23. FDAP with Cisco Switch- Multiple Modbus

## Connecting Modbus RTU devices to FEWIO device

### FDAP Gen3 and FDAP Gen3 Anchor

The FDAP Gen3 and FDAP Gen3 Anchor supports a two-wire RS-485 interface. A three-pin connector is available on the Power Board of the FDAP Gen3 and FDAP Gen3 Anchor when FDAP Gen3 and FDAP Gen3 Anchor top cover are opened as shown in the following figure.

The Ethernet connectivity is applicable only for Modbus TCP, when FDAP Gen3 and FDAP Gen3 Anchor acts as a FEWIO device.

B and A (Data+ and data-) are the two pins that must be connected to the slave RS-485 2-wire connection as shown in the following figure 24 and figure 25.

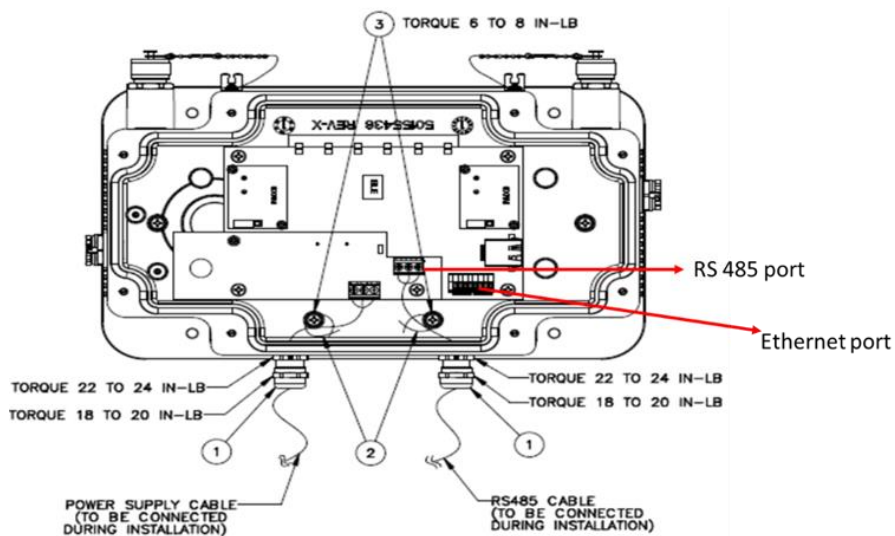


Fig. 24. FDAP Gen3 Connecting with Modbus

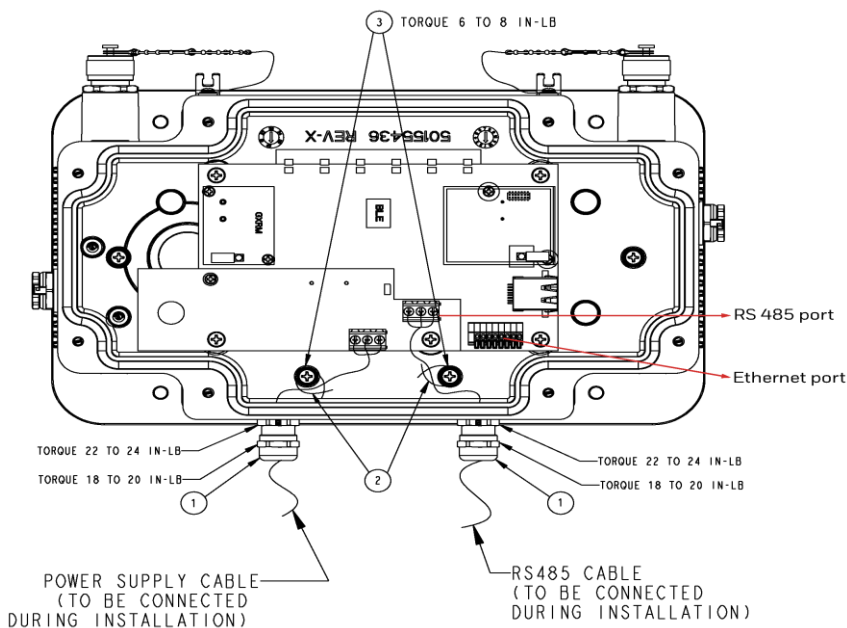


Fig. 25. FDAP Gen3 Anchor Connecting with Modbus

The Jumper is used to switch the connection between RS-485 and Ethernet. When the Jumper is placed in its relevant position as shown in the following figure, the connection towards RS-485 is terminated and Ethernet is configured. The removal of Jumper enables RS-485 connection and terminates Ethernet configuration effectively.

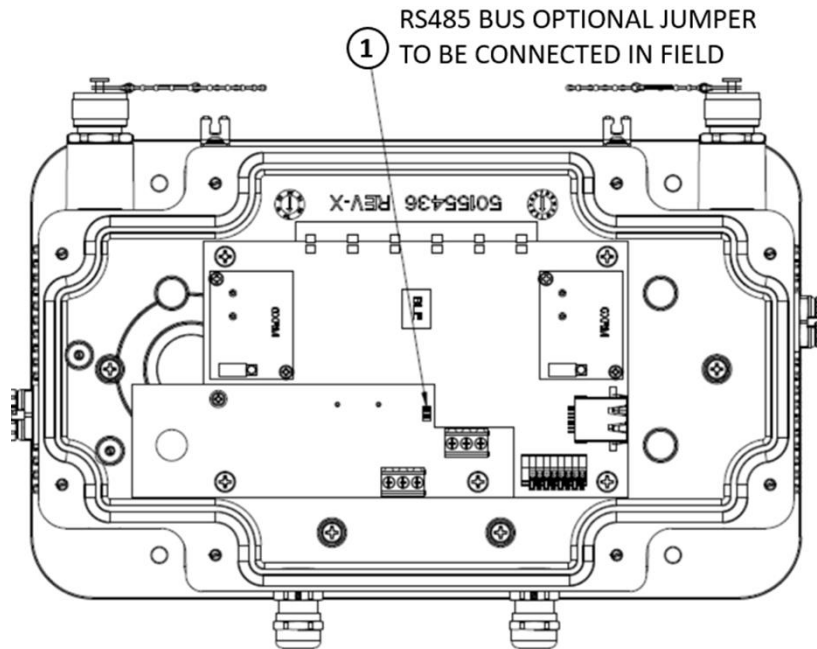


Fig. 26. FDAP Gen3 Jumper connection

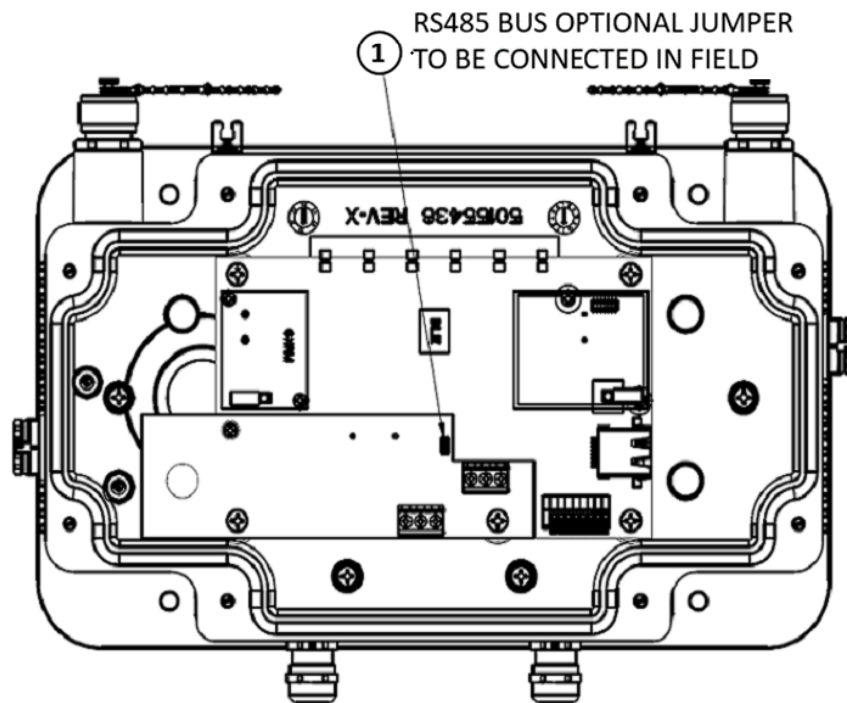


Fig. 27. FDAP Gen3 Anchor Jumper connection

## FDAP2

The FDAP2 supports a two-wire RS-485 interface. A three-pin connector is available on the Power Board of the FDAP2 when the FDAP2 top cover is opened as shown in the following figure, V+ and V- are the two pins that must be connected to slave RS-485 two-wire connection (DATA+ and DATA-) as shown in the following figure.

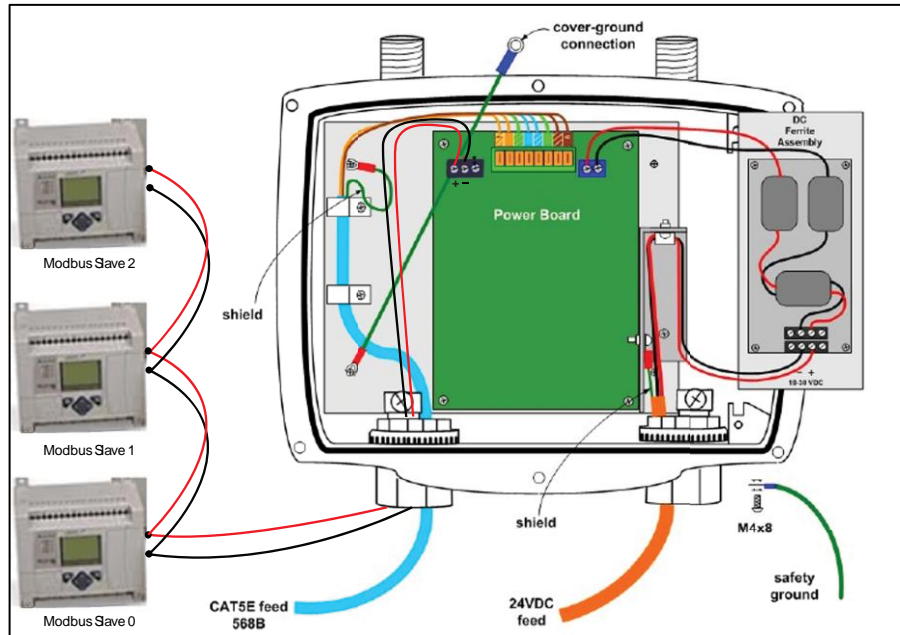



Fig. 28. FDAP2 Connection with Modbus

## Configure FEWIO device in WDM

To configure FEWIO device in WDM:

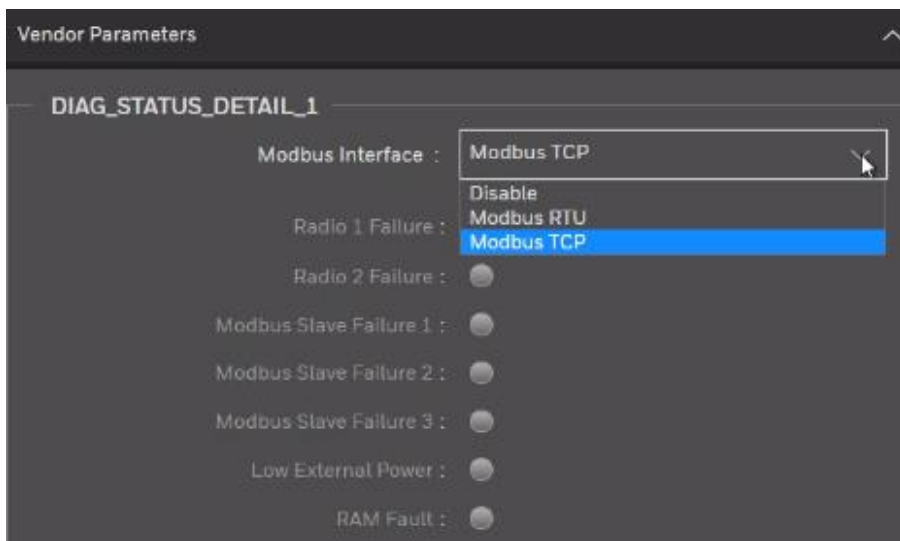
1. Make sure that the FEWIO DD file is loaded in WDM.

 <b>ATTENTION</b>	FDAP as FWIO, FDAP Gen3 and FDAP Gen3 Anchor as FEWIO role has different DD files
---------------------------------------------------------------------------------------------------------	-----------------------------------------------------------------------------------

2. Select the applicable FEWIO, which needs to be configured from the Selection Panel under **Manage Devices**.

TAG NAME	DEVICE TYPE	STATUS	VENDOR	MODEL	REVISION	SERIAL	IPV6 ADDRESS
wdmsy...	Device Manag...	Joined	Honeywell	WDM	OW322.1-29.0	0	FE80::4E7C...
OldFD...	Access Point	Joined	Honeywell	FDAP2	OW322.1-28.0	1	FE80::4E7B...
TD408...	ISA100	Joined	Honeywell	FDAP Gen3 FEWIO	OW322.1-31.0	1	FE80::0040...
TD408...	ISA100	Joined	Honeywell	FDAP Gen3 FEWIO	OW322.1-34.0	4294967295	FE80::0040...
702_Ix...	WirelessHART	Joined	Rosemount	702 Wireless Dis	3	378637	FE80::001B...

- Expand **Vendor Parameters** in the Property Panel.



- In the Modbus Interface list, click the required option. The following are the interface options available.
  - Modbus RTU
  - Modbus TCP

 <b>ATTENTION</b>	<p>Based on the connected Modbus devices, select the appropriate option.</p>
----------------------	------------------------------------------------------------------------------

- Configure one of the following depending on the Modbus interface option that you have selected.
  - If you have selected Modbus TCP Interface, configure the following under Modbus TCP Settings.
    - FEWIO IP Addr: IP address that needs to be assigned to FEWIO and the IP address Subnet should be same as the IP address of slaves
    - Subnet Mask: Subnet Mask

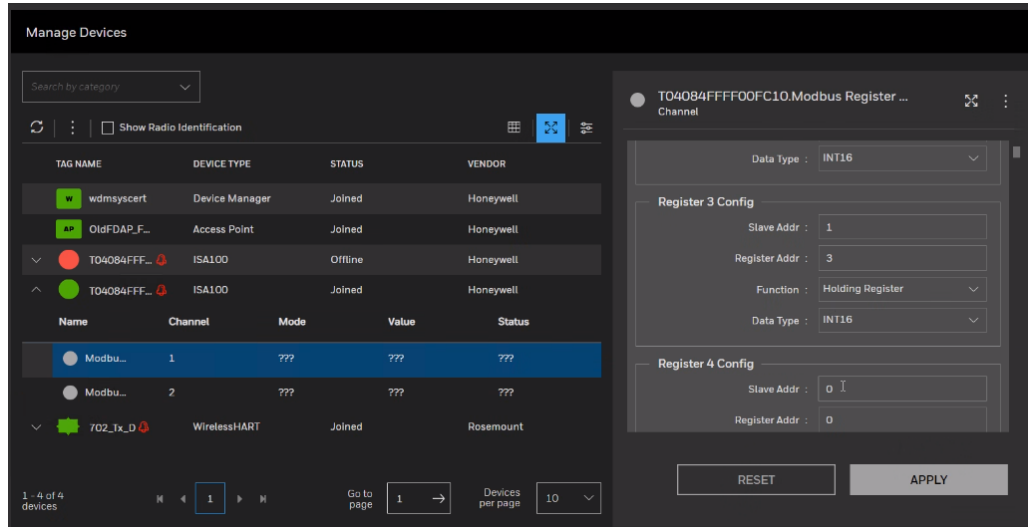


- 
- Gateway: Gateway IP address
  - Slave1 IP Addr: IP address of Slave1
  - Slave2 IP Addr: IP address of Slave2
  - Slave3 IP Addr: IP address of Slave3
  - Slave1 UnitID: Unit ID of Slave1 used for the Modbus TCP port
  - Slave2 UnitID: Unit ID of Slave2 used for the Modbus TCP port
  - Slave3 UnitID: Unit ID of Slave3 used for the Modbus TCP port
  - If you have selected Modbus RTU Interface, configure the following under Modbus RTU Settings.
    - Baud Rate: Select the baud rate used for the Modbus RTU serial port. Options include: 9600,19200, 38400, 57600, 11520.
    - Parity: The parity used for the Modbus RTU serial port. Options include: Even and Odd.
    - Stop Bits: Options include: 1 and 2.
    - Byte Order: Select a byte order that matches the expected byte order of the Modbus client. Options include: Big Endian, Little Endian, Big Endian Bytes Swapped, and Little Endian Bytes Swapped.

## Configuring and viewing the Modbus Registers

### To configure the Modbus Registers:

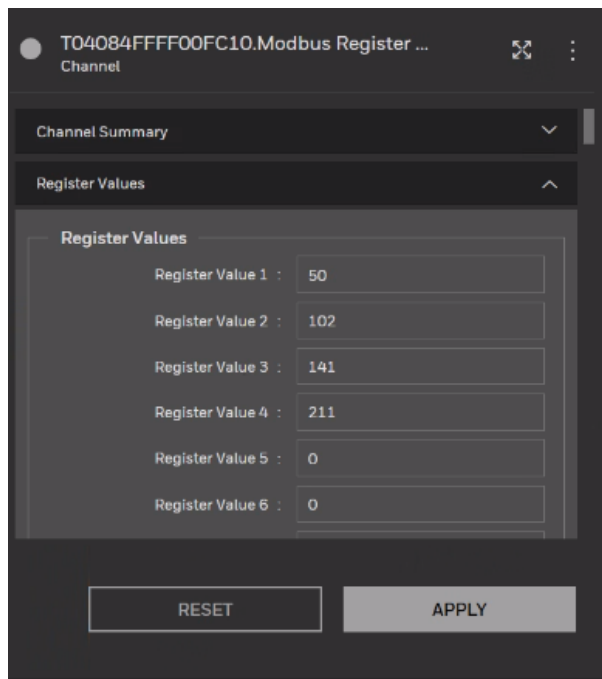
1. Select the **FEWIO device** from the Selection Panel under **Manage Devices**.
2. Expand the FEWIO device and select **Modbus Register Config**.



3. Expand **Register Configuration** from the Property Panel.
4. Configure the following under each Register Config:
  - **Slave Addr:** Slave Address
  - **Register Addr:** Register Address
  - **Function:** Select the required function option from the dropdown list. Options include: Input Register, Holding Register, Coil and Discrete Registers.
  - **Data Type:** Select the required data type option from the dropdown list. Options include: INT16, INT32, UINT16, UINT32, Float and Boolean.
5. Click **Apply**.

### To view the configured Modbus Registers:

1. Select **Modbus Register Values** from the Selection Panel.
2. Expand **Register Values** from the Property Panel.
3. Now, you can view the respective register values as shown in the following figure. The values shown for each register is the value read from the respective slave device registers as configured in the register configuration.

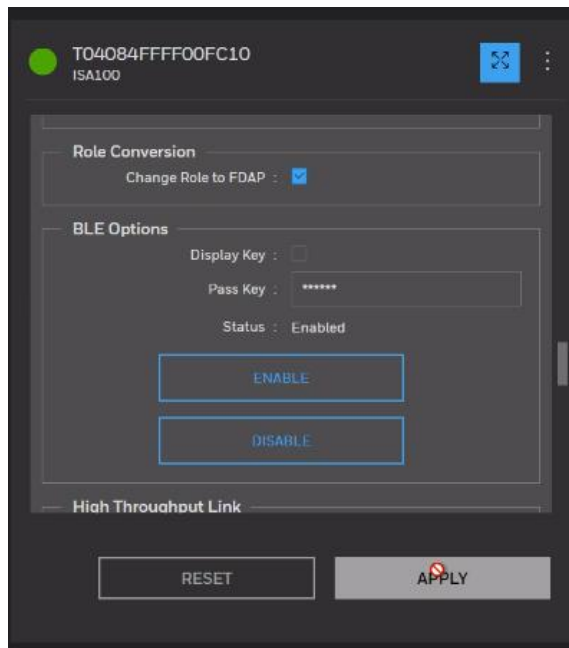



## Converting FEWIO device to FDAP Router

To convert FEWIO to FDAP Router:

1. Select the FEWIO that needs to be converted as an FDAP router in the Selection Panel from **Manage Devices**.
2. Expand **Device Management** from the Property Panel.

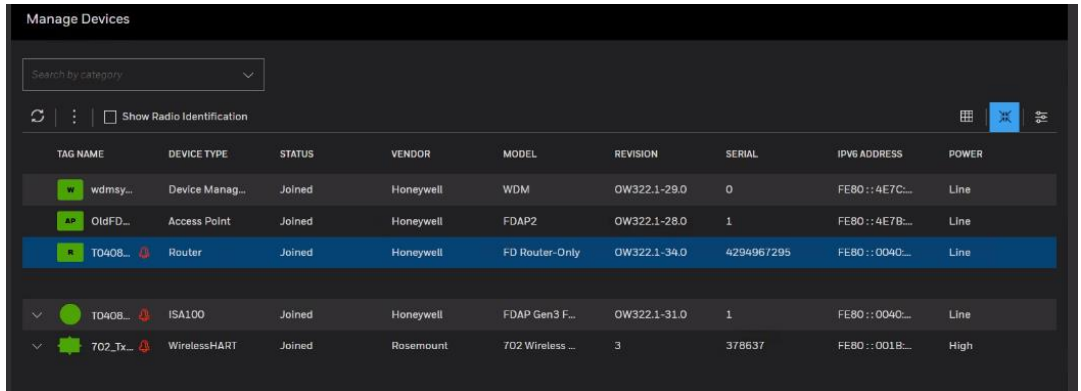
Under Role Conversion, select the **Change Role to FDAP** check box.



 <b>ATTENTION</b>	<b>BLE Options is only applicable to FDAP Gen3 and FDAP Gen3 Anchor</b>
-------------------------------------------------------------------------------------------------------	-------------------------------------------------------------------------

3. Click **Apply**.

The device drops out from the network and rejoins as an FDAP router.



TAG NAME	DEVICE TYPE	STATUS	VENDOR	MODEL	REVISION	SERIAL	IPV6 ADDRESS	POWER
wdmsy...	Device Manag...	Joined	Honeywell	WDM	OW322.1-29.0	0	FE80::4E7C...	Line
OldFD...	Access Point	Joined	Honeywell	FDAP2	OW322.1-28.0	1	FE80::4E7B...	Line
T0408...	Router	Joined	Honeywell	FD Router-Only	OW322.1-34.0	4294967295	FE80::0040...	Line
T0408...	ISA100	Joined	Honeywell	FDAP Gen3 F...	OW322.1-31.0	1	FE80::0040...	Line
702_Tx...	WirelessHART	Joined	Rosemount	702 Wireless ...	3	378637	FE80::001B...	High


## Integrating with Experion

The FEWIO device is natively integrated with Experion system. All parameter read and write, configuration support is provided in Experion for the FEWIO device through the ISA100 DD file.

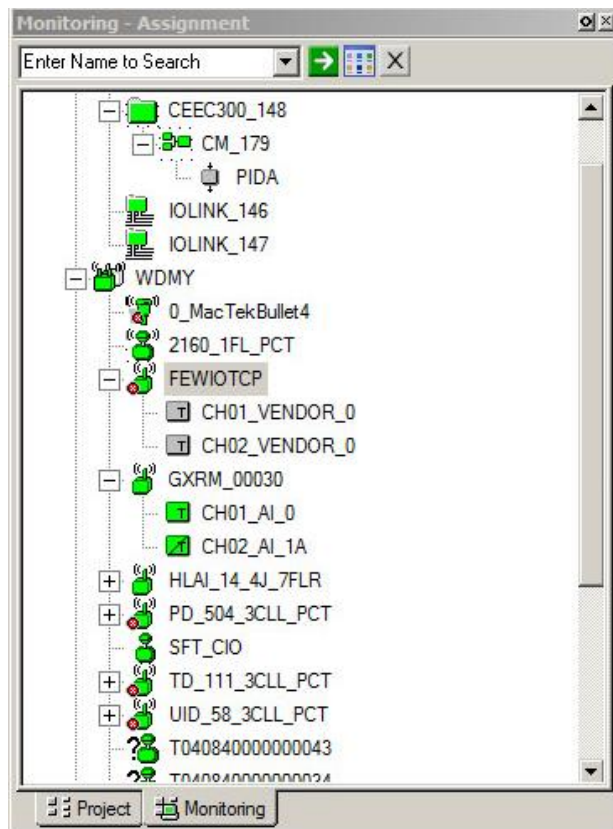
FEWIO comes as an uncommissioned ISA 100 device in Experion Control Builder, just like any other ISA100 field device. It is commissioned and configured like other ISA100 field devices.

### To configure the Modbus Registers of FEWIO:

1. Make sure that FEWIO DD file is loaded in Control Builder.

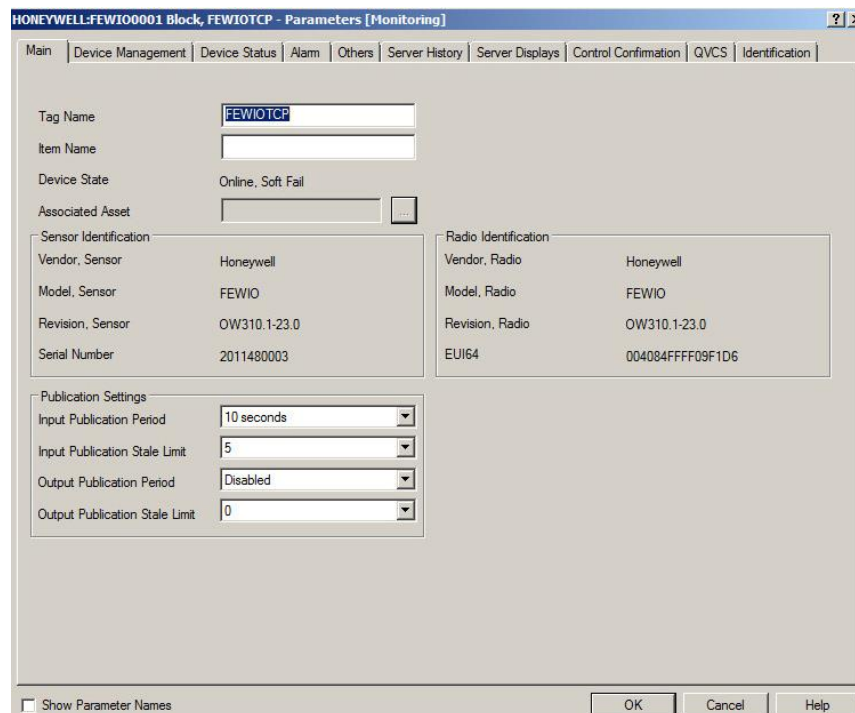
 <b>ATTENTION</b>	<b>FDAP as FWIO, FDAP Gen3, and FDAP Gen3 Anchor as FEWIO role has different DD files</b>
---------------------------------------------------------------------------------------------------------	-------------------------------------------------------------------------------------------

2. Commission the FEWIO device in Control Builder.
3. Once commissioned, the FEWIO appears in Control builder as shown in the following figure.

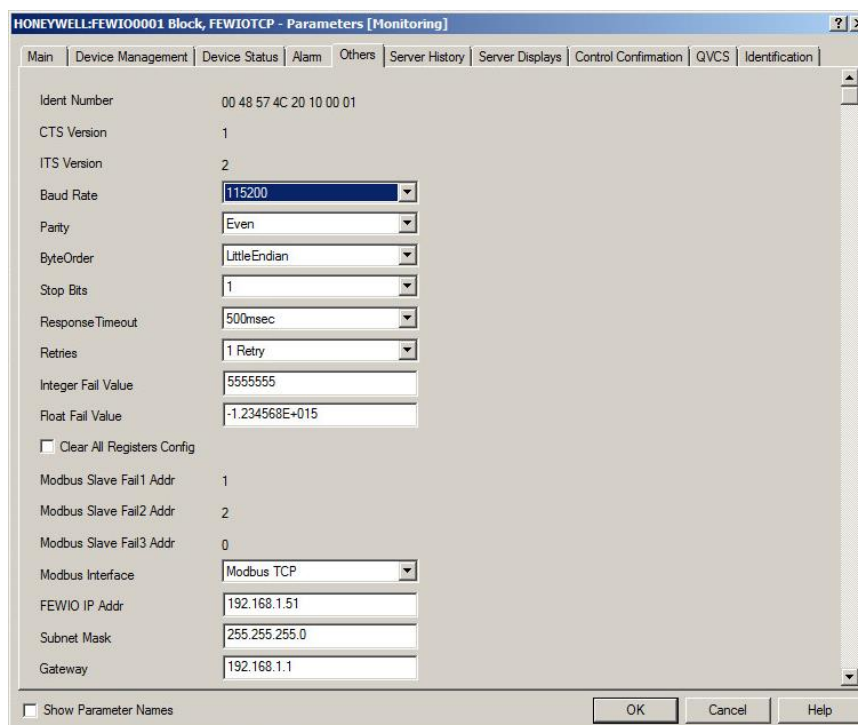


4. Double-click on the FEWIO that needs to be configured.

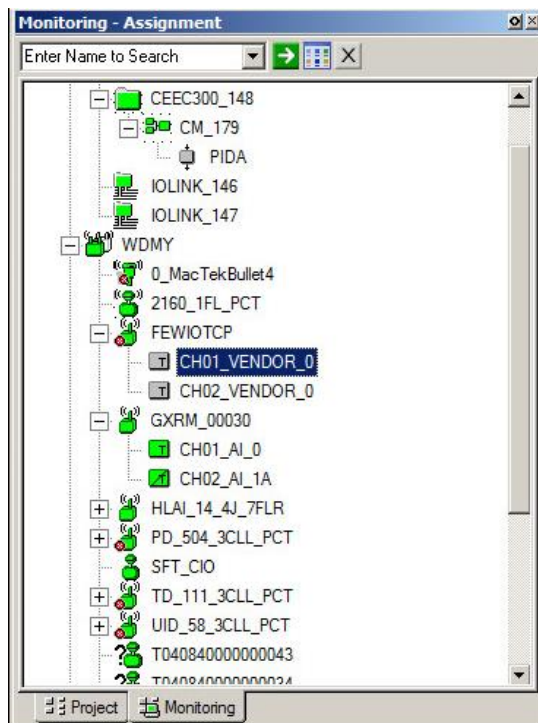
The **FEWIO-Parameters [Monitoring]** window appears.



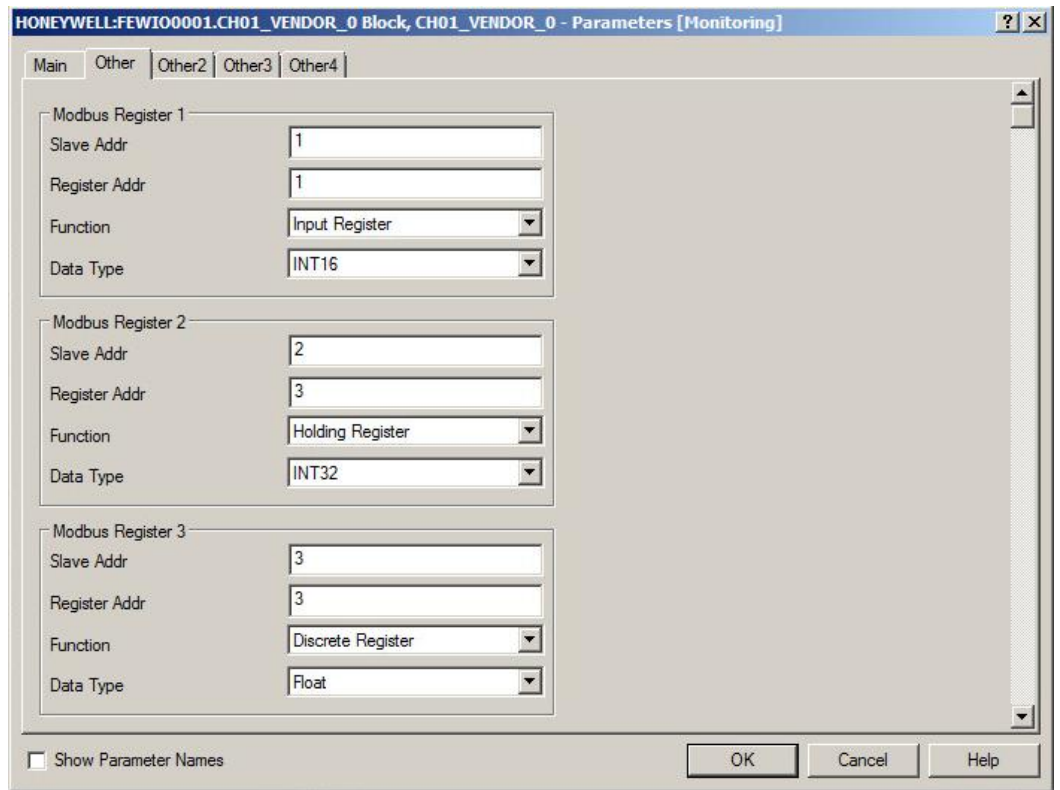
5. Go to **Others** tab and configure the parameters in the same way as configured in the WDM.



6. Click **OK**.
7. On the **Monitoring-Assignment** window, under the FEWIO, double-Click **CH01\_VENDOR\_0**.



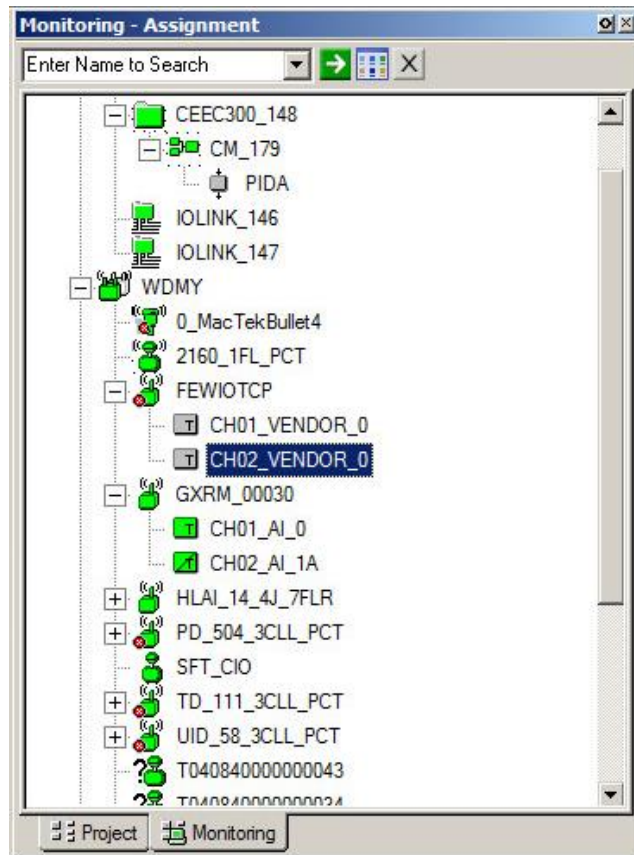
8. The **CH01\_VENDOR\_0-Parameters [Monitoring]** window appears.
9. Go to **Others** tab and configure the parameters in the same way as they are configured in the WDM.



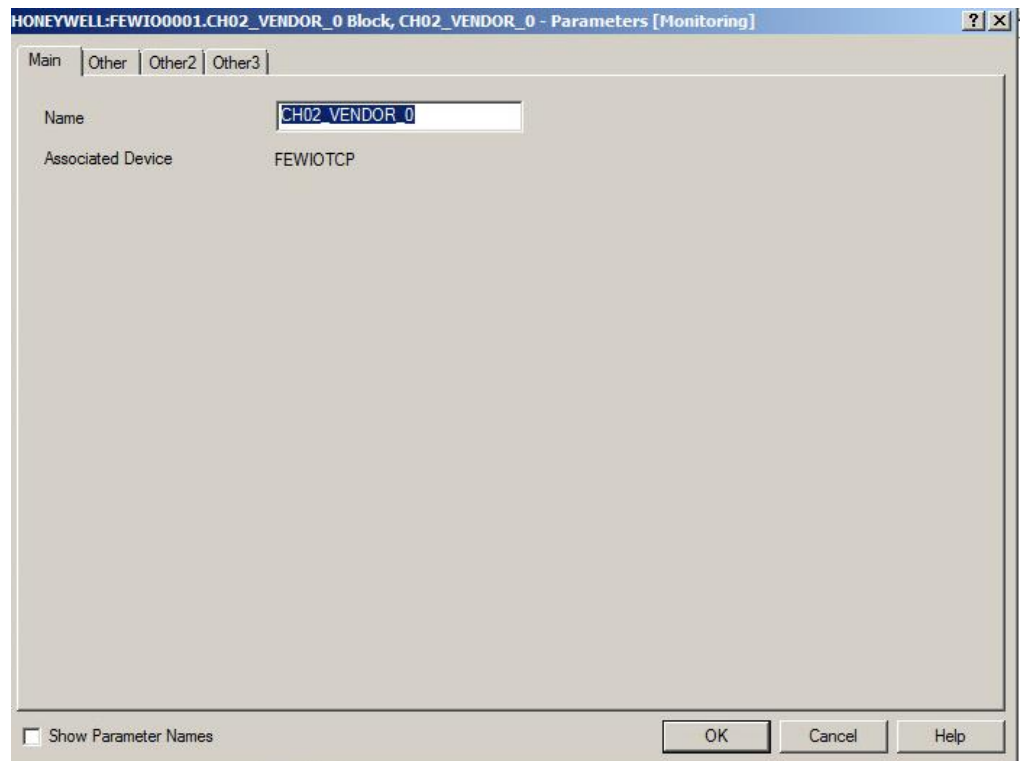
10. Click **OK**.

**To view the configured Modbus Registers:**

1. On the **Monitoring-Assignment** window, under the FEWIO, double-click **CH02\_VENDOR\_0**.



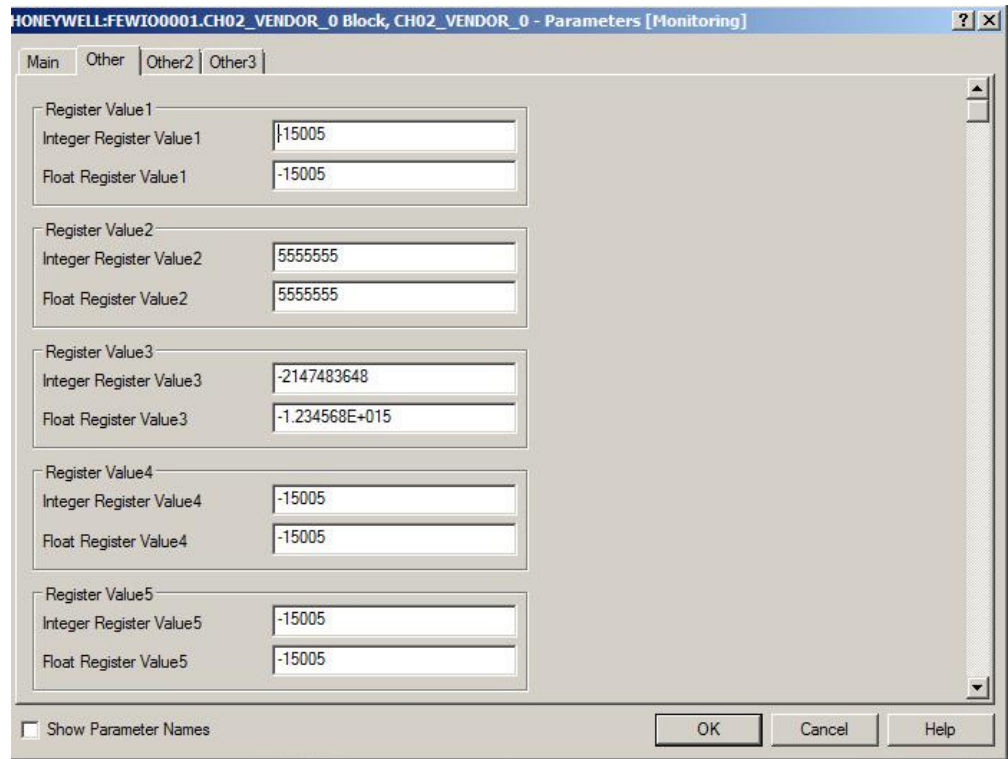
- The **CH02\_VENDOR\_0-Parameters [Monitoring]** window appears.



- Go to **Other** tab and view the configured parameters.



The values shown for each register is the value read from the respective slave device registers as configured in the register configuration.



# FDAP monitoring

## Overview about monitoring

The status and performance of FDAPs operating in a wireless network can be monitored using the following options.

- The Monitoring tab in the OneWireless user interface enables you to monitor FDAPs that are commissioned in the network.
- The Alarms & Event tab in the OneWireless user interface enables you to monitor events generated by the FDAPs.
- The Reports tab in the OneWireless user interface enables you to view and generate custom reports about connectivity and device health of the FDAPs in a network.

## Verify connectivity using maps

The OneWireless user interface enables you to create multiple locations and upload site map to the location. The devices can be positioned on the map to reflect the physical design and structure of a plant. The network topology map and connectivity can be visually inspected. You can navigate to the device in the topology map and check the link signal quality and connectivity. In addition, you can examine device communication statistics information like Receive Signal Quality Index (RSQI) and Receive Signal Strength Index (RSSI). This helps the Network Services Engineer to verify the wireless mesh connectivity and FDAP connectivity in the OneWireless user interface.

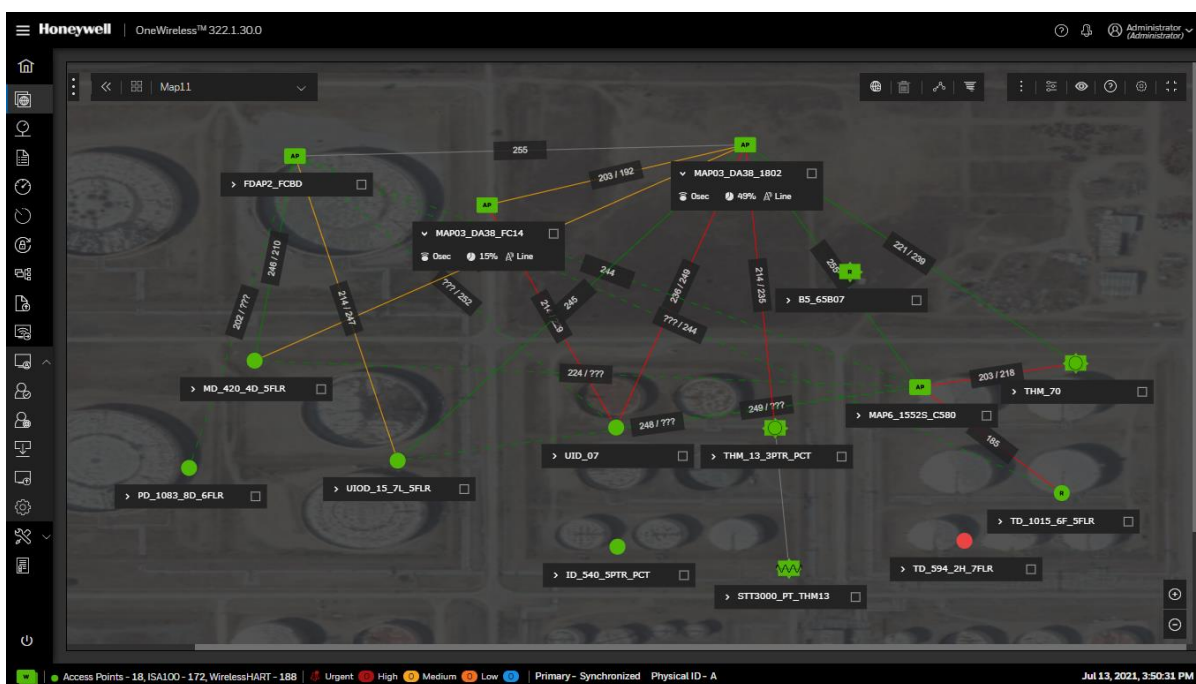


Fig. 29. Map view

---

For more information about setting up a monitoring area and for location-specific monitoring, see the *Wireless Device Manager User's Guide (OWDOC-X254-en)*.

## Monitor using Provisioning Handheld device

The FDAP is authenticated using a Provisioning Handheld device. Once the FDAP is authenticated, it joins the network. A Provisioning Handheld device can be used to monitor the status of the authenticated FDAP, and Provisioning Handheld device displays status as Discover, Secure, Joined, or Not Joined. You can read and set various FDAP parameters through the Provisioning Handheld device. If the FDAP is unable to join the network, you can read the FDAP parameter data through the Provisioning Handheld device and troubleshoot.

## Monitor using events

You can monitor system events generated by the FDAP. Events are generated when the FDAP joins the network, when the FDAP is Online, or when the FDAP is Offline or switched off. You can also export the event log created for a period. For more information about monitoring device using events, see the *Wireless Device Manager User's Guide (OWDOC-X254-en)*.

## Monitor using reports

You can generate and view various reports about connectivity, and device health of FDAPs in a network. You can generate and view the following reports:


- Battery Life
- Device Health Overview
- Device Summary
- Device History
- Connection Summary
- Connection History
- Inventory Summary

You can print the report and save the report in .csv format. For more information about reports, see the *Wireless Device Manager User's Guide (OWDOC-X254-en)*.

# FDAP maintenance and troubleshooting

## Replace an FDAP

You can replace a failed FDAP with a new device only if the new device specification is identical to the failed one. For more information about the procedure to replace an FDAP, see the *Wireless Device Manager User's Guide (OWDOC-X254-en)*.

 <b>ATTENTION</b>	<b>Any maintenance required is limited only to the external enclosure surface, cable connections, antennas, and the firmware. A failed unit must be returned to Honeywell for maintenance, repair, or replacement.</b>
-------------------------------------------------------------------------------------------------------	------------------------------------------------------------------------------------------------------------------------------------------------------------------------------------------------------------------------

## Remove an FDAP

You can remove a failed FDAP from the network. Once the FDAP is removed it is unable to join the network until it is assigned a new provisioning key. For more information about the procedure to remove an FDAP, see the *Wireless Device Manager User's Guide (OWDOC-X254-en)*.

## Firmware upgrade

FDAPs have only radio firmware and the radio firmware can be upgraded over-the-air. For more information about the procedure to upgrade a firmware for FDAP, see the *Wireless Device Manager User's Guide (OWDOC-X254-en)*.

## Troubleshooting

The FDAP does not have any user-serviceable parts inside the FDAP enclosure; any failure within the FDAP requires a hardware replacement. If a fault or failure is indicated or suspected in an FDAP in the network, there are many ways to diagnose a problem. You can diagnose a problem using the following methods:

- Events
- Reports
- System logs
- Provisioning Handheld device

## System logs

The system log contains events logged in the system. The system log information is helpful to System Administrators, Field Engineers, and Technical Support Personnel. You can generate and view the system log details. You can save the system log details in tar.gz format. For more information about system logs, see the *Wireless Device Manager User's Guide (OWDOC-X254-en)*.

---

## Recovering from failures

Failure indication may be signaled through the FDAP status LEDs. You can restart the FDAP if a failure is suspected. For more information about the procedure to restart the FDAP, see the *Wireless Device Manager User's Guide (OWDOC-X254-en)*.

# Appendix

## Technical Specifications

### FDAP Gen3

Attribute	Specification
Model Numbers	FDAP 32 (Class 1 Div 2 / Zone 2) FDAP 3P(Class1 Div 2/ Zone2)
Multiple Standards/Field Protocols	ISA100 Wireless, WirelessHART
Weight	2 kg (4.4 lbs.)
Dimensions	466 x 290 x 45 mm (18.34 x 11.41 x 1.77 in)
Power	24V DC, PoE Type -2 powered
External Ports and Connections	2 X external antenna ports for 2.4 GHz ISA100 Wireless and WirelessHART field instruments 1 X grounding cable
Internal Connections	1 X 10/100 Mbps auto-negotiation Ethernet port 1 X 3pin RS-485 port
Environmental Ratings	IP66, IP67, G3 corrosion resistance per ANSI/ISA-S71.04-1985
Operating Temperature	-40 to +70° C (IECEX) -40 to +70° C (ATEX) -40 to +70° C (CSA)
Operating Humidity	0~95% non-condensing
Transportation and Storage Humidity	0~95% non-condensing
Mechanical Shock	5G Operational, 15 G Non-Operational
Data Rates and Modulations	Radio: 250 Kbps, DSSS/O-QPSK Wired: 10 / 100 Mbps Fast Ethernet

Frequency Band and Operating Channels	Unlicensed ISM Band (2.4 – 2.483 GHz) 13 DSSS channels for ISA100 Wireless and/or Wireless HART BLE: 40 FHSS channels
Compliance	Radio Approvals (ISA100) FCC Part 15.247 Subparts B and C Canada – Industry Canada RSS247, Issue 2 RSS-Gen, Issue 5 ICES-003, Issue 6 European Union – ETSI EN 300 328 V2.2.2(2019-07) EN 301 489-17 V3.2.2 EN 301 489-1 V2.2.3 EN61326-1, 2021 Radio Approvals (Bluetooth (NINA-B1 module)) FCC/CFR 47part 15 unlicensed modular transmitter approval Canada - IC RSS European Union – ETSI RED CE Mark RED Directive 2014/53/EU EMC Directive 2004 / 108 / EC Hazardous Environment Ratings CSA: Class I, Division 2, Group A,B,C,D; T4 Nonincendive field wiring (NIFW) connection to external antenna
Security	128-bit AES encryption
Quality of Service	Supported
Transmit Power (Maximum)	18 dBm
Receive Sensitivity (Typical)	-100 dBm @ 250 kbps

Network Interface	10/100 Mbps Ethernet, auto-sensing
Number of Supported ISA100 Wireless and WirelessHART Field Instruments	<p><b>Access Point</b></p> <p>10 ISA100 Wireless or 8 WirelessHART Field Instruments at 0.5 second reporting rate</p> <p>25 ISA100 Wireless or 25 WirelessHART Field Instruments at 1 second reporting rate</p> <p>50 ISA100 Wireless or 50 WirelessHART Field Instruments at 2 seconds reporting rate</p> <p>80 ISA100 Wireless Field Instruments at 5 seconds or 80 WirelessHART Field Instruments at 4 seconds reporting rate</p> <p>100 ISA100 Wireless Field Instruments at 10 seconds or slower or 100 WirelessHART Field Instruments at 8 seconds or slower reporting rate</p> <p><b>Access Point as Router</b></p> <p>5 ISA100 Wireless and 4 WirelessHART Field Instruments at 0.5 second reporting rate</p> <p>12 ISA100 Wireless and 12 WirelessHART Field Instruments at 1 second reporting rate</p> <p>25 ISA100 Wireless and 25 WirelessHART Field Instruments at 2 seconds reporting rate</p> <p>40 ISA100 Wireless Field Instruments at 5 seconds or 50 WirelessHART Field Instruments at 4 seconds reporting rate</p> <p>50 ISA100 Wireless Field Instruments at 10 seconds or slower or 50 WirelessHART Field Instruments at 8 seconds or slower reporting rate</p>
Number of Supported Enraf FlexLine Radar Gauges / Wireless Field Interface (WFI)	40 Enraf FlexLine Radar Gauges / WFI
Maximum Number of Wireless Network Hops Between an	4 Hops 6 Hops for Wireless Tank Gauging applications



---

Access Point and a Field Device	
Warranty	1 Year
ECCN	5A002 ENC



## Federal Communications Commission (FCC) Statement

FDAP complies with Part 15 of the FCC Rules. Operation is subject to the following two conditions.

1. FDAP will not cause harmful interference.
2. FDAP must accept any interference received, including an interference that may cause undesired operation.

NOTE: This equipment has been tested and found to comply with the limits for a Class A digital device, pursuant to part 15 of the FCC Rules. These limits are designed to provide reasonable protection against harmful interference when the equipment is operated in a commercial environment. This equipment generates, uses, and can radiate radio frequency energy and, if not installed and used in accordance with the instruction manual, may cause harmful interference to radio communications. Operation of this equipment in a residential area is likely to cause harmful interference in which case the user will be required to correct the interference at his own expense.

### CAUTION:

- Any changes or modifications not expressly approved by the party responsible for compliance could avoid the user's authority to operate this equipment.

This equipment should be installed and operated with a minimum distance of 20 cm between the radiator and your body.

---

## Industry Canada (IC) Statement

Compliance Statements: This device complies with Industry Canada license-exempt RSS standard(s). Operation is subject to the following two conditions: 1) This device may not cause interference., 2) This device must accept any interference, including interference that may cause undesired operation of the device.

Déclarations de conformité: Le présent appareil est conforme aux CNR d'Industrie Canada applicables aux appareils radio exempts de licence. L'exploitation est autorisée aux deux conditions suivantes : (1) l'appareil ne doit pas produire de brouillage, et (2) l'utilisateur de l'appareil doit accepter tout brouillage radioélectrique subi, même si le brouillage est susceptible d'en compromettre le fonctionnement.

Caution Statements:

User Information General Information

- This equipment complies with radio frequency exposure limits set forth by Industry Canada for an uncontrolled environment.
- This equipment should be installed and operated with a minimum distance of 20 cm between the device and the user or bystanders.

Déclarations de mise en garde:

- Cet équipement est conforme aux limites d'exposition aux radiofréquences définies par Industrie Canada pour un environnement non contrôlé.
- Cet équipement doit être installé et utilisé avec un minimum de 20 cm de distance entre le dispositif et l'utilisateur ou des tiers.

Tant que 2 conditions ci-dessus sont remplies, un autre test d'émetteur ne sera pas nécessaire. Toutefois, l'intégrateur OEM est toujours responsable de tester leur produit final pour toutes les exigences de conformité supplémentaires requises avec ce module installé.

## FDAP Gen3 Anchor

Attribute	Specification
Model Numbers	FDAP32/3P (Class 1 Div 2 / Zone 2)
Multiple Standards/Field Protocols	ISA100 Wireless (IEC 62734) WirelessHART (IEC 62591) BLE (v5.1)
Weight	2 kg (4.4 lbs.)
Dimensions	466 x 290 x 45 mm (18.34 x 11.41 x 1.77 in)
Power consumption	2.5 Watts@24VDC PoE: 3W
External Ports and Connections	2 X external antenna ports for 2.4 GHz ISA100 Wireless field instruments, WirelessHART field instruments and RTLS 1 X grounding cable
Internal Connections	1 X 10/100 Mbps auto-negotiation Ethernet port 1 X 3pin RS-485 port
Environmental Ratings	IP66, IP67, G3 corrosion resistance per ANSI/ISA-S71.04-1985
Operating Temperature	-40 to +70° C (IECEX, ATEX, CSA)
Operating Humidity	0~95% non-condensing
Transportation and Storage Humidity	0~95% non-condensing
Mechanical Shock	5G Operational, 15 G Non-Operational
Data Rates and Modulations	Radio (ISA100): 250 Kbps, DSSS/O-QPSK Radio (RTLS): FHSS channel. Radio (BLE): 1Mbps, FHSS/FSK Wired: 10 / 100 Mbps Fast Ethernet
Frequency Band and Operating Channels	Unlicensed ISM Band (2.4 – 2.483 GHz) 13 DSSS channels for ISA100 Wireless and/or WirelessHART 40 FHSS Channels for RTLS 1 DSSS channel for RTLS

Compliance	<p><b>Radio Approvals (ISA100/WirelessHART/RTLS)</b></p> <ul style="list-style-type: none"> <li>• FCC Part 15.247 Subparts B and C</li> <li>• Canada – Industry Canada             <ul style="list-style-type: none"> <li>○ RSS247, Issue 2</li> <li>○ RSS-Gen, Issue 5</li> <li>○ ICES-003, Issue 6</li> </ul> </li> <li>• European Union – ETSI             <ul style="list-style-type: none"> <li>○ EN 300 328 V2.2.2(2019-07)</li> <li>○ EN 301 489-17 V3.2.2</li> <li>○ EN 301 489-1 V2.2.3</li> <li>○ IEC61326-1, 2013</li> </ul> </li> </ul> <p><b>Radio Approvals (Bluetooth)</b></p> <ul style="list-style-type: none"> <li>• FCC/CFR 47part 15 Subparts B and C</li> <li>• Canada - IC RSS</li> <li>• European Union – ETSI RED</li> </ul> <p><b>CE Mark</b></p> <ul style="list-style-type: none"> <li>• RED Directive 2014/53/EU</li> <li>• EMC Directive 2004 / 108 / EC</li> </ul> <p><b>Hazardous Environment Ratings</b></p> <ul style="list-style-type: none"> <li>• CSA: Class I, Division 2, Group A, B, C, D; T4</li> <li>• Non incendive field wiring (NIFW) connection to external antenna</li> </ul>
Security	128-bit AES encryption
Transmit Power (Maximum at Antenna Port)	17 dBm
Range	FDAP32R to FDAP32R: 500 meters (Instrumentation) FDAP32R to FDAP32R: 150 meters (RTLS)
Receive Sensitivity (Typical)	-95 dBm @ 250 kbps

---

Network Interface	10/100 Mbps Ethernet, auto-sensing
Maximum Number of Wireless Network Hops Between an Access Point and a Field Device/RTLS Tag	6 Hops
Warranty	1 Year

## FDAP2

Attribute	Specification
Model Numbers	FDAP1 (Class 1 Div 1/Zone 0) FDAP2 (Class 1 Div 2/Zone 2)
Multiple Standards/Field Protocols	ISA100 Wireless and WirelessHART
Weight	3.86 kg (5.5 lbs)
Dimensions	216 x 170 x 86 mm (8.47 x 6.73 x 3.37 in)
Power	24 VDC +/- 10% at 2 Watts 90 – 264 VAC, 50/60 Hz
External Ports and Connections	2 X external antenna ports for 2.4 GHz ISA100 Wireless field instruments
Internal Connections	1 X 10/100 Mbps auto negotiation Ethernet port 1 X shielded power cable 1 X grounding cable
Environmental Ratings	IP66, G3 Corrosion resistance per ANSI/ISA-S71.04-1985, NEMA Type 4X (FM only)
Operating Temperature	FDAP1: -40 to +70 °C FDAP2: -40 to +60 °C
Transportation and Storage Temperature	-40 to +85 °C
Operating Humidity	0~100% non-condensing
Transportation and Storage Humidity	0~100% non-condensing
Mechanical Shock	4G
Data Rates and Modulations	Radio: 250 Kbps, DSSS/ O-QPSK Wire: 10/100 Mbps Fast Ethernet
Frequency Band and Operating Channels	Unlicensed ISM Band (2.4 – 2.483 GHz) 15 DSSS channels for ISA100 Wireless

Compliance	<p>Radio Approvals</p> <p>FCC Part 15.247 Subparts B and C Canada – Industry Canada Australia – ACMA</p> <p>AS NZS 4771-2000 Method</p> <p>RSS-247, Issue 2 &amp; RSS-Gen, Issue 5</p> <p>ICES-003, Issue 4</p> <p>European Union – ETSI EN 300 328 V1.7.1</p> <p>EN 301 893 V1.4.1</p> <p>EN 301 489-17 V1.2.1</p> <p>EN 301 489-1 V1.6.1</p> <p>IEC61326-1, 2005</p> <p>CE Mark</p> <p>R&amp;TTE Directive 1999/5/EC EMC Directive 2004/108/EC LVD Directive 73/23/EEC ATEX Directive 94/9/EC Hazardous Environment Ratings FDAP1 Model:</p> <p>IECEX: Ex ia IIB T4</p> <p>FM: Class I, Division 1 Group C, D / Zone 0 Group IIB T4 FDAP2 Model:</p> <p>FM: Class I, Division 2 Group A, B, C, D / Zone 2 Group IIC T4</p>
Security	128-bit AES encryption
Quality of Service	Supported
Transmit Power (maximum)	DSSS: 18 dBm
Receive Sensitivity (Typical)	DSSS (2.4 GHz): -95 dBm @ 250 kbps
Network Interface	10/100 Mbps Ethernet, autosensing
Number of Supported ISA100 Wireless and WirelessHART Field Instruments	<p><b>Access Point</b></p> <p>10 ISA100 Wireless or 8 WirelessHART Field Instruments at 0.5 second reporting rate</p> <p>25 ISA100 Wireless or 25 WirelessHART Field Instruments at 1 second reporting rate</p> <p>50 ISA100 Wireless or 50 WirelessHART Field Instruments at 2 seconds reporting rate</p> <p>80 ISA100 Wireless Field Instruments at 5 seconds or 80 WirelessHART Field Instruments at 4 seconds reporting rate</p>



	<p>100 ISA100 Wireless Field Instruments at 10 seconds or slower or 100 WirelessHART Field Instruments at 8 seconds or slower reporting rate</p> <p><b>Access Point as Router</b></p> <p>5 ISA100 Wireless and 4 WirelessHART Field Instruments at 0.5 second reporting rate          12 ISA100 Wireless and 12 WirelessHART Field Instruments at 1 second reporting rate          25 ISA100 Wireless and 25 WirelessHART Field Instruments at 2 seconds reporting rate          40 ISA100 Wireless Field Instruments at 5 seconds or 50 WirelessHART Field Instruments at 4 seconds reporting rate          50 ISA100 Wireless Field Instruments at 10 seconds or slower or 50 WirelessHART Field Instruments at 8 seconds or slower reporting rate</p>
Number of Supported Enraf FlexLine Radar Gauges	<p>FDAP as an access point (connected to a high speed backbone1):          13 Enraf FlexLine Radar Gauges</p> <p>FDAP as a router (routing data to another field device):          10 Honeywell Enraf FlexLine Radar Gauges with 1 second publication rate with input only channels          5 devices with 1 second publication rate with both input and output channels</p>
Number of Supported SKF WVT Field Devices	<p>FDAP as an access point (connected to a high speed backbone1):          15 Wireless Vibration Transmitter (WVT) Field Devices</p> <p>FDAP as a router (routing data to another field device):          Number of Wireless Vibration Transmitter (WVT) Field Devices under FDAP as a router is 8</p>
Maximum Number of Wireless Network Hops Between an Access Point and a Field Device	4 hops
Warranty	1 year
ECCN	5A002 ENC

## Dimension Drawing

### FDAP Gen3 and FDAP Gen3 Anchor

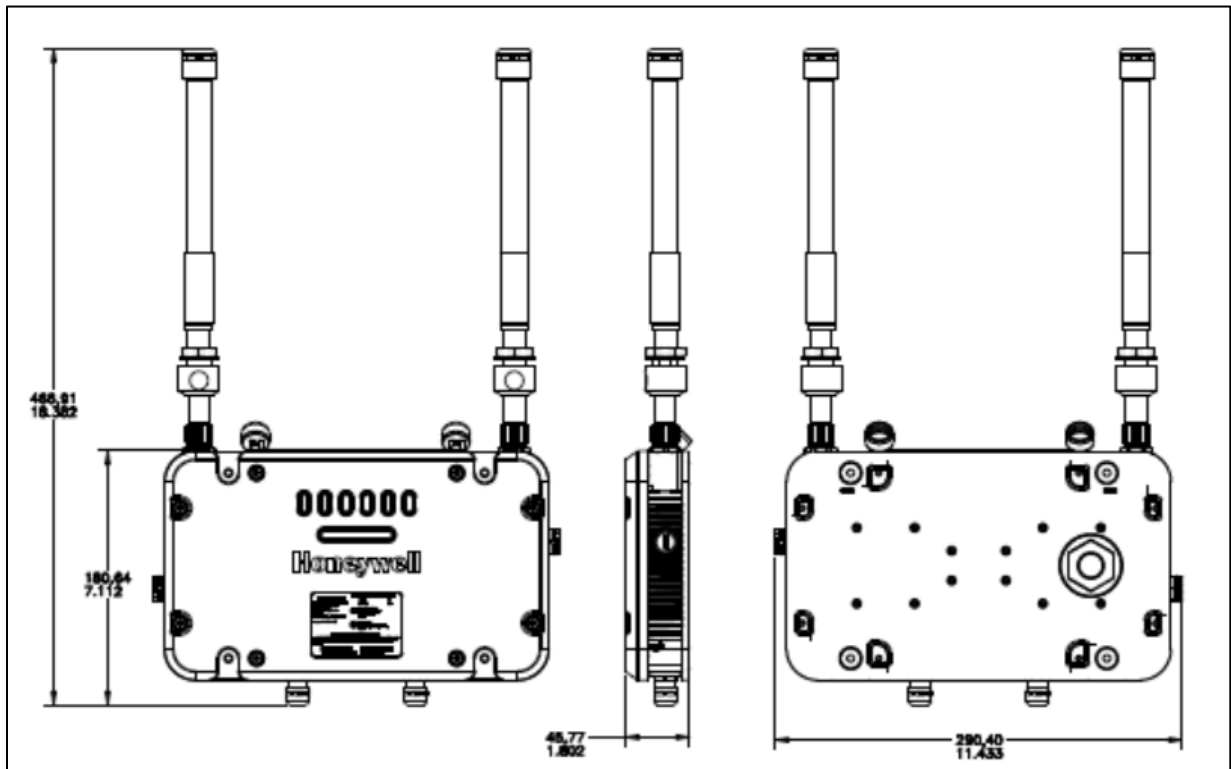


Fig. 30. FDAP Gen3 and FDAP Gen3 Anchor WITH LIGHTNING SURGE ARRESTOR

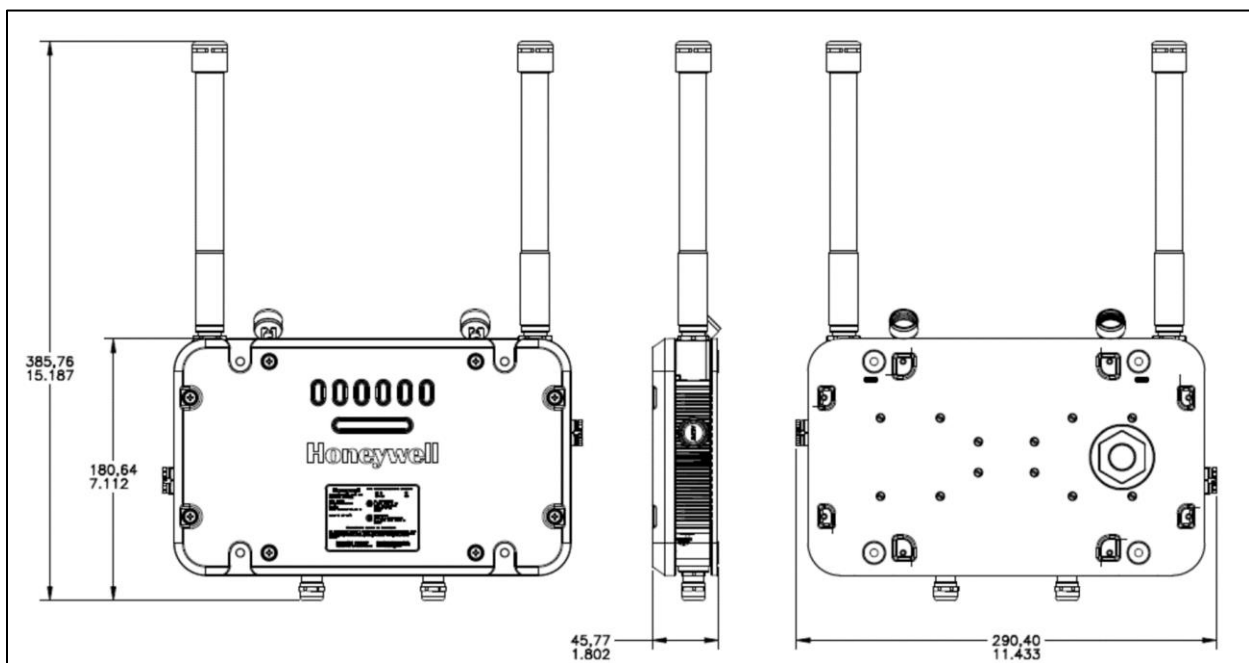


Fig. 31. FDAP Gen3 and FDAP Gen3 Anchor WITHOUT LIGHTNING SURGE ARRESTOR

FDAP2

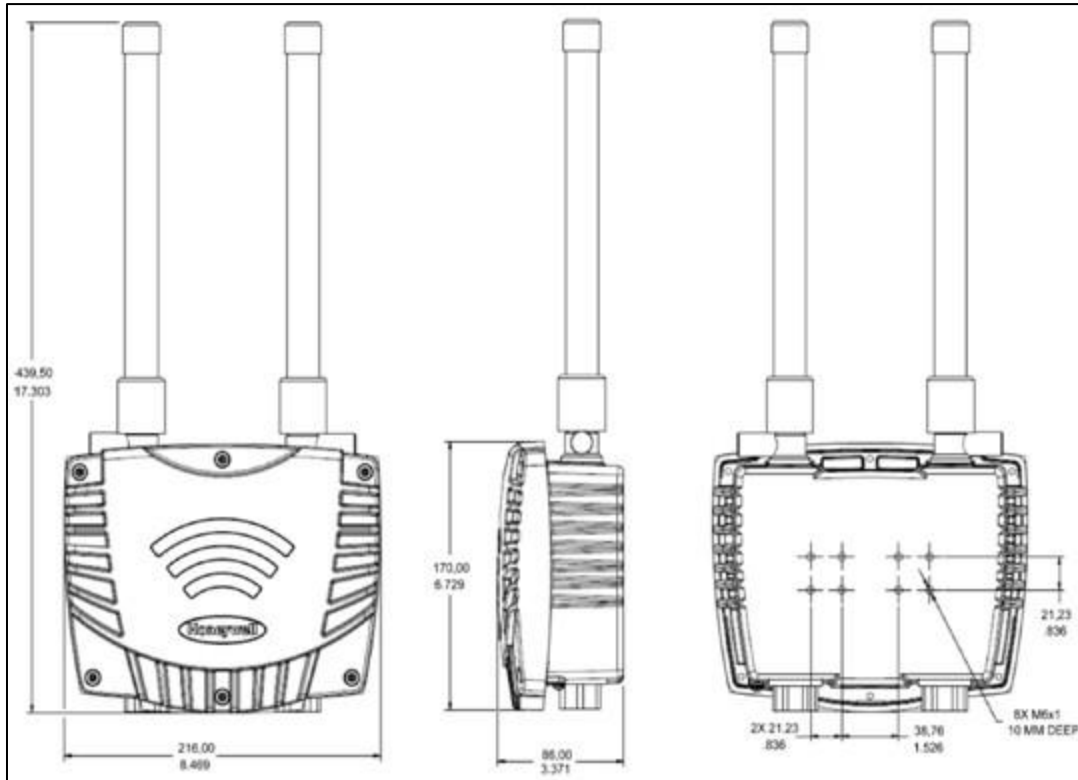


Fig. 32. FDAP2

# IS Control Drawing

## FDAP Gen3 and FDAP Gen3 Anchor

COPYRIGHT 2017, HONEYWELL INTERNATIONAL INC. NEITHER THIS DOCUMENT NOR THE INFORMATION CONTAINED HEREIN SHALL BE REPRODUCED, USED OR DISCLOSED TO OTHERS WITHOUT THE WRITTEN AUTHORIZATION OF HONEYWELL. USE, DUPLICATION, OR DISCLOSURE OF THIS DOCUMENT IS SUBJECT TO THE RESTRICTIONS SET FORTH IN A WRITTEN AGREEMENT. NOTHING CONTAINED HEREIN SHALL BE CONSTRUED AS CONFERRING BY IMPLICATION, ESTOPPEL, OR OTHERWISE ANY LICENSE TO ANY PATENT, TRADEMARK, COPYRIGHT OR OTHER INTELLECTUAL PROPERTY RIGHT OF HONEYWELL OR ANY THIRD PARTY.

PRE REL							
ISS	REVISION & DATE		APPD				
A2	23 Mar 2021 ECN 2020-XXXX		SB				

### FDAP32/FDAP3P Div2 INSTALLATION CONTROL DRAWING

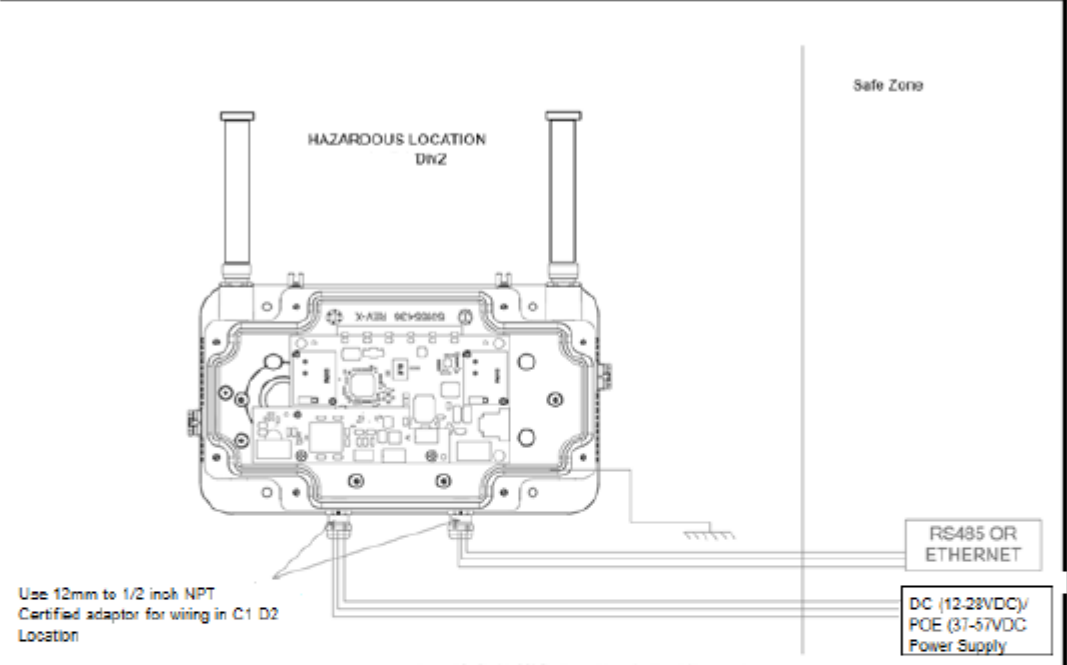
#### General Guidelines

- The FDAP32 shall follow field wiring guideline as per NEC/CEC guidelines. (Section 18 (CEC) , Article 500(NEC) )
- For Installation in Div2 location 12mm to ½ inch NPT Adaptor shall be used to satisfy Conduit connection requirement.
- Other than the wiring connections identified within this drawing, all other wiring connections must be accomplished with Division 2 wiring practices.
- WARNING: SUBSTITUTION OF COMPONENTS MAY IMPAIR SUITABILITY FOR USE IN HAZARDOUS LOCATIONS.  
AVERTISSEMENT : LA SUBSTITUTION DE COMPOSANTS PEUT NUIRE L'APTITUDE À L'UTILISATION DANS DES ENDROITS DANGEREUX
- WARNING: Explosion Hazard, when energized do not open, connect, or disconnect power/other signal line.  
AVERTISSEMENT: Risque d'explosion, lorsqu'il est sous tension, ne pas ouvrir, connecter ou déconnecter l'alimentation / toute autre ligne de signal

*Note: NO REVISION OF THIS CONTROL DRAWING IS PERMITTED WITHOUT AUTHORIZATION FROM THE AGENCIES LISTED.*

MASTER FILE TYPE: MS WORD	DRAWN			Honeywell		
	CHECKED					
	DEV ENG			ONEWIRELESS FDAP3X / PCAP3X CONTROL DRAWING		
	MFG ENG					
	QA ENG					
	TOLERANCE UNLESS NOTED			A A4	50165525	
ANGULAR DIMENSION						
			SCALE: None	USED ON	SH. 1 OF 5	

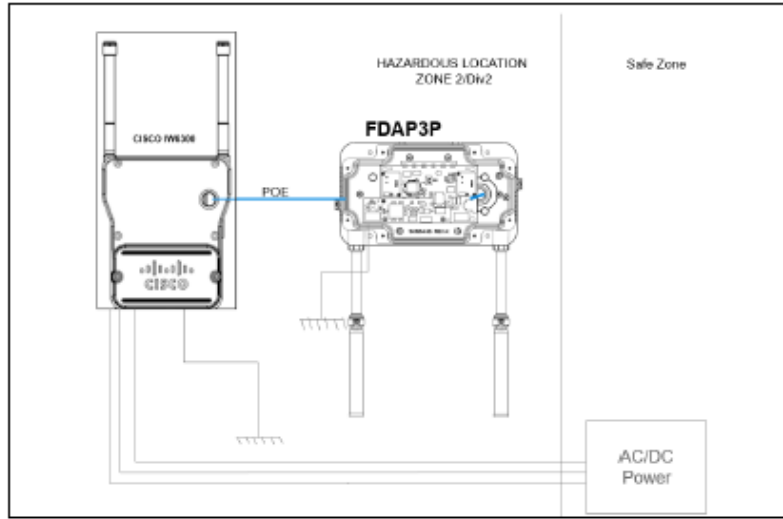
**FDAP32 - INSTALLATION DIAGRAM**



- Notes:**
- 1) Wiring to or from these devices, which enters or leaves the system enclosure, must utilize wiring methods suitable for Class I, Division 2 (and Class I, Zone 2) Hazardous Locations, or as appropriate for the installation.
  - 2) Gland or the Conduit adaptor must be configured with minimum IP66/Type 4X minimum rated cable glands at the time of final installation
  - 3) Refer Annexure A for Torque details to Mount Top Cover Assembly with Base Assembly.

<b>Honeywell</b>	<b>A/A4</b>	<b>50165525</b>		
SCALE: None	REV A2	DATE 032321	SH. 2 of 4	

**FDAP3P - INSTALLATION DIAGRAM**



**Notes:**

- 1) Wiring to or from these devices, which enters or leaves the system enclosure, must utilize wiring methods suitable for Class I, Division 2 (and Class I, Zone 2) Hazardous Locations, or as appropriate for the installation.
- 2) Wiring and connection to CISCO Model IW6300 shall be as per the user/Installation Manual of IW6300.
- 3) Refer Annexure A for Toque details to Mount Base assembly with CISCO IW6300.

Honeywell

A/A4

50165525

SCALE: None

REV A2

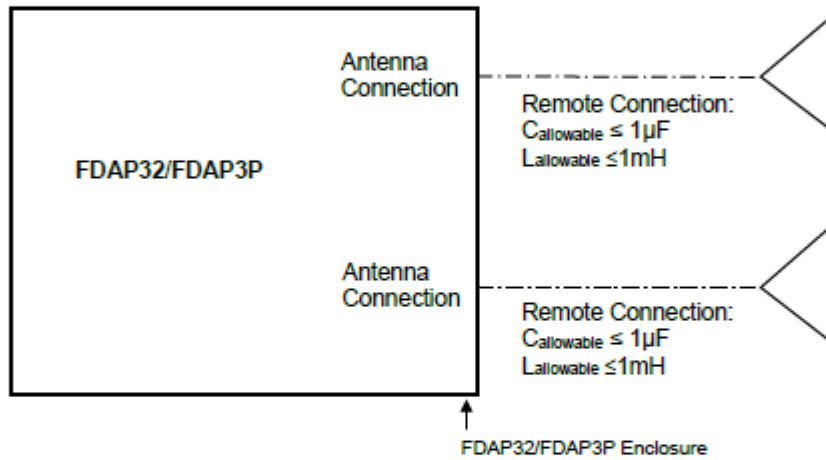
DATE 032321

SH. 3 of 4

**Div2 nonincendive Field Wiring  
REMOTE ANTENNA INSTALLATION CONTROL DRAWING**

HAZARDOUS (POTENTIALLY EXPLOSIVE ATMOSPHERE) LOCATION

**MODEL: FDAP32/FDAP3P**

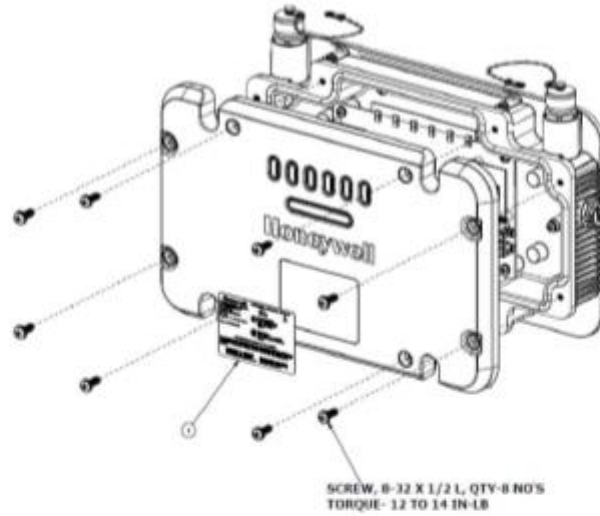


**Notes:**  
Refer FDAP Gen3 Div 2 Certificate for conditions of acceptability for External Antenna Installation.

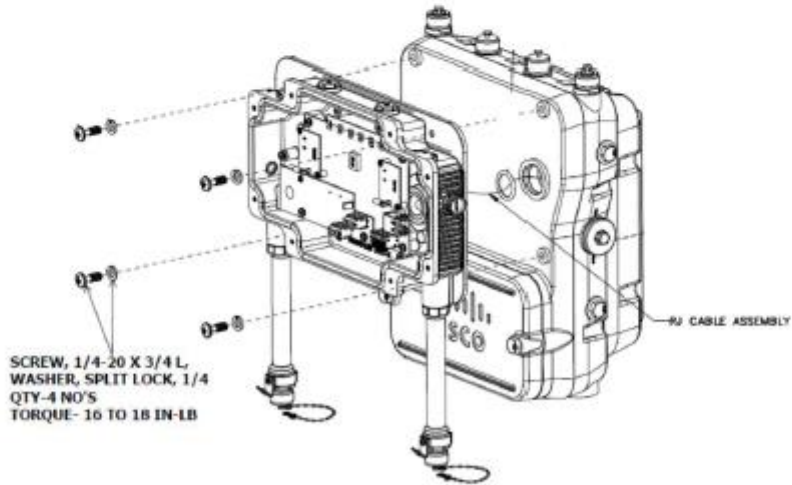
<b>Honeywell</b>	<b>A/A4</b>	<b>50165525</b>		
	SCALE: None	REV A2	DATE 032321	SH. 4 of 4

## ANNEXURE A

1) TOP COVER ASSEMBLY FOR MODEL NUMBER - FDAP32 AND FDAP3P



2) BASE ASSEMBLY WITH CISCO IW6300 FOR MODEL NUMBER - FDAP3P



<b>Honeywell</b>	<b>A/A4</b>	<b>50165525</b>		
SCALE: None	REV A2	DATE 032321	SH. 5 of 4	



FDAP2 (51202683)

COPYRIGHT 2014, HONEYWELL INTERNATIONAL INC. NEITHER THIS DOCUMENT NOR THE INFORMATION CONTAINED HEREIN SHALL BE REPRODUCED, USED OR DISCLOSED TO OTHERS WITHOUT THE WRITTEN AUTHORIZATION OF HONEYWELL. USE, DUPLICATION, OR DISCLOSURE OF THIS DOCUMENT IS SUBJECT TO THE RESTRICTIONS SET FORTH IN A WRITTEN AGREEMENT. NOTHING CONTAINED HEREIN SHALL BE CONSTRUED AS CONFERRING BY IMPLICATION, ESTOPPEL, OR OTHERWISE ANY LICENSE TO ANY PATENT, TRADEMARK, COPYRIGHT OR OTHER INTELLECTUAL PROPERTY RIGHT OF HONEYWELL OR ANY THIRD PARTY.		PRE REL			
		ISS	REVISION & DATE		APPD
		B	6/27/2014		AT

## OneWireless FDAP

### IECEX & FM APPROVED INTRINSICALLY SAFE

### INSTALLATION CONTROL DRAWING

1. Intrinsically safe installation shall be in accordance with
  - a. FM (USA): ANSI/NFPA 70, NEC Articles 504 and 505.
  - b. IECEX: Requirements of IEC 60079-14, 12.3 [See also 5.2.4].
2. ENTITY approved equipment shall be installed in accordance with the manufacturer's Intrinsic Safety Control Drawing.
3. The Intrinsic Safety ENTITY concept allows the interconnection of two ENTITY Approved intrinsically safe devices with ENTITY parameters not specifically examined in combination as a system when:
 

$U_o, V_o, (or V_t \text{ in the USA}) \leq U_i \text{ or } V_{max}; I_o, I_{sc}, (or I_t \text{ in the USA}) \leq I_i \text{ or } I_{max}; C_a \text{ or } C_o \geq C_i + C_{cable}; L_a \text{ or } L_o \geq L_i + L_{cable}; P_o \leq P_i$ . Where two separate barrier channels are required, one dual-channel or two single-channel barriers may be used, where in either case, both channels have been Certified for use together with combined entity parameters that meet the above equations.
4. System Entity Parameters:
 

FDAP1:  $V_{max} \geq V_o \text{ or } U_o, I_{max} \geq I_{sc} \text{ or } I_o; P_i \geq P_o$ .  
 FDAP1:  $C_i + C_{cable} \leq \text{Control Apparatus } C_a$ .  
 FDAP1:  $L_i + L_{cable} \leq \text{Control Apparatus } L_a$ .
5. When the electrical parameters of the cable are unknown, the following values may be used:
 

Capacitance: 197pF/m (60 pF/ft)  
 Inductance: 0.66µH/m (0.020µH/ft).
6. Control equipment that is connected to Associated Equipment must not use or generate more than 250 V.
7. Associated equipment must be FM or IECEX (depending on location) listed. Associated equipment may be installed in a Class I, Division 2 or Zone 2 Hazardous (Classified) location if so approved.
8. Non-Galvanically isolated equipment (grounded Zener Barriers) must be connected to a suitable ground electrode per:
  - a. FM (USA): NFPA 70, Article 504 and 505. The resistance of the ground path must be less than 1.0 ohm.
  - b. IECEX: Requirements of IEC 60079-14, 12.2.4.
9. Intrinsically Safe DIVISION 1/ Zone 0 WARNING: SUBSTITUTION OF COMPONENTS MAY IMPAIR SUITABILITY FOR USE IN HAZARDOUS LOCATIONS.
10. Division 2/ Zone 2: WARNING: DO NOT OPEN WHEN AN EXPLOSIVE GAS ATMOSPHERE IS PRESENT.
11. NO REVISION OF THIS CONTROL DRAWING IS PERMITTED WITHOUT AUTHORIZATION FROM THE AGENCIES listed.

MASTER FILE TYPE: MS WORD	DRAWN			Honeywell		
	CHECKED			FM & IECEX CONTROL DRAWING ONEWIRELESS FDAP DIVISIONS 1 / ZONE 0		
	DEV ENG					
	MFG ENG					
	QA ENG					
	TOLERANCE UNLESS NOTED			A/A4	51202683	
ANGULAR DIMENSION			SCALE: None	USED ON	SH. 1 OF 2	

**IECEX & FM APPROVED INTRINSICALLY SAFE  
INSTALLATION CONTROL DRAWING**

**MODEL: FDAPI**

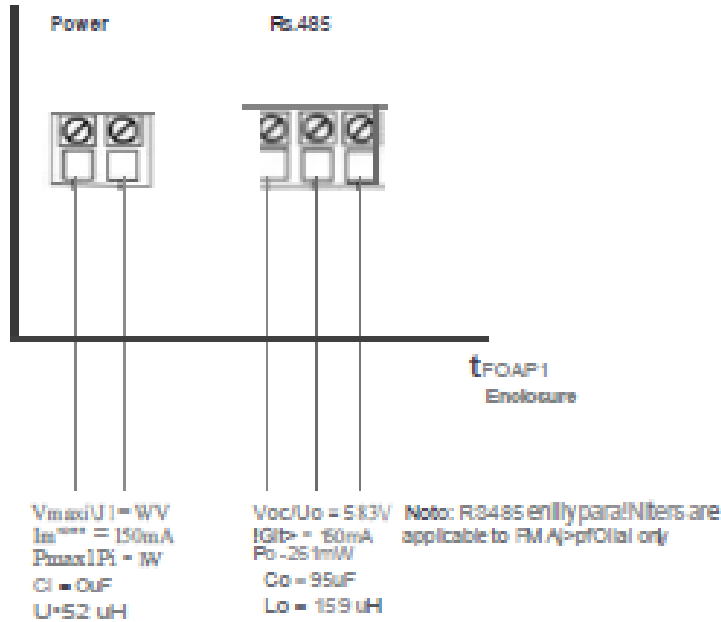
**HAZARDOUS CLASSIFICATION**

FM: CLASS DIV 1 GROUPS CDT4:

CLASS I, ZONE DE I (I A Ex) GROUP 1 BT4:

AMBIENT LIMITS: 40°C Stb 575°C

IECEX: FM BT4, AMBIENT LIMITS: 40°C Stb 570°C



Note: Ethernet connections are not allowed in intrinsic safety installations

**Honeywell**

4

**51202683**




SCALE: None | REV B | DATE 6/27/14 | 8/2 of 2

# Label Drawing

## FDAP Gen3

The labels shown are for reference purposes only.

**Honeywell**      FIELD DEVICE ACCESS POINT GEN3

Fort Washington, PA 19034, USA             

ASSEMBLED IN MEXICO

Model: FDAP31


Part No.: 51156751-003

Ser. No.:

Input: 12V - 28VDC, 1W

Temp.: -40 °C TO +70 °C

IP66/67






Ex ia, Cl. I, Div.1 Gp.CD;T4  
Cl. I, Zn O, Ex ia IIB; T4 Ga  
US TYPE 4

CSA: Installation per Dwg 50165525

This device complies with Part 15 of FCC Rules and Regulations. Operation is subject to the following conditions: (1) This device may not cause harmful interference and (2) This Device must accept any interference received, including interference that may cause undesired operation.

FCC ID : S5751307990	IC: 573W-51307990
Contains FCC ID : XPNINAB1	Contains IC: 8585A-NINAB1 Model NINA-B1
Ethernet MAC: 00-40-84-xx-xx-xx-xx	BLE MAC: xx-xx-xx-xx-xx-xx

**Honeywell**      FIELD DEVICE ACCESS POINT GEN3

Fort Washington, PA 19034, USA             

ASSEMBLED IN MEXICO

Model: FDAP32

Part No.: 51156751-002


Ser. No.:

Input: 12V - 28VDC, 2.4W

POE 37V - 57VDC, 2.5W

Temp.: -40 °C TO +70 °C

IP66/67



Cl. I, Div. 2 Gp. ABCD; T4  
Nonincendive Field Wiring (NFW)  
connection to external antenna  
as per the installation drawing.  
US TYPE 4

CSA: Installation per Dwg 50165525

This device complies with Part 15 of FCC Rules and Regulations. Operation is subject to the following conditions: (1) This device may not cause harmful interference and (2) This Device must accept any interference received, including interference that may cause undesired operation.

FCC ID : S5751307990	IC: 573W-51307990
Contains FCC ID : XPNINAB1	Contains IC: 8585A-NINAB1 Model NINA-B1
Ethernet MAC: 00-40-84-xx-xx-xx-xx	BLE MAC: xx-xx-xx-xx-xx-xx



**FDAP3x with 1 Anchor Radio and GXRm Radio**


**FDAP31 Gen3 Anchor**

**Honeywell** FIELD DEVICE ACCES POINT GEN3, ANCHOR

Fort Washington, PA 19034, USA  
 ASSEMBLED IN MEXICO  
 Model: FDAP31  
 Part No.: 51156751-006  
 Ser. No.:  
 Input: 12V - 28VDC, 10W

Temp.: -40 °C TO +70 °C  
 IP66/67

 Ex ia, Cl I, Div.1 Gp.CD;T4  
 Cl. I, Zn 0, Ex ia IIB; T4 Ga  
 US TYPE 4

Installation per Dwg 50165525

This device complies with Part 15 of FCC Rules and Regulations. Operation is subject to the following conditions: (1) This device may not cause harmful interference and (2) This Device must accept any interference received, including interference that may cause undesired operation.

FCC ID : S5751308987  
 Contains FCC ID : XPYNINAB1  
 Ethernet MAC: 00-40-84-xx-xx-xx-xx



IC: 573W-51308987  
 Contains IC: 8595A-NINAB1 Model NINA-B1  
 BLE MAC: xx-xx-xx-xx-xx-xx


**FDAP32 Gen3 Anchor**


**Honeywell** FIELD DEVICE ACCES POINT GEN3, ANCHOR

Fort Washington, PA 19034, USA  
 ASSEMBLED IN MEXICO  
 Model: FDAP32  
 Part No.: 51156751-006  
 Ser. No.:  
 Input: 12 - 28VDC , 3.05W  
 POE 37 - 57VDC 3.24W

Temp.: -40 °C TO +70 °C  
 IP66/67

 CSANe 21ATEX3127X  
 IIG Ex ec [ic] IIC T4 Gc  
 IECEX CSA 210025X  
 Ex ec [ic] IIC T4 Gc

 Cl. I, Div. 2 Gp. ABCD; T4  
 Nonincendive Field Wiring (NFW)  
 connection to external antenna  
 as per the installation drawing.  
 US TYPE 4

Installation per Dwg 50165525

This device complies with Part 15 of FCC Rules and Regulations. Operation is subject to the following conditions: (1) This device may not cause harmful interference and (2) This Device must accept any interference received, including interference that may cause undesired operation.

FCC ID : S5751308987  
 Contains FCC ID : XPYNINAB1  
 Ethernet MAC: 00-40-84-xx-xx-xx-xx

IC: 573W-51308987  
 Contains IC: 8595A-NINAB1 Model NINA-B1  
 BLE MAC: xx-xx-xx-xx-xx-xx

**FDAP3P Gen3 Anchor**

**Honeywell** FIELD DEVICE ACCESS POINT GEN3 PLUS, ANCHOR

Fort Washington, PA 19034, USA

ASSEMBLED IN MEXICO

Model: FDAP3P



Part No.: 51156751-004


Ser. No.:


Input: POE 37 - 57VDC 3.24W

Temp.: -40 °C TO +70 °C

IP66/67

 CSANe 21ATEX3127X  
IIIG Ex ec [ic] IIC T4 Gc  
IECEX CSA 21.0025X  
Ex ec [ic] IIC T4 Gc

 Cl. I, Div. 2 Gp. ABCD; T4  
Nonincendive Field Wiring (NIFW)  
connection to external antenna  
as per the installation drawing.

C US TYPE 4

Installation per Dwg 50165525

This device complies with Part 15 of FCC Rules and Regulations. Operation is subject to the following conditions: (1) This device may not cause harmful interference and (2) This Device must accept any interference received, including interference that may cause undesired operation.

FCC ID : S5751308987      IC: 573W-51308987  
Contains FCC ID : XPYNINAB1      Contains IC: 8595A-NINAB1 Model NINA-B1  
Ethernet MAC: 00-40-84-xx-xx-xx-xx      BLE MAC: xx-xx-xx-xx-xx-xx

**FDAP Gen3 with 2 Anchor Radios**


**FDAP31 Anchor2**

**Honeywell**      FIELD DEVICE ACCESS POINT GEN3 ANCHOR2

CE Ⓛ

Fort Washington, PA 19034, USA  
 ASSEMBLED IN MEXICO  
 Model: FDAP31  
 Part No.: 51156751-009  
 Ser. No.:  
 Input: 12V - 28VDC, 1.0W

Temp.: -40 °C TO +70 °C  
 IP66/67  
 MFD.: MM/YYYY

 Ex ia, Cl I, Div.1 Gp.CD:T4  
 Cl I, Zn 0, Ex ia IIB; T4 Gc  
 US TYPE 4

Installation per Dwg 50185525

This device complies with Part 15 of FCC Rules and Regulations. Operation is subject to the following conditions: (1) This device may not cause harmful interference and (2) This Device must accept any interference received, including interference that may cause undesired operation.

FCC ID : S5751460094	IC: 573W-51460094
Contains FCC ID : XPYNINAB1	Contains IC: 8595A-NINAB1 Model NINA-B1
Ethernet MAC: 00-40-84-xx-xx-xx-xx	BLE MAC: xx-xx-xx-xx-xx-xx


**FDAP32 Anchor2**


**Honeywell**      FIELD DEVICE ACCESS POINT GEN3 ANCHOR2

CE Ⓛ

Fort Washington, PA 19034, USA  
 ASSEMBLED IN MEXICO  
 Model: FDAP32  
 Part No.: 51156751-008  
 Ser. No.:  
 Input: 12V - 28VDC, 2.4W  
           POE 37V - 57VDC, 2.5W

Temp.: -40 °C TO +70 °C  
 IP66/67  
 MFD.: MM/YYYY

 CSANe 2IATEX3127X  
 I3G Ex ec [ic] IIC T4 Gc  
 ECEX CSA 210025X  
 Ex ec [ic] IIC T4 Gc

 Cl I, Div. 2 Gp. ABCD; T4  
 Nonincendive Field Wiring (NIFW)  
 connection to external antenna  
 as per the installation drawing.  
 US TYPE 4

Installation per Dwg 50185525

This device complies with Part 15 of FCC Rules and Regulations. Operation is subject to the following conditions: (1) This device may not cause harmful interference and (2) This Device must accept any interference received, including interference that may cause undesired operation.

FCC ID : S5751460094	IC: 573W-51460094
Contains FCC ID : XPYNINAB1	Contains IC: 8595A-NINAB1 Model NINA-B1
Ethernet MAC: 00-40-84-xx-xx-xx-xx	BLE MAC: xx-xx-xx-xx-xx-xx

FDAP3P Anchor2

**Honeywell** FIELD DEVICE ACCESS POINT GEN3 PLUS ANCHOR2

Fort Washington, PA 19034, USA

ASSEMBLED IN MEXICO

Model: FDAP3P

Part No.: 51156751-007


Ser. No.:


Input: POE 37V - 57VDC, 2.51W


Temp.: -40 °C TO +70 °C

IP66/67

MFD: MM/YYYY







CSANe 2IATEX3127X  
E3G Ex ec [ic] IIC T4 Gc  
IECEX CSA 210025X  
Ex ec [ic] IIC T4 Gc

Cl. I, Div. 2 Gp. ABCD; T4  
Nonincendive Field Wiring (NIFW)  
connection to external antenna  
as per the installation drawing.

US TYPE 4

Installation per Dwg 50165525




This device complies with Part 15 of FCC Rules and Regulations. Operation is subject to the following conditions: (1) This device may not cause harmful interference and (2) This Device must accept any interference received, including interference that may cause undesired operation.

FCC ID : S5751460094  
Contains FCC ID : XPYNINAB1  
Ethernet MAC: 00-40-84-xx-xx-xx-xx

IC: 573W-51460094  
Contains IC: 8595A-NINAB1 Model NINA-B1  
BLE MAC: xx-xx-xx-xx-xx-xx

FDAP2

The labels shown are for reference purposes only.

<p><b>Honeywell</b>                  Phoenix, AZ 85029, USA                  ASSEMBLED IN MEXICO</p> <p>Model: FDAP1                  Part No.: 51198665-100REV                  Ser. No.:                  Power: 18 - 30VDC, 2W</p> <p>Temp.: -40 to +70 °C (IECEX)                  -40 to +75 °C (FM)</p>	<p><b>Field Device Access Point</b></p> <div style="display: flex; justify-content: space-around;"> <div style="text-align: center;">                   0981             </div> <div style="text-align: center;">                   N314             </div> </div> <p>IECEX CSA 14.XXXX: Ex ia IIB Ga T4                  IP66</p> <div style="text-align: center;">                   APPROVED             </div> <p>Cl. I, Div. 1 Group. CD; T4                  Cl. I, Zone 0, Group IIB; T4                  IP54/NEMA Type 4X                  Installation Per Dwg 51202683</p> <p>This device complies with Part 15 of FCC Rules and Regulations. Operation is subject to the following two conditions: (1) This device may not cause harmful interference and (2) this device must accept any interference received, including interference that may cause undesired operation.</p> <p>Contains FCC ID: S57-51306533 IC: 5731-51306533 Model 51306533                  Ethernet MAC: 00-40-84-xx-xx-xx</p>
---------------------------------------------------------------------------------------------------------------------------------------------------------------------------------------------------------------------------------------------------------------------------------------------------------------------------------------	----------------------------------------------------------------------------------------------------------------------------------------------------------------------------------------------------------------------------------------------------------------------------------------------------------------------------------------------------------------------------------------------------------------------------------------------------------------------------------------------------------------------------------------------------------------------------------------------------------------------------------------------------------------------------------------------------------------------------------------------------------------------------------------------------------------------------------------------------------------------------------------------------------------------------------------------------------------------------------------------------------------------------------------------------------------------------------------------------------------------------------------------------------------------------------------------------------------------------------------------------------------------------------------------------------

<p><b>Honeywell</b>                  Phoenix, AZ 85029, USA                  ASSEMBLED IN MEXICO</p> <p>Model: FDAP2                  Part No.: 51198665-200REV                  Ser. No.:                  Power: 18 - 30VDC, 2W                  90-260VAC, 50/60Hz, 2W</p> <p>Temp.: -40 to +70 °C (FM)</p>	<p><b>Field Device Access Point</b></p> <div style="display: flex; justify-content: space-around;"> <div style="text-align: center;">                   0981             </div> <div style="text-align: center;">                   N314             </div> </div> <div style="text-align: center;">                   APPROVED             </div> <p>Cl. I, Div. 2 Grp. ABCD; T4                  Cl. I, Zone 2, AEx nA nC IIC; T4                  IP54/NEMA Type 4X</p> <p>This device complies with Part 15 of FCC Rules and Regulations. Operation is subject to the following two conditions: (1) This device may not cause harmful interference and (2) this device must accept any interference received, including interference that may cause undesired operation.</p> <p>Contains FCC ID: S57-51306533 IC: 5731-51306533 Model 51306533                  Ethernet MAC: 00-40-84-xx-xx-xx</p>
----------------------------------------------------------------------------------------------------------------------------------------------------------------------------------------------------------------------------------------------------------------------------------------------------------------------------------------	---------------------------------------------------------------------------------------------------------------------------------------------------------------------------------------------------------------------------------------------------------------------------------------------------------------------------------------------------------------------------------------------------------------------------------------------------------------------------------------------------------------------------------------------------------------------------------------------------------------------------------------------------------------------------------------------------------------------------------------------------------------------------------------------------------------------------------------------------------------------------------------------------------------------------------------------------------------------------------------------------------------------------------------------------------------------------------------------------------------------------------------------------------------------------------------------



---

# Notices

## Trademarks

Experion®, PlantScape®, SafeBrowse®, TotalPlant®, and TDC 3000® are registered trademarks of Honeywell International, Inc.

ControlEdge™ is a trademark of Honeywell International, Inc.

OneWireless™ is a trademark of Honeywell International, Inc.

Matrikon® and MatrikonOPC™ are trademarks of Matrikon International. Matrikon International is a business unit of Honeywell International, Inc.

Movilizer® is a registered trademark of Movilizer GmbH. Movilizer GmbH is a business unit of Honeywell International, Inc.

## Other trademarks

Microsoft and SQL Server are either registered trademarks or trademarks of Microsoft Corporation in the United States and/or other countries.

Trademarks that appear in this document are used only to the benefit of the trademark owner, with no intention of trademark infringement.

## Third-party licenses

This product may contain or be derived from materials, including software, of third parties. The third party materials may be subject to licenses, notices, restrictions and obligations imposed by the licensor.

The licenses, notices, restrictions and obligations, if any, may be found in the materials accompanying the product, in the documents or files accompanying such third party materials, in a file named `third_party_licenses` on the media containing the product.

## Documentation feedback

You can find the most up-to-date documents on the Honeywell Process Solutions support website at:

<https://process.honeywell.com>

If you have comments about Honeywell Process Solutions documentation, send your feedback to: [hpsdocs@honeywell.com](mailto:hpsdocs@honeywell.com)

Use this email address to provide feedback, or to report errors and omissions in the documentation. For immediate help with a technical problem, contact your local Honeywell Process Solutions Customer Contact Center (CCC) or Honeywell Technical Assistance Center (TAC).

## How to report a security vulnerability

For the purpose of submission, a security vulnerability is defined as a software defect or weakness that can be exploited to reduce the operational or security capabilities of the software.

Honeywell investigates all reports of security vulnerabilities affecting Honeywell products and services.

To report a potential security vulnerability against any Honeywell product, please follow the instructions at:

<https://honeywell.com/pages/vulnerabilityreporting.aspx>

Submit the requested information to Honeywell using one of the following methods:

- Send an email to [security@honeywell.com](mailto:security@honeywell.com); or
- Contact your local Honeywell Process Solutions Customer Contact Center (CCC) or Honeywell Technical Assistance Center (TAC).

## Support

For support, contact your local Honeywell Process Solutions Customer Contact Center (CCC). To find your local CCC visit the website,

<https://process.honeywell.com/us/en/contact-us>.

## Training classes

Honeywell holds technical training classes that are taught by process control systems experts. For more information about these classes, contact your Honeywell representative, or see <http://www.automationcollege.com>.

## **Honeywell Process Solutions**

1250 W Sam Houston Pkwy S #150, Houston,  
TX 77042

Honeywell House, Skimped Hill Lane  
Bracknell, Berkshire, RG12 1EB

Building #1, 555 Huanke Road, Zhangjiang  
Hi-Tech Park,  
Pudong New Area, Shanghai, China 201203  
<https://process.honeywell.com>

OWDOC-X256-en-323A  
June 2022  
© 2022 Honeywell International Sàrl

**Honeywell**