

FCC RF Test Report

APPLICANT : Noto LLC
EQUIPMENT : Tablet PC
MODEL NAME : P48WVB4
FCC ID : S55-1210
STANDARD : FCC Part 15 Subpart C §15.247
CLASSIFICATION : (DTS) Digital Transmission System

The product was received on Sep. 18, 2014 and testing was completed on Sep. 20, 2014. We, SPORTON INTERNATIONAL INC., would like to declare that the tested sample has been evaluated in accordance with the test procedures and has been in compliance with the applicable technical standards.

The test results in this report apply exclusively to the tested model / sample. Without written approval of SPORTON INTERNATIONAL INC., the test report shall not be reproduced except in full.



Reviewed by: Joseph Lin / Supervisor



Approved by: Jones Tsai / Manager



SPORTON INTERNATIONAL INC.

No. 52, Hwa Ya 1st Rd., Hwa Ya Technology Park, Kwei-Shan Hsiang, Tao Yuan Hsien, Taiwan, R.O.C.

TABLE OF CONTENTS

REVISION HISTORY	3
SUMMARY OF TEST RESULT	4
1 GENERAL DESCRIPTION	5
1.1 Applicant	5
1.2 Product Feature of Equipment Under Test.....	5
1.3 Product Specification subjective to this standard	5
1.4 Modification of EUT	6
1.5 Testing Location	6
1.6 Applicable Standards.....	6
2 TEST CONFIGURATION OF EQUIPMENT UNDER TEST	7
2.1 Descriptions of Test Mode.....	7
2.2 Test Mode.....	8
2.3 Connection Diagram of Test System.....	9
2.4 Support Unit used in test configuration and system	10
2.5 EUT Operation Test Setup	10
2.6 Measurement Results Explanation Example.....	10
3 TEST RESULT	11
3.1 6dB Bandwidth Measurement	11
3.2 Peak Output Power Measurement	14
3.3 Power Spectral Density Measurement	16
3.4 Conducted Band Edges and Spurious Emission Measurement	22
3.5 Radiated Band Edges and Spurious Emission Measurement	31
3.6 AC Conducted Emission Measurement.....	35
3.7 Antenna Requirements.....	41
4 LIST OF MEASURING EQUIPMENT	42
5 UNCERTAINTY OF EVALUATION	43
APPENDIX A. RADIATED SPURIOUS EMISSION	

REVISION HISTORY

REPORT NO.	VERSION	DESCRIPTION	ISSUED DATE
FR332120-05	Rev. 01	Initial issue of report	Sep. 22, 2014

SUMMARY OF TEST RESULT

Report Section	FCC Rule	Description	Limit	Result	Remark
3.1	15.247(a)(2)	6dB Bandwidth	$\geq 0.5\text{MHz}$	Pass	-
3.2	15.247(b)(1)	Peak Output Power	$\leq 30\text{dBm}$	Pass	-
3.3	15.247(e)	Power Spectral Density	$\leq 8\text{dBm}/3\text{kHz}$	Pass	-
3.4	15.247(d)	Conducted Band Edges and Spurious Emission	$\leq 20\text{dBc}$	Pass	-
3.5	15.247(d)	Radiated Band Edges and Spurious Emission	15.209(a) & 15.247(d)	Pass	Under limit 9.89 dB at 213.060 MHz
3.6	15.207	AC Conducted Emission	15.207(a)	Pass	Under limit 8.70 dB at 0.478 MHz
3.7	15.203 & 15.247(b)	Antenna Requirement	N/A	Pass	-

1 General Description

1.1 Applicant

Noto LLC
201 Penn Center Boulevard
Suite 400
Pittsburgh, PA 15235

1.2 Product Feature of Equipment Under Test

Product Feature	
Equipment	Tablet PC
Model Name	P48WVB4
FCC ID	S55-1210
EUT supports Radios application	WLAN 11b/g/n HT20 WLAN 11a/n HT20 Bluetooth v4.0 EDR/LE

Remark: The above EUT's information was declared by manufacturer. Please refer to the specifications or user's manual for more detailed description.

1.3 Product Specification subjective to this standard

Product Specification subjective to this standard	
Tx/Rx Frequency Range	2402 MHz ~ 2480 MHz
Number of Channels	40
Carrier Frequency of Each Channel	40 Channel(37 hopping + 3 advertising channel)
Maximum Output Power to Antenna	7.59 dBm (0.0057 W)
Antenna Type	Fixed internal Antenna type with gain 2.80 dBi
Type of Modulation	Bluetooth LE : GFSK

1.4 Modification of EUT

No modifications are made to the EUT during all test items.

1.5 Testing Location

Sporton Lab is accredited to ISO 17025 by Taiwan Accreditation Foundation (TAF code : 1190) and the FCC designation No. TW1022 under the FCC 2.948(e) by Mutual Recognition Agreement (MRA) in FCC Test.

Test Site	SPORTON INTERNATIONAL INC.		
Test Site Location	No. 52, Hwa Ya 1 st Rd., Hwa Ya Technology Park, Kwei-Shan Hsiang, Tao Yuan Hsien, Taiwan, R.O.C. TEL: +886-3-3273456 / FAX: +886-3-3284978		
Test Site No.	Sporton Site No.		
	TH02-HY	CO05-HY	03CH06-HY

1.6 Applicable Standards

According to the specifications of the manufacturer, the EUT must comply with the requirements of the following standards:

- FCC Part 15 Subpart C §15.247
- FCC KDB Publication No. 558074 D01 DTS Meas. Guidance v03r02
- ANSI C63.4-2003

Remark: All test items were verified and recorded according to the standards and without any deviation during the test.

2 Test Configuration of Equipment Under Test

2.1 Descriptions of Test Mode

The RF output power was recorded in the following table:

Channel	Frequency	Bluetooth 4.0 – LE RF Output Power
		Data Rate / Modulation
		GFSK
		1Mbps
Ch00	2402MHz	6.96 dBm
Ch19	2440MHz	7.34 dBm
Ch39	2480MHz	7.59 dBm

- a. The EUT has been associated with peripherals and configuration operated in a manner tended to maximize its emission characteristics in a typical application. Frequency range investigated: conduction (150 kHz to 30 MHz), radiation (9 kHz to the 10th harmonic of the highest fundamental frequency or to 40 GHz, whichever is lower). Pre-scanned tests, X, Y, Z in three orthogonal panels to determine the final configuration (Y plane as worst plane) from all possible combinations.

- b. AC power line Conducted Emission was tested under maximum output power.

2.2 Test Mode

The following summary table is showing all test modes to demonstrate in compliance with the standard.

Summary table of Test Cases	
Test Item	Data Rate / Modulation
	Bluetooth 4.0 – LE / GFSK
Conducted TCs	Mode 1: Bluetooth Tx CH00_2402 MHz_1Mbps Mode 2: Bluetooth Tx CH19_2440 MHz_1Mbps Mode 3: Bluetooth Tx CH39_2480 MHz_1Mbps
Radiated TCs	Mode 1: Bluetooth Tx CH00_2402 MHz_1Mbps Mode 2: Bluetooth Tx CH19_2440 MHz_1Mbps Mode 3: Bluetooth Tx CH39_2480 MHz_1Mbps
AC Conducted Emission	Mode 1: Bluetooth Tx + Earphone + USB Cable (Charging from Adapter) + MPEG4

2.3 Connection Diagram of Test System

<Bluetooth 4.0 – LE Tx Mode>

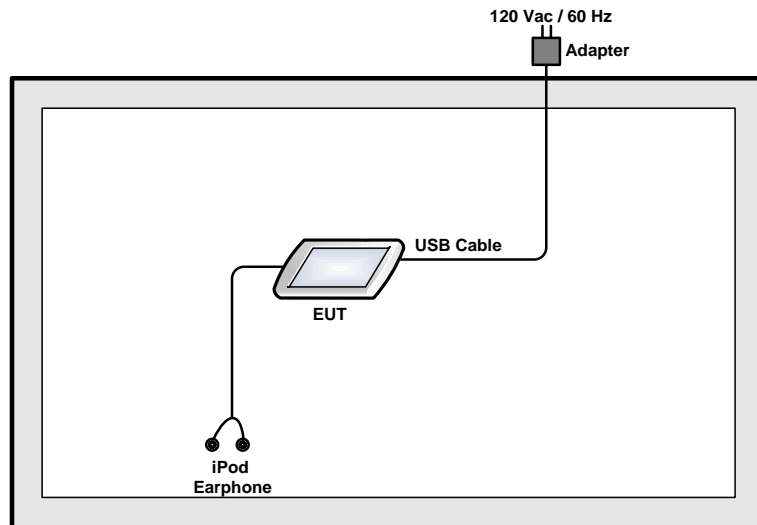

<AC Conducted Emission Mode>

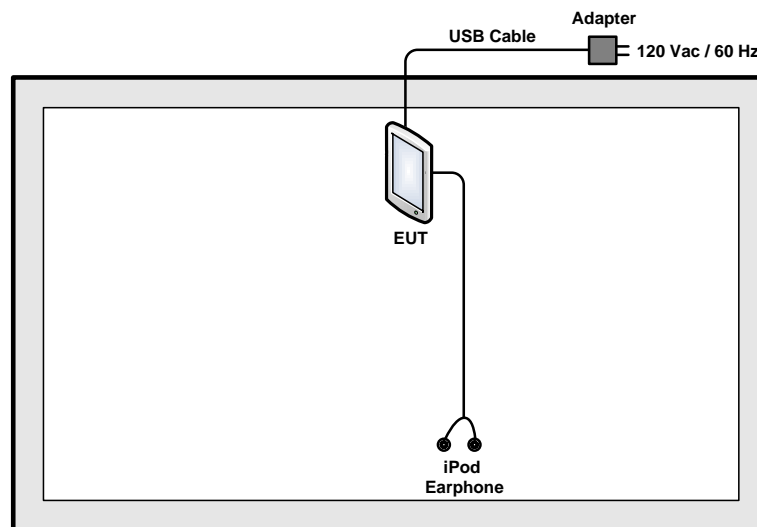

2.4 Support Unit used in test configuration and system

Item	Equipment	Trade Name	Model Name	FCC ID	Data Cable	Power Cord
1.	iPod Earphone	Apple	N/A	Verification	Unshielded, 1.0 m	N/A
2.	Adapter	N/A	N/A	N/A	N/A	N/A
3.	USB Cable	N/A	N/A	N/A	Unshielded, 1.6 m	N/A

2.5 EUT Operation Test Setup

For Bluetooth function, programmed RF utility, "ADB" installed in the notebook make the EUT provides functions like channel selection and power level for continuous transmitting and receiving signals.

2.6 Measurement Results Explanation Example

For all conducted test items:

The offset level is set in the spectrum analyzer to compensate the RF cable loss and attenuator factor between EUT conducted output port and spectrum analyzer. With the offset compensation, the spectrum analyzer reading level is exactly the EUT RF output level.

Example :

The spectrum analyzer offset is derived from RF cable loss and attenuator factor.

Offset = RF cable loss + attenuator factor.

Following shows an offset computation example with cable loss 4.2 dB and 10dB attenuator.

$$\begin{aligned} \text{Offset(dB)} &= \text{RF cable loss(dB)} + \text{attenuator factor(dB)}. \\ &= 4.2 + 10 = 14.2 \text{ (dB)} \end{aligned}$$

3 Test Result

3.1 6dB Bandwidth Measurement

3.1.1 Limit of 6dB Bandwidth

The minimum 6 dB bandwidth shall be at least 500 kHz.

3.1.2 Measuring Instruments

The section 4.0 of List of Measuring Equipment of this test report is used for test.

3.1.3 Test Procedures

1. The testing follows FCC KDB Publication No. 558074 D01 DTS Meas. Guidance v03r02.
2. The RF output of EUT was connected to the spectrum analyzer by RF cable and attenuator. The path loss was compensated to the results for each measurement.
3. Set to the maximum power setting and enable the EUT transmit continuously.
4. Make the measurement with the spectrum analyzer's resolution bandwidth (RBW) = 100 kHz. Set the Video bandwidth (VBW) = 300 kHz. In order to make an accurate measurement. The 6 dB bandwidth must be greater than 500 kHz.
5. Measure and record the results in the test report.

3.1.4 Test Setup

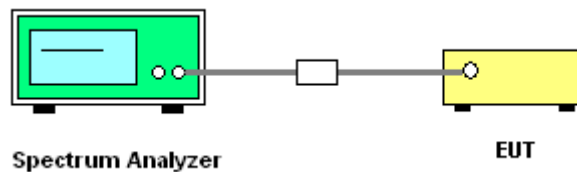

3.1.5 Test Result of 6dB Bandwidth

Test Mode :	Bluetooth 4.0 - LE	Temperature :	22~25°C
Test Engineer :	Stuart Lin	Relative Humidity :	51~55%

Channel	Frequency (MHz)	6dB Bandwidth (MHz)	6dB Bandwidth Min. Limit (MHz)	Pass/Fail
00	2402	0.72	0.5	Pass
19	2440	0.72	0.5	Pass
39	2480	0.72	0.5	Pass

6 dB Bandwidth Plot on Channel 00

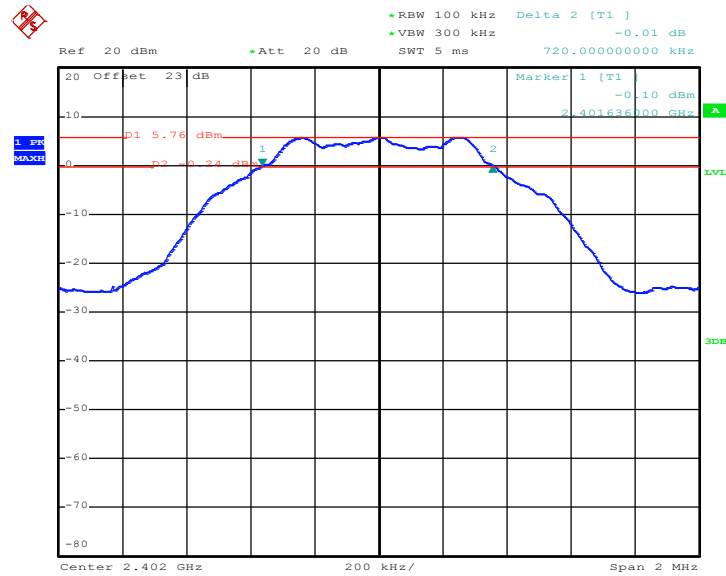

Date: 18.SEP.2014 14:47:53

6 dB Bandwidth Plot on Channel 19

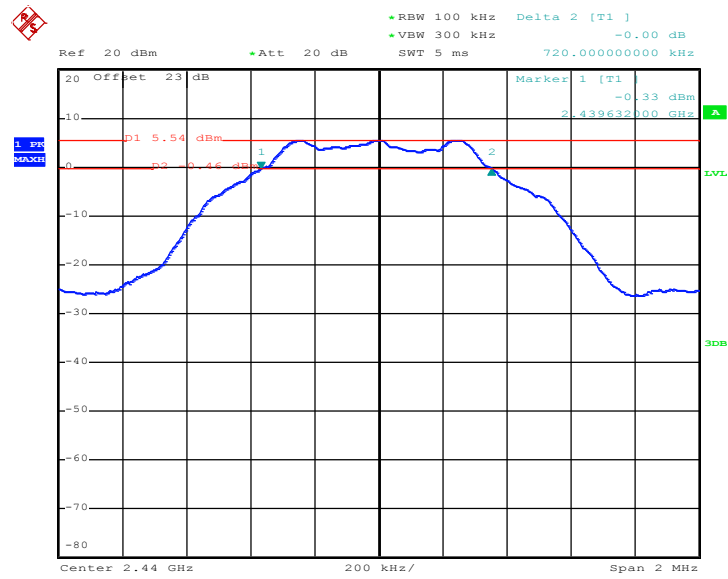

Date: 19.SEP.2014 15:46:17

6 dB Bandwidth Plot on Channel 39

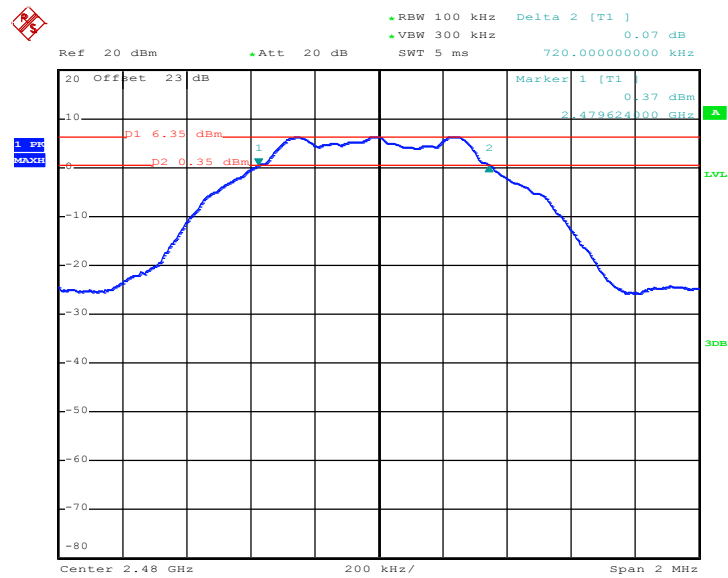

Date: 18.SEP.2014 14:56:49

3.2 Peak Output Power Measurement

3.2.1 Limit of Peak Output Power

For systems using digital modulation in the 2400-2483.5MHz, the limit for peak output power is 30dBm. If transmitting antenna of directional gain greater than 6dBi is used, the peak output power from the intentional radiator shall be reduced below the above stated value by the amount in dB that the directional gain of the antenna exceeds 6 dBi. In case of point-to-point operation, the limit has to be reduced by 1dB for every 3dB that the directional gain of the antenna exceeds 6dBi.

3.2.2 Measuring Instruments

The section 4.0 of List of Measuring Equipment of this test report is used for test.

3.2.3 Test Procedures

1. The testing follows the Measurement Procedure of FCC KDB No. 558074 DTS D01 Meas. Guidance v03r02.
2. The RF output of EUT was connected to the power meter by RF cable and attenuator. The path loss was compensated to the results for each measurement.
3. Set to the maximum power setting and enable the EUT transmit continuously.
4. Measure the conducted output power and record the results in the test report.

3.2.4 Test Setup

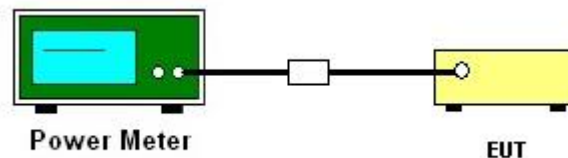

3.2.5 Test Result of Peak Output Power

Test Mode :	Bluetooth 4.0 - LE	Temperature :	22~25°C
Test Engineer :	Stuart Lin	Relative Humidity :	51~55%

Channel	Frequency (MHz)	RF Power (dBm)		
		GFSK	Max. Limits (dBm)	Pass/Fail
		1 Mbps		
00	2402	6.96	30.00	Pass
19	2440	7.34	30.00	Pass
39	2480	7.59	30.00	Pass

3.3 Power Spectral Density Measurement

3.3.1 Limit of Power Spectral Density

The peak power spectral density shall not be greater than 8dBm in any 3kHz band at any time interval of continuous transmission.

3.3.2 Measuring Instruments

The section 4.0 of List of Measuring Equipment of this test report is used for test.

3.3.3 Test Procedures

1. The testing follows Measurement Procedure 10.2 Method PKPSD of FCC KDB Publication No. 558074 D01 DTS Meas. Guidance v03r02
2. The RF output of EUT was connected to the spectrum analyzer by RF cable and attenuator. The path loss was compensated to the results for each measurement.
3. Set to the maximum power setting and enable the EUT transmit continuously.
4. Make the measurement with the spectrum analyzer's resolution bandwidth (RBW) = 3 kHz. Video bandwidth VBW = 10 kHz In order to make an accurate measurement, set the span to 1.5 times DTS Channel Bandwidth. (6dB BW)
5. Detector = peak, Sweep time = auto couple, Trace mode = max hold, Allow trace to fully stabilize. Use the peak marker function to determine the maximum power level.
6. Measure and record the results in the test report.
7. The Measured power density (dBm)/ 100kHz is a reference level and used as 20dBc down limit line for Conducted Band Edges and Conducted Spurious Emission.

3.3.4 Test Setup

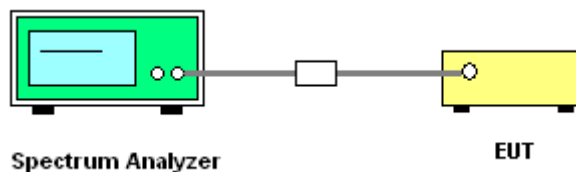

3.3.5 Test Result of Power Spectral Density

Test Mode :	Bluetooth 4.0 - LE	Temperature :	22~25°C
Test Engineer :	Stuart Lin	Relative Humidity :	51~55%

Channel	Frequency (MHz)	Power Density		Max. Limits (dBm/3kHz)	Pass/Fail
		PSD/100kHz (dBm)	PSD/3kHz (dBm)		
00	2402	5.76	-8.07	8	Pass
19	2440	5.56	-8.32	8	Pass
39	2480	6.37	-7.50	8	Pass

Note:

1. Measured power density (dBm) has offset with cable loss.
2. The Measured power density (dBm)/ 100kHz is reference level and used as 20dBc down for Conducted Band Edges and Conducted Spurious Emission limit line.

3.3.6 Test Result of Power Spectral Density Plots (100kHz)

PSD 100kHz Plot on Channel 00

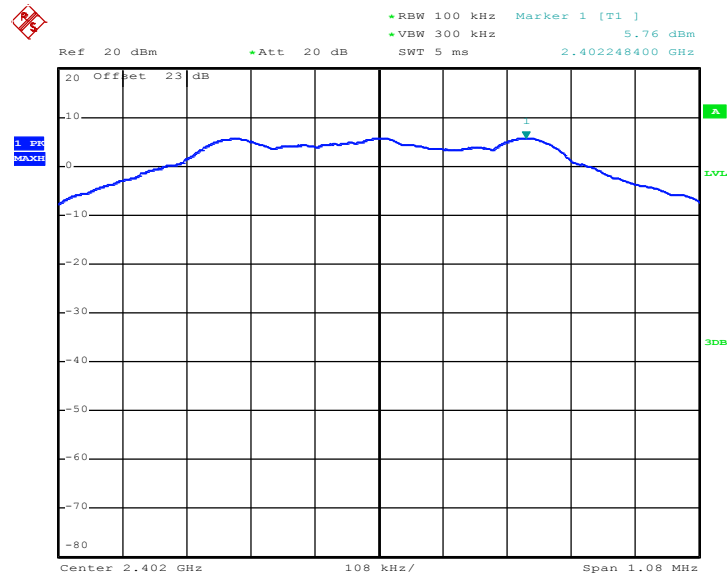

Date: 18.SEP.2014 14:48:54

PSD 100kHz Plot on Channel 19

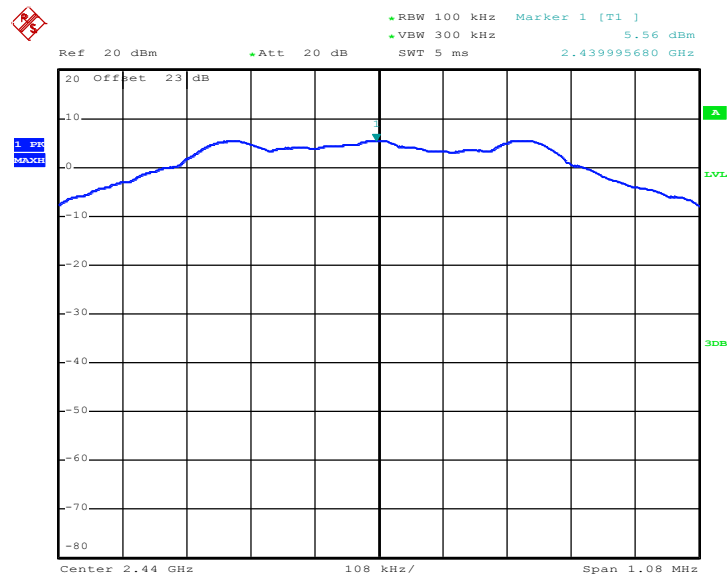

Date: 19.SEP.2014 15:47:01

PSD 100kHz Plot on Channel 39

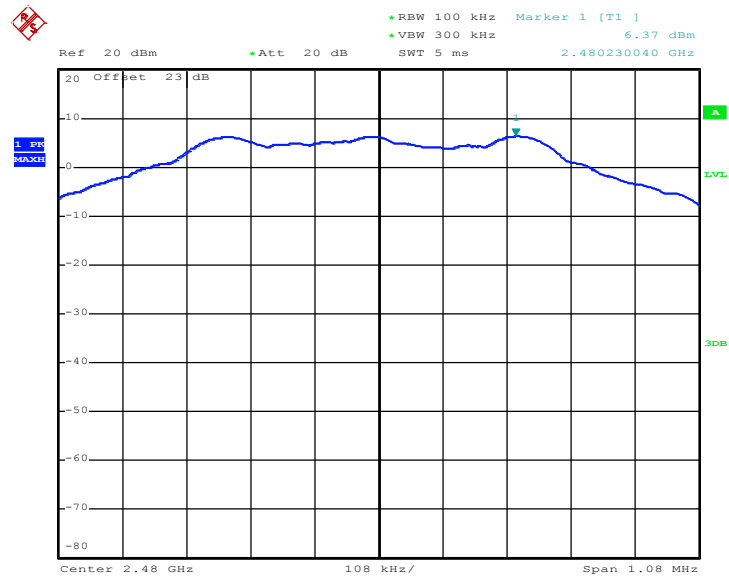

Date: 18.SEP.2014 14:57:40

3.3.7 Test Result of Power Spectral Density Plots (3kHz)

PSD 3kHz Plot on Channel 00

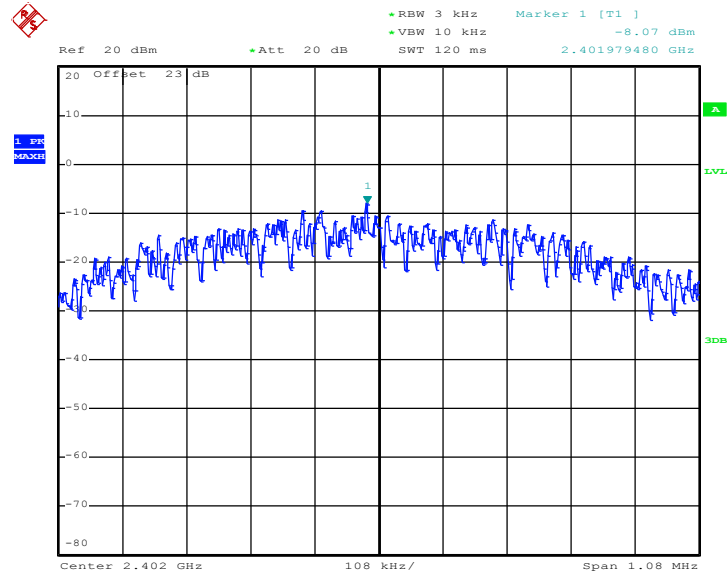

Date: 18.SEP.2014 14:48:31

PSD 3kHz Plot on Channel 19

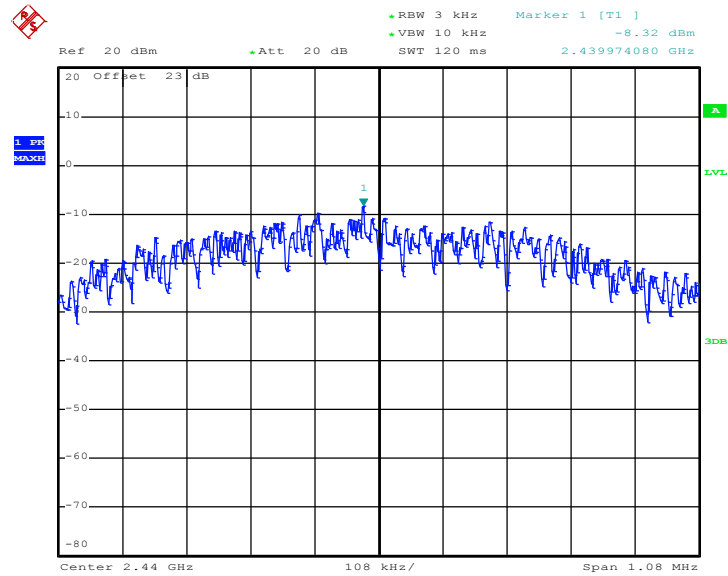

Date: 19.SEP.2014 15:46:39

PSD 3kHz Plot on Channel 39

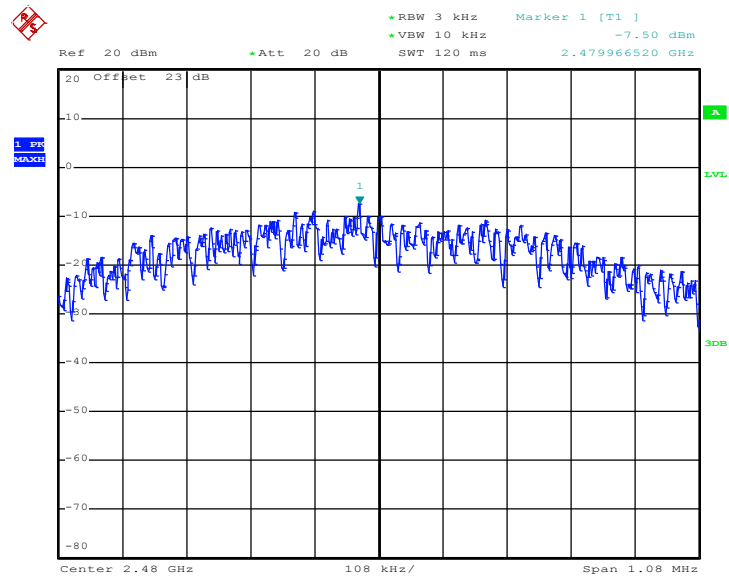

Date: 18.SEP.2014 14:57:19

3.4 Conducted Band Edges and Spurious Emission Measurement

3.4.1 Limit of Conducted Band Edges and Spurious Emission

All harmonics/spurious must be at least 20 dB down from the highest emission level within the authorized band.

3.4.2 Measuring Instruments

The section 4.0 of List of Measuring Equipment of this test report is used for test.

3.4.3 Test Procedure

1. The testing follows FCC KDB Publication No. 558074 D01 DTS Meas. Guidance v03r02.
2. The RF output of EUT was connected to the spectrum analyzer by RF cable and attenuator. The path loss was compensated to the results for each measurement.
3. Set to the maximum power setting and enable the EUT transmit continuously.
4. Set RBW = 100 kHz, VBW=300 kHz, Peak Detector. Unwanted Emissions measured in any 100 kHz bandwidth outside of the authorized frequency band shall be attenuated by at least 20 dB relative to the maximum in-band peak PSD level in 100 kHz when maximum peak conducted output power procedure is used. If the transmitter complies with the conducted power limits based on the use of RMS averaging over a time interval, the attenuation required under this paragraph shall be 30 dB instead of 20 dB per 15.247(d).
5. Measure and record the results in the test report.
6. The RF fundamental frequency should be excluded against the limit line in the operating frequency band.

3.4.4 Test Setup

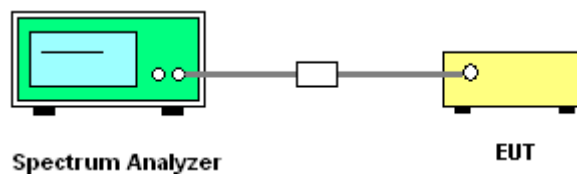

3.4.5 Test Result of Conducted Band Edges

Test Mode :	Bluetooth 4.0 - LE	Temperature :	22~25°C
Test Channel :	00 and 39	Relative Humidity :	51~55%
		Test Engineer :	Stuart Lin

Low Band Edge Plot on Channel 00

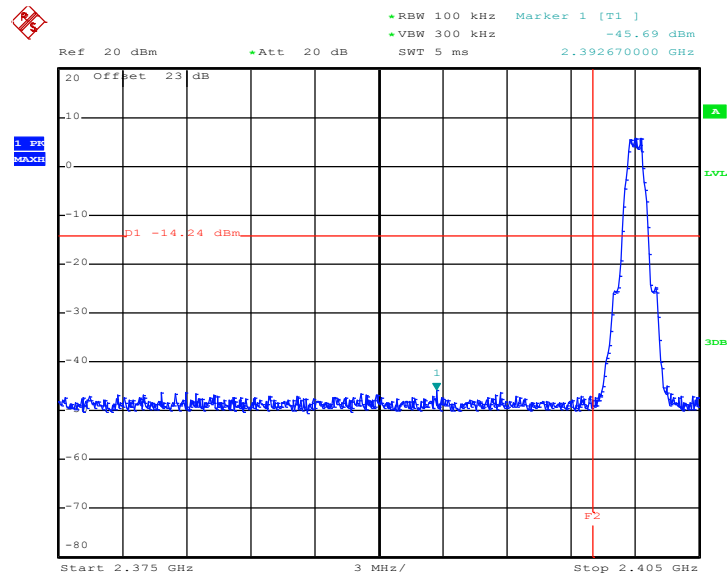

Date: 18.SEP.2014 14:49:40

High Band Edge Plot on Channel 39

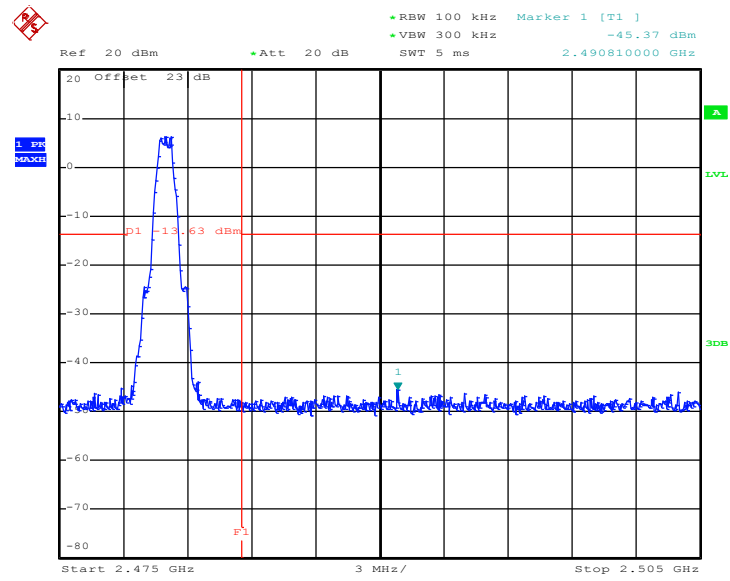

Date: 18.SEP.2014 14:57:56

3.4.6 Test Result of Conducted Spurious Emission

Test Mode :	Bluetooth 4.0 - LE	Temperature :	22~25°C
Test Channel :	00	Relative Humidity :	51~55%
		Test Engineer :	Stuart Lin

Conducted Spurious Emission Plot on Bluetooth LE 1Mbps GFSK Channel 00

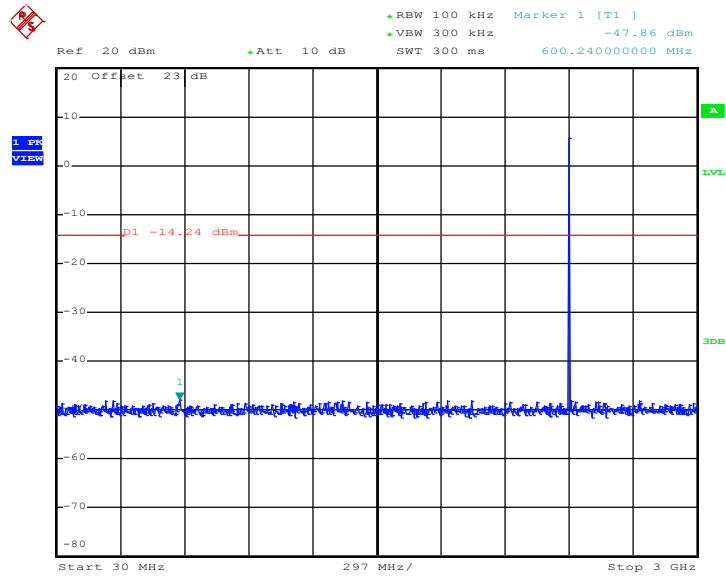

Date: 18.SEP.2014 14:50:15

Conducted Spurious Emission Plot on Bluetooth LE 1Mbps GFSK Channel 00

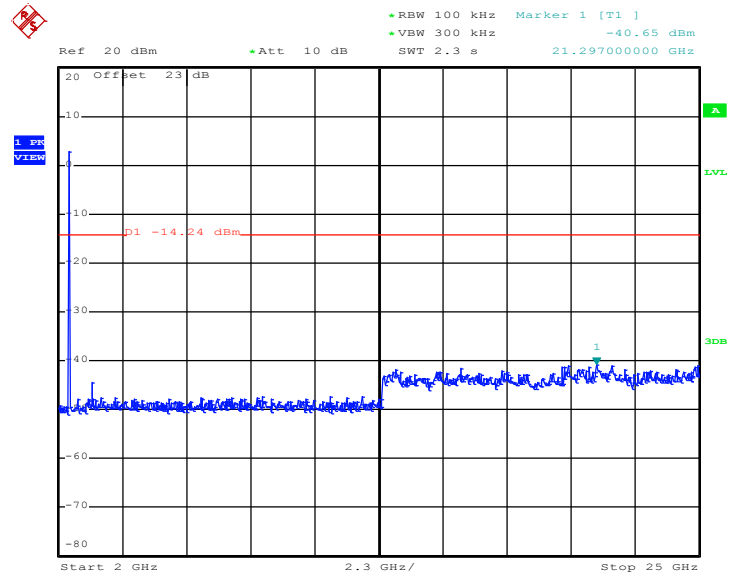

Date: 18.SEP.2014 14:50:33

Test Mode :	Bluetooth 4.0 - LE	Temperature :	22~25°C
Test Channel :	19	Relative Humidity :	51~55%
		Test Engineer :	Stuart Lin

**Conducted Spurious Emission Plot on Bluetooth LE 1Mbps
GFSK Channel 19**

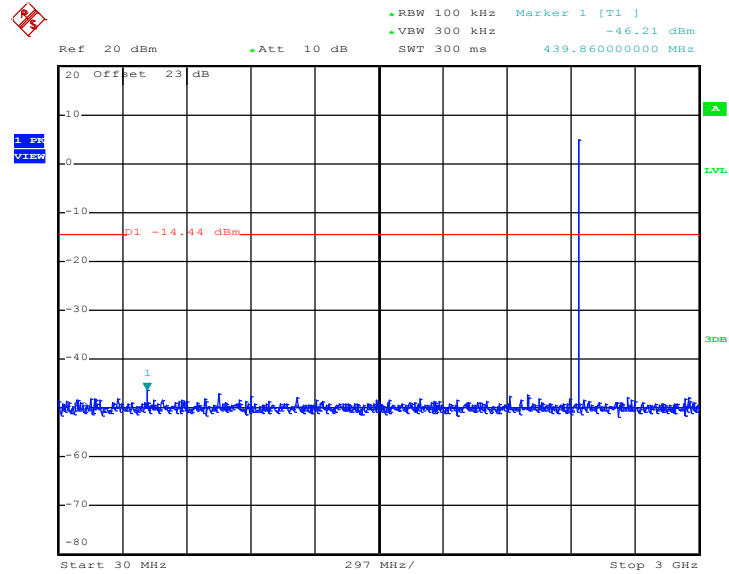

Date: 18.SEP.2014 14:43:02

Conducted Spurious Emission Plot on Bluetooth LE 1Mbps GFSK Channel 19

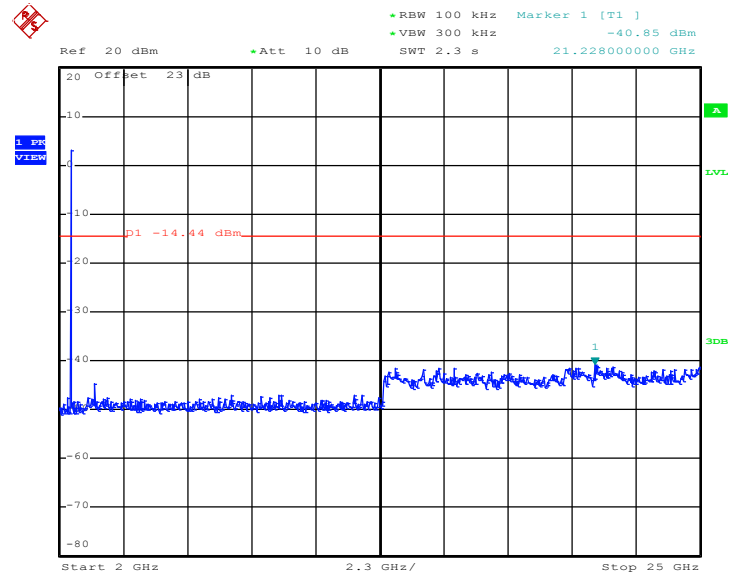

Date: 18.SEP.2014 14:43:20

Test Mode :	Bluetooth 4.0 - LE	Temperature :	22~25°C
Test Channel :	39	Relative Humidity :	51~55%
		Test Engineer :	Stuart Lin

**Conducted Spurious Emission Plot on Bluetooth LE 1Mbps
GFSK Channel 39**

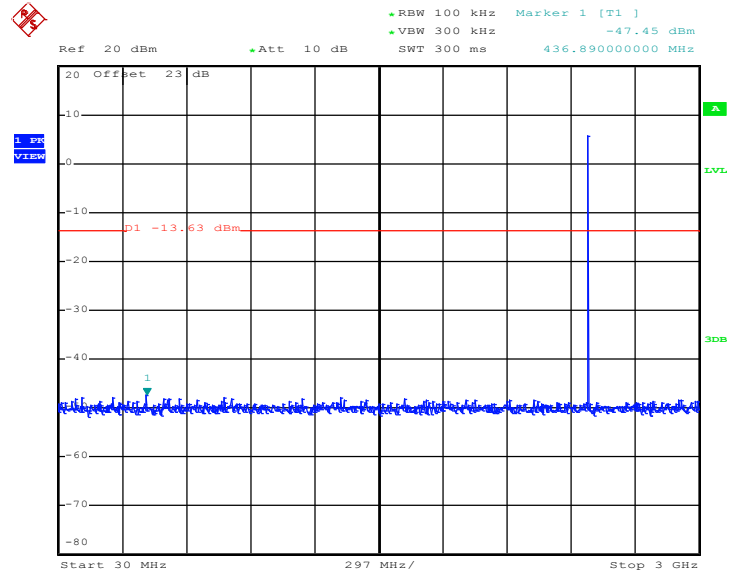

Date: 18.SEP.2014 14:58:18

Conducted Spurious Emission Plot on Bluetooth LE 1Mbps GFSK Channel 39

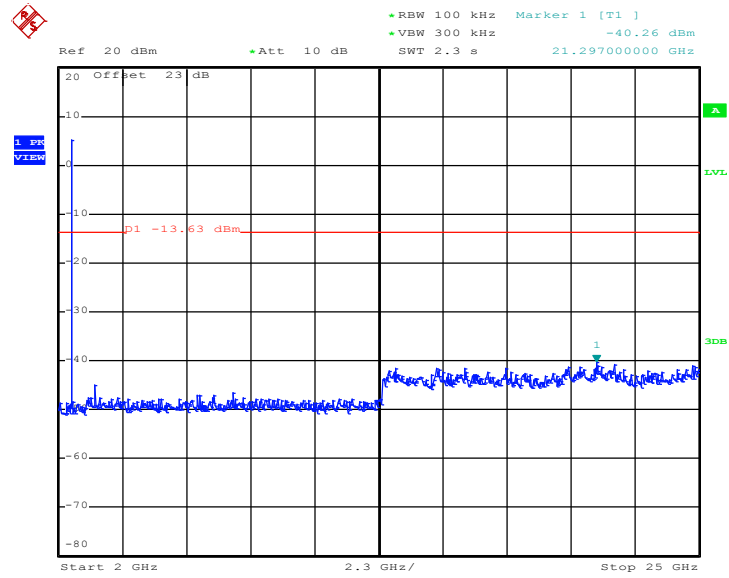

Date: 18.SEP.2014 14:58:36

3.5 Radiated Band Edges and Spurious Emission Measurement

3.5.1 Limit of Radiated Band Edges and Spurious Emission

In any 100 kHz bandwidth outside the intentional radiator frequency band, all harmonics/spurious must be at least 20 dB below the highest emission level within the authorized band. If the output power of this device was measured by spectrum analyzer, the attenuation under this paragraph shall be 30 dB instead of 20 dB. In addition, radiated emissions which fall in the restricted bands must also comply with the FCC section 15.209 limits as below.

Frequency (MHz)	Field Strength (microvolts/meter)	Measurement Distance (meters)
0.009 – 0.490	2400/F(kHz)	300
0.490 – 1.705	24000/F(kHz)	30
1.705 – 30.0	30	30
30 – 88	100	3
88 – 216	150	3
216 - 960	200	3
Above 960	500	3

3.5.2 Measuring Instruments

The section 4.0 of List of Measuring Equipment of this test report is used for test.

3.5.3 Test Procedures

1. The testing follows FCC KDB Publication No. 558074 D01 DTS Meas. Guidance v03r02.
2. The EUT was arranged to its worst case and then tune the antenna tower (from 1 m to 4 m) and turntable (from 0 degree to 360 degrees) to find the maximum reading. A pre-amp and a high pass filter are used for the test in order to get better signal level.
3. The EUT was placed on a turntable with 0.8 meter above ground.
4. The EUT was set 3 meters from the interference receiving antenna, which was mounted on the top of a variable height antenna tower.
5. Corrected Reading: Antenna Factor + Cable Loss + Read Level - Preamp Factor = Level
6. For measurement below 1GHz, If the emission level of the EUT measured by the peak detector is 3 dB lower than the applicable limit, the peak emission level will be reported. Otherwise, the emission measurement will be repeated using the quasi-peak detector and reported.
7. Use the following spectrum analyzer settings:
 - (1) Span shall wide enough to fully capture the emission being measured;
 - (2) Set RBW=100 kHz for $f < 1$ GHz; $VBW \geq RBW$; Sweep = auto; Detector function = peak; Trace = max hold;
 - (3) Set RBW = 1 MHz, VBW= 3MHz for $f \geq 1$ GHz for peak measurement.
 For average measurement:
 - $VBW = 10$ Hz, when duty cycle is no less than 98 percent.
 - $VBW \geq 1/T$, when duty cycle is less than 98 percent where T is the minimum transmission duration over which the transmitter is on and is transmitting at its maximum power control level for the tested mode of operation.

Band	Duty Cycle(%)	T(μ s)	1/T(kHz)	VBW Setting
Bluetooth 4.0 - LE	62.42	392.00	2.55	3kHz

3.5.4 Test Setup

For radiated emissions below 30MHz

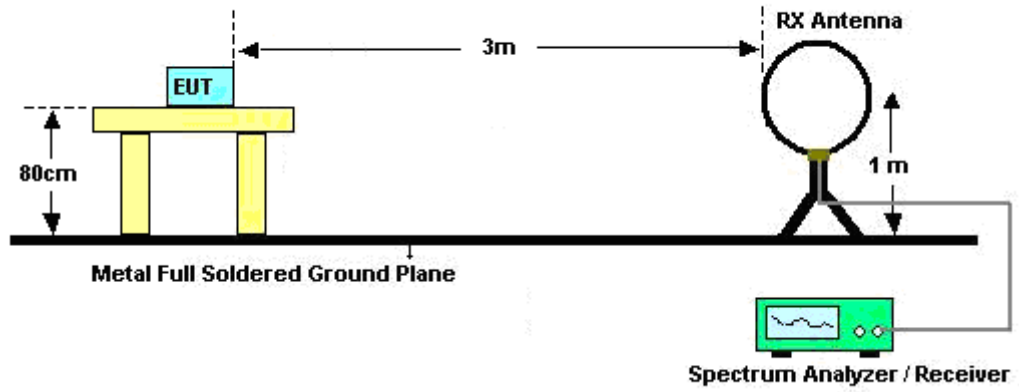

For radiated emissions from 30MHz to 1GHz

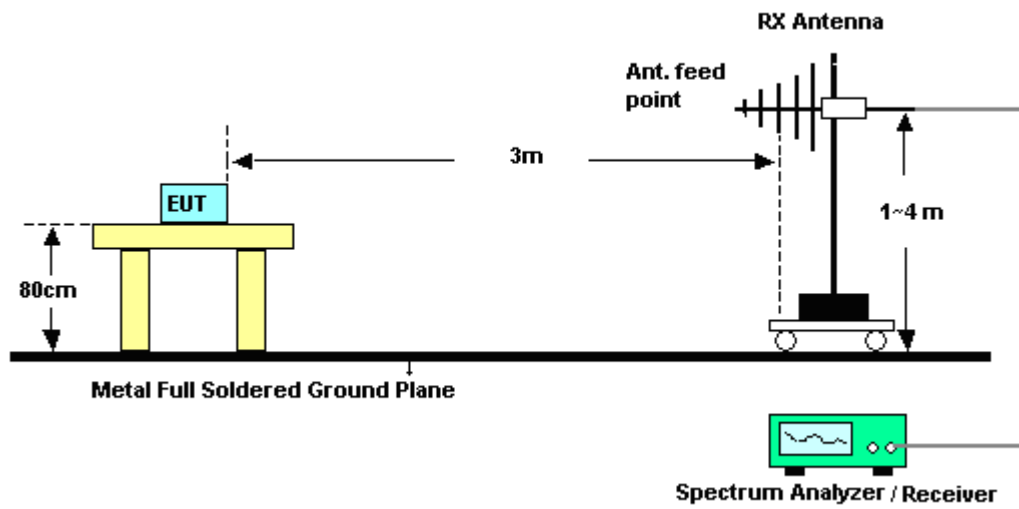

For radiated emissions above 1GHz

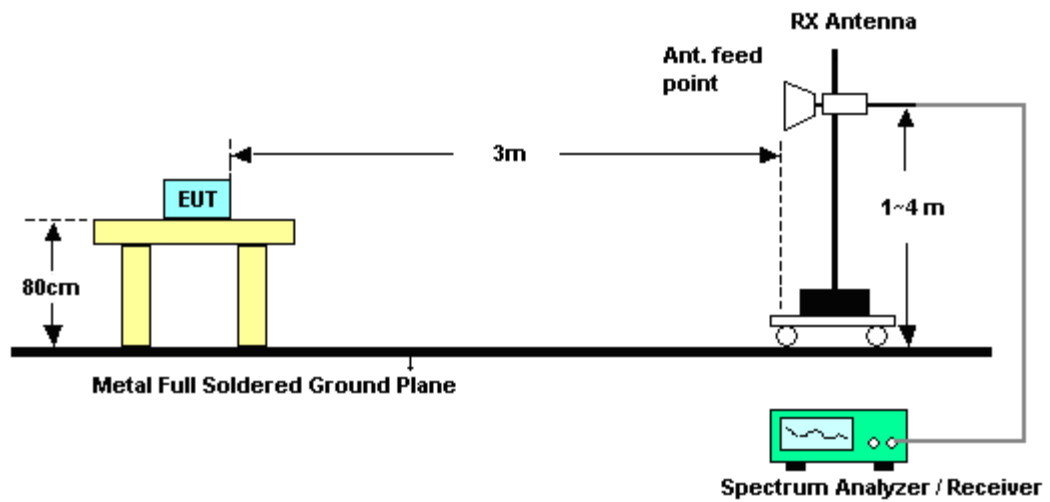

3.5.5 Test Results of Radiated Spurious Emissions (9 kHz ~ 30 MHz)

The low frequency, which started from 9 kHz to 30MHz, was pre-scanned and the result which was 20dB lower than the limit line per 15.31(o) was not reported.

3.5.6 Test Result of Radiated Spurious Emission (30MHz ~ 10th Harmonic)

Please refer Appendix A.

3.6 AC Conducted Emission Measurement

3.6.1 Limit of AC Conducted Emission

For equipment that is designed to be connected to the public utility (AC) power line, the radio frequency voltage that is conducted back onto the AC power line on any frequency or frequencies within the band 150 kHz to 30 MHz shall not exceed the limits in the following table.

Frequency of emission (MHz)	Conducted limit (dB μ V)	
	Quasi-peak	Average
0.15-0.5	66 to 56*	56 to 46*
0.5-5	56	46
5-30	60	50

*Decreases with the logarithm of the frequency.

3.6.2 Measuring Instruments

The section 4.0 of List of Measuring Equipment of this test report is used for test.

3.6.3 Test Procedures

1. The EUT was placed 0.4 meter from the conducting wall of the shielding room was kept at least 80 centimeters from any other grounded conducting surface.
2. Connect EUT to the power mains through a line impedance stabilization network (LISN).
3. All the support units are connecting to the other LISN.
4. The LISN provides 50 ohm coupling impedance for the measuring instrument.
5. The FCC states that a 50 ohm, 50 microhenry LISN should be used.
6. Both sides of AC line were checked for maximum conducted interference.
7. The frequency range from 150 kHz to 30 MHz was searched.
8. Set the test-receiver system to Peak Detect Function and specified bandwidth (IF Bandwidth = 9kHz) with Maximum Hold Mode. Then measurement is also conducted by Average Detector and Quasi-Peak Detector Function respectively.

3.6.4 Test Setup

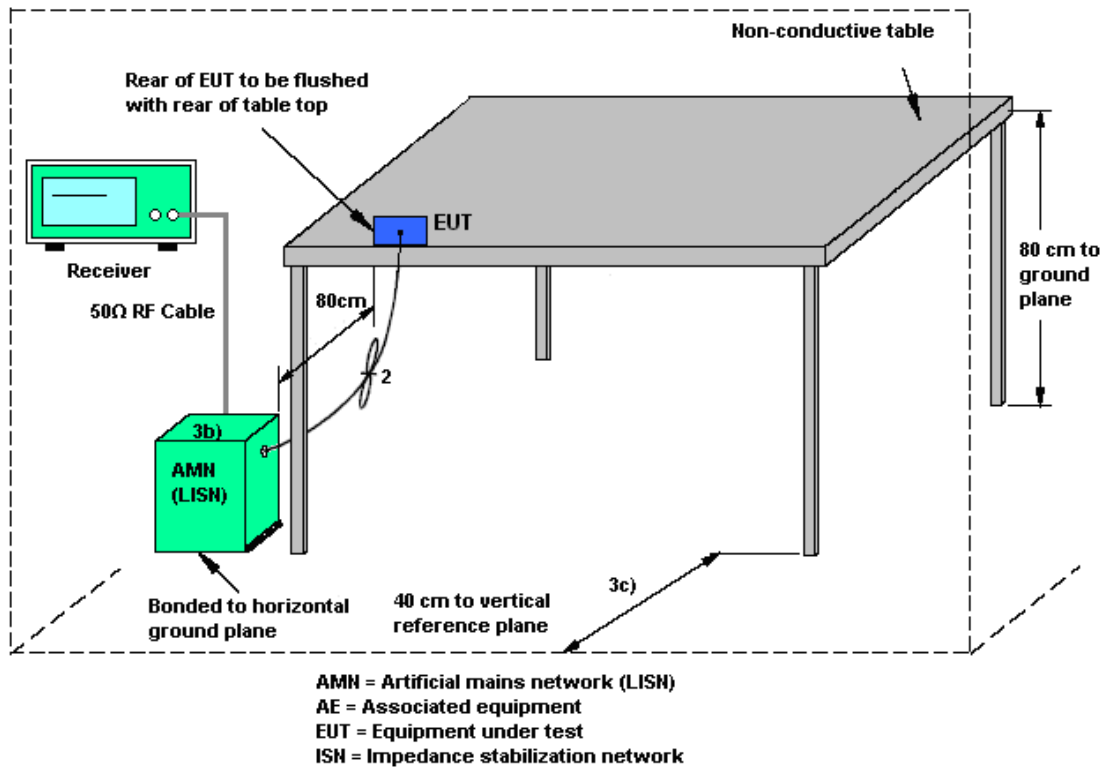

3.6.5 Test Result of AC Conducted Emission

Test Mode :	Mode 1	Temperature :	20~22°C
Test Engineer :	Kai-Chun Chu	Relative Humidity :	46~48%
Test Voltage :	120Vac / 60Hz	Phase :	Line
Function Type :	Bluetooth Tx + Earphone + USB Cable (Charging from Adapter) + MPEG4		

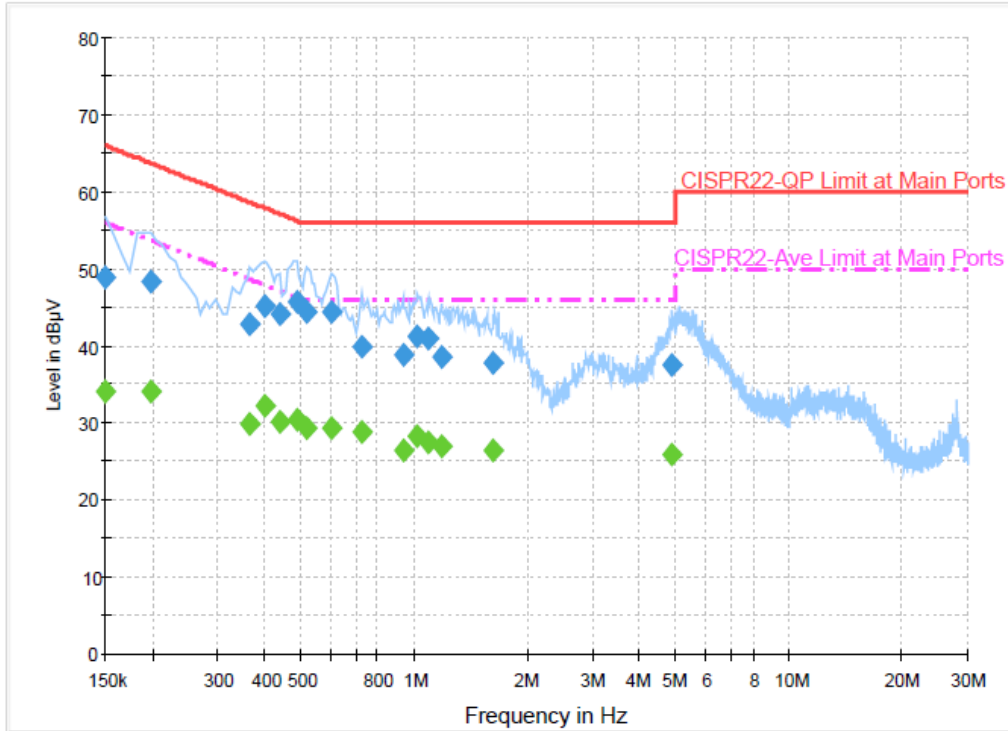

Final Result : Quasi-Peak

Frequency (MHz)	Quasi-Peak (dBµV)	Filter	Line	Corr. (dB)	Margin (dB)	Limit (dBµV)
0.150000	48.9	Off	L1	19.4	17.1	66.0
0.198000	48.2	Off	L1	19.4	15.5	63.7
0.366000	42.8	Off	L1	19.5	15.8	58.6
0.398000	45.1	Off	L1	19.5	12.8	57.9
0.438000	44.2	Off	L1	19.5	12.9	57.1
0.486000	45.8	Off	L1	19.5	10.4	56.2
0.518000	44.3	Off	L1	19.5	11.7	56.0
0.598000	44.4	Off	L1	19.5	11.6	56.0
0.726000	39.9	Off	L1	19.5	16.1	56.0
0.934000	38.8	Off	L1	19.5	17.2	56.0
1.022000	41.2	Off	L1	19.5	14.8	56.0
1.086000	40.8	Off	L1	19.5	15.2	56.0
1.182000	38.6	Off	L1	19.5	17.4	56.0
1.630000	37.6	Off	L1	19.6	18.4	56.0
4.886000	37.6	Off	L1	19.6	18.4	56.0

Test Mode :	Mode 1	Temperature :	20~22°C
Test Engineer :	Kai-Chun Chu	Relative Humidity :	46~48%
Test Voltage :	120Vac / 60Hz	Phase :	Line
Function Type :	Bluetooth Tx + Earphone + USB Cable (Charging from Adapter) + MPEG4		

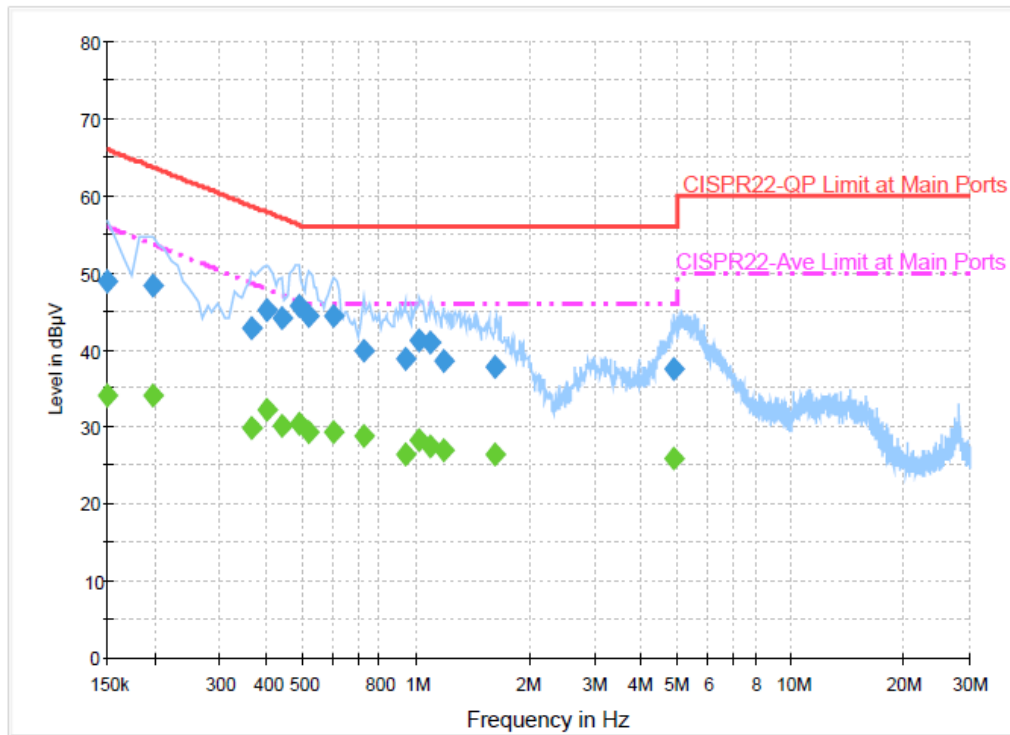

Final Result : Average

Frequency (MHz)	Average (dBµV)	Filter	Line	Corr. (dB)	Margin (dB)	Limit (dBµV)
0.150000	34.1	Off	L1	19.4	21.9	56.0
0.198000	34.1	Off	L1	19.4	19.6	53.7
0.366000	29.9	Off	L1	19.5	18.7	48.6
0.398000	32.2	Off	L1	19.5	15.7	47.9
0.438000	30.2	Off	L1	19.5	16.9	47.1
0.486000	30.3	Off	L1	19.5	15.9	46.2
0.518000	29.3	Off	L1	19.5	16.7	46.0
0.598000	29.4	Off	L1	19.5	16.6	46.0
0.726000	28.8	Off	L1	19.5	17.2	46.0
0.934000	26.3	Off	L1	19.5	19.7	46.0
1.022000	28.1	Off	L1	19.5	17.9	46.0
1.086000	27.3	Off	L1	19.5	18.7	46.0
1.182000	27.0	Off	L1	19.5	19.0	46.0
1.630000	26.5	Off	L1	19.6	19.5	46.0
4.886000	25.9	Off	L1	19.6	20.1	46.0

Test Mode :	Mode 1	Temperature :	20~22°C
Test Engineer :	Kai-Chun Chu	Relative Humidity :	46~48%
Test Voltage :	120Vac / 60Hz	Phase :	Neutral
Function Type :	Bluetooth Tx + Earphone + USB Cable (Charging from Adapter) + MPEG4		

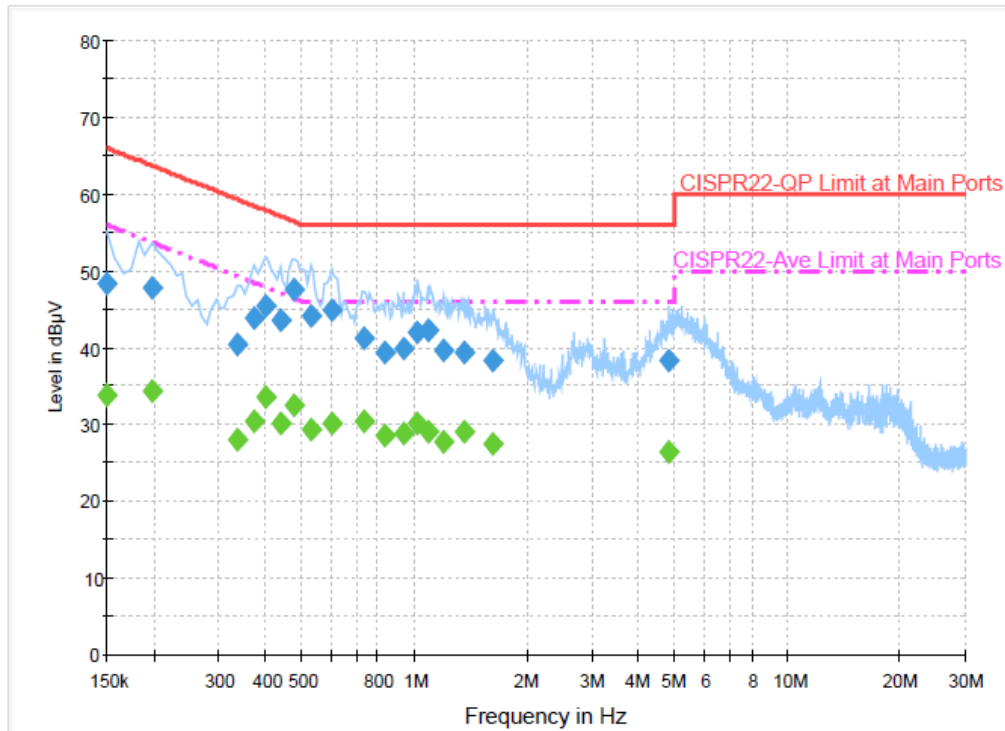

Final Result : Quasi-Peak

Frequency (MHz)	Quasi-Peak (dBµV)	Filter	Line	Corr. (dB)	Margin (dB)	Limit (dBµV)
0.150000	48.2	Off	N	19.4	17.8	66.0
0.198000	47.8	Off	N	19.4	15.9	63.7
0.334000	40.3	Off	N	19.5	19.1	59.4
0.374000	43.9	Off	N	19.5	14.5	58.4
0.398000	45.3	Off	N	19.5	12.6	57.9
0.438000	43.5	Off	N	19.5	13.6	57.1
0.478000	47.7	Off	N	19.6	8.7	56.4
0.526000	44.2	Off	N	19.5	11.8	56.0
0.598000	44.9	Off	N	19.5	11.1	56.0
0.734000	41.1	Off	N	19.5	14.9	56.0
0.838000	39.3	Off	N	19.6	16.7	56.0
0.934000	39.8	Off	N	19.5	16.2	56.0
1.022000	42.1	Off	N	19.6	13.9	56.0
1.086000	42.1	Off	N	19.5	13.9	56.0
1.198000	39.6	Off	N	19.6	16.4	56.0
1.366000	39.4	Off	N	19.6	16.6	56.0
1.630000	38.4	Off	N	19.6	17.6	56.0
4.806000	38.2	Off	N	19.6	17.8	56.0

Test Mode :	Mode 1	Temperature :	20~22°C
Test Engineer :	Kai-Chun Chu	Relative Humidity :	46~48%
Test Voltage :	120Vac / 60Hz	Phase :	Neutral
Function Type :	Bluetooth Tx + Earphone + USB Cable (Charging from Adapter) + MPEG4		

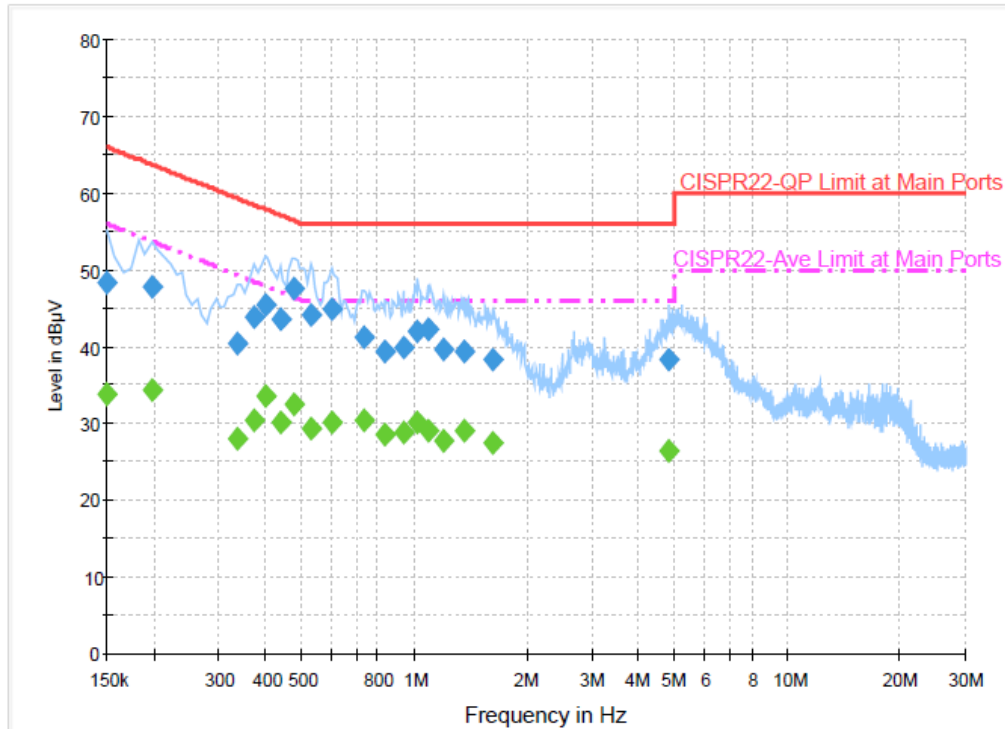

Final Result : Average

Frequency (MHz)	Average (dBµV)	Filter	Line	Corr. (dB)	Margin (dB)	Limit (dBµV)
0.150000	33.9	Off	N	19.4	22.1	56.0
0.198000	34.4	Off	N	19.4	19.3	53.7
0.334000	27.9	Off	N	19.5	21.5	49.4
0.374000	30.5	Off	N	19.5	17.9	48.4
0.398000	33.4	Off	N	19.5	14.5	47.9
0.438000	30.2	Off	N	19.5	16.9	47.1
0.478000	32.5	Off	N	19.6	13.9	46.4
0.526000	29.4	Off	N	19.5	16.6	46.0
0.598000	30.2	Off	N	19.5	15.8	46.0
0.734000	30.4	Off	N	19.5	15.6	46.0
0.838000	28.4	Off	N	19.6	17.6	46.0
0.934000	28.8	Off	N	19.5	17.2	46.0
1.022000	30.2	Off	N	19.6	15.8	46.0
1.086000	29.2	Off	N	19.5	16.8	46.0
1.198000	27.8	Off	N	19.6	18.2	46.0
1.366000	28.9	Off	N	19.6	17.1	46.0
1.630000	27.6	Off	N	19.6	18.4	46.0
4.806000	26.4	Off	N	19.6	19.6	46.0

3.7 Antenna Requirements

3.7.1 Standard Applicable

If directional gain of transmitting antennas is greater than 6dBi, the power shall be reduced by the same level in dB comparing to gain minus 6dBi. The use of a permanently attached antenna or of an antenna that uses a unique coupling to the intentional radiator shall be considered sufficient to comply with the FCC rule.

3.7.2 Antenna Anti-Replacement Construction

An embedded-in antenna design is used.

3.7.3 Antenna Gain

The antenna peak gain of EUT is less than 6 dBi. Therefore, it is not necessary to reduce maximum peak output power limit.

4 List of Measuring Equipment

Instrument	Manufacturer	Model No.	Serial No.	Characteristics	Calibration Date	Test Date	Due Date	Remark
Spectrum Analyzer	Rohde & Schwarz	FSP40	100055	9kHz~40GHz	Jun. 09, 2014	Sep. 18, 2014~ Sep. 19, 2014	Jun. 08, 2015	Conducted (TH02-HY)
Power Meter	Agilent	E4416A	GB412923 44	300MHz~40GHz	Jan. 28, 2014	Sep. 18, 2014~ Sep. 19, 2014	Jan. 27, 2015	Conducted (TH02-HY)
Power Sensor	Agilent	E9327A	US404415 48	300MHz~40GHz	Jan. 28, 2014	Sep. 18, 2014~ Sep. 19, 2014	Jan. 27, 2015	Conducted (TH02-HY)
Spectrum Analyzer	R&S	FSP30	101067	9kHz ~ 30GHz	Nov. 20, 2013	Sep. 20, 2014	Nov. 19, 2014	Radiation (03CH06-HY)
Spectrum Analyzer	Agilent	E4408B	MY442110 30	9kHz ~ 26.5GHz	Dec. 02, 2013	Sep. 20, 2014	Dec. 01, 2014	Radiation (03CH06-HY)
EMI Test Receiver	R&S	ESVS10	834468/00 03	20MHz ~ 1000MHz	May 06, 2014	Sep. 20, 2014	May 05, 2015	Radiation (03CH06-HY)
Bilog Antenna	Schaffner	CBL6112B	2885	30MHz ~ 2GHz	Oct. 10, 2013	Sep. 20, 2014	Oct. 09, 2014	Radiation (03CH06-HY)
Double Ridge Horn Antenna	EMCO	3117	00066583	1GHz ~ 18GHz	Jul. 24, 2014	Sep. 20, 2014	Jul. 23, 2015	Radiation (03CH06-HY)
Amplifier	SONOMA	310N	186713	9kHz ~ 1GHz	Apr. 16, 2014	Sep. 20, 2014	Apr. 15, 2015	Radiation (03CH06-HY)
Preamplifier	EMCI	EMC051845	SN980048	1GHz ~ 18GHz	Jul. 17, 2014	Sep. 20, 2014	Jul. 16, 2015	Radiation (03CH06-HY)
SHF-EHF Horn Antenna	SCHWARZBECK	BBHA 9170	BBHA9170 251	15GHz ~ 40GHz	Oct. 03, 2013	Sep. 20, 2014	Oct. 02, 2014	Radiation (03CH06-HY)
Preamplifier	Agilent	8449B	3008A019 17	1GHz ~ 26.5GHz	Apr. 10, 2014	Sep. 20, 2014	Apr. 09, 2015	Radiation (03CH06-HY)
Turn Table	INN-CO	DS2000	420/650/00	0 ~ 360 degree	N/A	Sep. 20, 2014	N/A	Radiation (03CH06-HY)
Antenna Mast	MF	MF-7802	MF780208 212	1 m ~ 4 m	N/A	Sep. 20, 2014	N/A	Radiation (03CH06-HY)
EMI Test Receiver	Rohde & Schwarz	ESCS 30	100356	9kHz ~ 2.75GHz	Nov. 15, 2013	Sep. 19, 2014	Nov. 14, 2014	Conduction (CO05-HY)
LISN (for auxiliary equipment)	Rohde & Schwarz	ENV216	100081	9kHz ~ 30MHz	Dec. 12, 2013	Sep. 19, 2014	Dec. 11, 2014	Conduction (CO05-HY)
LISN	Rohde & Schwarz	ENV216	100080	9kHz ~ 30MHz	Dec. 04, 2013	Sep. 19, 2014	Dec. 03, 2014	Conduction (CO05-HY)
AC Power Source	ChainTek	APC-1000W	N/A	N/A	N/A	Sep. 19, 2014	N/A	Conduction (CO05-HY)

5 Uncertainty of Evaluation

Uncertainty of Conducted Emission Measurement (150 kHz ~ 30 MHz)

Measuring Uncertainty for a Level of Confidence of 95% ($U = 2Uc(y)$)	2.26
---	------

Uncertainty of Radiated Emission Measurement (30 MHz ~ 1000 MHz)

Measuring Uncertainty for a Level of Confidence of 95% ($U = 2Uc(y)$)	4.50
---	------

Appendix A. Radiated Spurious Emission

Test Engineer :	Hyden Wu		
Temperature :	22~23°C	Relative Humidity :	52~53%

15C 2.4GHz 2400~2483.5MHz

BLE (Band Edge @ 3m)

BLE	Note	Frequency	Level	Over	Limit	Read	Antenna	Cable	Preamp	Ant	Table	Peak	Pol.	
				Limit	Line	Level	Factor	Loss	Factor	Pos	Pos	Avg.		
		(MHz)	(dBμV/m)	(dB)	(dBμV/m)	(dBμV)	(dB/m)	(dB)	(dB)	(cm)	(deg)	(P/A)	(H/V)	
BLE CH 00 2402MHz		2390	51.49	-22.51	74	47.98	31.94	6.21	34.64	103	50	P	H	
		2378.13	40.77	-13.23	54	37.32	31.93	6.17	34.65	103	50	A	H	
	*	2401.753	107.9	-	-	104.39	31.94	6.21	34.64	103	50	P	H	
	*	2402.004	106.71	-	-	103.2	31.94	6.21	34.64	103	50	A	H	
													H	
													H	
			2385.6	52.39	-21.61	74	48.93	31.94	6.17	34.65	107	66	P	V
			2388.75	40.49	-13.51	54	37.03	31.94	6.17	34.65	107	66	A	V
	*		2401.67	105.32	-	-	101.81	31.94	6.21	34.64	107	66	P	V
	*		2402.004	104.2	-	-	100.69	31.94	6.21	34.64	107	66	A	V
													V	
												V		
BLE CH 19 2440MHz		2316.57	52.06	-21.94	74	48.72	31.89	6.1	34.65	101	64	P	H	
		2380.02	40.68	-13.32	54	37.23	31.93	6.17	34.65	101	64	A	H	
	*	2439.746	108.24	-	-	104.67	31.97	6.24	34.64	101	64	P	H	
	*	2439.997	107.14	-	-	103.57	31.97	6.24	34.64	101	64	A	H	
			2491.92	51.52	-22.48	74	47.81	32	6.34	34.63	101	64	P	H
			2486.24	40.33	-13.67	54	36.67	31.99	6.3	34.63	101	64	A	H
			2329.89	51.49	-22.51	74	48.14	31.9	6.1	34.65	106	90	P	V
			2327.64	40.51	-13.49	54	37.16	31.9	6.1	34.65	106	90	A	V
	*		2439.746	106.32	-	-	102.75	31.97	6.24	34.64	106	90	P	V
	*		2439.997	105.15	-	-	101.58	31.97	6.24	34.64	106	90	A	V
			2486	51.5	-22.5	74	47.84	31.99	6.3	34.63	106	90	P	V
			2495.92	40.66	-13.34	54	36.95	32	6.34	34.63	106	90	A	V

BLE CH 39 2480MHz	*	2480.243	107.97	-	-	104.31	31.99	6.3	34.63	100	51	P	H
	*	2480.076	106.82	-	-	103.16	31.99	6.3	34.63	100	51	P	H
		2483.64	51.67	-22.33	74	48.01	31.99	6.3	34.63	100	51	P	H
		2483.64	41.3	-12.7	54	37.64	31.99	6.3	34.63	100	51	A	H
													H
													H
	*	2480.243	104.89	-	-	101.23	31.99	6.3	34.63	126	84	P	V
	*	2480.076	103.77	-	-	100.11	31.99	6.3	34.63	126	84	P	V
		2493.76	51.04	-22.96	74	47.33	32	6.34	34.63	126	84	P	V
		2483.56	40.7	-13.3	54	37.04	31.99	6.3	34.63	126	84	A	V
													V
													V
Remark	<p>1. No other spurious found.</p> <p>2. All results are PASS against Peak and Average limit line.</p>												

15C 2.4GHz 2400~2483.5MHz

BLE (Harmonic @ 3m)

BLE	Note	Frequency	Level	Over	Limit	Read	Antenna	Cable	Preamp	Ant	Table	Peak	Pol.	
		(MHz)	(dBμV/m)	(dB)	(dBμV/m)	(dBμV)	(dB/m)	(dB)	(dB)	(cm)	(deg)	(P/A)	(H/V)	
BLE CH 00 2402MHz		4804	43.39	-30.61	74	61.38	34.35	8.52	60.86	100	0	P	H	
													H	
													H	
													H	
		4804	41.27	-32.73	74	59.26	34.35	8.52	60.86	100	0	P	V	
														V
														V
														V
BLE CH 19 2440MHz		4880	43.67	-30.33	74	61.19	34.4	8.77	60.69	100	0	P	H	
		7320	41.2	-32.8	74	54.05	35.73	11.95	60.53	100	0	P	H	
													H	
													H	
		4880	43.31	-30.69	74	60.83	34.4	8.77	60.69	100	0	P	V	
		7320	40.81	-33.19	74	53.66	35.73	11.95	60.53	100	0	P	V	
														V
														V
BLE CH 39 2480MHz		4960	44.88	-29.12	74	61.87	34.47	9.02	60.48	100	0	P	H	
		7440	39.67	-34.33	74	52.53	35.71	12.01	60.58	100	0	P	H	
													H	
													H	
		4960	43.89	-30.11	74	60.88	34.47	9.02	60.48	100	0	P	V	
		7440	41.16	-32.84	74	54.02	35.71	12.01	60.58	100	0	P	V	
														V
														V
Remark	1. No other spurious found. 2. All results are PASS against Peak and Average limit line.													

15C Emission below 1GHz

2.4GHz BLE (LF)

BLE	Note	Frequency	Level	Over	Limit	Read	Antenna	Cable	Preamp	Ant	Table	Peak	Pol.	
				Limit	Line	Level	Factor	Loss	Factor	Pos	Pos	Avg.		
		(MHz)	(dBμV/m)	(dB)	(dBμV/m)	(dBμV)	(dB/m)	(dB)	(dB)	(cm)	(deg)	(P/A)	(H/V)	
2.4GHz BLE LF		185.25	26.83	-16.67	43.5	48.11	9	1.47	31.75			P	H	
		213.06	33.61	-9.89	43.5	54.64	9.13	1.59	31.75	112	325	P	H	
		251.94	33.71	-12.29	46	51	12.7	1.74	31.73			P	H	
		497.4	23.69	-22.31	46	35.39	17.77	2.46	31.93			P	H	
		856.5	24.58	-21.42	46	32.24	20.8	3.25	31.71			P	H	
		940.5	25.58	-20.42	46	32.09	21.3	3.35	31.16			P	H	
													H	
													H	
													H	
													H	
													H	
													H	
			51.06	27.44	-12.56	40	50.43	7.98	0.81	31.78			P	V
			83.46	26.56	-13.44	40	49.79	7.52	1.01	31.76			P	V
			186.06	32.37	-11.13	43.5	53.63	9.02	1.47	31.75	100	235	P	V
			447	24.68	-21.32	46	37.38	16.87	2.3	31.87			P	V
			553.4	23.13	-22.87	46	33.15	19.42	2.56	32			P	V
			872.6	25.06	-20.94	46	32.51	20.9	3.29	31.64			P	V
														V
														V
													V	
													V	
													V	
													V	
Remark	1. No other spurious found. 2. All results are PASS against limit line.													

Note symbol

*	Fundamental Frequency which can be ignored. However, the level of any unwanted emissions shall not exceed the level of the fundamental frequency per 15.209(c).
!	Test result is over limit line.
P/A	Peak or Average
H/V	Horizontal or Vertical

A calculation example for radiated spurious emission is shown as below:

WIFI	Note	Frequency	Level	Over	Limit	Read	Antenna	Cable	Preamp	Ant	Table	Peak	Pol.
Ant.				Limit	Line	Level	Factor	Loss	Factor	Pos	Pos	Avg.	
1+2		(MHz)	(dB μ V/m)	(dB)	(dB μ V/m)	(dB μ V)	(dB/m)	(dB)	(dB)	(cm)	(deg)	(P/A)	(H/V)
802.11b		2390	55.45	-18.55	74	54.51	32.22	4.58	35.86	103	308	P	H
CH 01													
2412MHz		2390	43.54	-10.46	54	42.6	32.22	4.58	35.86	103	308	A	H

1. Level(dB μ V/m) =

$$\text{Antenna Factor(dB/m)} + \text{Cable Loss(dB)} + \text{Read Level(dB}\mu\text{V)} - \text{Preamp Factor(dB)}$$

2. Over Limit(dB) = Level(dB μ V/m) – Limit Line(dB μ V/m)

For Peak Limit @ 2390MHz:

1. Level(dB μ V/m)

$$= \text{Antenna Factor(dB/m)} + \text{Cable Loss(dB)} + \text{Read Level(dB}\mu\text{V)} - \text{Preamp Factor(dB)}$$

$$= 32.22(\text{dB/m}) + 4.58(\text{dB}) + 54.51(\text{dB}\mu\text{V}) - 35.86(\text{dB})$$

$$= 55.45(\text{dB}\mu\text{V/m})$$

2. Over Limit(dB)

$$= \text{Level(dB}\mu\text{V/m)} - \text{Limit Line(dB}\mu\text{V/m)}$$

$$= 55.45(\text{dB}\mu\text{V/m}) - 74(\text{dB}\mu\text{V/m})$$

$$= -18.55(\text{dB})$$

For Average Limit @ 2390MHz:

1. Level(dB μ V/m)

$$= \text{Antenna Factor(dB/m)} + \text{Cable Loss(dB)} + \text{Read Level(dB}\mu\text{V)} - \text{Preamp Factor(dB)}$$

$$= 32.22(\text{dB/m}) + 4.58(\text{dB}) + 42.6(\text{dB}\mu\text{V}) - 35.86(\text{dB})$$

$$= 43.54(\text{dB}\mu\text{V/m})$$

2. Over Limit(dB)

$$= \text{Level(dB}\mu\text{V/m)} - \text{Limit Line(dB}\mu\text{V/m)}$$

$$= 43.54(\text{dB}\mu\text{V/m}) - 54(\text{dB}\mu\text{V/m})$$

$$= -10.46(\text{dB})$$

Both peak and average measured complies with the limit line, so test result is "PASS".