

Mobile CX1-6 4G+

Coupling Cradle Connect
Cellular Signal Booster

Vehicle

 6 BAND
MULTI BAND
23dB

User Manual

USA

Cellular *RX/TX* **23dB 6 BAND**
Signal Booster **MULTI BAND 23dB**

CRADLE TYPE

Coupling Connect

2G, 3G, 3G+, 4G, 4G+

GSM,HSPA,CDMA,LTE, LTE A

Band 12,17	700MHz Lower
Band 13	700MHz Upper
Band 5	850MHz
Band 4	1700/2100MHz
Band 2,25	1900MHz ext



In 2001 SmoothTalker produced the first digital mobile cellular signal booster in North America with FCC and ICAN approval. We continue to lead with the most powerful and intelligent boosters in the world. Our dynamic adaptive proprietary algorithms make them very network friendly. We call it STEALTH TECH technology.

**Boosts the outside signal into your vehicle
and the cell phone signal back to the tower.**

Smoothtalker.com

Contents

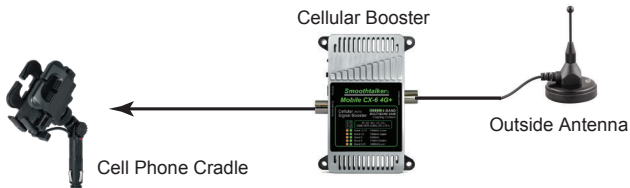

Optional Power Types



12 volt install
fused type



12 volt socket
CLA plug type



120 volt AC/DC

All parts shown are not included in all kits.
Please check your model number for more details at smoothtalker.com

NOTE: It is normal for the booster to be quite warm while the phone is in use state.

To comply with FCC rules, this booster must only be operated with cables, antennas and coupling devices that have been approved for use with this equipment.

Installation

Installation

1) Connect the outside antenna to the side of the booster marked as "outside antenna"

Connect the coupling holder to the side of the booster marked as "inside antenna"

2) Placement

Place the outside antenna in the middle of the vehicle roof. If the vehicle has a sunroof please place the antenna on the roof towards the back window.

Place the coupling holder in desired location.

Connect the booster as shown in Fig. 1 & 2 below.

Important: Use only the power supply included with the booster. Connecting any other power supply at any time will result in damage to the booster and will void the warranty. Do not turn on the power switch until ALL cables have been screwed or plugged into the booster or you can cause damage to the booster.

Applications

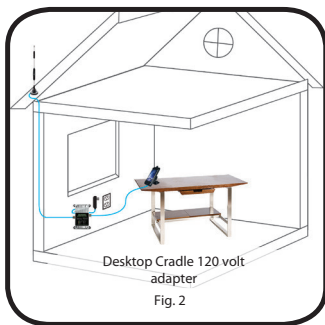
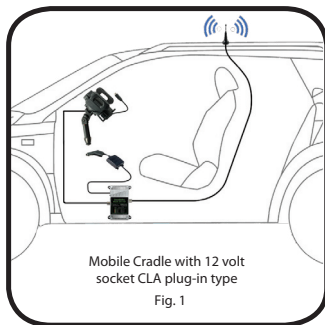

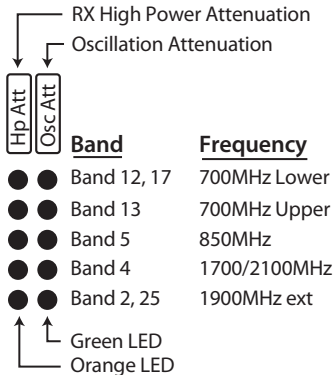
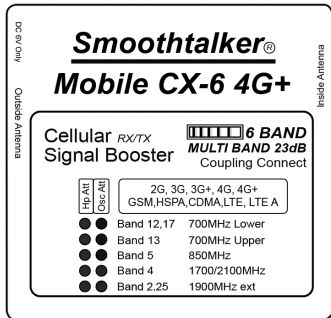

Understanding the lights

The “LEDS” on the face of the booster indicate operating gain state. In any given frequency band there is a Green and Orange LED which indicate the gain status of the band. When both of these LEDs are “SOLID ON” it means that the booster is operating normally and with full gain (No attenuation) in that band. If the booster has reduced its gain, one or both of the LEDs will indicate by flashing. (Per the chart on pg. 4)









Any reduction of gain will be due to either:

- High outside signal level (close to tower)
- Loop Oscillation due to the inside antenna (either on holder or Patch antenna) and the outside antennas are located too close together.

When the booster is off it will be indicated as follows:

When inside and outside antennas are extremely close together the Green LED will fast flash and the Orange LED will turn off indicating that the booster is off due to loop oscillation.

LED Lights Status Explanation

Attenuation (Att) Each flash indicates 3dB of gain reduction also known as gain attenuation. For example: three flashes equals 9dB of attenuation.	ORANGE LED RX High Power	GREEN LED Oscillation
Orange Solid ON = Full Gain - Green Solid ON = Full Gain	 SOLID ON	 SOLID ON
Orange Solid ON & Green Slow Flashing = Oscillation Att	 ON	 SLOW FLASHING
Orange Off & Green Fast Flashing = Oscillation Shutdown	 OFF	 FAST FLASHING
Orange Slow Flashing & Green Solid ON = RX High Power Att	 SLOW FLASHING	 ON/

What do the LED flashes mean?

**Each flash indicates 3dB of gain reduction also known as gain attenuation.
For example: three flashes equals 9dB of attenuation.**

Green LED indicates loop oscillation status. When flashing it means reduction of gain. To improve you need to spread the distance between the inside and outside antennas. If you spread them far enough away, the Green LED will become SOLID ON.

Orange LED indicates RX (outside signal strength) status. When flashing it means reduction of gain also known as attenuation of gain. You cannot prevent this condition. As you drive away from the nearby cell tower and get far enough away the flashing Orange will automatically stop flashing which indicates that the booster is no longer attenuated. As you approach another nearby cell tower the Orange may begin flashing again and will stop flashing as you get farther away. This is the normal operating process.

6 Band Coupling Kit

with Universal Charging Holder

Typical Cradle Booster Kit

Model shown
BTUX623MinUPA



Specifications Mobile CX-623 4G+

MODULATIONS	2G, 3G, 3G+, 4G, 4G+, GSM, HSPA, CDMA, LTE, LTE A				
OPERATIONAL BANDS	Band 12/17	Band 13	Band 5	Band 4	Band 2/25
FREQUENCIES	700 MHz lower	700 MHz upper	850 MHz	1700/2100 MHz	1900 MHz
TX POWER	1 watt EIRP				
GAIN	23 dB				
POWER SUPPLY	12V DC CLA OR 12V DC fused or 120V AC/DC				
OPERATING TEMP	-22 F TO + 185 F				
DIMENSIONS	L 4.56 xW 2.15 x H 1.25 (inch - pulgadas)				
WEIGHT	0.65 lb				

Approved Equipment List

For specifications of any of the Smoothalker FCC approved part numbers listed below visit smoothtalker.com

FCC requirements prohibit the use of unauthorized Antennas, Cables, and/or Coupling devices.

Coupling holders -	
BTH series	
Thru-hole Antennas	
SEM2TH series	SEM11TH series
SEM14TH series	SEM26TH series
SEM2THL series	SEM11THL series
SEM14THL series	SEM26THL series
Directional antennas	
SEMD1 series	SEMO series
SEMDA2 series	SEMPN1 series
Magnetic base Antennas	
SEMiniX1	SEM2M series
SEM11M series	SEM14M series
SEM2LGM series	SEM11LGM series
SEM14LGM series	SEM26LGM series
SEM2LGML series	SEM11LGML series
SEM14LGML series	SEM26LGML series
Extension Cables	
ACX100	
ACX900	
CBXmaXfe10	CBXmaXfe40
CBXmaXfe20	CBXmaXfe50
CBXmaXfe30	CBXmaXfe60

This is a CONSUMER device.

BEFORE USE, you MUST REGISTER THIS DEVICE with your wireless provider and have your provider's consent.

Most wireless providers consent to the use of signal boosters. Some providers may not consent to the use of this device on their network. If you are unsure, contact your provider.

You **MUST** operate this device with approved antennas and cables as specified by the manufacturer. Antennas **MUST** be installed at least 20 cm (8 inches) from any person. You **MUST** cease operating this device immediately if requested by the FCC or a licensed wireless service provider.

WARNING. E911 location information may not be provided or may be inaccurate for calls served by using this device.

Operational description:

To comply with FCC NPS (Network Protection Standard) requirements: NPS and other compliance/safeguard features for AGC and anti-oscillation have been implemented. NPS and other compliance/safeguard features are defaulted to be "On" (in operation). NPS and other compliance/safeguard features can not be field reconfigured, disabled or removed. This booster is not user programmable, does not need fine tuning or adjustment, does not require professional installation.

Contact information for Booster registration:

Some providers have set up web-sites for booster registration. If you don't see your provider on this list, please contact your provider for information on how to register your booster.

AT&T: <https://securec45.securewebsession.com/attsignalbooster.com/>

Verizon: <http://www.verizonwireless.com/solutions-and-services/accessories/register-signal-booster/>

T-mobile: <https://www.signalboosterregistration.com/>

Sprint: https://www.sprint.com/legal/fcc_boosters.html

Us Cellular: <http://www.uscellular.com/uscellular/support/fcc-booster-registration.jsp>

Warranty:

2 Year on manufacturing defects. Does not include misuse or customer damage.

Original Bill of Sale is required for all Warranty Claims



Automatic power control protects the Cellular Network

Smoothtalker.com

info@smoothtalker.com

Tel: 1 877 726 3444