



# FCC RADIO TEST REPORT

## FCC ID:S4R-TBGP

**Product:** Tablet PC

**Trade Name:** Smoothtalker

**Model Number:** TBGP

**Serial Model:** TBG8P,TBG16P,TBG32P

**Report No.:** NTEK-2015NT06031910F5

### Prepared for

Mobile Communications Inc.

230 Earl Stewart Drive, Aurora, Ontario L4G 6V8, Canada

### Prepared by

Shenzhen NTEK Testing Technology Co., Ltd.

1/F, Building E, Fenda Science Park, Sanwei Community, Xixiang Street

Bao'an District, Shenzhen P.R. China

Tel.: +86-0755-61156588 Fax.: +86-0755-61156599

Website: [www.ntek.org.cn](http://www.ntek.org.cn)

### TEST RESULT CERTIFICATION

**Applicant's name**.....: Mobile Communications Inc.  
**Address** .....: 230 Earl Stewart Drive, Aurora, Ontario L4G 6V8, Canada  
**Manufacture's Name** .....: Mobile Communications Inc.  
**Address** .....: 230 Earl Stewart Drive, Aurora, Ontario L4G 6V8, Canada  
**Product name**.....: Tablet PC  
**Model and/or type reference** ...: TBGP  
**Serial Model** : TBG8P,TBG16P,TBG32P  
**Standards**.....: FCC Part 22H and 24E: 01 Oct. 2014  
**Test procedure** .....: ANSI C63.10-2013, TIA/EIA 603D

This device described above has been tested by NTEK, and the test results show that the equipment under test (EUT) is in compliance with the FCC requirements. And it is applicable only to the tested sample identified in the report.

This report shall not be reproduced except in full, without the written approval of NTEK, this document may be altered or revised by NTEK, personnel only, and shall be noted in the revision of the document.

**Date of Test**.....  
Date (s) of performance of tests ..... 03 Jun. 2015 ~26 Jun. 2015  
Date of Issue ..... 26 Jun. 2015  
Test Result ..... **Pass**

Testing Engineer : Jason Chen  
(Jason Chen)  
Technical Manager : Brown Lu  
(Brown Lu)  
Authorized Signatory : Bill Yao  
(Bill Yao)

## TABLE OF CONTENTS

<b>1. GENERAL INFORMATION.....</b>	<b>5</b>
<b>1. GENERAL INFORMATION.....</b>	<b>5</b>
<b>1.1 PRODUCT DESCRIPTION.....</b>	<b>5</b>
<b>1.2 RELATED SUBMITTAL(S) / GRANT (S).....</b>	<b>6</b>
<b>1.3 TEST METHODOLOGY.....</b>	<b>6</b>
<b>1.4 TEST FACILITY.....</b>	<b>6</b>
<b>1.5 MEASUREMENT INSTRUMENTS.....</b>	<b>6</b>
<b>1.6 SPECIAL ACCESSORIES.....</b>	<b>6</b>
<b>1.7 EQUIPMENT MODIFICATIONS.....</b>	<b>6</b>
<b>2. SYSTEM TEST CONFIGURATION.....</b>	<b>7</b>
<b>2.1 EUT CONFIGURATION.....</b>	<b>7</b>
<b>2.2 EUT EXERCISE.....</b>	<b>7</b>
<b>2.3 GENERAL TECHNICAL REQUIREMENTS.....</b>	<b>7</b>
<b>2.4 CONFIGURATION OF EUT SYSTEM.....</b>	<b>8</b>
<b>3. SUMMARY OF TEST RESULTS.....</b>	<b>9</b>
<b>4. DESCRIPTION OF TEST MODES.....</b>	<b>9</b>
<b>5. OUTPUT POWER.....</b>	<b>10</b>
<b>5.1 Conducted Output Power.....</b>	<b>10</b>
<b>5.2 Radiated Output Power.....</b>	<b>15</b>
<b>6. SPURIOUS EMISSION.....</b>	<b>18</b>
<b>6.1 CONDUCTED SPURIOUS EMISSION.....</b>	<b>18</b>
<b>7. FREQUENCY STABILITY.....</b>	<b>26</b>
<b>7.1 MEASUREMENT METHOD.....</b>	<b>26</b>

<b>7.2 PROVISIONS APPLICABLE</b> .....	<b>26</b>
<b>7.3 MEASUREMENT RESULT</b> .....	<b>27</b>
<b>8. BANDWIDTH</b> .....	<b>30</b>
<b>8.1 APPLICABLE STANDARD</b> .....	<b>30</b>
<b>8.2 Test Procedure</b> .....	<b>30</b>
<b>8.3 MEASUREMENT RESULT</b> .....	<b>30</b>
<b>9. BAND EDGE</b> .....	<b>32</b>
<b>9.1 Applicable Standard</b> .....	<b>32</b>
<b>9.2 Test Procedure</b> .....	<b>32</b>
<b>9.3 MEASUREMENT RESULT</b> .....	<b>32</b>
<b>10. PEAK-TO-AVERAGE RATIO</b> .....	<b>33</b>
<b>10.1 MEASURING INSTRUMENTS</b> .....	<b>33</b>
<b>10.2 TEST PROCEDURES</b> .....	<b>33</b>
<b>10.3 TEST SETUP</b> .....	<b>33</b>
<b>10.4 TEST RESULT OF PEAK-TO-AVERAGE RATIO</b> .....	<b>34</b>
<b>TEST PLOTS FOR CONDUCTED SPURIOUS EMISSION</b> .....	<b>35</b>
<b>TEST PLOTS FOR OCCUPIED BANDWIDTH (99%)</b> .....	<b>48</b>
<b>EMISSION BANDWIDTH (-26DBC)</b> .....	<b>48</b>
<b>APPENDIX III</b> .....	<b>56</b>
<b>TEST PLOTS FOR BAND EDGES</b> .....	<b>56</b>
<b>APPENDIX IV</b> .....	<b>61</b>
<b>PHOTOGRAPHS OF TEST SETUP</b> .....	<b>61</b>

# 1. GENERAL INFORMATION

## 1.1 PRODUCT DESCRIPTION

A major technical description of EUT is described as following:

Product Designation:	Tablet PC
Hardware version:	--
Software version:	--
Frequency Bands:	<input checked="" type="checkbox"/> GSM 850 <input checked="" type="checkbox"/> GSM 1900 (U.S. Bands) <input type="checkbox"/> GSM 900 <input type="checkbox"/> DCS 1800 (Non-U.S. Bands) U.S. Bands: <input checked="" type="checkbox"/> UMTS FDD Band II <input checked="" type="checkbox"/> UMTS FDD Band V Non-U.S. Bands: <input type="checkbox"/> UMTS FDD Band I <input type="checkbox"/> UMTS FDD Band VIII
Antenna:	FPCB Antenna
Antenna gain:	1.0 dBi
Power Supply:	DC 3.7V by battery
Battery parameter:	DC 3.7V,6000mAh
Adapter Input:	100-240V~,50/60 Hz
Adapter Output:	5.0V---,2000mA
GPRS Class	Multi-Class12 Only 4 timeslots are used for GPRS
SIM CARD	The Phone Two SIM Card sockets
Extreme Vol. Limits:	DC3.5 V to 4.2 V (Nominal DC3.7 V)
Extreme Temp. Tolerance	-10°C to +50°C
** Note: The High Voltage 4.2V and Low Voltage 3.5V was declared by manufacturer, The EUT couldn't be operate normally with higher or lower voltage.	

## 1.2 RELATED SUBMITTAL(S) / GRANT (S)

This submittal(s) (test report) is intended for **FCC ID:S4R-TBGP** filing to comply with the FCC Part 22H&24E .

## 1.3 TEST METHODOLOGY

The radiated emission testing was performed according to the procedures of ANSI C 63.4: 2003; TIA/EIA 603D and FCC CFR 47 Rules of 2.1046, 2.1047, 2.1049, 2.1051, 2.1053, 2.1055, 2.1057.

## 1.4 TEST FACILITY

The test site used to collect the radiated data is located at:  
NTEK Testing Technology Co., Ltd.

1/F, Building E, Fenda Science Park, Sanwei Community, Xixiang Street, Bao'an District, Shenzhen P.R. China.

The test site is constructed and calibrated to meet the FCC requirements in documents ANSI C63.4: 2003.

FCC Registration No.:238937

IC Registration No.:9270A-1,

CNAS Registration No.:L5516

## 1.5 MEASUREMENT INSTRUMENTS

NAME OF EQUIPMENT	MANUFACTURER	MODEL	SERIAL NUMBER	NEXT CAL. DATE
SPECTRUM ANALYZER	AGILENT	E4440A	US44300399	2015.6.26
TEST RECEIVER	R&S	ESCI	A0304218	2015.6.26
COMMUNICATION TESTER	AGILENT	8960	3104A03367	2015.6.26
COMMUNICATION TESTER	R&S	CMU200	A0304247	2015.6.26
TEST RECEIVER	R&S	FCKL1528	A0304230	2015.6.26
LISN	SCHWARZBECK	NSLK8127	A0304233	2015.6.26
CLIMATE CHAMBER	ALBATROSS	--	--	2015.6.26
Loop Antenna	Daze	ZN30900N	SEL0097	2015.6.26
Biological Antenna	A.H. Systems Inc.	SAS-521-4	N/A	2015.6.26
Horn Antenna	EM	EM-AH-10180	N/A	2015.6.26

## 1.6 SPECIAL ACCESSORIES

The battery and the charger, earphone supplied by the applicant were used as accessories and being tested with EUT intended for FCC grant together.

## 1.7 EQUIPMENT MODIFICATIONS

Not available for this EUT intended for grant.

## 2. SYSTEM TEST CONFIGURATION

### 2.1 EUT CONFIGURATION

The EUT configuration for testing is installed on RF field strength measurement to meet the Commission's requirement and operating in a manner which intends to maximize its emission characteristics in a continuous normal application.

### 2.2 EUT EXERCISE

The Transmitter was operated in the maximum output power mode through Communication Tester. The TX frequency was fixed which was for the purpose of the measurements.

### 2.3 GENERAL TECHNICAL REQUIREMENTS

Item Number	Item Description		FCC Rules
1	Output Power	Conducted output power	22.913(a) / 24.232 (b)
		Radiated output power	
2	Spurious Emission	Conducted spurious emission	2.1051 / 22.917 / 24.238
		Radiated spurious emission	
3	Frequency Stability		2.1055 /24.235
4	Occupied Bandwidth		2.1049 (h)(i)
5	Emission Bandwidth		22.917(b) / 24.238 (b)
6	Band Edge		22.917(b) / 24.238 (b)
7	Peak-to-Average Ratio		24.232(d)

**2.4 CONFIGURATION OF EUT SYSTEM**

Fig. 2-1 Configuration of EUT System



Table 2-1 Equipment Used in EUT System

Item	Equipment	Model No.	ID or Specification	Note
1	Tablet PC	<b>TBGP</b>	<b>FCC ID:S4R-TBGP</b>	EUT

*Note: All the accessories have been used during the test.  
the following "EUT" in setup diagram means EUT system.*



### 3. SUMMARY OF TEST RESULTS

Item Number	Item Description		FCC Rules	Result
1	Output Power	Conducted Output Power	22.913(a) / 24.232 (b)	Pass
		Radiated Output Power		
2	Spurious Emission	Conducted Spurious Emission	2.1051 / 22.917 / 24.238	Pass
		Radiated Spurious Emission		
3	Frequency Stability		2.1055 /24.235	Pass
4	Occupied Bandwidth		2.1049 (h)(i)	Pass
5	Emission Bandwidth		22.917(b) / 24.238 (b)	Pass
6	Band Edge		22.917(b) / 24.238 (b)	Pass
7	Peak-to-Average Ratio		24.232(d)	Pass

### 4. DESCRIPTION OF TEST MODES

During the testing, the EUT was controlled via Rhode & Schwarz Digital Radio Communication Tester (CMU 200) to ensure max power transmission and proper modulation. Three channels (The top channel, the middle channel and the bottom channel) were chosen for testing on both GPRS850 and GPRS1900 frequency band.

**Note:** GSM/GPRS 850, GSM/GPRS 1900, HSDPA band II, HSUPA band II, HSDPA band V, HSUPA band V modes have been tested during the test. the worst condition (GSM850, GSM1900 RMC 12.2k) be recorded in the test report if no other modes test data.

## **5. OUTPUT POWER**

### **5.1 Conducted Output Power**

#### **5.1.1 MEASUREMENT METHOD**

The EUT was setup for the max output power with pseudo random data modulation. Power was measured with Spectrum Analyzer. The measurements were performed on all modes(GSM/GPRS 850, GSM/GPRS 1900, HSDPA band II, HSUPA band II, HSDPA band V, HSUPA band V) at 3 typical channels(the Top Channel, the Middle Channel and the Bottom Channel) for each band.

#### **5.1.2 MEASUREMENT RESULT**

**GSM850:**

Mode	Frequency (MHz)	Maximum Burst-Average Output Power
GSM850	824.2	32.35
	836.6	32.31
	848.8	32.09
GPRS850 (1 Slot)	824.2	32.15
	836.6	32.24
	848.8	32.17
GPRS850 (2 Slot)	824.2	30.41
	836.6	30.46
	848.8	30.39
GPRS850 (3 Slot)	824.2	28.42
	836.6	28.46
	848.8	28.37
GPRS850 (4 Slot)	824.2	27.52
	836.6	27.51
	848.8	27.57
	848.8	27.52

Mode	Frequency (MHz)	Maximum Burst-Average Output Power
EGPRS850 (1 Slot)	824.2	25.85
	836.6	25.63
	848.8	25.65
EGPRS850 (2 Slot)	824.2	24.66
	836.6	24.42
	848.8	24.37
EGPRS850 (3 Slot)	824.2	24.62
	836.6	24.64
	848.8	24.65
EGPRS850 (4 Slot)	824.2	24.51
	836.6	24.76
	848.8	24.77

**GSM1900:**

<b>Mode</b>	<b>Frequency (MHz)</b>	<b>Maximum Burst-Average Output Power</b>
GSM1900	1850.2	29.28
	1880	29.27
	1909.8	29.23
GPRS1900 (1 Slot)	1850.2	29.18
	1880	29.16
	1909.8	29.34
GPRS1900 (2 Slot)	1850.2	28.18
	1880	28.27
	1909.8	28.31
GPRS1900 (3 Slot)	1850.2	26.26
	1880	26.44
	1909.8	26.36
GPRS1900 (4 Slot)	1850.2	25.42
	1880	25.37
	1909.8	25.53
	1880	29.28
	1909.8	29.27

<b>Mode</b>	<b>Frequency (MHz)</b>	<b>Maximum Burst-Average Output Power</b>
EGPRS1900 (1 Slot)	1850.2	25.38
	1880	25.45
	1909.8	25.28
EGPRS1900 (2 Slot)	1850.2	24.46
	1880	24.38
	1909.8	24.37
EGPRS1900 (3 Slot)	1850.2	24.37
	1880	24.56
	1909.8	24.39
EGPRS1900 (4 Slot)	1850.2	24.28
	1880	24.82
	1909.8	24.15

**UMTS BAND II**

<b>Mode</b>	<b>Frequency (MHz)</b>	<b>Maximum Burst-Average Output Power</b>
WCDMA 1900 RMC	1852.4	22.43
	1880.0	22.38
	1907.6	22.35
WCDMA 1900 AMR	1852.4	21.92
	1880.0	22.25
	1907.6	21.82
HSDPA Subtest 1	1852.4	22.16
	1880	22.54
	1907.6	21.35
HSDPA Subtest 2	1852.4	21.54
	1880	21.33
	1907.6	21.47
HSDPA Subtest 3	1852.4	21.26
	1880	21.48
	1907.6	21.51
HSDPA Subtest 4	1852.4	21.35
	1880	21.39
	1907.6	21.35
HSUPA Subtest 1	1852.4	22.26
	1880.0	22.14
	1907.6	21.85
HSUPA Subtest 2	1852.4	21.58
	1880.0	21.68
	1907.6	21.74
HSUPA Subtest 3	1852.4	21.58
	1880.0	21.35
	1907.6	21.16
HSUPA Subtest 4	1852.4	21.26
	1880.0	21.54
	1907.6	21.65
HSUPA Subtest 5	1852.4	21.06
	1880.0	21.35
	1907.6	21.25

**UMTS BAND V**

<b>Mode</b>	<b>Frequency (MHz)</b>	<b>Maximum Burst-Average Output Power</b>
WCDMA 850 RMC	826.4	21.32
	835.0	21.31
	846.6	21.35
WCDMA 850 AMR	826.4	21.34
	835.0	21.31
	846.6	21.26
HSDPA Subtest 1	826.4	21.28
	835.0	20.31
	846.6	20.48
HSDPA Subtest 2	826.4	20.27
	835.0	20.36
	846.6	20.34
HSDPA Subtest 3	826.4	20.41
	835.0	20.41
	846.6	20.36
HSDPA Subtest 4	826.4	20.31
	835.0	20.38
	846.6	20.41
HSUPA Subtest 1	826.4	20.36
	835.0	20.31
	846.6	20.29
HSUPA Subtest 2	826.4	20.21
	835.0	20.27
	846.6	20.41
HSUPA Subtest 3	826.4	20.43
	835.0	20.44
	846.6	20.45
HSUPA Subtest 4	826.4	20.47
	835.0	20.37
	846.6	20.46
HSUPA Subtest 5	826.4	20.35
	835.0	20.36
	846.6	20.34

## 5.2 Radiated Output Power

### 5.2.1 MEASUREMENT METHOD

The measurements procedures specified in TIA-603D-2004 were applied.

- 1 In an anechoic antenna test chamber, a half-wave dipole antenna for the frequency band of interest is placed at the reference centre of the chamber. An RF Signal source for the frequency band of interest is connected to the dipole with a cable that has been constructed to not interfere with the radiation pattern of the antenna. A known (measured) power ( $P_{in}$ ) is applied to the input of the dipole, and the power received ( $P_r$ ) at the chamber's probe antenna is recorded.
- 2 The substitution method is used. Substitution values at each frequency are measured before and saved to the test software. A "reference path loss" is established as  $AR_{pl} = P_{in} + 2.15 - P_r$ . The  $AR_{pl}$  is the attenuation of "reference path loss", and including the gain of receive antenna, the cable loss and the air loss. The measurement results are obtained as described below:  $Power = P_{Mea} + AR_{pl}$
- 3 The EUT is substituted for the dipole at the reference centre of the chamber and a scan is performed to obtain the radiation pattern.
- 4 From the radiation pattern, the co-ordinates where the maximum antenna gain occurs are identified.
- 5 The EUT is then put into continuously transmitting mode at its maximum power level.
- 6 Power mode measurements are performed with the receiving antenna placed at the coordinates determined in Step 3 to determine the output power as defined in Rule 24.232 (b) and (c). The "reference path loss" from Step1 is added to this result.
- 7 This value is EIRP since the measurement is calibrated using a half-wave dipole antenna of known gain (2.15 dBi) and known input power ( $P_{in}$ ).
- 8 ERP can be calculated from EIRP by subtracting the gain of the dipole,  $ERP = EIRP - 2.15dBi$ .
9. Both horizontal and vertical antenna polarities were tested and performed pretest to three orthogonal axis. The worst case emissions were reported

### 5.2.2 PROVISIONS APPLICABLE

This is the test for the maximum radiated power from the EUT. Rule Part 24.232(b) specifies, "Mobile/portable stations are limited to 2 watts e.i.r.p. Peak power" and 24.232(c) specifies that "Peak transmit power must be measured over any interval of continuous transmission using instrumentation calibrated in terms of an rms-equivalent voltage." Rule Part 22.913(a) specifies "Maximum ERP. The effective radiated power (ERP) of base transmitters and cellular repeaters must not exceed 500 Watts. The ERP of mobile transmitters and auxiliary test transmitters must not exceed 7 Watts."

Mode	Nominal Peak Power
GSM 850	$\leq 38.45$ dBm (7W)
GSM 1900	$\leq 33$ dBm (2W)
UMTS BANDV	$\leq 38.45$ dBm (7W)

**5.2.3 MEASUREMENT RESULT**

Radiated Power (ERP) for GSM 850 MHZ				
Mode	Frequency	Result		Conclusion
		Max. Peak ERP (dBm)	Polarization Of Max. ERP	
GSM850	824.2	27.54	Horizontal	Pass
	824.2	25.21	Vertical	Pass
	836.6	26.57	Horizontal	Pass
	836.6	25.37	Vertical	Pass
	848.8	27.72	Horizontal	Pass
	848.8	26.61	Vertical	Pass

Radiated Power (ERP) for GPRS 850 MHZ				
Mode	Frequency	Result		Conclusion
		Max. Peak ERP (dBm)	Polarization Of Max. ERP	
GPRS850	824.2	27.91	Horizontal	Pass
	824.2	25.34	Vertical	Pass
	836.6	26.64	Horizontal	Pass
	836.6	25.11	Vertical	Pass
	848.8	26.54	Horizontal	Pass
	848.8	26.36	Vertical	Pass

Radiated Power (E.I.R.P) for GSM 1900 MHZ				
Mode	Frequency	Result		Conclusion
		Max. Peak E.I.R.P.(dBm)	Polarization Of Max. E.I.R.P.	
GSM 1900	1850.2	26.12	Horizontal	Pass
	1850.2	25.52	Vertical	Pass
	1880.0	26.89	Horizontal	Pass
	1880.0	24.65	Vertical	Pass
	1909.8	25.25	Horizontal	Pass
	1909.8	26.15	Vertical	Pass



Radiated Power (E.I.R.P) for GPRS 1900 MHZ				
Mode	Frequency	Result		Conclusion
		Max. Peak E.I.R.P.(dBm)	Polarization Of Max. E.I.R.P.	
GPRS 1900	1850.2	26.54	Horizontal	Pass
	1850.2	26.12	Vertical	Pass
	1880.0	26.41	Horizontal	Pass
	1880.0	25.37	Vertical	Pass
	1909.8	25.24	Horizontal	Pass
	1909.8	25.31	Vertical	Pass

Radiated Power (E.I.R.P) for UMTS band II				
Mode	Frequency	Result		Conclusion
		Max. Peak E.I.R.P.(dBm)	Polarization Of Max. E.I.R.P.	
HSDPA	1852.4	21.42	Horizontal	Pass
	1852.4	22.01	Vertical	Pass
	1880.0	21.34	Horizontal	Pass
	1880.0	22.33	Vertical	Pass
	1907.6	22.21	Horizontal	Pass
	1907.6	21.89	Vertical	Pass

Radiated Power (E.I.R.P) for UMTS band V				
Mode	Frequency	Result		Conclusion
		Max. Peak E.I.R.P.(dBm)	Polarization Of Max. E.I.R.P.	
HSDPA	826.4	19.35	Horizontal	Pass
	826.4	20.16	Vertical	Pass
	836.6	20.09	Horizontal	Pass
	836.6	20.31	Vertical	Pass
	846.6	19.96	Horizontal	Pass
	846.6	20.62	Vertical	Pass

NOTE 1: in the part, result the worst case GPRS 1slot for GSM 850 and GSM1900, and RMC 12.2kbps for band II and band v.

## 6. SPURIOUS EMISSION

### 6.1 CONDUCTED SPURIOUS EMISSION

#### 6.1.1 MEASUREMENT METHOD

The following steps outline the procedure used to measure the conducted emissions from the EUT.

1, Determine frequency range for measurements: From CFR 2.1057 the spectrum should be investigated from the lowest radio frequency generated in the equipment up to at least the 10th harmonic of the carrier frequency. For the equipment of GSM1900 band, this equates to a frequency range of 30 MHz to 19.1 GHz, data taken from 30 MHz to 20 GHz. For GSM850, data taken from 30 MHz to 9 GHz.

2, Determine EUT transmit frequencies: the following typical channels were chosen to conducted emissions testing.

Typical Channels for testing of GSM/GPRS 850 MHz	
Channel	Frequency (MHz)
128	824.2
190	836.6
251	848.8

Typical Channels for testing of GSM/ GPRS 1900 MHz	
Channel	Frequency (MHz)
512	1850.2
661	1880.0
810	1909.8

Typical Channels for testing of UMTS band II	
Channel	Frequency (MHz)
9262	1852.4
9400	1880.0
9538	1907.6

Typical Channels for testing of UMTS band V	
Channel	Frequency (MHz)
4132	826.4
4183	836.6
4233	846.6

### 6.1.2 PROVISIONS APPLICABLE

On any frequency outside frequency band of the USGSM spectrum, the power of any emission shall be attenuated below the transmitter power (P, in Watts) by at least  $43+10\log(P)$  dB. For all power levels +30 dBm to 0 dBm, this becomes a constant specification limit of -13 dBm.

### 6.1.3 MEASUREMENT RESULT

**PLEASE REFER TO : APPENDIX I TEST PLOTS FOR CONDUCTED SPURIOUS EMISSION**

- Note:**
1. Below 30MHZ no Spurious found and The GSM modes is the worst condition.
  2. As no emission found in standby or receive mode, no recording in this report.

## 6.2 Radiated Spurious Emission

### 6.2.1 MEASUREMENT METHOD

The measurements procedures specified in TIA-603D-2004 were used for testing. The spectrum was scanned from 30 MHz to the 10th harmonic of the highest frequency generated within the equipment. The resolution bandwidth is set 1MHz as outlined in Part 24.238. The measurements were performed on all modes(GPRS850, GPRS1900, HSDPA band V) at 3 typical channels(the Top Channel, the Middle Channel and the Bottom Channel) for each band.Only shown the worst data.

The procedure of radiated spurious emissions is as follows:

a) Pre-calibration With pre-calibration method, the Radiated Spurious Emissions(RSE) is calculated as,  $RSE = Rx \text{ (dBuV)} + CL \text{ (dB)} + SA \text{ (dB)} + Gain \text{ (dBi)} - 107 \text{ (dBuV to dBm)}$  The SA is calibrated using following setup.

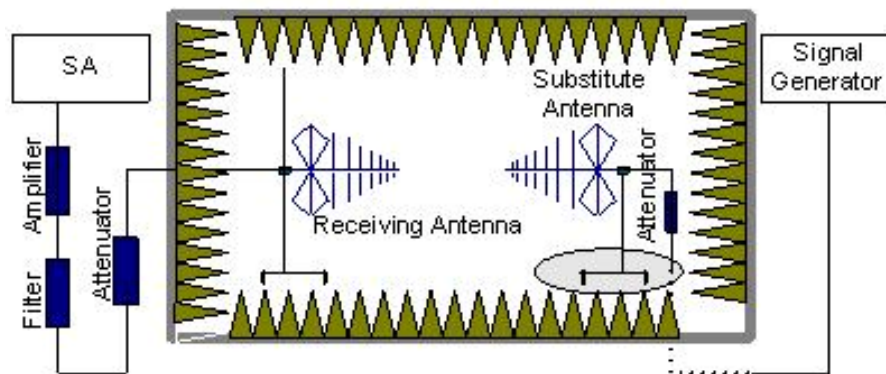

b) EUT was placed on a 0.8 meter high non-conductive stand at a 3 meter test distance from the receive antenna. A receiving antenna was placed on the antenna mast 3 meters from the test item for emission measurements. The height of receiving antenna is 0.8m. The test setup refers to figure below. Detected emissions were maximized at each frequency by rotating the test item and adjusting the receiving antenna polarization. The radiated emission measurements of all non-harmonic and harmonics of the transmit frequency through the 10th harmonic were measured with peak detector and 1MHz bandwidth.

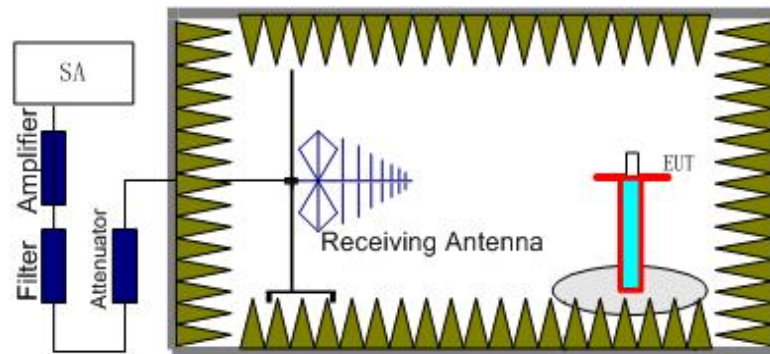

Radiated emissions measurements were made only at the upper, middle, and lower carrier frequencies of the GSM 1900 band (1850.2 MHz, 1880 MHz and 1909.8 MHz) ,GSM850 band (824.2MHz, 836.6MHz, 848.8MHz), UMTS band II(1852.4MHz, 1880MHz, 1907.6MHz), UMTS band V(826.4MHz, 835.0MHz, 846.6MHz) . It was decided that measurements at these three carrier frequencies would be sufficient to demonstrate compliance with emissions limits because it was seen that all the significant spurs occur well outside the band and no radiation was seen from a carrier in one block of any band into any of the other blocks.

The substitution method is used. Substitution values at each frequency are measured before and saved to the test software. A "reference path loss" is established and the  $A_{Rpl}$  is the attenuation of "reference path loss", and including the gain of receive antenna, the gain of the preamplifier, the cable loss and the air loss. The measurement results are obtained as described below:  $Power = P_{Mea} + A_{Rpl}$

### 6.2.2 PROVISIONS APPLICABLE

(a) On any frequency outside a licensee's frequency block (e.g. A, D, B, etc.) within the USGSM spectrum, the power of any emission shall be attenuated below the transmitter power ( $P$ , in Watts) by at least  $43 + 10 \log(P)$  dB. The specification that emissions shall be attenuated below the transmitter power ( $P$ ) by at least  $43 + 10 \log(P)$  dB, translates in the relevant power range (1 to 0.001 W) to -13 dBm. At 1 W the specified minimum attenuation becomes 43 dB and relative to a 30 dBm (1 W) carrier becomes a limit of -13 dBm. At 0.001 W (0 dBm) the minimum attenuation is 13 dB, which again yields a limit of -13 dBm. In this way a translation of the specification from relative to absolute terms is carried out.

**Note:** only result the worst condition of each test mode:

**6.2.3 MEASUREMENT RESULT**

GSM 850:

<b>Test Results for Channel 128/824.2 MHz</b>					
Frequency(MHz)	Power(dBm)	A <sub>Rpl</sub> (dBm)	P <sub>Mea</sub> (dBm)	Limit (dBm)	Polarity
1648.4	-26.46	7.8	-18.66	-13.00	Vertical
1648.4	-33.18	7.8	-25.38	-13.00	Horizontal
2472.6	-28.46	11	-17.46	-13.00	Vertical
2472.6	-33.596	11	-22.596	-13.00	Horizontal
3296.8	-29.15	12.3	-16.85	-13.00	Horizontal
3296.8	-33.39	12.3	-21.09	-13.00	Vertical
<b>Test Results for Channel 190/836.6 MHz</b>					
1673.2	-26.59	8	-18.59	-13.00	Vertical
1673.2	-28.75	8	-20.75	-13.00	Horizontal
2509.8	-27.14	11.2	-15.94	-13.00	Vertical
2509.8	-27.49	11.2	-16.29	-13.00	Horizontal
3346.4	-28.83	12.6	-16.23	-13.00	Horizontal
3346.4	-33.51	12.6	-20.91	-13.00	Vertical
<b>Test Results for Channel 251/848.8 MHz</b>					
1697.6	-27.95	8.1	-19.85	-13.00	Vertical
1697.6	-36.48	8.1	-28.38	-13.00	Horizontal
2546.4	-27.67	11.69	-15.98	-13.00	Vertical
2546.4	-35.47	11.69	-23.78	-13.00	Horizontal
3395.2	-29.38	12.92	-16.46	-13.00	Horizontal
3395.2	-36.95	12.92	-24.03	-13.00	Vertical

GSM 1900:

<b>Test Results for Channel 512/1850.2MHz</b>					
Frequency(MHz)	Power(dBm)	A <sub>Rpl</sub> (dBm)	P <sub>Mea</sub> (dBm)	Limit (dBm)	Polarity
3700.4	-29.34	13.42	-15.92	-13.00	Horizontal
3700.4	-33.87	13.42	-20.45	-13.00	Vertical
5550.6	-34.75	17.12	-17.63	-13.00	Vertical
5550.6	-36.36	17.12	-19.24	-13.00	Horizontal
7400.8	-35.79	19.26	-16.53	-13.00	Horizontal
7400.8	-36.12	19.26	-16.86	-13.00	Vertical
<b>Test Results for Channel 661/1880.0MHz</b>					
3760	-32.65	13.76	-18.89	-13.00	Horizontal
3760	-35.98	13.76	-22.22	-13.00	Vertical
5640	-35.64	17.56	-18.08	-13.00	Vertical
5640	-44.12	17.56	-26.56	-13.00	Horizontal
7520	-38.83	19.6	-19.23	-13.00	Horizontal
7520	-37.49	19.6	-17.89	-13.00	Vertical
<b>Test Results for Channel 810/1909.8MHz</b>					
3819.6	-34.12	13.87	-20.25	-13.00	Horizontal
3819.6	-35.39	13.87	-21.52	-13.00	Vertical
5729.4	-39.83	17.66	-22.17	-13.00	Vertical
5729.4	-37.53	17.66	-19.87	-13.00	Horizontal
7639.2	-39.83	19.75	-20.08	-13.00	Horizontal
7639.2	-36.77	19.75	-17.02	-13.00	Vertical

UMTS band II:

<b>Test Results for Channel 9262/1852.4MHz</b>					
Frequency(MHz)	Power(dBm)	A <sub>Rpl</sub> (dBm)	P <sub>Mea</sub> (dBm)	Limit (dBm)	Polarity
3700.8	-33.65	13.42	-20.23	-13.00	Horizontal
3700.8	-34.76	13.42	-21.34	-13.00	Vertical
5551.2	-33.65	17.12	-16.53	-13.00	Vertical
5551.2	-37.34	17.12	-20.22	-13.00	Horizontal
<b>Test Results for Channel 9400/1880MHz</b>					
3760.00	-31.53	13.76	-17.77	-13.00	Horizontal
3760.00	-33.15	13.76	-19.39	-13.00	Vertical
5640.00	-36.67	17.56	-19.11	-13.00	Vertical
5640.00	-37.83	17.56	-20.27	-13.00	Horizontal
<b>Test Results for Channel 9538/1907.6MHz</b>					
3819.2	-31.65	13.87	-17.78	-13.00	Horizontal
3819.2	-33.54	13.87	-19.67	-13.00	Vertical
5728.8	-33.65	17.66	-15.99	-13.00	Vertical
5728.8	-37.65	17.66	-19.99	-13.00	Horizontal



UMTS band V:

Test Results for Channel 4233/846.6MHz					
Frequency(MHz)	Power(dBm)	A <sub>Rpl</sub> (dBm)	P <sub>Mea</sub> (dBm)	Limit ( dBm )	Polarity
1673.2	-24.76	8.1	-16.66	-13.00	Vertical
1673.2	-28.96	8.1	-20.86	-13.00	Horizontal
2509.8	-26.76	11.69	-15.07	-13.00	Horizontal
2509.8	-33.88	11.69	-22.19	-13.00	Vertical
3346.4	-32.58	12.92	-19.66	-13.00	Horizontal
3346.4	-45.79	12.92	-32.87	-13.00	Vertical
Test Results for Channel 4182/836.4MHz					
1672.8	-24.46	8	-16.46	-13.00	Vertical
1672.8	-29.49	8	-21.49	-13.00	Horizontal
2509.2	-23.67	11.2	-12.47	-13.00	Horizontal
2509.2	-28.14	11.2	-16.94	-13.00	Vertical
3345.6	-25.89	12.6	-13.29	-13.00	Horizontal
3345.6	-35.38	12.6	-22.78	-13.00	Vertical
Test Results for Channel 4132/826.4MHz					
1652.8	-26.87	7.8	-19.07	-13.00	Vertical
1652.8	-34.16	7.8	-26.36	-13.00	Horizontal
2479.2	-32.89	11	-21.89	-13.00	Horizontal
2479.2	-44.33	11	-33.33	-13.00	Vertical
3305.6	-37.59	12.3	-25.29	-13.00	Horizontal
3305.6	-44.32	12.3	-32.02	-13.00	Vertical

**Note:** Below 30MHZ no Spurious found.

## 7. FREQUENCY STABILITY

### 7.1 MEASUREMENT METHOD

In order to measure the carrier frequency under the condition of AFC lock, it is necessary to make measurements with the EUT in a "call mode". This is accomplished with the use of R&S CMU200 DIGITAL RADIO COMMUNICATION TESTER.

- 1 , Measure the carrier frequency at room temperature.
- 2 , Subject the EUT to overnight soak at -10°C.
- 3 , With the EUT, powered via nominal voltage, connected to the CMU200 and in a simulated call on channel 661 for GSM 1900 band , channel 190 for GSM 850 band, channel 9400 for UMTS band II and channel 4175 for UMTS band V measure the carrier frequency. These measurements should be made within 2 minutes of Powering up the EUT, to prevent significant self-warming.
- 4 , Repeat the above measurements at 10°C increments from -10°C to +50°C. Allow at least 1 1/2 hours at each temperature, unpowered, before making measurements.
- 5 , Re-measure carrier frequency at room temperature with nominal voltage. Vary supply voltage from minimum voltage to maximum voltage, in 0.1Volt increments re-measuring carrier frequency at each voltage. Pause at nominal voltage for 1 1/2 hours unpowered, to allow any self-heating to stabilize, before continuing.
- 6 , Subject the EUT to overnight soak at +50°C.
- 7 , With the EUT, powered via nominal voltage, connected to the CMU200 and in a simulated call on the centre channel, measure the carrier frequency. These measurements should be made within 2 minutes of Powering up the EUT, to prevent significant self-warming.
- 8 , Repeat the above measurements at 10°C increments from +50°C to -10°C. Allow at least 1 1/2 hours at each temperature, unpowered, before making measurements.
- 9 , At all temperature levels hold the temperature to +/- 0.5°C during the measurement procedure.

### 7.2 PROVISIONS APPLICABLE

#### 7.2.1 For Hand carried battery powered equipment

According to the JTC standard the frequency stability of the carrier shall be accurate to within 0.1 ppm of the received frequency from the base station. This accuracy is sufficient to meet Sec. 24.235, Frequency Stability. The frequency stability shall be sufficient to ensure that the fundamental emission stays within the authorized frequency block. As this transceiver is considered "Hand carried, battery powered equipment" Section 2.1055(d)(2) applies. This requires that the lower voltage for frequency stability testing be specified by the manufacturer. This transceiver is specified to operate with an input voltage of between 3.5VDC and 4.2VDC, with a nominal voltage of 3.7VDC. Operation above or below these voltage limits is prohibited by transceiver software in order to prevent improper operation as well as to protect components from overstress. These voltages represent a tolerance of -10 % and +12.5 %. For the purposes of measuring frequency stability these voltage limits are to be used.

### 7.2.2 For equipment powered by primary supply voltage

According to the JTC standard the frequency stability of the carrier shall be accurate to within 0.1 ppm of the received frequency from the base station. This accuracy is sufficient to meet Sec. 24.235, Frequency Stability. The frequency stability shall be sufficient to ensure that the fundamental emission stays within the authorized frequency block. For this EUT section 2.1055(d)(1) applies. This requires varying primary supply voltage from 85 to 115 percent of the nominal value for other than hand carried battery equipment, the normal environment temperature is 20°C.

### 7.3 MEASUREMENT RESULT

Frequency Error Against Voltage for GSM 850 band		
Voltage (V)	Frequency Error (Hz)	Frequency Error (ppm)
3.5	30	0.036
3.7	25	0.030
4.2	28	0.033

Frequency Error Against Temperature for GPRS 850 band		
Temperature (°C)	Frequency Error (Hz)	Frequency Error (ppm)
-10	45	0.054
0	36	0.043
10	32	0.038
20	31	0.037
30	34	0.041
40	35	0.042
50	42	0.050

Note: The EUT doesn't work below -10°C

Frequency Error Against Voltage for GSM 1900 band		
Voltage (V)	Frequency Error (Hz)	Frequency Error (ppm)
3.5	43	0.023
3.7	41	0.022
4.2	53	0.028

Frequency Error Against Temperature for GPRS 1900 band		
Temperature (°C)	Frequency Error (Hz)	Frequency Error (ppm)
-10	52	0.028
0	51	0.027
10	44	0.023
20	45	0.024
30	36	0.019
40	46	0.024
50	32	0.017

Note: The EUT doesn't work below -10°C

Frequency Error Against Voltage for UMTS band II		
Voltage (V)	Frequency Error (Hz)	Frequency Error (ppm)
3.5	49	0.026
3.7	42	0.022
4.2	44	0.023

Frequency Error Against Temperature for UMTS band II		
Temperature (°C)	Frequency Error (Hz)	Frequency Error (ppm)
-10	57	0.030
0	49	0.026
10	48	0.026
20	51	0.027
30	46	0.024
40	47	0.025
50	51	0.027

Note: The EUT doesn't work below -10°C

Frequency Error Against Voltage for UMTS band V		
Voltage (V)	Frequency Error (Hz)	Frequency Error (ppm)
3.5	38	0.020
3.7	37	0.020
4.2	36	0.019

Frequency Error Against Temperature for UMTS band V		
Temperature (°C)	Frequency Error (Hz)	Frequency Error (ppm)
-10	43	0.051
0	41	0.049
10	43	0.051
20	29	0.035
30	27	0.032
40	30	0.036
50	35	0.042

**Note:** The EUT doesn't work below -10°C

## 8. BANDWIDTH

### 8.1 APPLICABLE STANDARD

FCC §2.1049, §22.917, §22.905 and §24.238.

### 8.2 Test Procedure

1. The EUT was connected to Spectrum Analyzer and Base Station via power divider.
2. The 99% and 26 dB occupied bandwidth (BW) of the middle channel for the highest RF powers.
3. Details according with KDB 971168 section 4.1 & 4.2.

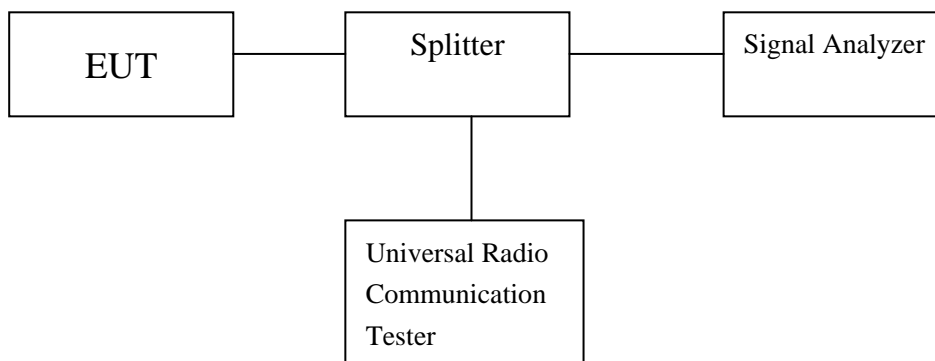

### Test Equipment List and Details

Refer a test equipment and calibration data table in this test report.

### 8.3 MEASUREMENT RESULT

Occupied Bandwidth (99%) for GPRS 850 band		
Mode	Frequency(MHz)	Occupied Bandwidth (99%)( kHz)
Low Channel	824.2	243.893
Middle Channel	836.6	249.669
High Channel	848.8	248.886

Occupied Bandwidth (99%) for GPRS1900 band		
Mode	Frequency(MHz)	Occupied Bandwidth (99%)( kHz)
Low Channel	1850.2	248.124
Middle Channel	1880.0	242.736
High Channel	1909.8	242.216

<b>Occupied Bandwidth (99%) for UMTS band II</b>		
Mode	Frequency(MHz)	Occupied Bandwidth (99%)( MHz)
Low Channel	1852.4	4.159
Middle Channel	1880.0	4.170
High Channel	1907.6	4.165

<b>Occupied Bandwidth (99%) for UMTS band V</b>		
Mode	Frequency(MHz)	Occupied Bandwidth (99%)( MHz)
Low Channel	826.4	4.164
Middle Channel	836.4	4.167
High Channel	846.6	4.176

<b>Emission Bandwidth (-26dBc) for GPRS850 band</b>		
Mode	Frequency(MHz)	Emission Bandwidth (-26dBc)( kHz)
Low Channel	824.2	322.634
Middle Channel	836.6	314.350
High Channel	848.8	320.652

<b>Emission Bandwidth (-26dBc) for GPRS1900 band</b>		
Mode	Frequency(MHz)	Emission Bandwidth (-26dBc)( kHz)
Low Channel	1850.2	322.226
Middle Channel	1880.0	324.770
High Channel	1909.8	311.889

<b>Emission Bandwidth (-26dBc) for UMTS band II</b>		
Mode	Frequency(MHz)	Emission Bandwidth (-26dBc)( MHz)
Low Channel	1852.4	4.712
Middle Channel	1880.0	4.689
High Channel	1907.6	4.715

<b>Emission Bandwidth (-26dBc) for UMTS band V</b>		
Mode	Frequency(MHz)	Emission Bandwidth (-26dBc)( MHz)
Low Channel	826.4	4.732
Middle Channel	836.4	4.731
High Channel	846.6	4.719

## 9. BAND EDGE

### 9.1 Applicable Standard

According to § 22.917(a), the power of any emissions outside of the authorized operating frequency ranges must be attenuated below the transmitting power (P) by a factor of at least  $43 + 10 \log(P)$  dB.

According to §24.238(a), the power of any emissions outside of the authorized operating frequency ranges must be attenuated below the transmitting power (P) by a factor of at least  $43 + 10 \log(P)$  dB.

### 9.2 Test Procedure

1. The EUT was connected to Spectrum Analyzer and Base Station via power divider.
2. The Band Edges of low and high channels for the highest RF powers were measured. Setting RBW as roughly BW/100.
3. Details according with KDB 971168 section 6.0.

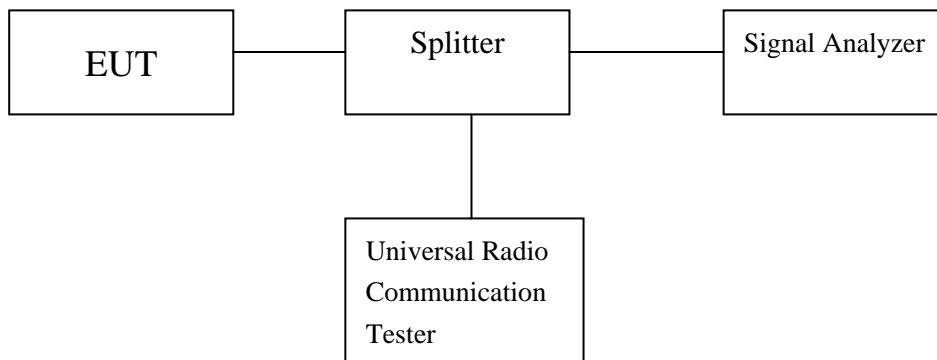

### Test Equipment List and Details

Refer a test equipment and calibration data table in this test report.

### 9.3 MEASUREMENT RESULT

Please refers to Appendix III for compliance test plots for band edges



## 10. Peak-to-Average Ratio

### DESCRIPTION OF THE PAR MEASUREMENT

The peak-to-average ratio (PAR) of the transmission may not exceed 13 dB.

#### 10.1 MEASURING INSTRUMENTS

See list of measuring instruments of this test report.

#### 10.2 TEST PROCEDURES

1. The EUT was connected to Spectrum Analyzer and Base Station via power divider.
2. The RF output of EUT was connected to the spectrum analyzer by RF cable and attenuator. The path loss was compensated to the results for each measurement.
3. For GSM/EGPRS operating modes:
  - a. Set the RBW = 1MHz, VBW = 1MHz, Peak detector in spectrum analyzer.
  - b. Set EUT in maximum power output, and triggered the burst signal.
  - c. Measured respectively the Peak level and Mean level, and the deviation was recorded as Peak to Average Ratio.
4. For UMTS operating modes:
  - a. Set the CCDF (Complementary Cumulative Distribution Function) option in spectrum analyzer.
  - b. The highest RF powers were measured and recorded the maximum PAPR level associated with a probability of 0.1 %.

#### 10.3 TEST SETUP

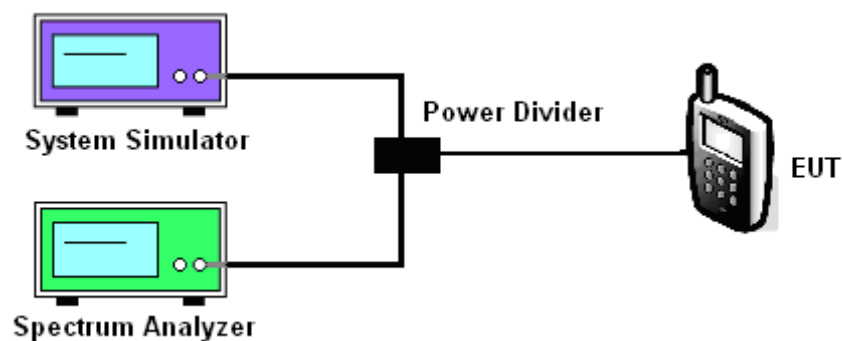

10.4 TEST RESULT OF PEAK-TO-AVERAGE RATIO

Cellular Band						
Modes	GSM850			GSM1900		
Channel	128 (Low)	190 (Mid)	251 (High)	512 (Low)	661 (Mid)	810 (High)
Frequency(MHz)	824.2	836.6	848.8	1850.2	1880	1909.8
Peak-to-Average Ratio (dB)	-0.001	-0.008	-0.012	-0.001	-0.004	-0.017
Cellular Band						
Modes	WCDMA Band II (RMC 12.2Kbps)			WCDMA Band V (RMC 12.2Kbps)		
Channel	9262 (Low)	9400 (Mid)	9538 (High)	4132 (Low)	4175 (Mid)	4233 (High)
Frequency(MHz)	1852.4	1880	1907.6	826.4	836.6	846.6
Peak-to-Average Ratio (dB)	-0.383	-0.358	-0.395	-0.477	-0.792	-1.720

**APPENDIX I**

**TEST PLOTS FOR CONDUCTED SPURIOUS EMISSION**

CONDUCTED EMISSION IN GSM 850 BAND  
 Conducted Emission Transmitting Mode CH 128 30MHz – 5GHz

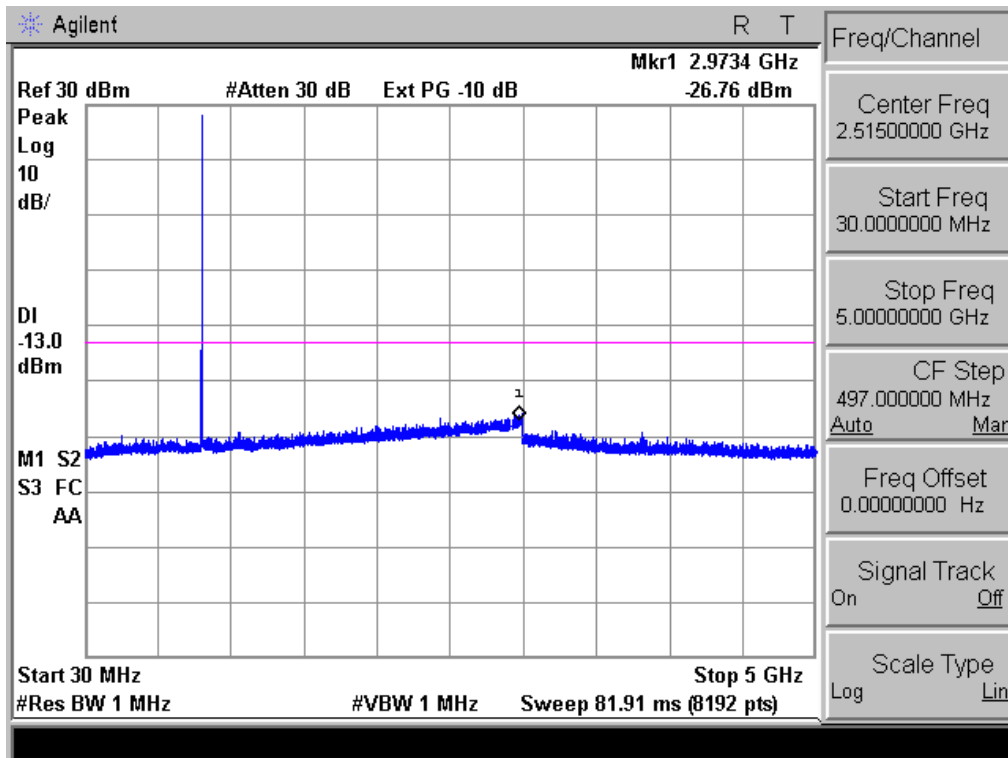

Conducted Emission Transmitting Mode CH 128 5GHz – 10GHz

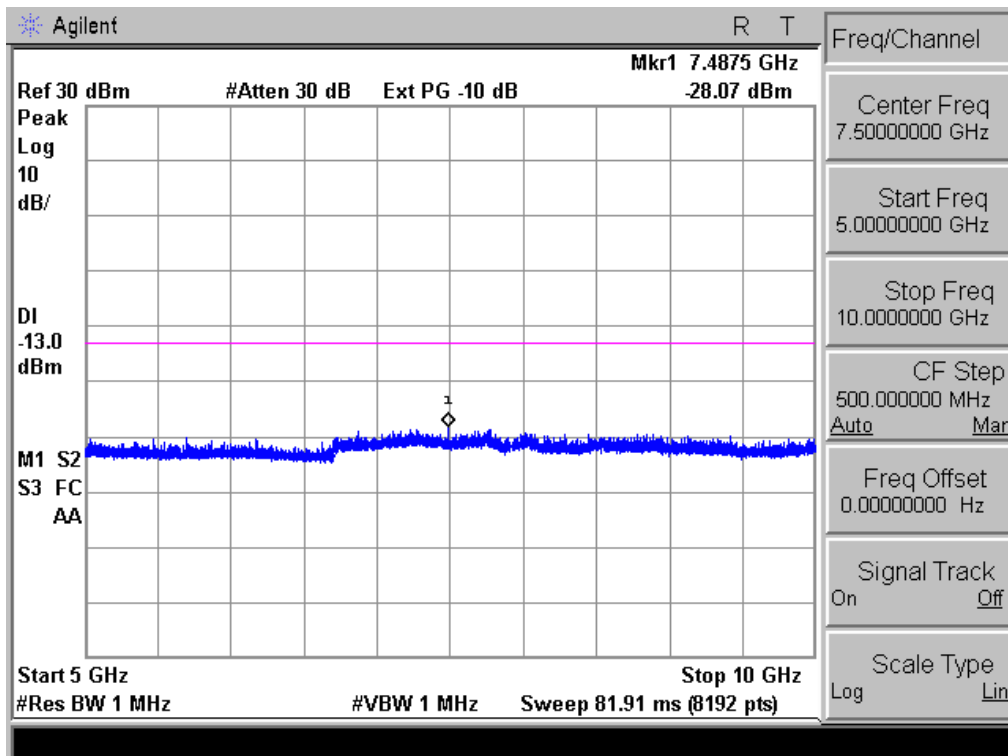

Conducted Emission Transmitting Mode CH 190 30MHz – 5GHz

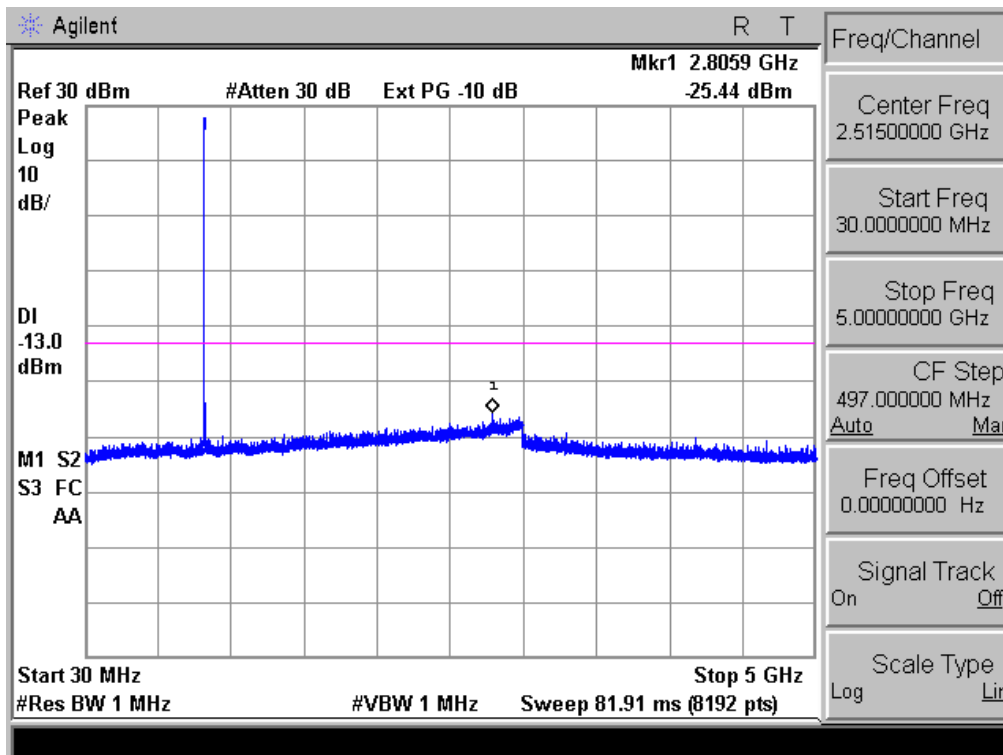

Conducted Emission Transmitting Mode CH 190 5GHz – 10GHz

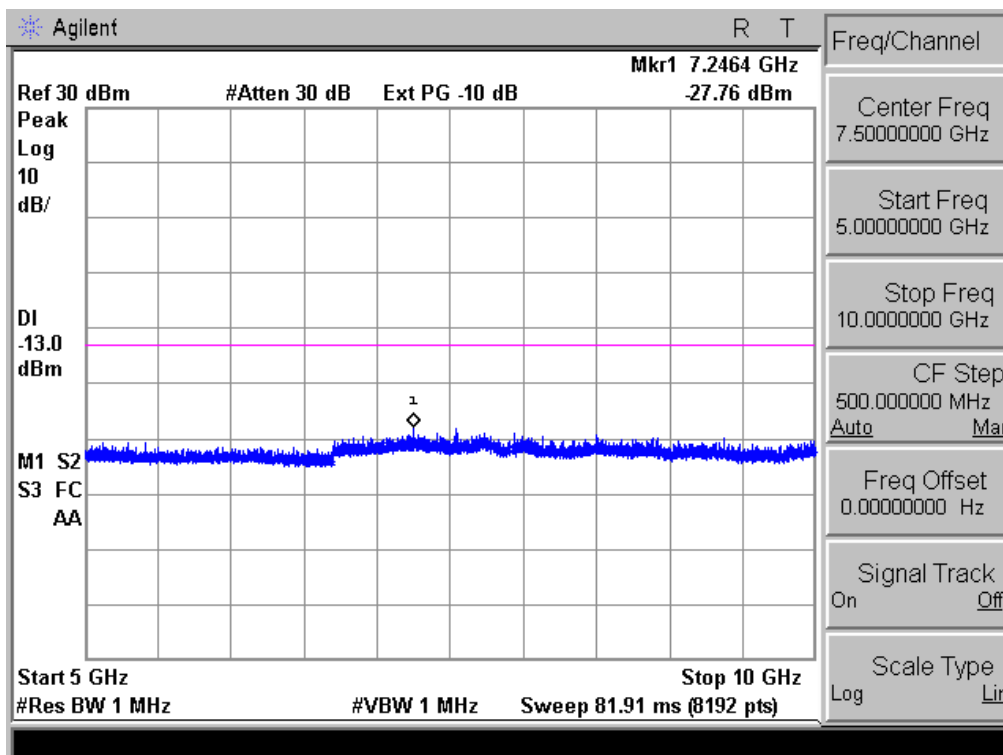

Conducted Emission Transmitting Mode CH 251 30MHz – 5GHz

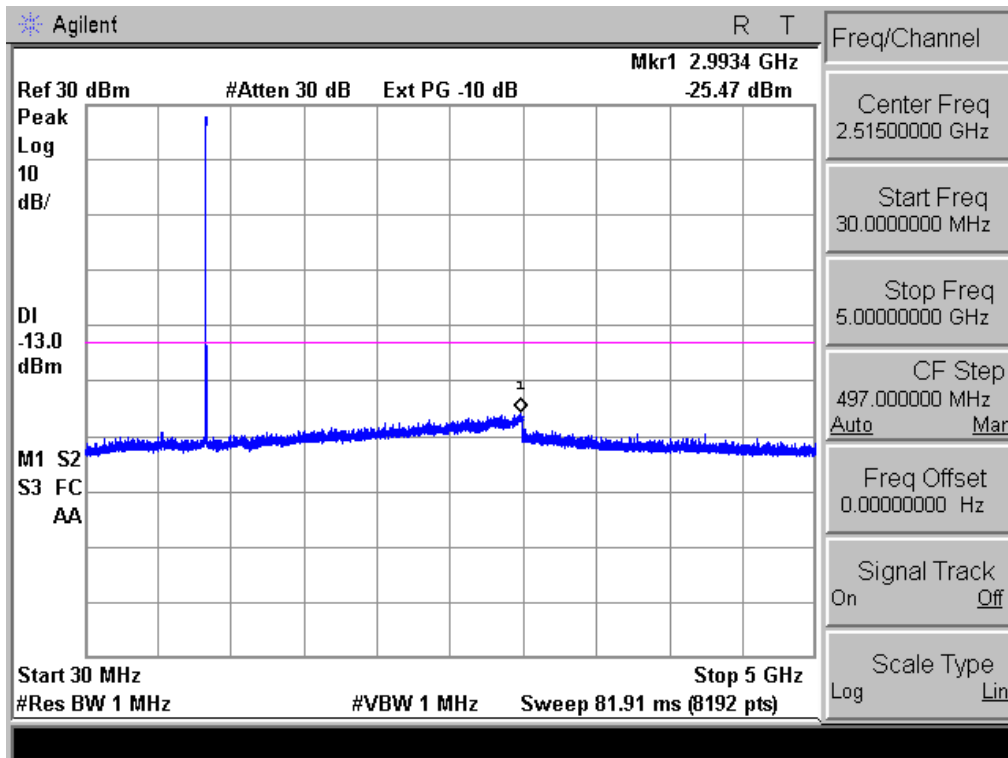

Conducted Emission Transmitting Mode CH 251 5GHz – 10GHz

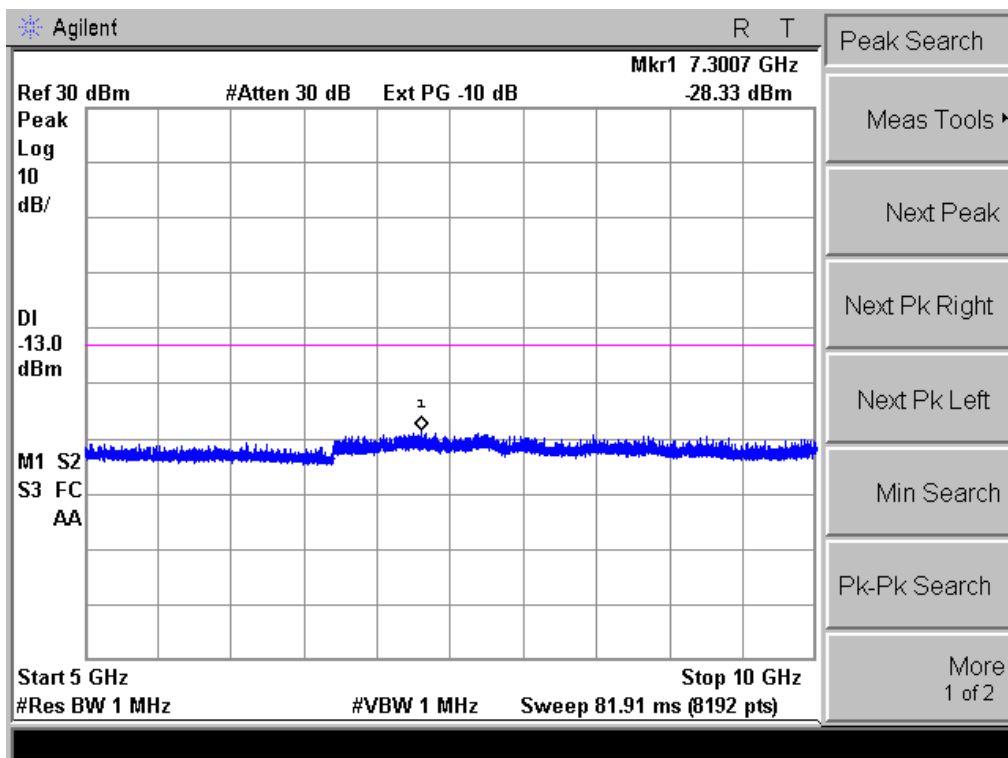

CONDUCTED EMISSION IN GSM1900 BAND  
 Conducted Emission Transmitting Mode CH 512 30MHz – 10GHz

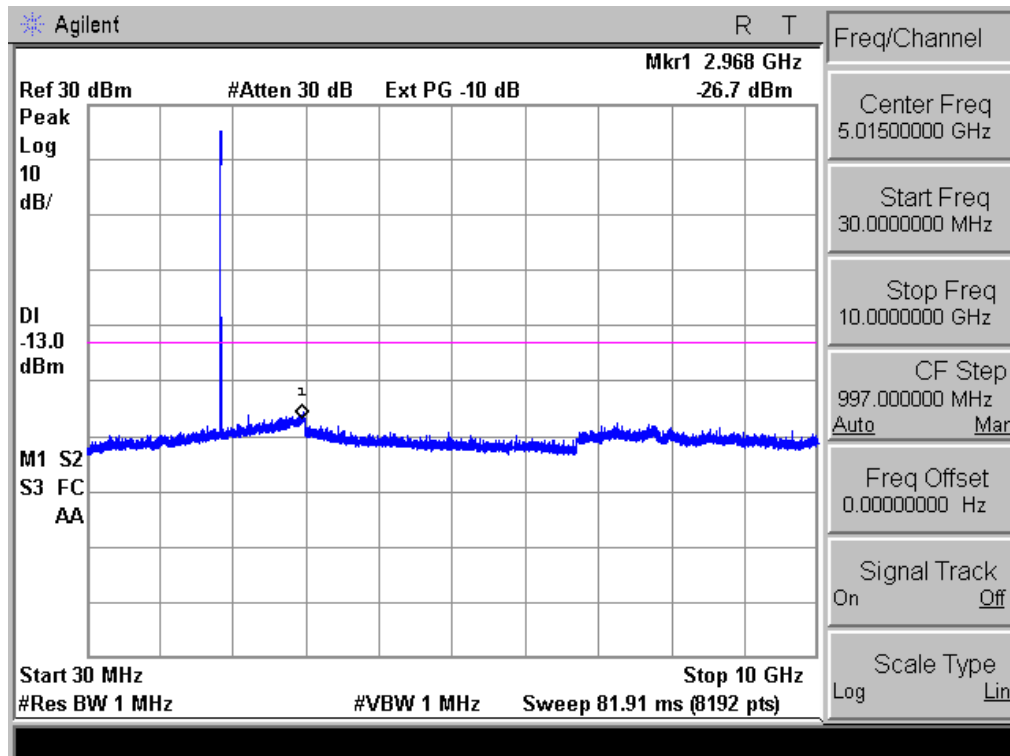

Conducted Emission Transmitting Mode CH 512 10GHz – 20GHz

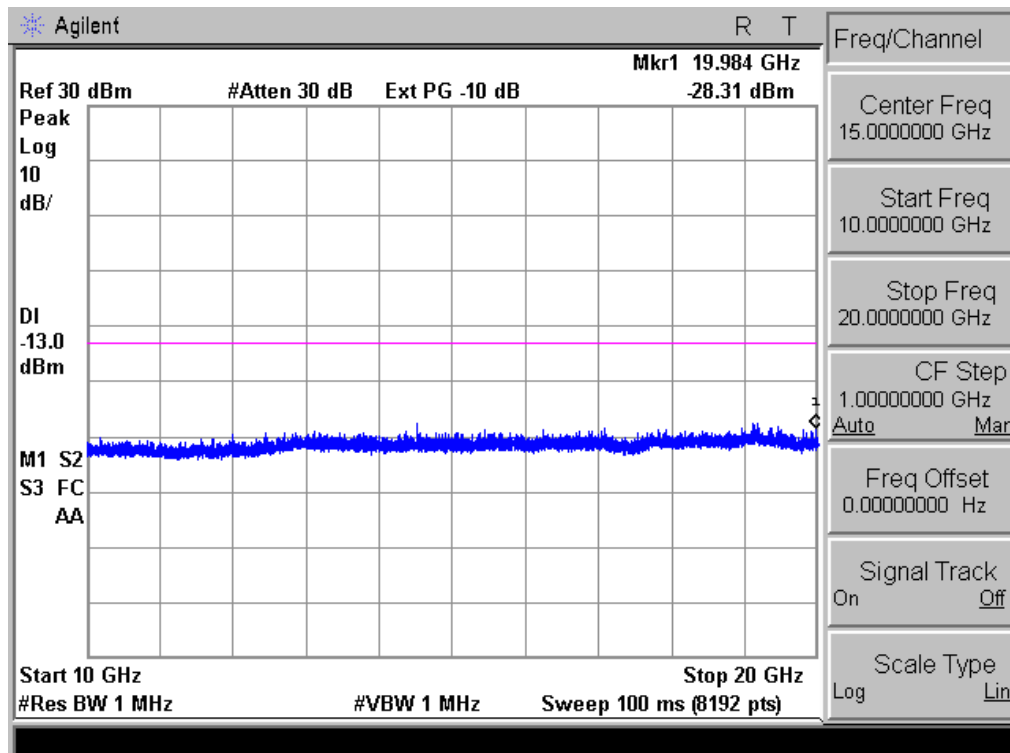

Conducted Emission Transmitting Mode CH 661 30MHz – 10GHz

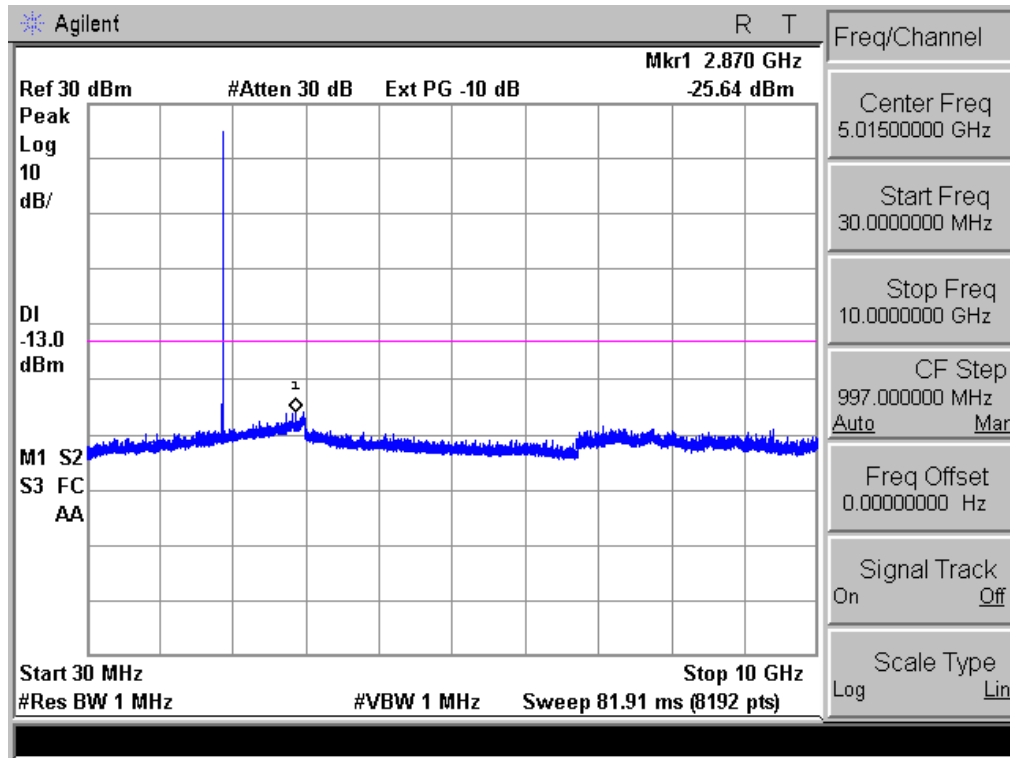

Conducted Emission Transmitting Mode CH 661 10GHz – 20GHz

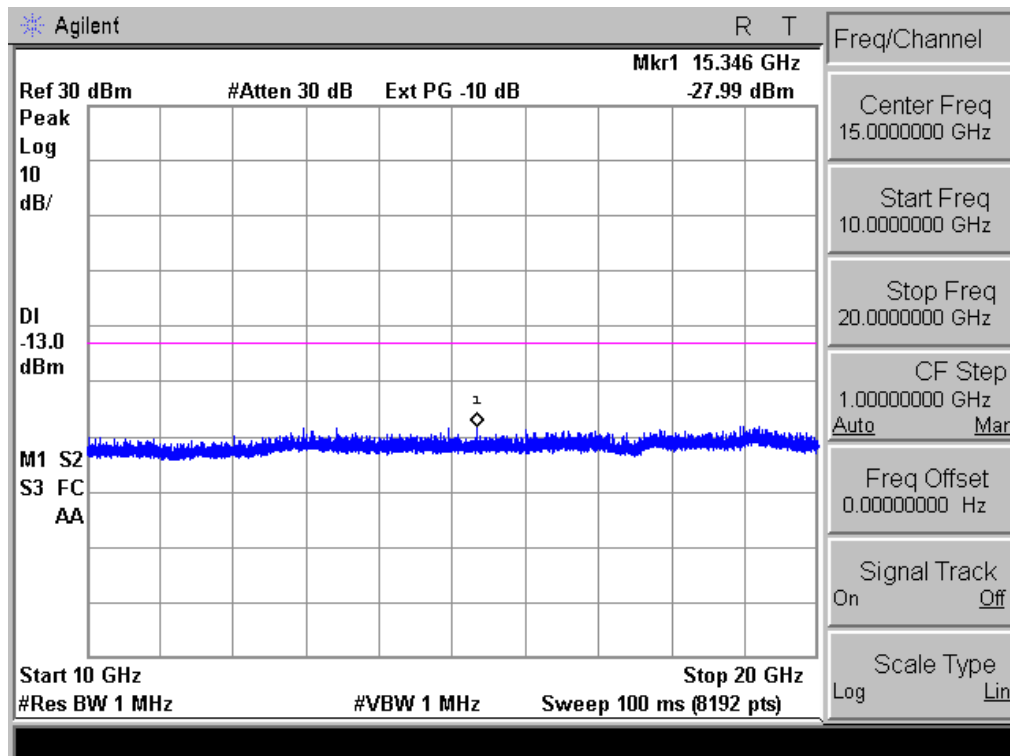



Conducted Emission Transmitting Mode CH 810 30MHz – 10GHz

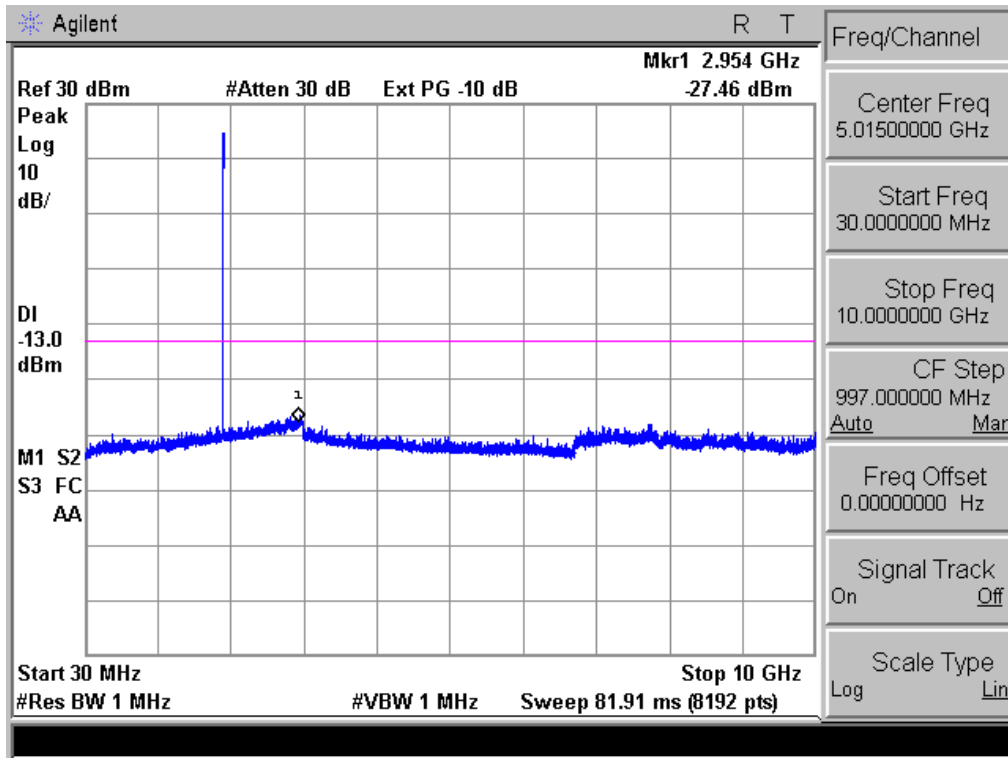

Conducted Emission Transmitting Mode CH 810 10GHz – 20GHz

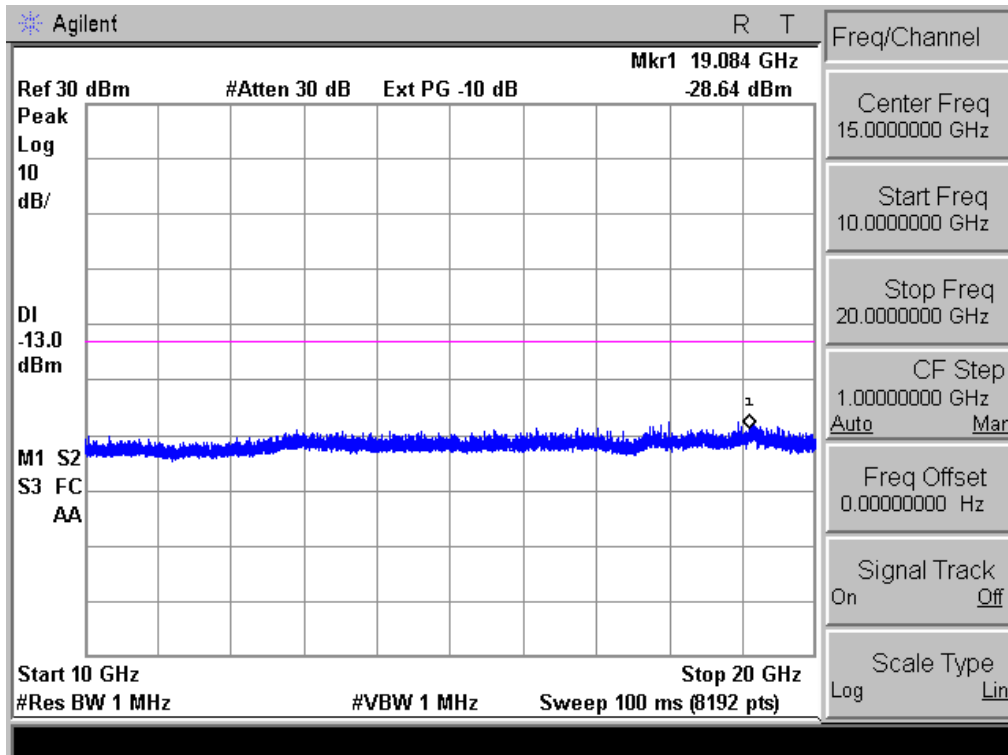

CONDUCTED EMISSION IN UMTS band II  
 Conducted Emission Transmitting Mode CH 9262 30MHz – 10GHz

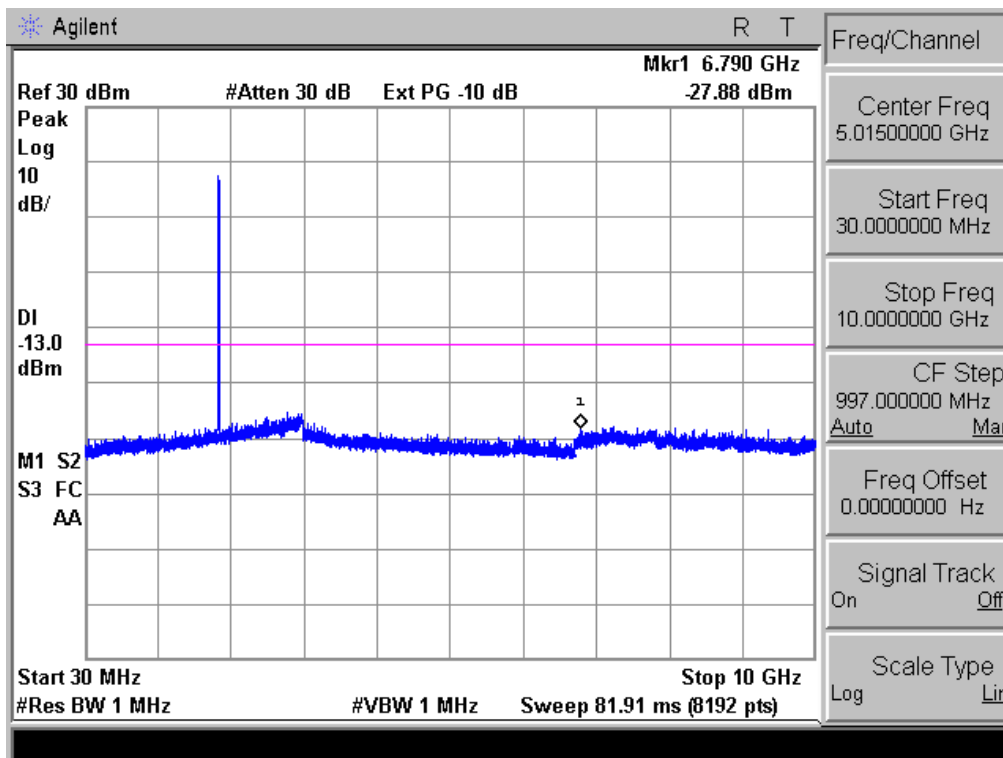

Conducted Emission Transmitting Mode CH 9262 10GHz – 20GHz

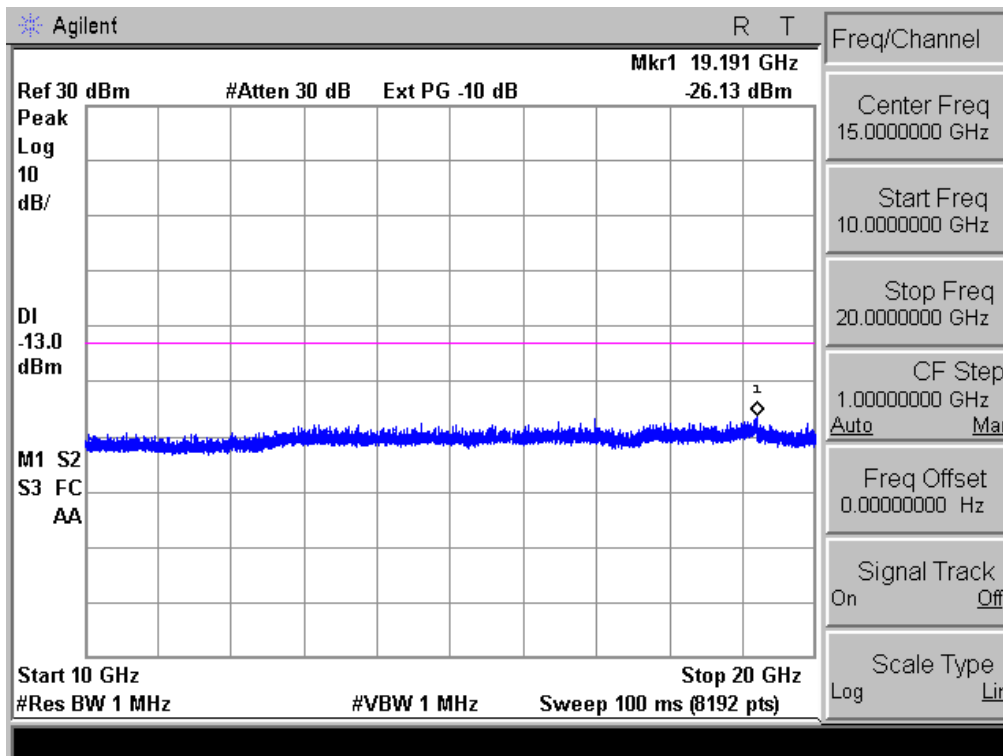

Conducted Emission Transmitting Mode CH 9400 30MHz – 10GHz

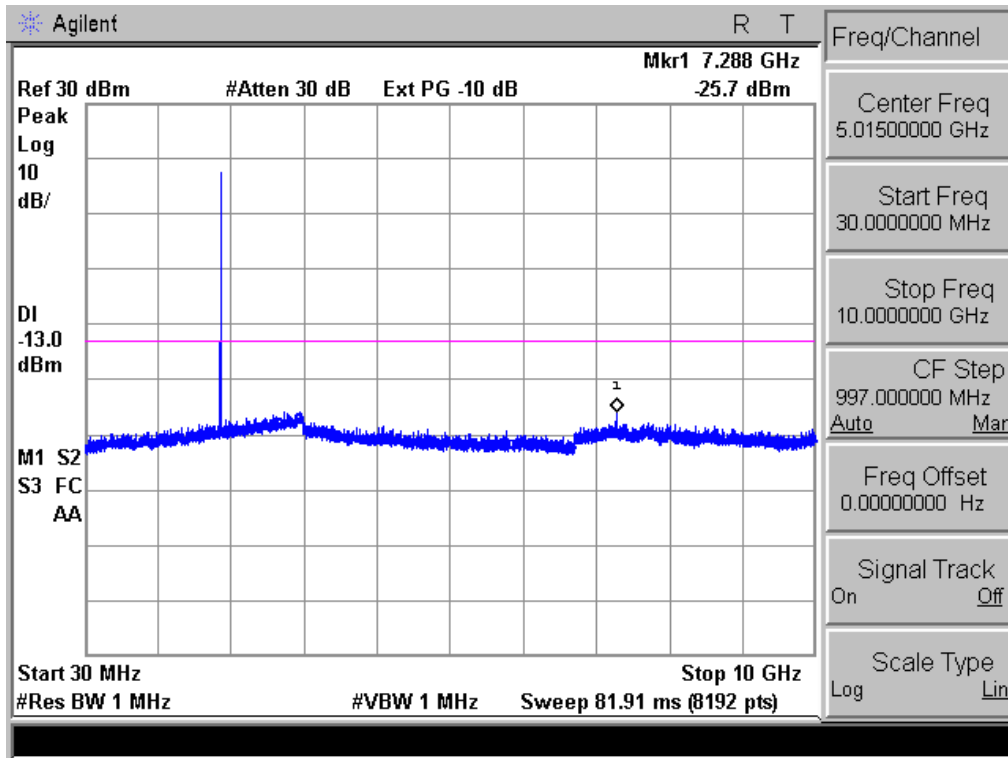

Conducted Emission Transmitting Mode CH 9400 10GHz – 20GHz

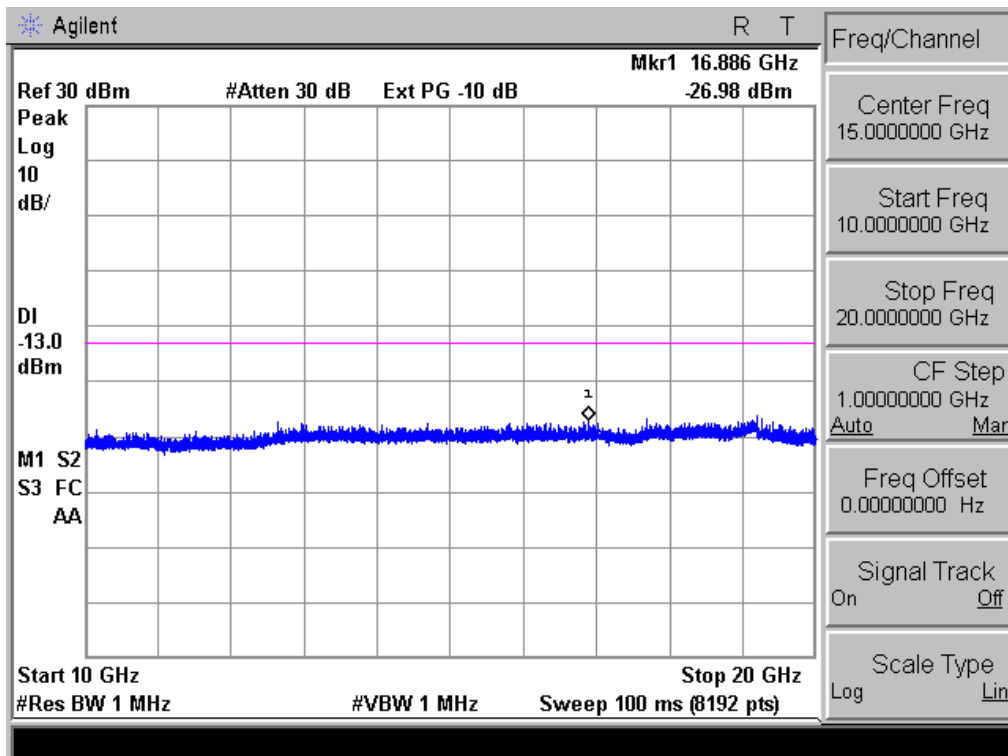

Conducted Emission Transmitting Mode CH 9538 30MHz – 10GHz

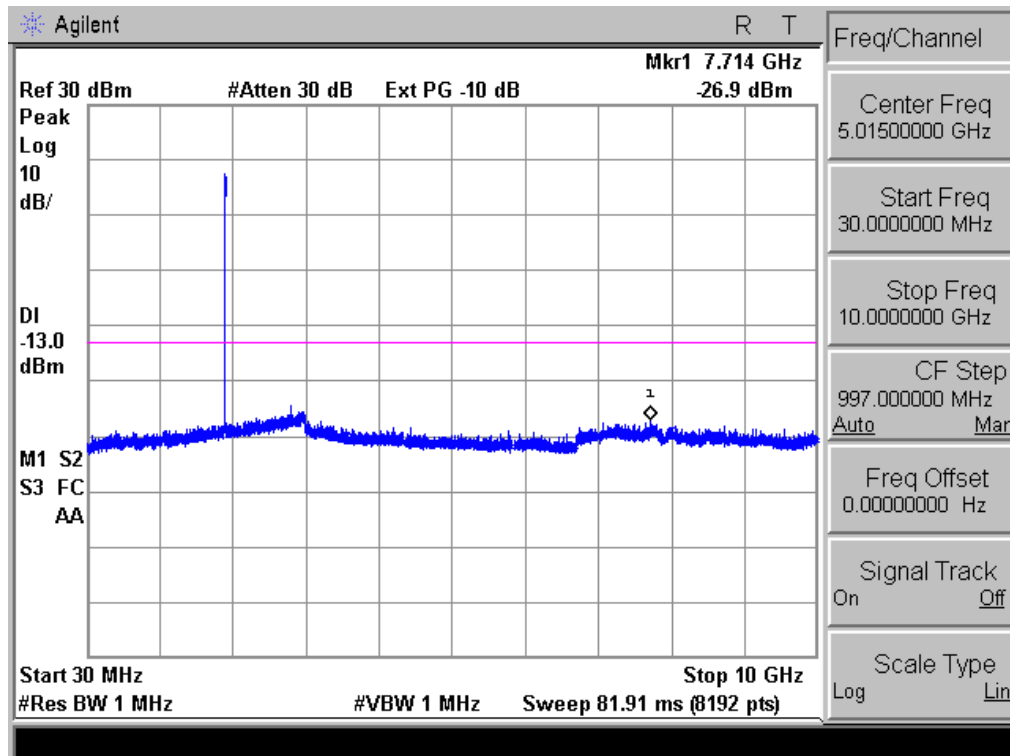

Conducted Emission Transmitting Mode CH 9538 10GHz – 20GHz

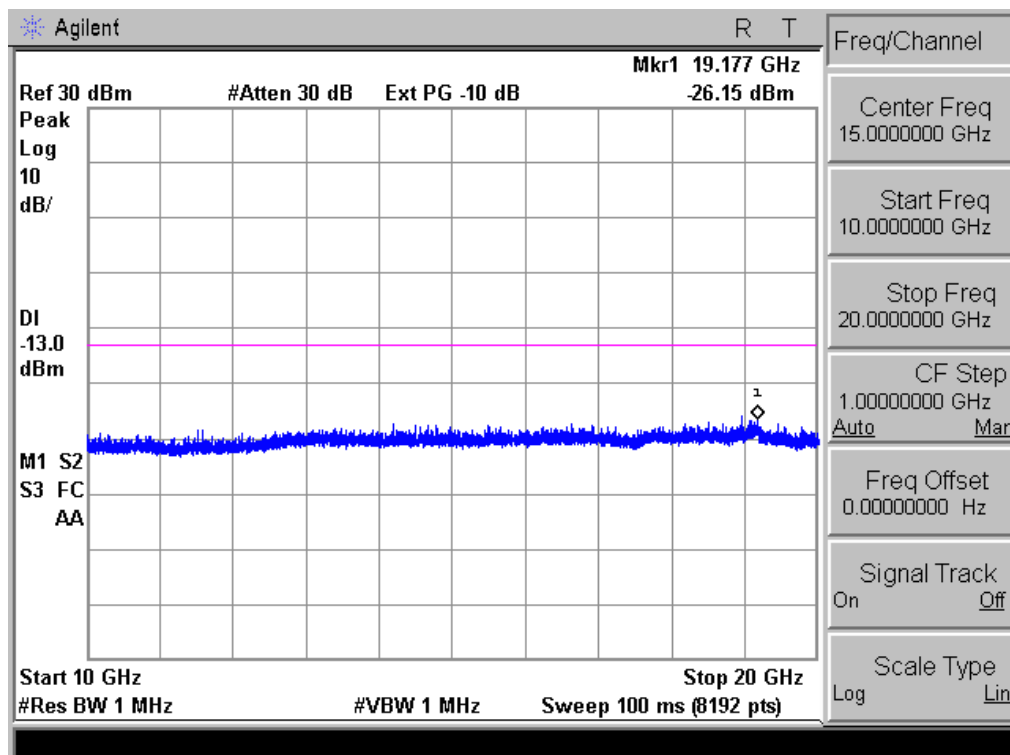

CONDUCTED EMISSION IN UMTS band V  
 Conducted Emission Transmitting Mode CH 4132 30MHz – 5GHz

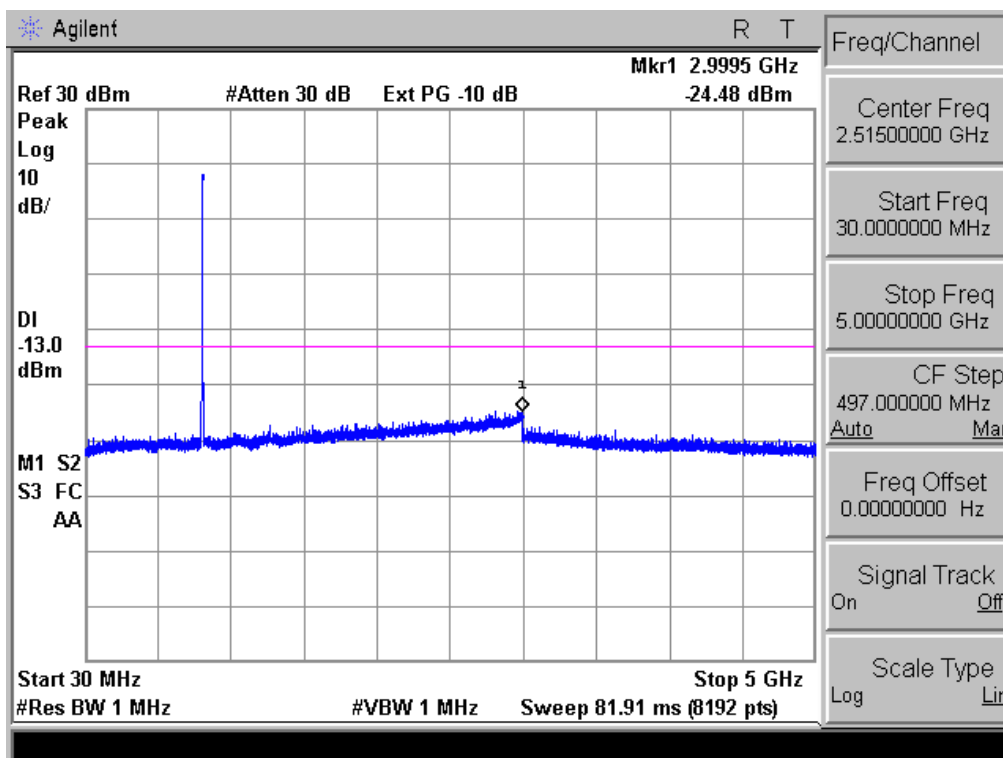

Conducted Emission Transmitting Mode CH 4132 5GHz – 10GHz

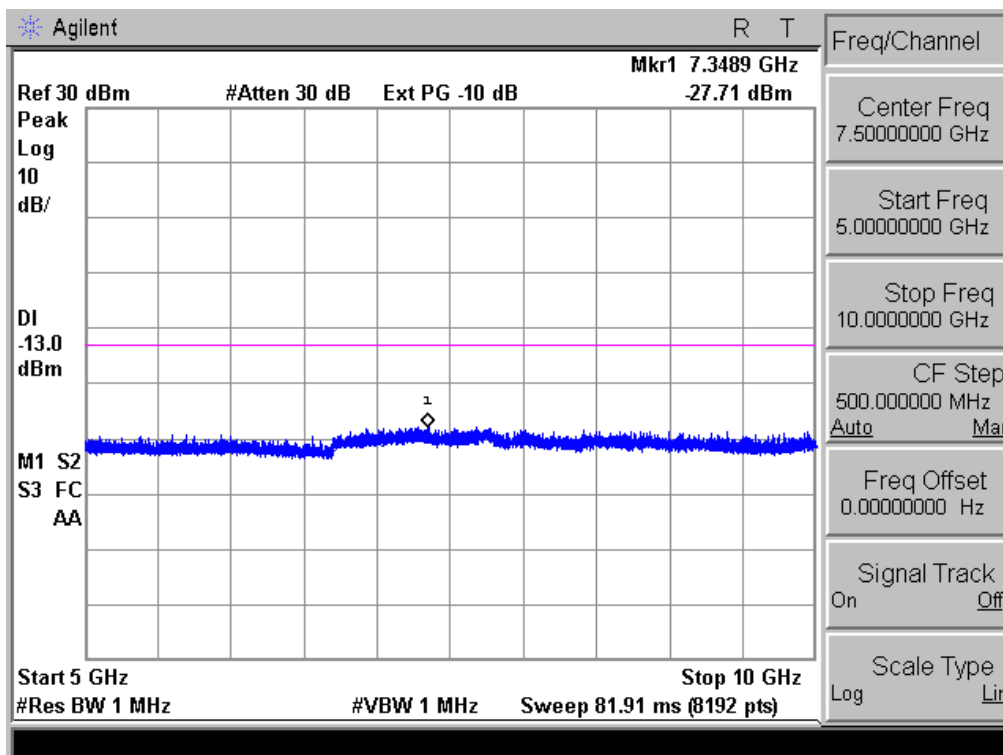

Conducted Emission Transmitting Mode CH 4183 30MHz –5GHz

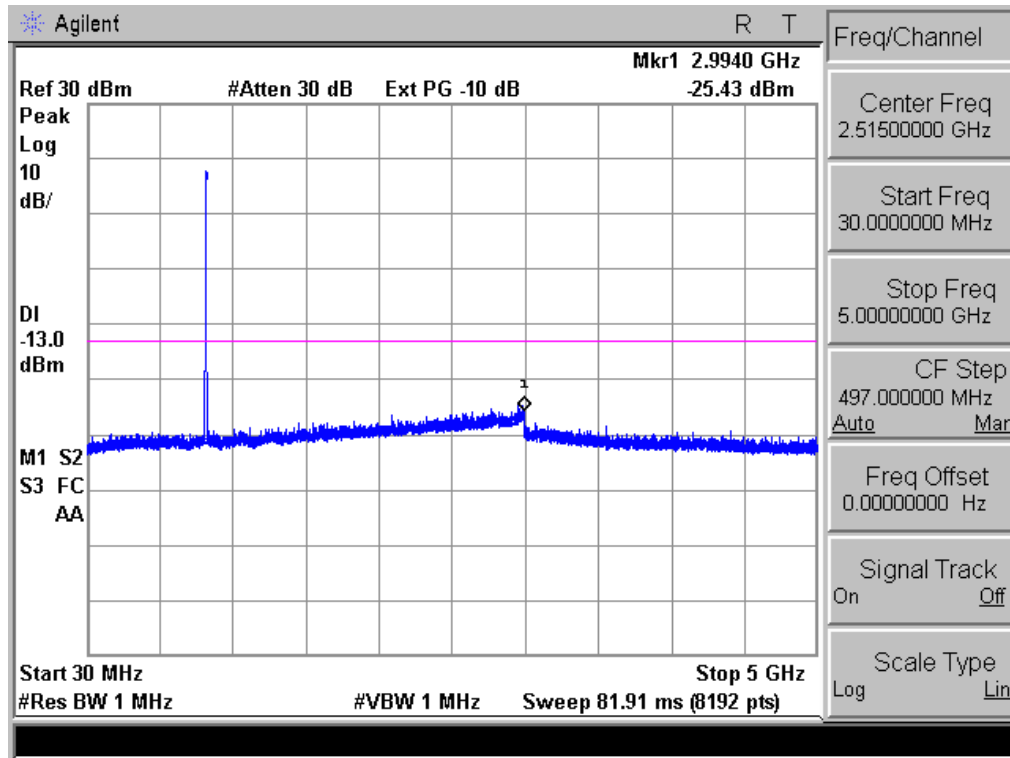

Conducted Emission Transmitting Mode CH 4183 5GHz – 10GHz

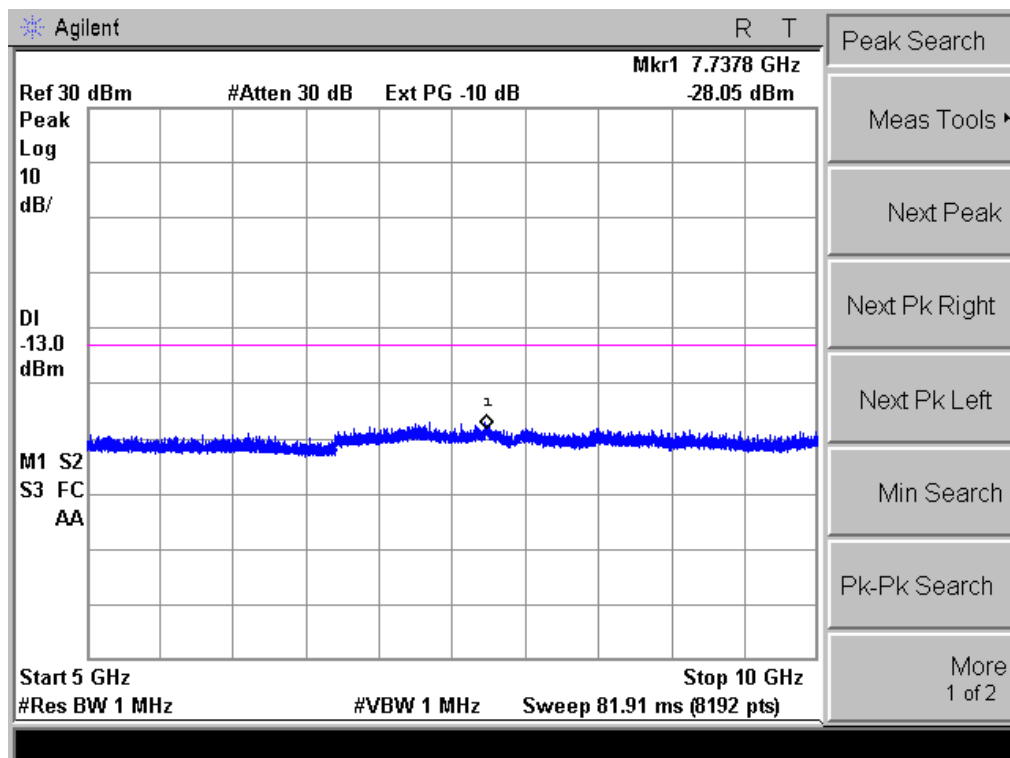

Conducted Emission Transmitting Mode CH 4233 30MHz – 5GHz

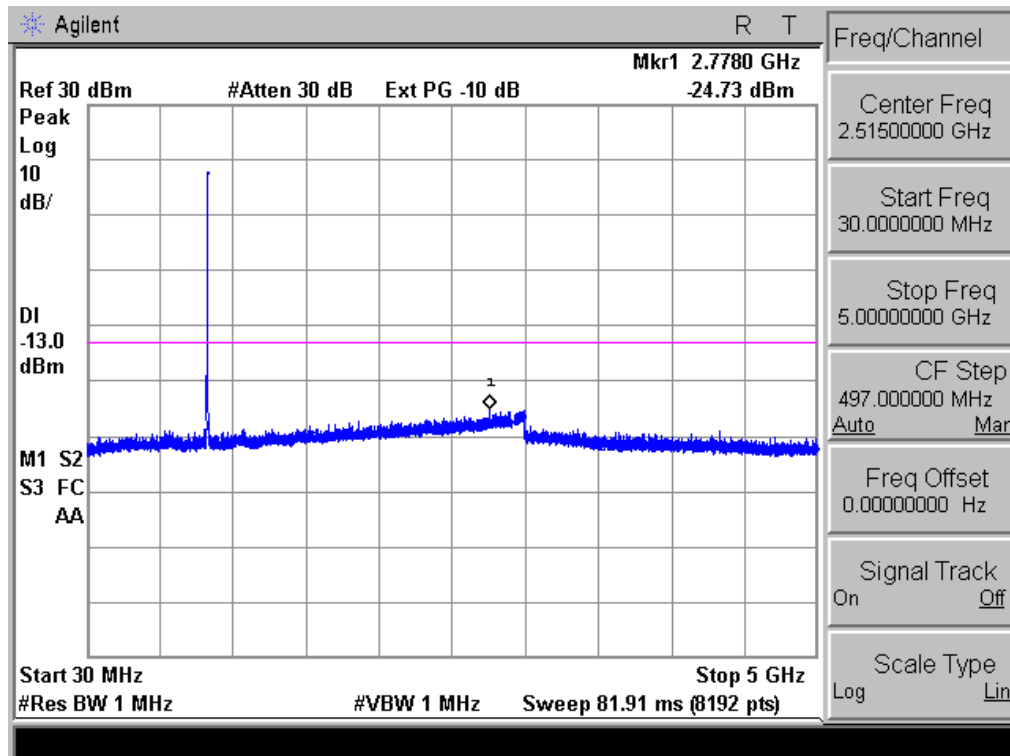

Conducted Emission Transmitting Mode CH 4233 5GHz – 10GHz

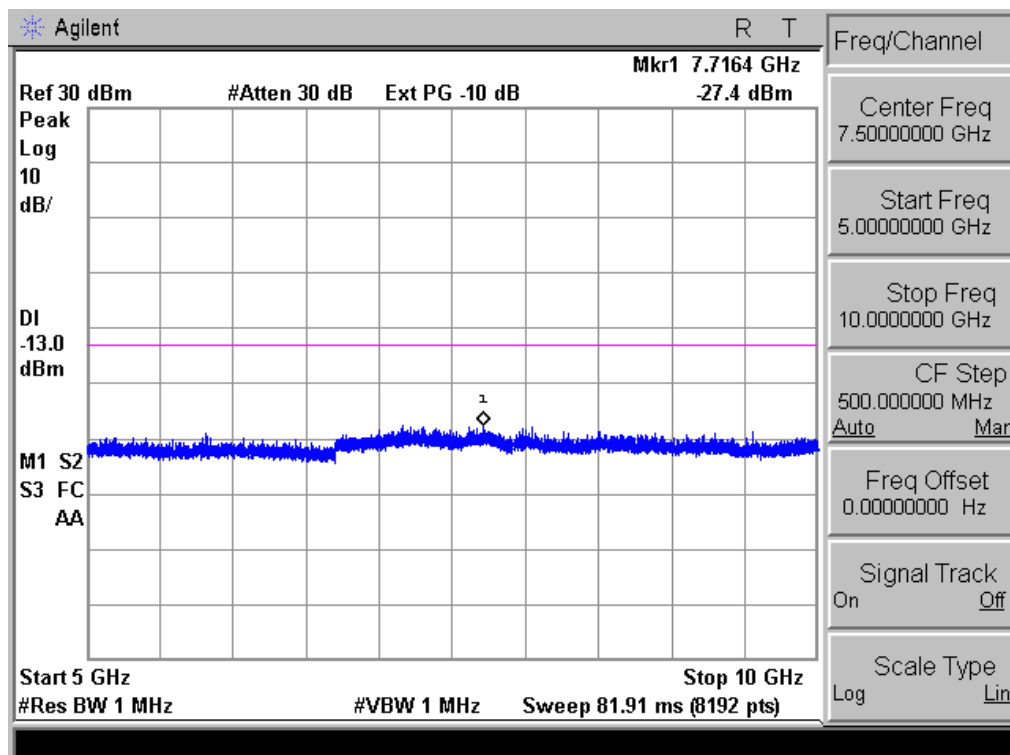

**APPENDIX II**

**TEST PLOTS FOR OCCUPIED BANDWIDTH (99%)**

**EMISSION BANDWIDTH (-26dBC)**



Occupied Bandwidth (99%) GSM 850 BAND CH 128

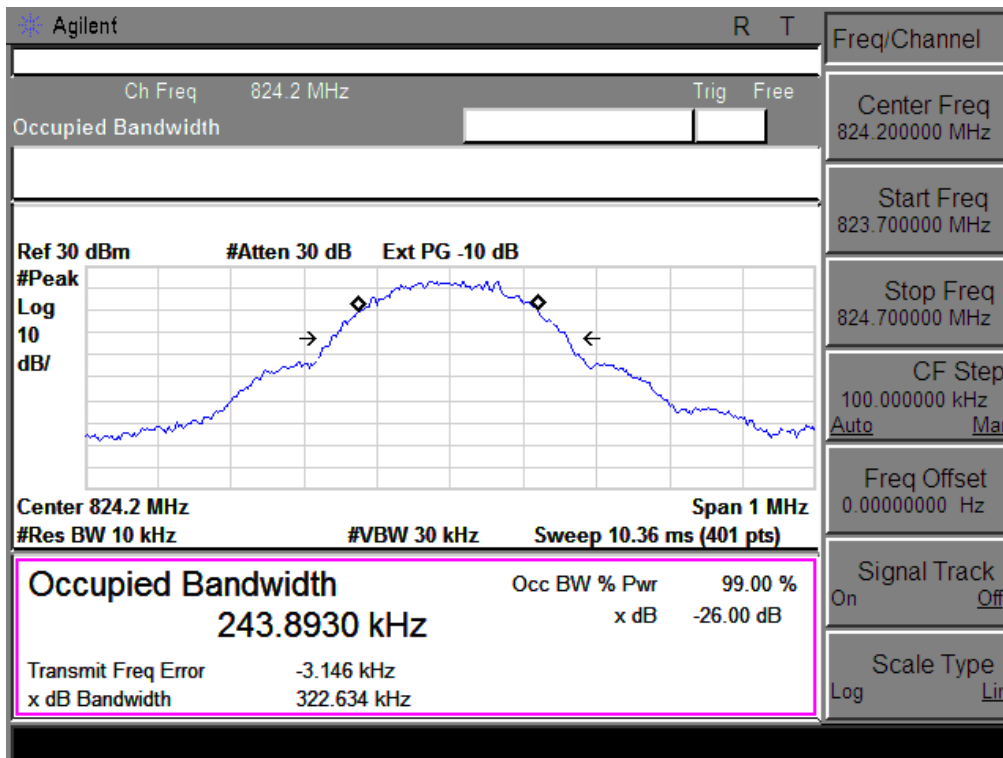

Occupied Bandwidth (99%) GSM 850 BAND CH 190

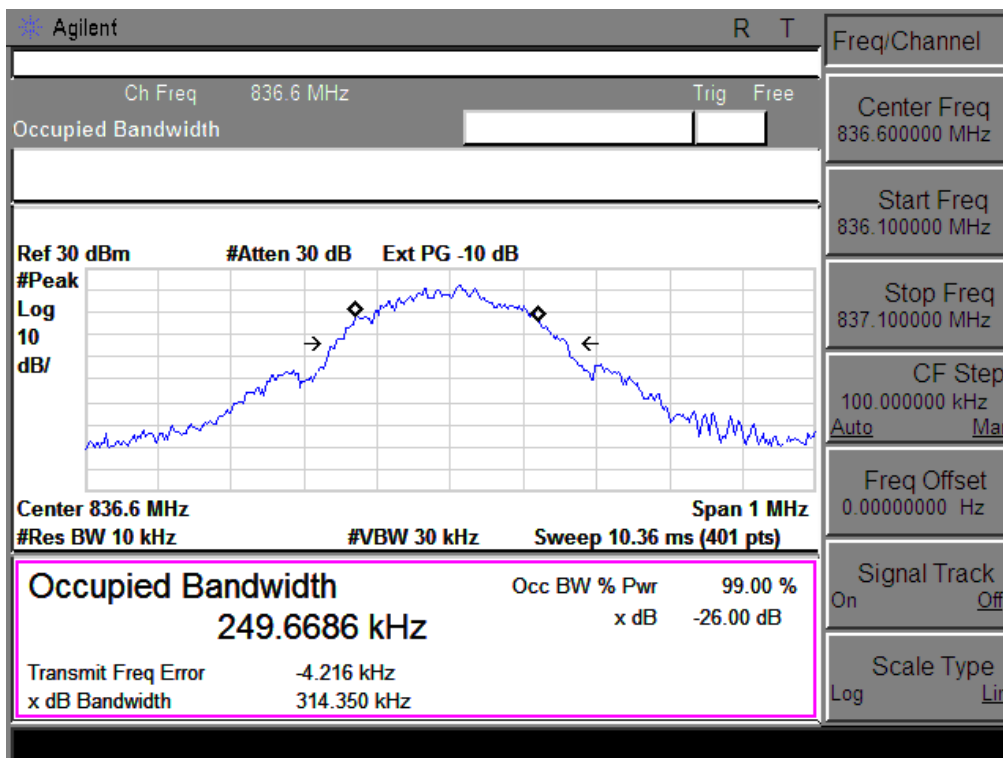

Occupied Bandwidth (99%) GSM 850 BAND CH 251

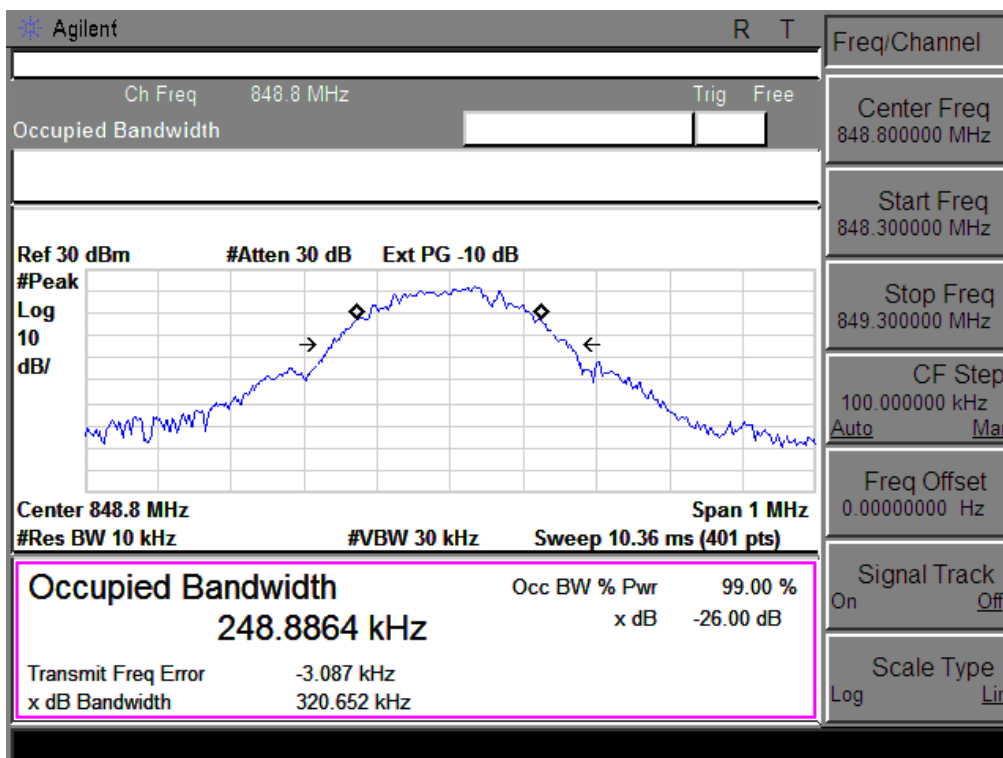

Occupied Bandwidth (99%) GSM 1900 BAND CH 512

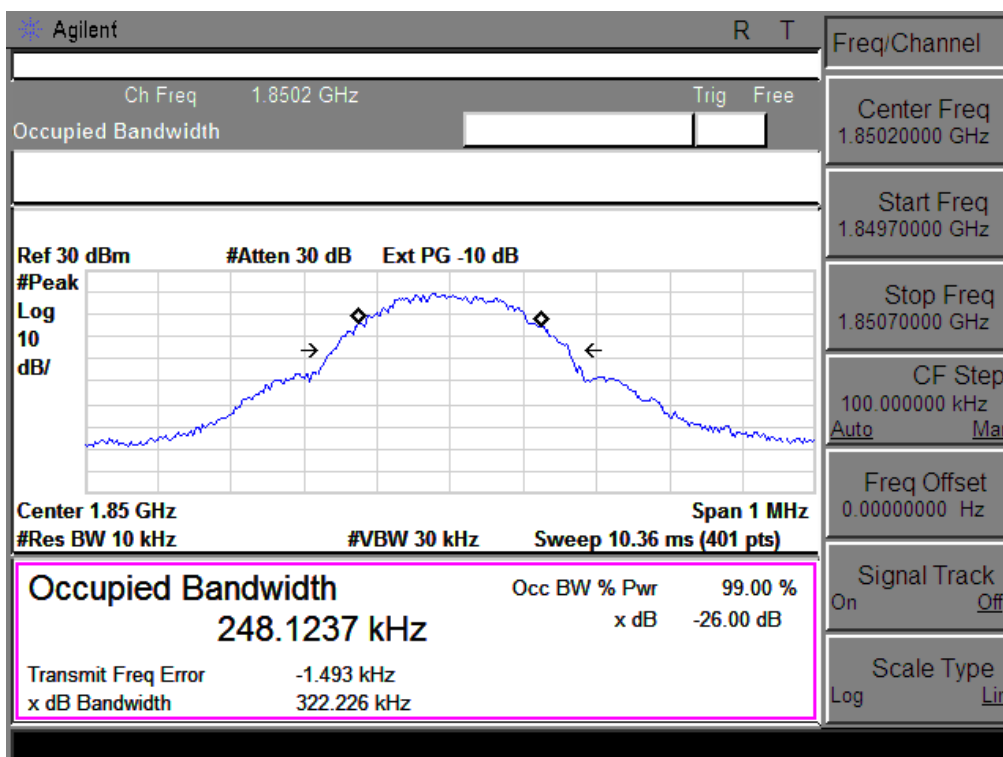

Occupied Bandwidth (99%) GSM 1900 BAND CH 661

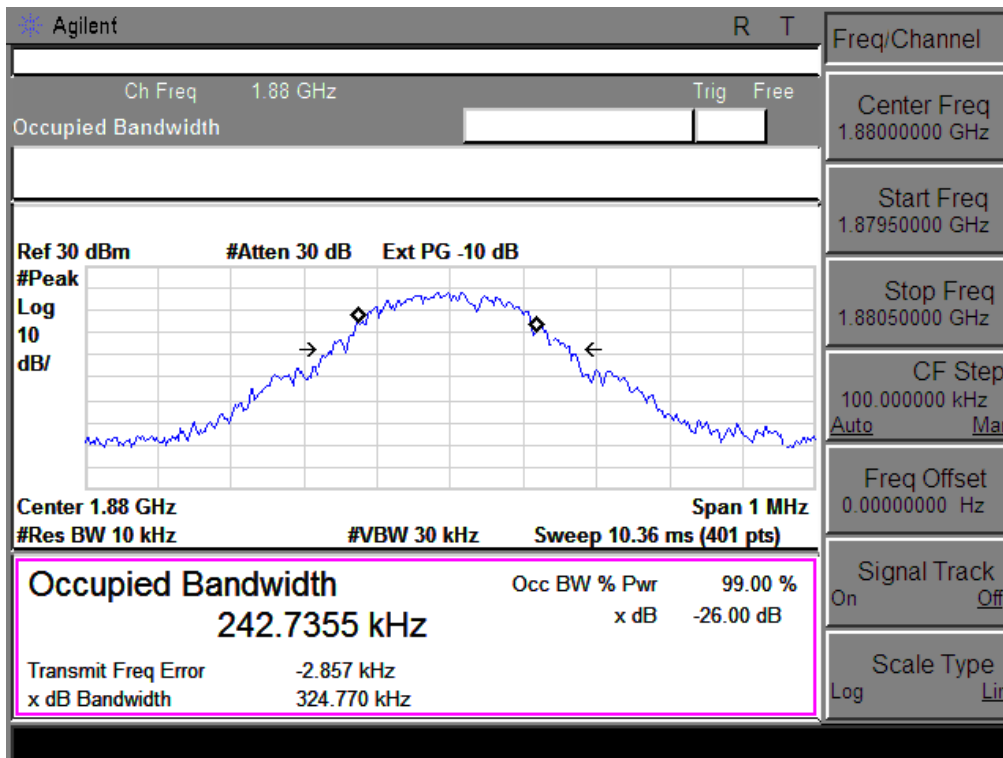

Occupied Bandwidth (99%) GSM 1900 BAND CH 810

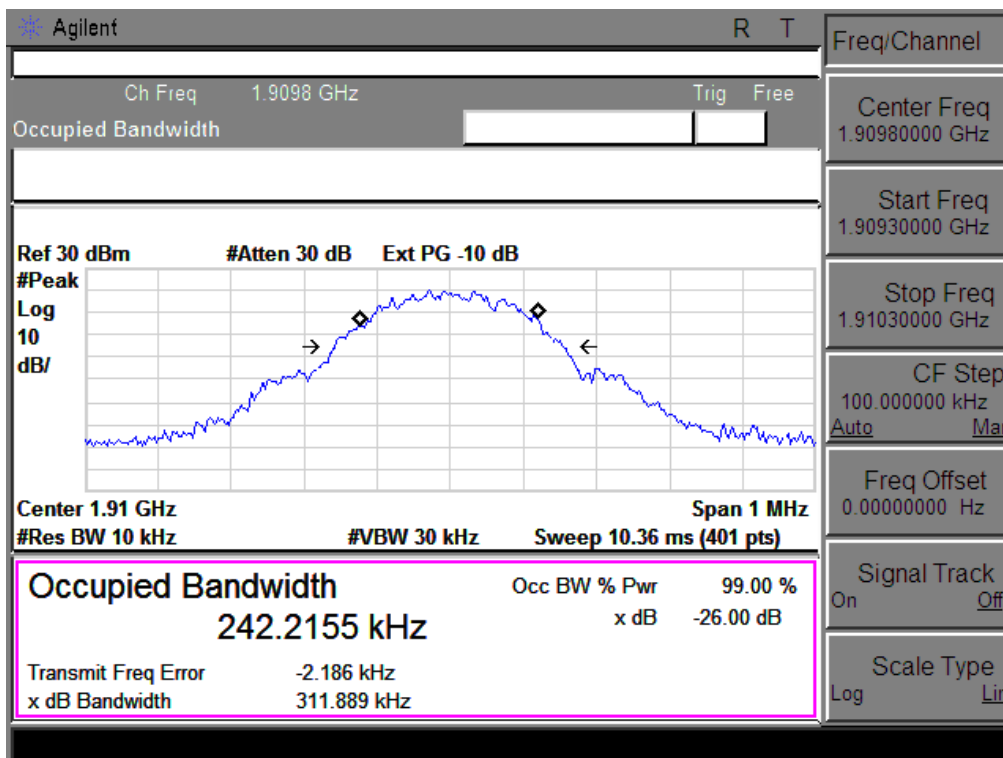

Occupied Bandwidth (99%) UMTS band II CH 9262

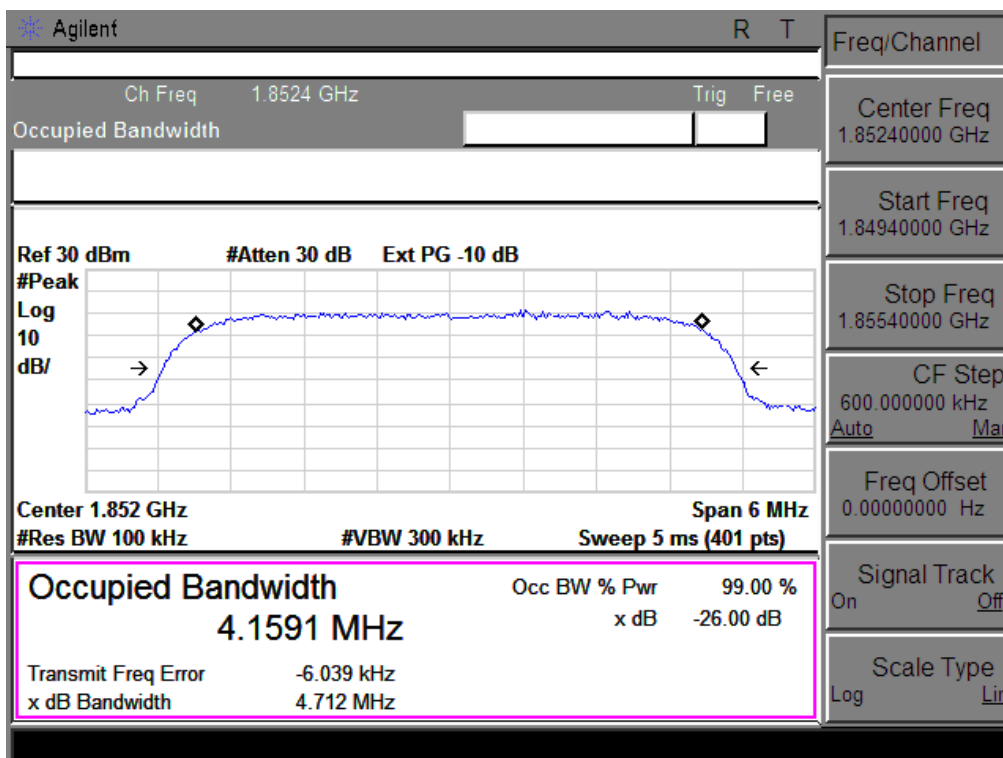

Occupied Bandwidth (99%) UMTS band II CH 9400

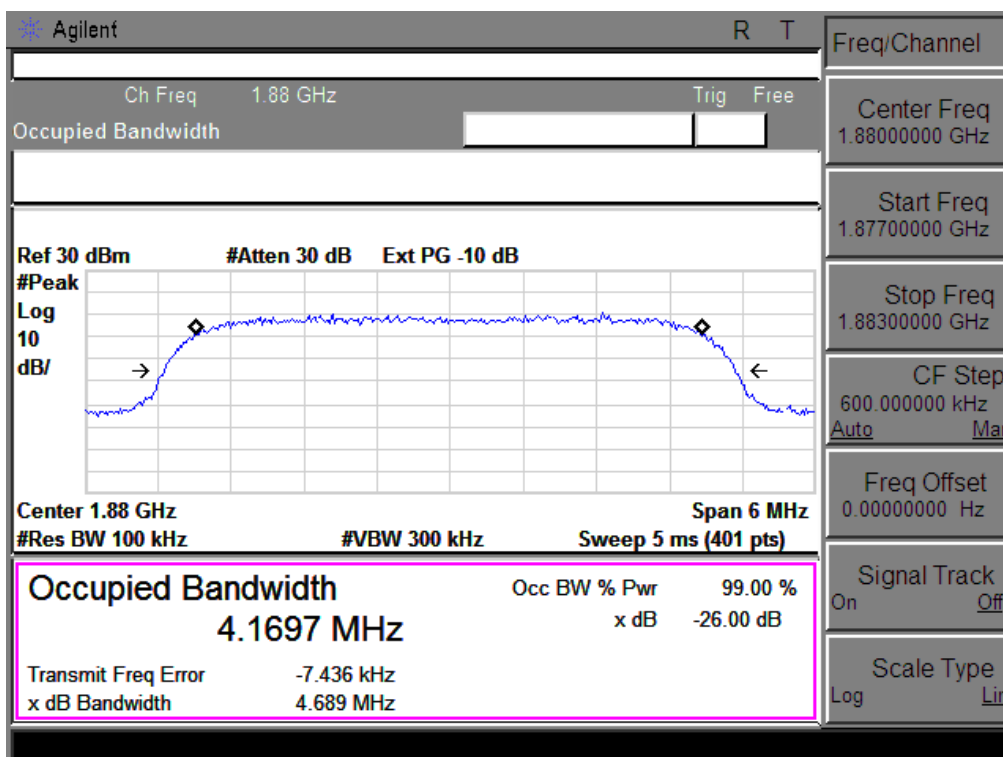

Occupied Bandwidth (99%) UMTS band II CH 9538

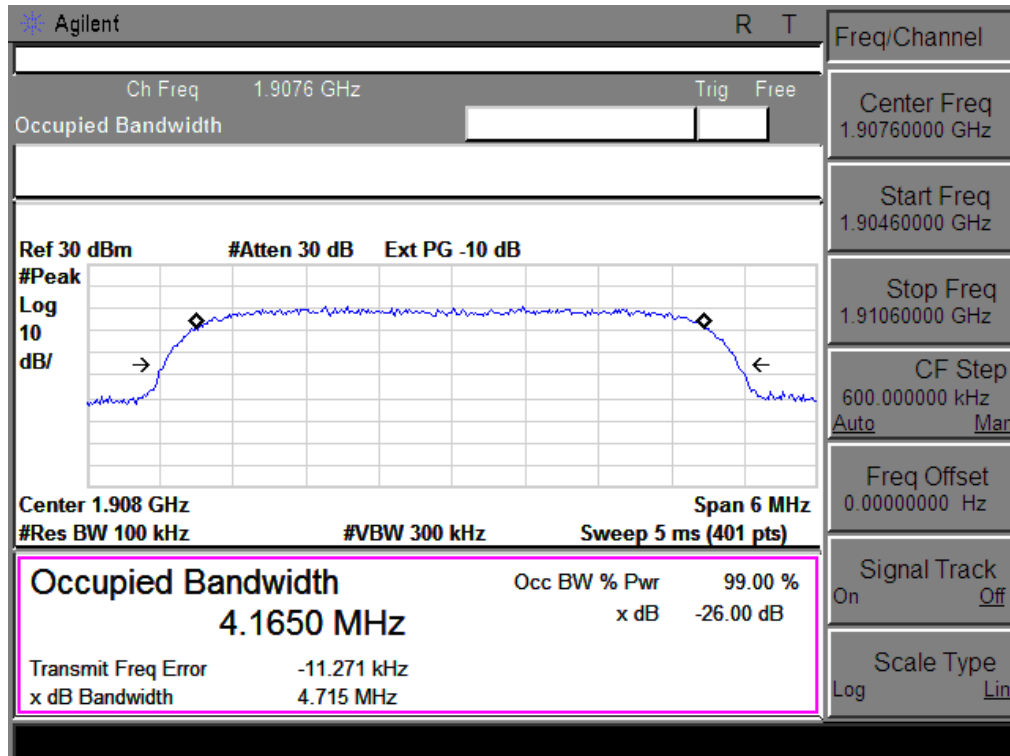

Occupied Bandwidth (99%) UMTS band V CH 4132

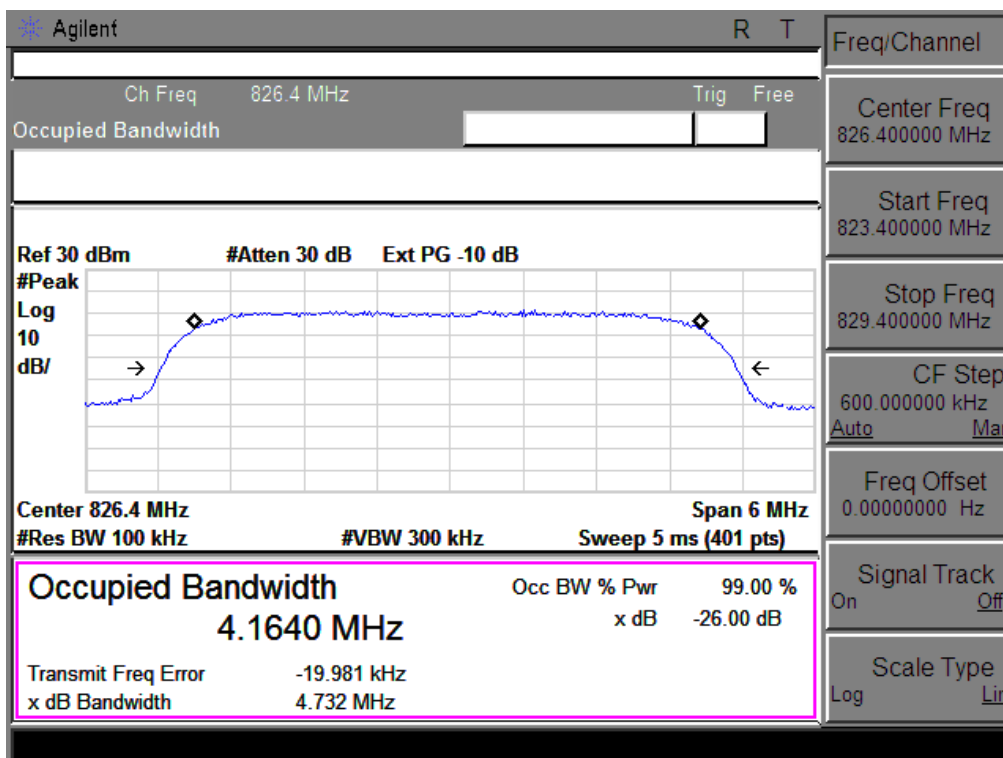

Occupied Bandwidth (99%) UMTS band V CH 4183

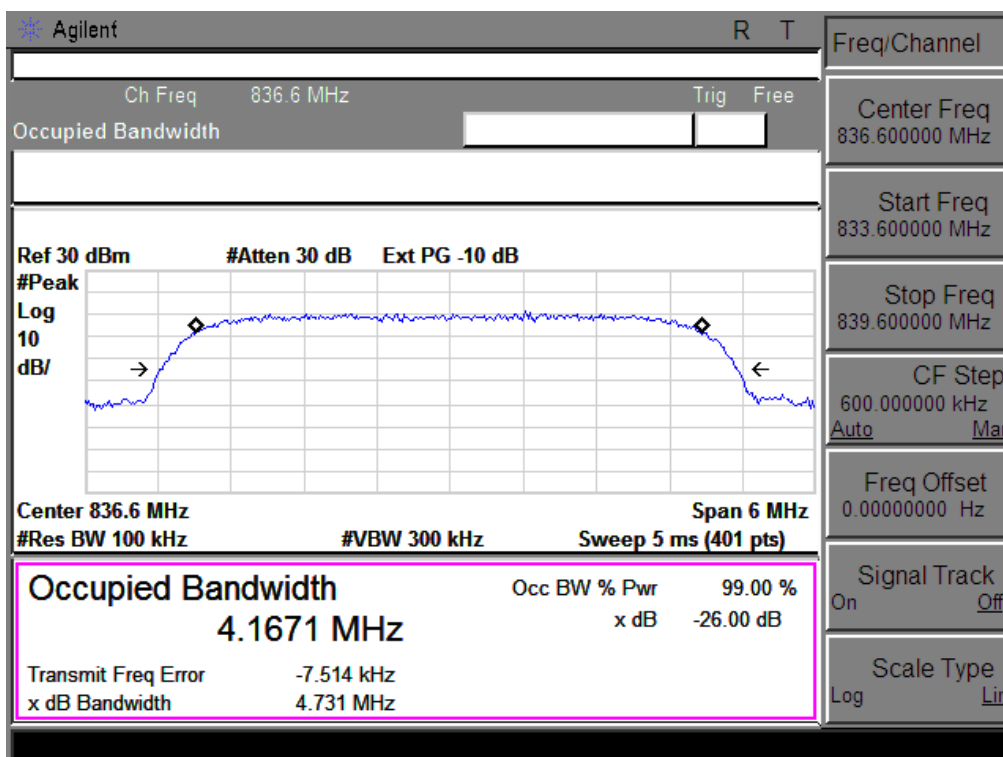

Occupied Bandwidth (99%) UMTS band V CH 4233

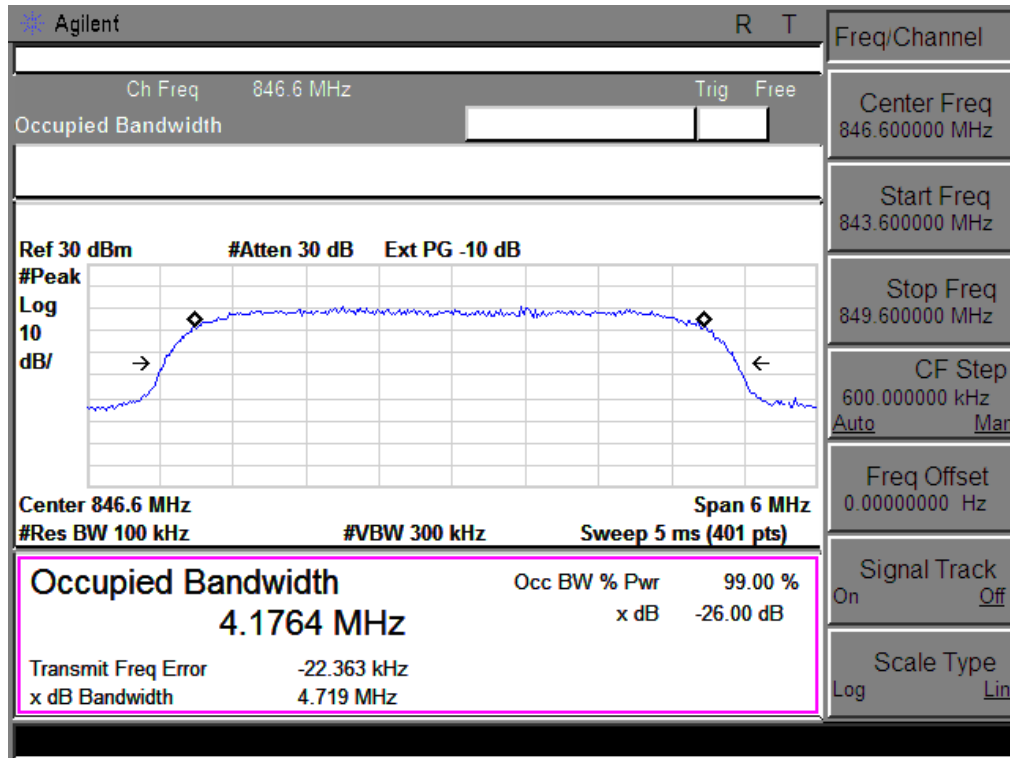

**APPENDIX III**  
**TEST PLOTS FOR BAND EDGES**



Low Band Edge SM 850 BAND CH 128

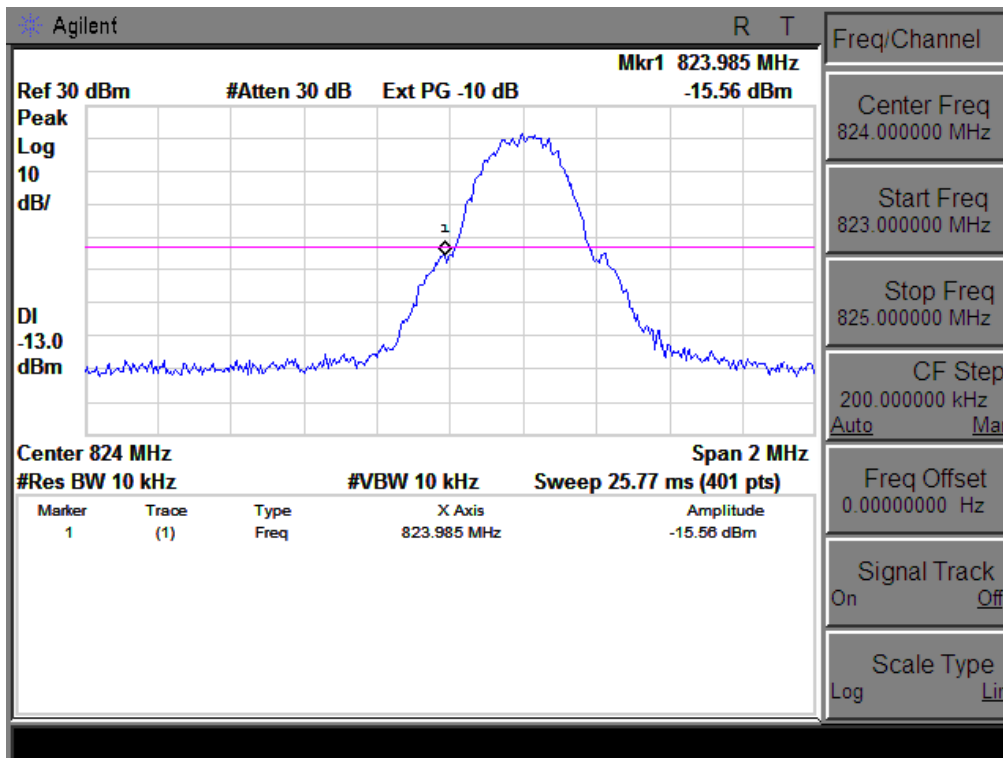

High Band Edge GSM 850 BAND CH 251

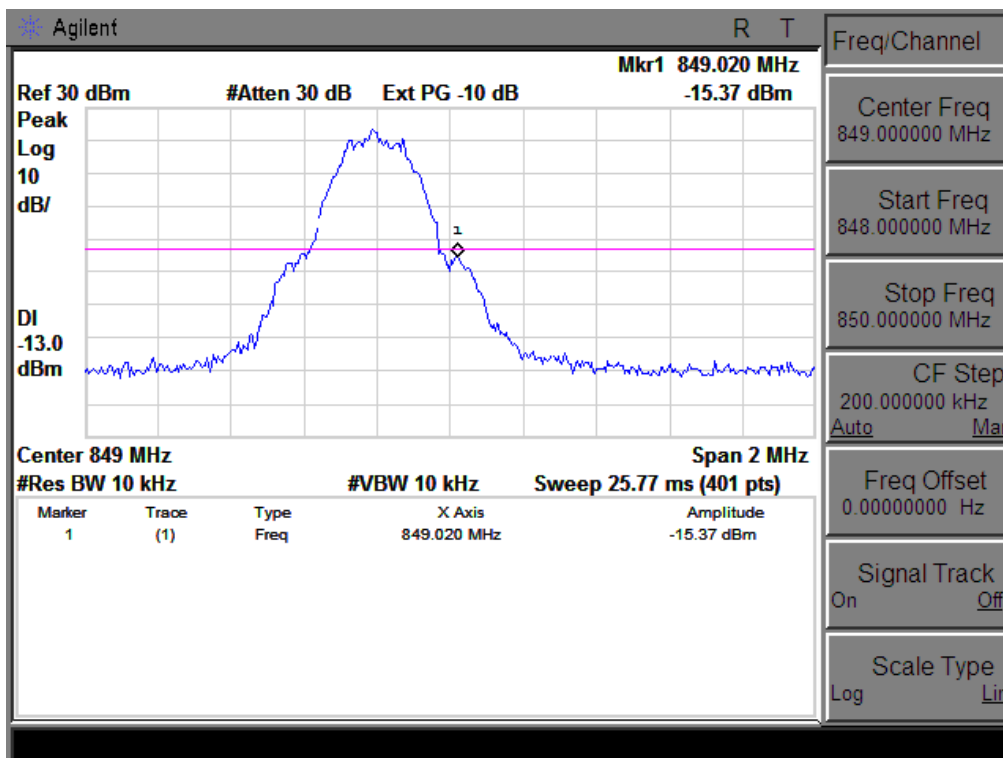

Low Band Edge GSM 1900 BAND CH 512

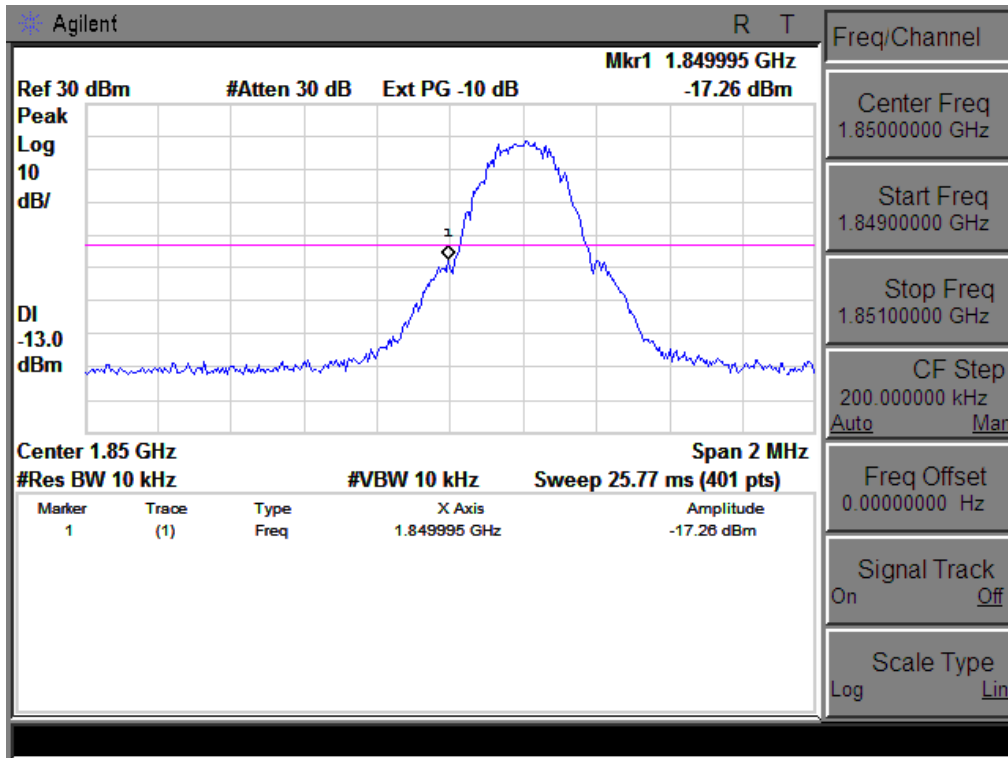

High Band Edge GSM 1900 BAND CH 810

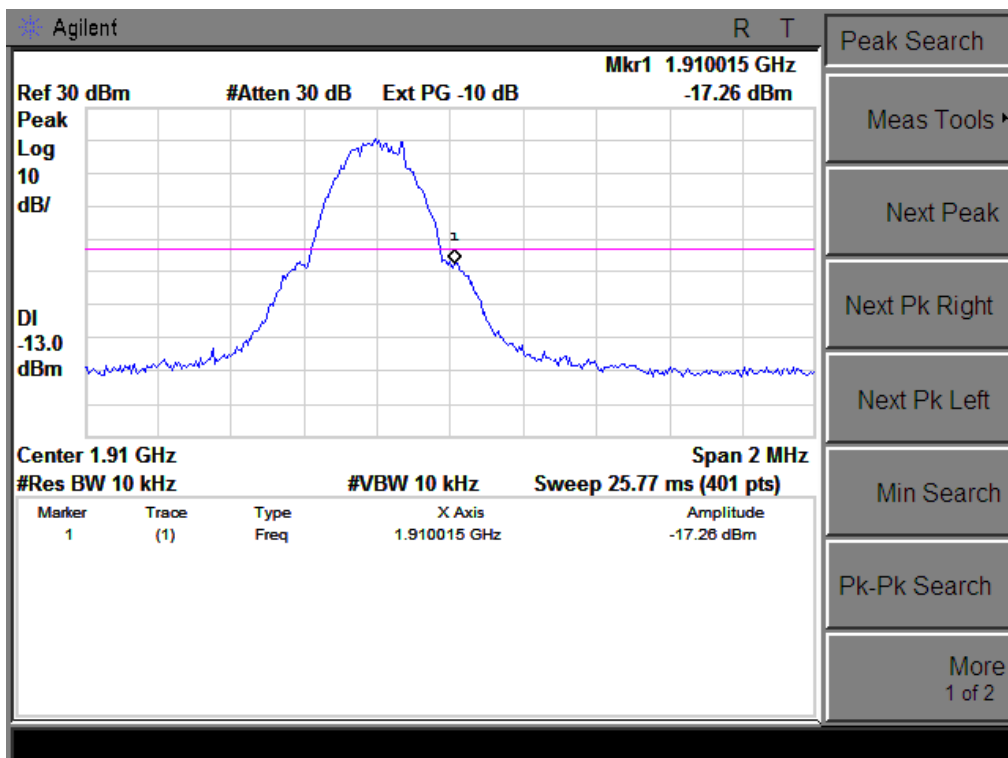

Low Band Edge UMTS BAND II CH 9262

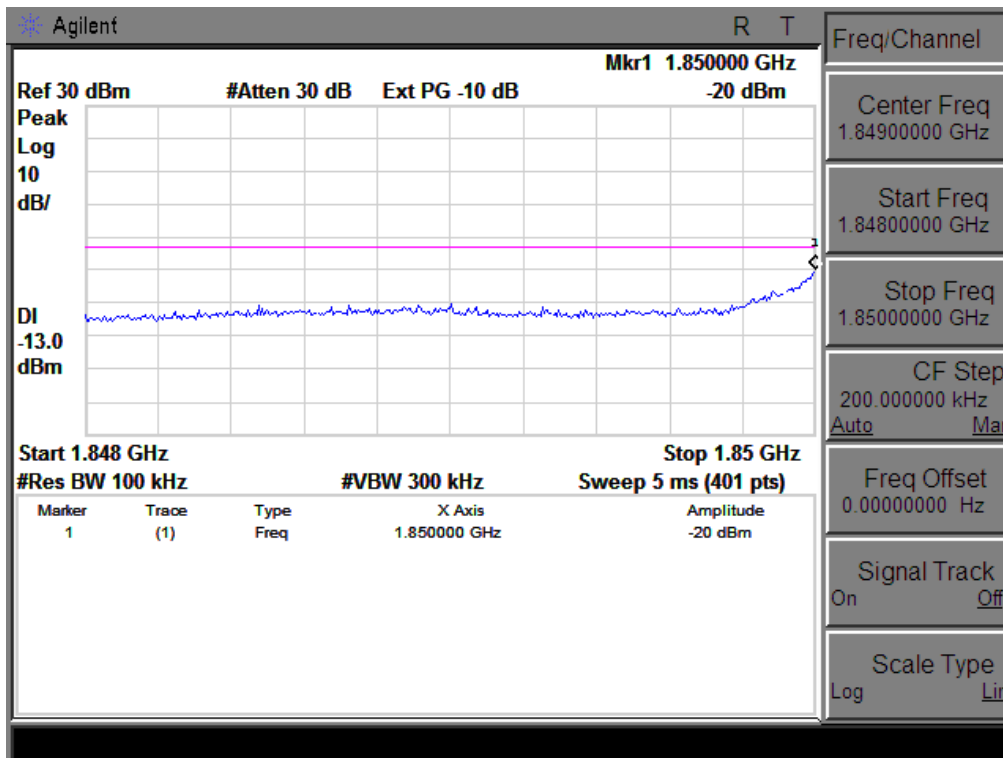

High Band Edge UMTS BAND II CH 9538

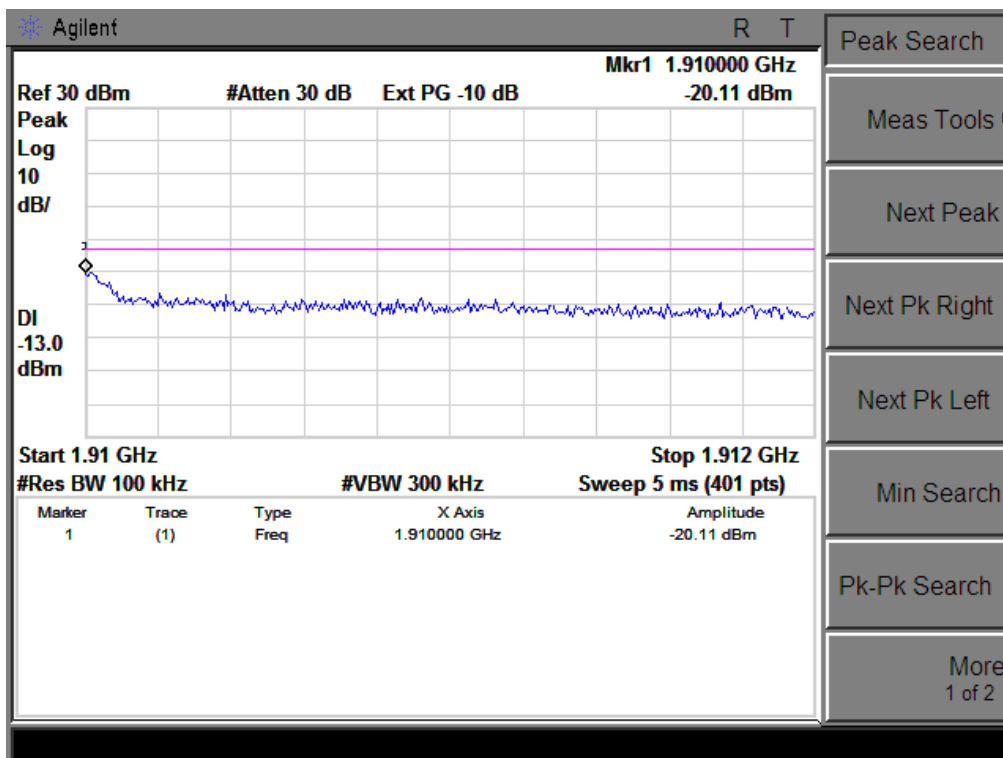

Low Band Edge UMTS BAND V CH 4132

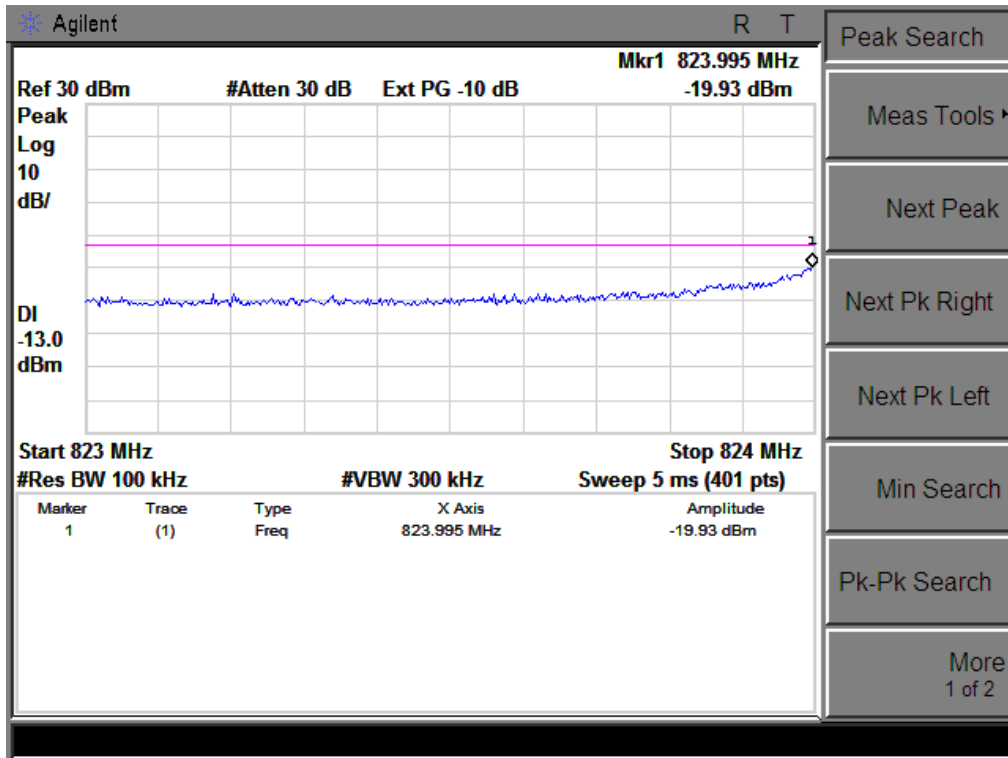

High Band Edge UMTS BAND V CH 4233

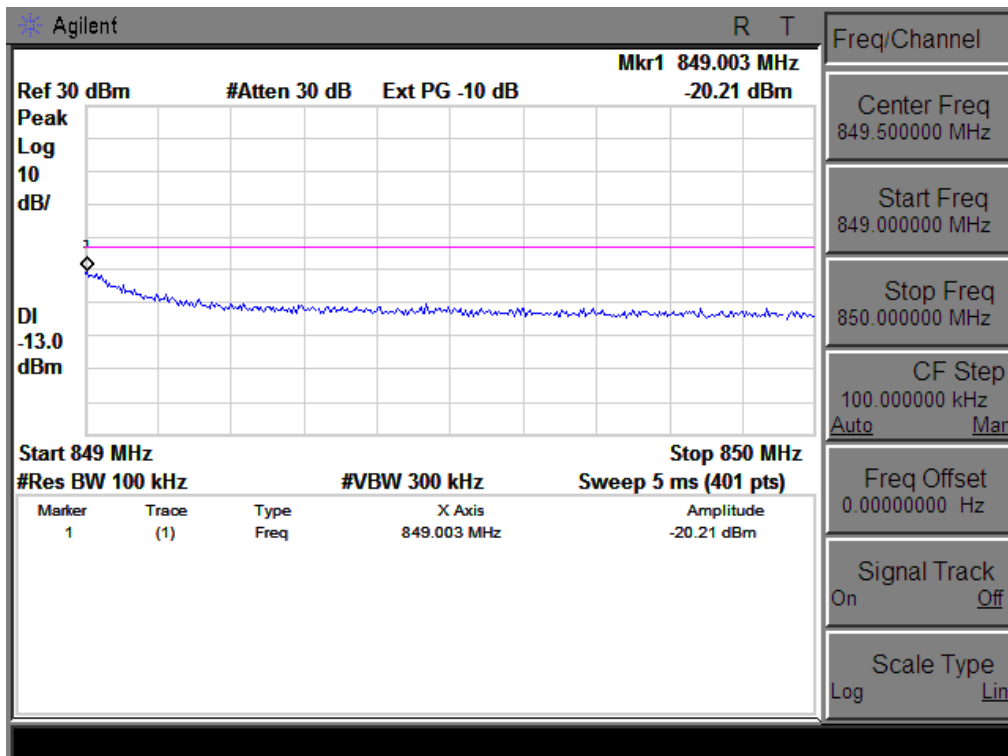

# APPENDIX IV

## PHOTOGRAPHS OF TEST SETUP

### RADIATED SPURIOUS EMISSION

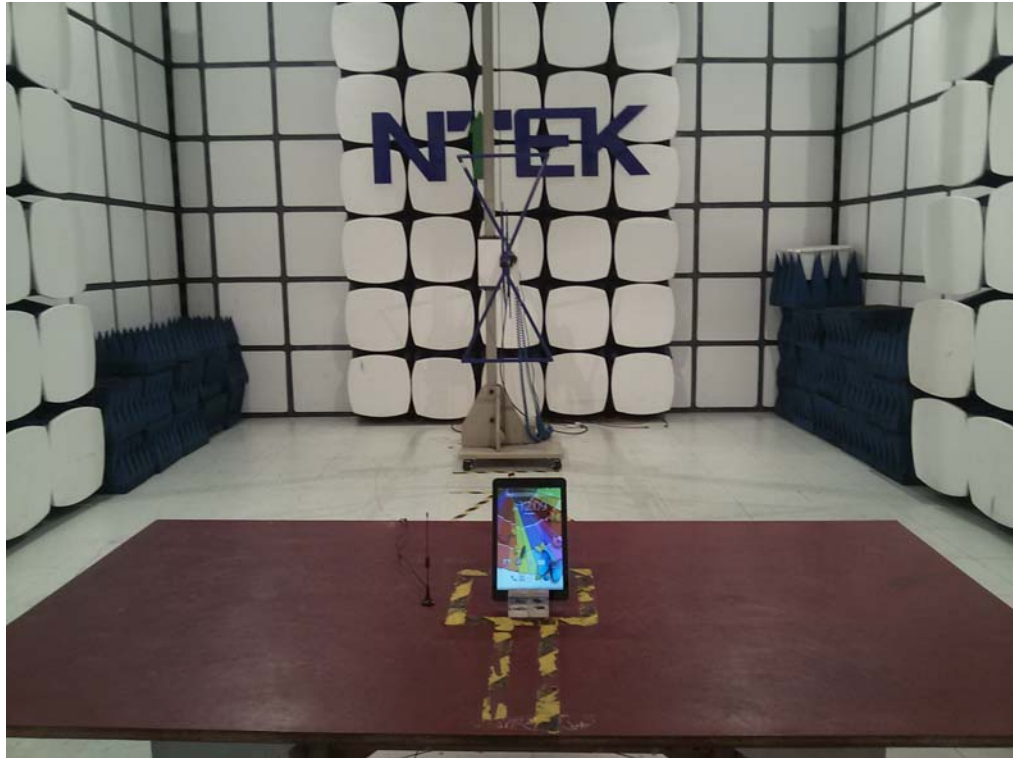

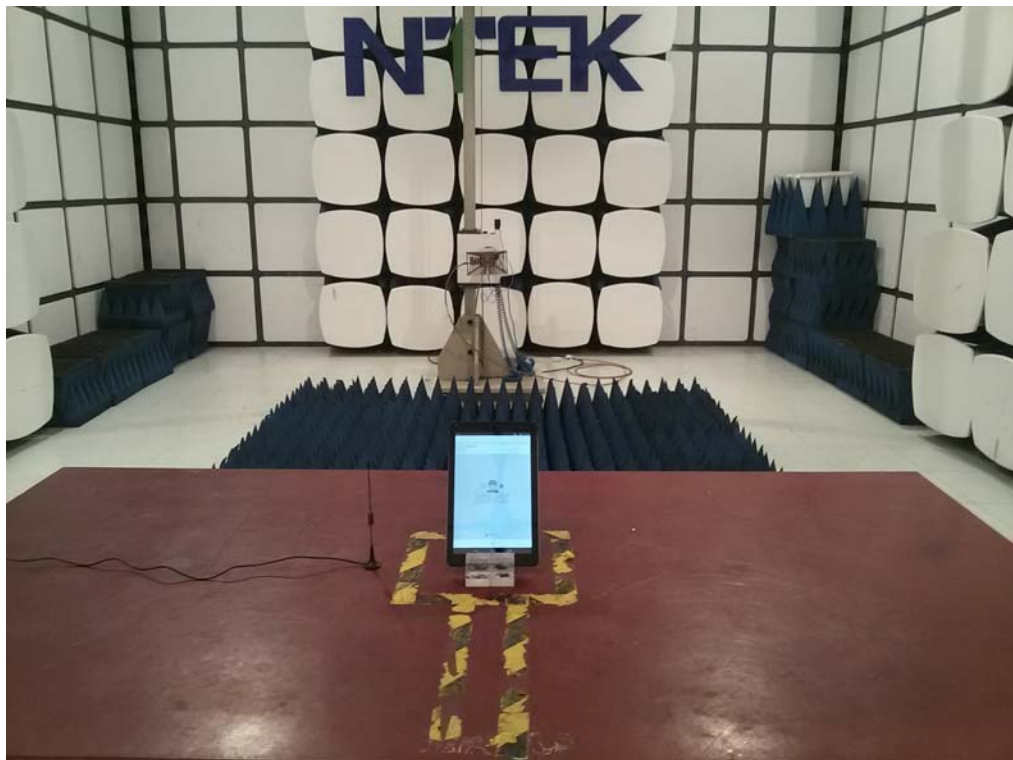

---END OF REPORT---