



FCC RADIO TEST REPORT-WIFI

FCC ID:S4R-TBGP

Product : Tablet PC

Trade Name : Smoothtalker

Model Name : TBGP

Serial Model : TBG8P,TBG16P,TBG32P

Report No. : NTEK-2015NT06031910F4

Prepared for

Mobile Communications Inc.

230 Earl Stewart Drive, Aurora, Ontario L4G 6V8, Canada

Prepared by

Shenzhen NTEK Testing Technology Co., Ltd.

1/F, Building E, Fenda Science Park, Sanwei Community, Xixiang Street
Bao'an District, Shenzhen P.R. China

Tel.: +86-0755-61156588 Fax.: +86-0755-61156599

Website:www.ntek.org.cn

TEST RESULT CERTIFICATION

Applicant's name Mobile Communications Inc.
 Address..... 230 Earl Stewart Drive, Aurora, Ontario L4G 6V8, Canada
Manufacture's Name... Mobile Communications Inc.
 Address..... 230 Earl Stewart Drive, Aurora, Ontario L4G 6V8, Canada

Product description
 Product name..... Tablet PC
 Model and/or type reference TBGP
 Serial Model TBG8P,TBG16P,TBG32P

Standards FCC Part15.247 01 Oct. 2014
 Test procedure ANSI C63.10-2013 and KDB 558074: June 5, 2014

This device described above has been tested by NTEK, and the test results show that the equipment under test (EUT) is in compliance with the FCC requirements. And it is applicable only to the tested sample identified in the report.
 This report shall not be reproduced except in full, without the written approval of NTEK, this document may be altered or revised by NTEK, personnel only, and shall be noted in the revision of the document.

Date of Test
 Date (s) of performance of tests..... 03 Jun. 2015 ~26 Jun. 2015
 Date of Issue 26 Jun. 2015
 Test Result..... **Pass**

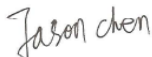
Testing Engineer : 
 (Jason Chen)

Technical Manager : 
 (Brown Lu)

Authorized Signatory : 
 (Bill Yao)

Table of Contents

	Page
1 . SUMMARY OF TEST RESULTS	5
1.1 TEST FACILITY	6
1.2 MEASUREMENT UNCERTAINTY	6
2 . GENERAL INFORMATION	7
2.1 GENERAL DESCRIPTION OF EUT	7
2.2 DESCRIPTION OF TEST MODES	9
2.3 BLOCK DIGRAM SHOWING THE CONFIGURATION OF SYSTEM TESTED	10
2.4 DESCRIPTION OF SUPPORT UNITS(CONDUCTED MODE)	11
2.5 EQUIPMENTS LIST FOR ALL TEST ITEMS	12
3 . EMC EMISSION TEST	13
3.1 CONDUCTED EMISSION MEASUREMENT	13
3.1.1 POWER LINE CONDUCTED EMISSION LIMITS	13
3.1.2 TEST PROCEDURE	14
3.1.3 DEVIATION FROM TEST STANDARD	14
3.1.4 TEST SETUP	14
3.1.5 EUT OPERATING CONDITIONS	14
3.1.6 TEST RESULTS	15
3.2 RADIATED EMISSION MEASUREMENT	23
3.2.1 RADIATED EMISSION LIMITS	23
3.2.2 TEST PROCEDURE	24
3.2.3 DEVIATION FROM TEST STANDARD	24
3.2.4 TEST SETUP	25
3.2.5 EUT OPERATING CONDITIONS	26
3.2.6 TEST RESULTS (BETWEEN 9KHZ – 30 MHZ)	27
3.2.7 TEST RESULTS (BETWEEN 30MHZ – 1GHZ)	28
3.2.8 TEST RESULTS (ABOVE 1000 MHZ)	30
4 . POWER SPECTRAL DENSITY TEST	31
4.1 APPLIED PROCEDURES / LIMIT	31
4.1.1 TEST PROCEDURE	31
4.1.2 DEVIATION FROM STANDARD	31
4.1.3 TEST SETUP	31
4.1.4 EUT OPERATION CONDITIONS	31
4.1.5 TEST RESULTS	32
5 . BANDWIDTH TEST	40
5.1 APPLIED PROCEDURES / LIMIT	40
5.1.1 TEST PROCEDURE	40

Table of Contents

	Page
TEST SETUP	40
5.1.2 EUT OPERATION CONDITIONS	40
5.1.3 TEST RESULTS	41
6 . PEAK OUTPUT POWER TEST	49
6.1 APPLIED PROCEDURES / LIMIT	49
6.1.1 TEST PROCEDURE	49
6.1.2 DEVIATION FROM STANDARD	49
6.1.3 TEST SETUP	49
6.1.4 EUT OPERATION CONDITIONS	49
6.1.5 TEST RESULTS	50
7 . 100 KHZ BANDWIDTH OF FREQUENCY BAND EDGE	51
7.1 DEVIATION FROM STANDARD	51
7.2 TEST SETUP	51
7.3 EUT OPERATION CONDITIONS	51
7.4 TEST RESULTS	52
8 . ANTENNA REQUIREMENT	58
8.1 STANDARD REQUIREMENT	58
8.2 EUT ANTENNA	58
9 . EUT TEST PHOTO	59
APPENDIX-PHOTOGRAPHS OF EUT CONSTRUCTIONAL DETAILS	

1. SUMMARY OF TEST RESULTS

Test procedures according to the technical standards:

FCC Part15 (15.247) , Subpart C			
Standard Section	Test Item	Judgment	Remark
15.207	Conducted Emission	PASS	
15.247 (a)(2)	6dB Bandwidth	PASS	
15.247 (b)	Peak Output Power	PASS	
15.247 (c)	Radiated Spurious Emission	PASS	
15.247 (d)	Power Spectral Density	PASS	
15.205	Band Edge Emission	PASS	
15.203	Antenna Requirement	PASS	

NOTE:

(1) "N/A" denotes test is not applicable in this Test Report

1.1 TEST FACILITY

NTEK Testing Technology Co., Ltd

Add.:1/F, Building E, Fenda Science Park, Sanwei Community, Xixiang Street, Bao'an District, Shenzhen P.R. China.

FCC Registration No.:238937; IC Registration No.:9270A-1

CNAS Registration No.:L5516

1.2 MEASUREMENT UNCERTAINTY

The reported uncertainty of measurement $y \pm U$, where expanded uncertainty U is based on a standard uncertainty multiplied by a coverage factor of $k=2$, providing a level of confidence of approximately 95 %.

No.	Item	Uncertainty
1	Conducted Emission Test	$\pm 1.38\text{dB}$
2	RF power,conducted	$\pm 0.16\text{dB}$
3	Spurious emissions,conducted	$\pm 0.21\text{dB}$
4	All emissions,radiated(<1G)	$\pm 4.68\text{dB}$
5	All emissions,radiated(>1G)	$\pm 4.89\text{dB}$
6	Temperature	$\pm 0.5^\circ\text{C}$
7	Humidity	$\pm 2\%$

2. GENERAL INFORMATION

2.1 GENERAL DESCRIPTION OF EUT

Equipment	Tablet PC	
Trade Name	Smoothtalker	
Model Name	TBGP	
Serial Model	TBG8P,TBG16P,TBG32P	
Model Difference	All the model are the same circuit and RF module, except the model name and colour.	
Product Description	Operation Frequency:	802.11b/g/n(20MHz): 2412~2462MHz 802.11n(40MHz):2422~2452MHz
	Modulation Type:	IEEE 802.11b : DSSS (CCK, QPSK, DBPSK) IEEE 802.11g/n (HT20/HT40) : OFDM (64QAM, 16QAM, QPSK, BPSK)
	Bit Rate of Transmitter	802.11b:11/5.5/2/1 Mbps 802.11g:54/48/36/24/18/12/9/6Mbps 802.11n(20MHz/40MHz):150/144.44/130/117/115.56/104/86.67/78/52/6.5Mbps
	Number Of Channel	802.11b/g/n20MHz:11CH 802.11n40MHz:7CH
	Antenna Designation:	Please see Note 3.
	Antenna Gain (dBi)	1.0 dbi
	Channel List	Please refer to the Note 2.
Ratings	DC 3.7V	
Adapter	Mode : JK050200-S04USB Input: 100-240V~, 50/60Hz, 0.5A Output: 5V---, 2000mA	
Battery	DC 3.7V, 6000mAh	
Connecting I/O Port(s)	Please refer to the User's Manual	

Note:

1. For a more detailed features description, please refer to the manufacturer's specifications or the User's Manual.

2.

Channel List for 802.11b/g/n(20 MHz)							
Channel	Frequency (MHz)	Channel	Frequency (MHz)	Channel	Frequency (MHz)	Channel	Frequency (MHz)
01	2412	04	2427	07	2442	10	2457
02	2417	05	2432	08	2447	11	2462
03	2422	06	2437	09	2452		

Channel List for 802.11n(40MHz)							
Channel	Frequency (MHz)	Channel	Frequency (MHz)	Channel	Frequency (MHz)	Channel	Frequency (MHz)
03	2422	06	2437	09	2452		
04	2427	07	2442				
05	2432	08	2447				

3.

Table for Filed Antenna

Ant	Brand	Model Name	Antenna Type	Connector	Gain (dBi)	NOTE
A	N/A	N/A	FPCB Antenna	N/A	1.0	Wifi Antenna

2.2 DESCRIPTION OF TEST MODES

To investigate the maximum EMI emission characteristics generates from EUT, the test system was pre-scanning tested base on the consideration of following EUT operation mode or test configuration mode which possible have effect on EMI emission level. Each of these EUT operation mode(s) or test configuration mode(s) mentioned above was evaluated respectively.

Pretest Mode	Description
Mode 1	802.11b CH1/ CH6/ CH11
Mode 2	802.11g CH1/ CH6/ CH11
Mode 3	802.11n20 CH1/ CH6/ CH11
Mode 4	802.11n40 CH3/ CH6/ CH9
Mode 5	Link Mode

For Conducted Emission	
Final Test Mode	Description
Mode 5	Link Mode

For Radiated Emission	
Final Test Mode	Description
Mode 1	802.11b CH1/ CH6/ CH11
Mode 2	802.11g CH1/ CH6/ CH11
Mode 3	802.11n20 CH1/ CH6/ CH11
Mode 4	802.11n40 CH3/ CH6/ CH 9
Mode 5	Link Mode

Note:

- (1) The measurements are performed at the highest, middle, lowest available channels.
- (2) The measurements are performed at all Bit Rate of Transmitter, the worst data was reported
- (3) EUT configured to transmit continuously:

Operated Mode for Worst Duty Cycle	
Test Signal Duty Cycle (x)	Average correction factor (dB)
100% - IEEE 802.11b	0
100% - IEEE 802.11g	0
100% - IEEE 802.11n (HT20)	0
100% - IEEE 802.11n (HT40)	0

2.3 BLOCK DIGRAM SHOWING THE CONFIGURATION OF SYSTEM TESTED

Conducted Emission Test

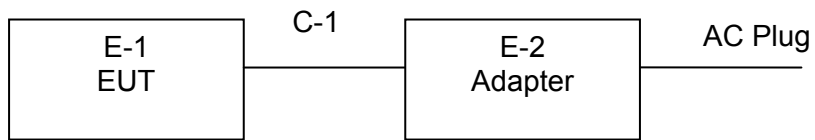

Radiated Spurious Emission Test

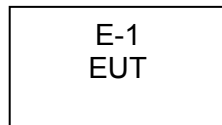

2.4 DESCRIPTION OF SUPPORT UNITS(CONDUCTED MODE)

The EUT has been tested as an independent unit together with other necessary accessories or support units. The following support units or accessories were used to form a representative test configuration during the tests.

Item	Equipment	Brand	Model/Type No.	Series No.	Note
E-1	Tablet PC	Smoothtalker	TBGP	N/A	EUT
E-2	Adapter	N/A	JK050200-S04USB	N/A	

Item	Shielded Type	Ferrite Core	Length	Note
C-1	NO	NO	1.2m	

Note:

- (1) The support equipment was authorized by Declaration of Confirmation.
- (2) For detachable type I/O cable should be specified the length in cm in 『Length』 column.

2.5 EQUIPMENTS LIST FOR ALL TEST ITEMS

Radiation Test equipment

Item	Kind of Equipment	Manufacturer	Type No.	Serial No.	Last calibration	Calibrated until	Calibration period
1	Spectrum Analyzer	Agilent	E4407B	MY45108040	2014.07.06	2015.07.05	1 year
2	Test Receiver	R&S	ESPI	101318	2015.06.07	2015.06.06	1 year
3	Bilog Antenna	TESEQ	CBL6111D	31216	2014.07.06	2015.07.05	1 year
4	50Ω Coaxial Switch	Anritsu	MP59B	6200264416	2015.06.07	2015.06.06	1 year
5	Spectrum Analyzer	ADVANTEST	R3132	150900201	2015.06.07	2015.06.06	1 year
6	Horn Antenna	EM	EM-AH-10180	2011071402	2014.07.06	2015.07.05	1 year
7	Horn Ant	Schwarzbeck	BBHA 9170	9170-181	2014.07.06	2015.07.05	1 year
8	Amplifier	EM	EM-30180	060538	2014.12.22	2015.12.21	1 year
9	Loop Antenna	ARA	PLA-1030/B	1029	2015.06.08	2016.06.07	1 year
10	Power Meter	R&S	NRVS	100696	2014.07.06	2015.07.05	1 year
11	Power Sensor	R&S	URV5-Z4	0395.1619.05	2014.07.06	2015.07.05	1 year

Conduction Test equipment

Item	Kind of Equipment	Manufacturer	Type No.	Serial No.	Last calibration	Calibrated until	Calibration period
1	Test Receiver	R&S	ESCI	101160	2015.06.06	2016.06.05	1 year
2	LISN	R&S	ENV216	101313	2014.08.24	2015.08.23	1 year
3	LISN	EMCO	3816/2	00042990	2014.06.06	2015.06.05	1 year
4	50Ω Coaxial Switch	Anritsu	MP59B	6200264417	2015.06.06	2016.06.05	1 year
5	Passive Voltage Probe	R&S	ESH2-Z3	100196	2015.06.06	2016.06.05	1 year
6	Absorbing clamp	R&S	MOS-21	100423	2015.06.06	2016.06.05	1 year

1	Attenuation	MCE	24-10-34	BN9258	2015.06.06	2016.06.05	1 year
---	-------------	-----	----------	--------	------------	------------	--------

3. EMC EMISSION TEST

3.1 CONDUCTED EMISSION MEASUREMENT

3.1.1 POWER LINE CONDUCTED EMISSION Limits (Frequency Range 150KHz-30MHz)

FREQUENCY (MHz)	Class A (dBuV)		Class B (dBuV)		Standard
	Quasi-peak	Average	Quasi-peak	Average	
0.15 -0.5	79.00	66.00	66 - 56 *	56 - 46 *	CISPR
0.50 -5.0	73.00	60.00	56.00	46.00	CISPR
5.0 -30.0	73.00	60.00	60.00	50.00	CISPR

0.15 -0.5	79.00	66.00	66 - 56 *	56 - 46 *	FCC
0.50 -5.0	73.00	60.00	56.00	46.00	FCC
5.0 -30.0	73.00	60.00	60.00	50.00	FCC

Note:

- (1) The tighter limit applies at the band edges.
- (2) The limit of " * " marked band means the limitation decreases linearly with the logarithm of the frequency in the range.

The following table is the setting of the receiver

Receiver Parameters	Setting
Attenuation	10 dB
Start Frequency	0.15 MHz
Stop Frequency	30 MHz
IF Bandwidth	9 kHz

3.1.2 TEST PROCEDURE

- a. The EUT was placed 0.8 meters from the horizontal ground plane with EUT being connected to the power mains through a line impedance stabilization network (LISN). All other support equipments powered from additional LISN(s). The LISN provide 50 Ohm/ 50uH of coupling impedance for the measuring instrument.
- b. Interconnecting cables that hang closer than 40 cm to the ground plane shall be folded back and forth in the center forming a bundle 30 to 40 cm long.
- c. I/O cables that are not connected to a peripheral shall be bundled in the center. The end of the cable may be terminated, if required, using the correct terminating impedance. The overall length shall not exceed 1 m.
- d. LISN at least 80 cm from nearest part of EUT chassis.
- e. For the actual test configuration, please refer to the related Item –EUT Test Photos.

3.1.3 DEVIATION FROM TEST STANDARD

No deviation

3.1.4 TEST SETUP

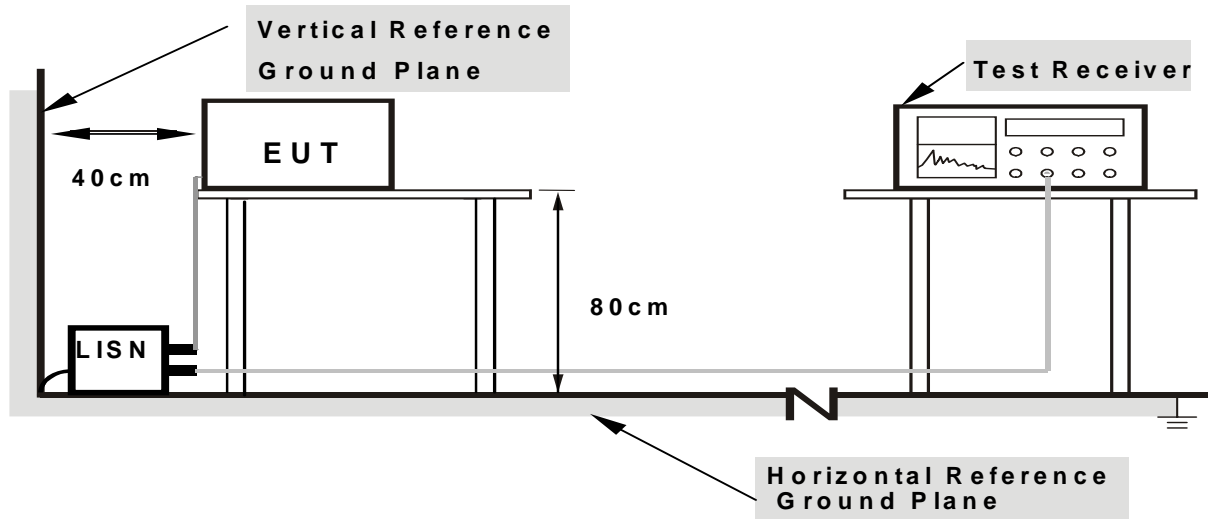

- Note:**
- 1. Support units were connected to second LISN.
 - 2. Both of LISNs (AMN) are 80 cm from EUT and at least 80 from other units and other metal planes

3.1.5 EUT OPERATING CONDITIONS

The EUT was configured for testing in a typical fashion (as a customer would normally use it). The EUT has been programmed to continuously transmit during test. This operating condition was tested and used to collect the included data.

3.1.6 TEST RESULTS

EUT :	Tablet PC	Model Name :	TBGP
Temperature :	26 °C	Relative Humidity :	54%
Pressure :	1010hPa	Phase :	L
Test Voltage :	DC 5.0V form Adapter AC 120V/60Hz	Test Mode :	Mode 5

Frequency (MHz)	Reading Level (dBμV)	Correct Factor (dB)	Measure-ment (dBμV)	Limits (dBμV)	Margin (dB)	Remark
0.1500	31.20	11.49	42.69	55.99	-13.30	AVG
0.1580	49.67	11.36	61.03	65.56	-4.53	QP
0.4660	28.11	10.62	38.73	56.58	-17.85	QP
0.4700	18.02	10.62	28.64	46.51	-17.87	AVG
9.5180	25.56	10.83	36.39	60.00	-23.61	QP
10.1140	15.41	10.84	26.25	50.00	-23.75	AVG

Remark:

1. All readings are Quasi-Peak and Average values.
2. Factor = Insertion Loss + Cable Loss.

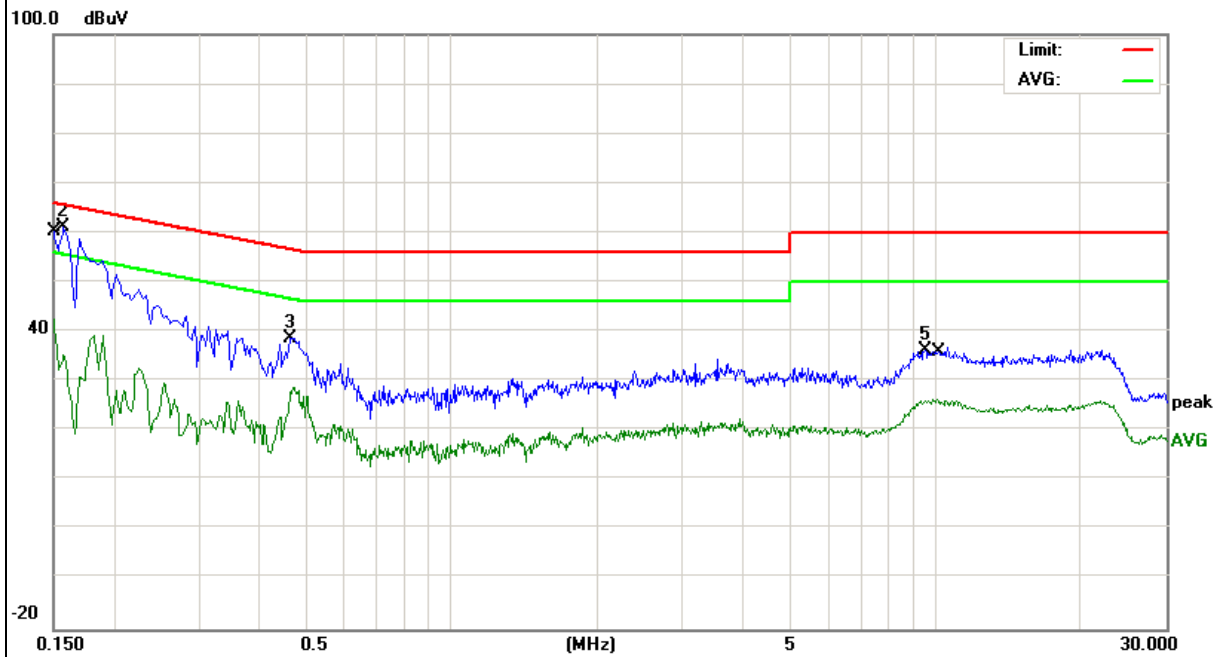

EUT :	Tablet PC	Model Name :	TBGP
Temperature :	26 °C	Relative Humidity :	54%
Pressure :	1010hPa	Phase :	N
Test Voltage :	DC 5.0V form Adapter AC 120V/60Hz	Test Mode :	Mode 5

Frequency (MHz)	Reading Level (dBµV)	Correct Factor (dB)	Measure-ment (dBµV)	Limits (dBµV)	Margin (dB)	Remark
0.1500	49.25	11.63	60.88	65.99	-5.11	QP
0.1500	32.96	11.63	44.59	55.99	-11.40	AVG
0.4660	27.60	10.61	38.21	56.58	-18.37	QP
0.4660	17.96	10.61	28.57	46.58	-18.01	AVG
8.3300	25.81	10.78	36.59	60.00	-23.41	QP
8.5940	15.80	10.78	26.58	50.00	-23.42	AVG

Remark:

1. All readings are Quasi-Peak and Average values.
2. Factor = Insertion Loss + Cable Loss.

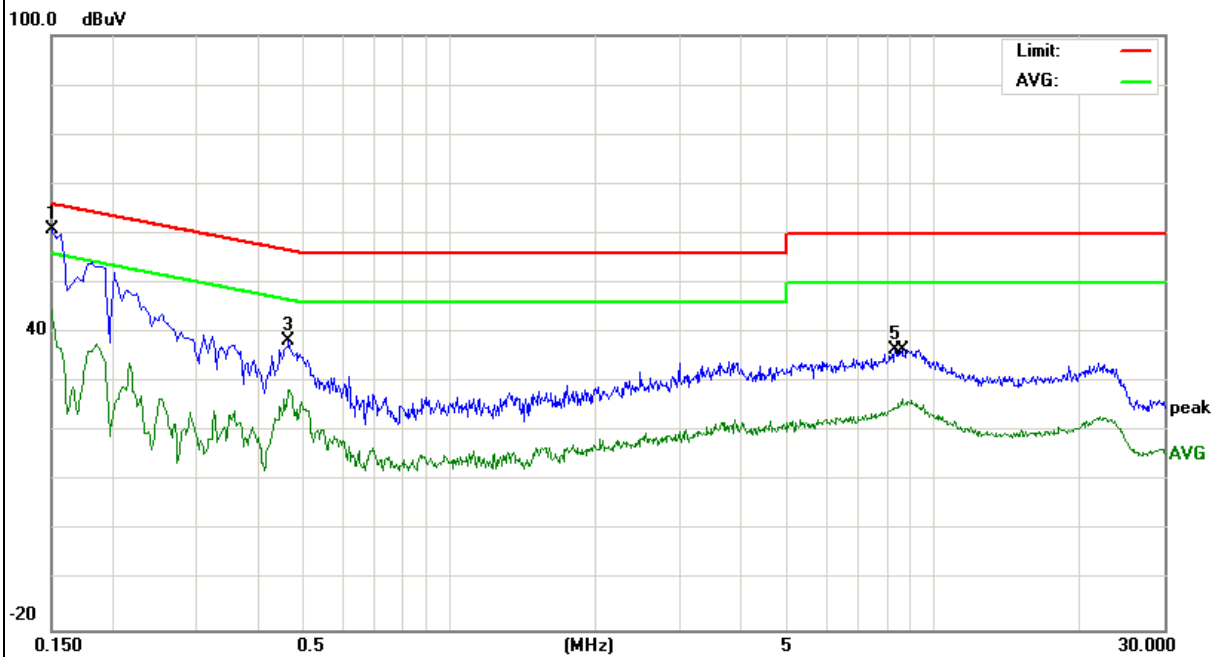

EUT :	Tablet PC	Model Name :	TBGP
Temperature :	26 °C	Relative Humidity :	54%
Pressure :	1010hPa	Phase :	L
Test Voltage :	DC 5.0V form Adapter AC 240V/60Hz	Test Mode :	Mode 5

Frequency (MHz)	Reading Level (dBμV)	Correct Factor (dB)	Measure-ment (dBμV)	Limits (dBμV)	Margin (dB)	Remark
0.1620	47.35	11.29	58.64	65.36	-6.72	QP
0.1620	33.38	11.29	44.67	55.36	-10.69	AVG
0.4820	29.33	10.60	39.93	56.30	-16.37	QP
0.4900	21.97	10.60	32.57	46.17	-13.60	AVG
8.8740	16.91	10.80	27.71	50.00	-22.29	AVG
9.1260	26.58	10.81	37.39	60.00	-22.61	QP

Remark:

1. All readings are Quasi-Peak and Average values.
2. Factor = Insertion Loss + Cable Loss.

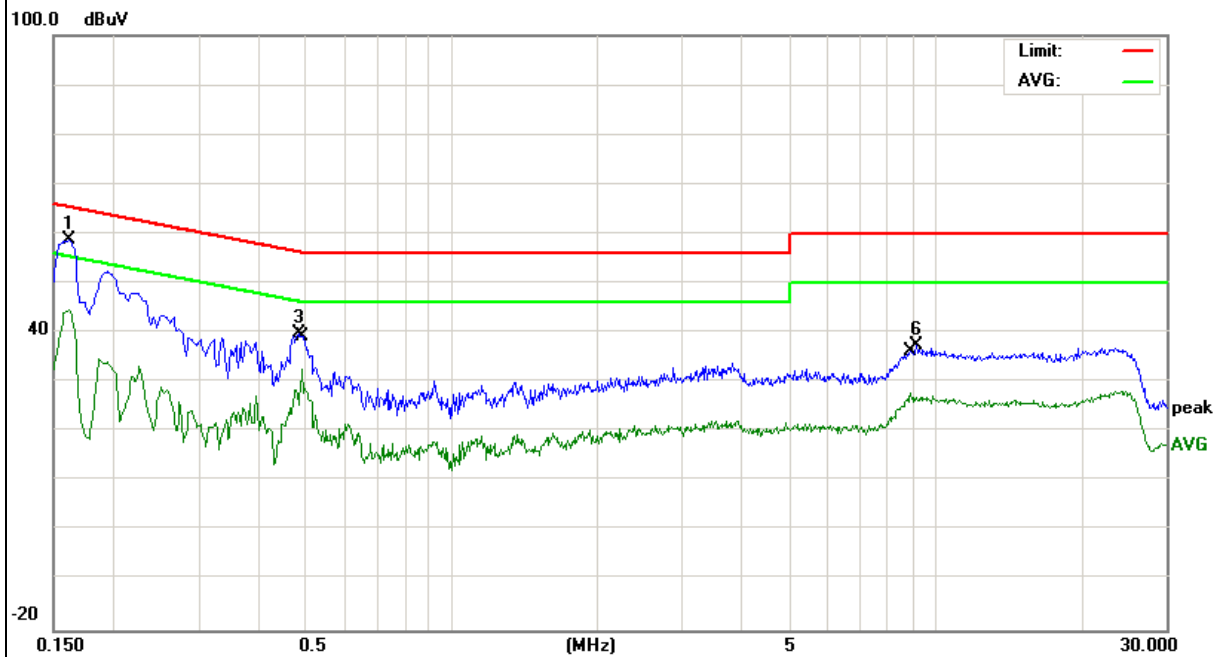

EUT :	Tablet PC	Model Name :	TBGP
Temperature :	26 °C	Relative Humidity :	54%
Pressure :	1010hPa	Phase :	N
Test Voltage :	DC 5.0V form Adapter AC 240V/60Hz	Test Mode :	Mode 5

Frequency (MHz)	Reading Level (dBµV)	Correct Factor (dB)	Measure-ment (dBµV)	Limits (dBµV)	Margin (dB)	Remark
0.1500	48.54	11.63	60.17	65.99	-5.82	QP
0.1580	35.21	11.54	46.75	55.56	-8.81	AVG
0.4860	28.46	10.60	39.06	56.24	-17.18	QP
0.5100	16.71	10.58	27.29	46.00	-18.71	AVG
8.4340	24.87	10.78	35.65	60.00	-24.35	QP
8.7100	14.70	10.78	25.48	50.00	-24.52	AVG

Remark:

1. All readings are Quasi-Peak and Average values.
2. Factor = Insertion Loss + Cable Loss.

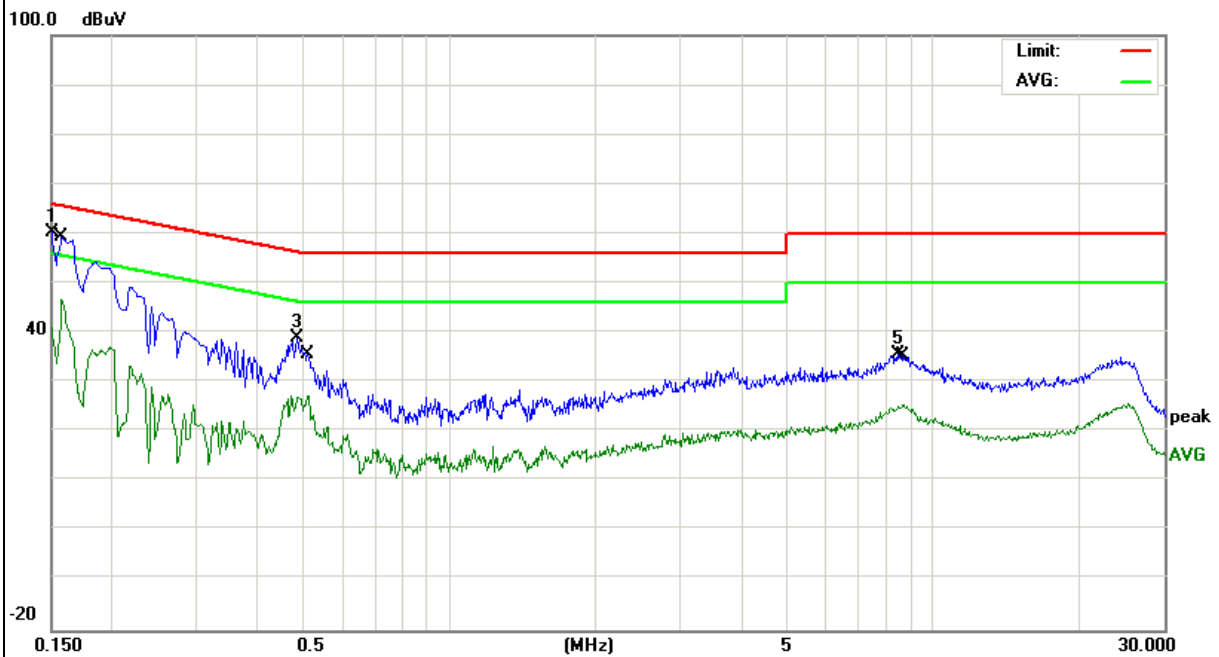

EUT :	Tablet PC	Model Name :	TBGP
Temperature :	26 °C	Relative Humidity :	54%
Pressure :	1010hPa	Phase :	L
Test Voltage :	DC 5.0V form PC AC 120V/60Hz	Test Mode :	Mode 5

Frequency (MHz)	Reading Level (dBμV)	Correct Factor (dB)	Measure-ment (dBμV)	Limits (dBμV)	Margin (dB)	Remark
0.1500	48.76	11.49	60.25	65.99	-5.74	QP
0.1580	32.06	11.36	43.42	55.56	-12.14	AVG
0.4860	29.11	10.60	39.71	56.24	-16.53	QP
0.4860	19.12	10.60	29.72	46.24	-16.52	AVG
25.5100	27.48	11.14	38.62	60.00	-21.38	QP
26.1580	19.09	11.14	30.23	50.00	-19.77	AVG

Remark:

1. All readings are Quasi-Peak and Average values.
2. Factor = Insertion Loss + Cable Loss.

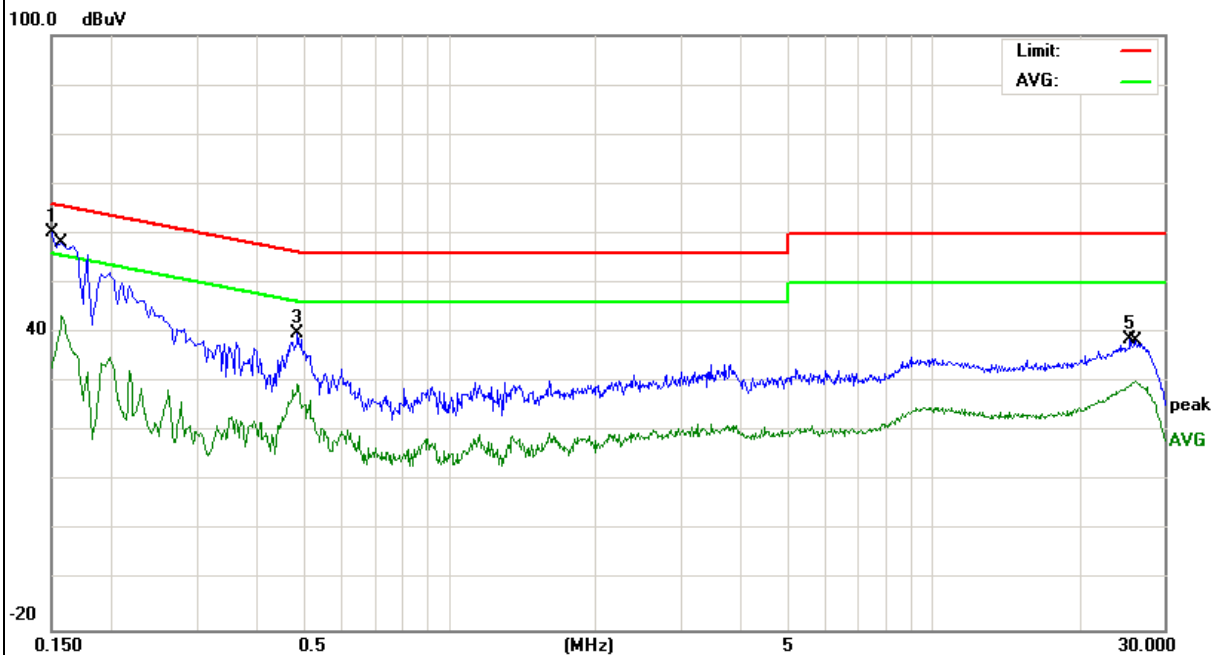

EUT :	Tablet PC	Model Name :	TBGP
Temperature :	26 °C	Relative Humidity :	54%
Pressure :	1010hPa	Phase :	N
Test Voltage :	DC 5.0V form PC AC 120V/60Hz	Test Mode :	Mode 5

Frequency (MHz)	Reading Level (dBμV)	Correct Factor (dB)	Measure-ment (dBμV)	Limits (dBμV)	Margin (dB)	Remark
0.1660	45.39	11.46	56.85	65.15	-8.30	QP
0.1660	27.60	11.46	39.06	55.15	-16.09	AVG
0.4700	19.23	10.61	29.84	46.51	-16.67	AVG
0.4740	28.76	10.61	39.37	56.44	-17.07	QP
26.0180	27.00	11.16	38.16	60.00	-21.84	QP
26.2580	18.18	11.16	29.34	50.00	-20.66	AVG
3.9140	24.04	10.59	34.63	56.00	-21.37	QP

Remark:

1. All readings are Quasi-Peak and Average values.
2. Factor = Insertion Loss + Cable Loss.

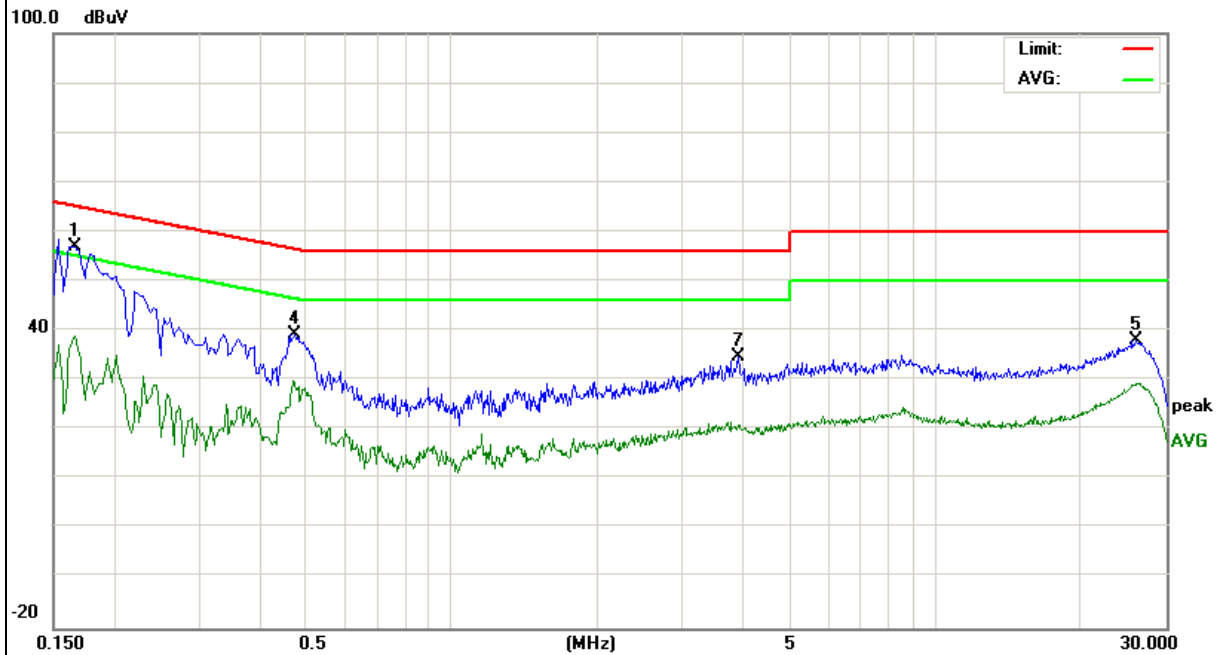

EUT :	Tablet PC	Model Name :	TBGP
Temperature :	26 °C	Relative Humidity :	54%
Pressure :	1010hPa	Phase :	L
Test Voltage :	DC 5.0V form PC AC 240V/60Hz	Test Mode :	Mode 5

Frequency (MHz)	Reading Level (dBμV)	Correct Factor (dB)	Measure-ment (dBμV)	Limits (dBμV)	Margin (dB)	Remark
0.4420	43.75	9.53	53.28	57.02	-3.74	QP
2.3700	34.51	9.66	44.17	56.00	-11.83	QP
4.1299	37.43	9.70	47.13	56.00	-8.87	QP
1.5740	33.35	9.68	43.03	56.00	-12.97	QP
3.0020	27.78	9.67	37.45	46.00	-8.55	AVG
4.0859	27.26	9.70	36.96	46.00	-9.04	AVG

Remark:

1. All readings are Quasi-Peak and Average values.
2. Factor = Insertion Loss + Cable Loss.

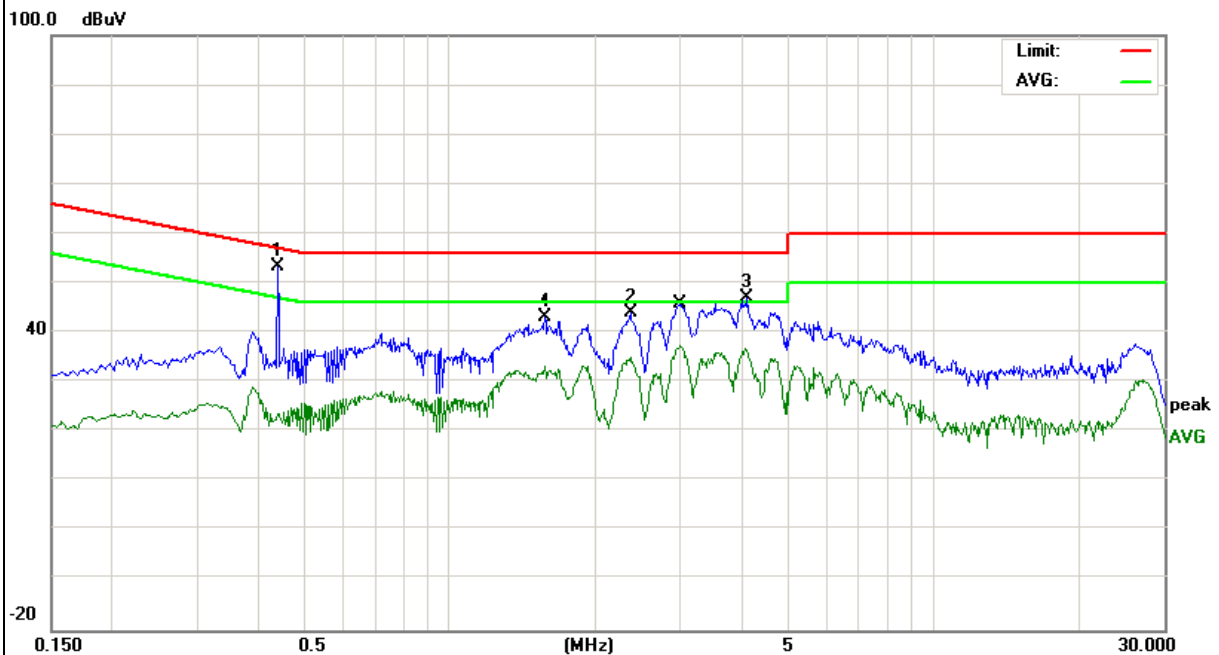

EUT :	Tablet PC	Model Name :	TBGP
Temperature :	26 °C	Relative Humidity :	54%
Pressure :	1010hPa	Phase :	N
Test Voltage :	DC 5.0V form PC AC 240V/60Hz	Test Mode :	Mode 5

Frequency (MHz)	Reading Level (dBμV)	Correct Factor (dB)	Measure-ment (dBμV)	Limits (dBμV)	Margin (dB)	Remark
0.3900	27.90	9.64	37.54	58.06	-20.52	QP
2.3580	32.25	9.53	41.78	56.00	-14.22	QP
4.1379	35.55	9.51	45.06	56.00	-10.94	QP
1.6860	31.38	9.56	40.94	56.00	-15.06	QP
0.3860	12.57	9.63	22.20	48.15	-25.95	AVG
2.9900	23.10	9.52	32.62	46.00	-13.38	AVG

Remark:

1. All readings are Quasi-Peak and Average values.
2. Factor = Insertion Loss + Cable Loss.

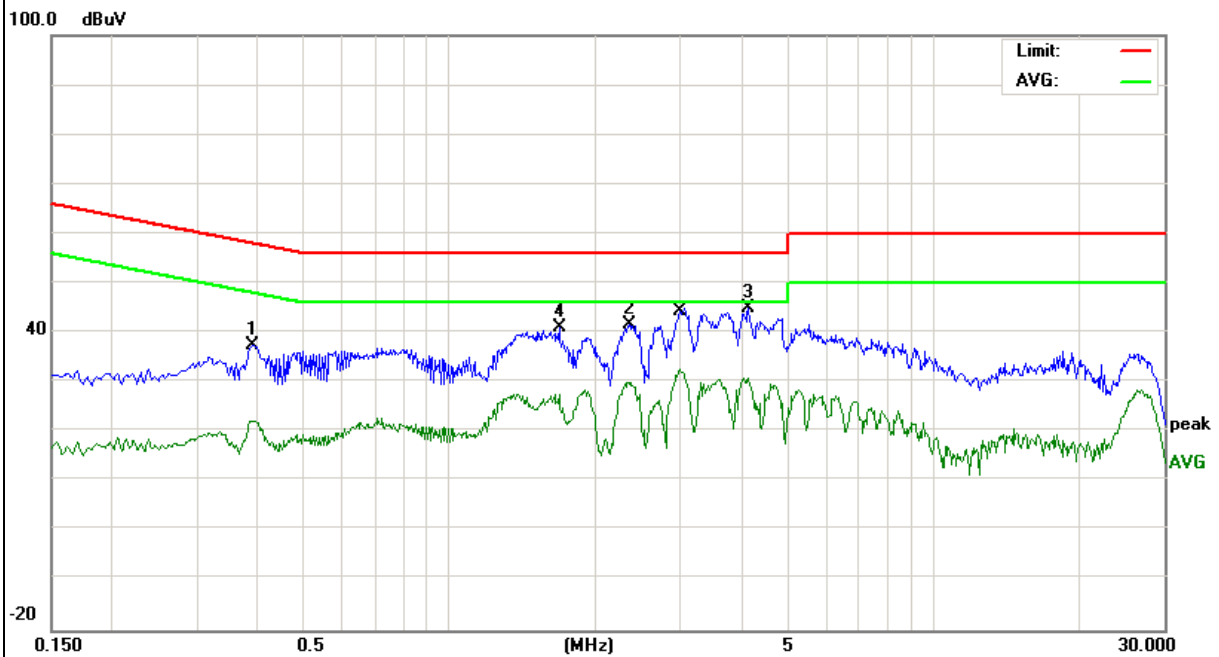

3.2 RADIATED EMISSION MEASUREMENT

3.2.1 RADIATED EMISSION LIMITS (Frequency Range 9kHz-1000MHz)

20dBc in any 100 kHz bandwidth outside the operating frequency band. In case the emission fall within the restricted band specified on 15.205(a), then the 15.209(a) limit in the table below has to be followed.

Frequencies (MHz)	Field Strength (microrvolts/meter)	Measurement Distance (meters)
0.009~0.490	2400/F(KHz)	300
0.490~1.705	24000/F(KHz)	30
1.705~30.0	30	30
30~88	100	3
88~216	150	3
216~960	200	3
Above 960	500	3

LIMITS OF RADIATED EMISSION MEASUREMENT (Above 1000MHz)

FREQUENCY (MHz)	dBuV/m@at 3M	
	PEAK	AVERAGE
Above 1000	74	54

Notes:

- (1) The limit for radiated test was performed according to FCC PART 15C.
- (2) The tighter limit applies at the band edges.
- (3) Emission level (dBuV/m)=20log Emission level (uV/m).

Spectrum Parameter	Setting
Attenuation	Auto
Start Frequency	1000 MHz
Stop Frequency	10th carrier harmonic
RB / VB (emission in restricted band)	1 MHz / 1 MHz for Peak, 1 MHz / 10Hz for Average

Receiver Parameter	Setting
Attenuation	Auto
Start ~ Stop Frequency	9kHz~150kHz / RB 200Hz for QP
Start ~ Stop Frequency	150kHz~30MHz / RB 9kHz for QP
Start ~ Stop Frequency	30MHz~1000MHz / RB 120kHz for QP

3.2.2 TEST PROCEDURE

- a. The measuring distance of at 3 m shall be used for measurements at frequency up to 1GHz. For frequencies above 1GHz, any suitable measuring distance may be used.
- b. The EUT was placed on the top of a rotating table 0.8 m for below 1GHz and 1.5m for above 1GHz the ground at a 3 meter open area test site. The table was rotated 360 degrees to determine the position of the highest radiation.
- c. The height of the equipment or of the substitution antenna shall be 0.8 m for below 1GHz and 1.5m for above 1GHz; the height of the test antenna shall vary between 1 m to 4 m. Both horizontal and vertical polarizations of the antenna are set to make the measurement.
- d. The initial step in collecting conducted emission data is a spectrum analyzer peak detector mode pre-scanning the measurement frequency range. Significant peaks are then marked and then Quasi Peak detector mode re-measured.
- e. If the Peak Mode measured value compliance with and lower than Quasi Peak Mode Limit, the EUT shall be deemed to meet QP Limits and then no additional QP Mode measurement performed.
- f. For the actual test configuration, please refer to the related Item –EUT Test Photos.

Note:

Both horizontal and vertical antenna polarities were tested and performed pretest to three orthogonal axis. The worst case emissions were reported

During the radiated emission test, the Spectrum Analyzer was set with the following configurations:

Frequency Band (MHz)	Function	Resolution bandwidth	Video Bandwidth
30 to 1000	Peak	100 kHz	100 kHz
Above 1000	Peak	1 MHz	1 MHz
	Average	1 MHz	10 Hz

3.2.3 DEVIATION FROM TEST STANDARD

No deviation

3.2.4 TEST SETUP

(A) Radiated Emission Test-Up Frequency Below 30MHz

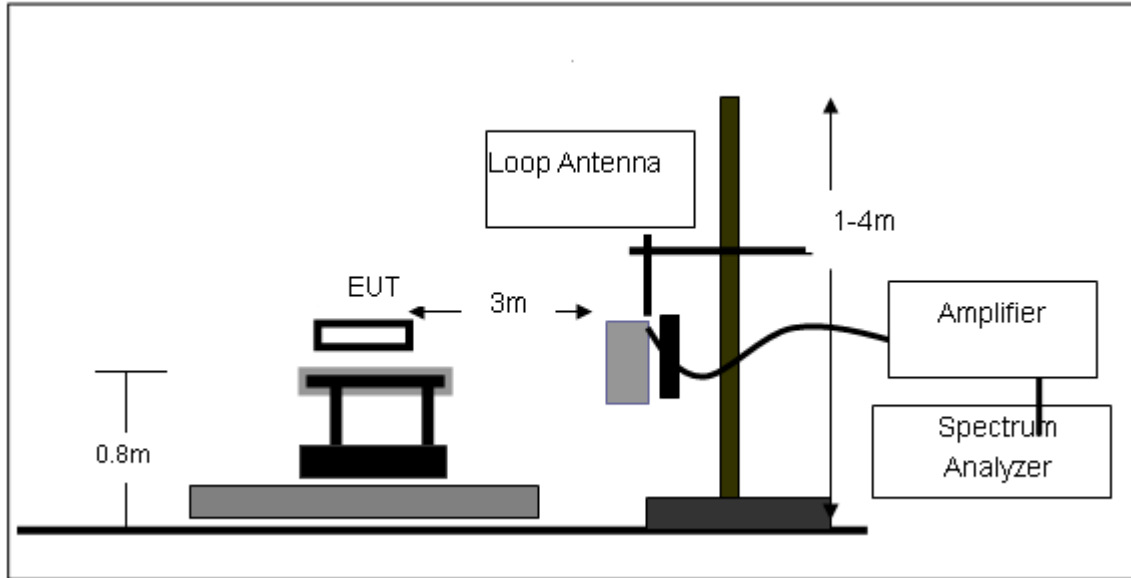

(B) Radiated Emission Test-Up Frequency 30MHz~1GHz

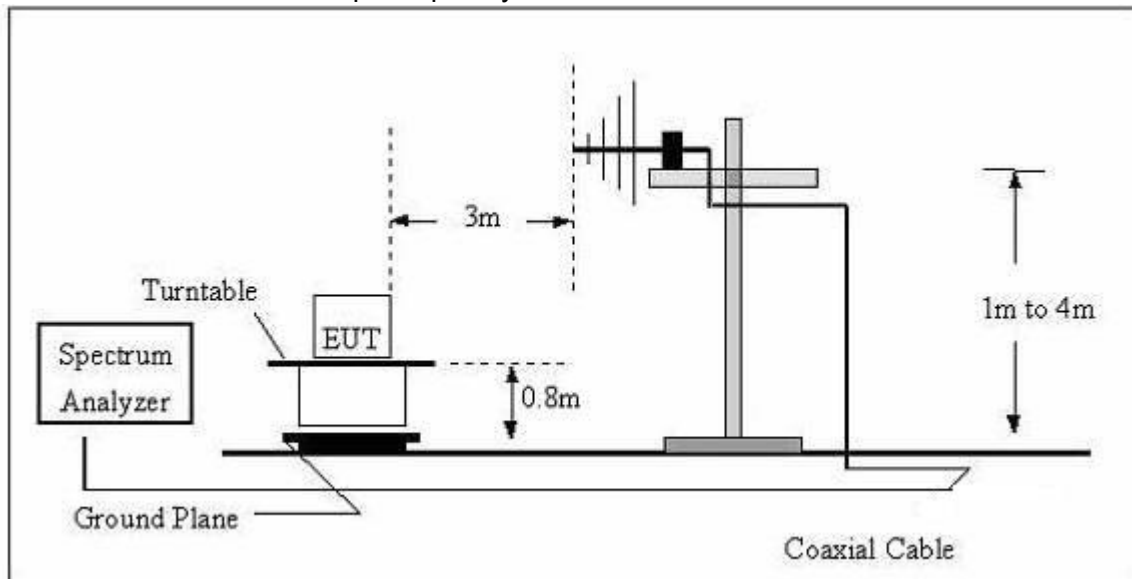

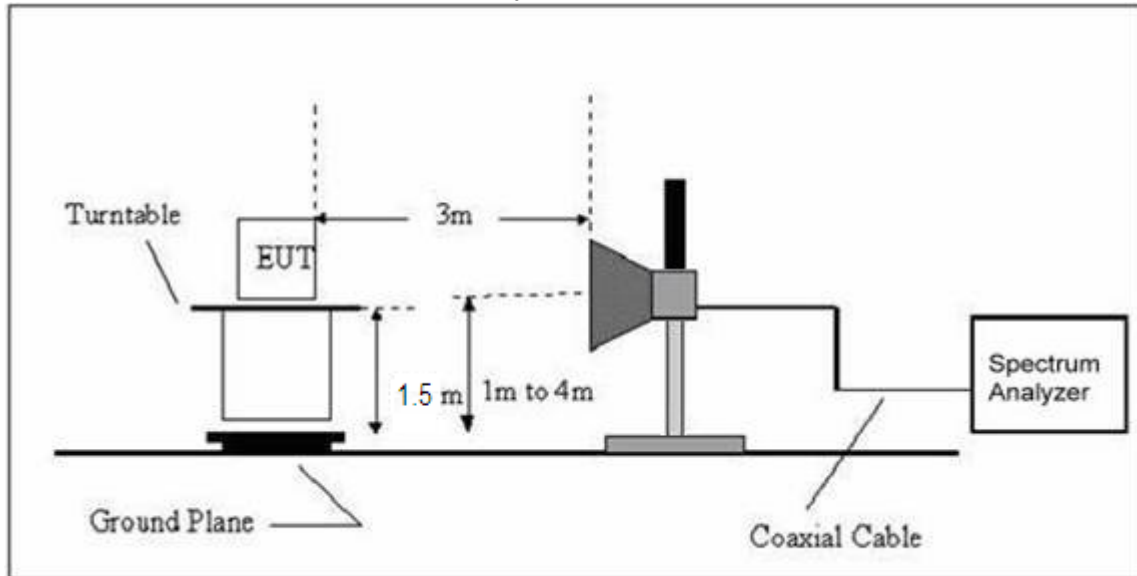
(C) Radiated Emission Test-Up Frequency Above 1GHz**3.2.5 EUT OPERATING CONDITIONS**

The EUT tested system was configured as the statements of 2.4 Unless otherwise a special operating condition is specified in the follows during the testing.

3.2.6 TEST RESULTS (BETWEEN 9KHZ – 30 MHZ)

EUT:	Tablet PC	Model Name. :	TBGP
Temperature:	20 °C	Relative Humidity:	48%
Pressure:	1010 hPa	Test Voltage :	DC 3.7V
Test Mode :	TX	Polarization :	--

Freq. (MHz)	Reading (dBuV/m)	Limit (dBuV/m)	Margin (dB)	State P/F
--	--	--	--	N/A
--	--	--	--	N/A

NOTE:

The amplitude of spurious emissions which are attenuated by more than 20dB below the permissible value has no need to be reported.

Distance extrapolation factor = $40 \log(\text{specific distance}/\text{test distance})(\text{dB})$;

Limit line = specific limits(dBuv) + distance extrapolation factor.

3.2.7 TEST RESULTS (BETWEEN 30MHZ – 1GHZ)

EUT :	Tablet PC	Model Name :	TBGP
Temperature :	20 °C	Relative Humidity :	48%
Pressure :	1010 hPa	Test Voltage :	DC 3.7V
Test Mode :	TX		

Polar (H/V)	Frequency	Meter Reading	Factor	Emission Level	Limits	Margin	Remark
	(MHz)	(dBuV)	(dB)	(dBuV/m)	(dBuV/m)	(dB)	
V	55.2207	23.33	9.20	32.53	40.00	-7.47	QP
V	132.6850	27.36	11.76	39.12	43.50	-4.38	QP
V	175.6516	22.78	10.60	33.38	43.50	-10.12	QP
V	480.5276	16.58	19.91	36.49	46.00	-9.51	QP
V	721.7259	14.77	25.36	40.13	46.00	-5.87	QP

Remark:

Absolute Level= ReadingLevel+ Factor, Margin= Absolute Level - Limit

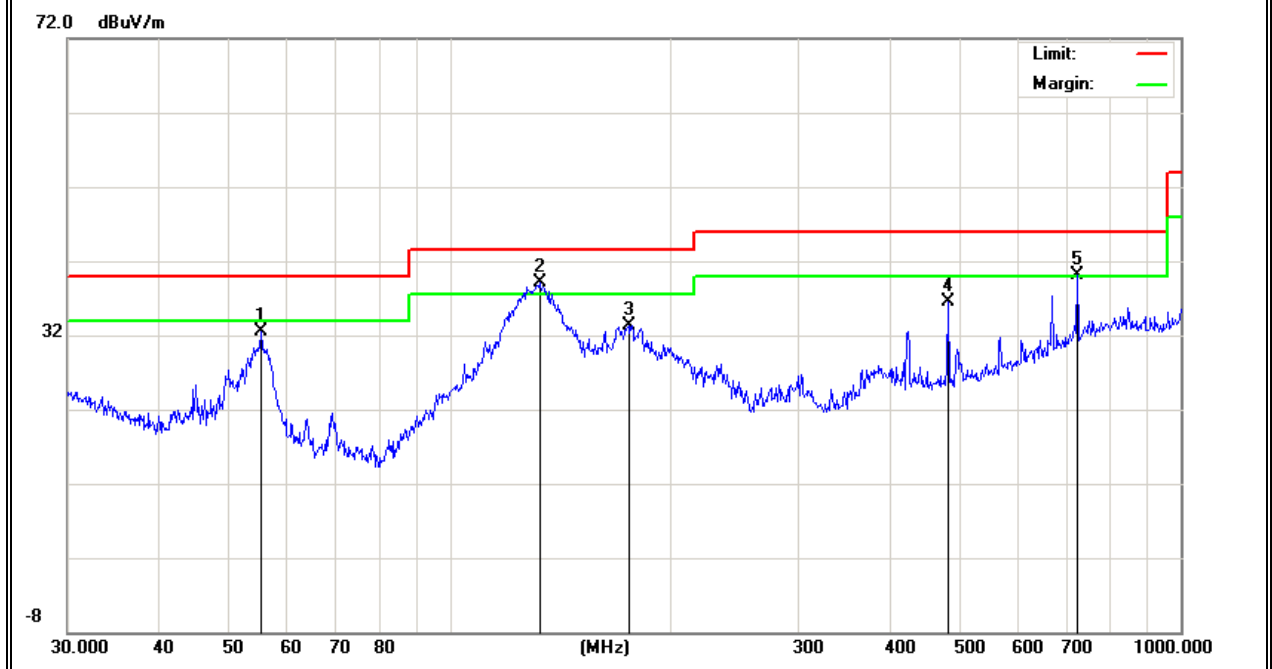

Polar (H/V)	Frequency	Meter Reading	Factor	Emission Level	Limits	Margin	Remark
	(MHz)	(dBuV)	(dB)	(dBuV/m)	(dBuV/m)	(dB)	
H	53.5052	24.64	9.69	34.33	40.00	-5.67	QP
H	138.8735	19.67	11.47	31.14	43.50	-12.36	QP
H	180.0165	23.40	10.63	34.03	43.50	-9.47	QP
H	300.3673	22.56	14.16	36.72	46.00	-9.28	QP
H	480.5276	20.07	19.91	39.98	46.00	-6.02	QP
H	668.1422	15.70	23.91	39.61	46.00	-6.39	QP

Remark:

Absolute Level= ReadingLevel+ Factor, Margin= Absolute Level - Limit

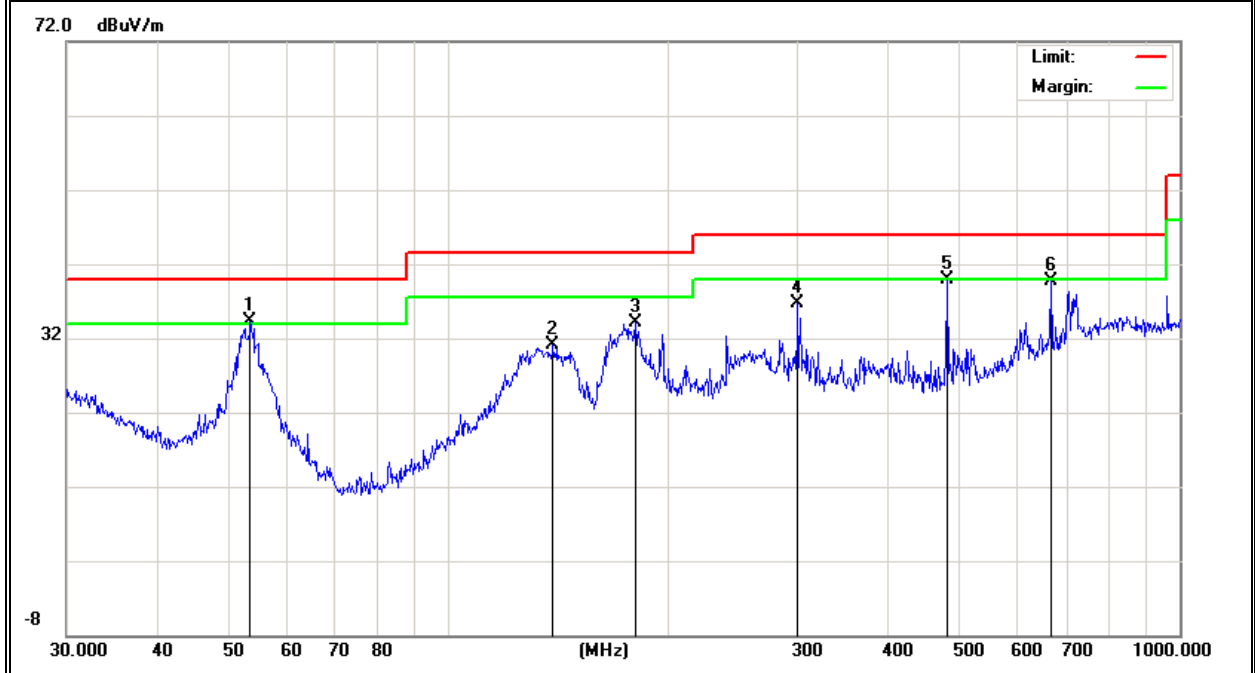

3.2.8 TEST RESULTS (ABOVE 1000 MHZ)

EUT :	Tablet PC	Model Name :	TBGP
Temperature :	20 °C	Relative Humidity :	48%
Pressure :	1010 hPa	Test Voltage :	DC 3.7V
Test Mode :	TX		

Polar (H/V)	Frequency	Meter Reading	Factor	Emission Level	Limits	Margin	Detector Type
	(MHz)	(dBuV)	(dB)	(dBuV/m)	(dBuV/m)	(dB)	
Low Channel (2412 MHz)-Above 1G							
Vertical	4824.000	44.12	10.44	54.56	74	-19.44	Pk
Vertical	4824.000	27.67	10.44	38.11	54	-15.89	AV
Vertical	7236.000	35.57	12.39	47.96	74	-26.04	pk
Horizontal	4824.000	43.68	10.44	54.12	74	-19.88	pk
Horizontal	4824.000	25.96	10.44	36.4	54	-17.6	AV
Horizontal	7236.000	30.54	12.39	42.93	74	-31.07	pk
Mid Channel (2437 MHz)-Above 1G							
Vertical	4874.000	47.19	10.4	57.59	74	-16.41	pk
Vertical	4874.000	31.66	10.4	42.06	54	-11.94	AV
Vertical	7311.000	35.71	12.75	48.46	74	-25.54	Pk
Horizontal	4874.000	45.36	10.4	55.76	74	-18.24	Pk
Horizontal	4874.000	28.16	10.4	38.56	54	-15.44	AV
Horizontal	7311.000	30.23	12.75	42.98	74	-31.02	Pk
High Channel (2462 MHz)- Above 1G							
Vertical	4924.000	46.13	10.39	56.52	74	-17.48	pk
Vertical	4924.000	32.41	10.39	42.8	54	-11.20	AV
Vertical	7386.000	33.24	12.68	45.92	74	-28.08	pk
Horizontal	4924.000	44.16	10.39	54.55	74	-19.45	pk
Horizontal	4924.000	28.43	10.39	38.82	54	-15.18	AV
Horizontal	7386.000	31.29	12.68	43.97	74	-30.03	pk

Note: "802.11b" mode is the worst mode. When PK value is lower than the Average value limit, average didn't record.

4. POWER SPECTRAL DENSITY TEST

4.1 APPLIED PROCEDURES / LIMIT

FCC Part15 (15.247) , Subpart C				
Section	Test Item	Limit	Frequency Range (MHz)	Result
15.247	Power Spectral Density	8 dBm (in any 3KHz)	2400-2483.5	PASS

4.1.1 TEST PROCEDURE

1. Set analyzer center frequency to DTS channel center frequency.
2. Set the span to 1.5 times the DTS channel bandwidth.
3. 3 kHz ≤ Set the RBW ≤ 100 kHz.
4. Set the VBW ≥ 3 x RBW.
5. Detector = peak.
6. Sweep time = auto couple.
7. Trace mode = max hold.
8. Allow trace to fully stabilize.
9. Use the peak marker function to determine the maximum amplitude level within the RBW.
10. If measured value exceeds limit, reduce RBW (no less than 3 kHz) and repeat.

4.1.2 DEVIATION FROM STANDARD

No deviation.

4.1.3 TEST SETUP

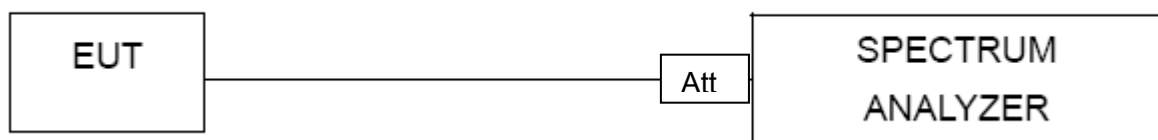

4.1.4 EUT OPERATION CONDITIONS

The EUT tested system was configured as the statements of 2.1 Unless otherwise a special operating condition is specified in the follows during the testing.

4.1.5 TEST RESULTS

EUT :	Tablet PC	Model Name :	TBGP
Temperature :	25 °C	Relative Humidity :	56%
Pressure :	1015 hPa	Test Voltage :	DC 3.7V
Test Mode :	TX b Mode /CH01, CH06, CH11		

Frequency	Power Density (dBm)	Limit (dBm)	Result
2412 MHz	-12.42	8	PASS
2437 MHz	-12.82	8	PASS
2462 MHz	-13.21	8	PASS

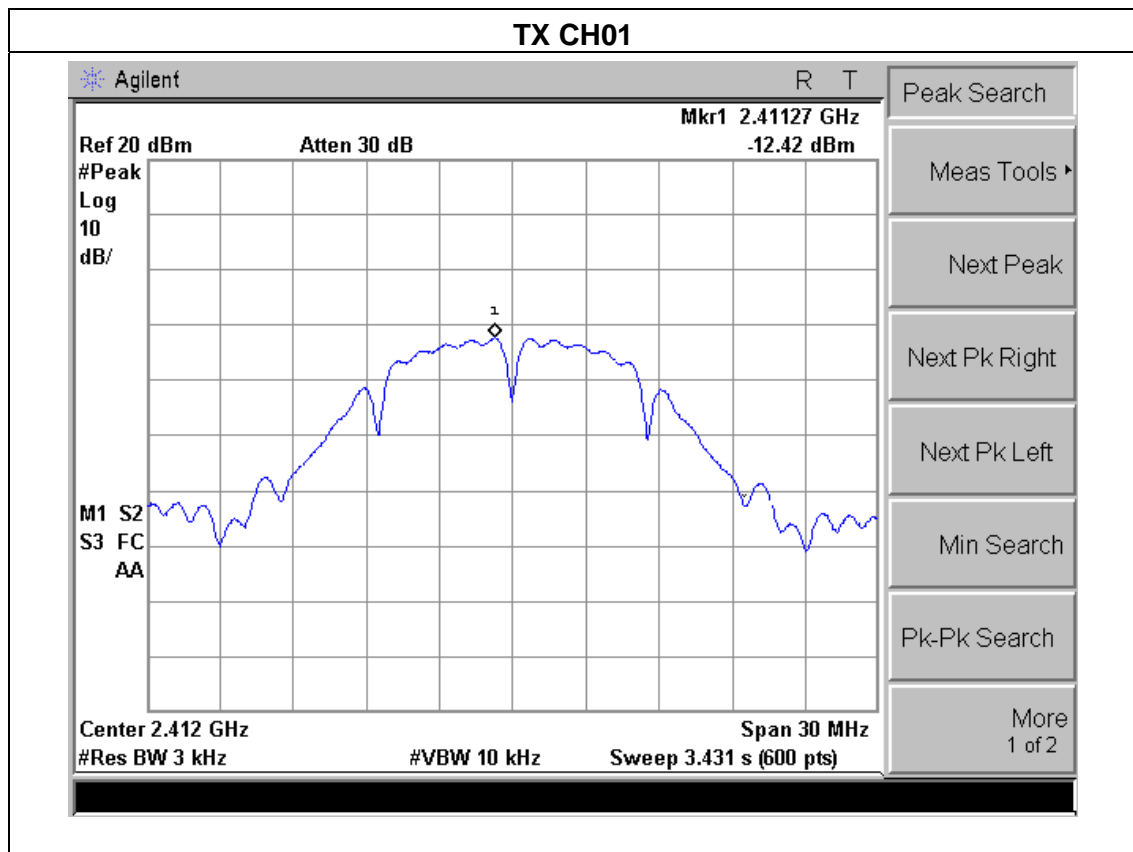

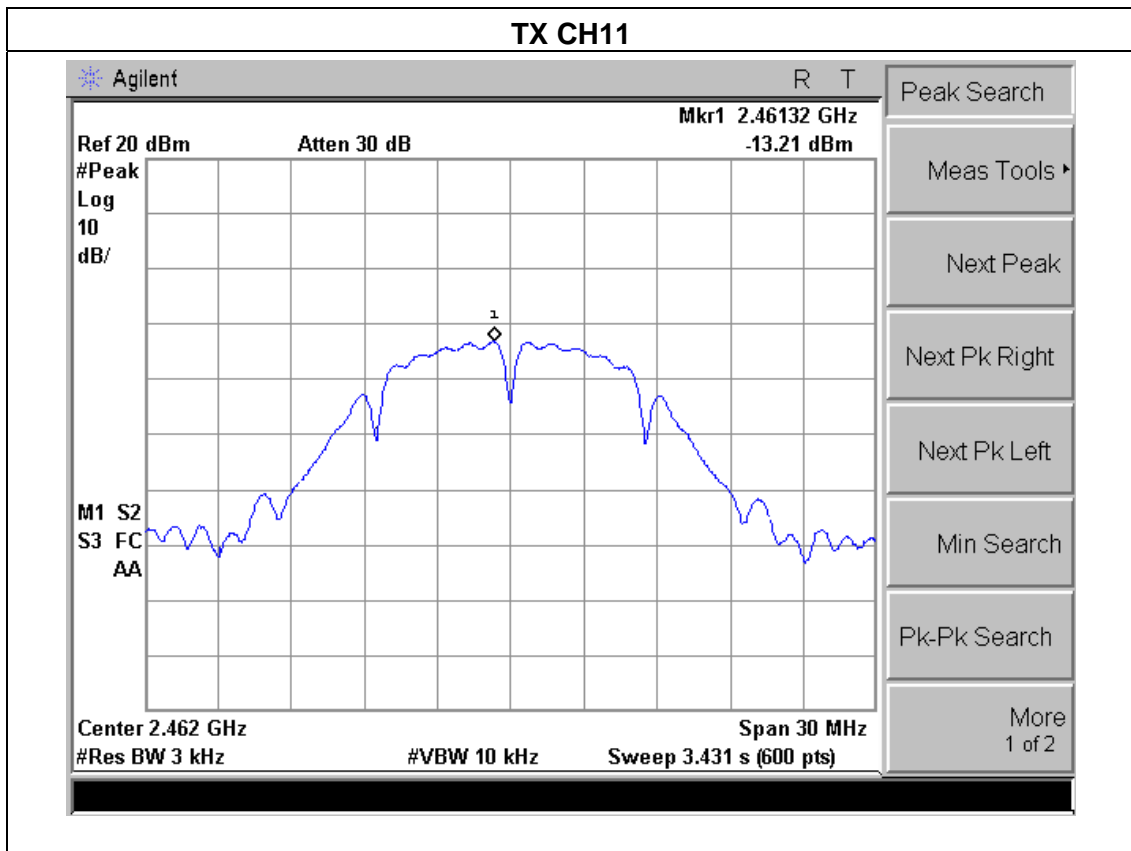
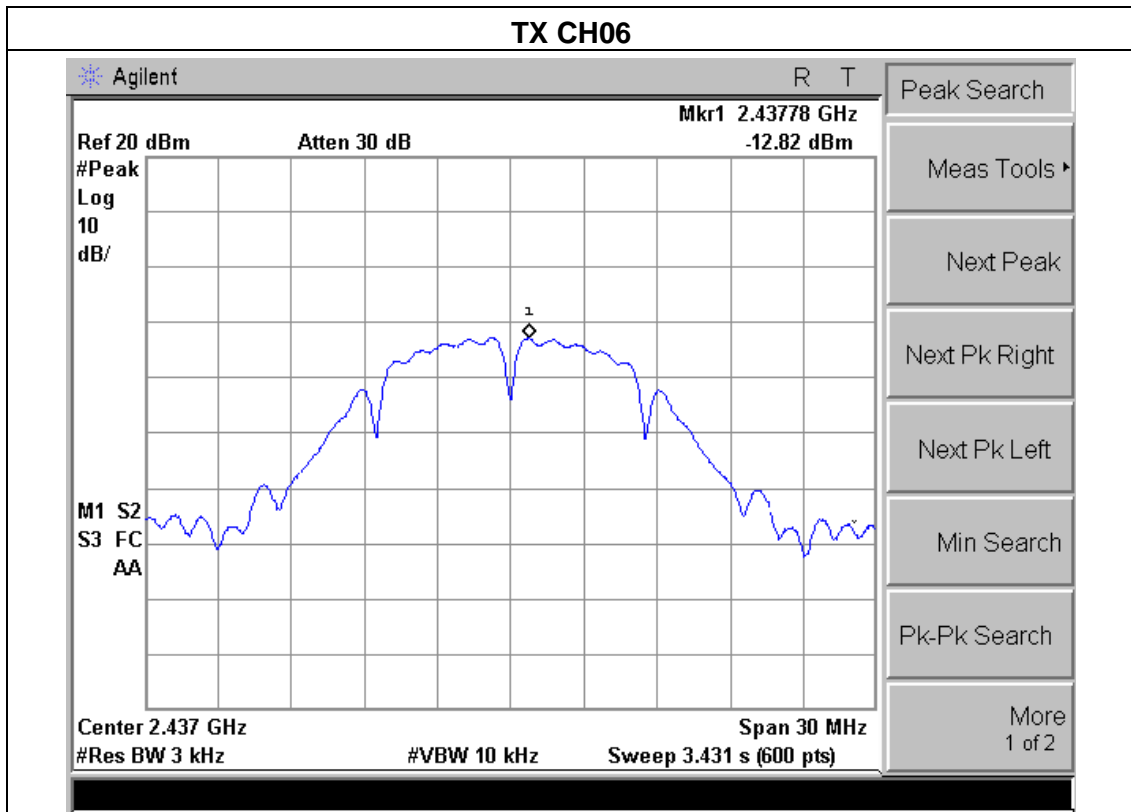

EUT :	Tablet PC	Model Name :	TBGP
Temperature :	25 °C	Relative Humidity :	56%
Pressure :	1015 hPa	Test Voltage :	DC 3.7V
Test Mode :	TX g Mode /CH01, CH06, CH11		

Frequency	Power Density (dBm)	Limit (dBm)	Result
2412 MHz	-13.42	8	PASS
2437 MHz	-14.16	8	PASS
2462 MHz	-15.19	8	PASS

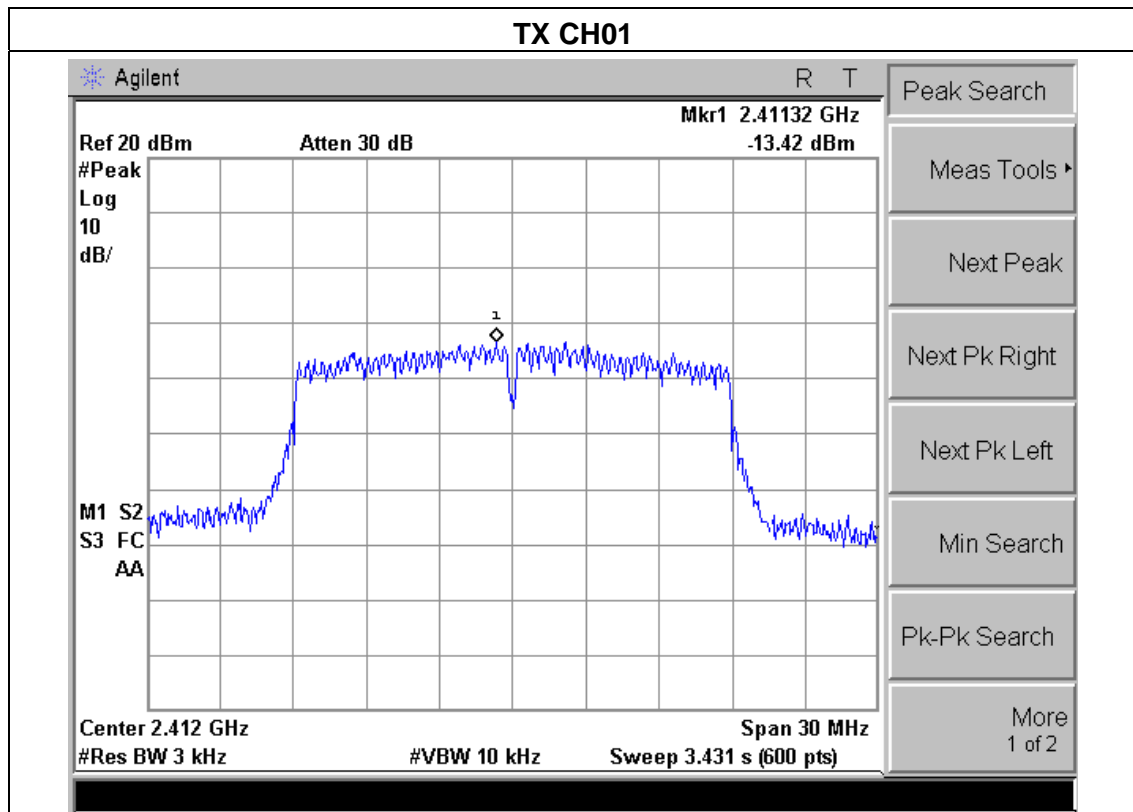

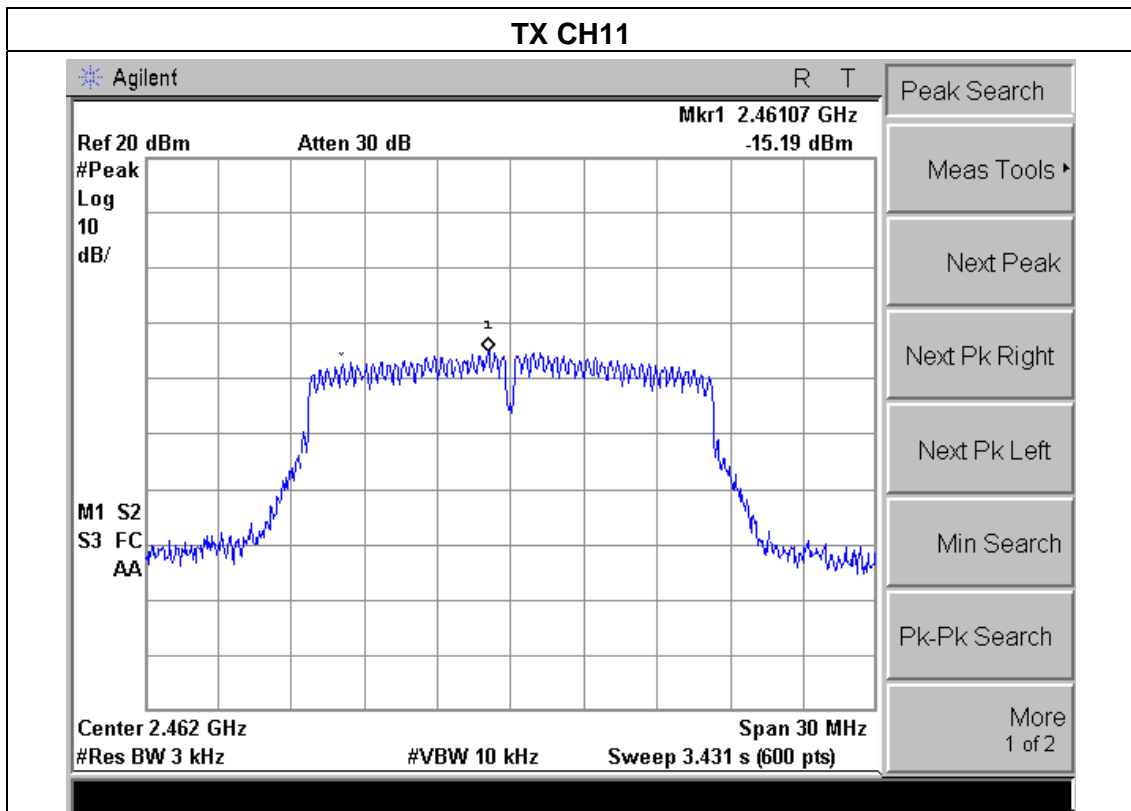
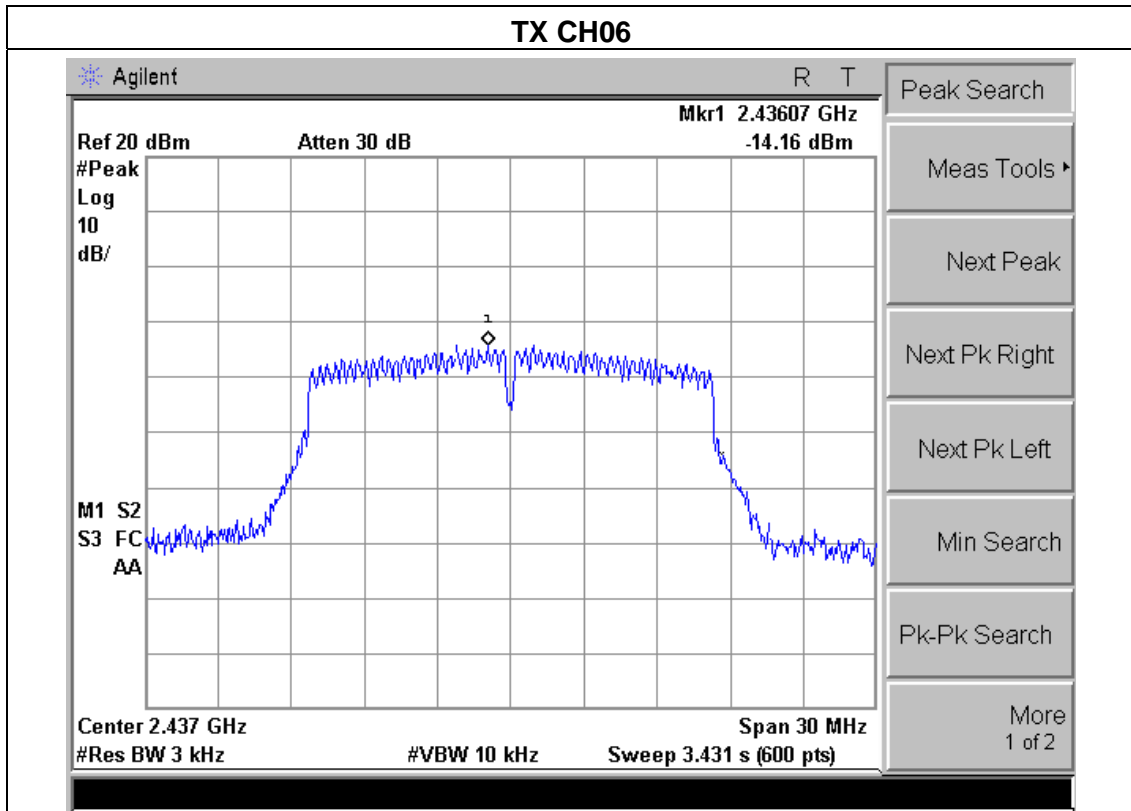

EUT :	Tablet PC	Model Name :	TBGP
Temperature :	25 °C	Relative Humidity :	56%
Pressure :	1015 hPa	Test Voltage :	DC 3.7V
Test Mode :	TX n Mode (20MHz)/CH01, CH06, CH11		

Frequency	Power Density (dBm)	Limit (dBm)	Result
2412 MHz	-13.42	8	PASS
2437 MHz	-14.10	8	PASS
2462 MHz	-14.56	8	PASS

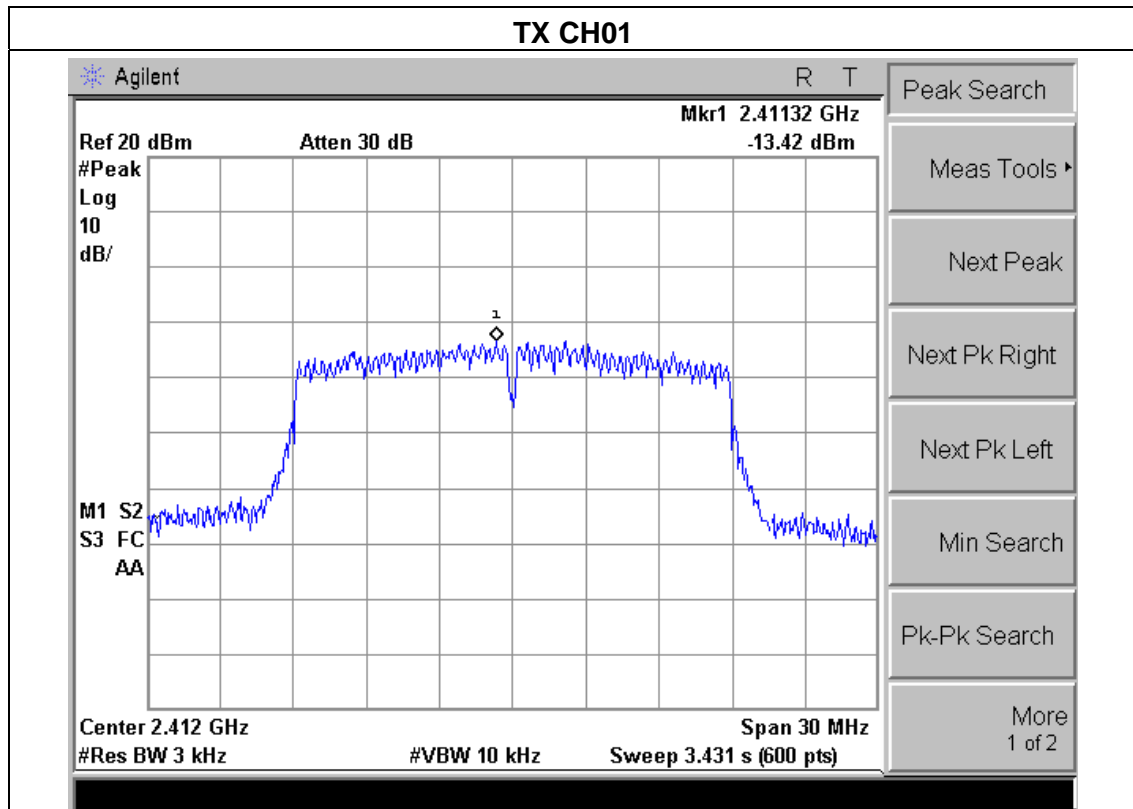

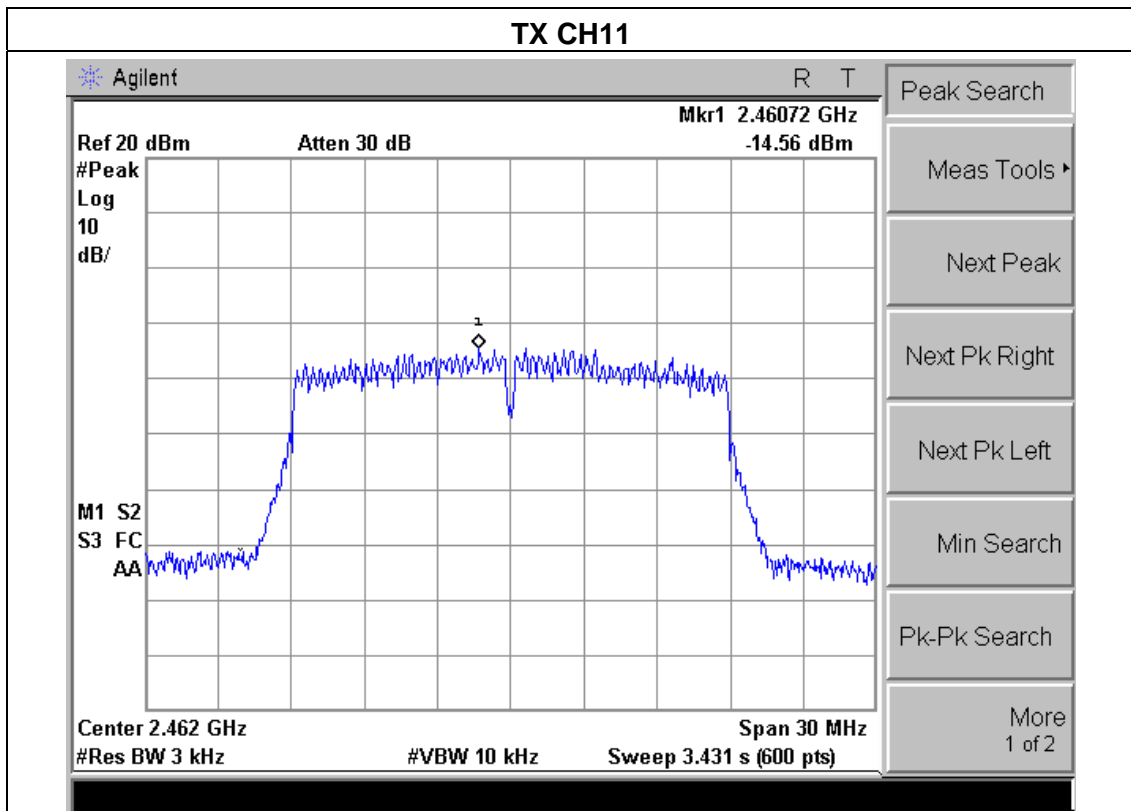
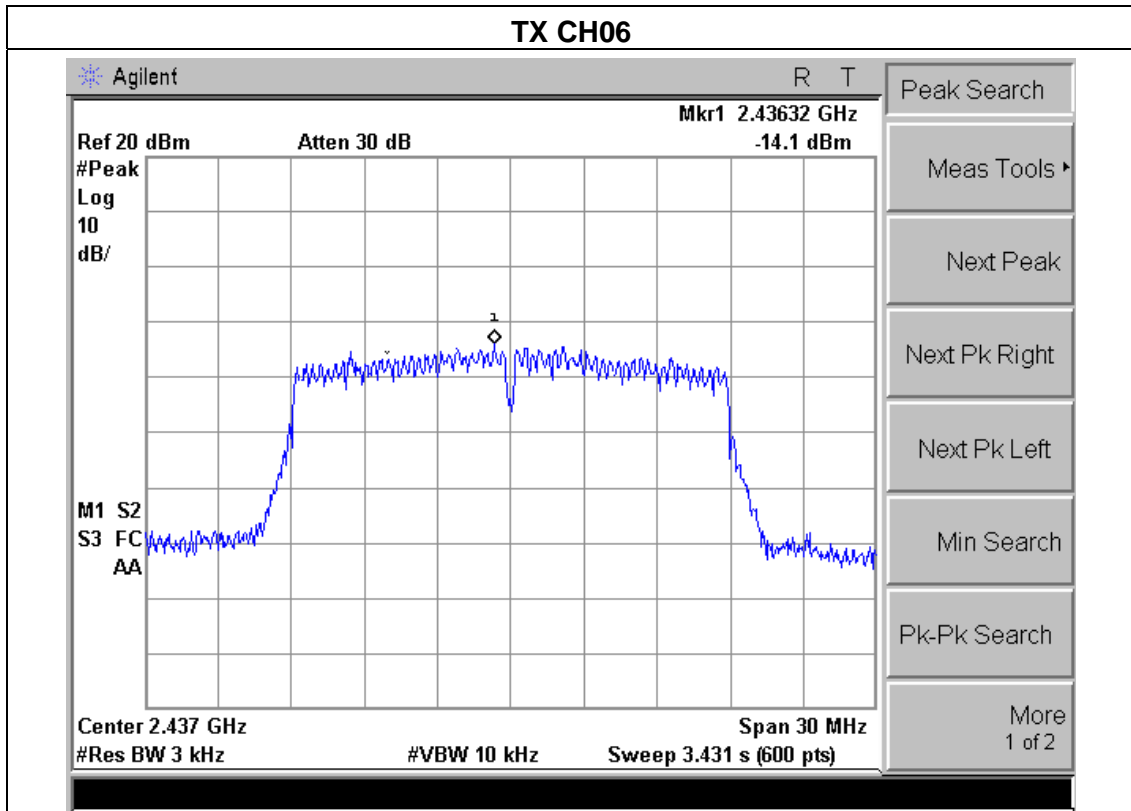

EUT :	Tablet PC	Model Name :	TBGP
Temperature :	25 °C	Relative Humidity :	56%
Pressure :	1015 hPa	Test Voltage :	DC 3.7V
Test Mode :	TX n Mode (40MHz)/CH03, CH06, CH09		

Frequency	Power Density (dBm)	Limit (dBm)	Result
2422 MHz	-17.53	8	PASS
2437 MHz	-17.66	8	PASS
2452 MHz	-18.25	8	PASS

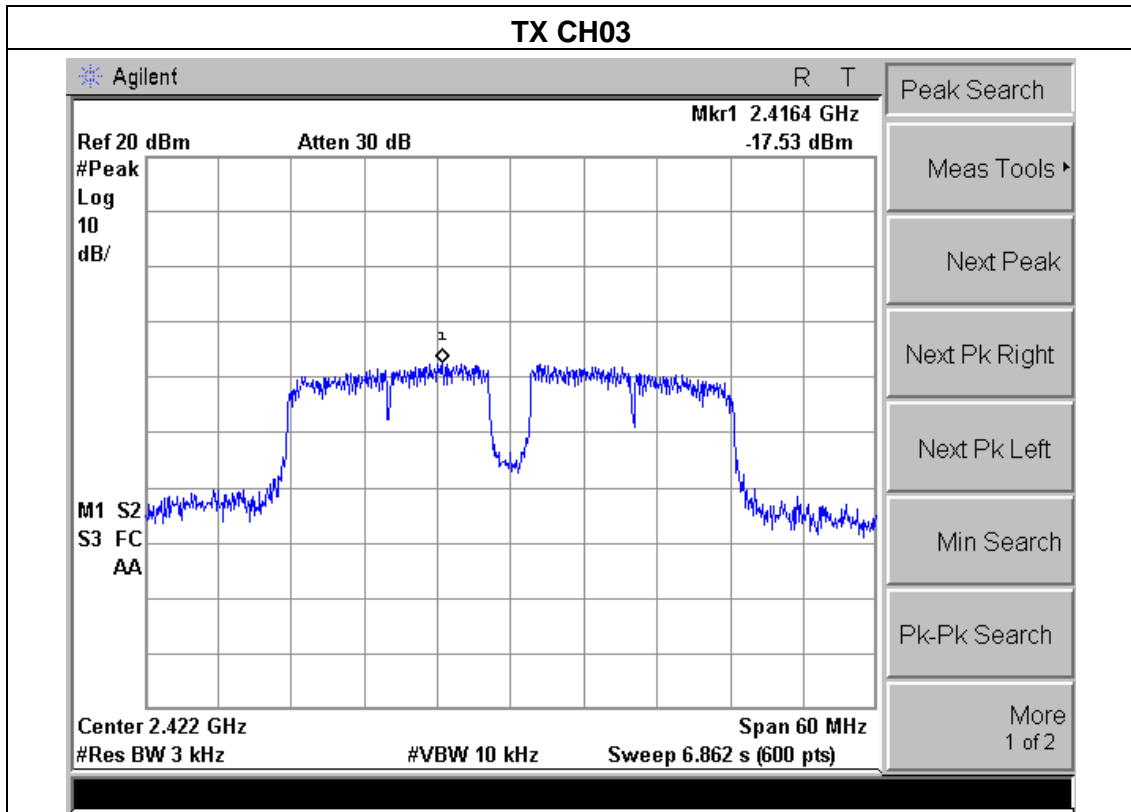

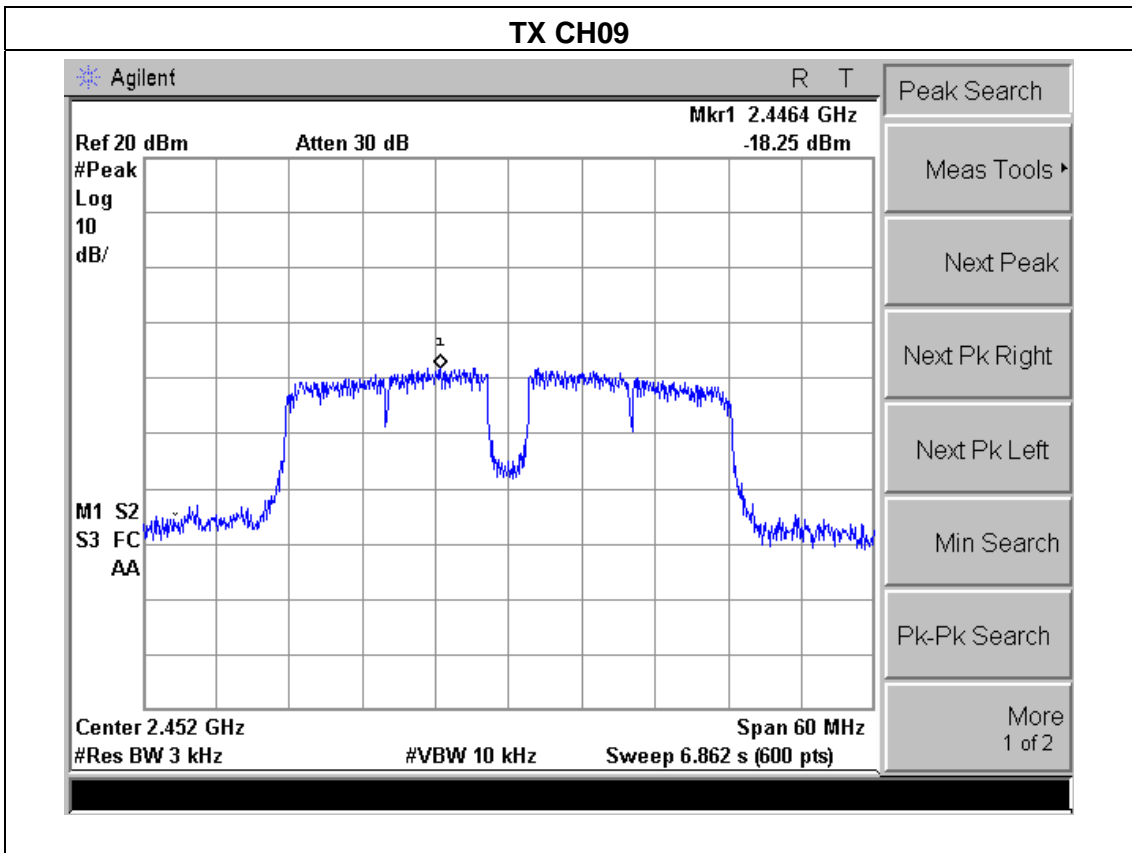
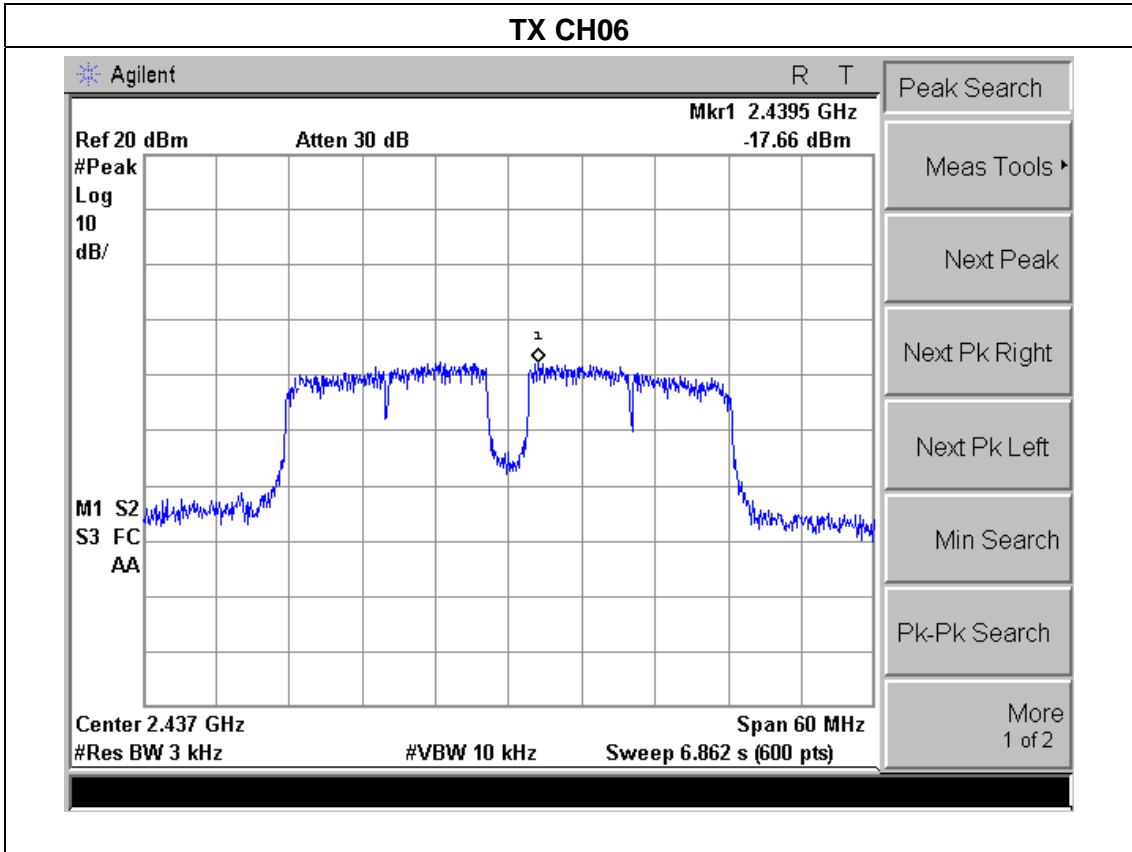

5. BANDWIDTH TEST

5.1 APPLIED PROCEDURES / LIMIT

FCC Part15 (15.247) , Subpart C				
Section	Test Item	Limit	Frequency Range (MHz)	Result
15.247(a)(2)	Bandwidth	$\geq 500\text{KHz}$ (6dB bandwidth)	2400-2483.5	PASS

5.1.1 TEST PROCEDURE

1. Set RBW = 100 kHz.
2. Set the video bandwidth (VBW) $\geq 3 \times$ RBW.
3. Detector = Peak.
4. Trace mode = max hold.
5. Sweep = auto couple.
6. Allow the trace to stabilize.
7. Measure the maximum width of the emission that is constrained by the frequencies associated with the two outermost amplitude points (upper and lower) that are attenuated by 6 dB relative to the maximum level measured in the fundamental emission.

TEST SETUP

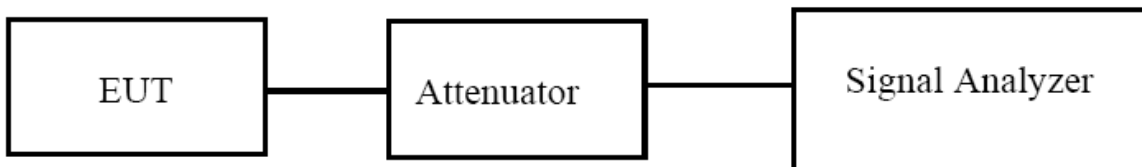

5.1.2 EUT OPERATION CONDITIONS

The EUT tested system was configured as the statements of 2.4 Unless otherwise a special operating condition is specified in the follows during the testing.

5.1.3 TEST RESULTS

EUT :	Tablet PC	Model Name :	TBGP
Temperature :	25 °C	Relative Humidity :	56%
Pressure :	1012 hPa	Test Voltage :	DC 3.7V
Test Mode :	TX b Mode /CH01, CH06, CH11		

Channel	Frequency (MHz)	6dB bandwidth (MHz)	Limit (kHz)	Result
Low	2412	9.583	500	Pass
Middle	2437	10.057	500	Pass
High	2462	9.162	500	Pass

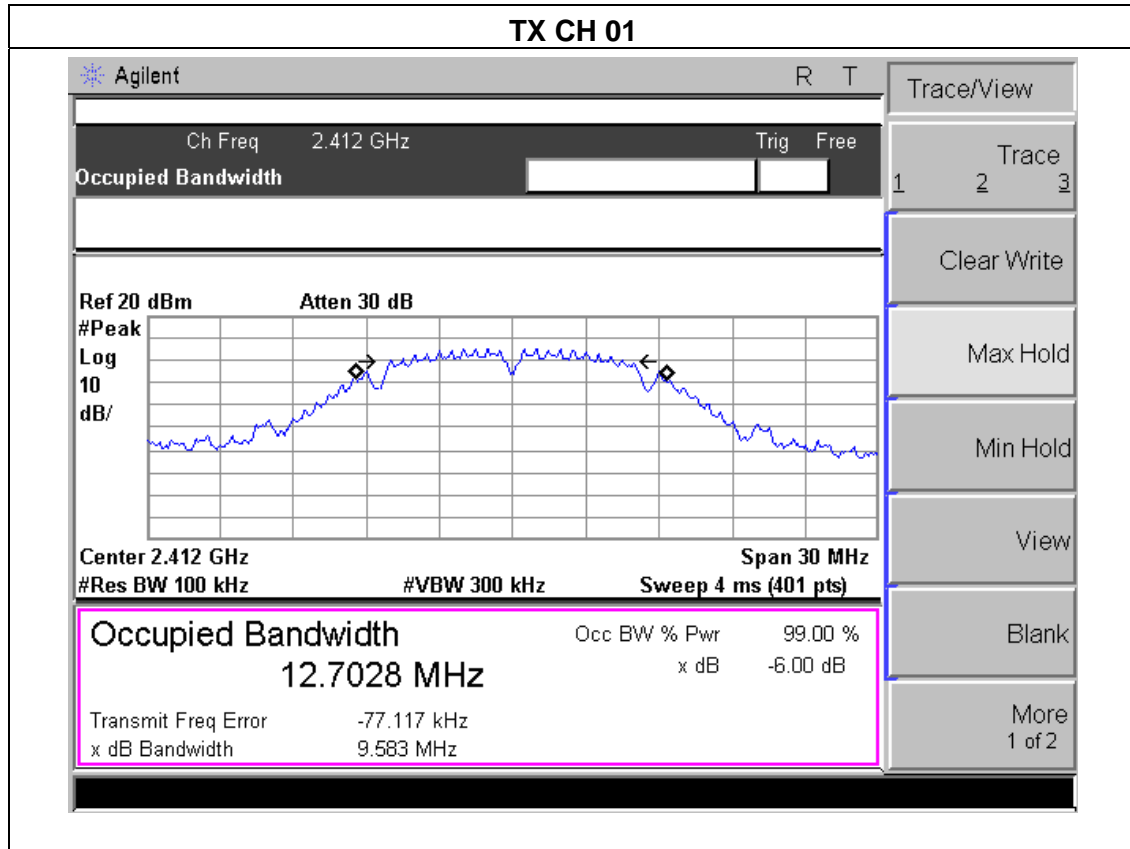

TX CH 06

Agilent
R T

Ch Freq 2.437 GHz
Trig Free

Occupied Bandwidth

Ref 20 dBm
Atten 30 dB

#Peak
Log
10
dB/

Freq/Channel

Center Freq 2.43700000 GHz

Start Freq 2.42200000 GHz

Stop Freq 2.45200000 GHz

CF Step 3.00000000 MHz
Auto Man

Freq Offset 0.00000000 Hz

Signal Track On Off

Scale Type Log Lin

Center 2.437 GHz
Span 30 MHz

#Res BW 100 kHz
#VBW 300 kHz
Sweep 4 ms (401 pts)

Occupied Bandwidth	Occ BW % Pwr	99.00 %
12.7977 MHz	x dB	-6.00 dB
Transmit Freq Error	-43.152 kHz	
x dB Bandwidth	10.057 MHz	

TX CH 11

Agilent
R T

Ch Freq 2.462 GHz
Trig Free

Occupied Bandwidth

Ref 20 dBm
Atten 30 dB

#Peak
Log
10
dB/

Freq/Channel

Center Freq 2.46200000 GHz

Start Freq 2.44700000 GHz

Stop Freq 2.47700000 GHz

CF Step 3.00000000 MHz
Auto Man

Freq Offset 0.00000000 Hz

Signal Track On Off

Scale Type Log Lin

Center 2.462 GHz
Span 30 MHz

#Res BW 100 kHz
#VBW 300 kHz
Sweep 4 ms (401 pts)

Occupied Bandwidth	Occ BW % Pwr	99.00 %
12.8486 MHz	x dB	-6.00 dB
Transmit Freq Error	-38.487 kHz	
x dB Bandwidth	9.162 MHz	

EUT :	Tablet PC	Model Name :	TBGP
Temperature :	25 °C	Relative Humidity :	60%
Pressure :	1012 hPa	Test Voltage :	DC 3.7V
Test Mode :	TX g Mode /CH01, CH06, CH11		

Channel	Frequency (MHz)	6dB bandwidth (MHz)	Limit (kHz)	Result
Low	2412	16.424	500	Pass
Middle	2437	16.404	500	Pass
High	2462	16.012	500	Pass

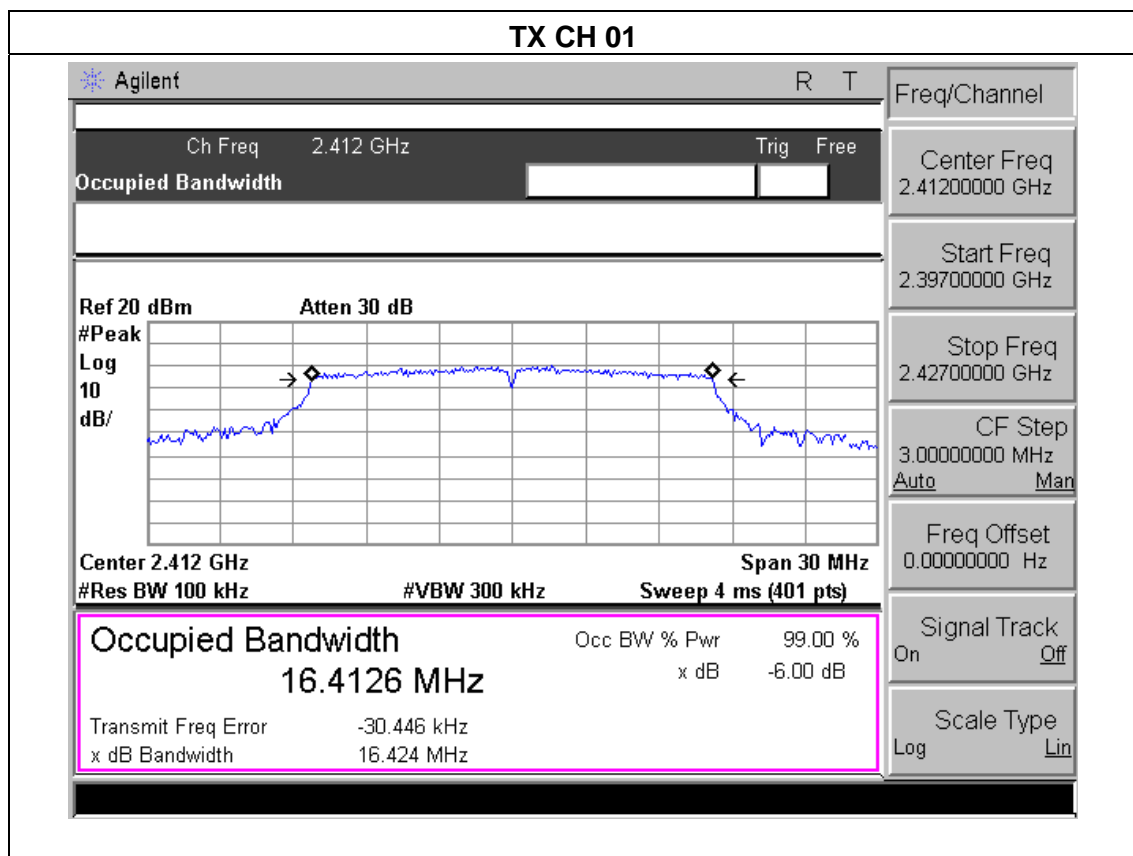

TX CH 06

Agilent
R T

Ch Freq 2.437 GHz
Trig Free

Occupied Bandwidth

Ref 20 dBm
Atten 30 dB

#Peak
Log
10
dB/

Center 2.437 GHz Span 30 MHz

#Res BW 100 kHz #VBW 300 kHz Sweep 4 ms (401 pts)

Occupied Bandwidth Occ BW % Pwr 99.00 %

16.3742 MHz x dB -6.00 dB

Transmit Freq Error -1.281 kHz

x dB Bandwidth 16.404 MHz

Freq/Channel

Center Freq 2.43700000 GHz

Start Freq 2.42200000 GHz

Stop Freq 2.45200000 GHz

CF Step 3.00000000 MHz
Auto Man

Freq Offset 0.00000000 Hz

Signal Track On Off

Scale Type Log Lin

TX CH 11

Agilent
R T

Ch Freq 2.462 GHz
Trig Free

Occupied Bandwidth

Ref 20 dBm
Atten 30 dB

#Peak
Log
10
dB/

Center 2.462 GHz Span 30 MHz

#Res BW 100 kHz #VBW 300 kHz Sweep 4 ms (401 pts)

Occupied Bandwidth Occ BW % Pwr 99.00 %

16.3532 MHz x dB -6.00 dB

Transmit Freq Error -5.011 kHz

x dB Bandwidth 16.012 MHz

Trace/View

Trace 1 2 3

Clear Write

Max Hold

Min Hold

View

Blank

More 1 of 2

EUT :	Tablet PC	Model Name :	TBGP
Temperature :	25 °C	Relative Humidity :	56%
Pressure :	1012 hPa	Test Voltage :	DC 3.7V
Test Mode :	TX n Mode(20M) /CH01, CH06, CH11		

Channel	Frequency (MHz)	6dB bandwidth (MHz)	Limit (kHz)	Result
Low	2412	17.643	500	Pass
Middle	2437	17.636	500	Pass
High	2462	17.626	500	Pass

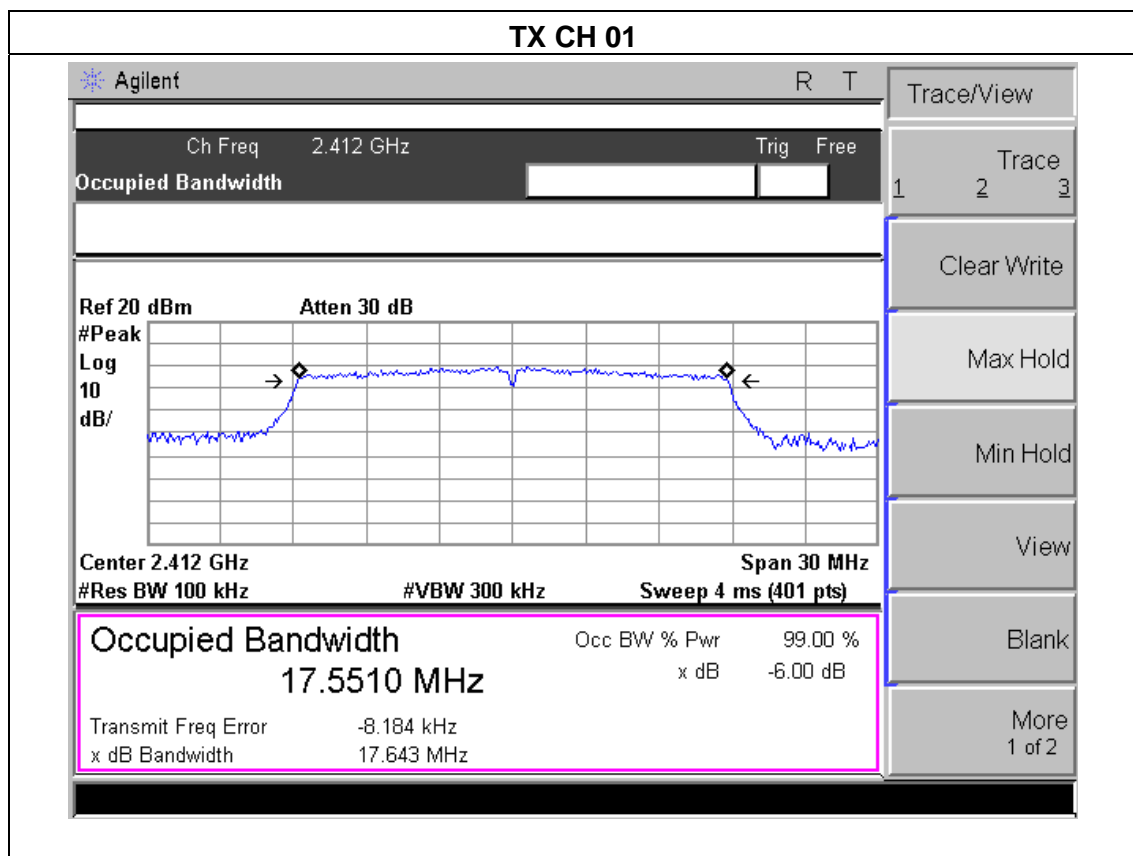

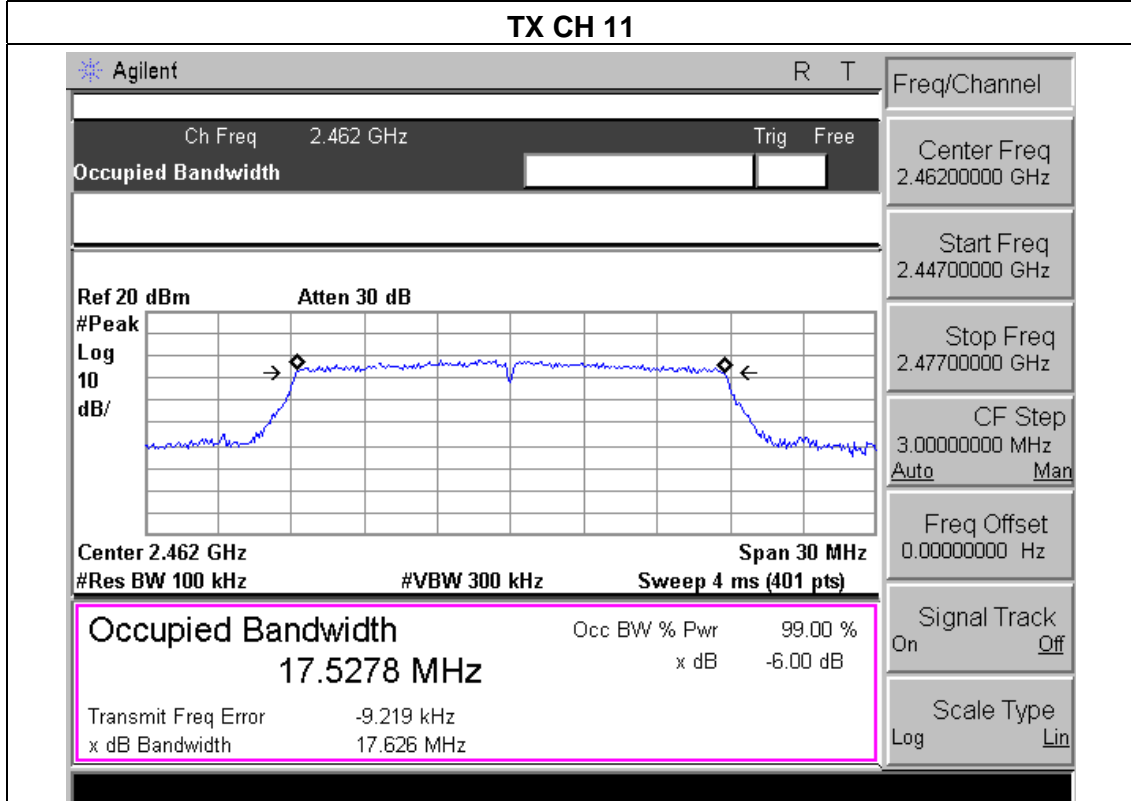
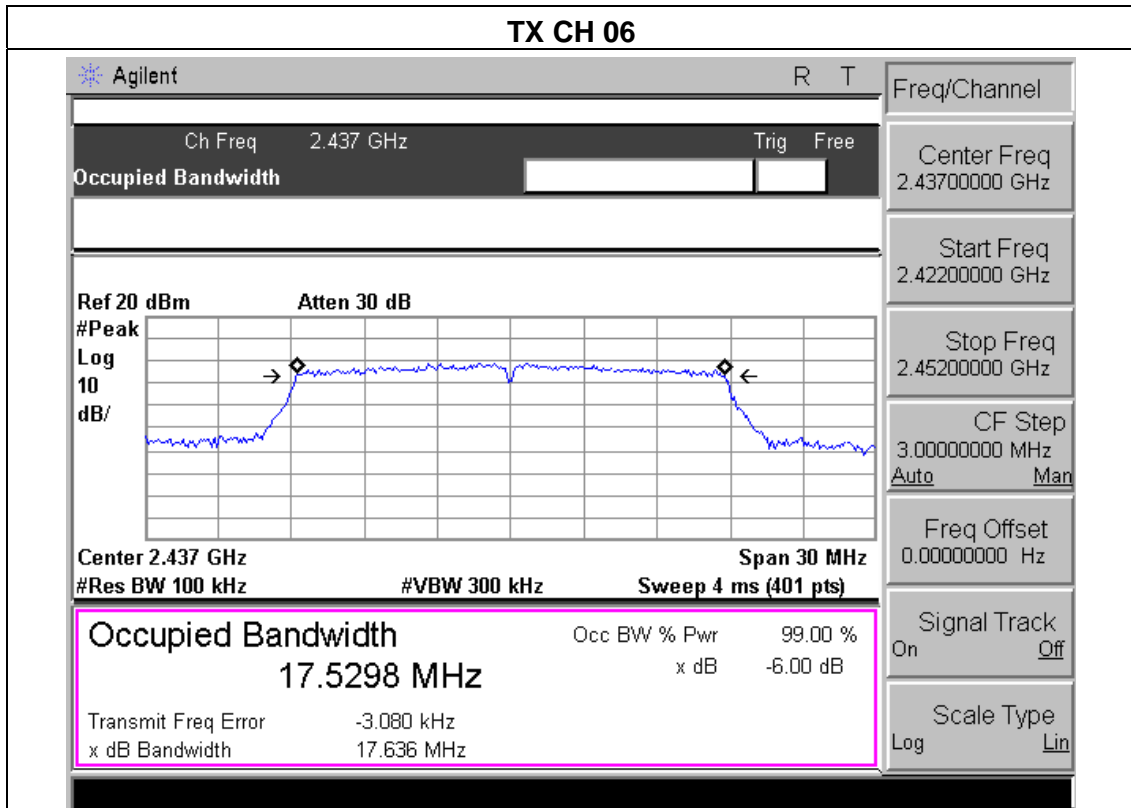

EUT :	Tablet PC	Model Name :	TBGP
Temperature :	25 °C	Relative Humidity :	56%
Pressure :	1012 hPa	Test Voltage :	DC 3.7V
Test Mode :	TX n Mode(40M) /CH03, CH06, CH09		

Channel	Frequency (MHz)	6dB bandwidth (MHz)	Limit (kHz)	Result
Low	2422	36.106	500	Pass
Middle	2437	36.081	500	Pass
High	2452	36.004	500	Pass

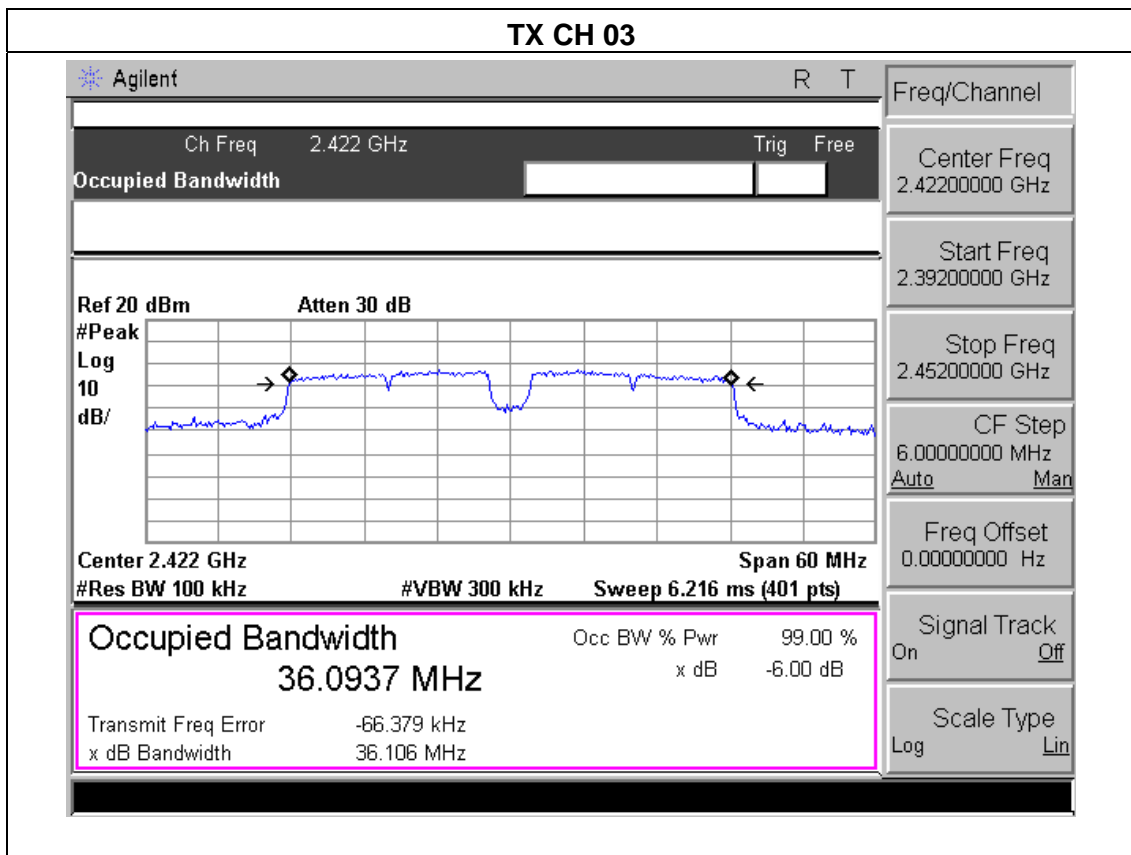

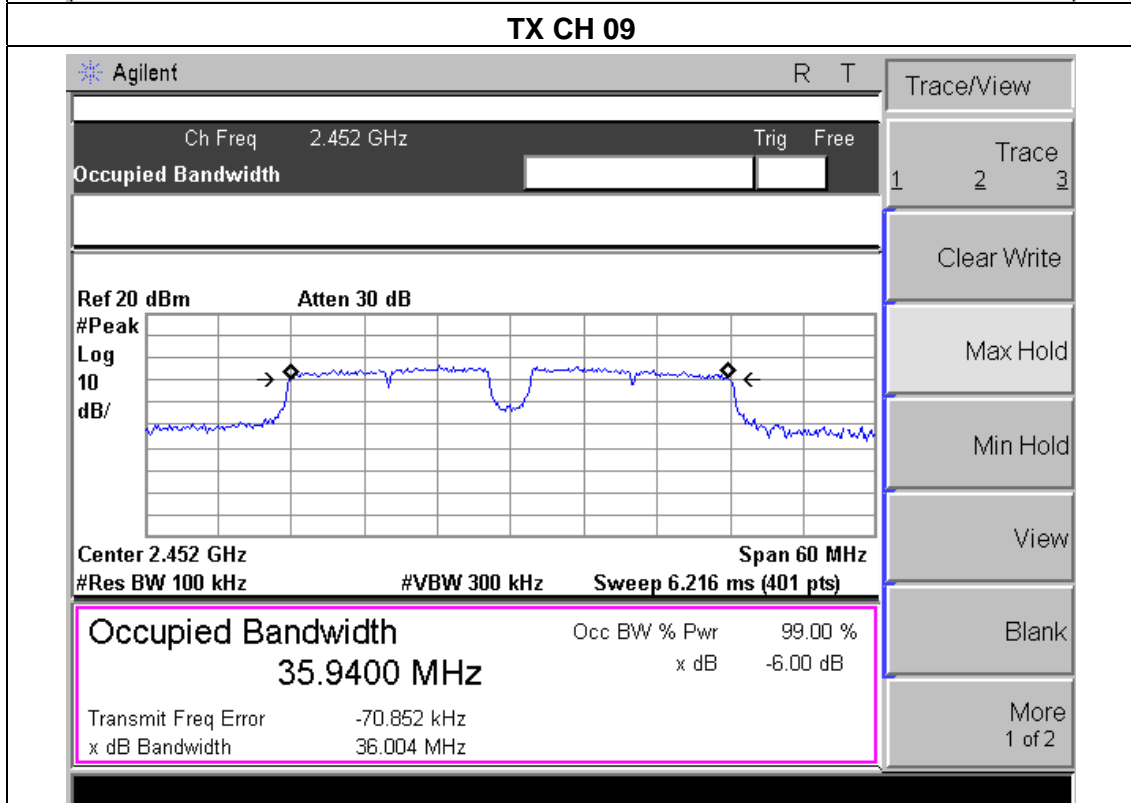
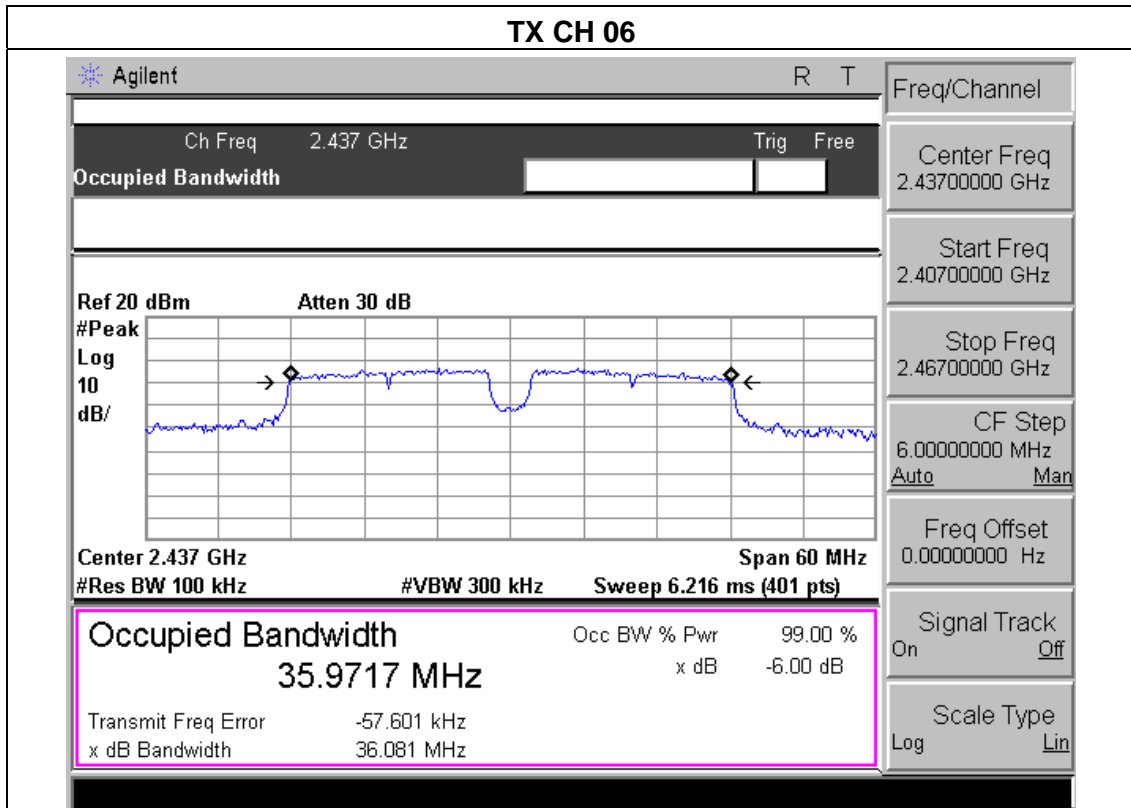

6. PEAK OUTPUT POWER TEST

6.1 APPLIED PROCEDURES / LIMIT

FCC Part15 (15.247) , Subpart C				
Section	Test Item	Limit	Frequency Range (MHz)	Result
15.247(b)(3)	Peak Output Power	1 watt or 30dBm	2400-2483.5	PASS

6.1.1 TEST PROCEDURE

- a. The EUT was directly connected to the Power meter

6.1.2 DEVIATION FROM STANDARD

No deviation.

6.1.3 TEST SETUP

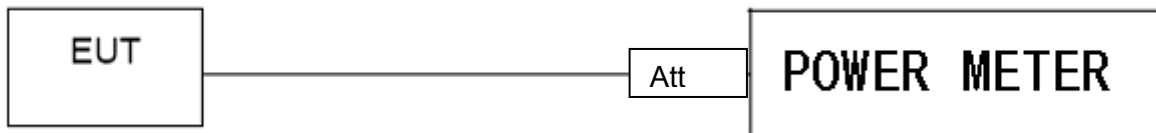

6.1.4 EUT OPERATION CONDITIONS

The EUT tested system was configured as the statements of 2.4 Unless otherwise a special operating condition is specified in the follows during the testing.

6.1.5 TEST RESULTS

EUT :	Tablet PC	Model Name :	TBGP
Temperature :	25 °C	Relative Humidity :	60%
Pressure :	1012 hPa	Test Voltage :	DC 3.7V
Test Mode :	TX b/g/n(20M/40M) Mode		

TX 802.11b Mode				
Test Channel	Frequency	Maximum Peak Conducted Output Power (PK)	Maximum Peak Conducted Output Power (AV)	LIMIT
	(MHz)	(dBm)	(dBm)	dBm
CH01	2412	11.27	9.16	30
CH06	2437	11.61	9.37	30
CH11	2462	11.53	9.25	30
TX 802.11g Mode				
CH01	2412	11.13	8.45	30
CH06	2437	10.38	8.24	30
CH11	2462	10.24	8.53	30
TX 802.11n(20) Mode				
CH01	2412	10.15	7.14	30
CH06	2437	10.41	7.42	30
CH11	2462	10.30	7.53	30
TX 802.11n(40) Mode				
CH03	2422	10.17	7.10	30
CH06	2437	10.04	7.21	30
CH09	2452	10.21	7.34	30

7. 100 KHZ BANDWIDTH OF FREQUENCY BAND EDGE

APPLICABLE STANDARD

In any 100 kHz bandwidth outside the frequency band in which the spread spectrum or digitally modulated intentional radiator is operating, the radio frequency power that is produced by the intentional radiator shall be at least 20 dB below that in the 100 kHz bandwidth within the band that contains the highest level of the desired power, based on either an RF conducted or a radiated measurement, provided the transmitter demonstrates compliance with the peak conducted power limits. If the transmitter complies with the conducted power limits based on the use of RMS averaging over a time interval, as permitted under paragraph (b)(3) of this section, the attenuation required under this paragraph shall be 30 dB instead of 20 dB. Attenuation below the general limits specified in §15.209(a) is not required. In addition, radiated emissions which fall in the restricted bands, as defined in §15.205(a), must also comply with the radiated emission limits specified in §15.209(a) (see §15.205(c)).

TEST PROCEDURE

- a) Check the calibration of the measuring instrument using either an internal calibrator or a known signal from an external generator.
- b) Position the EUT without connection to measurement instrument. Turn on the EUT and connect its antenna terminal to measurement instrument via a low loss cable. Then set it to any one measured frequency within its operating range, and make sure the instrument is operated in its linear range.
- c) Set RBW to 100 kHz and VBW of spectrum analyzer to 300 kHz with a convenient frequency span including 100 kHz bandwidth from band edge.
- d) Measure the highest amplitude appearing on spectral display and set it as a reference level. Plot the graph with marking the highest point and edge frequency.
- e) Repeat above procedures until all measured frequencies were complete.

7.1 DEVIATION FROM STANDARD

No deviation.

7.2 TEST SETUP

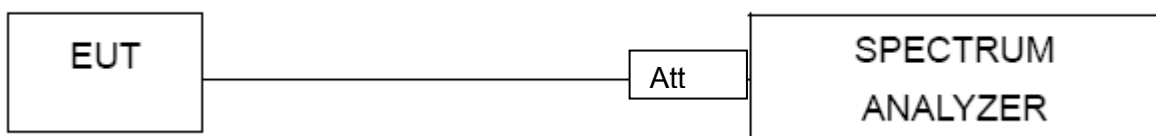

7.3 EUT OPERATION CONDITIONS

The EUT tested system was configured as the statements of 2.4 Unless otherwise a special operating condition is specified in the follows during the testing.

7.4 TEST RESULTS

EUT :	Tablet PC	Model Name :	TBGP
Temperature :	25 °C	Relative Humidity :	56%
Pressure :	1012 hPa	Test Voltage :	DC 3.7V

Frequency Band MHz	Delta Peak to band emission (dBc)	> Limit (dBc)	Result
802.11b mode			
2400	37.32	20	Pass
2483.5	53.11	20	Pass
802.11g mode			
2400	26.49	20	Pass
2483.5	41.52	20	Pass
802.11n-HT20 mode			
2400	25.86	20	Pass
2483.5	38.41	20	Pass
802.11n-HT40 mode			
2400	34.16	20	Pass
2483.5	42.67	20	Pass

Radiated band edge:

Frequency (MHz)	Meter Reading (dBμV)	Factor (dB)	Emission Level (dBμV/m)	Limits (dBμV/m)	Margin (dB)	Detector Type	Comment
802.11b							
2390	67.61	-13.06	54.55	74	-19.45	peak	Vertical
2390	49.77	-13.06	36.71	54	-17.29	Avg	Vertical
2390	66.73	-13.06	53.67	74	-20.33	peak	Horizontal
2483.5	67.64	-12.78	54.86	74	-19.14	peak	Vertical
2483.5	48.76	-12.78	35.98	54	-18.02	Avg	Vertical
2483.5	66.41	-12.78	53.63	74	-20.37	peak	Horizontal
802.11g							
2390	63.42	-13.06	50.36	74	-23.64	peak	Vertical
2390	65.34	-13.06	52.28	74	-21.72	peak	Horizontal
2483.5	67.04	-12.78	54.26	74	-19.74	peak	Vertical
2483.5	45.65	-12.78	32.87	54	-21.13	Avg	Vertical
2483.5	63.57	-12.78	50.79	74	-23.21	peak	Horizontal
802.11n (20)							
2390	69.83	-13.06	56.77	74	-17.23	peak	Vertical
2390	48.64	-13.06	35.58	54	-18.42	Avg	Vertical
2390	64.14	-13.06	51.08	74	-22.92	peak	Horizontal
2483.5	69.43	-12.78	56.65	74	-17.35	peak	Vertical
2483.5	53.75	-12.78	40.97	54	-13.03	Avg	Vertical
2483.5	68.76	-12.78	55.98	74	-18.02	peak	Horizontal
2483.5	50.37	-12.78	37.59	54	-16.41	Avg	Horizontal
802.11n (40)							
2390	69.41	-13.06	56.35	74	-17.65	peak	Vertical
2390	54.87	-13.06	41.81	54	-12.19	Avg	Vertical
2390	68.24	-13.06	55.18	74	-18.82	peak	Horizontal
2390	52.54	-13.06	39.48	54	-14.52	Avg	Horizontal
2483.5	66.71	-12.78	53.93	74	-20.07	peak	Vertical
2483.5	65.84	-12.78	53.06	74	-20.94	peak	Horizontal

Note: Test method to see chapter 3.2 . When PK value is lower than the Average value limit, average not record.

802.11b: Band Edge, Right Side

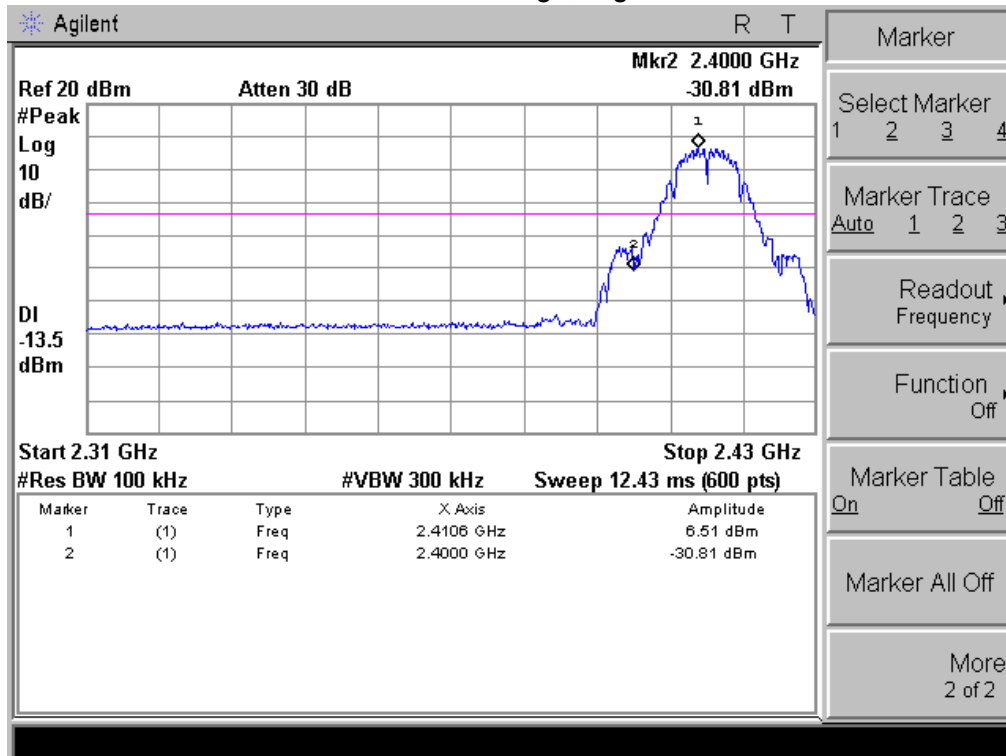

802.11b: Band Edge, Left Side

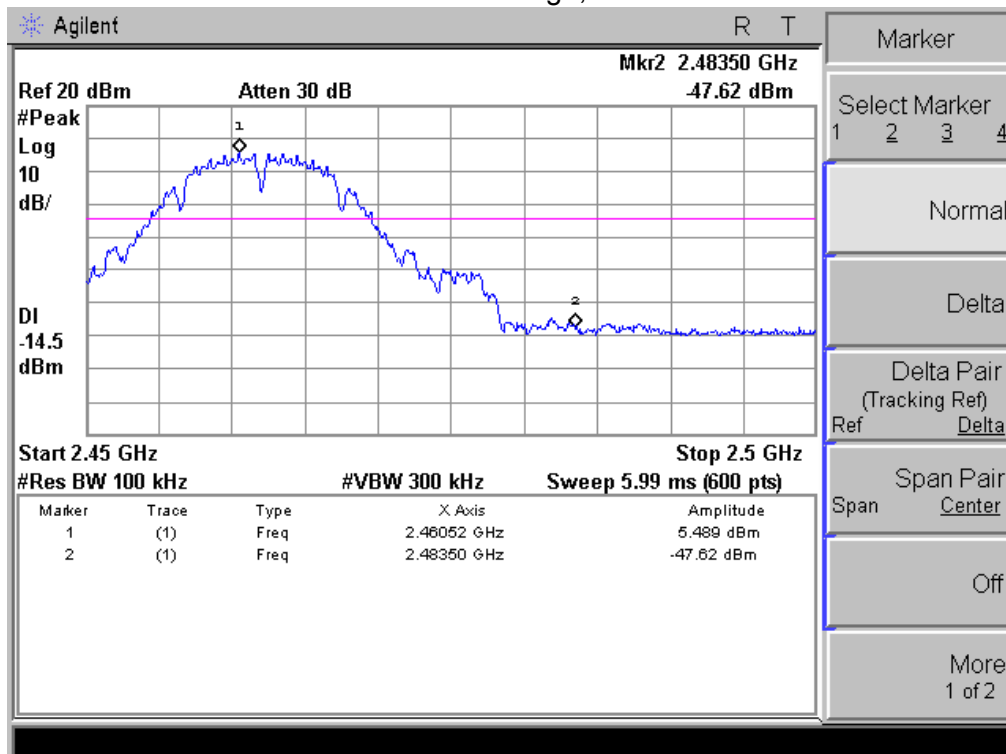

802.11g: Band Edge, Right Side

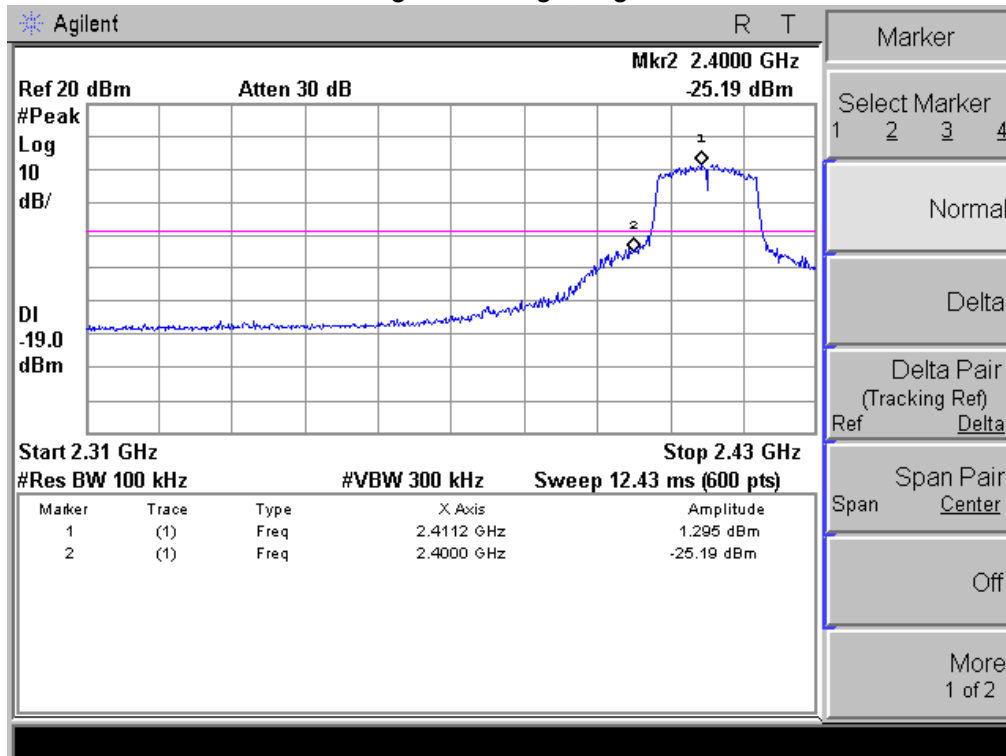

802.11g: Band Edge, Left Side

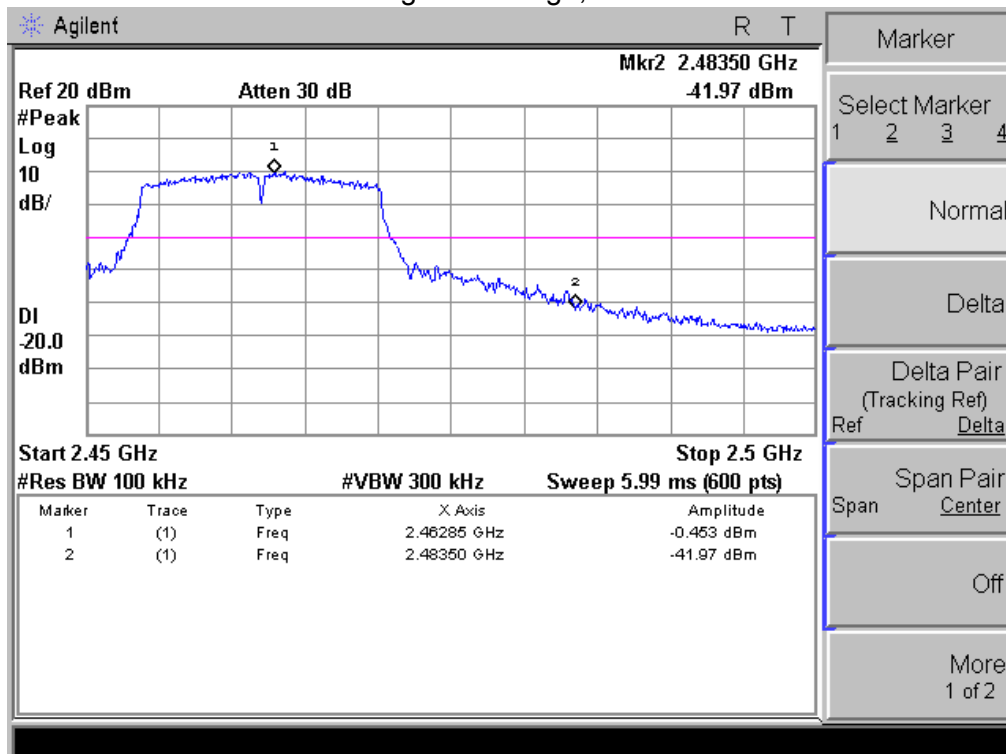

802.11n-HT20: Band Edge, Right Side

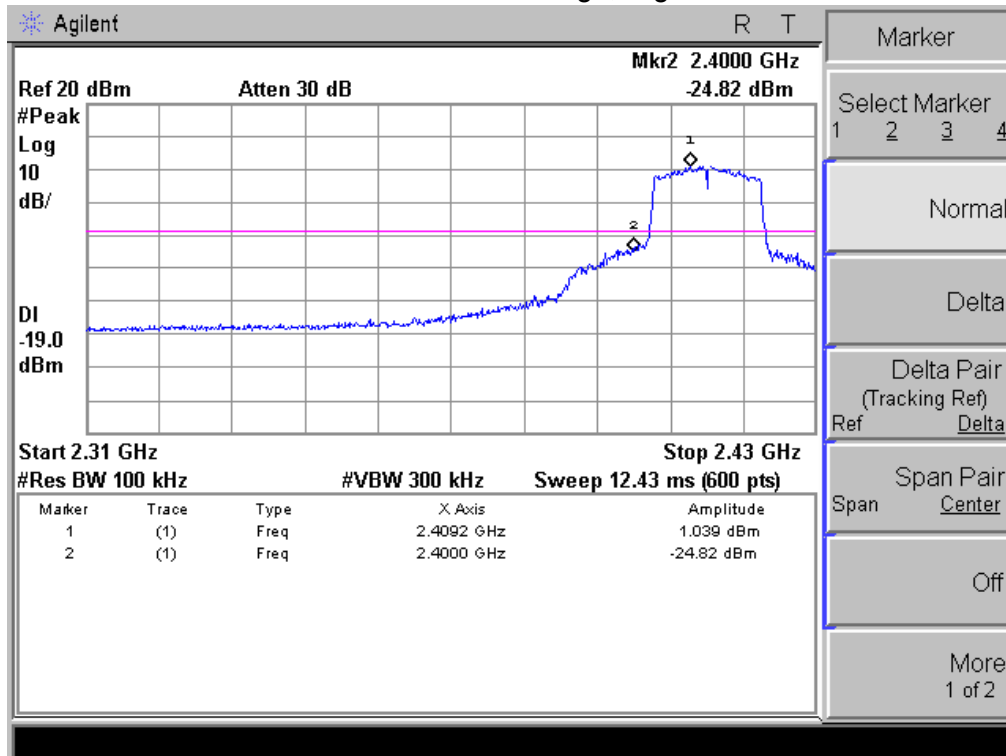

802.11n-HT20: Band Edge, Left Side

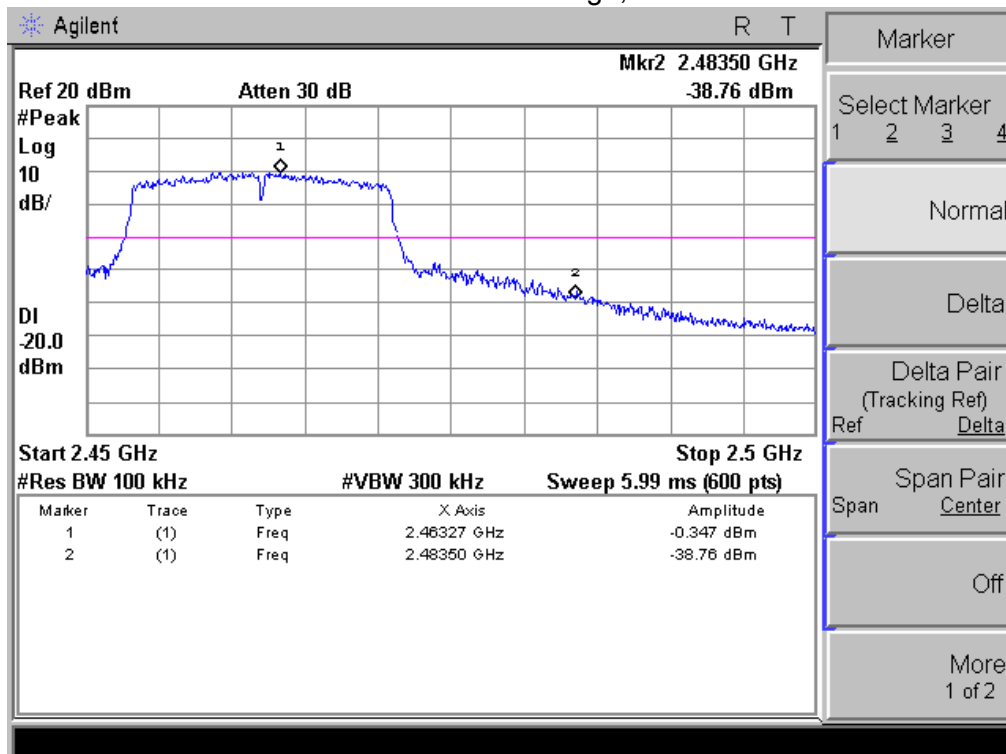

802.11n-HT40: Band Edge, Right Side

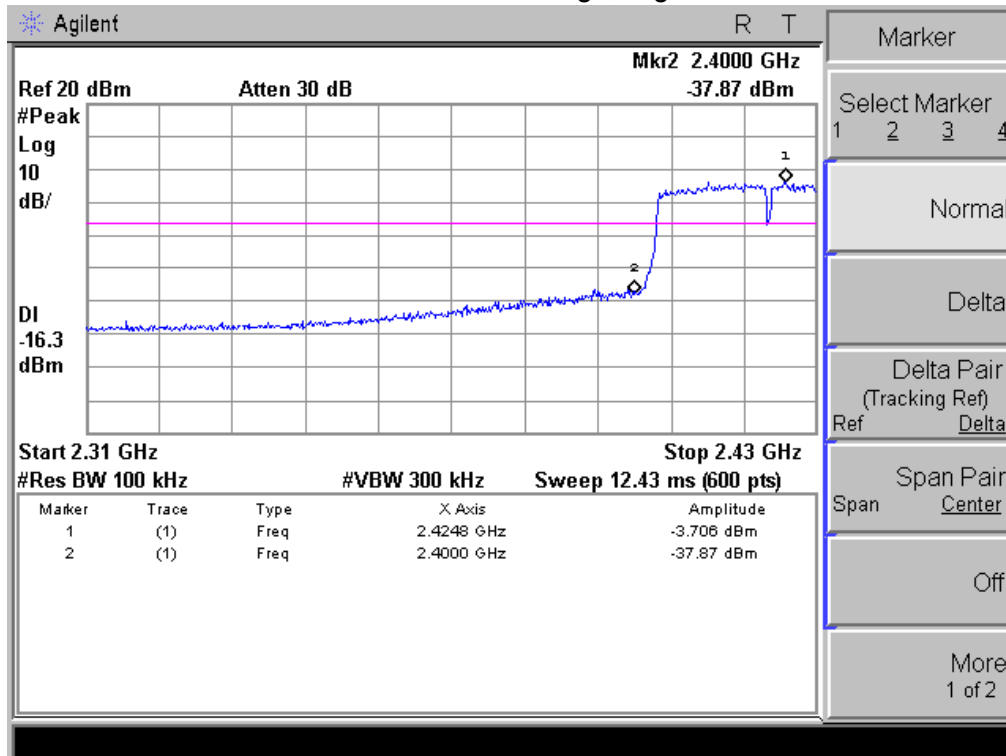

802.11n-HT40: Band Edge, Left Side

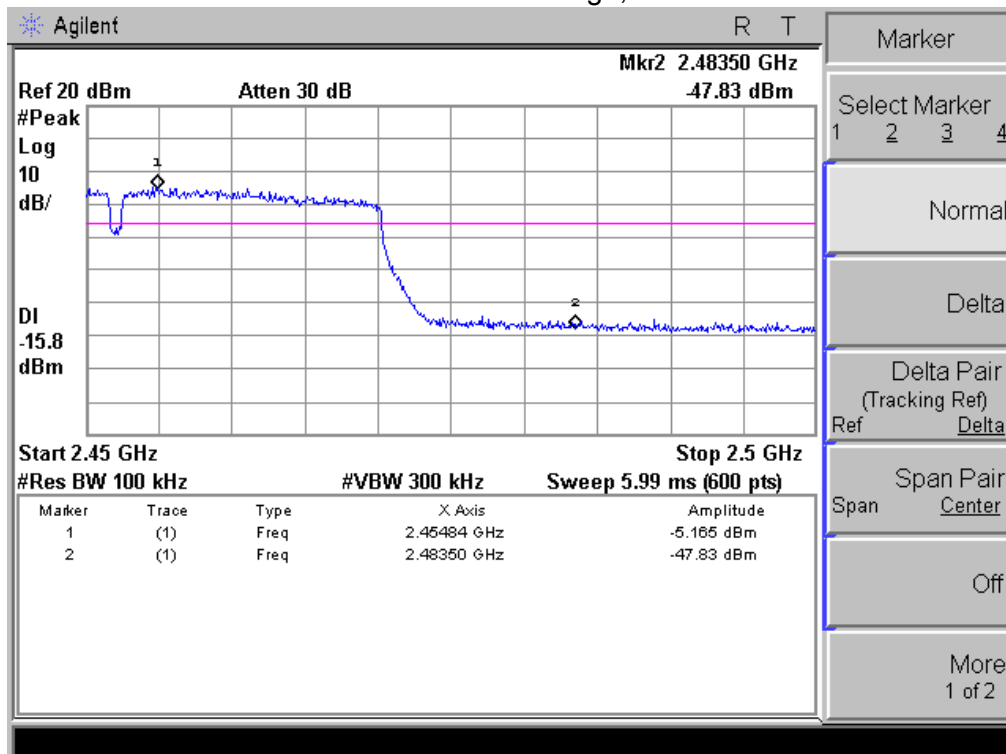

8. ANTENNA REQUIREMENT

8.1 STANDARD REQUIREMENT

15.203 requirement: For intentional device, according to 15.203: an intentional radiator shall be designed to ensure that no antenna other than that furnished by the responsible party shall be used with the device.

8.2 EUT ANTENNA

The EUT antenna is permanent attached antenna. It comply with the standard requirement.

9. EUT TEST PHOTO

Radiated Measurement Photos

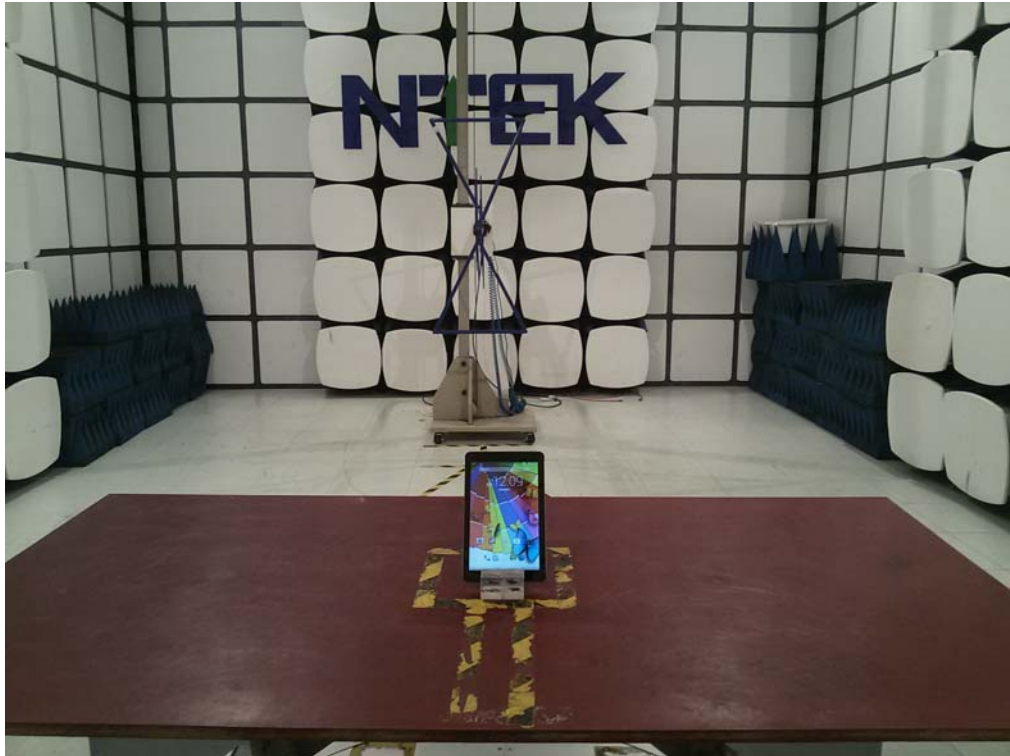

CONDUCTED EMISSION Photos

