

# SAR Test Report

APPLICANT : Kilpatrick LLC  
EQUIPMENT : Tablet PC  
MODEL NAME : C9R6QM  
FCC ID : S2F-8560  
STANDARD : FCC 47 CFR Part 2 (2.1093)  
ANSI/IEEE C95.1-1992  
IEEE 1528-2003

The product testing was completed on Aug. 02, 2013. We, SPORTON INTERNATIONAL INC., would like to declare that the tested sample has been evaluated in accordance with the procedures and shown the compliance with the applicable technical standards.

The test results in this report apply exclusively to the tested model / sample. Without written approval of SPORTON INTERNATIONAL INC., the test report shall not be reproduced except in full.

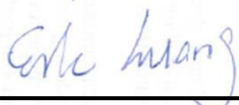

Reviewed by: Eric Huang / Deputy Manager



Approved by: Jones Tsai / Manager



## **SPORTON INTERNATIONAL INC.**

**No. 52, Hwa Ya 1<sup>st</sup> Rd., Hwa Ya Technology Park, Kwei-Shan Hsiang, Tao Yuan Hsien, Taiwan, R.O.C.**

# Table of Contents

|  |           |
|--|-----------|
| <b>1. Statement of Compliance</b> .....                  | <b>4</b>  |
| <b>2. Administration Data</b> .....                      | <b>4</b>  |
| 2.1 Testing Laboratory .....                             | 4         |
| 2.2 Applicant .....                                      | 4         |
| 2.3 Application Details .....                            | 4         |
| <b>3. General Information</b> .....                      | <b>5</b>  |
| 3.1 Description of Equipment Under Test (EUT) .....      | 5         |
| 3.2 Maximum RF output power among production units ..... | 6         |
| 3.3 Applied Standard .....                               | 7         |
| 3.4 Device Category and SAR Limits .....                 | 7         |
| 3.5 Test Conditions .....                                | 7         |
| <b>4. Specific Absorption Rate (SAR)</b> .....           | <b>8</b>  |
| 4.1 Introduction .....                                   | 8         |
| 4.2 SAR Definition .....                                 | 8         |
| <b>5. SAR Measurement System</b> .....                   | <b>9</b>  |
| 5.1 E-Field Probe .....                                  | 10        |
| 5.2 Data Acquisition Electronics (DAE) .....             | 11        |
| 5.3 Robot .....  | 11        |
| 5.4 Measurement Server .....                             | 11        |
| 5.5 Phantom .....  | 12        |
| 5.6 Device Holder .....                                  | 13        |
| 5.7 Data Storage and Evaluation .....                    | 14        |
| 5.8 Test Equipment List .....                            | 16        |
| <b>6. Tissue Simulating Liquids</b> .....                | <b>17</b> |
| <b>7. System Verification Procedures</b> .....           | <b>19</b> |
| 7.1 Purpose of System Performance check .....            | 19        |
| 7.2 System Setup .....                                   | 19        |
| 7.3 SAR System Verification Results .....                | 20        |
| <b>8. EUT Testing Position</b> .....                     | <b>21</b> |
| <b>9. Measurement Procedures</b> .....                   | <b>21</b> |
| 9.1 Spatial Peak SAR Evaluation .....                    | 21        |
| 9.2 Power Reference Measurement .....                    | 22        |
| 9.3 Area & Zoom Scan Procedures .....                    | 22        |
| 9.4 Volume Scan Procedures .....                         | 23        |
| 9.5 SAR Averaged Methods .....                           | 23        |
| 9.6 Power Drift Monitoring .....                         | 23        |
| <b>10. Conducted RF Output Power (Unit: dBm)</b> .....   | <b>23</b> |
| <b>11. Exposure Position Conditions</b> .....            | <b>32</b> |
| <b>12. SAR Test Results</b> .....                        | <b>33</b> |
| 12.1 Body SAR .....                                      | 33        |
| 12.2 Repeated SAR Measurement .....                      | 35        |
| 12.3 Highest SAR Plot .....                              | 36        |
| <b>13. Simultaneous Transmission Analysis</b> .....      | <b>38</b> |
| 13.1 Body Exposure Conditions .....                      | 39        |
| 13.2 SPLSR Evaluation and Analysis .....                 | 39        |
| <b>14. Uncertainty Assessment</b> .....                  | <b>40</b> |
| <b>15. References</b> .....                              | <b>43</b> |

**Appendix A. Plots of System Performance Check**

**Appendix B. Plots of SAR Measurement**

**Appendix C. DASYS Calibration Certificate**

## Revision History

| REPORT NO.  | VERSION | DESCRIPTION             | ISSUED DATE   |
|-------------|---------|-------------------------|---------------|
| FA332726-04 | Rev. 01 | Initial issue of report | Sep. 05, 2013 |
|             |         |                         |               |
|             |         |                         |               |
|             |         |                         |               |
|             |         |                         |               |
|             |         |                         |               |
|             |         |                         |               |
|             |         |                         |               |
|             |         |                         |               |
|             |         |                         |               |
|             |         |                         |               |
|             |         |                         |               |
|             |         |                         |               |
|             |         |                         |               |
|             |         |                         |               |
|             |         |                         |               |

## **1. Statement of Compliance**

The maximum results of Specific Absorption Rate (SAR) found during testing for **Kilpatrick LLC Tablet PC, C9R6QM**, are as follows.

### **<Highest SAR Summary>**

| <b>Exposure Position</b> | <b>Frequency Band</b> | <b>Reported 1g-SAR (W/kg)</b> | <b>Equipment Class</b> | <b>Highest Reported 1g-SAR (W/kg)</b> |
|--------------------------|-----------------------|-------------------------------|------------------------|---------------------------------------|
| Body<br>(separation 0cm) | WLAN 2.4GHz Band      | 1.29                          | DTS                    | 1.29                                  |
|                          | WLAN 5.8GHz Band      | 1.23                          |                        |                                       |
|                          | WLAN 5.2GHz Band      | 1.21                          | NII                    | 1.27                                  |
|                          | WLAN 5.3GHz Band      | 1.17                          |                        |                                       |
|                          | WLAN 5.5GHz Band      | 1.27                          |                        |                                       |

This device is in compliance with Specific Absorption Rate (SAR) for general population/uncontrolled exposure limits (1.6 W/kg) specified in FCC 47 CFR part 2 (2.1093), ANSI/IEEE C95.1-1992 and had been tested in accordance with the measurement methods and procedures specified in IEEE 1528-2003.

## **2. Administration Data**

### **2.1 Testing Laboratory**

|                           |   |
|---------------------------|---|
| <b>Test Site</b>          | SPORTON INTERNATIONAL INC.  |
| <b>Test Site Location</b> | No. 52, Hwa Ya 1 <sup>st</sup> Rd., Hwa Ya Technology Park,<br>Kwei-Shan Hsiang, Tao Yuan Hsien, Taiwan, R.O.C.<br>TEL: +886-3-327-3456<br>FAX: +886-3-328-4978 |

### **2.2 Applicant**

|                     |   |
|---------------------|---|
| <b>Company Name</b> | Kilpatrick LLC  |
| <b>Address</b>      | 102 S. Tejon Street Suite 1100 Colorado Springs, Colorado 80903 |

### **2.3 Application Details**

|                                      |               |
|--------------------------------------|---------------|
| <b>Date of Start during the Test</b> | Jul. 19, 2013 |
| <b>Date of End during the Test</b>   | Aug. 02, 2013 |

### 3. General Information

#### 3.1 Description of Equipment Under Test (EUT)

| Product Feature & Specification  |  |
|--|--|
| <b>EUT</b>   | Tablet PC  |
| <b>Model Name</b>  | C9R6QM   |
| <b>FCC ID</b>  | S2F-8560   |
| <b>Wireless Technology and Frequency Range</b>   | WLAN 2.4GHz Band: 2412 MHz ~ 2462 MHz<br>WLAN 5.2GHz Band: 5180 MHz ~ 5240 MHz<br>WLAN 5.3GHz Band: 5260 MHz ~ 5320 MHz<br>WLAN 5.5GHz Band: 5500 MHz ~ 5580 MHz and 5660 MHz ~ 5700MHz<br>WLAN 5.8GHz Band: 5745 MHz ~ 5825 MHz<br>Bluetooth: 2402MHz ~ 2480MHz |
| <b>Mode</b>  | <ul style="list-style-type: none"><li>• 802.11a/b/g/n HT20/HT40</li><li>• Bluetooth v3.0</li></ul>   |
| <b>Antenna Type</b>  | WLAN: Fixed Internal Antenna<br>Bluetooth: Fixed Internal Antenna  |
| <b>Remark:</b><br><ol style="list-style-type: none"><li>1. The above EUT's information was declared by manufacturer. Please refer to the specifications or user's manual for more detailed description.</li><li>2. 802.11n-HT40 is not supported in WLAN2.4GHz.</li><li>3. WLAN5GHz operation in 5600 MHz ~ 5650 MHz is notched.</li></ol> |  |

### 3.2 Maximum RF output power among production units

| Band              | Bluetooth Average power(dBm) |                         |                |
|-------------------|------------------------------|-------------------------|----------------|
|                   | 1Mbps (GFSK)                 | 2Mbps ( $\pi/4$ -DQPSK) | 3Mbps (8-DPSK) |
| 2.4 GHz Bluetooth | 5.5                          | 5.5                     | 5.5            |

| Band            | IEEE 802.11 average power(dBm) |           |             |           |           |             |           |           |             |
|-----------------|--------------------------------|-----------|-------------|-----------|-----------|-------------|-----------|-----------|-------------|
|                 | 11b                            |           |             | 11g       |           |             | HT20      |           |             |
|                 | Antenna 1                      | Antenna 2 | Antenna 1+2 | Antenna 1 | Antenna 2 | Antenna 1+2 | Antenna 1 | Antenna 2 | Antenna 1+2 |
| WLNA2.4GHz Band | 16.0                           | 15.0      | 18.5        | 15.5      | 14.5      | 18.0        | 15.5      | 14.5      | 18.0        |

| Band            | IEEE 802.11 average power(dBm) |           |             |           |           |             |           |           |             |
|-----------------|--------------------------------|-----------|-------------|-----------|-----------|-------------|-----------|-----------|-------------|
|                 | 11a                            |           |             | HT20      |           |             | HT40      |           |             |
|                 | Antenna 1                      | Antenna 2 | Antenna 1+2 | Antenna 1 | Antenna 2 | Antenna 1+2 | Antenna 1 | Antenna 2 | Antenna 1+2 |
| WLNA5.2GHz Band | 13.0                           | 9.5       | 14.6        | 13.0      | 9.5       | 14.6        | 13.0      | 9.5       | 14.6        |
| WLNA5.3GHz Band | 13.0                           | 9.5       | 14.6        | 13.0      | 9.5       | 14.6        | 13.0      | 9.5       | 14.6        |
| WLNA5.5GHz Band | 13.0                           | 10.0      | 14.8        | 13.0      | 10.0      | 14.8        | 13.0      | 10.0      | 14.8        |
| WLNA5.8GHz Band | 13.0                           | 10.0      | 14.8        | 13.0      | 10.0      | 14.8        | 13.0      | 10.0      | 14.8        |

### **3.3 Applied Standard**

The Specific Absorption Rate (SAR) testing specification, method, and procedure for this device is in accordance with the following standards:

- FCC 47 CFR Part 2 (2.1093)
- ANSI/IEEE C95.1-1992
- IEEE 1528-2003
- FCC KDB 447498 D01 v05r01
- FCC KDB 248227 D01 v01r02
- FCC KDB 616217 D04 v01r01

### **3.4 Device Category and SAR Limits**

This device belongs to portable device category because its radiating structure is allowed to be used within 20 centimeters of the body of the user. Limit for General Population/Uncontrolled exposure should be applied for this device, it is 1.6 W/kg as averaged over any 1 gram of tissue.

### **3.5 Test Conditions**

#### ***Ambient Condition***

|                            |             |
|----------------------------|-------------|
| <b>Ambient Temperature</b> | 20 to 24 °C |
| <b>Humidity</b>            | < 60 %      |

#### ***Test Configuration***

For WLAN SAR testing, WLAN engineering testing software installed on the EUT can provide continuous transmitting RF signal.

## **4. Specific Absorption Rate (SAR)**

### **4.1 Introduction**

SAR is related to the rate at which energy is absorbed per unit mass in an object exposed to a radio field. The SAR distribution in a biological body is complicated and is usually carried out by experimental techniques or numerical modeling. The standard recommends limits for two tiers of groups, occupational/controlled and general population/uncontrolled, based on a person's awareness and ability to exercise control over his or her exposure. In general, occupational/controlled exposure limits are higher than the limits for general population/uncontrolled.

### **4.2 SAR Definition**

The SAR definition is the time derivative (rate) of the incremental energy (dW) absorbed by (dissipated in) an incremental mass (dm) contained in a volume element (dv) of a given density ( $\rho$ ). The equation description is as below:

$$\mathbf{SAR} = \frac{d}{dt} \left( \frac{dW}{dm} \right) = \frac{d}{dt} \left( \frac{dW}{\rho dv} \right)$$

SAR is expressed in units of Watts per kilogram (W/kg)

SAR measurement can be either related to the temperature elevation in tissue by

$$\mathbf{SAR} = C \left( \frac{\delta T}{\delta t} \right)$$

Where: C is the specific heat capacity,  $\delta T$  is the temperature rise and  $\delta t$  is the exposure duration, or related to the electrical field in the tissue by

$$\mathbf{SAR} = \frac{\sigma |E|^2}{\rho}$$

Where:  $\sigma$  is the conductivity of the tissue,  $\rho$  is the mass density of the tissue and E is the RMS electrical field strength.

However for evaluating SAR of low power transmitter, electrical field measurement is typically applied.



## 5. SAR Measurement System

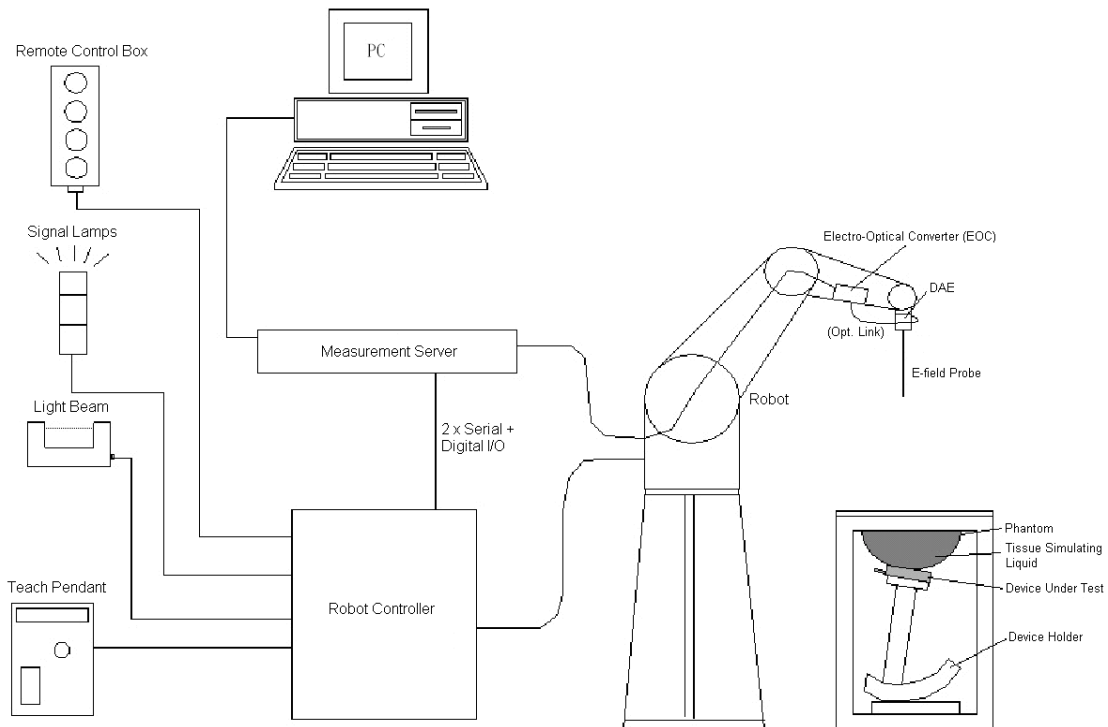

**Fig 5.1 SPEAG DASY System Configurations**

The DASY system for performance compliance tests is illustrated above graphically. This system consists of the following items:

- A standard high precision 6-axis robot with controller, a teach pendant and software
- A data acquisition electronic (DAE) attached to the robot arm extension
- A dosimetric probe equipped with an optical surface detector system
- The electro-optical converter (EOC) performs the conversion between optical and electrical signals
- A measurement server performs the time critical tasks such as signal filtering, control of the robot operation and fast movement interrupts.
- A probe alignment unit which improves the accuracy of the probe positioning
- A computer operating Windows XP
- DASY software
- Remote control with teach pendant and additional circuitry for robot safety such as warning lamps, etc.
- The SAM twin phantom
- A device holder
- Tissue simulating liquid
- Dipole for evaluating the proper functioning of the system

Component details are described in in the following sub-sections.

## 5.1 E-Field Probe

The SAR measurement is conducted with the dosimetric probe (manufactured by SPEAG). The probe is specially designed and calibrated for use in liquid with high permittivity. The dosimetric probe has special calibration in liquid at different frequency. This probe has a built in optical surface detection system to prevent from collision with phantom.

### 5.1.1 E-Field Probe Specification

#### <EX3DV4 Probe>

|                      |   |   |
|----------------------|---|---|
| <b>Construction</b>  | Symmetrical design with triangular core<br>Built-in shielding against static charges<br>PEEK enclosure material (resistant to organic solvents, e.g., DGBE) |  |
| <b>Frequency</b>     | 10 MHz to 6 GHz; Linearity: $\pm 0.2$ dB  |   |
| <b>Directivity</b>   | $\pm 0.3$ dB in HSL (rotation around probe axis)<br>$\pm 0.5$ dB in tissue material (rotation normal to probe axis)   |   |
| <b>Dynamic Range</b> | 10 $\mu$ W/g to 100 mW/g; Linearity: $\pm 0.2$ dB<br>(noise: typically $< 1$ $\mu$ W/g)   |   |
| <b>Dimensions</b>    | Overall length: 330 mm (Tip: 20 mm)<br>Tip diameter: 2.5 mm (Body: 12 mm)<br>Typical distance from probe tip to dipole centers: 1 mm                        |   |

**Fig 5.2** Photo of EX3DV4/ES3DV4

### 5.1.2 E-Field Probe Calibration

Each probe needs to be calibrated according to a dosimetric assessment procedure with accuracy better than  $\pm 10\%$ . The spherical isotropy shall be evaluated and within  $\pm 0.25$ dB. The sensitivity parameters (NormX, NormY, and NormZ), the diode compression parameter (DCP) and the conversion factor (ConvF) of the probe are tested. The calibration data can be referred to appendix C of this report.

## 5.2 Data Acquisition Electronics (DAE)

The data acquisition electronics (DAE) consists of a highly sensitive electrometer-grade preamplifier with auto-zeroing, a channel and gain-switching multiplexer, a fast 16 bit AD-converter and a command decoder and control logic unit. Transmission to the measurement server is accomplished through an optical downlink for data and status information as well as an optical uplink for commands and the clock. The input impedance of the DAE is 200 MOhm; the inputs are symmetrical and floating. Common mode rejection is above 80 dB.



Fig 5.3 Photo of DAE

## 5.3 Robot

The SPEAG DASY system uses the high precision robots (DASY4: RX90BL; DASY5: TX90XL) type from Stäubli SA (France). For the 6-axis controller system, the robot controller version (DASY4: CS7MB; DASY5: CS8c) from Stäubli is used. The Stäubli robot series have many features that are important for our application:

- High precision (repeatability  $\pm 0.035$  mm)
- High reliability (industrial design)
- Jerk-free straight movements
- Low ELF interference (the closed metallic construction shields against motor control fields)



Fig 5.4 Photo of DASY4



Fig 5.5 Photo of DASY5

## 5.4 Measurement Server

The measurement server is based on a PC/104 CPU board with CPU (DASY4: 166 MHz, Intel Pentium; DASY5: 400 MHz, Intel Celeron), chipdisk (DASY4: 32 MB; DASY5: 128 MB), RAM (DASY4: 64 MB, DASY5: 128 MB). The necessary circuits for communication with the DAE electronic box, as well as the 16 bit AD converter system for optical detection and digital I/O interface are contained on the DASY I/O board, which is directly connected to the PC/104 bus of the CPU board.

The measurement server performs all the real-time data evaluation for field measurements and surface detection, controls robot movements and handles safety operations.



Fig 5.6 Photo of Server for DASY4

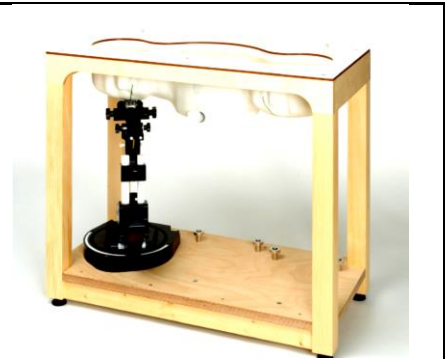

Fig 5.7 Photo of Server for DASY5

## 5.5 Phantom

### <SAM Twin Phantom>

|                          |  |
|--------------------------|--|
| <b>Shell Thickness</b>   | 2 ± 0.2 mm;<br>Center ear point: 6 ± 0.2 mm                |
| <b>Filling Volume</b>    | Approx. 25 liters  |
| <b>Dimensions</b>        | Length: 1000 mm; Width: 500 mm;<br>Height: adjustable feet |
| <b>Measurement Areas</b> | Left Hand, Right Hand, Flat Phantom                        |

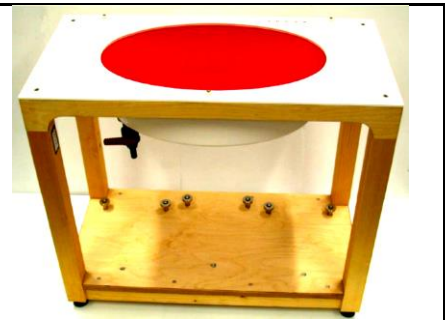

**Fig 5.8 Photo of SAM Phantom**

The bottom plate contains three pair of bolts for locking the device holder. The device holder positions are adjusted to the standard measurement positions in the three sections. A white cover is provided to tap the phantom during off-periods to prevent water evaporation and changes in the liquid parameters. On the phantom top, three reference markers are provided to identify the phantom position with respect to the robot.

### <ELI4 Phantom>

|                        |  |
|------------------------|--|
| <b>Shell Thickness</b> | 2 ± 0.2 mm (sagging: <1%)                        |
| <b>Filling Volume</b>  | Approx. 30 liters                                |
| <b>Dimensions</b>      | Major ellipse axis: 600 mm<br>Minor axis: 400 mm |



**Fig 5.9 Photo of ELI4 Phantom**

The ELI4 phantom is intended for compliance testing of handheld and body-mounted wireless devices in the frequency range of 30 MHz to 6 GHz. ELI4 is fully compatible with standard and all known tissue simulating liquids.

## 5.6 Device Holder

### <Device Holder for SAM Twin Phantom>

The SAR in the phantom is approximately inversely proportional to the square of the distance between the source and the liquid surface. For a source at 5 mm distance, a positioning uncertainty of  $\pm 0.5$  mm would produce a SAR uncertainty of  $\pm 20$  %. Accurate device positioning is therefore crucial for accurate and repeatable measurements. The positions in which the devices must be measured are defined by the standards.

The DASY device holder is designed to cope with different positions given in the standard. It has two scales for the device rotation (with respect to the body axis) and the device inclination (with respect to the line between the ear reference points). The rotation center for both scales is the ear reference point (ERP). Thus the device needs no repositioning when changing the angles.

The DASY device holder is constructed of low-loss POM material having the following dielectric parameters: relative permittivity  $\epsilon = 3$  and loss tangent  $\delta = 0.02$ . The amount of dielectric material has been reduced in the closest vicinity of the device, since measurements have suggested that the influence of the clamp on the test results could thus be lowered.



Fig 5.10 Device Holder

### <Laptop Extension Kit>

The extension is lightweight and made of POM, acrylic glass and foam. It fits easily on the upper part of the mounting device in place of the phone positioned. The extension is fully compatible with the SAM Twin and ELI phantoms.

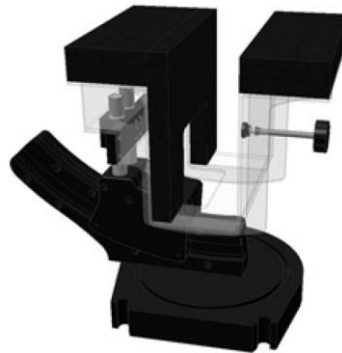

Fig 5.11 Laptop Extension Kit

## **5.7 Data Storage and Evaluation**

### **5.7.1 Data Storage**

The DASY software stores the assessed data from the data acquisition electronics as raw data (in microvolt readings from the probe sensors), together with all the necessary software parameters for the data evaluation (probe calibration data, liquid parameters and device frequency and modulation data) in measurement files. The post-processing software evaluates the desired unit and format for output each time the data is visualized or exported. This allows verification of the complete software setup even after the measurement and allows correction of erroneous parameter settings. For example, if a measurement has been performed with an incorrect crest factor parameter in the device setup, the parameter can be corrected afterwards and the data can be reevaluated.

The measured data can be visualized or exported in different units or formats, depending on the selected probe type (e.g., [V/m], [A/m], [mW/g]). Some of these units are not available in certain situations or give meaningless results, e.g., a SAR-output in a non-lose media, will always be zero. Raw data can also be exported to perform the evaluation with other software packages.

### **5.7.2 Data Evaluation**

The DASY post-processing software (SEMCAD) automatically executes the following procedures to calculate the field units from the microvolt readings at the probe connector. The parameters used in the evaluation are stored in the configuration modules of the software :

|                            |                           |   |
|----------------------------|---------------------------|---|
| <b>Probe parameters :</b>  | - Sensitivity             | Norm <sub>i</sub> , a <sub>10</sub> , a <sub>11</sub> , a <sub>12</sub> |
|                            | - Conversion factor       | ConvF <sub>i</sub>  |
|                            | - Diode compression point | dcp <sub>i</sub>  |
| <b>Device parameters :</b> | - Frequency               | f   |
|                            | - Crest factor            | cf  |
| <b>Media parameters :</b>  | - Conductivity            | σ   |
|                            | - Density                 | ρ   |

These parameters must be set correctly in the software. They can be found in the component documents or they can be imported into the software from the configuration files issued for the DASY components. In the direct measuring mode of the multi-meter option, the parameters of the actual system setup are used. In the scan visualization and export modes, the parameters stored in the corresponding document files are used.

The first step of the evaluation is a linearization of the filtered input signal to account for the compression characteristics of the detector diode. The compensation depends on the input signal, the diode type and the DC-transmission factor from the diode to the evaluation electronics. If the exciting field is pulsed, the crest factor of the signal must be known to correctly compensate for peak power.

The formula for each channel can be given as :

$$V_i = U_i + U_i^2 \cdot \frac{cf}{dcp_i}$$

with  $V_i$  = compensated signal of channel i, (i = x, y, z)  
 $U_i$  = input signal of channel i, (i = x, y, z)  
 cf = crest factor of exciting field (DASY parameter)  
 dcp<sub>i</sub> = diode compression point (DASY parameter)

From the compensated input signals, the primary field data for each channel can be evaluated :

$$\text{E-field Probes : } E_i = \sqrt{\frac{V_i}{\text{Norm}_i \cdot \text{ConvF}}}$$

$$\text{H-field Probes : } H_i = \sqrt{V_i} \cdot \frac{a_{i0} + a_{i1}f + a_{i2}f^2}{f}$$

with  $V_i$  = compensated signal of channel i, (i = x, y, z)  
 Norm<sub>i</sub> = sensor sensitivity of channel i, (i = x, y, z),  $\mu\text{V}/(\text{V}/\text{m})^2$  for E-field Probes  
 ConvF = sensitivity enhancement in solution  
 a<sub>ij</sub> = sensor sensitivity factors for H-field probes  
 f = carrier frequency [GHz]  
 $E_i$  = electric field strength of channel i in V/m  
 $H_i$  = magnetic field strength of channel i in A/m

The RSS value of the field components gives the total field strength (Hermitian magnitude) :

$$E_{\text{tot}} = \sqrt{E_x^2 + E_y^2 + E_z^2}$$

The primary field data are used to calculate the derived field units.

$$\text{SAR} = E_{\text{tot}}^2 \cdot \frac{\sigma}{\rho \cdot 1000}$$

with SAR = local specific absorption rate in mW/g  
 $E_{\text{tot}}$  = total field strength in V/m  
 $\sigma$  = conductivity in [mho/m] or [Siemens/m]  
 $\rho$  = equivalent tissue density in  $\text{g}/\text{cm}^3$

Note that the density is set to 1, to account for actual head tissue density rather than the density of the tissue simulating liquid.

## 5.8 Test Equipment List

| Manufacturer | Name of Equipment                  | Type/Model | Serial Number | Calibration   |               |
|--------------|------------------------------------|------------|---------------|---------------|---------------|
|              |                                    |            |               | Last Cal.     | Due Date      |
| SPEAG        | 2450MHz System Validation Kit      | D2450V2    | 869           | Jun. 11, 2013 | Jun. 10, 2014 |
| SPEAG        | 5GHz System Validation Kit         | D5GHzV2    | 1006          | Dec. 11, 2012 | Dec. 10, 2013 |
| SPEAG        | Data Acquisition Electronics       | DAE4       | 778           | Aug. 27, 2012 | Aug. 26, 2013 |
| SPEAG        | Data Acquisition Electronics       | DAE4       | 1279          | Jan. 28, 2013 | Jan. 27, 2014 |
| SPEAG        | Dosimetric E-Field Probe           | EX3DV4     | 3697          | Sep. 28, 2012 | Sep. 27, 2013 |
| Wisewind     | Thermometer                        | ETP-101    | TM560         | Nov. 13, 2012 | Nov. 12, 2013 |
| SPEAG        | Device Holder                      | N/A        | N/A           | NCR           | NCR           |
| Agilent      | ESG Vector Series Signal Generator | E4438C     | MY49070755    | Oct. 02, 2012 | Oct. 01, 2013 |
| Agilent      | ENA Network Analyzer               | E5071C     | MY46316648    | Feb. 07, 2013 | Feb. 06, 2014 |
| Anritsu      | Power Meter                        | ML2495A    | 1132003       | Aug. 14, 2012 | Aug. 13, 2013 |
| Anritsu      | Power Sensor                       | MA2411B    | 1126017       | Aug. 14, 2012 | Aug. 13, 2013 |
| Agilent      | Dual Directional Coupler           | 778D       | 50422         | Note 2        |               |
| Woken        | Attenuator 1                       | WK0602-XX  | N/A           | Note 2        |               |
| PE           | Attenuator 2                       | PE7005-10  | N/A           | Note 2        |               |
| PE           | Attenuator 3                       | PE7005- 3  | N/A           | Note 2        |               |
| Agilent      | Dielectric Probe Kit               | 85070D     | US01440205    | Note 3        |               |
| AR           | Power Amplifier                    | 5S1G4M2    | 0328767       | Note 4        |               |
| R&S          | Spectrum Analyzer                  | FSP 40     | 100055        | Jun. 07, 2013 | Jun. 06, 2014 |

**Table 5.1 Test Equipment List**

**Note:**

1. The calibration certificate of DASYS can be referred to appendix C of this report.
2. The Insertion Loss calibration of Dual Directional Coupler and Attenuator were characterized via the network analyzer and compensated during system check.
3. The dielectric probe kit was calibrated via the network analyzer, with the specified procedure (calibrated in pure water) and calibration kit (standard) short circuit, before the dielectric measurement. The specific procedure and calibration kit are provided by Agilent.
4. In system check we need to monitor the level on the power meter, and adjust the power amplifier level to have precise power level to the dipole; the measured SAR will be normalized to 1W input power according to the ratio of 1W to the input power to the dipole. For system check, the calibration of the power amplifier is deemed not critically required for correct measurement; the power meter is critical and we do have calibration for it
5. Attenuator 1 insertion loss is calibrated by the network Analyzer, which the calibration is valid, before system check.



## 6. Tissue Simulating Liquids

For the measurement of the field distribution inside the SAM phantom with DASY, the phantom must be filled with around 25 liters of homogeneous body tissue simulating liquid. For head SAR testing, the liquid height from the ear reference point (ERP) of the phantom to the liquid top surface is larger than 15 cm, which is shown in Fig. 6.1. For body SAR testing, the liquid height from the center of the flat phantom to the liquid top surface is larger than 15 cm, which is shown in Fig. 6.2.

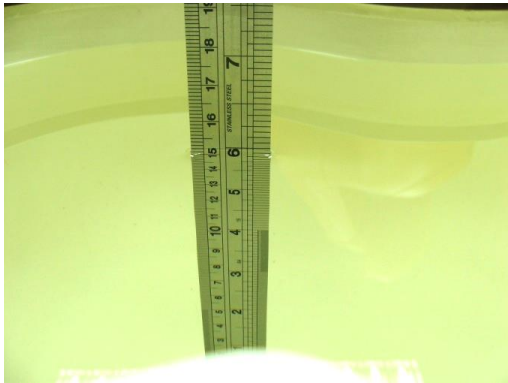

Fig 6.1 Photo of Liquid Height for Head SAR



Fig 6.2 Photo of Liquid Height for Body SAR

The following table gives the recipes for tissue simulating liquid.

| Frequency (MHz)  | Water (%) | Sugar (%) | Cellulose (%) | Salt (%) | Preventol (%) | DGBE (%) | Conductivity ( $\sigma$ ) | Permittivity ( $\epsilon_r$ ) |
|------------------|-----------|-----------|---------------|----------|---------------|----------|---------------------------|-------------------------------|
| <b>For Head</b>  |           |           |               |          |               |          |                           |                               |
| 750              | 41.1      | 57.0      | 0.2           | 1.4      | 0.2           | 0        | 0.89                      | 41.9                          |
| 835              | 40.3      | 57.9      | 0.2           | 1.4      | 0.2           | 0        | 0.90                      | 41.5                          |
| 900              | 40.3      | 57.9      | 0.2           | 1.4      | 0.2           | 0        | 0.97                      | 41.5                          |
| 1800, 1900, 2000 | 55.2      | 0         | 0             | 0.3      | 0             | 44.5     | 1.40                      | 40.0                          |
| 2450             | 55.0      | 0         | 0             | 0        | 0             | 45.0     | 1.80                      | 39.2                          |
| <b>For Body</b>  |           |           |               |          |               |          |                           |                               |
| 750              | 51.7      | 47.2      | 0             | 0.9      | 0.1           | 0        | 0.96                      | 55.5                          |
| 835              | 50.8      | 48.2      | 0             | 0.9      | 0.1           | 0        | 0.97                      | 55.2                          |
| 900              | 50.8      | 48.2      | 0             | 0.9      | 0.1           | 0        | 1.05                      | 55.0                          |
| 1800, 1900, 2000 | 70.2      | 0         | 0             | 0.4      | 0             | 29.4     | 1.52                      | 53.3                          |
| 2450             | 68.6      | 0         | 0             | 0        | 0             | 31.4     | 1.95                      | 52.7                          |

Table 6.1 Recipes of Tissue Simulating Liquid

### Simulating Liquid for 5G, Manufactured by SPEAG

| Ingredients        | (% by weight) |
|--------------------|---------------|
| Water              | 64~78%        |
| Mineral oil        | 11~18%        |
| Emulsifiers        | 9~15%         |
| Additives and Salt | 2~3%          |

The dielectric parameters of the liquids were verified prior to the SAR evaluation using an Agilent 85070D Dielectric Probe Kit and an Agilent Network Analyzer.

The following table shows the measuring results for simulating liquid.

| Frequency (MHz) | Liquid Type | Liquid Temp. (°C) | Conductivity ( $\sigma$ ) | Permittivity ( $\epsilon_r$ ) | Conductivity Target ( $\sigma$ ) | Permittivity Target ( $\epsilon_r$ ) | Delta ( $\sigma$ ) (%) | Delta ( $\epsilon_r$ ) (%) | Limit (%) | Date      |
|-----------------|-------------|-------------------|---------------------------|-------------------------------|----------------------------------|--------------------------------------|------------------------|----------------------------|-----------|-----------|
| 2450            | Body        | 22.2              | 1.920                     | 53.118                        | 1.95                             | 52.70                                | -1.54                  | 0.79                       | ±5        | 2013/7/24 |
| 2450            | Body        | 22.2              | 1.955                     | 53.805                        | 1.95                             | 52.70                                | 0.26                   | 2.10                       | ±5        | 2013/7/27 |
| 5200            | Body        | 22.7              | 5.325                     | 47.518                        | 5.30                             | 49.00                                | 0.47                   | -3.02                      | ±5        | 2013/7/19 |
| 5200            | Body        | 22.6              | 5.114                     | 47.437                        | 5.30                             | 49.00                                | -3.51                  | -3.19                      | ±5        | 2013/7/23 |
| 5200            | Body        | 22.4              | 5.327                     | 49.297                        | 5.30                             | 49.00                                | 0.51                   | 0.61                       | ±5        | 2013/7/26 |
| 5200            | Body        | 22.3              | 5.346                     | 47.813                        | 5.30                             | 49.00                                | 0.87                   | -2.42                      | ±5        | 2013/8/2  |
| 5300            | Body        | 22.7              | 5.466                     | 47.251                        | 5.42                             | 48.88                                | 0.85                   | -3.33                      | ±5        | 2013/7/19 |
| 5300            | Body        | 22.6              | 5.244                     | 47.199                        | 5.42                             | 48.88                                | -3.25                  | -3.44                      | ±5        | 2013/7/23 |
| 5300            | Body        | 22.4              | 5.469                     | 49.105                        | 5.42                             | 48.88                                | 0.90                   | 0.46                       | ±5        | 2013/7/26 |
| 5600            | Body        | 22.7              | 5.868                     | 46.726                        | 5.77                             | 48.47                                | 1.70                   | -3.60                      | ±5        | 2013/7/19 |
| 5600            | Body        | 22.6              | 5.623                     | 46.749                        | 5.77                             | 48.47                                | -2.55                  | -3.55                      | ±5        | 2013/7/23 |
| 5600            | Body        | 22.4              | 5.904                     | 48.418                        | 5.77                             | 48.47                                | 2.32                   | -0.11                      | ±5        | 2013/7/26 |
| 5800            | Body        | 22.7              | 6.229                     | 46.417                        | 6.00                             | 48.20                                | 3.82                   | -3.70                      | ±5        | 2013/7/19 |
| 5800            | Body        | 22.6              | 5.956                     | 46.473                        | 6.00                             | 48.20                                | -0.73                  | -3.58                      | ±5        | 2013/7/23 |
| 5800            | Body        | 22.4              | 6.160                     | 47.897                        | 6.00                             | 48.20                                | 2.67                   | -0.63                      | ±5        | 2013/7/26 |

**Table 6.2 Measuring Results for Simulating Liquid**

## 7. System Verification Procedures

Each DASy system is equipped with one or more system validation kits. These units, together with the predefined measurement procedures within the DASy software, enable the user to conduct the system performance check and system validation. System validation kit includes a dipole, tripod holder to fix it underneath the flat phantom and a corresponding distance holder.

### 7.1 Purpose of System Performance check

The system performance check verifies that the system operates within its specifications. System and operator errors can be detected and corrected. It is recommended that the system performance check be performed prior to any usage of the system in order to guarantee reproducible results. The system performance check uses normal SAR measurements in a simplified setup with a well characterized source. This setup was selected to give a high sensitivity to all parameters that might fail or vary over time. The system check does not intend to replace the calibration of the components, but indicates situations where the system uncertainty is exceeded due to drift or failure.

### 7.2 System Setup

In the simplified setup for system evaluation, the EUT is replaced by a calibrated dipole and the power source is replaced by a continuous wave that comes from a signal generator. The calibrated dipole must be placed beneath the flat phantom with the correct distance holder. The distance holder should touch the phantom surface with a light pressure at the reference marking and be oriented parallel to the long side of the phantom. The equipment setup is shown below:

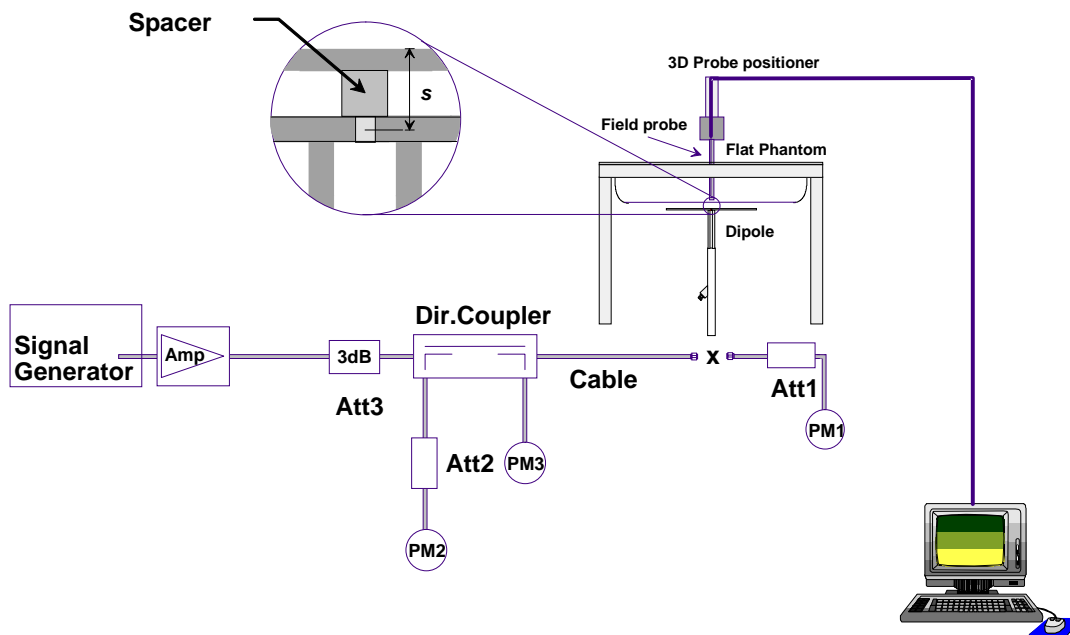
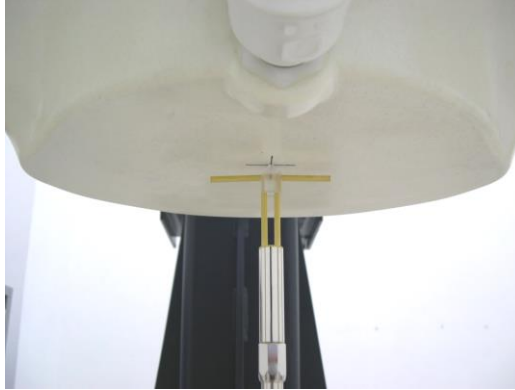

Fig 7.1 System Setup for System Evaluation

1. Signal Generator
2. Amplifier
3. Directional Coupler
4. Power Meter
5. Calibrated Dipole



**Fig 7.2 Photo of Dipole Setup**

### **7.3 SAR System Verification Results**

Comparing to the original SAR value provided by SPEAG, the verification data should be within its specification of 10 %. Table 7.1 shows the target SAR and measured SAR after normalized to 1W input power. The table below indicates the system performance check can meet the variation criterion and the plots can be referred to Appendix A of this report.

| Date      | Frequency (MHz) | Liquid Type | Power fed onto reference dipole (mW) | Targeted SAR (W/kg) | Measured SAR (W/kg) | Normalized SAR (W/kg) | Deviation (%) |
|-----------|-----------------|-------------|--------------------------------------|---------------------|---------------------|-----------------------|---------------|
| 2013/7/24 | 2450            | Body        | 250                                  | 51.5                | 12.4                | 49.6                  | -3.69         |
| 2013/7/27 | 2450            | Body        | 250                                  | 51.5                | 12.6                | 50.4                  | -2.14         |
| 2013/7/19 | 5200            | Body        | 100                                  | 71.4                | 7.4                 | 74.0                  | 3.64          |
| 2013/7/23 | 5200            | Body        | 100                                  | 71.4                | 7.11                | 71.1                  | -0.42         |
| 2013/7/26 | 5200            | Body        | 100                                  | 71.4                | 6.87                | 68.7                  | -3.78         |
| 2013/8/2  | 5200            | Body        | 100                                  | 71.4                | 6.9                 | 69.0                  | -3.36         |
| 2013/7/19 | 5300            | Body        | 100                                  | 73.5                | 7.62                | 76.2                  | 3.67          |
| 2013/7/23 | 5300            | Body        | 100                                  | 73.5                | 7.31                | 73.1                  | -0.54         |
| 2013/7/26 | 5300            | Body        | 100                                  | 73.5                | 7.00                | 70.0                  | -4.76         |
| 2013/7/19 | 5600            | Body        | 100                                  | 76.8                | 7.88                | 78.8                  | 2.60          |
| 2013/7/23 | 5600            | Body        | 100                                  | 76.8                | 7.55                | 75.5                  | -1.69         |
| 2013/7/26 | 5600            | Body        | 100                                  | 76.8                | 7.37                | 73.7                  | -4.04         |
| 2013/7/19 | 5800            | Body        | 100                                  | 71.7                | 7.01                | 70.1                  | -2.23         |
| 2013/7/23 | 5800            | Body        | 100                                  | 71.7                | 7.35                | 73.5                  | 2.51          |
| 2013/7/26 | 5800            | Body        | 100                                  | 71.7                | 7.12                | 71.2                  | -0.70         |

**Table 7.1 Target and Measurement SAR after Normalized**

## **8. EUT Testing Position**

Please refer to the test setup photos.

## **9. Measurement Procedures**

The measurement procedures are as follows:

### <Conducted power measurement>

- (a) For WWAN power measurement, use base station simulator to configure EUT WWAN transmission in conducted connection with RF cable, at maximum power in each supported wireless interface and frequency band.
- (b) Read the WWAN RF power level from the base station simulator.
- (c) For WLAN/BT power measurement, use engineering software to configure EUT WLAN/BT continuously transmission, at maximum RF power in each supported wireless interface and frequency band
- (d) Connect EUT RF port through RF cable to the power meter, and measure WLAN/BT output power

### <SAR measurement>

- (a) Use base station simulator to configure EUT WWAN transmission in radiated connection, and engineering software to configure EUT WLAN/BT continuously transmission, at maximum RF power, in the highest power channel.
- (b) Place the EUT in the positions as Appendix D demonstrates.
- (c) Set scan area, grid size and other setting on the DASY software.
- (d) Measure SAR results for the highest power channel on each testing position.
- (e) Find out the largest SAR result on these testing positions of each band
- (f) Measure SAR results for other channels in worst SAR testing position if the reported SAR of highest power channel is larger than 0.8 W/kg

According to the test standard, the recommended procedure for assessing the peak spatial-average SAR value consists of the following steps:

- (a) Power reference measurement
- (b) Area scan
- (c) Zoom scan
- (d) Power drift measurement

### **9.1 Spatial Peak SAR Evaluation**

The procedure for spatial peak SAR evaluation has been implemented according to the test standard. It can be conducted for 1g and 10g, as well as for user-specific masses. The DASY software includes all numerical procedures necessary to evaluate the spatial peak SAR value.

The base for the evaluation is a "cube" measurement. The measured volume must include the 1g and 10g cubes with the highest averaged SAR values. For that purpose, the center of the measured volume is aligned to the interpolated peak SAR value of a previously performed area scan.

The entire evaluation of the spatial peak values is performed within the post-processing engine (SEMCAD). The system always gives the maximum values for the 1g and 10g cubes. The algorithm to find the cube with highest averaged SAR is divided into the following stages:

- (a) Extraction of the measured data (grid and values) from the Zoom Scan
- (b) Calculation of the SAR value at every measurement point based on all stored data (A/D values and measurement parameters)
- (c) Generation of a high-resolution mesh within the measured volume
- (d) Interpolation of all measured values from the measurement grid to the high-resolution grid
- (e) Extrapolation of the entire 3-D field distribution to the phantom surface over the distance from sensor to surface
- (f) Calculation of the averaged SAR within masses of 1g and 10g

## 9.2 Power Reference Measurement

The Power Reference Measurement and Power Drift Measurements are for monitoring the power drift of the device under test in the batch process. The minimum distance of probe sensors to surface determines the closest measurement point to phantom surface. This distance cannot be smaller than the distance of sensor calibration points to probe tip as defined in the probe properties.

## 9.3 Area & Zoom Scan Procedures

First Area Scan is used to locate the approximate location(s) of the local peak SAR value(s). The measurement grid within an Area Scan is defined by the grid extent, grid step size and grid offset. Next, in order to determine the EM field distribution in a three-dimensional spatial extension, Zoom Scan is required. The Zoom Scan is performed around the highest E-field value to determine the averaged SAR-distribution over 10 g. Area scan and zoom scan resolution setting follows KDB 865664 D01v01 quoted below.

When the 1-g SAR of the highest peak is within 2 dB of the SAR limit, additional zoom scans are required for other peaks within 2 dB of the highest peak that have not been included in any zoom scan to ensure there is no increase in SAR.

|   |                                    | $\leq 3$ GHz   | $> 3$ GHz   |
|---|------------------------------------|--|---|
| Maximum distance from closest measurement point (geometric center of probe sensors) to phantom surface  |                                    | $5 \pm 1$ mm   | $\frac{1}{2} \cdot \delta \cdot \ln(2) \pm 0.5$ mm                            |
| Maximum probe angle from probe axis to phantom surface normal at the measurement location   |                                    | $30^\circ \pm 1^\circ$   | $20^\circ \pm 1^\circ$  |
| Maximum area scan spatial resolution: $\Delta x_{Area}$ , $\Delta y_{Area}$   |                                    | $\leq 2$ GHz: $\leq 15$ mm<br>2 – 3 GHz: $\leq 12$ mm  | 3 – 4 GHz: $\leq 12$ mm<br>4 – 6 GHz: $\leq 10$ mm                            |
|   |                                    | When the x or y dimension of the test device, in the measurement plane orientation, is smaller than the above, the measurement resolution must be $\leq$ the corresponding x or y dimension of the test device with at least one measurement point on the test device. |   |
| Maximum zoom scan spatial resolution: $\Delta x_{Zoom}$ , $\Delta y_{Zoom}$   |                                    | $\leq 2$ GHz: $\leq 8$ mm<br>2 – 3 GHz: $\leq 5$ mm*   | 3 – 4 GHz: $\leq 5$ mm*<br>4 – 6 GHz: $\leq 4$ mm*                            |
| Maximum zoom scan spatial resolution, normal to phantom surface   | uniform grid: $\Delta z_{Zoom}(n)$ | $\leq 5$ mm  | 3 – 4 GHz: $\leq 4$ mm<br>4 – 5 GHz: $\leq 3$ mm<br>5 – 6 GHz: $\leq 2$ mm    |
|   | graded grid                        | $\Delta z_{Zoom}(1)$ : between 1 <sup>st</sup> two points closest to phantom surface   | $\leq 4$ mm   |
|   |                                    | $\Delta z_{Zoom}(n>1)$ : between subsequent points   | $\leq 1.5 \cdot \Delta z_{Zoom}(n-1)$   |
| Minimum zoom scan volume  | x, y, z                            | $\geq 30$ mm   | 3 – 4 GHz: $\geq 28$ mm<br>4 – 5 GHz: $\geq 25$ mm<br>5 – 6 GHz: $\geq 22$ mm |
| <p>Note: <math>\delta</math> is the penetration depth of a plane-wave at normal incidence to the tissue medium; see draft standard IEEE P1528-2011 for details.</p> <p>* When zoom scan is required and the <i>reported</i> SAR from the area scan based 1-g SAR estimation procedures of KDB 447498 is <math>\leq 1.4</math> W/kg, <math>\leq 8</math> mm, <math>\leq 7</math> mm and <math>\leq 5</math> mm zoom scan resolution may be applied, respectively, for 2 GHz to 3 GHz, 3 GHz to 4 GHz and 4 GHz to 6 GHz.</p> |                                    |  |   |

## 9.4 Volume Scan Procedures

The volume scan is used for assess overlapping SAR distributions for antennas transmitting in different frequency bands. It is equivalent to an oversized zoom scan used in standalone measurements. The measurement volume will be used to enclose all the simultaneous transmitting antennas. For antennas transmitting simultaneously in different frequency bands, the volume scan is measured separately in each frequency band. In order to sum correctly to compute the 1g aggregate SAR, the EUT remain in the same test position for all measurements and all volume scan use the same spatial resolution and grid spacing. When all volume scan were completed, the software, SEMCAD postprocessor can combine and subsequently superpose these measurement data to calculating the multiband SAR.

## 9.5 SAR Averaged Methods

In DASY, the interpolation and extrapolation are both based on the modified Quadratic Shepard's method. The interpolation scheme combines a least-square fitted function method and a weighted average method which are the two basic types of computational interpolation and approximation.

Extrapolation routines are used to obtain SAR values between the lowest measurement points and the inner phantom surface. The extrapolation distance is determined by the surface detection distance and the probe sensor offset. The uncertainty increases with the extrapolation distance. To keep the uncertainty within 1% for the 1 g and 10 g cubes, the extrapolation distance should not be larger than 5 mm.

## 9.6 Power Drift Monitoring

All SAR testing is under the EUT install full charged battery and transmit maximum output power. In DASY measurement software, the power reference measurement and power drift measurement procedures are used for monitoring the power drift of EUT during SAR test. Both these procedures measure the field at a specified reference position before and after the SAR testing. The software will calculate the field difference in dB. If the power drifts more than 5%, the SAR will be retested.

# 10. Conducted RF Output Power (Unit: dBm)

### <Bluetooth Conducted Power>

| Channel | Frequency (MHz) | Average power (dBm) |                |        |
|---------|-----------------|---------------------|----------------|--------|
|         |                 | Mode                |                |        |
|         |                 | GFSK                | $\pi/4$ -DQPSK | 8-DPSK |
| CH 0    | 2402            | 5.1                 | 5.3            | 5.0    |
| CH 39   | 2441            | 5.0                 | 5.2            | 4.9    |
| CH 78   | 2480            | 4.0                 | 4.3            | 4.0    |

**Note:**

- Per KDB 447498 D01v05r01, the 1-g and 10-g SAR test exclusion thresholds for 100 MHz to 6 GHz at *test separation distances*  $\leq 50$  mm are determined by:

$[(\text{max. power of channel, including tune-up tolerance, mW}) / (\text{min. test separation distance, mm})] \cdot [\sqrt{f(\text{GHz})}] \leq 3.0$  for 1-g SAR and  $\leq 7.5$  for 10-g extremity SAR

- f(GHz) is the RF channel transmit frequency in GHz
- Power and distance are rounded to the nearest mW and mm before calculation
- The result is rounded to one decimal place for comparison

| Bluetooth Maximum average power (dBm) | mW   | Test Distance (mm) | Frequency (GHz) | exclusion thresholds |
|---------------------------------------|------|--------------------|-----------------|----------------------|
| 5.5                                   | 3.55 | 5                  | 2.48            | 1.12                 |

- Per KDB 447498 D01v05r01 exclusion thresholds is  $1.12 < 3$ , RF exposure evaluation is not required.

**<WLAN 2.4GHz Conducted Power>**

**Note:**

1. Per KDB 248227 D01 v01r02, choose the highest output power channel to test SAR and determine further SAR exclusion
2. For each frequency band, testing at higher data rates and higher order modulations is not required when the maximum average output power for each of these configurations is less than 1/4dB higher than those measured at the lowest data rate
3. Apply the test exclusion rule in KDB 248227 D01 v01r02 11g, 11n-HT20 output power is less than 1/4dB higher than 11b mode, thus the SAR can be excluded.
4. The measured power of antenna 1 and antenna 2 is summed to a total power.

**<Total power of Antenna 1+2>**

| WLAN 2.4GHz 802.11b Average Power (dBm) |                 |           |                     |         |        |
|---|-----------------|-----------|---------------------|---------|--------|
| Power vs. Channel                       |                 |           | Power vs. Data Rate |         |        |
| Channel                                 | Frequency (MHz) | Data Rate | 2Mbps               | 5.5Mbps | 11Mbps |
|   |                 | 1Mbps     |                     |         |        |
| CH 1                                    | 2412            | 18.3      | 18.5                | 18.4    | 18.4   |
| CH 6                                    | 2437            | 18.5      |                     |         |        |
| CH 11                                   | 2462            | 18.5      |                     |         |        |

| WLAN 2.4GHz 802.11g Average Power (dBm) |                 |           |                     |        |        |        |        |        |        |
|---|-----------------|-----------|---------------------|--------|--------|--------|--------|--------|--------|
| Power vs. Channel                       |                 |           | Power vs. Data Rate |        |        |        |        |        |        |
| Channel                                 | Frequency (MHz) | Data Rate | 9Mbps               | 12Mbps | 18Mbps | 24Mbps | 36Mbps | 48Mbps | 54Mbps |
|   |                 | 6Mbps     |                     |        |        |        |        |        |        |
| CH 01                                   | 2412 MHz        | 10.6      | 17.6                | 17.6   | 17.6   | 14.0   | 14.0   | 13.9   | 13.8   |
| CH 02                                   | 2417 MHz        | 15.3      |                     |        |        |        |        |        |        |
| CH 06                                   | 2437 MHz        | 17.9      |                     |        |        |        |        |        |        |
| CH 10                                   | 2457 MHz        | 15.8      |                     |        |        |        |        |        |        |
| CH 11                                   | 2462 MHz        | 11.7      |                     |        |        |        |        |        |        |

| WLAN 2.4GHz 802.11n-HT20 Average Power (dBm) |                 |           |                     |      |      |      |      |      |      |
|--|-----------------|-----------|---------------------|------|------|------|------|------|------|
| Power vs. Channel                            |                 |           | Power vs. MCS Index |      |      |      |      |      |      |
| Channel                                      | Frequency (MHz) | MCS Index | MCS1                | MCS2 | MCS3 | MCS4 | MCS5 | MCS6 | MCS7 |
|  |                 | MCS0      |                     |      |      |      |      |      |      |
| CH 01  | 2412 MHz        | 9.6       | 17.8                | 17.9 | 15.4 | 15.3 | 15.3 | 13.8 | 13.8 |
| CH 02  | 2417 MHz        | 14.8      |                     |      |      |      |      |      |      |
| CH 06  | 2437 MHz        | 17.9      |                     |      |      |      |      |      |      |
| CH 10  | 2457 MHz        | 16.0      |                     |      |      |      |      |      |      |
| CH 11  | 2462 MHz        | 12.1      |                     |      |      |      |      |      |      |



**<Antenna 1>**

| WLAN 2.4GHz 802.11b Average Power (dBm) |                 |           |                     |         |        |
|---|-----------------|-----------|---------------------|---------|--------|
| Power vs. Channel                       |                 |           | Power vs. Data Rate |         |        |
| Channel                                 | Frequency (MHz) | Data Rate | 2Mbps               | 5.5Mbps | 11Mbps |
|   |                 | 1Mbps     |                     |         |        |
| CH 1                                    | 2412            | 15.6      | 16.0                | 15.9    | 15.9   |
| CH 6                                    | 2437            | 16.0      |                     |         |        |
| CH 11                                   | 2462            | 16.0      |                     |         |        |

| WLAN 2.4GHz 802.11g Average Power (dBm) |                 |           |                     |        |        |        |        |        |        |
|---|-----------------|-----------|---------------------|--------|--------|--------|--------|--------|--------|
| Power vs. Channel                       |                 |           | Power vs. Data Rate |        |        |        |        |        |        |
| Channel                                 | Frequency (MHz) | Data Rate | 9Mbps               | 12Mbps | 18Mbps | 24Mbps | 36Mbps | 48Mbps | 54Mbps |
|   |                 | 6Mbps     |                     |        |        |        |        |        |        |
| CH 01                                   | 2412 MHz        | 8.4       | 15.1                | 15.1   | 15.1   | 11.6   | 11.6   | 11.5   | 11.3   |
| CH 02                                   | 2417 MHz        | 12.9      |                     |        |        |        |        |        |        |
| CH 06                                   | 2437 MHz        | 15.3      |                     |        |        |        |        |        |        |
| CH 10                                   | 2457 MHz        | 13.2      |                     |        |        |        |        |        |        |
| CH 11                                   | 2462 MHz        | 9.5       |                     |        |        |        |        |        |        |

| WLAN 2.4GHz 802.11n-HT20 Average Power (dBm) |                 |           |                     |      |      |      |      |      |      |
|--|-----------------|-----------|---------------------|------|------|------|------|------|------|
| Power vs. Channel                            |                 |           | Power vs. MCS Index |      |      |      |      |      |      |
| Channel                                      | Frequency (MHz) | MCS Index | MCS1                | MCS2 | MCS3 | MCS4 | MCS5 | MCS6 | MCS7 |
|  |                 | MCS0      |                     |      |      |      |      |      |      |
| CH 01  | 2412 MHz        | 7.5       | 15.3                | 15.3 | 12.9 | 12.8 | 12.8 | 11.3 | 11.3 |
| CH 02  | 2417 MHz        | 12.4      |                     |      |      |      |      |      |      |
| CH 06  | 2437 MHz        | 15.3      |                     |      |      |      |      |      |      |
| CH 10  | 2457 MHz        | 13.7      |                     |      |      |      |      |      |      |
| CH 11  | 2462 MHz        | 9.9       |                     |      |      |      |      |      |      |

**<Antenna 2>**

| WLAN 2.4GHz 802.11b Average Power (dBm) |                 |           |                     |         |        |
|---|-----------------|-----------|---------------------|---------|--------|
| Power vs. Channel                       |                 |           | Power vs. Data Rate |         |        |
| Channel                                 | Frequency (MHz) | Data Rate | 2Mbps               | 5.5Mbps | 11Mbps |
|   |                 | 1Mbps     |                     |         |        |
| CH 1                                    | 2412            | 14.9      | 14.9                | 14.9    | 14.9   |
| CH 6                                    | 2437            | 15.0      |                     |         |        |
| CH 11                                   | 2462            | 15.0      |                     |         |        |

| WLAN 2.4GHz 802.11g Average Power (dBm) |                 |           |                     |        |        |        |        |        |        |
|---|-----------------|-----------|---------------------|--------|--------|--------|--------|--------|--------|
| Power vs. Channel                       |                 |           | Power vs. Data Rate |        |        |        |        |        |        |
| Channel                                 | Frequency (MHz) | Data Rate | 9Mbps               | 12Mbps | 18Mbps | 24Mbps | 36Mbps | 48Mbps | 54Mbps |
|   |                 | 6Mbps     |                     |        |        |        |        |        |        |
| CH 01                                   | 2412 MHz        | 6.5       | 14.1                | 14.1   | 14.1   | 10.3   | 10.2   | 10.3   | 10.2   |
| CH 02                                   | 2417 MHz        | 11.7      |                     |        |        |        |        |        |        |
| CH 06                                   | 2437 MHz        | 14.5      |                     |        |        |        |        |        |        |
| CH 10                                   | 2457 MHz        | 12.4      |                     |        |        |        |        |        |        |
| CH 11                                   | 2462 MHz        | 7.8       |                     |        |        |        |        |        |        |

| WLAN 2.4GHz 802.11n-HT20 Average Power (dBm) |                 |           |                     |      |      |      |      |      |      |
|--|-----------------|-----------|---------------------|------|------|------|------|------|------|
| Power vs. Channel                            |                 |           | Power vs. MCS Index |      |      |      |      |      |      |
| Channel                                      | Frequency (MHz) | MCS Index | MCS1                | MCS2 | MCS3 | MCS4 | MCS5 | MCS6 | MCS7 |
|  |                 | MCS0      |                     |      |      |      |      |      |      |
| CH 01  | 2412 MHz        | 5.6       | 14.1                | 14.4 | 11.7 | 11.7 | 11.7 | 10.3 | 10.3 |
| CH 02  | 2417 MHz        | 11.1      |                     |      |      |      |      |      |      |
| CH 06  | 2437 MHz        | 14.4      |                     |      |      |      |      |      |      |
| CH 10  | 2457 MHz        | 12.2      |                     |      |      |      |      |      |      |
| CH 11  | 2462 MHz        | 8.0       |                     |      |      |      |      |      |      |

**<WLAN 5GHz Conducted Power>**

**Note:**

1. Per KDB 248227 D01 v01r02, choose the highest output power channel to test SAR and determine further SAR exclusion
2. For each frequency band, testing at higher data rates and higher order modulations is not required when the maximum average output power for each of these configurations is less than 1/4dB higher than those measured at the lowest data rate
3. Apply the test exclusion rule in KDB 248227 D01 v01r02 11n-HT20 and 11n-HT40 output power is less than 1/4dB higher than 11a mode, thus the SAR can be excluded.
4. The measured power of antenna 1 and antenna 2 is summed to a total power.

**<Total power of Antenna 1+2>**

| WLAN 5GHz 802.11a Average Power (dBm) |                 |                 |                     |        |        |        |        |        |        |
|---------------------------------------|-----------------|-----------------|---------------------|--------|--------|--------|--------|--------|--------|
| Power vs. Channel                     |                 |                 | Power vs. Data Rate |        |        |        |        |        |        |
| Channel                               | Frequency (MHz) | Data Rate 6Mbps | 9Mbps               | 12Mbps | 18Mbps | 24Mbps | 36Mbps | 48Mbps | 54Mbps |
| CH 36                                 | 5180            | 14.6            |                     |        |        |        |        |        |        |
| CH 40                                 | 5200            | 14.6            |                     |        |        |        |        |        |        |
| CH 44                                 | 5220            | 14.5            | 14.4                | 14.3   | 14.3   | 14.2   | 14.2   | 14.2   | 14.2   |
| CH 48                                 | 5240            | 14.4            |                     |        |        |        |        |        |        |
| CH 52                                 | 5260            | 14.5            |                     |        |        |        |        |        |        |
| CH 56                                 | 5280            | 14.6            | 14.0                | 14.0   | 14.1   | 14.0   | 14.2   | 14.1   | 14.2   |
| CH 60                                 | 5300            | 14.6            |                     |        |        |        |        |        |        |
| CH 64                                 | 5320            | 14.5            |                     |        |        |        |        |        |        |
| CH 100                                | 5500            | 14.8            |                     |        |        |        |        |        |        |
| CH 104                                | 5520            | 14.8            |                     |        |        |        |        |        |        |
| CH 108                                | 5540            | 14.6            |                     |        |        |        |        |        |        |
| CH 112                                | 5560            | 14.6            |                     |        |        |        |        |        |        |
| CH 116                                | 5580            | 14.8            | 14.2                | 13.9   | 14.1   | 14.1   | 14.3   | 14.4   | 14.4   |
| CH 132                                | 5660            | 14.4            |                     |        |        |        |        |        |        |
| CH 136                                | 5680            | 14.7            |                     |        |        |        |        |        |        |
| CH 140                                | 5700            | 14.6            |                     |        |        |        |        |        |        |
| CH 144                                | 5720            | 14.5            |                     |        |        |        |        |        |        |
| CH 149                                | 5745            | 14.5            |                     |        |        |        |        |        |        |
| CH 153                                | 5765            | 14.7            |                     |        |        |        |        |        |        |
| CH 157                                | 5785            | 14.8            | 14.4                | 14.3   | 14.4   | 11.0   | 11.0   | 10.9   | 11.0   |
| CH 161                                | 5805            | 14.8            |                     |        |        |        |        |        |        |
| CH 165                                | 5825            | 14.7            |                     |        |        |        |        |        |        |

| WLAN 5GHz 802.11n-HT20 Average Power (dBm) |                 |                   |                     |       |       |       |       |       |       |
|--|-----------------|-------------------|---------------------|-------|-------|-------|-------|-------|-------|
| Power vs. Channel                          |                 |                   | Power vs. MCS Index |       |       |       |       |       |       |
| Channel                                    | Frequency (MHz) | MCS Index<br>MCS8 | MCS9                | MCS10 | MCS11 | MCS12 | MCS13 | MCS14 | MCS15 |
| CH 36                                      | 5180            | 14.6              | 14.4                | 14.3  | 14.4  | 14.3  | 14.4  | 14.3  | 14.3  |
| CH 40                                      | 5200            | 14.4              |                     |       |       |       |       |       |       |
| CH 44                                      | 5220            | 14.4              |                     |       |       |       |       |       |       |
| CH 48                                      | 5240            | 14.3              |                     |       |       |       |       |       |       |
| CH 52                                      | 5260            | 14.3              | 14.2                | 14.2  | 14.2  | 14.2  | 14.3  | 14.3  | 14.3  |
| CH 56                                      | 5280            | 14.3              |                     |       |       |       |       |       |       |
| CH 60                                      | 5300            | 14.4              |                     |       |       |       |       |       |       |
| CH 64                                      | 5320            | 14.3              |                     |       |       |       |       |       |       |
| CH 100                                     | 5500            | 14.7              |                     |       |       |       |       |       |       |
| CH 104                                     | 5520            | 14.7              | 14.6                | 14.5  | 14.6  | 14.6  | 14.6  | 14.6  | 14.6  |
| CH 108                                     | 5540            | 14.8              |                     |       |       |       |       |       |       |
| CH 112                                     | 5560            | 14.7              |                     |       |       |       |       |       |       |
| CH 116                                     | 5580            | 14.5              |                     |       |       |       |       |       |       |
| CH 132                                     | 5660            | 14.6              |                     |       |       |       |       |       |       |
| CH 136                                     | 5680            | 14.6              |                     |       |       |       |       |       |       |
| CH 140                                     | 5700            | 14.7              |                     |       |       |       |       |       |       |
| CH 144                                     | 5720            | 14.4              |                     |       |       |       |       |       |       |
| CH 149                                     | 5745            | 14.8              | 14.6                | 14.7  | 12.7  | 12.8  | 12.8  | 11.0  | 11.9  |
| CH 153                                     | 5765            | 14.7              |                     |       |       |       |       |       |       |
| CH 157                                     | 5785            | 14.8              |                     |       |       |       |       |       |       |
| CH 161                                     | 5805            | 14.5              |                     |       |       |       |       |       |       |
| CH 165                                     | 5825            | 14.5              |                     |       |       |       |       |       |       |

| WLAN 5GHz 802.11n-HT40 Average Power (dBm) |                 |                   |                     |       |       |       |       |       |       |
|--|-----------------|-------------------|---------------------|-------|-------|-------|-------|-------|-------|
| Power vs. Channel                          |                 |                   | Power vs. MCS Index |       |       |       |       |       |       |
| Channel                                    | Frequency (MHz) | MCS Index<br>MCS8 | MCS9                | MCS10 | MCS11 | MCS12 | MCS13 | MCS14 | MCS15 |
| CH 38                                      | 5190            | 14.4              | 14.1                | 14.2  | 13.0  | 13.0  | 13.0  | 13.0  | 13.0  |
| CH 46                                      | 5230            | 14.5              |                     |       |       |       |       |       |       |
| CH 54                                      | 5270            | 14.6              |                     |       |       |       |       |       |       |
| CH 62                                      | 5310            | 13.1              | 14.0                | 14.0  | 12.2  | 13.0  | 12.9  | 13.0  | 12.9  |
| CH 102                                     | 5510            | 11.1              |                     |       |       |       |       |       |       |
| CH 110                                     | 5550            | 14.7              |                     |       |       |       |       |       |       |
| CH 134                                     | 5670            | 14.6              |                     |       |       |       |       |       |       |
| CH 142                                     | 5710            | 14.1              | 14.4                | 14.5  | 13.4  | 13.6  | 13.4  | 13.5  | 13.5  |
| CH 151                                     | 5755            | 14.7              |                     |       |       |       |       |       |       |
| CH 159                                     | 5795            | 14.6              |                     |       |       |       |       |       |       |
| CH 151                                     | 5755            | 14.7              | 14.6                | 14.5  | 10.6  | 10.7  | 10.2  | 10.7  | 11.0  |
| CH 159                                     | 5795            | 14.6              |                     |       |       |       |       |       |       |

**<Antenna 1>**

| WLAN 5GHz 802.11a Average Power (dBm) |                 |           |                     |        |        |        |        |        |        |
|---------------------------------------|-----------------|-----------|---------------------|--------|--------|--------|--------|--------|--------|
| Power vs. Channel                     |                 |           | Power vs. Data Rate |        |        |        |        |        |        |
| Channel                               | Frequency (MHz) | Data Rate | 9Mbps               | 12Mbps | 18Mbps | 24Mbps | 36Mbps | 48Mbps | 54Mbps |
|                                       |                 | 6Mbps     |                     |        |        |        |        |        |        |
| CH 36                                 | 5180            | 13.0      | 12.8                | 12.8   | 12.8   | 12.7   | 12.7   | 12.7   | 12.6   |
| CH 40                                 | 5200            | 13.0      |                     |        |        |        |        |        |        |
| CH 44                                 | 5220            | 12.9      |                     |        |        |        |        |        |        |
| CH 48                                 | 5240            | 12.8      |                     |        |        |        |        |        |        |
| CH 52                                 | 5260            | 13.0      | 12.4                | 12.5   | 12.6   | 12.5   | 12.7   | 12.6   | 12.6   |
| CH 56                                 | 5280            | 13.0      |                     |        |        |        |        |        |        |
| CH 60                                 | 5300            | 13.0      |                     |        |        |        |        |        |        |
| CH 64                                 | 5320            | 13.0      |                     |        |        |        |        |        |        |
| CH 100                                | 5500            | 13.0      |                     |        |        |        |        |        |        |
| CH 104                                | 5520            | 13.0      |                     |        |        |        |        |        |        |
| CH 108                                | 5540            | 12.8      | 12.4                | 12.1   | 12.3   | 12.2   | 12.6   | 12.5   | 12.6   |
| CH 112                                | 5560            | 12.8      |                     |        |        |        |        |        |        |
| CH 116                                | 5580            | 13.0      |                     |        |        |        |        |        |        |
| CH 132                                | 5660            | 12.7      |                     |        |        |        |        |        |        |
| CH 136                                | 5680            | 13.0      |                     |        |        |        |        |        |        |
| CH 140                                | 5700            | 12.9      |                     |        |        |        |        |        |        |
| CH 144                                | 5720            | 13.0      |                     |        |        |        |        |        |        |
| CH 149                                | 5745            | 12.8      |                     |        |        |        |        |        |        |
| CH 153                                | 5765            | 12.9      | 12.6                | 12.6   | 12.6   | 9.4    | 9.4    | 9.2    | 9.4    |
| CH 157                                | 5785            | 13.0      |                     |        |        |        |        |        |        |
| CH 161                                | 5805            | 13.0      |                     |        |        |        |        |        |        |
| CH 165                                | 5825            | 13.0      |                     |        |        |        |        |        |        |

| WLAN 5GHz 802.11n-HT20 Average Power (dBm) |                 |           |                     |      |      |      |      |      |      |
|--|-----------------|-----------|---------------------|------|------|------|------|------|------|
| Power vs. Channel                          |                 |           | Power vs. MCS Index |      |      |      |      |      |      |
| Channel                                    | Frequency (MHz) | MCS Index | MCS1                | MCS2 | MCS3 | MCS4 | MCS5 | MCS6 | MCS7 |
|  |                 | MCS0      |                     |      |      |      |      |      |      |
| CH 36                                      | 5180            | 13.0      | 12.9                | 12.8 | 12.9 | 12.8 | 12.9 | 12.8 | 12.9 |
| CH 40                                      | 5200            | 12.9      |                     |      |      |      |      |      |      |
| CH 44                                      | 5220            | 12.9      |                     |      |      |      |      |      |      |
| CH 48                                      | 5240            | 12.7      |                     |      |      |      |      |      |      |
| CH 52                                      | 5260            | 12.8      | 12.8                | 12.6 | 12.7 | 12.7 | 12.8 | 12.7 | 12.8 |
| CH 56                                      | 5280            | 12.8      |                     |      |      |      |      |      |      |
| CH 60                                      | 5300            | 12.9      |                     |      |      |      |      |      |      |
| CH 64                                      | 5320            | 12.8      |                     |      |      |      |      |      |      |
| CH 100                                     | 5500            | 12.9      |                     |      |      |      |      |      |      |
| CH 104                                     | 5520            | 12.9      |                     |      |      |      |      |      |      |
| CH 108                                     | 5540            | 13.0      | 12.8                | 12.8 | 13.0 | 12.9 | 12.9 | 13.0 | 12.9 |
| CH 112                                     | 5560            | 13.0      |                     |      |      |      |      |      |      |
| CH 116                                     | 5580            | 13.0      |                     |      |      |      |      |      |      |
| CH 132                                     | 5660            | 13.0      |                     |      |      |      |      |      |      |
| CH 136                                     | 5680            | 12.9      |                     |      |      |      |      |      |      |
| CH 140                                     | 5700            | 13.0      |                     |      |      |      |      |      |      |
| CH 144                                     | 5720            | 12.8      |                     |      |      |      |      |      |      |
| CH 149                                     | 5745            | 13.0      |                     |      |      |      |      |      |      |
| CH 153                                     | 5765            | 12.9      | 12.8                | 12.8 | 11.0 | 11.1 | 11.2 | 9.3  | 10.2 |
| CH 157                                     | 5785            | 13.0      |                     |      |      |      |      |      |      |
| CH 161                                     | 5805            | 13.0      |                     |      |      |      |      |      |      |
| CH 165                                     | 5825            | 12.9      |                     |      |      |      |      |      |      |

| WLAN 5GHz 802.11n-HT40 Average Power (dBm) |                 |                   |                     |      |      |      |      |      |      |
|--|-----------------|-------------------|---------------------|------|------|------|------|------|------|
| Power vs. Channel                          |                 |                   | Power vs. MCS Index |      |      |      |      |      |      |
| Channel                                    | Frequency (MHz) | MCS Index<br>MCS0 | MCS1                | MCS2 | MCS3 | MCS4 | MCS5 | MCS6 | MCS7 |
| CH 38                                      | 5190            | 12.8              | 12.7                | 12.7 | 11.6 | 11.6 | 11.6 | 11.5 | 11.6 |
| CH 46                                      | 5230            | 12.9              |                     |      |      |      |      |      |      |
| CH 54                                      | 5270            | 13.0              |                     |      |      |      |      |      |      |
| CH 62                                      | 5310            | 11.7              | 12.6                | 12.5 | 10.4 | 11.5 | 11.5 | 11.5 | 11.5 |
| CH 102                                     | 5510            | 9.6               |                     |      |      |      |      |      |      |
| CH 110                                     | 5550            | 12.9              |                     |      |      |      |      |      |      |
| CH 134                                     | 5670            | 12.9              |                     |      |      |      |      |      |      |
| CH 142                                     | 5710            | 12.5              |                     |      |      |      |      |      |      |
| CH 151                                     | 5755            | 13.0              |                     |      |      |      |      |      |      |
| CH 159                                     | 5795            | 13.0              | 13.0                | 12.8 | 8.9  | 9.0  | 8.5  | 9.0  | 9.3  |

**<Antenna 2>**

| WLAN 5GHz 802.11a Average Power (dBm) |                 |                    |                     |        |        |        |        |        |        |
|---------------------------------------|-----------------|--------------------|---------------------|--------|--------|--------|--------|--------|--------|
| Power vs. Channel                     |                 |                    | Power vs. Data Rate |        |        |        |        |        |        |
| Channel                               | Frequency (MHz) | Data Rate<br>6Mbps | 9Mbps               | 12Mbps | 18Mbps | 24Mbps | 36Mbps | 48Mbps | 54Mbps |
| CH 36                                 | 5180            | 9.5                | 9.3                 | 9.1    | 8.9    | 8.8    | 8.9    | 8.9    | 8.8    |
| CH 40                                 | 5200            | 9.5                |                     |        |        |        |        |        |        |
| CH 44                                 | 5220            | 9.3                |                     |        |        |        |        |        |        |
| CH 48                                 | 5240            | 9.2                |                     |        |        |        |        |        |        |
| CH 52                                 | 5260            | 9.2                | 8.7                 | 8.6    | 8.7    | 8.8    | 8.8    | 8.8    | 8.8    |
| CH 56                                 | 5280            | 9.5                |                     |        |        |        |        |        |        |
| CH 60                                 | 5300            | 9.5                |                     |        |        |        |        |        |        |
| CH 64                                 | 5320            | 9.3                |                     |        |        |        |        |        |        |
| CH 100                                | 5500            | 10.0               |                     |        |        |        |        |        |        |
| CH 104                                | 5520            | 10.0               |                     |        |        |        |        |        |        |
| CH 108                                | 5540            | 10.0               | 9.6                 | 9.3    | 9.4    | 9.5    | 9.5    | 9.8    | 9.7    |
| CH 112                                | 5560            | 10.0               |                     |        |        |        |        |        |        |
| CH 116                                | 5580            | 10.0               |                     |        |        |        |        |        |        |
| CH 132                                | 5660            | 9.6                |                     |        |        |        |        |        |        |
| CH 136                                | 5680            | 9.8                |                     |        |        |        |        |        |        |
| CH 140                                | 5700            | 9.7                |                     |        |        |        |        |        |        |
| CH 144                                | 5720            | 9.3                |                     |        |        |        |        |        |        |
| CH 149                                | 5745            | 9.6                |                     |        |        |        |        |        |        |
| CH 153                                | 5765            | 9.9                | 9.6                 | 9.4    | 9.7    | 6.0    | 6.0    | 6.1    | 6.1    |
| CH 157                                | 5785            | 10.0               |                     |        |        |        |        |        |        |
| CH 161                                | 5805            | 10.0               |                     |        |        |        |        |        |        |
| CH 165                                | 5825            | 9.9                |                     |        |        |        |        |        |        |

| WLAN 5GHz 802.11n-HT20 Average Power (dBm) |                 |                   |                     |      |      |      |      |      |      |
|--|-----------------|-------------------|---------------------|------|------|------|------|------|------|
| Power vs. Channel                          |                 |                   | Power vs. MCS Index |      |      |      |      |      |      |
| Channel                                    | Frequency (MHz) | MCS Index<br>MCS0 | MCS1                | MCS2 | MCS3 | MCS4 | MCS5 | MCS6 | MCS7 |
| CH 36                                      | 5180            | 9.4               | 8.9                 | 9.0  | 8.9  | 8.9  | 8.9  | 9.0  | 8.9  |
| CH 40                                      | 5200            | 9.0               |                     |      |      |      |      |      |      |
| CH 44                                      | 5220            | 9.1               |                     |      |      |      |      |      |      |
| CH 48                                      | 5240            | 9.1               |                     |      |      |      |      |      |      |
| CH 52                                      | 5260            | 9.0               | 8.6                 | 8.9  | 9.0  | 8.9  | 9.1  | 9.2  | 9.0  |
| CH 56                                      | 5280            | 9.0               |                     |      |      |      |      |      |      |
| CH 60                                      | 5300            | 9.2               |                     |      |      |      |      |      |      |
| CH 64                                      | 5320            | 9.0               |                     |      |      |      |      |      |      |
| CH 100                                     | 5500            | 9.9               |                     |      |      |      |      |      |      |
| CH 104                                     | 5520            | 10.0              | 9.9                 | 9.5  | 9.7  | 9.7  | 9.7  | 9.7  | 9.8  |
| CH 108                                     | 5540            | 10.0              |                     |      |      |      |      |      |      |
| CH 112                                     | 5560            | 9.8               |                     |      |      |      |      |      |      |
| CH 116                                     | 5580            | 9.2               |                     |      |      |      |      |      |      |
| CH 132                                     | 5660            | 9.6               |                     |      |      |      |      |      |      |
| CH 136                                     | 5680            | 9.8               |                     |      |      |      |      |      |      |
| CH 140                                     | 5700            | 10.0              |                     |      |      |      |      |      |      |
| CH 144                                     | 5720            | 9.4               | 9.9                 | 10.0 | 7.9  | 7.8  | 7.9  | 6.0  | 6.9  |
| CH 149                                     | 5745            | 10.0              |                     |      |      |      |      |      |      |
| CH 153                                     | 5765            | 10.0              |                     |      |      |      |      |      |      |
| CH 157                                     | 5785            | 10.0              |                     |      |      |      |      |      |      |
| CH 161                                     | 5805            | 9.2               |                     |      |      |      |      |      |      |
| CH 165                                     | 5825            | 9.4               |                     |      |      |      |      |      |      |

| WLAN 5GHz 802.11n-HT40 Average Power (dBm) |                 |                   |                     |      |      |      |      |      |      |     |     |     |     |     |     |     |
|--|-----------------|-------------------|---------------------|------|------|------|------|------|------|-----|-----|-----|-----|-----|-----|-----|
| Power vs. Channel                          |                 |                   | Power vs. MCS Index |      |      |      |      |      |      |     |     |     |     |     |     |     |
| Channel                                    | Frequency (MHz) | MCS Index<br>MCS0 | MCS1                | MCS2 | MCS3 | MCS4 | MCS5 | MCS6 | MCS7 |     |     |     |     |     |     |     |
| CH 38                                      | 5190            | 9.3               | 8.6                 | 8.6  | 7.5  | 7.5  | 7.4  | 7.6  | 7.5  |     |     |     |     |     |     |     |
| CH 46                                      | 5230            | 9.3               |                     |      |      |      |      |      |      |     |     |     |     |     |     |     |
| CH 54                                      | 5270            | 9.5               |                     |      |      |      |      |      |      |     |     |     |     |     |     |     |
| CH 62                                      | 5310            | 7.4               | 8.4                 | 8.5  | 7.5  | 7.5  | 7.4  | 7.6  | 7.4  |     |     |     |     |     |     |     |
| CH 102                                     | 5510            | 5.9               |                     |      |      |      |      |      |      |     |     |     |     |     |     |     |
| CH 110                                     | 5550            | 10.0              |                     |      |      |      |      |      |      |     |     |     |     |     |     |     |
| CH 134                                     | 5670            | 9.7               |                     |      |      |      |      |      |      |     |     |     |     |     |     |     |
| CH 142                                     | 5710            | 8.8               | 9.7                 | 9.8  | 9.1  | 9.2  | 9.0  | 9.1  | 9.1  |     |     |     |     |     |     |     |
| CH 151                                     | 5755            | 9.9               |                     |      |      |      |      |      |      |     |     |     |     |     |     |     |
| CH 159                                     | 5795            | 9.5               |                     |      |      |      |      |      |      |     |     |     |     |     |     |     |
|  |                 |                   |                     |      |      |      |      |      |      | 9.6 | 9.7 | 5.8 | 5.9 | 5.2 | 5.9 | 6.2 |
|  |                 |                   |                     |      |      |      |      |      |      |     |     |     |     |     |     |     |

## 11. Exposure Position Conditions

### <Distance from the antenna to the edge>

| Exposure Position                  | Bottom Face | Edge1  | Edge2  | Edge3   | Edge4  |
|------------------------------------|-------------|--------|--------|---------|--------|
| Antenna1 to the Edge distance (mm) | < 5 mm      | 5 mm   | 120 mm | 110 mm  | 33 mm  |
| Antenna2 to the Edge distance (mm) | < 5 mm      | 114 mm | 26 mm  | 5.17 mm | 129 mm |

#### Note:

- The detail antenna locations please refer to setup photo.
- This device overall diagonal dimension is 217mm, and according to KDB 616217 D04v01r01, if the diagonal is greater than 200mm, SAR evaluation for the front surface of tablet display screens are generally not necessary.

### <SAR test exclusion table>

| Exposure Position | Wireless Interface              | 802.11b Antenna 1 | 802.11b Antenna 2 | 802.11a Antenna 1 | 802.11a Antenna 2 |
|-------------------|---------------------------------|-------------------|-------------------|-------------------|-------------------|
|                   | Tune-up Maximum power           | 16                | 15                | 13                | 10                |
|                   | Tune-up Maximum rated power(mW) | 39.81             | 31.62             | 19.95             | 10.00             |
| Bottom Face       | Antenna to user (mm)            | 5                 | 5                 | 5                 | 5                 |
|                   | SAR exclusion threshold         | 12.49             | 9.92              | 9.63              | 4.83              |
|                   | SAR testing required?           | Yes               | Yes               | Yes               | Yes               |
| Edge 1            | Antenna to user (mm)            | 5                 | 114               | 5                 | 114               |
|                   | SAR exclusion threshold         | 12.49             | 735.6             | 9.63              | 702.15            |
|                   | SAR testing required?           | Yes               | No                | Yes               | No                |
| Edge 2            | Antenna to user (mm)            | 120               | 26                | 120               | 26                |
|                   | SAR exclusion threshold         | 795.6             | 1.91              | 762.15            | 0.93              |
|                   | SAR testing required?           | No                | No                | No                | No                |
| Edge 3            | Antenna to user (mm)            | 110               | 5.17              | 110               | 5.17              |
|                   | SAR exclusion threshold         | 695.6             | 9.6               | 662.15            | 4.67              |
|                   | SAR testing required?           | No                | Yes               | No                | Yes               |
| Edge 4            | Antenna to user (mm)            | 33                | 129               | 33                | 129               |
|                   | SAR exclusion threshold         | 1.89              | 885.6             | 1.46              | 852.15            |
|                   | SAR testing required?           | No                | No                | No                | No                |

#### Note:

- Maximum power is the source-based time-average power and represents the maximum RF output power among production units
- Per KDB 447498 D01v05r01, for larger devices, the test separation distance of adjacent edge configuration is determined by the closest separation between the antenna and the user.
- Per KDB 447498 D01v05r01, standalone SAR test exclusion threshold is applied; If the distance of the antenna to the user is < 5mm, 5mm is used to determine SAR exclusion threshold
- Per KDB 447498 D01v05r01, the 1-g and 10-g SAR test exclusion thresholds for 100 MHz to 6 GHz at *test separation distances* ≤ 50 mm are determined by:
 
$$[(\text{max. power of channel, including tune-up tolerance, mW}) / (\text{min. test separation distance, mm})] \cdot [\sqrt{f(\text{GHz})}] \leq 3.0$$
 for 1-g SAR and ≤ 7.5 for 10-g extremity SAR
  - f(GHz) is the RF channel transmit frequency in GHz
  - Power and distance are rounded to the nearest mW and mm before calculation
  - The result is rounded to one decimal place for comparison
- Per KDB 447498 D01v05r01, at 100 MHz to 6 GHz and for *test separation distances* > 50 mm, the SAR test exclusion threshold is determined according to the following
  - [Threshold at 50 mm in step 1) + (test separation distance - 50 mm) · ( f(MHz)/150)] mW, at 100 MHz to 1500 MHz
  - [Threshold at 50 mm in step 1) + (test separation distance - 50 mm) · 10] mW at > 1500 MHz and ≤ 6 GHz.



## 12. SAR Test Results

### Note:

1. Per KDB 447498 D01v05r01, the reported SAR is the measured SAR value adjusted for maximum tune-up tolerance.
  - (a) Tune-up scaling Factor = tune-up limit power (mW) / EUT RF power (mW), where tune-up limit is the maximum rated power among all production units.
  - (b) For WLAN: Reported SAR(W/kg)= Measured SAR(W/kg)\* Tune-up Scaling Factor
2. Per KDB 447498 D01v05r01, for each exposure position, testing of other required channels within the operating mode of a frequency band is not required when the *reported* 1-g or 10-g SAR for the mid-band or highest output power channel is:
  - ≤ 0.8 W/kg or 2.0 W/kg, for 1-g or 10-g respectively, when the transmission band is ≤ 100 MHz
  - ≤ 0.6 W/kg or 1.5 W/kg, for 1-g or 10-g respectively, when the transmission band is between 100 MHz and 200 MHz
  - ≤ 0.4 W/kg or 1.0 W/kg, for 1-g or 10-g respectively, when the transmission band is ≥ 200 MHz
3. For SAR testing of the slant region of the device, the device was slanted and placed directly against the phantom.
4. Single antenna RF power in SISO mode is larger or equal to the single antenna RF power in MIMO mode, and for RF exposure assessment of MIMO mode simultaneous transmission exclusion analysis was performed with SAR test results of each antenna in SISO mode.

### 12.1 Body SAR

#### <WLAN SAR-DTS>

| Plot No. | Band       | Mode          | Test Position                | Antenna | Ch. | Freq. (MHz) | Average Power (dBm) | Tune-Up Limit (dBm) | Tune-up Scaling Factor | Power Drift (dB) | Measured 1g SAR (W/kg) | Reported 1g SAR (W/kg) |
|----------|------------|---------------|------------------------------|---------|-----|-------------|---------------------|---------------------|------------------------|------------------|------------------------|------------------------|
| 282      | WLAN2.4GHz | 802.11b 1Mbps | Bottom Face                  | Ant 1   | 11  | 2462        | 16.0                | 16.0                | 1.000                  | -0.09            | 1.180                  | 1.180                  |
| 283      | WLAN2.4GHz | 802.11b 1Mbps | Bottom Face                  | Ant 1   | 1   | 2412        | 15.6                | 16.0                | 1.096                  | -0.19            | 0.949                  | 1.041                  |
| 284      | WLAN2.4GHz | 802.11b 1Mbps | Bottom Face                  | Ant 1   | 6   | 2437        | 16.0                | 16.0                | 1.000                  | -0.07            | 1.150                  | 1.150                  |
| 300      | WLAN2.4GHz | 802.11b 1Mbps | Bottom Face - Slant of Ant 1 | Ant 1   | 11  | 2462        | 16.0                | 16.0                | 1.000                  | 0.11             | 0.815                  | 0.815                  |
| 301      | WLAN2.4GHz | 802.11b 1Mbps | Bottom Face - Slant of Ant 1 | Ant 1   | 1   | 2412        | 15.6                | 16.0                | 1.096                  | 0.11             | 0.774                  | 0.849                  |
| 302      | WLAN2.4GHz | 802.11b 1Mbps | Bottom Face - Slant of Ant 1 | Ant 1   | 6   | 2437        | 16.0                | 16.0                | 1.000                  | 0.06             | 0.943                  | 0.943                  |
| 303      | WLAN2.4GHz | 802.11b 1Mbps | Edge 1                       | Ant 1   | 11  | 2462        | 16.0                | 16.0                | 1.000                  | 0.14             | 0.367                  | 0.367                  |
| 222      | WLAN5GHz   | 802.11a 6Mbps | Bottom Face                  | Ant 1   | 157 | 5785        | 13.0                | 13.0                | 1.000                  | -0.04            | 0.379                  | 0.379                  |
| 218      | WLAN5GHz   | 802.11a 6Mbps | Bottom Face - Slant of Ant 1 | Ant 1   | 157 | 5785        | 13.0                | 13.0                | 1.000                  | 0.14             | 0.341                  | 0.341                  |
| 223      | WLAN5GHz   | 802.11a 6Mbps | Edge 1                       | Ant 1   | 157 | 5785        | 13.0                | 13.0                | 1.000                  | -0.09            | 0.692                  | 0.692                  |
| 309      | WLAN5GHz   | 802.11a 6Mbps | Edge 1                       | Ant 1   | 153 | 5765        | 12.9                | 13.0                | 1.023                  | -0.1             | 0.686                  | 0.702                  |
| 310      | WLAN5GHz   | 802.11a 6Mbps | Edge 1                       | Ant 1   | 161 | 5805        | 13.0                | 13.0                | 1.000                  | 0.13             | 0.700                  | 0.700                  |

| Plot No. | Band       | Mode          | Test Position                | Antenna | Ch. | Freq. (MHz) | Average Power (dBm) | Tune-Up Limit (dBm) | Tune-up Scaling Factor | Power Drift (dB) | Measured 1g SAR (W/kg) | Reported 1g SAR (W/kg) |
|----------|------------|---------------|------------------------------|---------|-----|-------------|---------------------|---------------------|------------------------|------------------|------------------------|------------------------|
| 277      | WLAN2.4GHz | 802.11b 1Mbps | Bottom Face                  | Ant 2   | 11  | 2462        | 15.0                | 15.0                | 1.000                  | -0.05            | 1.220                  | 1.220                  |
| 278      | WLAN2.4GHz | 802.11b 1Mbps | Bottom Face                  | Ant 2   | 1   | 2412        | 14.9                | 15.0                | 1.023                  | -0.05            | 0.803                  | 0.822                  |
| 279      | WLAN2.4GHz | 802.11b 1Mbps | Bottom Face                  | Ant 2   | 6   | 2437        | 15.0                | 15.0                | 1.000                  | -0.03            | 1.110                  | 1.110                  |
| 273      | WLAN2.4GHz | 802.11b 1Mbps | Bottom Face - Slant of Ant 2 | Ant 2   | 11  | 2462        | 15.0                | 15.0                | 1.000                  | -0.15            | 1.140                  | 1.140                  |
| 272      | WLAN2.4GHz | 802.11b 1Mbps | Bottom Face - Slant of Ant 2 | Ant 2   | 1   | 2412        | 14.9                | 15.0                | 1.023                  | -0.18            | 1.260                  | 1.289                  |
| 271      | WLAN2.4GHz | 802.11b 1Mbps | Bottom Face - Slant of Ant 2 | Ant 2   | 6   | 2437        | 15.0                | 15.0                | 1.000                  | -0.14            | 1.230                  | 1.230                  |
| 280      | WLAN2.4GHz | 802.11b 1Mbps | Edge 3                       | Ant 2   | 11  | 2412        | 15.0                | 15.0                | 1.000                  | 0.1              | 0.713                  | 0.713                  |
| 293      | WLAN5GHz   | 802.11a 6Mbps | Bottom Face                  | Ant 2   | 161 | 5805        | 10.0                | 10.0                | 1.000                  | -0.11            | 0.582                  | 0.582                  |
| 265      | WLAN5GHz   | 802.11a 6Mbps | Bottom Face - Slant of Ant 2 | Ant 2   | 161 | 5805        | 10.0                | 10.0                | 1.000                  | 0.11             | 1.220                  | 1.220                  |
| 263      | WLAN5GHz   | 802.11a 6Mbps | Bottom Face - Slant of Ant 2 | Ant 2   | 153 | 5765        | 9.9                 | 10.0                | 1.023                  | 0.05             | 1.200                  | 1.228                  |
| 264      | WLAN5GHz   | 802.11a 6Mbps | Bottom Face - Slant of Ant 2 | Ant 2   | 157 | 5785        | 10.0                | 10.0                | 1.000                  | -0.19            | 1.210                  | 1.210                  |
| 294      | WLAN5GHz   | 802.11a 6Mbps | Edge 3                       | Ant 2   | 161 | 5805        | 10.0                | 10.0                | 1.000                  | -0.06            | 0.519                  | 0.519                  |

### <WLAN SAR-NII>

| Plot No. | Band     | Mode          | Test Position                | Antenna | Ch. | Freq. (MHz) | Average Power (dBm) | Tune-Up Limit (dBm) | Tune-up Scaling Factor | Power Drift (dB) | Measured 1g SAR (W/kg) | Reported 1g SAR (W/kg) |
|----------|----------|---------------|------------------------------|---------|-----|-------------|---------------------|---------------------|------------------------|------------------|------------------------|------------------------|
| 219      | WLAN5GHz | 802.11a 6Mbps | Bottom Face                  | Ant 1   | 40  | 5200        | 13.0                | 13.0                | 1.000                  | -0.14            | 0.407                  | 0.407                  |
| 215      | WLAN5GHz | 802.11a 6Mbps | Bottom Face - Slant of Ant 1 | Ant 1   | 40  | 5200        | 13.0                | 13.0                | 1.000                  | -0.1             | 0.613                  | 0.613                  |
| 224      | WLAN5GHz | 802.11a 6Mbps | Edge 1                       | Ant 1   | 40  | 5200        | 13.0                | 13.0                | 1.000                  | -0.15            | 0.926                  | 0.926                  |
| 233      | WLAN5GHz | 802.11a 6Mbps | Edge 1                       | Ant 1   | 44  | 5220        | 12.9                | 13.0                | 1.027                  | -0.05            | 0.977                  | 1.004                  |
| 220      | WLAN5GHz | 802.11a 6Mbps | Bottom Face                  | Ant 1   | 56  | 5280        | 13.0                | 13.0                | 1.000                  | -0.04            | 0.399                  | 0.399                  |
| 216      | WLAN5GHz | 802.11a 6Mbps | Bottom Face - Slant of Ant 1 | Ant 1   | 56  | 5280        | 13.0                | 13.0                | 1.000                  | -0.07            | 0.373                  | 0.373                  |
| 225      | WLAN5GHz | 802.11a 6Mbps | Edge 1                       | Ant 1   | 56  | 5280        | 13.0                | 13.0                | 1.000                  | 0.04             | 0.688                  | 0.688                  |
| 221      | WLAN5GHz | 802.11a 6Mbps | Bottom Face                  | Ant 1   | 104 | 5520        | 13.0                | 13.0                | 1.000                  | -0.02            | 0.594                  | 0.594                  |
| 229      | WLAN5GHz | 802.11a 6Mbps | Bottom Face                  | Ant 1   | 116 | 5580        | 13.0                | 13.0                | 1.000                  | -0.07            | 0.545                  | 0.545                  |
| 230      | WLAN5GHz | 802.11a 6Mbps | Bottom Face                  | Ant 1   | 136 | 5680        | 13.0                | 13.0                | 1.000                  | -0.13            | 0.541                  | 0.541                  |
| 217      | WLAN5GHz | 802.11a 6Mbps | Bottom Face - Slant of Ant 1 | Ant 1   | 104 | 5520        | 13.0                | 13.0                | 1.000                  | -0.09            | 0.637                  | 0.637                  |
| 231      | WLAN5GHz | 802.11a 6Mbps | Bottom Face - Slant of Ant 1 | Ant 1   | 116 | 5580        | 13.0                | 13.0                | 1.000                  | -0.02            | 0.632                  | 0.632                  |
| 232      | WLAN5GHz | 802.11a 6Mbps | Bottom Face - Slant of Ant 1 | Ant 1   | 136 | 5680        | 13.0                | 13.0                | 1.000                  | -0.08            | 0.609                  | 0.609                  |
| 226      | WLAN5GHz | 802.11a 6Mbps | Edge 1                       | Ant 1   | 104 | 5520        | 13.0                | 13.0                | 1.000                  | -0.08            | 1.000                  | 1.000                  |
| 227      | WLAN5GHz | 802.11a 6Mbps | Edge 1                       | Ant 1   | 116 | 5580        | 13.0                | 13.0                | 1.000                  | -0.08            | 0.765                  | 0.765                  |
| 228      | WLAN5GHz | 802.11a 6Mbps | Edge 1                       | Ant 1   | 136 | 5680        | 13.0                | 13.0                | 1.000                  | -0.04            | 0.706                  | 0.706                  |

| Plot No. | Band     | Mode          | Test Position                | Antenna | Ch. | Freq. (MHz) | Average Power (dBm) | Tune-Up Limit (dBm) | Tune-up Scaling Factor | Power Drift (dB) | Measured 1g SAR (W/kg) | Reported 1g SAR (W/kg) |
|----------|----------|---------------|------------------------------|---------|-----|-------------|---------------------|---------------------|------------------------|------------------|------------------------|------------------------|
| 306      | WLAN5GHz | 802.11a 6Mbps | Bottom Face                  | Ant 2   | 40  | 5200        | 9.5                 | 9.5                 | 1.000                  | -0.15            | 0.361                  | 0.361                  |
| 246      | WLAN5GHz | 802.11a 6Mbps | Bottom Face - Slant of Ant 2 | Ant 2   | 40  | 5200        | 9.5                 | 9.5                 | 1.000                  | -0.05            | 1.210                  | 1.210                  |
| 255      | WLAN5GHz | 802.11a 6Mbps | Bottom Face - Slant of Ant 2 | Ant 2   | 44  | 5220        | 9.3                 | 9.5                 | 1.047                  | -0.08            | 0.870                  | 0.911                  |
| 298      | WLAN5GHz | 802.11a 6Mbps | Edge 3                       | Ant 2   | 40  | 5200        | 9.5                 | 9.5                 | 1.000                  | -0.19            | 1.030                  | 1.030                  |
| 288      | WLAN5GHz | 802.11a 6Mbps | Edge 3                       | Ant 2   | 44  | 5220        | 9.3                 | 9.5                 | 1.047                  | 0.1              | 0.761                  | 0.797                  |
| 289      | WLAN5GHz | 802.11a 6Mbps | Bottom Face                  | Ant 2   | 60  | 5300        | 9.5                 | 9.5                 | 1.000                  | 0.04             | 0.432                  | 0.432                  |
| 251      | WLAN5GHz | 802.11a 6Mbps | Bottom Face - Slant of Ant 2 | Ant 2   | 60  | 5300        | 9.5                 | 9.5                 | 1.000                  | -0.05            | 1.160                  | 1.160                  |
| 252      | WLAN5GHz | 802.11a 6Mbps | Bottom Face - Slant of Ant 2 | Ant 2   | 56  | 5280        | 9.5                 | 9.5                 | 1.000                  | 0.04             | 1.170                  | 1.170                  |
| 290      | WLAN5GHz | 802.11a 6Mbps | Edge 3                       | Ant 2   | 60  | 5300        | 9.5                 | 9.5                 | 1.000                  | -0.11            | 0.926                  | 0.926                  |
| 295      | WLAN5GHz | 802.11a 6Mbps | Edge 3                       | Ant 2   | 56  | 5280        | 9.5                 | 9.5                 | 1.000                  | 0.01             | 0.914                  | 0.914                  |
| 291      | WLAN5GHz | 802.11a 6Mbps | Bottom Face                  | Ant 2   | 104 | 5520        | 10.0                | 10.0                | 1.000                  | 0.01             | 0.374                  | 0.374                  |
| 257      | WLAN5GHz | 802.11a 6Mbps | Bottom Face - Slant of Ant 2 | Ant 2   | 104 | 5520        | 10.0                | 10.0                | 1.000                  | -0.05            | 1.110                  | 1.110                  |
| 258      | WLAN5GHz | 802.11a 6Mbps | Bottom Face - Slant of Ant 2 | Ant 2   | 116 | 5580        | 10.0                | 10.0                | 1.000                  | -0.02            | 1.180                  | 1.180                  |
| 259      | WLAN5GHz | 802.11a 6Mbps | Bottom Face - Slant of Ant 2 | Ant 2   | 136 | 5680        | 9.8                 | 10.0                | 1.047                  | -0.12            | 1.210                  | 1.267                  |
| 292      | WLAN5GHz | 802.11a 6Mbps | Edge 3                       | Ant 2   | 104 | 5520        | 10.0                | 10.0                | 1.000                  | -0.08            | 0.503                  | 0.503                  |
| 296      | WLAN5GHz | 802.11a 6Mbps | Edge 3                       | Ant 2   | 116 | 5580        | 10.0                | 10.0                | 1.000                  | -0.17            | 0.415                  | 0.415                  |
| 297      | WLAN5GHz | 802.11a 6Mbps | Edge 3                       | Ant 2   | 136 | 5680        | 9.8                 | 10.0                | 1.047                  | -0.16            | 0.437                  | 0.458                  |

## 12.2 Repeated SAR Measurement

| Plot No. | Band       | Mode          | Test Position                | Gap (cm) | Antenna | Ch. | Freq. (MHz) | Average Power (dBm) | Tune-Up Limit (dBm) | Tune-up Scaling Factor | Power Drift (dB) | Measured 1g SAR (W/kg) | Ratio | Reported 1g SAR (W/kg) |
|----------|------------|---------------|------------------------------|----------|---------|-----|-------------|---------------------|---------------------|------------------------|------------------|------------------------|-------|------------------------|
| 272      | WLAN2.4GHz | 802.11b 1Mbps | Bottom Face - Slant of Ant 2 | 0cm      | Ant 2   | 1   | 2412        | 14.9                | 15.0                | 1.023                  | -0.18            | 1.260                  | 1     | 1.289                  |
| 281      | WLAN2.4GHz | 802.11b 1Mbps | Bottom Face - Slant of Ant 2 | 0cm      | Ant 2   | 1   | 2412        | 14.9                | 15.0                | 1.023                  | -0.16            | 1.250                  | 1.01  | 1.279                  |
| 265      | WLAN5GHz   | 802.11a 6Mbps | Bottom Face - Slant of Ant 2 | 0cm      | Ant 2   | 161 | 5805        | 10.0                | 10.0                | 1.000                  | 0.11             | 1.220                  | 1     | 1.220                  |
| 299      | WLAN5GHz   | 802.11a 6Mbps | Bottom Face - Slant of Ant 2 | 0cm      | Ant 2   | 161 | 5805        | 10.0                | 10.0                | 1.000                  | -0.1             | 1.150                  | 1.06  | 1.150                  |

### Note:

1. Per KDB 865664 D01v01, for each frequency band, repeated SAR measurement is required only when the measured SAR is  $\geq 0.8W/kg$
2. Per KDB 865664 D01v01, if the ratio among the repeated measurement is  $\leq 1.2$  and the measured SAR  $< 1.45W/kg$ , only one repeated measurement is required.
3. The ratio is the difference in percentage between original and repeated *measured* SAR.
4. All measurement SAR result is scaled-up to account for tune-up tolerance and is compliant.

## 12.3 Highest SAR Plot

Test Laboratory: Sporton International Inc. SAR/HAC Testing Lab

Date: 2013/7/24

#272\_WLAN2.4GHz\_802.11b 1Mbps\_Bottom Face - Slant of Ant 2\_0cm\_Ch1;Ant 2

DUT: 332726-04

Communication System: 802.11b ; Frequency: 2412 MHz;Duty Cycle: 1:1

Medium: MSL\_2450\_130724 Medium parameters used:  $f = 2412$  MHz;  $\sigma = 1.876$  S/m;  $\epsilon_r = 53.364$ ;  $\rho = 1000$  kg/m<sup>3</sup>

Ambient Temperature : 23.2 °C; Liquid Temperature : 22.2 °C

DASY5 Configuration:

- Probe: EX3DV4 - SN3697; ConvF(6.57, 6.57, 6.57); Calibrated: 2012/9/28;
- Sensor-Surface: 2mm (Mechanical Surface Detection)
- Electronics: DAE4 Sn1279; Calibrated: 2013/1/28
- Phantom: ELI v4.0; Type: QDOVA001BB; Serial: 1173
- Measurement SW: DASY52, Version 52.8 (6); SEMCAD X Version 14.6.9 (7117)

**Configuration/Ch1/Area Scan (51x81x1):** Interpolated grid: dx=1.200 mm, dy=1.200 mm  
Maximum value of SAR (interpolated) = 2.17 W/kg

**Configuration/Ch1/Zoom Scan (7x7x7)/Cube 0:** Measurement grid: dx=5mm, dy=5mm, dz=5mm

Reference Value = 32.132 V/m; Power Drift = -0.18 dB

Peak SAR (extrapolated) = 2.97 W/kg

**SAR(1 g) = 1.26 W/kg; SAR(10 g) = 0.534 W/kg**

Maximum value of SAR (measured) = 1.95 W/kg

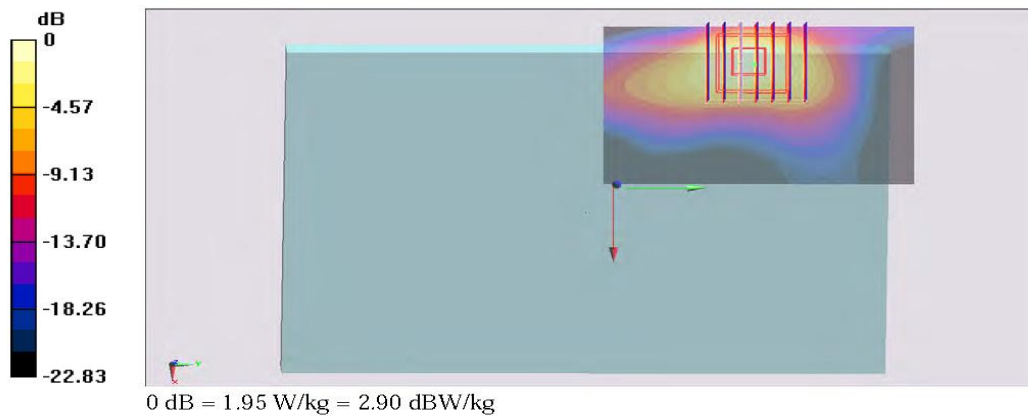

**#259\_WLAN5GHz\_802.11a 6Mbps\_Bottom Face - Slant of Ant 2\_0cm\_Ch136;Ant 2**

**DUT: 332726-04**

Communication System: 802.11a; Frequency: 5680 MHz; Duty Cycle: 1:1.019  
 Medium: MSL\_5G\_130723 Medium parameters used :  $f = 5680$  MHz;  $\sigma = 5.759$  S/m;  $\epsilon_r = 46.658$ ;  $\rho = 1000$  kg/m<sup>3</sup>  
 Ambient Temperature : 23.6 °C; Liquid Temperature : 22.6 °C

DASY5 Configuration:

- Probe: EX3DV4 - SN3697; ConvF(3.75, 3.75, 3.75); Calibrated: 2012/9/28;
- Sensor-Surface: 1.4mm (Mechanical Surface Detection)
- Electronics: DAE4 Sn1 279; Calibrated: 2013/1/28
- Phantom: ELI v4.0; Type: QDOVA001BB; Serial: 1173
- Measurement SW: DASY52, Version 52.8 (6); SEMCAD X Version 14.6.9 (7117)

**Configuration/Ch136/Area Scan (61x91x1):** Interpolated grid: dx=1.000 mm, dy=1.000 mm  
 Maximum value of SAR (interpolated) = 2.99 W/kg

**Configuration/Ch136/Zoom Scan (7x7x7)/Cube 0:** Measurement grid: dx=4mm, dy=4mm, dz=1.4mm

Reference Value = 24.586 V/m; Power Drift = -0.12 dB

Peak SAR (extrapolated) = 6.60 W/kg

**SAR(1 g) = 1.21 W/kg; SAR(10 g) = 0.322 W/kg**

Maximum value of SAR (measured) = 3.41 W/kg

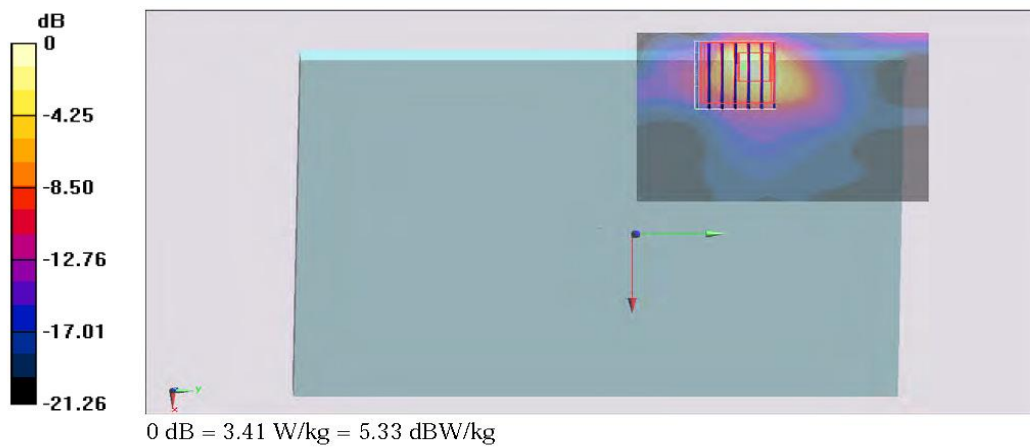

### **13. Simultaneous Transmission Analysis**

| <b>NO.</b> | <b>Simultaneous Transmission Configurations</b> | <b>Supported</b> |
|------------|---|------------------|
| 1.         | WLAN + Bluetooth                                | No               |
| 2.         | WLAN Antenna 1 + WLAN Antenna 2                 | Yes              |

**Note:**

1. WLAN and Bluetooth share the same antenna, and cannot transmit simultaneously.
2. EUT will choose either WLAN 2.4GHz or WLAN 5GHz according to the network signal condition; therefore, they will not transmit simultaneously.
3. The Scaled SAR summation is calculated based on the same configuration and test position.
4. Per KDB 447498 D01v05r01, summation SAR is compliant if,
  - i) Scalar SAR summation < 1.6W/kg.
  - ii)  $SPLSR = (SAR_1 + SAR_2)^{1.5} / (min. \text{ separation distance, mm})$ , and the peak separation distance is determined from the square root of  $[(x_1-x_2)^2 + (y_1-y_2)^2 + (z_1-z_2)^2]$ , where  $(x_1, y_1, z_1)$  and  $(x_2, y_2, z_2)$  are the coordinates of the extrapolated peak SAR locations in the zoom scan  
If  $SPLSR \leq 0.04$ , Summation SAR measurement is not necessary
  - iii) Summation SAR measurement, and the reported multi-band SAR < 1.6W/kg

### 13.1 Body Exposure Conditions

| Position                     | WLAN Antenna 1  |         |            | WLAN Antenna 2  |         |            | Summed SAR (W/kg) | SPLSR | Case No |
|------------------------------|-----------------|---------|------------|-----------------|---------|------------|-------------------|-------|---------|
|                              | Band            | Plot No | SAR (W/kg) | Band            | Plot No | SAR (W/kg) |                   |       |         |
| Bottom Face                  | WLAN2.4GHz Band | 282     | 1.180      | WLAN2.4GHz Band | 277     | 1.220      | 2.40              | 0.03  | Case 1  |
|                              | WLAN5.2GHz Band | 219     | 0.407      | WLAN5.2GHz Band | 306     | 0.361      | 0.77              |       |         |
|                              | WLAN5.3GHz Band | 220     | 0.399      | WLAN5.3GHz Band | 289     | 0.432      | 0.83              |       |         |
|                              | WLAN5.5GHz Band | 221     | 0.594      | WLAN5.5GHz Band | 291     | 0.374      | 0.97              |       |         |
|                              | WLAN5.8GHz Band | 222     | 0.379      | WLAN5.8GHz Band | 293     | 0.582      | 0.96              |       |         |
| Bottom Face - Slant of Ant 1 | WLAN2.4GHz Band | 302     | 0.943      |                 |         |            | 0.94              |       |         |
|                              | WLAN5.2GHz Band | 215     | 0.613      |                 |         |            | 0.61              |       |         |
|                              | WLAN5.3GHz Band | 216     | 0.373      |                 |         |            | 0.37              |       |         |
|                              | WLAN5.5GHz Band | 217     | 0.637      |                 |         |            | 0.64              |       |         |
|                              | WLAN5.8GHz Band | 218     | 0.341      |                 |         |            | 0.34              |       |         |
| Edge 1                       | WLAN2.4GHz Band | 303     | 0.367      |                 |         |            | 0.37              |       |         |
|                              | WLAN5.2GHz Band | 233     | 0.977      |                 |         |            | 0.98              |       |         |
|                              | WLAN5.3GHz Band | 225     | 0.688      |                 |         |            | 0.69              |       |         |
|                              | WLAN5.5GHz Band | 226     | 1.000      |                 |         |            | 1.00              |       |         |
|                              | WLAN5.8GHz Band | 310     | 0.700      |                 |         |            | 0.70              |       |         |
| Bottom Face - Slant of Ant 2 |                 |         |            | WLAN2.4GHz Band | 272     | 1.260      | 1.26              |       |         |
|                              |                 |         |            | WLAN5.2GHz Band | 246     | 1.210      | 1.21              |       |         |
|                              |                 |         |            | WLAN5.3GHz Band | 252     | 1.170      | 1.17              |       |         |
|                              |                 |         |            | WLAN5.5GHz Band | 259     | 1.210      | 1.21              |       |         |
|                              |                 |         |            | WLAN5.8GHz Band | 265     | 1.220      | 1.22              |       |         |
| Edge 3                       |                 |         |            | WLAN2.4GHz Band | 280     | 0.713      | 0.71              |       |         |
|                              |                 |         |            | WLAN5.2GHz Band | 298     | 1.030      | 1.03              |       |         |
|                              |                 |         |            | WLAN5.3GHz Band | 290     | 0.926      | 0.93              |       |         |
|                              |                 |         |            | WLAN5.5GHz Band | 292     | 0.503      | 0.50              |       |         |
|                              |                 |         |            | WLAN5.8GHz Band | 294     | 0.519      | 0.52              |       |         |

### 13.2 SPLSR Evaluation and Analysis

| Case 1  | Band        | Position    | SAR (W/kg) | Gap  | SAR peak location (m) |         |        | 3D distance (mm) | Pair SAR sum (W/kg) | SPLSR | Simultaneous SAR |
|---------|-------------|-------------|------------|------|-----------------------|---------|--------|------------------|---------------------|-------|------------------|
| Plot No |             |             |            | (cm) | X                     | Y       | Z      |                  |                     |       |                  |
| 282     | WLAN 2.4GHz | Bottom Face | 1.180      | 0    | 0.0528                | -0.0406 | -0.18  | 143.1            | 2.40                | 0.03  | Not required     |
| 277     | WLAN 2.4GHz |             | 1.220      | 0    | -0.058                | 0.05    | -0.181 |                  |                     |       |                  |

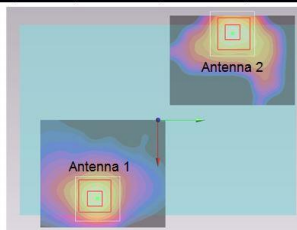

Test Engineer : Jack Wu, Nick Yu, Vic Yang, San Lin, and Aaron Chen

## 14. Uncertainty Assessment

The component of uncertainty may generally be categorized according to the methods used to evaluate them. The evaluation of uncertainty by the statistical analysis of a series of observations is termed a Type A evaluation of uncertainty. The evaluation of uncertainty by means other than the statistical analysis of a series of observations is termed a Type B evaluation of uncertainty. Each component of uncertainty, however evaluated, is represented by an estimated standard deviation, termed standard uncertainty, which is determined by the positive square root of the estimated variance.

A Type A evaluation of standard uncertainty may be based on any valid statistical method for treating data. This includes calculating the standard deviation of the mean of a series of independent observations; using the method of least squares to fit a curve to the data in order to estimate the parameter of the curve and their standard deviations; or carrying out an analysis of variance in order to identify and quantify random effects in certain kinds of measurement.

A type B evaluation of standard uncertainty is typically based on scientific judgment using all of the relevant information available. These may include previous measurement data, experience, and knowledge of the behavior and properties of relevant materials and instruments, manufacture's specification, data provided in calibration reports and uncertainties assigned to reference data taken from handbooks. Broadly speaking, the uncertainty is either obtained from an outdoor source or obtained from an assumed distribution, such as the normal distribution, rectangular or triangular distributions indicated in Table 14.1

| Uncertainty Distributions          | Normal             | Rectangular | Triangular | U-Shape |
|------------------------------------|--------------------|-------------|------------|---------|
| Multi-plying Factor <sup>(a)</sup> | 1/k <sup>(b)</sup> | 1/√3        | 1/√6       | 1/√2    |

(a) standard uncertainty is determined as the product of the multiplying factor and the estimated range of variations in the measured quantity

(b)  $\kappa$  is the coverage factor

**Table 14.1 Standard Uncertainty for Assumed Distribution**

The combined standard uncertainty of the measurement result represents the estimated standard deviation of the result. It is obtained by combining the individual standard uncertainties of both Type A and Type B evaluation using the usual "root-sum-squares" (RSS) methods of combining standard deviations by taking the positive square root of the estimated variances.

Expanded uncertainty is a measure of uncertainty that defines an interval about the measurement result within which the measured value is confidently believed to lie. It is obtained by multiplying the combined standard uncertainty by a coverage factor. Typically, the coverage factor ranges from 2 to 3. Using a coverage factor allows the true value of a measured quantity to be specified with a defined probability within the specified uncertainty range. For purpose of this document, a coverage factor two is used, which corresponds to confidence interval of about 95 %. The DASY uncertainty Budget is shown in the following tables.



| Error Description                    | Uncertainty Value ( $\pm\%$ ) | Probability Distribution | Divisor    | Ci (1g) | Ci (10g) | Standard Uncertainty (1g) | Standard Uncertainty (10g) |
|--------------------------------------|-------------------------------|--------------------------|------------|---------|----------|---------------------------|----------------------------|
| <b>Measurement System</b>            |                               |                          |            |         |          |                           |                            |
| Probe Calibration                    | 6.0                           | Normal                   | 1          | 1       | 1        | $\pm 6.0\%$               | $\pm 6.0\%$                |
| Axial Isotropy                       | 4.7                           | Rectangular              | $\sqrt{3}$ | 0.7     | 0.7      | $\pm 1.9\%$               | $\pm 1.9\%$                |
| Hemispherical Isotropy               | 9.6                           | Rectangular              | $\sqrt{3}$ | 0.7     | 0.7      | $\pm 3.9\%$               | $\pm 3.9\%$                |
| Boundary Effects                     | 1.0                           | Rectangular              | $\sqrt{3}$ | 1       | 1        | $\pm 0.6\%$               | $\pm 0.6\%$                |
| Linearity                            | 4.7                           | Rectangular              | $\sqrt{3}$ | 1       | 1        | $\pm 2.7\%$               | $\pm 2.7\%$                |
| System Detection Limits              | 1.0                           | Rectangular              | $\sqrt{3}$ | 1       | 1        | $\pm 0.6\%$               | $\pm 0.6\%$                |
| Readout Electronics                  | 0.3                           | Normal                   | 1          | 1       | 1        | $\pm 0.3\%$               | $\pm 0.3\%$                |
| Response Time                        | 0.8                           | Rectangular              | $\sqrt{3}$ | 1       | 1        | $\pm 0.5\%$               | $\pm 0.5\%$                |
| Integration Time                     | 2.6                           | Rectangular              | $\sqrt{3}$ | 1       | 1        | $\pm 1.5\%$               | $\pm 1.5\%$                |
| RF Ambient Noise                     | 3.0                           | Rectangular              | $\sqrt{3}$ | 1       | 1        | $\pm 1.7\%$               | $\pm 1.7\%$                |
| RF Ambient Reflections               | 3.0                           | Rectangular              | $\sqrt{3}$ | 1       | 1        | $\pm 1.7\%$               | $\pm 1.7\%$                |
| Probe Positioner                     | 0.4                           | Rectangular              | $\sqrt{3}$ | 1       | 1        | $\pm 0.2\%$               | $\pm 0.2\%$                |
| Probe Positioning                    | 2.9                           | Rectangular              | $\sqrt{3}$ | 1       | 1        | $\pm 1.7\%$               | $\pm 1.7\%$                |
| Max. SAR Eval.                       | 1.0                           | Rectangular              | $\sqrt{3}$ | 1       | 1        | $\pm 0.6\%$               | $\pm 0.6\%$                |
| <b>Test Sample Related</b>           |                               |                          |            |         |          |                           |                            |
| Device Positioning                   | 2.9                           | Normal                   | 1          | 1       | 1        | $\pm 2.9\%$               | $\pm 2.9\%$                |
| Device Holder                        | 3.6                           | Normal                   | 1          | 1       | 1        | $\pm 3.6\%$               | $\pm 3.6\%$                |
| Power Drift                          | 5.0                           | Rectangular              | $\sqrt{3}$ | 1       | 1        | $\pm 2.9\%$               | $\pm 2.9\%$                |
| <b>Phantom and Setup</b>             |                               |                          |            |         |          |                           |                            |
| Phantom Uncertainty                  | 4.0                           | Rectangular              | $\sqrt{3}$ | 1       | 1        | $\pm 2.3\%$               | $\pm 2.3\%$                |
| Liquid Conductivity (Target)         | 5.0                           | Rectangular              | $\sqrt{3}$ | 0.64    | 0.43     | $\pm 1.8\%$               | $\pm 1.2\%$                |
| Liquid Conductivity (Meas.)          | 2.5                           | Normal                   | 1          | 0.64    | 0.43     | $\pm 1.6\%$               | $\pm 1.1\%$                |
| Liquid Permittivity (Target)         | 5.0                           | Rectangular              | $\sqrt{3}$ | 0.6     | 0.49     | $\pm 1.7\%$               | $\pm 1.4\%$                |
| Liquid Permittivity (Meas.)          | 2.5                           | Normal                   | 1          | 0.6     | 0.49     | $\pm 1.5\%$               | $\pm 1.2\%$                |
| <b>Combined Standard Uncertainty</b> |                               |                          |            |         |          | $\pm 11.0\%$              | $\pm 10.8\%$               |
| <b>Coverage Factor for 95 %</b>      |                               |                          |            |         |          | K=2                       |                            |
| <b>Expanded Uncertainty</b>          |                               |                          |            |         |          | $\pm 22.0\%$              | $\pm 21.5\%$               |

**Table 14.2 Uncertainty Budget for frequency range 300 MHz to 3 GHz according to IEEE1528-2003.**

| Error Description                    | Uncertainty Value ( $\pm\%$ ) | Probability Distribution | Divisor    | Ci (1g) | Ci (10g) | Standard Uncertainty (1g) | Standard Uncertainty (10g) |
|--------------------------------------|-------------------------------|--------------------------|------------|---------|----------|---------------------------|----------------------------|
| <b>Measurement System</b>            |                               |                          |            |         |          |                           |                            |
| Probe Calibration                    | 6.55                          | Normal                   | 1          | 1       | 1        | $\pm 6.55\%$              | $\pm 6.55\%$               |
| Axial Isotropy                       | 4.7                           | Rectangular              | $\sqrt{3}$ | 0.7     | 0.7      | $\pm 1.9\%$               | $\pm 1.9\%$                |
| Hemispherical Isotropy               | 9.6                           | Rectangular              | $\sqrt{3}$ | 0.7     | 0.7      | $\pm 3.9\%$               | $\pm 3.9\%$                |
| Boundary Effects                     | 2.0                           | Rectangular              | $\sqrt{3}$ | 1       | 1        | $\pm 1.2\%$               | $\pm 1.2\%$                |
| Linearity                            | 4.7                           | Rectangular              | $\sqrt{3}$ | 1       | 1        | $\pm 2.7\%$               | $\pm 2.7\%$                |
| System Detection Limits              | 1.0                           | Rectangular              | $\sqrt{3}$ | 1       | 1        | $\pm 0.6\%$               | $\pm 0.6\%$                |
| Readout Electronics                  | 0.3                           | Normal                   | 1          | 1       | 1        | $\pm 0.3\%$               | $\pm 0.3\%$                |
| Response Time                        | 0.8                           | Rectangular              | $\sqrt{3}$ | 1       | 1        | $\pm 0.5\%$               | $\pm 0.5\%$                |
| Integration Time                     | 2.6                           | Rectangular              | $\sqrt{3}$ | 1       | 1        | $\pm 1.5\%$               | $\pm 1.5\%$                |
| RF Ambient Noise                     | 3.0                           | Rectangular              | $\sqrt{3}$ | 1       | 1        | $\pm 1.7\%$               | $\pm 1.7\%$                |
| RF Ambient Reflections               | 3.0                           | Rectangular              | $\sqrt{3}$ | 1       | 1        | $\pm 1.7\%$               | $\pm 1.7\%$                |
| Probe Positioner                     | 0.8                           | Rectangular              | $\sqrt{3}$ | 1       | 1        | $\pm 0.5\%$               | $\pm 0.5\%$                |
| Probe Positioning                    | 9.9                           | Rectangular              | $\sqrt{3}$ | 1       | 1        | $\pm 5.7\%$               | $\pm 5.7\%$                |
| Max. SAR Eval.                       | 4.0                           | Rectangular              | $\sqrt{3}$ | 1       | 1        | $\pm 2.3\%$               | $\pm 2.3\%$                |
| <b>Test Sample Related</b>           |                               |                          |            |         |          |                           |                            |
| Device Positioning                   | 2.9                           | Normal                   | 1          | 1       | 1        | $\pm 2.9\%$               | $\pm 2.9\%$                |
| Device Holder                        | 3.6                           | Normal                   | 1          | 1       | 1        | $\pm 3.6\%$               | $\pm 3.6\%$                |
| Power Drift                          | 5.0                           | Rectangular              | $\sqrt{3}$ | 1       | 1        | $\pm 2.9\%$               | $\pm 2.9\%$                |
| <b>Phantom and Setup</b>             |                               |                          |            |         |          |                           |                            |
| Phantom Uncertainty                  | 4.0                           | Rectangular              | $\sqrt{3}$ | 1       | 1        | $\pm 2.3\%$               | $\pm 2.3\%$                |
| Liquid Conductivity (Target)         | 5.0                           | Rectangular              | $\sqrt{3}$ | 0.64    | 0.43     | $\pm 1.8\%$               | $\pm 1.2\%$                |
| Liquid Conductivity (Meas.)          | 2.5                           | Normal                   | 1          | 0.64    | 0.43     | $\pm 1.6\%$               | $\pm 1.1\%$                |
| Liquid Permittivity (Target)         | 5.0                           | Rectangular              | $\sqrt{3}$ | 0.6     | 0.49     | $\pm 1.7\%$               | $\pm 1.4\%$                |
| Liquid Permittivity (Meas.)          | 2.5                           | Normal                   | 1          | 0.6     | 0.49     | $\pm 1.5\%$               | $\pm 1.2\%$                |
| <b>Combined Standard Uncertainty</b> |                               |                          |            |         |          | $\pm 12.8\%$              | $\pm 12.6\%$               |
| <b>Coverage Factor for 95 %</b>      |                               |                          |            |         |          | K=2                       |                            |
| <b>Expanded Uncertainty</b>          |                               |                          |            |         |          | $\pm 25.6\%$              | $\pm 25.2\%$               |

Table 14.3 Uncertainty Budget for frequency range 3 GHz to 6 GHz according to Dasy5 user manual.

## **15. References**

- [1] FCC 47 CFR Part 2 “Frequency Allocations and Radio Treaty Matters; General Rules and Regulations”.
- [2] ANSI/IEEE Std. C95.1-1992, “IEEE Standard for Safety Levels with Respect to Human Exposure to Radio Frequency Electromagnetic Fields, 3 kHz to 300 GHz”, September 1992.
- [3] IEEE Std. 1528-2003, “Recommended Practice for Determining the Peak Spatial-Average Specific Absorption Rate (SAR) in the Human Head from Wireless Communications Devices: Measurement Techniques”, December 2003
- [4] SPEAG DASY System Handbook
- [5] FCC KDB 248227 D01 v01r02, “SAR Measurement Procedures for 802.11 a/b/g Transmitters”, May 2007
- [6] FCC KDB 447498 D01 v05r01, “Mobile and Portable Device RF Exposure Procedures and Equipment Authorization Policies”, May 2013
- [7] FCC KDB 616217 D04 v01r01, “SAR Evaluation Considerations for Laptop, Notebook, Netbook and Tablet Computers”, May 2013