

广州市花都区大唐通信天线厂

规格书

SPECIFICATION FOR APPROVAL

客户名称

Customer: GUANGZHOU Walkera Technology Co., Ltd

产品名称

Product Name: FPC ANTENNA

规格描述

Description: DTXLB2.4-5.8G-IPEX-35mm

发出日期:

Approval Date: 2022-12-01

地址: 广州市花都区花城街平石西路 113 号厂房 1

电话: +86 020-36981239

目录

1. 电性能参数 ELECTRICAL SPECIFICATIONS	3
2. 机械性能 MECHANICAL SPECIFICATIONS	3
3. 尺寸图 DIMENSION DRAWING	4
4. 驻波图 VSWR	4
5. 测试数据 TEST DATA	5

1. 电性能参数 ELECTRICAL SPECIFICATIONS

频率范围 Frequency Range	2.4-5.8Ghz
输入阻抗 Impedance	50 Ω
驻波比 VSWR	<2.0
增益 Gain	3dBi
极化 Polarization	垂直
方向性 Radiation	全向
最大功率 Max power	20W

2. 机械性能 MECHANICAL SPECIFICATIONS

厚度 Thickness
宽度 Width	5.5 ± 1mm
长度 Length	31 ± 2mm
接口 Connector	IPEX
电缆长度 Length of Cable	1.13 黑线 35mm
雷电保护 Lighting protection	直流接地

3. 尺寸图 DIMENSION DRAWING

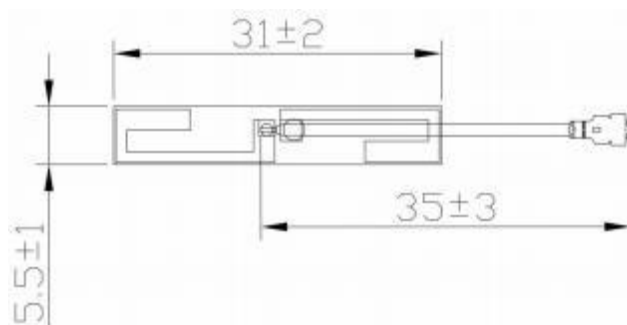

4. 驻波图 VSWR

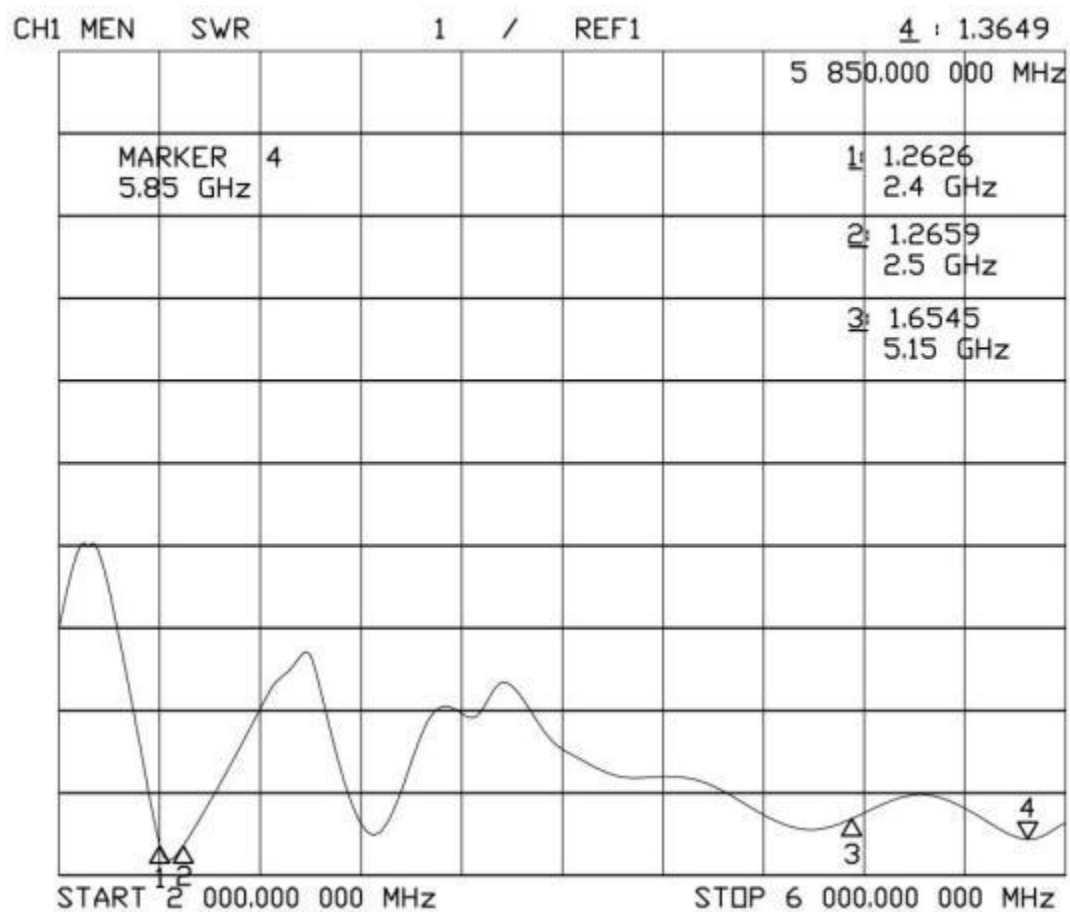

5. 测试数据 TEST DATA

Freq (MHz)	Gain (dBi)
5000	2.8
5050	2.31
5100	2.13
5150	2.14
5200	2.63
5250	2.07
5300	2.28
5350	2.28
5400	2.21
5450	2.52
5500	2.4
5550	2.98
5600	2.42
5650	2.77
5700	2.09
5750	2.73
5800	2.61
5850	2.95
5900	2.23
5950	3.0
6000	2.14

5.15GHz

5150.000MHz H

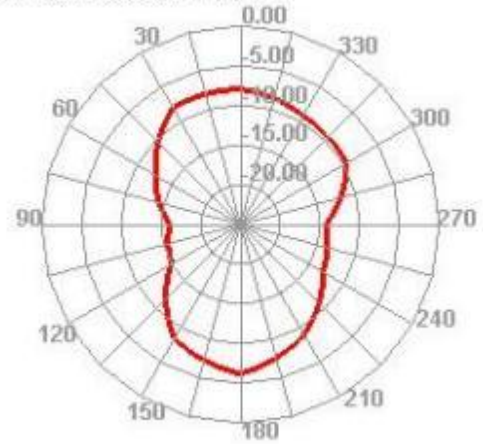

5150.000MHz E1

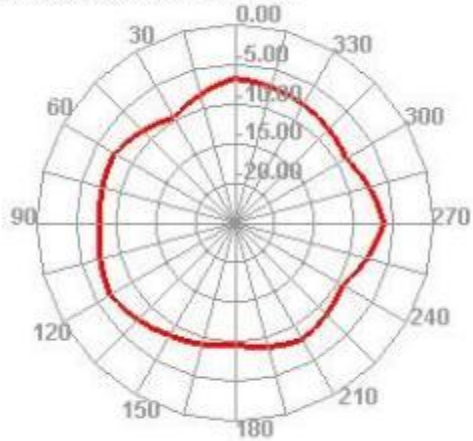

5150.000MHz E2

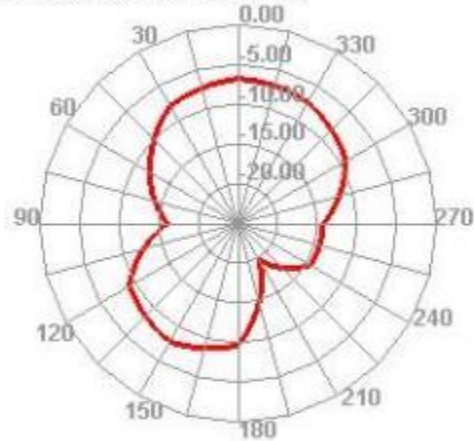

5.5GHz

5550.000MHz H

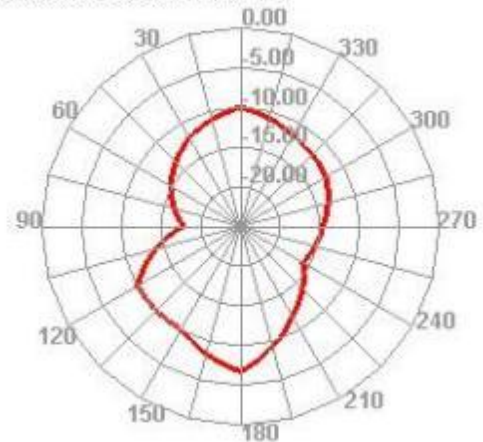

5550.000MHz E1

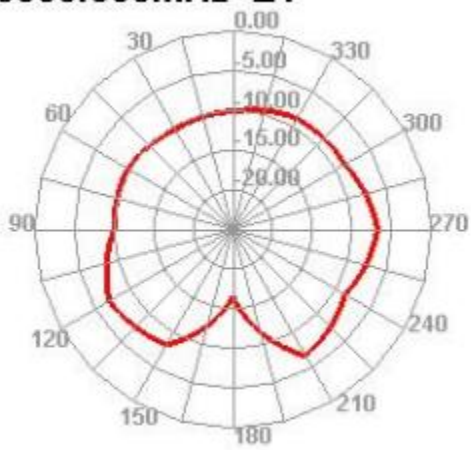

5550.000MHz E2

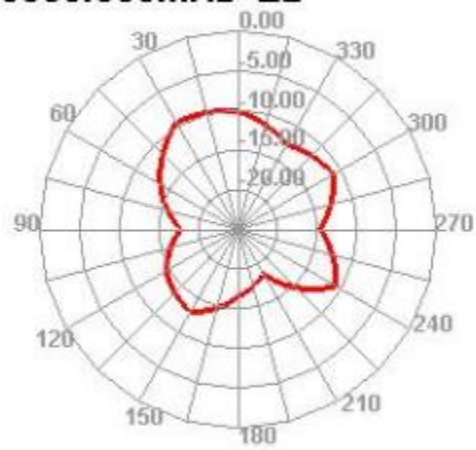

5.85GHz

5850.000MHz H

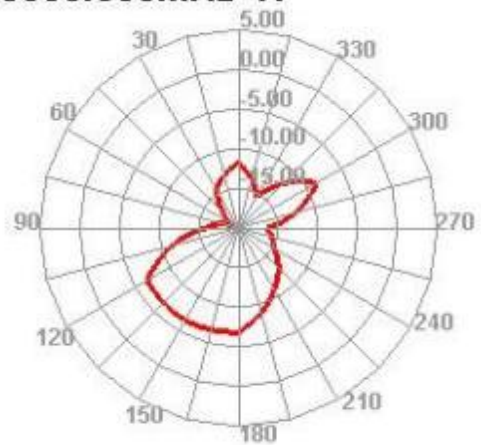

5850.000MHz E1

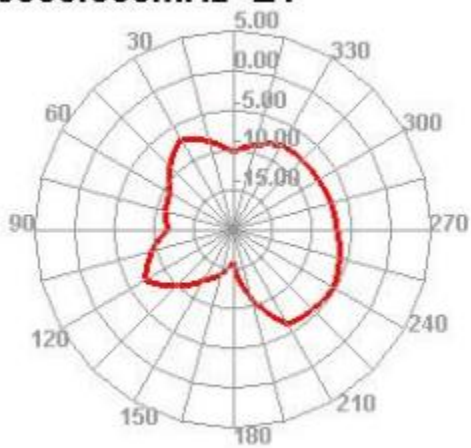

5850.000MHz E2

