



Welcome to use the **WK-2402** transmitter

# **WK-2402**

## **User Manual**

**Note:** Please read throughly the manual before using and keep it in a safe place for the future reference.



# WK-2402

## Content

### Part one: General Information

<b>1.0 Foreword</b>	1
1.1 Important Statements	1
1.2 Safety Guidelines Needing Attention	1
1.3 Attention before flight	2
<b>2.0 Features</b>	3
2.1 Transmitter WK-2402	3
<b>3.0 Specifications</b>	3
3.1 Transmitter Specification	3
<b>4.0 Face</b>	4
4.1 Back	5
4.2 Wiring Diagram	6
4.3 WK-2402 Input Key Function	7
<b>5.0 Control Stick Length Adjustment</b>	7

5.1 Control Stick Tension Adjustment	7
5.2 Neck Strap Usage	7
5.3 Throttle stick switch (mechanical method)	8
5.3.1 Right-hand throttle switched to left-hand throttle	8
5.3.2 Left-hand throttle switched to right hand	9
5.4 Stick Tension Adjustment	10
<b>6.0 Installation Requirements</b>	10

### Party two: Function Setup

<b>1.0 Main Menu</b>	12
<b>2.0 Channel reverse setup</b>	12
<b>3.0 Buzzer setup</b>	13

# WK-2402

## Part one: General Information

### 1.0 Foreword

Walkera's WK-2402 adopts 2.4G spectrum technology with the functions of automatic code pairing, ID assignment and high ability of anti-jamming. It also has the function of wireless copy so that you will get out of the trouble of wire connection. 4 hotkeys can be set to get fast access to the desired screen. It has modes for both helicopters and airplanes to meet your requirements for different models.

### 1.1 Important Statements

- (1) The transmitter is suitable for experienced radio controlled helicopter modelers beyond 14 years old.
- (2) Flying the model aircraft in approved ground is a must.
- (3) We are not responsible for any safety caused by operation, usage or control as soon as the transmitter is sold out.
- (4) We consign our distributors to offer technical support and service after sale. Please contact the local distributors for problem solutions caused by usage, operation, maintenance, etc.

### 1.2 Safety Needing Attention

- (1) Far away from obstacle and people  
RC helicopter in flight is uncertain of flight speed and status, which potential risk exists in. when flying, please keep your RC helicopter far away from people, high buildings, high-tension line, etc, and avoid operating in rain, storms, thunder and lightning.
- (2) Away from humidity environment  
RC helicopter should be kept away from humidity and vapor because it is composed of complicated precise electronic elements and mechanic parts.

## WK-2402

(3) Proper operation

Please use Walkera original spare parts to upgrade, modify or maintain your equipment in order to assure its safety. Please operate your equipment within the range of functions permitted. It is forbidden to use out of the safety laws or regulations.

(4) Safety operation

Please fly your equipment according to your body status and flight skills. Fatigue, listlessness and miss-operation will increase the possibilities of accidental hazard.

(5) Away from heat source

The inside of the transmitter is composed of many precise electronic components and mechanical parts. Keep it far away from heat sources and sunshine to avoid distortion, or even damage caused by high temperature.

(6) Correct Charging Method

It is prohibited to charge the battery by the CHG jack when using a non-rechargeable batterypack.

### 1.3 Attention before flight

(1) Ensure the battery packs of both transmitter and receiver are fully charged (saturated).

(2) Ensure both the throttle stick and the throttle trim of your transmitter stay at the lowest positions before operation.

(3) Please strictly obey the order of turn-on and turn-off before operation. When starting your flight, turn on your transmitter first, then connect the battery to the heli. When turning off the heli, disconnect the battery first, then turn off the transmitter. An upset in the order of connection may cause your helicopter to lose control. Please cultivate a correct habit of turn-on and turn-off.

(4) Ensure the directions and actions of the servos are correct when executing commands of the transmitter. Using a broken servo will result in unforeseen dangers.

# WK-2402

## 2. 0 Features

### 2.1 Transmitter WK-2402

1. The WK-2402 adopts 2.4G frequency-hopping spread spectrum technology and features automatic code pairing and ID assignment.
2. Graphic display menu is simple to understand and to set.
3. The appearance design accords with ergonomics and features easy holding. The LCD screen with backlight and graphic interface looks more personalized.
4. Both the length and tension of the stick can be adjustable. It is convenient to freely switch among the 4 stick modes.

## 3. 0 Specifications

### 3.1 Transmitter Specification:

Encoder-----	4-channel micro computer system
Frequency -----	2.4G spread spectrum
Output Power -----	< 10Mw
Current Drain -----	< 120mA
Power Source -----	1.2V × 8NiCad(9.6V600mAh) or 1.5V × 8 AA dry batteries

# WK-2402

## 4.0 Face



# WK-2402

## 4.1 Back

Charging Jack: Input Voltage: 12V; Current: 50-100mA

**It's only fit for the rechargeable batteries. The charging function is prohibited when using the non-rechargeable batteries.**

Analog signals output jack/ training jack (DSC): for simulator flight practice via computer (You need a software and its dongle which are available in hobby stores), and for training.



# WK-2402

## 4.2 Wiring Diagram:

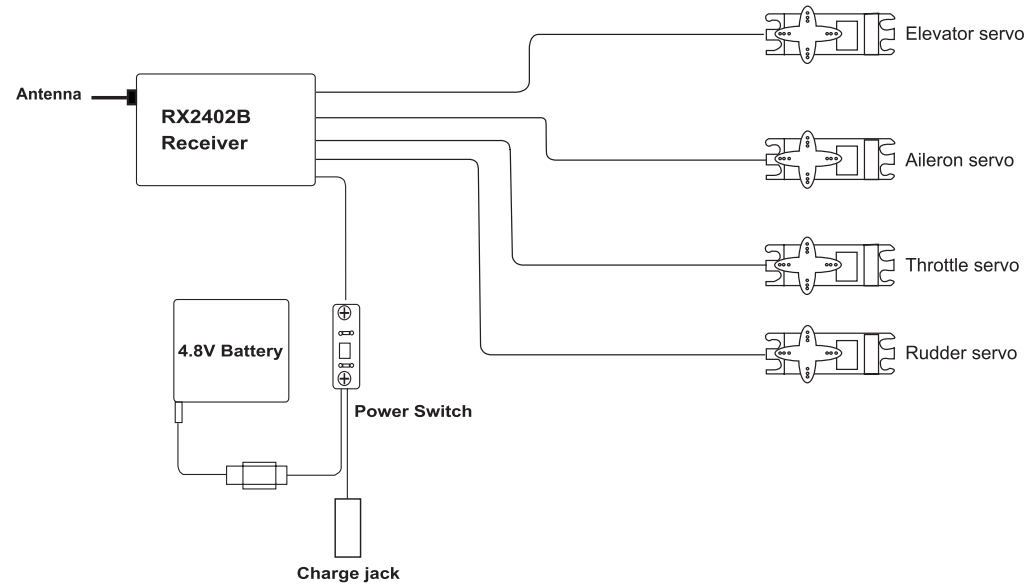



# WK-2402

## 4.3 WK-2402 Input Key Function

- EXT:** Reset key, press EXT to exit the setting mode.
- ENT:** Enter key, press ENT to enter the setting and confirmation status.
- UP:** Selection key, moves cursor up to the previous function item.
- DN:** Selection key, moves cursor down to the next function item.
- +R:** Change the setting.
- L-:** Change the setting.

## 5.0 Control Stick Length Adjustment

Prolong the stick length: CCW rotate the stick head until the length you hope, and then CCW tighten the stick sleeve;  
Shorten the stick length: CW rotate the stick sleeve until the length you hope, and then CW tighten the stick head.

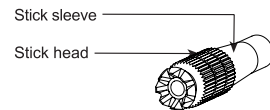

## 5.1 Control Stick Tension Adjustment

Remove the 6 screws in the back cover of WK-2402, and remove the transmitter back cover (Be careful not to break the wires). Then use a Phillips screwdriver to adjust each screw on the throttle arresting spring for the desired tension (Note: CW rotate to tighten the stick and CCW rotate to loosen).

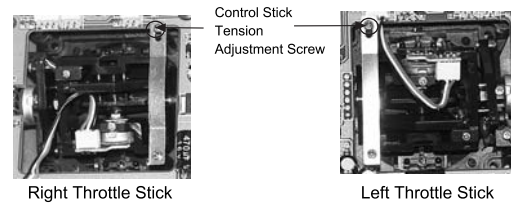

## 5.2 Neck Strap Usage

The neck strap can be hooked on the face of the WK-2402 transmitter. The Hook located at the center helps to get optimal balance of the transmitter.



# WK-2402

## 5.3 Four types of stick switch between left-hand throttle and right-hand throttle (mechanical method)

### 5.3.1 Right-hand throttle switched to left-hand throttle

#### A. The stick position change

Remove the battery pack and the 6 fixing screws in the back of transmitter, and then remove the transmitter back case (Be careful not to break the wires inside). Use a Phillips screwdriver to loosen the linkage screws, screw A, screw B and the throttle arresting spring in the right throttle position. Then mount them to the corresponding positions in the left throttle position. Adjust screw A according to the personal hand feeling (adjust the tension of the throttle stick). Then install the transmitter back case.

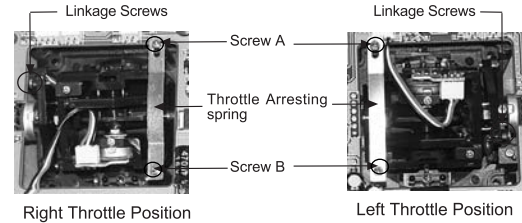

#### B. The data switch

Press ENT to enter the setting status, and both ELEV and the current reverse status NOR or REV are flashing. Press UP or DN to flash STICK MOD. STICK MOD and its current stick (one of the numbers from 1 through 4) are together flashing. If want to change the stick mode, press R or L to let the number 1 or 3 behind STICK MOD flashing. Press ENT to confirm and then press EXT to exit.

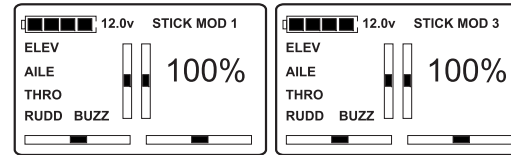

The right-hand throttle includes two modes: MODE 1 and MODE 3; The left-hand includes another two modes: MODE 2 and MODE 4. Refer to the following sketch map:

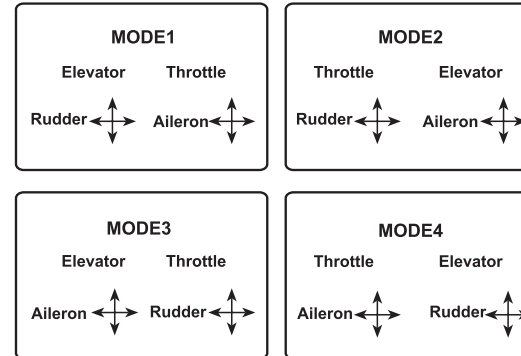

The switch from right hand throttle to left is completed and your WK-2402 is ready for normal flying.

# WK-2402

## 5.3.2 Left-hand throttle switched to right hand

### A. The stick position change

Remove the battery pack and the 6 fixing screws in the back of transmitter, and then remove the transmitter back case (Be careful not to break the wires inside). Use a Phillips screwdriver to loosen the linkage screws, screw A, screw B and the throttle arresting spring in the left throttle position. Then mount them to the corresponding positions in the right throttle position. Adjust screw A according to the personal hand feeling (adjust the tension of the throttle stick). Then install the transmitter back case.

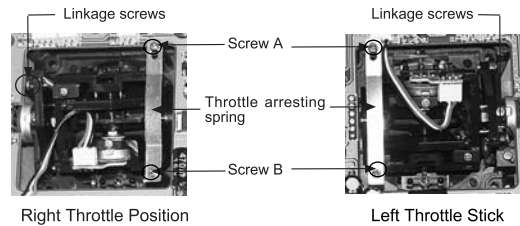

### B. The data switch

Press ENT to enter the setting status, and both ELEV and the current reverse status NOR or REV are flashing. Press UP or DN to flash STICK MOD. STICK MOD and its current stick (one of the numbers from 1 through 4) are together flashing. If want to change the stick mode, press R or L to let the number 2 or 4 behind STICK MOD flashing. Press ENT to confirm and then press EXT to exit.

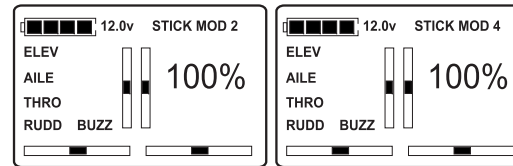

The left-hand includes two modes: MODE 2 and MODE 4; The right-hand throttle includes another two modes: MODE 1 and MODE 3. Refer to the following sketch map:

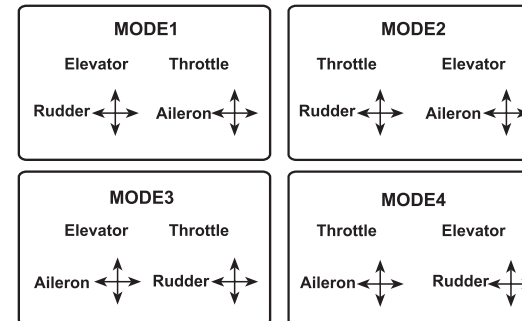

The switch from left hand throttle to right is completed and your WK-2402 is ready for normal flying.

**Note:** Pay attention to the strength when removing and adjusting the screws. Excessive strength may damage them.

# WK-2402

## 5.4 Stick tension adjustment

A. Stick tension adjustment of right-hand throttle (take MODE 1 as an example)

Remove batteries and fixing screws in the cover of WK-2402 and open the cover (don't break wires inside). Use a Phillips screwdriver to rotate the screw which is corresponding to the relative stick shown as the pictures below: clockwise rotation increases the tension and counterclockwise rotation decreases the tension.

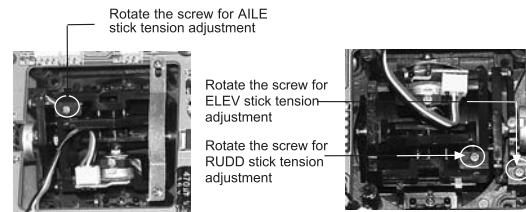

Adjustment method of right-hand throttle

B. Stick tension adjustment of left-hand throttle (take MODE 2 as an example)

Remove batteries and fixing screws in the cover of WK-2402 and open the cover (don't break wires inside). Use a Phillips screwdriver to rotate the screw which is corresponding to the relative stick shown as the pictures below: clockwise rotation increases the tension and counterclockwise rotation decreases the tension.

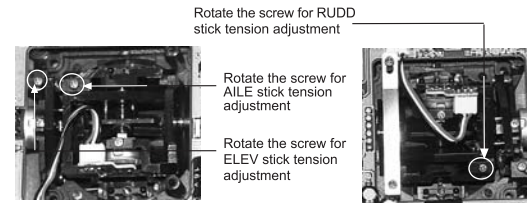

Adjustment method of left-hand throttle

## 6.0 Installation Requirements

It is important to correctly mount your radio system in your model. Below are some advices on how to install your equipments.

1. Wrap the receiver with 10mm thick foam and fix it with a rubber band or string on your helicopter or plane. It helps protect the receiver.
2. It is necessary for you to use rubber grommets and copper sleeves to isolate the vibration from the main body. The mounting screws cannot be over-tightened. Otherwise, the rubber grommets will be distorted and decrease the vibration absorption effect.

## WK-2402

- When mounting the servos, make sure the servos' bellcranks can move freely over their whole travel range and ensure the control linkages don't touch or impede the movement of the servos.
- If installing various switches, keep them far away from the engine tuned pipe and high vibration sources. Ensure all the switches move freely over their whole range.
- Don't make the receiver antennas wrapped or parallel.
- Mount the transmitter battery pack as the following picture:  
When inserting the plug of battery pack, aim the concave of the plug at the concave of socket.

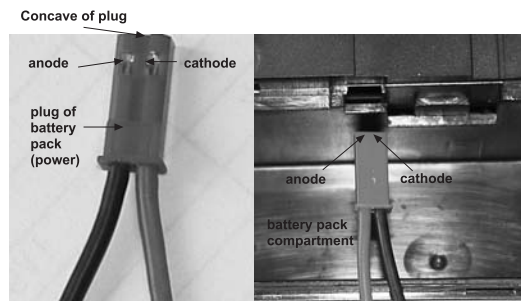

## Party two: Function Setup

### 1. 0 Main Menu

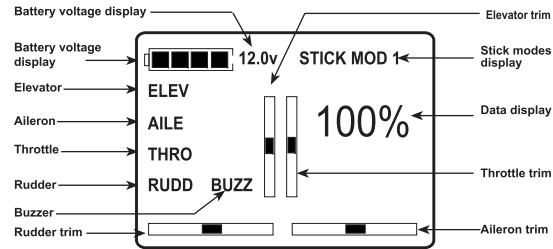

When turning on the transmitter power, the buzzer rings, and 4 trim bars beginning to make stream-like movements. After the ID binding is both buzzing and trim bars stream-like movements stop, instead of opening screen appears.

### 2. 0 Channel Reverse Setup

#### ELEV reverse setup

Press ENT to enter the setting status and both ELEV and the current reverse status NOR or REV are together flashing. If want to make reverse, press R or L to let REV or NOR flashing, and then press ENT to confirm. Press EXT to exit .

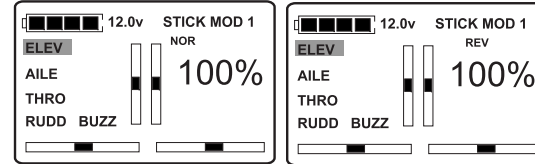

#### AILE reverse setup

Press ENT to enter the setting status, and both ELEV and the current reverse status NOR or REV are together flashing. Press UP or DN to flash AILE while its current reverse status NOR or REV is also flashing. If want to make reverse, press R or L to make REV or NOR flashing and press ENT to confirm. Press EXT to exit .

# WK-2402

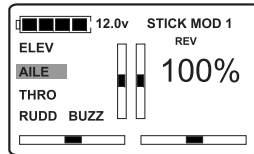
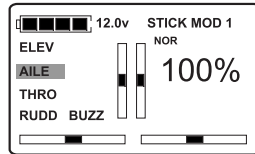

### THRO reverse setup

Press ENT to enter the setting status, and both ELEV and the current reverse status NOR or REV are together flashing. Press UP or DN to flash THRO. Both THRO and its current reverse status NOR or REV are together flashing. If want to make reverse, press R or L to let REV or NOR flashing, and then press ENT to confirm. Press EXT to exit .

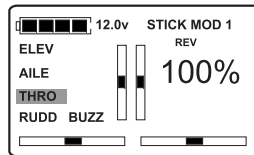
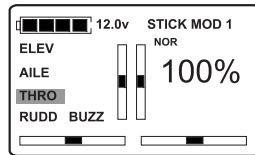

### RUDD reverse setup

Press ENT to enter the setting status, and both ELEV and the current reverse status NOR or REV are flashing. Press UP or DN to flash RUDD. RUDD and its current reverse status NOR or REV are together flashing. If want to make reverse, press R or L to let REV or NOR flashing. Press ENT to confirm, and then press EXT to exit .

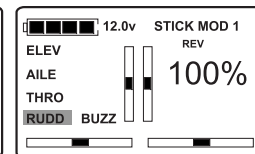
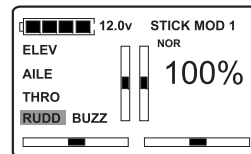

### 3.0 Buzzer setup

The buzzer setup includes two status: ON or OFF. Below is the setting method:

Press ENT to enter the setting status, and both ELEV and the current reverse status NOR or REV are flashing. Press UP or DN to flash BUZZ. BUZZ and its current switch status ON or OFF are together flashing. If want to change the switch status, press R or L to make ON or OFF flashing, and then press ENT to confirm and save. Press EXT to exit.

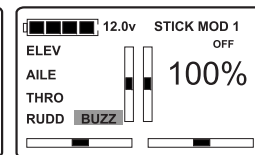
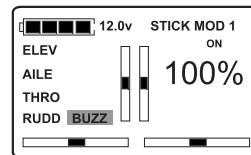



The specifications of the R/C Product may be altered without notice. ■





## **FCC WARNING**

This device complies with Part 15 of the FCC Rules. Operation is subject to the following two conditions:

- (1) this device may not cause harmful interference, and
- (2) this device must accept any interference received, including interference that may cause undesired operation.

NOTE: The manufacturer is not responsible for and radio or TV interference caused by unauthorized modifications to this equipment. Such modifications could void the user's authority to operate the equipment.