

devention
DEVO 10



DEVO 10

10-channel micro computer system

Users Manual of DEVO-10 transmitter

Note: Please read throughly the manual before using and keep it in a safe place for the future reference.

Contents

Part one: General information

1.0 General information	2
1.1 Important statements	2
1.2 Safety needing attention	2
1.3 Attention before flight	2
2.0 Features	3
2.1 Transmitter DEVO-10	3
2.2 Features of DEVO-RX1002	3
3.0 Specification	3
3.1 DEVO-10 transmitter specification	3
3.2 Receiver specification	3
4.0 Definition of DEVO-10	4
4.1 Panel definition	4
4.2 Rear definition	4
4.3 Wiring Diagram	5
4.4 Function keys in panel	5
5.0 Control Stick Adjustment	5
5.1 The stick length adjustment	5
5.2 Control Stick Tension Adjustment	6
6.0 Neck Strap Usage	6
7.0 Stick Mode Switch	6
8.0 Switches between left-hand and right-hand throttles	7
8.1 Right-hand throttle switched to left-hand throttle	7
8.2 Left-hand throttle switched to right-hand throttle	7
9.0 Training function	8
10.0 Customized fixed ID	10
11.0 Installation requirement for receiver	11
11.1 Receiver Frame rate setting	11
12.0 Installation requirement for DEVO-10 battery pack	12
12.1 DEVO-10 Battery Charging	12

Part two: Helicopter

1.0 System Menu	14
1.1 Language setting	14
1.2 Display	14
1.3 Buzzer warning	15
1.4 Vibrator	15
1.5 Stick Mode	15
1.6 Stick Direction	16
1.7 Stick Calibration	16
1.8 About	16
2.0 Model Menu	17
2.1 Model Select	17
2.2 Model Name	17
2.3 Model Copy	17
2.4 Model wireless copy	18
2.5 Model reset	19
2.6 Type Select	19
2.7 Trim System	19
2.8 Stick Position Switch	20
2.9 Device select	21
2.10 Device Output	21
2.11 Swash Type	22
2.12 Power Amplifier	22
2.13 Fixed ID	23
2.14 Sensor setting	24
3.0 Function Menu	26
3.1 Reverse Switch	26
3.2 Travel Adjust	27
3.3 Sub Trim	27
3.4 Dual rate and Exponential	28
3.5 Throttle Hold	29
3.6 Throttle Curve	30
3.7 Mix to throttle	31
3.8 Gyro Sensor	32

3.9 Governor	33
3.10 Tail Curve	33
3.11 Swash Mix	35
3.12 Pitch Curve	35
3.13 Program Mix	37
3.14 Monitor	40
3.15 Fail safe	41
3.16 Sensor View	41
3.17 Trainer	42
3.18 Timer	44

Part three: Airplane

1.0 System Menu	46
1.1 Language setting	46
1.2 Display	46
1.3 Buzzer warning	47
1.4 Vibrator	47
1.5 Stick Mode	47
1.6 Stick Direction	48
1.7 Stick Calibration	48
1.8 About	48
2.0 Model Menu	49
2.1 Model Select	49
2.2 Model Name	49
2.3 Model Copy	49
2.4 Model wireless copy	50
2.5 Model reset	51
2.6 Type Select	51
2.7 Trim System	51
2.8 Stick Position Switch	52
2.9 Device select	53
2.10 Device Output	53
2.11 Wing Type	55
2.12 Power Amplifier	57
2.13 Fixed ID	57

2.14 Sensor setting	58
3.0 Function Menu	61
3.1 Reverse Switch	61
3.2 Travel Adjust	61
3.3 Sub Trim	61
3.4 Dual rate and Exponential	62
3.5 Throttle Hold	63
3.6 Throttle Curve	63
3.7 Differential	65
3.8 Balance	67
3.9 Gyro sensor	68
3.10 Governor	69
3.11 Aileron to Rudder Mix	69
3.12 Elevator to flap mix	70
3.13 Rudder to aileron/elevator mix	71
3.14 Flap System	71
3.15 Aileron to flap mix	72
3.16 Program mix	73
3.17 Monitor	76
3.18 Fail safe	77
3.19 Sensor View	77
3.20 Trainer	78
3.21 Timer	79
4.0 Upgrading	79

devention

DEVO-10

Part one General information

DEVO-10 takes 2.4 GHz Direct Sequence Spread Spectrum (DSSS) technology and features automatic ID binding, automatic ID assignment, and also features fixed ID set by yourself. The usage of wireless copy function keeps you away from the trouble in wire link-up. Three mode types of helicopter, airplane and glider are available to meet your requirements for different models. Touch screen with wide area is used and it offers you convenient operation. Online update via USB ensures a transmitter in hand not to be out of date and makes it full of vigour.

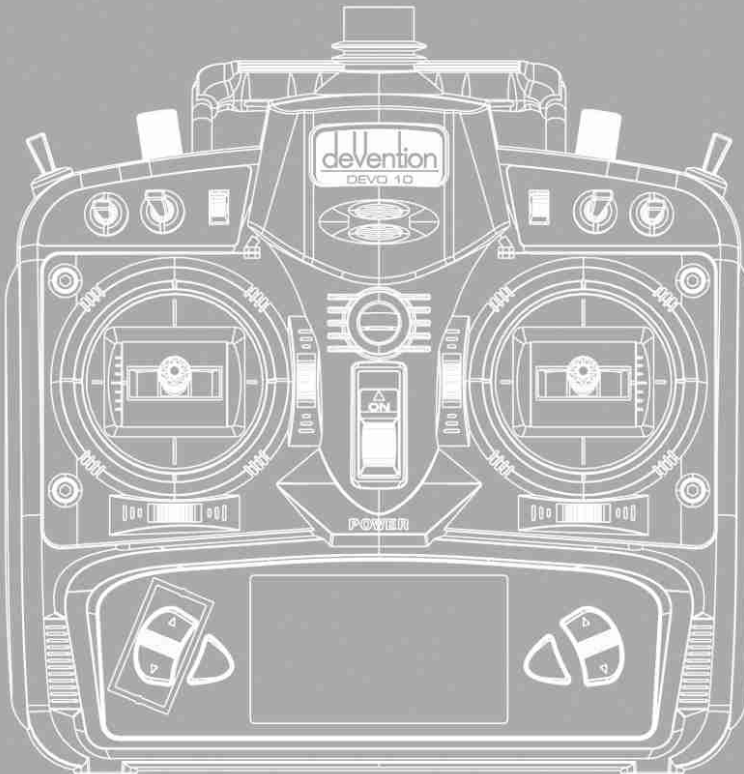

1.0 General information

1.1 Important statements

- (1) The transmitter is suitable for experienced pilots beyond 14 years old.
- (2) Flying the model aircraft in approved ground is a must.
- (3) We are not responsible for any safety caused by operation, usage or control once the transmitter is sold out.
- (4) We consign our distributors to offer technical support and service after sale. Please contact the local distributors for problem solutions caused by usage, operation, maintenance, etc.

1.2 Safety needing attention

- (1) Far away from obstacle and people.

RC aircraft in flights is uncertain of flight speed and status, which potential risk exists in when flying. Please keep your radio controlled aircraft far away from people, high buildings, high-tension line, etc, and avoid operating in rain, storms, thunder and lightening.



- (2) Away from humid environment

Radio controlled aircraft should be kept away from humidity and vapor because it is composed of complicated precise electronic elements and mechanical parts.



- (3) Proper operation

Use original spare parts to upgrade, modify or maintain your equipment in order to assure its safety. Please operate your equipment within the range of functions permitted. It is forbidden to use out of the safety laws or regulations.



- (4) Safety operation

Operate your equipment according to your body status and flight skills. Fatigue, listlessness and mis-operation will increase the possibilities of accidental hazard.



- (5) Away from heat sources

The inside of the transmitter is composed of precise electronic components and mechanical parts. Keep it far away from heat sources and sunshine to avoid distortion, or even damage caused by high temperature.



1.3 Attention before flight

- (1) Ensure the battery packs of both transmitter and receiver are fully saturated.
- (2) Ensure both the throttle stick and the throttle trim of your DEVO-10 stay at the lowest positions before operation.

- (3) Strictly obey the order of TURN-ON and TURN-OFF before operation. When starting your flight, turn on your DEVO-10 first, and connect the battery to the aircraft last. When turning off the aircraft, disconnect the battery first, and turn off your DEVO-10 last. An upset in the order may cause your aircraft out of control. Cultivate a correct habit of turn-on and turn-off.
- (4) Ensure whether the directions and actions of all the servos in your RC aircraft are correct when executing commands of the transmitter. Using broken servos will result in unforeseen dangers.

2.0 Features

2.1 Transmitter DEVO-10

- (1) The DEVO-10 adopts 2.4 GHz Direct Sequence Spread Spectrum (DSSS) technology and features automatic ID binding and ID assignment. It can also be customizedly set as fixed ID code.
- (2) USB online update makes you always enjoy the latest program.
- (3) Hi-frequency output power is adjustable.
- (4) Wireless data transmission between two DEVO-10 helps experience the training function.
- (5) Up to 30-model data can be saved.
- (6) DEVO-10 adjusting the gyro sensitivity makes hovering flight and fancy flight in an easy way.
- (7) Shape design accords with human engineering and provides comfortable holding.
- (8) Both the length and tension of the sticks can be amendable.
- (9) DEVO-10 can be freely switched among Modes 1, 2, 3, and 4.
- (10) DEVO-10 is suitable for helicopter and airplane. In the helicopter mode, there are three flight modes, each of which can be freely set and its parameters can be personalizedly adjusted to meet the requirement for F3C or 3D aerobatic flight.

2.2 Features of DEVO-RX1002

- (1) Adopts 2.4GHz Direct Sequence Spread Spectrum (DSSS) that features fast reaction and strong anti-jamming protection.
- (2) Double receiving circuits and signal switch automatically effectively assure the stability of receiving signal.
- (3) The single chip Micro as CPU provides super-strong analyzing ability.
- (4) The receiver maintains the frequency and the ID memories when its changing a new battery pack with the transmitter powered on .
- (5) It can be customizedly set as fixed ID and automatic ID assignment.

3.0 Specification

3.1 DEVO-10 transmitter Specification

- Encoder 10-channel micro computer system
- Frequency 2.4GHz DSSS
- Output power ≤ 100 mW
- Current drain ≤ 200 mA (100 mW)
- Power supply 5# Battery 8 X1.5V or NiMH 8 X1.2V 1,600 - 2,000 mAh
- Output pulse 1000 – 2000 Ms (1500Ms Neutral)

3.2 Receiver specification

- Type 2.4GHz 10 channels
- Sensitivity - 105 dbm
- Frequency interval ≥ 4 M
- Weight 9.5 g
- Dimension 37X28X14.5mm
- Receiver Battery 4.8-6V 1,300mAh

4.0 Definition of DEVO-10

4.1 Panel definition



4.2 Rear definition



- (1) Charge socket (CHG): input DC at 12V, Current 50 mA; Polarity: $\oplus \rightarrow \ominus$
- (2) Digital Signal Converter socket (DSC): used for simulator flight practice via computer (You need software and its dongle which are available in hobby shops), and for training.
- (3) USB socket: The USB socket combined with PC machine can upgrade the device program, upload and download the Configuration parameters.

4.3 Wiring Diagram

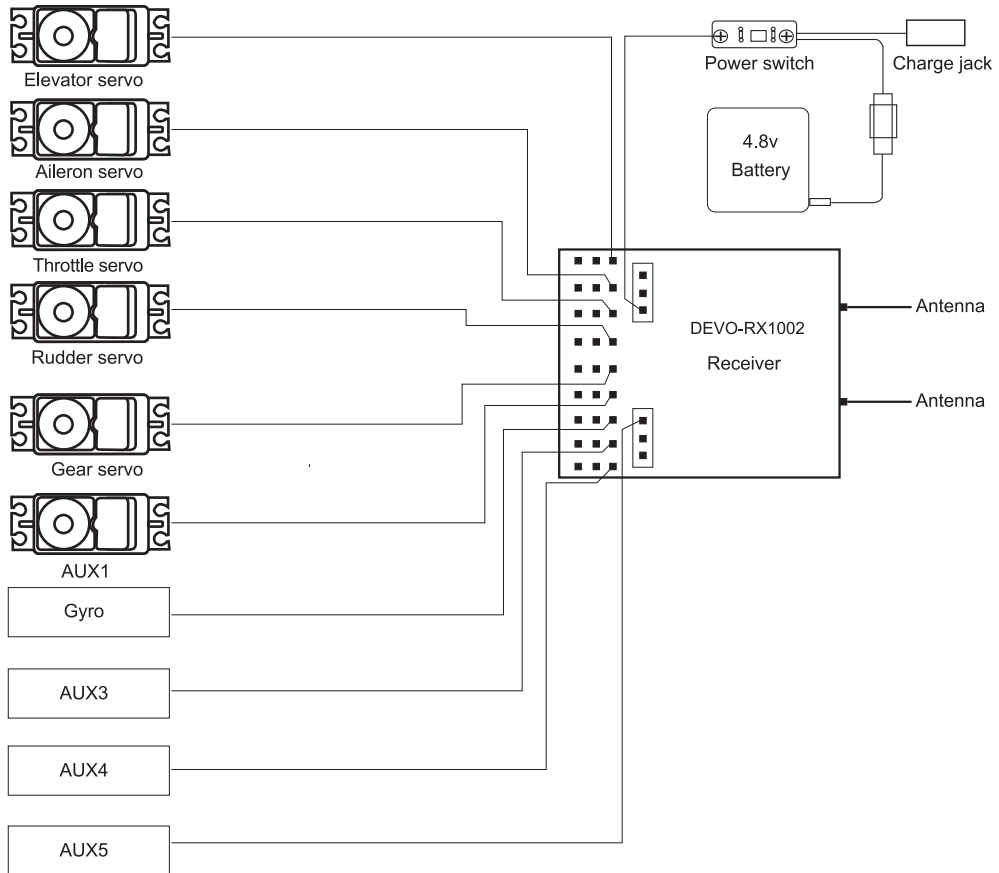

4.4 Function keys in panel

There are 6 functional keys in the panel of DEVO-10. Below are the details:

- (1) EXT: Reset key. Press EXT to exit the main menu.
- (2) ENT: Confirmation key. Press ENT to access the system or the function mode.
- (3) UP: Moves cursor up to the forward function item.
- (4) DN: Moves cursor down to the next function item.
- (5) R: Moves cursor right to increase the setting value.
- (6) L-: Moves cursor left to decrease the setting value.

5.0 Control Stick Adjustment

Stick adjustment control has two parts: the stick length and degree of tightness.

5.1 The stick length adjustment

- (1) Prolong the stick length: Counter clockwise rotate the stick head until the length you hope, and then counter clockwise tighten the stick sleeve.
- (2) Shorten the stick length: Clockwise rotate the stick sleeve until the length you hope, and then clockwise tighten the stick head.



5.2 Control Stick Tension Adjustment

Use the screw driver to loosen the 6 screws in the back cover, (Be careful not to break the wires). Then use a Phillips screwdriver to adjust each screw on the throttle arresting spring for the desired tension (Note: CW rotate to tighten the stick and CCW rotate to loosen).

Control Stick Tension Adjustment Screw

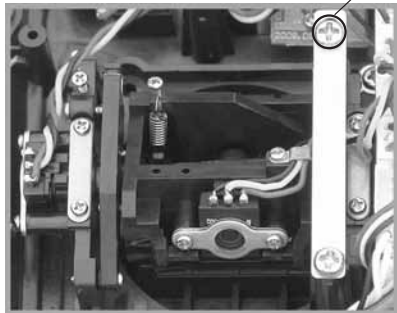

Right throttle set

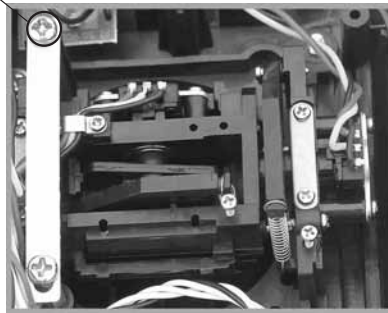

Left throttle set

6.0 Neck Strap Usage

The neck strap can be hooked on the face of the transmitter. The Hook located at the center helps to get optimal balance of the transmitter.



Neck Strap Eyelet

7.0 Stick Mode Switch

There are total four stick modes from MODE 1 through MODE 4. The left-hand throttle includes MODE 2 and MODE 4, and the right-hand throttle includes MODE 1 and MODE 3. Below is the sketch map:

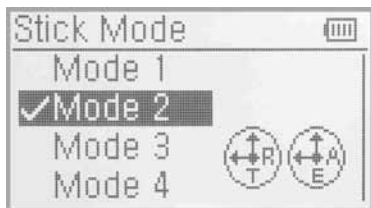

MODE 2



MODE 4

MODE 2 and MODE 4 are listed in left-hand throttle.



MODE 1

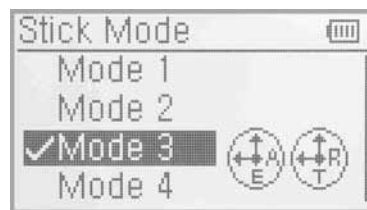

MODE 3

MODE 1 and MODE 3 are listed in right-hand throttle.

8.0 Switches between left-hand and right-hand throttles

The throttle switch between the left hand and right hand will be successful if both the MECHANICAL switch and ELECTRONIC switch are finished, separately. Below are the methods for switching:

8.1 Right-hand throttle switched to left-hand throttle

(1) Mechanical switch

Remove the battery and 6 fixed screws in the back cover of Transmitter, and remove the transmitter back cover (Be careful not to break the wires).The internal conditions of the left and right throttle are showed in the following pictures. Then use a Phillips screwdriver to release the connecting rod fixed screw\screw F\screw G and throttle arresting slices in the right throttle position,and fix them up in the corresponding left hand Throttle position.According to personal feeling to adjust screw F(adjust the Throttle stick to desired tention),then fixed up the transmitter back cover.

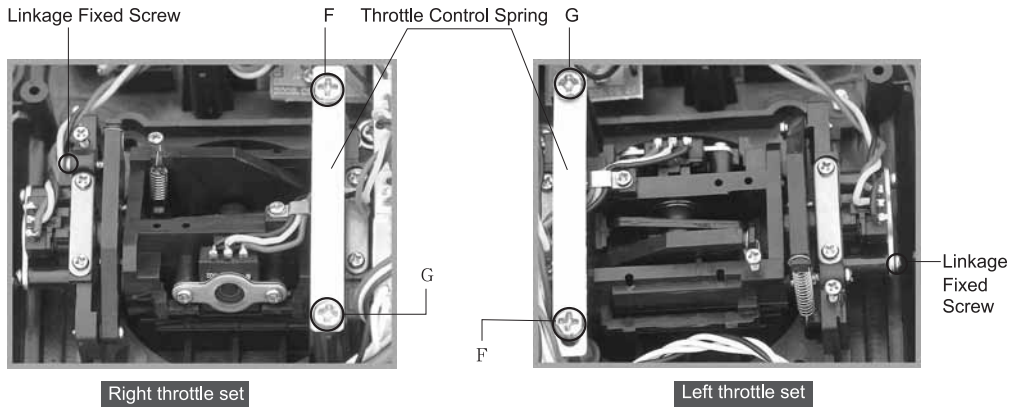

(2) The ELECTRONIC switch

In the main interface,press ENT to access the main menu;Press UP\DN to choose "system menu";Press UP\DN to choose "stick model" and access via "ENT" key,or to choose "model 2\4" and confirm via ENT key,make a mark "✓" before the choosed model.Press EXT to exit after setup complete.

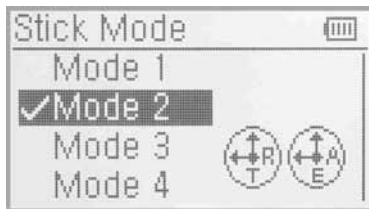

Through the mechanical and electronic switch,the right hand throttle switch to the left hand successfully and can be used normally.

8.2 Left-hand throttle switched to right-hand throttle

(1) Mechanical switch

Refer to the above "Mechanical switch" to open the transmitter cover.

See the following pictures to learn the internal conditions of the left and right hand stich. Then use a Phillips screwdriver to release the connecting rod fixed screw\screw F\screw G and throttle arresting slices in the left hand throttle position,and fix them up in the corresponding right hand Throttle position.According to personal feeling to adjust screw F(adjust the Throttle stick to desired tention),then fixed up the transmitter back cover.

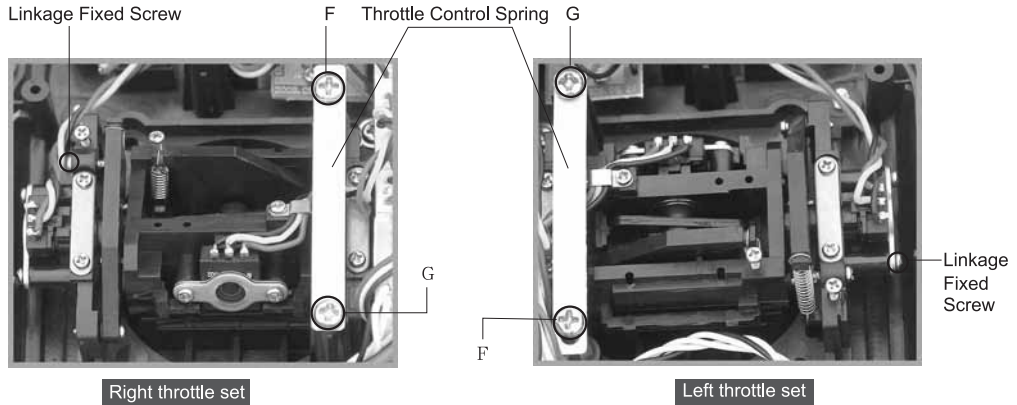

(2) The data switch

Refer to the steps of “8.1 right hand throttle switch to the left hand ,(2)electric switch”,access to “stick model”. The left hand throttle switch to the right hand. There are 4 stick models can be choosed at the stick position. Press UP/DN to choose “model 1\3” and confirm via ENT key,make a mark “√” before the choosed model.Press EXT to exit after setup complete.The dates can be switched automatically.



The switch from left hand throttle to right is completed and your DEVO-10 is ready for normal flying.

Note: Pay attention to the strength when removing and adjusting the screws. Excessive strength may damage them.

9.0 Training function

Two DEVO-10 transmitters working together can execute the training function to meet the requirements for the beginner. The setting method is shown as below:

(1) Data copy

First, use the wireless copy function between two DEVO-10 to copy the main transmitter’s model data to the trainee’s transmitter, this promise the the model data between two transmitters is same. Refer the copy method to the second part of helicopter “2.4 model wireless copy” and do the following steps:

(2) Linkage

Insert the signal wire from the trainer’s transmitter into the DSC socket of the trainee’s transmitter. Turn on the transmitter and a linkage icon will be shown on the boot screen.

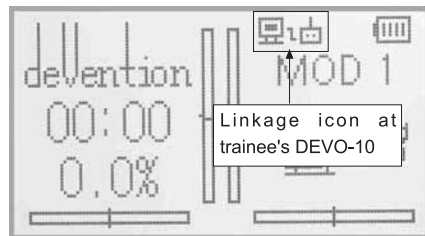

linkage icon

Turn on the power of the trainer’s radio. Find out the trainee’s model data, and then let the trainer’s Radio bind with the aircraft model and fly it normally. Then turn off the power.Insert the other end of the digital signal wire into the trainer’s DEVO-10, and then turn on its power. A linkage icon will be shown as below:



Trainee is off and trainer is working

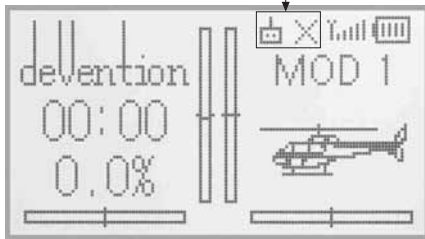

Trainee is working and trainer is off

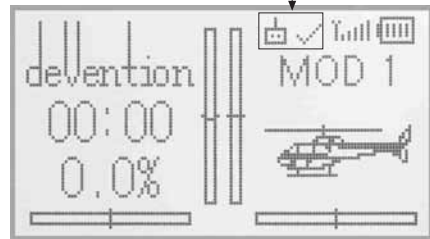

Trainer icon

Training status display: when the trainer's icon becomes into "X", the trainee stops flying and the trainer is working; when the trainer's icon turns into "✓", the trainee is flying and the trainer is in leisure.

(3) Usage method

The training switch can be freely switchable between Left trim and Right trim. The default setting is Right trim. Shown as below:



During flight, if the trainer pushes Right Trim once, the linkage icon will be shown as "✓" that means the control right is moved to the trainee from Trainer. If trainer pushes Right Trim once again, the linkage icon will be shown as "X" that means the trainer takes back the control right from the trainee.

(4) Setting for training function channels

Trainee is available to get full or part of flight control power to the aircraft model via setting the training function channel in the trainer's radio. Below is the setting method:

Push the ENT button to enter main Menu, and then push UP or DN to get access to function menu. Then push UP or DN to select "training function" and push ENT button to enter Trainer screen interface. The available channels are shown below, and the current status of trainer switch is also shown there.



Trainer switch selection: Press UP or DN to select the switch option; press R or L to select the switch which you want. It includes right and left trim. The default setting is Right trim.

Channel selection: Press UP or DN to select the channel option; Press R or L to select the channel(s) which you want to grant to trainee. The channel(s) you have selected will be activated as "Active". The channels which are not granted to trainee will be kept inhibited. The default setting is "Inhibit".

Press EXT to exit.

10.0 Customized fixed ID

This setting will bind DEVO-10 with its receiver in a unique corresponding relationship. It will greatly speed up the time of automatic binding when DEVO-10 powered on.

(1) Setting for fixed ID

The setting for fixed ID should be under the status that automatic ID binding is successfully finished. Below is the setting method.

Press ENT to enter the main Menu and push UP or DN to move the navigational mark to select Model menu. Press ENT to enter Model Menu. Press UP or DN to select Fixed ID and press ENT to enter the Fixed ID setting interface.

If you want to activate the fixed ID settings, press R or L to change the status from off to ON. A series of random digits will be shown below after change to On.



Press UP or DN to choose the ID code setting, press R or L to choose the words or number, press UP or DN moves to the next code setting. There are 6 words that can be set to ID code.



Press ENT key after the new ID has been set. An inquiry interface of "Are you sure?" will pop up. "ID Code Matching" will be shown after press ENT. After matching, the interface will be returned to Model Menu.

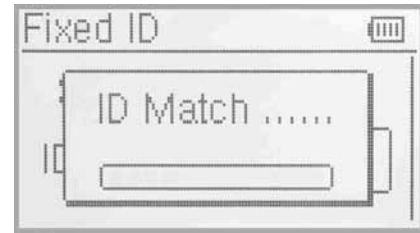
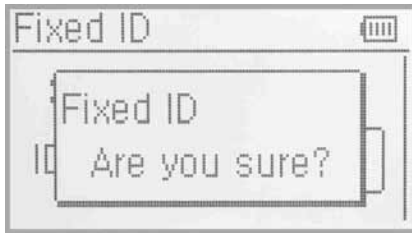

(2) Fixed ID cancellation

Insert the assorted BIND PLUG into the output terminal of BATT before the receiver is powered on, and then plug 5V DC power into other output terminal. The red light of receiver will flash slowly. This means the fixed ID code has been cancelled. Pull out bind plug. DEVO-10 also needs to make relative cancellation and revision after the fixed ID in receiver is cleared out.

In the main interface press the ENT to enter Model Menu and then press UP or DN to move the navigational mark to select MODEL MENU. Press ENT to enter MODEL MENU. Press UP or DN to select Fixed ID code and push ENT key to enter the Fixed ID code interface. Press UP or DN to select STATUS option, Press R or L to change the status to Off. Then press EXT to exit.

