



**FCC 47 CFR PART 15 Subpart C**

**TEST REPORT**

**For**

**Home Monitoring Gateway**

**Model Number:  
iHUB-3001B, iHUB-3001B-ADT**

**Trade Name: iControl, ADT**

*Issued to*

**iControl Networks Inc.  
555 Twin Dolphin Drive Suite 280, Redwood City,  
California 94065, United States**

*Issued by*

**Compliance Certification Services Inc.  
No.11, Wu-Gong 6th Rd., Wugu Industrial Park,  
New Taipei City 248, Taiwan (R.O.C.)**

**<http://www.ccsrf.com>**

**[service@ccsrf.com](mailto:service@ccsrf.com)**

**Issued Date: May 2, 2012**



Testing Laboratory  
1309

---

*Note: This report shall not be reproduced except in full, without the written approval of Compliance Certification Services Inc. This document may be altered or revised by Compliance Certification Services Inc. personnel only, and shall be noted in the revision section of the document.*



**Revision History**

Rev.	Issue Date	Revisions	Effect Page	Revised By
00	May 2, 2012	Initial Issue	ALL	Eunice Shem



## TABLE OF CONTENTS

1. TEST RESULT CERTIFICATION.....	4
2. EUT DESCRIPTION.....	5
3. TEST METHODOLOGY .....	6
3.1 EUT CONFIGURATION .....	6
3.2 EUT EXERCISE.....	6
3.3 GENERAL TEST PROCEDURES.....	6
3.4 FCC PART 15.205 RESTRICTED BANDS OF OPERATIONS.....	7
3.5 DESCRIPTION OF TEST MODES .....	7
4. INSTRUMENT CALIBRATION.....	8
4.1 MEASURING INSTRUMENT CALIBRATION .....	8
4.2 MEASUREMENT EQUIPMENT USED .....	8
4.3 MEASUREMENT UNCERTAINTY .....	9
5. FACILITIES AND ACCREDITATIONS.....	10
5.1 FACILITIES .....	10
5.2 EQUIPMENT.....	10
5.3 TABLE OF ACCREDITATIONS AND LISTINGS.....	11
6. SETUP OF EQUIPMENT UNDER TEST.....	12
6.1 SETUP CONFIGURATION OF EUT.....	12
6.2 SUPPORT EQUIPMENT .....	12
7. FCC PART 15.249 REQUIREMENTS.....	13
7.1 20 DB BANDWIDTH.....	13
7.2 SPURIOUS EMISSION .....	15
7.3 POWERLINE CONDUCTED EMISSIONS .....	21
APPENDIX I PHOTOGRAPHS OF TEST SETUP .....	24
APPENDIX 1 - PHOTOGRAPHS OF EUT	



# 1. TEST RESULT CERTIFICATION

**Applicant:** iControl Networks Inc.  
555 Twin Dolphin Drive Suite 280, Redwood City,  
California 94065, United States

**Equipment Under Test:** Home Monitoring Gateway

**Trade Name:** iControl, ADT

**Model Number:** iHUB-3001B, iHUB-3001B-ADT

**Date of Test:** March 29 ~ April 26, 2012

APPLICABLE STANDARDS	
STANDARD	TEST RESULT
FCC 47 CFR Part 15 Subpart C	No non-compliance noted

### We hereby certify that:

The above equipment was tested by Compliance Certification Services Inc. The test data, data evaluation, test procedures, and equipment configurations shown in this report were made in accordance with the procedures given in ANSI C63.4: 2003 and the energy emitted by the sample EUT tested as described in this report is in compliance with the requirements emission limits of FCC Rules Part 15.107, 15.109, 15.207, 15.209 and 15.249.

The test results of this report relate only to the tested sample identified in this report.

Approved by:

Reviewed by:

\_\_\_\_\_  
Jason Lin  
Section Manager  
Compliance Certification Services Inc.

\_\_\_\_\_  
Gina Lo  
Section Manager  
Compliance Certification Services Inc.



## 2. EUT DESCRIPTION

<b>Product</b>	Home Monitoring Gateway
<b>Trade Name</b>	iControl, ADT
<b>Model Number</b>	iHUB-3001B, iHUB-3001B-ADT
<b>Model Discrepancy</b>	All the specification and layout are identical except they come with different model numbers for marketing purposes.
<b>Received Date</b>	March 27, 2012
<b>Power Adapter</b>	1. Brand: Sunny / Model: SYS1381-1212-W2 I/P: 100-240V, 50-60Hz, 0.5A MAX O/P: 12V, 1.0A 2. Brand: LEADER / Model: MU12-G120100-A1 I/P: 100-240V, 50-60Hz, 0.5A O/P: 12V, 1.0A
<b>Frequency Range</b>	902MHz ~ 928MHz
<b>Modulation Technique</b>	FSK
<b>Antenna Gain</b>	3.5dBi
<b>Antenna Designation</b>	PIFA Antenna

**Remark:**

1. The sample selected for test was production product and was provided by manufacturer.
2. This submittal(s) (test report) is intended for FCC ID: **S23-IHUB3001B** filing to comply with Section 15.107 & 15.109 (FCC Part 15, Subpart B) and Section 15.207, 15.209, 15.249.



### **3. TEST METHODOLOGY**

The tests documented in this report were performed in accordance with ANSI C63.4 and FCC CFR 47 2.1046, 2.1047, 2.1049, 2.1051, 2.1053, 2.1055, 2.1057, 15.207, 15.209 and 15.249.

#### **3.1 EUT CONFIGURATION**

The EUT configuration for testing is installed on RF field strength measurement to meet the Commissions requirement and operating in a manner that intends to maximize its emission characteristics in a continuous normal application.

#### **3.2 EUT EXERCISE**

The EUT was operated in the engineering mode to fix the TX frequency that was for the purpose of the measurements.

According to its specifications, the EUT must comply with the requirements of the Section 15.107 and 15.109 under the FCC Rules Part 15 Subpart B and Section 15.207, 15.209, 15.249 under the FCC Rules Part 15 Subpart C.

#### **3.3 GENERAL TEST PROCEDURES**

##### **Conducted Emissions**

The EUT is placed on the turntable, which is 0.8 m above ground plane. According to the requirements in Section 13.1.4.1 of ANSI C63.4 Conducted emissions from the EUT measured in the frequency range between 0.15 MHz and 30MHz using CISPR Quasi-peak and average detector modes.

##### **Radiated Emissions**

The EUT is placed on a turn table, which is 0.8 m above ground plane. The turntable shall rotate 360 degrees to determine the position of maximum emission level. EUT is set 3m away from the receiving antenna, which varied from 1m to 4m to find out the highest emission. And also, each emission was to be maximized by changing the polarization of receiving antenna both horizontal and vertical. In order to find out the maximum emissions, exploratory radiated emission measurements were made according to the requirements in Section 13.1.4.1 of ANSI C63.4.



### 3.4 FCC PART 15.205 RESTRICTED BANDS OF OPERATIONS

(a) Except as shown in paragraph (d) of this section, only spurious emissions are permitted in any of the frequency bands listed below:

MHz	MHz	MHz	GHz
0.090 - 0.110	16.42 - 16.423	399.9 - 410	4.5 - 5.15
<sup>1</sup> 0.495 - 0.505	16.69475 - 16.69525	608 - 614	5.35 - 5.46
2.1735 - 2.1905	16.80425 - 16.80475	960 - 1240	7.25 - 7.75
4.125 - 4.128	25.5 - 25.67	1300 - 1427	8.025 - 8.5
4.17725 - 4.17775	37.5 - 38.25	1435 - 1626.5	9.0 - 9.2
4.20725 - 4.20775	73 - 74.6	1645.5 - 1646.5	9.3 - 9.5
6.215 - 6.218	74.8 - 75.2	1660 - 1710	10.6 - 12.7
6.26775 - 6.26825	108 - 121.94	1718.8 - 1722.2	13.25 - 13.4
6.31175 - 6.31225	123 - 138	2200 - 2300	14.47 - 14.5
8.291 - 8.294	149.9 - 150.05	2310 - 2390	15.35 - 16.2
8.362 - 8.366	156.52475 -	2483.5 - 2500	17.7 - 21.4
8.37625 - 8.38675	156.52525	2655 - 2900	22.01 - 23.12
8.41425 - 8.41475	156.7 - 156.9	3260 - 3267	23.6 - 24.0
12.29 - 12.293	162.0125 - 167.17	3332 - 3339	31.2 - 31.8
12.51975 - 12.52025	167.72 - 173.2	3345.8 - 3358	36.43 - 36.5
12.57675 - 12.57725	240 - 285	3600 - 4400	( <sup>2</sup> )
13.36 - 13.41	322 - 335.4		

<sup>1</sup> Until February 1, 1999, this restricted band shall be 0.490-0.510 MHz.

<sup>2</sup> Above 38.6

(b) Except as provided in paragraphs (d) and (e), the field strength of emissions appearing within these frequency bands shall not exceed the limits shown in Section 15.209. At frequencies equal to or less than 1000 MHz, compliance with the limits in Section 15.209 shall be demonstrated using measurement instrumentation employing a CISPR quasi-peak detector. Above 1000 MHz, compliance with the emission limits in Section 15.209 shall be demonstrated based on the average value of the measured emissions. The provisions in Section 15.35 apply to these measurements.

### 3.5 DESCRIPTION OF TEST MODES

The EUT (model: iHUB-3001B) comes with two types of power adapter (SYS1381-1212-W2 / MU12-G120100-A1) for sale. After the preliminary test, the power adapter MU12-G120100-A1 was found to emit the worst emissions and therefore had been tested under operating condition.

After verification, all tests were carried out with the worst case test modes as shown below except radiated spurious emission below 1GHz, which worst case was in normal link mode only, and powerline conducted emission below 30MHz, which worst case was in normal link mode.



## 4. INSTRUMENT CALIBRATION

### 4.1 MEASURING INSTRUMENT CALIBRATION

The measuring equipment, which was utilized in performing the tests documented herein, has been calibrated in accordance with the manufacturer's recommendations for utilizing calibration equipment, which is traceable to recognized national standards.

### 4.2 MEASUREMENT EQUIPMENT USED

#### Equipment Used for Emissions Measurement

*Remark: Each piece of equipment is scheduled for calibration once a year and Loop Antenna is scheduled for calibration once three years.*

Conducted Emissions Test Site				
Name of Equipment	Manufacturer	Model	Serial Number	Calibration Due
Spectrum Analyzer	Agilent	E4446A	MY43360131	03/16/2013

Wugu 966 Chamber A				
Name of Equipment	Manufacturer	Model	Serial Number	Calibration Due
Spectrum Analyzer	Agilent	E4446A	US42510252	11/02/2012
EMI Test Receiver	R&S	ESCI	100064	02/16/2013
Pre-Amplifier	Mini-Circuits	ZFL-1000LN	SF350700823	01/12/2013
Pre-Amplifier	MITEQ	AFS44-00102650-42-10P-44	1415367	11/19/2012
Bilog Antenna	Sunol Sciences	JB3	A030105	10/03/2012
Horn Antenna	EMCO	3117	00055165	01/11/2013
Horn Antenna	EMCO	3116	00026370	10/12/2012
Loop Antenna	EMCO	6502	8905/2356	06/10/2013
Turn Table	CCS	CC-T-1F	N/A	N.C.R
Antenna Tower	CCS	CC-A-1F	N/A	N.C.R
Controller	CCS	CC-C-1F	N/A	N.C.R
Site NSA	CCS	N/A	N/A	12/25/2012
Test S/W	EZ-EMC (CCS-3A1RE)			

Conducted Emission room # B				
Name of Equipment	Manufacturer	Model	Serial Number	Calibration Due
TEST RECEIVER	R&S	ESCI	100234	06/13/2012
LISN (EUT)	FCC	FCC-LISN-50-32-2	08009	03/26/2013
LISN	SCHWARZBECK	NSLK 8127	8127382	01/02/2013
BNC CABLE	EMCI	5Dr	BNC B4	03/15/2013
Pulse Limiter	R&S	ESH3-Z2	100374	01/08/2013
THERMO-HYGRO METER	WISEWIND	201A	1006	05/23/2012
Test S/W	EZ-EMC			





### 4.3 MEASUREMENT UNCERTAINTY

PARAMETER	UNCERTAINTY
Powerline Conducted Emission	+/- 1.29
3M Semi Anechoic Chamber / 30M~200M	+/- 4.0138
3M Semi Anechoic Chamber / 200M~1000M	+/- 3.9483
3M Semi Anechoic Chamber / 1G~8G	+/- 2.5975
3M Semi Anechoic Chamber / 8G~18G	+/- 2.6112
3M Semi Anechoic Chamber / 18G~26G	+/- 2.7389
3M Semi Anechoic Chamber / 26G~40G	+/- 2.9683

**Remark:** This uncertainty represents an expanded uncertainty expressed at approximately the 95% confidence level using a coverage factor of  $k=2$ .



## 5. FACILITIES AND ACCREDITATIONS

### 5.1 FACILITIES

All measurement facilities used to collect the measurement data are located at

No.199, Chungshen Road, Hsintien City, Taipei Hsien, Taiwan, R.O.C.

Tel: 886-2-2217-0894 / Fax: 886-2-2217-1029

*Remark: The Powerline Conducted test items was tested at Compliance Certification Services Inc. (Hsintien Lab.)  
The test equipments were listed in page 8 and the test data, please refer page22-23.*

No.11, Wu-Gong 6th Rd., Wugu Industrial Park, New Taipei City 248, Taiwan (R.O.C.)

Tel: 886-2-2299-9720 / Fax: 886-2-2298-4045

No.81-1, Lane 210, Bade 2nd Rd., Lujhu Township, Taoyuan County 33841, TAIWAN, R.O.C.

Tel: 886-3-324-0332 / Fax: 886-3-324-5235

The sites are constructed in conformance with the requirements of ANSI C63.7, ANSI C63.4 and CISPR Publication 22.

### 5.2 EQUIPMENT

Radiated emissions are measured with one or more of the following types of linearly polarized antennas: tuned dipole, biconical, log periodic, bi-log, and/or ridged waveguide, horn. Spectrum analyzers with pre-selectors and quasi-peak detectors are used to perform radiated measurements.



Conducted emissions are measured with Line Impedance Stabilization Networks and EMI Test Receivers.

Calibrated wideband preamplifiers, coaxial cables, and coaxial attenuators are also used for making measurements.

All receiving equipment conforms to CISPR Publication 16-1, "Radio Interference Measuring Apparatus and Measurement Methods."



### 5.3 TABLE OF ACCREDITATIONS AND LISTINGS

Country	Agency	Scope of Accreditation	Logo
USA	FCC	3M Semi Anechoic Chamber (FCC MRA: TW1039) to perform FCC Part 15 measurements	 FCC MRA: TW1039
Taiwan	TAF	LP0002, RTTE01, FCC Method-47 CFR Part 15 Subpart C, D, E, RSS-210, RSS-310 IDA TS SRD, AS/NZS 4268, AS/NZS 4771, TS 12.1 & 12.2, ETSI EN 300 440-1, ETSI EN 300 440-2, ETSI EN 300 328, ETSI EN 300 220-1, ETSI EN 300 220-2, ETSI EN 301 893, ETSI EN 301 489-1/3/7/17 FCC OET Bulletin 65 + Supplement C, EN 50360, EN 50361, EN 50371, RSS 102, EN 50383, EN 50385, EN 50392, IEC 62209, CNS 14958-1, CNS 14959 FCC Method -47 CFR Part 15 Subpart B IEC / EN 61000-3-2, IEC / EN 61000-3-3, IEC / EN 61000-4-2/3/4/5/6/8/11	
Canada	Industry Canada	3M Semi Anechoic Chamber (IC 2324G-1 / IC 2324G-2) to perform	 IC 2324G-1 IC 2324G-2

\* No part of this report may be used to claim or imply product endorsement by A2LA or any agency of the US Government.



## 6. SETUP OF EQUIPMENT UNDER TEST

### 6.1 SETUP CONFIGURATION OF EUT

See test photographs attached in Appendix I for the actual connections between EUT and support equipment.

### 6.2 SUPPORT EQUIPMENT

No	Equipment	Model No.	Serial No.	FCC ID / BSMI ID	Brand Name	Data Cable	Power Cord
1	USB Mouse	M-UAE96	F93A90A5BU90L20	DOC BSMI: T41126	HP	Shielded, 1.8m	N/A
2	USB Keyboard	KU-0316	BC3870FVBWH079	DOC BSMI: R33001	HP	Shielded, 1.8m	N/A
3~4	iPod	A1112	N/A	BSMI: R33057	Apple	Shielded, 1.8m	N/A
5	Modem	AL-56ERM	0MERM04A0223	DOC	GALILEO	Shielded, 1.0m	Unshielded, 1.8m
6	Host PC	T3500	FX36VBX	DOC BSMI: R33002	DELL	Unshielded, 1.0m	Unshielded, 1.8m
7	Monitor	933SN+	N/A	DOC BSMI: R33475	SAMSUNG	Shielded, 1.8m with two cores	Unshielded, 1.8m
8	Printer	Deskjet D2360	TH73C1492F	DOC BSMI: R33001	HP	Shielded, 1.5m	Unshielded, 1.8m
9	Server PC	HD075AV	SGH950SHHC	DOC BSMI: R33001	HP	Unshielded, 20m	Unshielded, 1.8m
10	Notebook PC (Remote)	PP19L	61G6Q1S	FCC DoC	DELL	LAN Cable: Unshielded, 10m Line Cable: Unshielded, 1.0m	AC I/P: Unshielded, 1.8m DC O/P: Unshielded, 1.8m with a core

**Remark:**

1. All the equipment/cables were placed in the worst-case configuration to maximize the emission during the test.
2. Grounding was established in accordance with the manufacturer's requirements and conditions for the intended use.



## 7. FCC PART 15.249 REQUIREMENTS

### 7.1 20 DB BANDWIDTH

#### LIMIT

None; for reporting purposes only.

#### Test Configuration

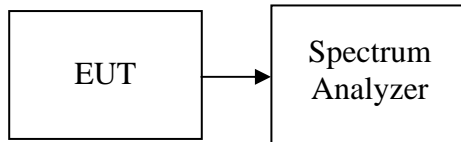

#### TEST PROCEDURE

1. Place the EUT on the table and set it in the transmitting mode.
2. Remove the antenna from the EUT and then connect a low loss RF cable from the antenna port to the spectrum analyzer.
3. Set the spectrum analyzer as RBW=3kHz, VBW = 10kHz, Span = 500kHz, Sweep = auto.
4. Mark the peak frequency and 20dB (upper and lower) frequency.
5. Repeat until all the rest channels are investigated.

#### TEST RESULTS

*No non-compliance noted*

#### Test Data

Frequency (MHz)	20dB Bandwidth (kHz)
908	75.4



### Test Plot

Agilent 11:21:03 Apr 30, 2012

R T

▲ Mkr2 75.4 kHz  
0.36 dB

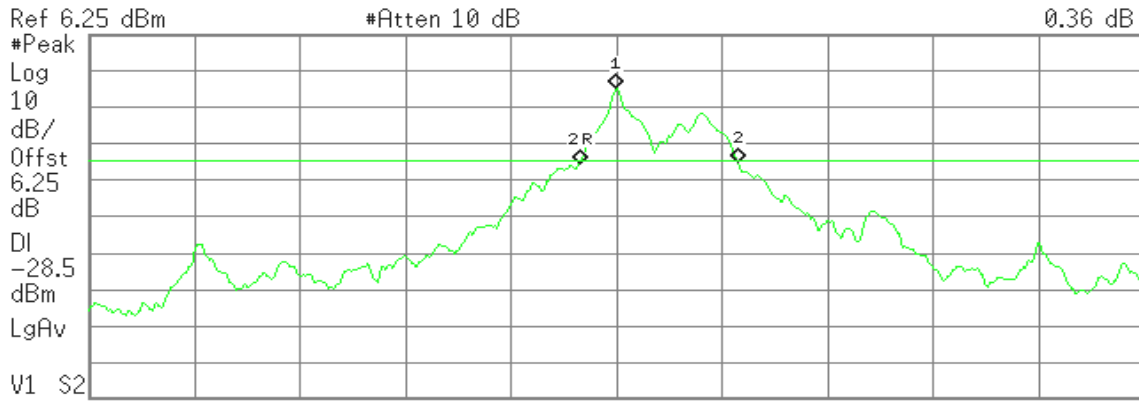

Center 908.393 2 MHz Span 500 kHz  
#Res BW 3 kHz #VBW 10 kHz Sweep 52.72 ms (601 pts)

Marker	Trace	Type	X Axis	Amplitude
1	(1)	Freq	908.393 2 MHz	-8.50 dBm
2R	(1)	Freq	908.375 6 MHz	-29.05 dBm
2▲	(1)	Freq	75.4 kHz	0.36 dB



## 7.2 SPURIOUS EMISSION

### LIMIT

1. In the section 15.249(a):

Except as provided in paragraph (b) of this section, the field strength of emissions from intentional radiators operated within these frequency bands shall comply with the following:

Fundamental Frequency (MHz)	Field Strength of Fundamental Field Strength (mV/m)	Field Strength of Harmonics ( $\mu$ V/m)
902-928 MHz	50	500
2400 - 2483.5 MHz	50	500
5725 - 5875 MHz	50	500
24.0 - 24.25 GHz	250	2500

2. Except as provided elsewhere in this Subpart, the emissions from an intentional radiator shall not exceed the field strength levels specified in the following table:

Frequency (MHz)	Field Strength ( $\mu$ V/m)	Measurement Distance (m)
30-88	100*	3
88-216	150*	3
216-960	200*	3
Above 960	500	3

**Remark:** Except as provided in paragraph (g), fundamental emissions from intentional radiators operating under this Section shall not be located in the frequency bands 54-72 MHz, 76-88 MHz, 174-216 MHz or 470-806 MHz. However, operation within these frequency bands is permitted under other sections of this Part, e.g., Sections 15.231 and 15.241.

3. In the above emission table, the tighter limit applies at the band edges.

Frequency (MHz)	Field Strength ( $\mu$ V/m at 3-meter)	Field Strength (dB $\mu$ V/m at 3-meter)
30-88	100	40
88-216	150	43.5
216-960	200	46
Above 960	500	54



### Test Configuration

9kHz ~ 30MHz

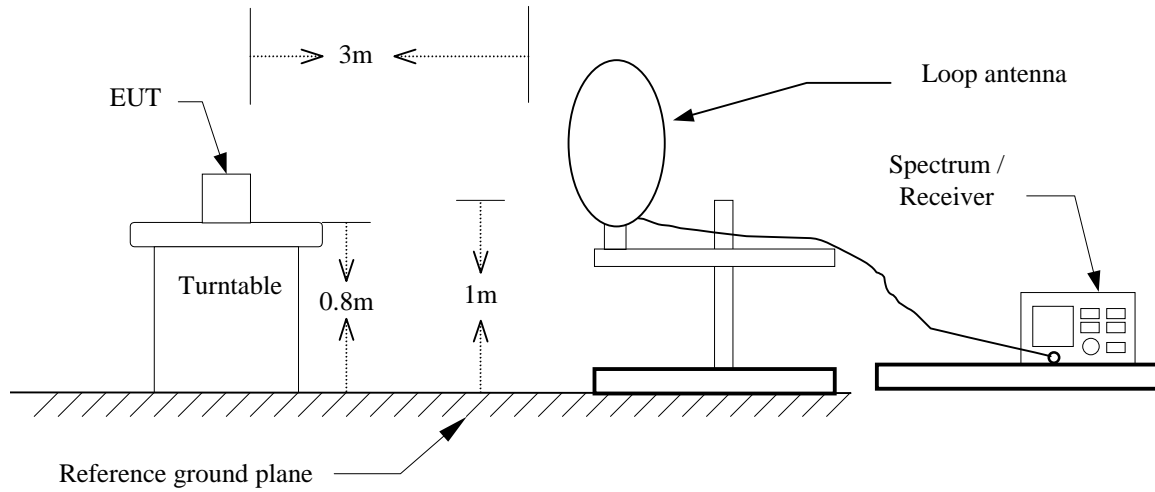

30MHz ~ 1GHz

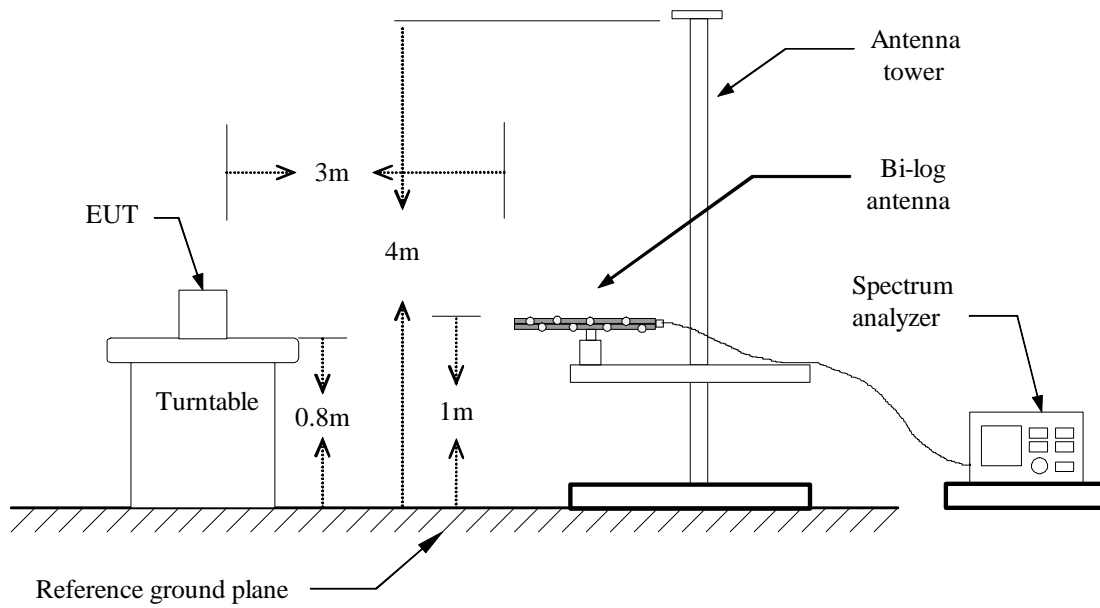





Above 1 GHz

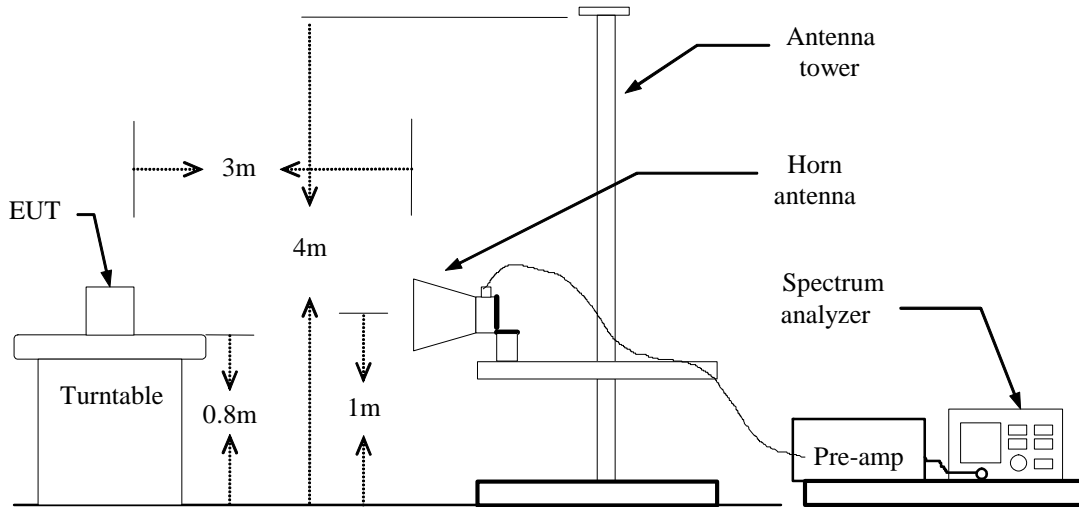



## **TEST PROCEDURE**

1. The EUT is placed on a turntable, which is 0.8m above ground plane.
2. The turntable shall be rotated for 360 degrees to determine the position of maximum emission level.
3. EUT is set 3m away from the receiving antenna, which is varied from 1m to 4m to find out the highest emissions.
4. Maximum procedure was performed on the six highest emissions to ensure EUT compliance.
5. And also, each emission was to be maximized by changing the polarization of receiving antenna both horizontal and vertical.
6. Set the spectrum analyzer in the following setting as:  
Below 1GHz:  
RBW=100kHz / VBW=300kHz / Sweep=AUTO  
Above 1GHz:  
(a) PEAK: RBW=1MHz / VBW=3MHz / Sweep=AUTO  
(b) AVERAGE: RBW=1MHz / VBW=10Hz / Sweep=AUTO
7. Repeat above procedures until the measurements for all frequencies are complete.

**Below 1 GHz**

**Operation Mode:** Normal Link      **Test Date:** April 26, 2012  
**Temperature:** 25°C      **Tested by:** Sehni Hu  
**Humidity:** 50% RH      **Polarity:** Ver. / Hor.

Frequency (MHz)	Reading (dBuV)	Correction Factor (dB/m)	Result (dBuV/m)	Limit (dBuV/m)	Margin (dB)	Remark	Ant. Pol. (H/V)
49.40	66.37	-32.83	33.54	40.00	-6.46	Peak	V
73.65	67.51	-33.04	34.47	40.00	-5.53	Peak	V
157.72	66.80	-28.60	38.20	43.50	-5.30	QP	V
359.80	59.78	-24.93	34.85	46.00	-11.15	Peak	V
479.43	60.87	-22.48	38.39	46.00	-7.61	Peak	V
600.68	56.66	-20.92	35.74	46.00	-10.26	Peak	V
149.63	65.20	-28.32	36.88	43.50	-6.62	QP	H
233.70	63.95	-29.03	34.92	46.00	-11.08	Peak	H
299.98	62.11	-26.38	35.73	46.00	-10.27	Peak	H
359.80	63.26	-24.93	38.33	46.00	-7.67	Peak	H
479.43	58.89	-22.48	36.40	46.00	-9.60	Peak	H
600.68	51.46	-20.92	30.55	46.00	-15.45	Peak	H

**Remark:**

1. No emission found between lowest internal used/generated frequency to 30MHz (9kHz~30MHz).
2. Radiated emissions measured in frequency range from 30 MHz to 1000MHz, were made with an instrument using peak/quasi-peak detector mode.
3. Quasi-peak test would be performed if the peak result were greater than the quasi-peak limit or as required by the applicant.
4. Measurements above show only up to 6 maximum emissions noted, or would be lesser, with " N/A " remark, if no specific emissions from the EUT are recorded (ie: margin>20dB from the applicable limit) and considered that's already beyond the background noise floor.
5. Margin (dB) = Remark result (dBuV/m) – Quasi-peak limit (dBuV/m).



**Above 1 GHz**

**Operation Mode:** Tx / CH Low                      **Test Date:** April 26, 2012

**Temperature:** 25°C                                      **Tested by:** Sehni Hu

**Humidity:** 50% RH                                      **Polarity:** Ver. / Hor.

Freq. (MHz)	Peak Reading (dBuV)	AV Reading (dBuV)	Ant. / CL CF (dB/m)	Result		Peak Limit (dBuV/m)	AV Limit (dBuV/m)	Margin (dB)	Remark	Ant. Pol H/V
				Peak (dBuV/m)	AV (dBuV/m)					
908.40	103.94	---	-16.01	87.93	---	94.00	---	-6.07	QP	V
1176.67	51.16	---	-10.89	40.27	---	74.00	54.00	-13.73	Peak	V
N/A										
908.40	99.34	---	-16.01	83.33	---	94.00	---	-10.67	QP	H
4925.00	49.51	33.13	2.81	52.32	35.94	74.00	54.00	-18.06	AVG	H
N/A										

**Remark:**

1. Measuring frequencies from 1 GHz to the 10th harmonic of highest fundamental frequency.
2. Radiated emissions measured in frequency above 1000MHz were made with an instrument using peak/average detector mode.
3. Average test would be performed if the peak result were greater than the average limit or as required by the applicant.
4. Data of measurement within this frequency range shown " --- " in the table above means the reading of emissions are attenuated more than 20dB below the permissible limits or the field strength is too small to be measured.
5. Measurements above show only up to 6 maximum emissions noted, or would be lesser, with " N/A " remark, if no specific emissions from the EUT are recorded (ie: margin > 20dB from the applicable limit) and considered that's already beyond the background noise floor.
6. Margin (dB) = Remark result (dBuV/m) – Average limit (dBuV/m). Peak detector mode and average detector mode of the emission shown in Result column.



### 7.3 POWERLINE CONDUCTED EMISSIONS

#### LIMIT

According to §15.207(a), except as shown in paragraphs (b) and (c) of this section, for an intentional radiator that is designed to be connected to the public utility (AC) power line, the radio frequency voltage that is conducted back onto the AC power line on any frequency or frequencies within the band 150 kHz to 30 MHz shall not exceed the limits in the following table, as measured using a 50  $\mu$ H/50 ohms line impedance stabilization network (LISN). Compliance with the provisions of this paragraph shall be based on the measurement of the radio frequency voltage between each power line and ground at the power terminal. The lower limit applies at the boundary between the frequency ranges.

Frequency Range (MHz)	Limits (dB $\mu$ V)	
	Quasi-peak	Average
0.15 to 0.50	66 to 56*	56 to 46*
0.50 to 5	56	46
5 to 30	60	50

\* Decreases with the logarithm of the frequency.

#### Test Configuration

See test photographs attached in Appendix I for the actual connections between EUT and support equipment.

#### TEST PROCEDURE

1. The EUT was placed on a table, which is 0.8m above ground plane.
2. Maximum procedure was performed on the six highest emissions to ensure EUT compliance.
3. Repeat above procedures until all frequency measured were complete.



## TEST RESULTS

The initial step in collecting conducted data is a spectrum analyzer peak scan of the measurement range. Significant peaks are then marked as shown on the following data page, and these signals are then quasi-peaked.

### Test Data

**Operation Mode:** Normal Link                      **Test Date:** March 29, 2012  
**Temperature:** 24°C                                      **Tested by:** Frank Liao  
**Humidity:** 60% RH

Frequency (MHz)	Reading (dBuV)	Factor (dB)	Result (dBuV)	Limit (dBuV)	Margin (dB)	Detector	Note
0.1500	47.24	10.29	57.53	65.99	-8.46	QP	L1
0.1500	35.34	10.29	45.63	55.99	-10.36	AVG	L1
0.1660	44.68	10.27	54.95	65.15	-10.20	QP	L1
0.1660	31.29	10.27	41.56	55.15	-13.59	AVG	L1
0.3780	36.46	10.14	46.60	58.32	-11.72	QP	L1
0.3780	24.62	10.14	34.76	48.32	-13.56	AVG	L1
2.3500	27.88	10.18	38.06	56.00	-17.94	QP	L1
2.3500	13.15	10.18	23.33	46.00	-22.67	AVG	L1
11.7940	33.58	10.34	43.92	60.00	-16.08	QP	L1
11.7940	24.10	10.34	34.44	50.00	-15.56	AVG	L1
29.8100	36.56	10.63	47.19	60.00	-12.81	QP	L1
29.8100	34.56	10.63	45.19	50.00	-4.81	AVG	L1
0.1500	47.12	10.65	57.77	65.99	-8.22	QP	L2
0.1500	35.30	10.65	45.95	55.99	-10.04	AVG	L2
0.3700	36.58	10.50	47.08	58.50	-11.42	QP	L2
0.3700	21.80	10.50	32.30	48.50	-16.20	AVG	L2
1.1460	26.50	10.52	37.02	56.00	-18.98	QP	L2
1.1460	14.69	10.52	25.21	46.00	-20.79	AVG	L2
2.3100	28.68	10.57	39.25	56.00	-16.75	QP	L2
2.3100	14.90	10.57	25.47	46.00	-20.53	AVG	L2
12.1459	33.67	10.71	44.38	60.00	-15.62	QP	L2
12.1459	24.43	10.71	35.14	50.00	-14.86	AVG	L2
29.8100	36.58	11.02	47.60	60.00	-12.40	QP	L2
29.8100	34.54	11.02	45.56	50.00	-4.44	AVG	L2

### **Remark:**

1. Measuring frequencies from 0.15 MHz to 30MHz.
2. The emissions measured in frequency range from 0.15 MHz to 30MHz were made with an instrument using Quasi-peak detector and average detector.
3. The IF bandwidth of SPN between 0.15MHz to 30MHz was 10kHz; the IF bandwidth of Test Receiver between 0.15MHz to 30MHz was 9kHz;
4. L1 = Line One (Live Line) / L2 = Line Two (Neutral Line)



**Test Plots**

**Conducted emissions (Line 1)**

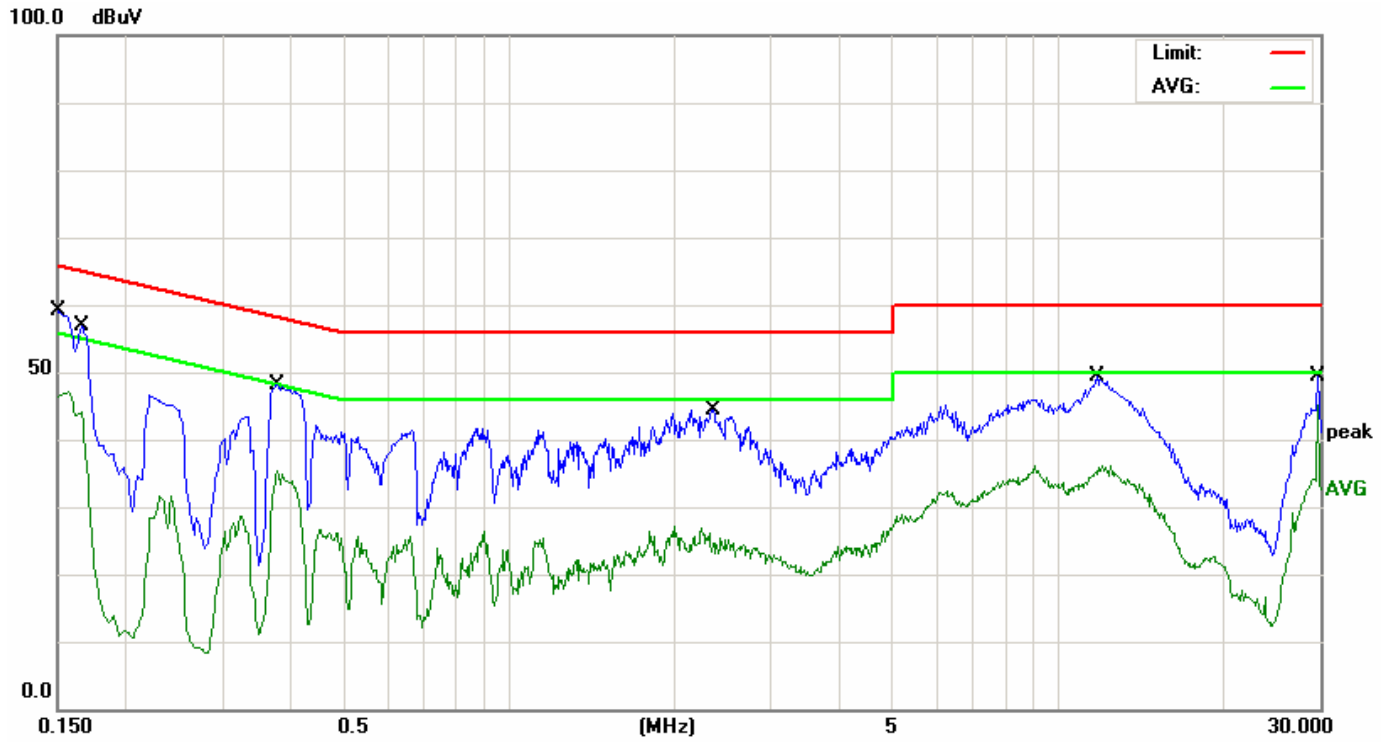

**Conducted emissions (Line 2)**

