

FCC Test Report

Product Name	VistaHub Wifi only
Model No.	VISTA HUB-WIFI
FCC ID.	RZ5-VISTA HUB-WIFI

Applicant	Onyx Healthcare Inc.
Address	2F., No.135, LANE 235, PAO CHIAO RD., XINDIAN DIST., NEW TAIPEI CITY 231, TAIWAN (R.O.C.)

Date of Receipt	Aug. 08, 2017
Issued Date	Dec. 07, 2017
Report No.	1790230R-RFUSP01V00
Report Version	V1.0



The test results relate only to the samples tested.

The test results shown in the test report are traceable to the national/international standard through the calibration report of the equipment and evaluated measurement uncertainty herein.

This report must not be used to claim product endorsement by TAF or any agency of the government.

The test report shall not be reproduced without the written approval of DEKRA Testing and Certification Co., Ltd.

Test Report

Issued Date: Dec. 07, 2017

Report No.: 1790230R-RFUSP01V00



Product Name	VistaHub Wifi only
Applicant	Onyx Healthcare Inc.
Address	2F., No.135, LANE 235, PAO CHIAO RD., XINDIAN DIST., NEW TAIPEI CITY 231, TAIWAN (R.O.C.)
Manufacturer	VitalConnect, Inc.
Model No.	VISTA HUB-WIFI
FCC ID.	RZ5-VISTA HUB-WIFI
EUT Rated Voltage	AC 100-240V, 50/60Hz
EUT Test Voltage	AC 120V/60Hz
Trade Name	VitalConnect
Applicable Standard	FCC CFR Title 47 Part 15 Subpart C: 2016 ANSI C63.4: 2014, ANSI C63.10: 2013
Test Result	Complied

Documented By :



(Senior Adm. Specialist / Genie Chang)

Tested By :

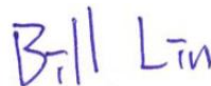

(Engineer / Bill Lin)

Approved By :



(Director / Vincent Lin)

TABLE OF CONTENTS

Description	Page
1. GENERAL INFORMATION	5
1.1. EUT Description.....	5
1.2. Operational Description.....	7
1.3. Tested System Details.....	8
1.4. Configuration of Tested System	8
1.5. EUT Exercise Software	9
1.6. Test Facility	10
1.7. List of Test Equipment.....	11
2. CONDUCTED EMISSION	12
2.1. Test Setup	12
2.2. Limits.....	12
2.3. Test Procedure	13
2.4. Uncertainty	13
2.5. Test Result of Conducted Emission.....	14
3. PEAK POWER OUTPUT	18
3.1. Test Setup	18
3.2. Limit	18
3.3. Test Procedure	18
3.4. Uncertainty	18
3.5. Test Result of Peak Power Output.....	19
4. RADIATED EMISSION	21
4.1. Test Setup	21
4.2. Limits.....	22
4.3. Test Procedure	23
4.4. Uncertainty	23
4.5. Test Result of Radiated Emission.....	24
5. RF ANTENNA CONDUCTED TEST	34
5.1. Test Setup	34
5.2. Limits.....	34
5.3. Test Procedure	34
5.4. Uncertainty	34
5.5. Test Result of RF Antenna Conducted Test.....	35
6. BAND EDGE	37
6.1. Test Setup	37
6.2. Limit	38
6.3. Test Procedure	38
6.4. Uncertainty	38
6.5. Test Result of Band Edge	39
7. CHANNEL NUMBER.....	51
7.1. Test Setup	51
7.2. Limit	51
7.3. Test Procedure	51
7.4. Uncertainty	51
7.5. Test Result of Channel Number.....	52
8. CHANNEL SEPARATION.....	54
8.1. Test Setup	54
8.2. Limit	54
8.3. Test Procedure	54
8.4. Uncertainty	54
8.5. Test Result of Channel Separation.....	55
9. DWELL TIME.....	59
9.1. Test Setup	59
9.2. Limit	59
9.3. Test Procedure	59
9.4. Uncertainty	59
9.5. Test Result of Dwell Time.....	60
10. OCCUPIED BANDWIDTH	64
10.1. Test Setup	64

10.2.	Limits.....	64
10.3.	Test Procedure	64
10.4.	Uncertainty	64
10.5.	Test Result of Occupied Bandwidth	65
11.	EMI REDUCTION METHOD DURING COMPLIANCE TESTING	69
Attachment 1: EUT Test Photographs		
Attachment 2: EUT Detailed Photographs		

1. GENERAL INFORMATION

1.1. EUT Description

Product Name	VistaHub Wifi only
Trade Name	VitalConnect
Model No.	VISTAHUB-WIFI
FCC ID.	RZ5-VISTAHUB-WIFI
Frequency Range	2402 – 2480MHz
Channel Number	79
Type of Modulation	FHSS: GFSK(1Mbps) / π /4DQPSK(2Mbps) / 8DPSK(3Mbps)
Antenna Type	Dipole
Channel Control	Auto
Antenna Gain	Refer to the table “Antenna List”
Power Adapter (1)	M/N: ATM020-W050U Input: AC 100-240V~50-60Hz 0.45-0.27A Output: DC 5V, 3.5A Cable Out: Non-shielded, 1.8m
Power Adapter (2)	M/N: ATM036T-A050 Input: AC 100-240V~50-60Hz 1A-0.45 Output: DC 5V, 5A Cable IN: Non-shielded, 1.8m Cable Out: Non-shielded, 1.5m

Antenna List

No.	Manufacturer	Part No.	Antenna Type	Peak Gain
1	ARISTOTLE	RFA-25-L14M3-B32	Dipole	2.5dBi for WLAN
2	ARISTOTLE	RFA-25-L14M3-B32	Dipole	2.5dBi for Bluetooth

Note: The antenna of EUT is conforming to FCC 15.203.

Center Frequency of Each Channel:

Channel	Frequency	Channel	Frequency	Channel	Frequency	Channel	Frequency
Channel 00:	2402 MHz	Channel 20:	2422 MHz	Channel 40:	2442 MHz	Channel 60:	2462 MHz
Channel 01:	2403 MHz	Channel 21:	2423 MHz	Channel 41:	2443 MHz	Channel 61:	2463 MHz
Channel 02:	2404 MHz	Channel 22:	2424 MHz	Channel 42:	2444 MHz	Channel 62:	2464 MHz
Channel 03:	2405 MHz	Channel 23:	2425 MHz	Channel 43:	2445 MHz	Channel 63:	2465 MHz
Channel 04:	2406 MHz	Channel 24:	2426 MHz	Channel 44:	2446 MHz	Channel 64:	2466 MHz
Channel 05:	2407 MHz	Channel 25:	2427 MHz	Channel 45:	2447 MHz	Channel 65:	2467 MHz
Channel 06:	2408 MHz	Channel 26:	2428 MHz	Channel 46:	2448 MHz	Channel 66:	2468 MHz
Channel 07:	2409 MHz	Channel 27:	2429 MHz	Channel 47:	2449 MHz	Channel 67:	2469 MHz
Channel 08:	2410 MHz	Channel 28:	2430 MHz	Channel 48:	2450 MHz	Channel 68:	2470 MHz
Channel 09:	2411 MHz	Channel 29:	2431 MHz	Channel 49:	2451 MHz	Channel 69:	2471 MHz
Channel 10:	2412 MHz	Channel 30:	2432 MHz	Channel 50:	2452 MHz	Channel 70:	2472 MHz
Channel 11:	2413 MHz	Channel 31:	2433 MHz	Channel 51:	2453 MHz	Channel 71:	2473 MHz
Channel 12:	2414 MHz	Channel 32:	2434 MHz	Channel 52:	2454 MHz	Channel 72:	2474 MHz
Channel 13:	2415 MHz	Channel 33:	2435 MHz	Channel 53:	2455 MHz	Channel 73:	2475 MHz
Channel 14:	2416 MHz	Channel 34:	2436 MHz	Channel 54:	2456 MHz	Channel 74:	2476 MHz
Channel 15:	2417 MHz	Channel 35:	2437 MHz	Channel 55:	2457 MHz	Channel 75:	2477 MHz
Channel 16:	2418 MHz	Channel 36:	2438 MHz	Channel 56:	2458 MHz	Channel 76:	2478 MHz
Channel 17:	2419 MHz	Channel 37:	2439 MHz	Channel 57:	2459 MHz	Channel 77:	2479 MHz
Channel 18:	2420 MHz	Channel 38:	2440 MHz	Channel 58:	2460 MHz	Channel 78:	2480 MHz
Channel 19:	2421 MHz	Channel 39:	2441 MHz	Channel 59:	2461 MHz		

Note:

1. The EUT is a VistaHub Wifi only with a 2.4GHz WLAN \ Bluetooth transceiver, this report for Bluetooth
2. These tests were conducted on a sample for the purpose of demonstrating compliance of Bluetooth transmitter with Part 15 Subpart C Paragraph 15.247 for spread spectrum devices.
3. Regarding to the operation frequency, the lowest, middle and highest frequency are selected to perform the test.
4. The radiation measurements are performed in X, Y, Z axis positioning. Only the worst case is shown in the report.
5. Bluetooth operation was evaluated at both 1Mb/s and 3Mb/s data rates. 2Mb/s data rate was found, through pre-testing, to produce emissions similar to those for 3Mb/s.

Test Mode	Mode 1: Transmit - 1Mbps Mode 2: Transmit - 3Mbps
-----------	--

1.3. Tested System Details

The types for all equipment, plus descriptions of all cables used in the tested system (including inserted cards) are:

Product	Manufacturer	Model No.	Serial No.	Power Cord	
1	Notebook PC	DELL	P62G	229FJC2	N/A
2	Monitor	DELL	U2415	CN-01RMGX-74261-63H-09UL-A02	N/A
3	USB 3.0	WD	WDBUZG0010BBK-PESN	WX11A166S2Y3	N/A
4	USB 3.0	WD	WDBUZG0010BBK-PESN	WXR1AC5478U6	N/A
5	Mouse	Logitech	U0026	N/A	N/A
6	Keyboard	Logitech	K120	N/A	N/A

Signal Cable Type	Signal cable Description
A	HDD USB 3.0 Cable
B	HDD USB 3.0 Cable
C	USB Keyboard Cable
D	USB Moue Cable
E	HDM Cable
F	USB Cable (Signal Cable)
G	USB Cable (Signal Cable)
H	LAB Cable

1.4. Configuration of Tested System

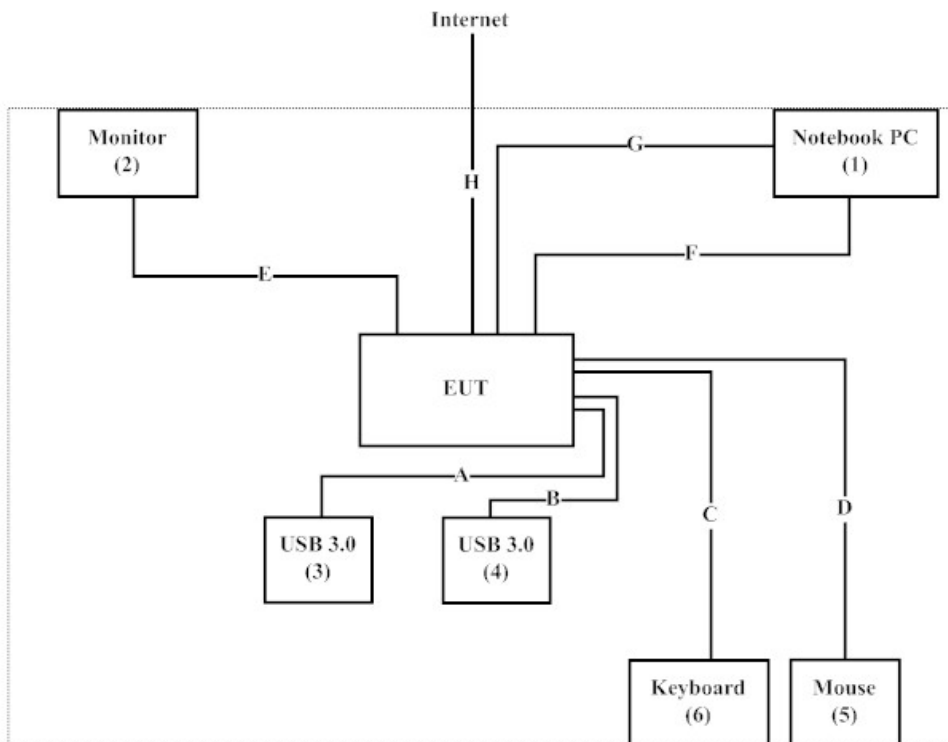

1.5. EUT Exercise Software

1. Setup the EUT as shown in Section 1.4.
2. Execute software “Blue Test3 (Ver 2.62)” on the EUT.
3. Configure the test mode, the test channel, and the data rate.
4. Press “OK” to start the continuous Transmit.
5. Verify that the EUT works properly.

1.6. Test Facility

Ambient conditions in the laboratory:

Items	Required (IEC 68-1)	Actual
Temperature (°C)	15-35	20-35
Humidity (%RH)	25-75	50-65
Barometric pressure (mbar)	860-1060	950-1000

The related certificate for our laboratories about the test site and management system can be downloaded from DEKRA Testing and Certification Co., Ltd. Web Site:

<http://www.dekra.com.tw/english/about/certificates.aspx?bval=5>

The address and introduction of DEKRA Testing and Certification Co., Ltd. laboratories can be founded in our Web site: http://www.dekra.com.tw/index_en

Site Description: Accredited by TAF
Accredited Number: 3023

Site Name: DEKRA Testing and Certification Co., Ltd.
Site Address: No.159, Sec. 2, Wenhua 1st Rd., Linkou Dist.,
New Taipei City 24457, Taiwan.
TEL: 886-2-2602-7968 / FAX : 866-2-2602-3286
E-Mail : info.tw@dekra.com

FCC Accreditation Number: TW3023

1.7. List of Test Equipment

For Conduction measurements /ASR1

	Equipment	Manufacturer	Model No.	Serial No.	Cali. Data	Due. Data
X	EMI Test Receiver	R&S	ESR7	161601	2017.01.06	2018.01.05
X	Two-Line V-Network	R&S	ENV216	101306	2017.02.16	2018.02.15
X	Two-Line V-Network	R&S	ENV216	101307	2017.03.17	2018.03.16
X	Coaxial Cable	Quietek	RG400_BNC	RF001	2017.05.24	2018.05.23

Note:

1. All equipments are calibrated every one year.
2. The test instruments marked with "X" are used to measure the final test results.
3. Test Software version : QuieTek EMI 2.0 V2.1.113

For Conducted measurements /ASR4

	Equipment	Manufacturer	Model No.	Serial No.	Cali. Data	Due. Data
X	Spectrum Analyzer	R&S	FSV30	103464	2017.01.09	2018.01.08
X	Power Meter	Anritsu	ML2496A	1548003	2016.12.15	2017.12.14
X	Power Sensor	Anritsu	MA2411B	1531024	2016.12.15	2017.12.14
X	Power Sensor	Anritsu	MA2411B	1531025	2016.12.15	2017.12.14
	Bluetooth Tester	R&S	CBT	101238	2017.01.03	2018.01.02

Note:

1. All equipments are calibrated every one year.
2. The test instruments marked with "X" are used to measure the final test results.
3. Test Software version : QuieTek Conduction Test System V8.0.110

For Radiated measurements /ACB1

	Equipment	Manufacturer	Model No.	Serial No.	Cali. Data	Due. Data
X	Loop Antenna	TESEQ	HLA6121	37133	2017.10.13	2018.10.12
X	Bi-Log Antenna	SCHWARZBECK	VULB9168	9168-674	2017.02.09	2018.02.08
X	Horn Antenna	ETS-Lindgren	3117	00203761	2017.10.25	2018.10.24
X	Horn Antenna	Com-Power	AH-840	101087	2017.05.24	2018.05.23
X	Pre-Amplifier	EMCI	EMC001330	980316	2017.05.14	2018.05.13
X	Pre-Amplifier	EMCI	EMC051835SE	980311	2017.05.15	2018.05.14
X	Pre-Amplifier	EMCI	EMC05820SE	980310	2017.05.15	2018.05.14
X	Pre-Amplifier	EMCI	EMC184045SE	980314	2017.05.17	2018.05.16
X	Filter	MICRO TRONICS	BRM50702	G249	2017.08.11	2018.08.10
	Filter	MICRO TRONICS	BRM50716	G187	2017.08.16	2018.08.15
X	EMI Test Receiver	R&S	ESR7	101602	2016.12.15	2017.12.14
X	Spectrum Analyzer	R&S	FSV40	101148	2017.01.24	2018.01.23
X	Coaxial Cable	SUHNER	SUCOFLEX 106	RF002	2017.05.25	2018.05.24
X	Mircoflex Cable	HUBER SUHNER	SUCOFLEX 102	MY3381/2	2017.08.11	2018.08.10

Note:

1. Loop Antenna is calibrated every two year, the other equipments are calibrated every one year.
2. The test instruments marked with "X" are used to measure the final test results.
3. Test Software version : QuieTek EMI 2.0 V2.1.113

2. Conducted Emission

2.1. Test Setup

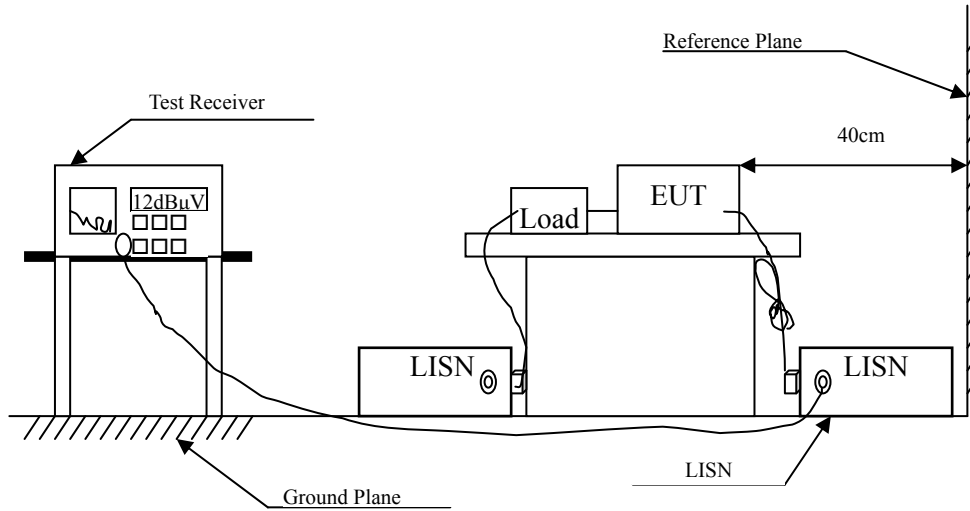

2.2. Limits

FCC Part 15 Subpart C Paragraph 15.207 (dB μ V) Limit		
Frequency MHz	Limits	
	QP	AV
0.15 - 0.50	66-56	56-46
0.50-5.0	56	46
5.0 - 30	60	50

Remarks: In the above table, the tighter limit applies at the band edges.

2.3. Test Procedure

The EUT and Peripherals are connected to the main power through a line impedance stabilization network (L.I.S.N.). This provides a 50 ohm /50uH coupling impedance for the measuring equipment. The peripheral devices are also connected to the main power through a LISN that provides a 50ohm /50uH coupling impedance with 50ohm termination. (Please refer to the block diagram of the test setup and photographs.)

Both sides of A.C. line are checked for maximum conducted interference. In order to find the maximum emission, the relative positions of equipment and all the interface cables must be changed according to ANSI C63.4: 2014 on conducted measurement.

Conducted emissions were investigated over the frequency range from 0.15MHz to 30MHz using a receiver bandwidth of 9kHz.

The EUT was setup to ANSI C63.4, 2014; tested to FHSS test procedure of FCC Public Notice DA 00-705 for compliance to FCC 47CFR 15.247 requirements.

2.4. Uncertainty

±2.35dB

2.5. Test Result of Conducted Emission

Product : VistaHub Wifi only
 Test Item : Conducted Emission Test
 Power Line : Line 1
 Test Mode : Mode 2: Transmit - 3Mbps (2441MHz)_ Adapter: ATM020-W050U
 Test Date : 2017/10/02

Frequency MHz	Correct Factor dB	Reading Level dB μ V	Measurement Level dB μ V	Margin dB	Limit dB μ V
LINE 1					
Quasi-Peak					
0.153	9.561	39.270	48.830	-17.084	65.914
0.170	9.560	36.846	46.406	-19.023	65.429
0.604	9.580	36.013	45.593	-10.407	56.000
2.300	9.583	34.453	44.036	-11.964	56.000
2.663	9.587	29.140	38.727	-17.273	56.000
2.974	9.590	27.963	37.553	-18.447	56.000
Average					
0.153	9.561	27.418	36.978	-18.936	55.914
0.170	9.560	25.415	34.975	-20.454	55.429
0.604	9.580	28.034	37.614	-8.386	46.000
2.300	9.583	27.482	37.065	-8.935	46.000
2.663	9.587	23.999	33.586	-12.414	46.000
2.974	9.590	21.229	30.819	-15.181	46.000

Note:

1. All Reading Levels are Quasi-Peak and average value.
2. "■" means the worst emission level.
3. Measurement Level = Reading Level + Correct Factor

Product : VistaHub Wifi only
 Test Item : Conducted Emission Test
 Power Line : Line 2
 Test Mode : Mode 2: Transmit - 3Mbps (2441MHz) _ Adapter: ATM020-W050U
 Test Date : 2017/10/02

Frequency MHz	Correct Factor dB	Reading Level dB μ V	Measurement Level dB μ V	Margin dB	Limit dB μ V
LINE 2					
Quasi-Peak					
0.157	9.552	38.290	47.841	-17.959	65.800
0.206	9.560	32.048	41.607	-22.793	64.400
0.600	9.575	33.795	43.369	-12.631	56.000
2.300	9.583	34.008	43.591	-12.409	56.000
2.672	9.587	29.148	38.735	-17.265	56.000
2.976	9.590	27.717	37.307	-18.693	56.000
Average					
0.157	9.552	25.307	34.859	-20.941	55.800
0.206	9.560	20.952	30.511	-23.889	54.400
0.600	9.575	25.303	34.877	-11.123	46.000
2.300	9.583	28.063	37.646	-8.354	46.000
2.672	9.587	23.382	32.969	-13.031	46.000
2.976	9.590	20.911	30.501	-15.499	46.000

Note:

1. All Reading Levels are Quasi-Peak and average value.
2. "█" means the worst emission level.
3. Measurement Level = Reading Level + Correct Factor

Product : VistaHub Wifi only
 Test Item : Conducted Emission Test
 Power Line : Line 1
 Test Mode : Mode 2: Transmit - 3Mbps (2441MHz)_ Adapter: ATM036T-A050
 Test Date : 2017/10/02

Frequency MHz	Correct Factor dB	Reading Level dB μ V	Measurement Level dB μ V	Margin dB	Limit dB μ V
LINE 1					
Quasi-Peak					
0.160	9.560	26.483	36.043	-29.671	65.714
0.390	9.572	31.795	41.367	-17.776	59.143
2.346	9.583	37.242	46.825	-9.175	56.000
2.700	9.587	31.090	40.677	-15.323	56.000
3.000	9.590	28.070	37.660	-18.340	56.000
3.364	9.594	25.242	34.836	-21.164	56.000
Average					
0.160	9.560	18.525	28.085	-27.629	55.714
0.390	9.572	23.645	33.218	-15.925	49.143
2.346	9.583	30.058	39.641	-6.359	46.000
2.700	9.587	24.395	33.982	-12.018	46.000
3.000	9.590	21.858	31.448	-14.552	46.000
3.364	9.594	17.751	27.345	-18.655	46.000

Note:

1. All Reading Levels are Quasi-Peak and average value.
2. "■" means the worst emission level.
3. Measurement Level = Reading Level + Correct Factor

Product : VistaHub Wifi only
 Test Item : Conducted Emission Test
 Power Line : Line 2
 Test Mode : Mode 2: Transmit - 3Mbps (2441MHz) _ Adapter: ATM036T-A050
 Test Date : 2017/10/02

Frequency MHz	Correct Factor dB	Reading Level dB μ V	Measurement Level dB μ V	Margin dB	Limit dB μ V
LINE 2					
Quasi-Peak					
0.157	9.552	31.003	40.555	-25.245	65.800
0.390	9.567	32.524	42.091	-17.052	59.143
2.340	9.583	36.043	45.626	-10.374	56.000
2.700	9.587	31.228	40.815	-15.185	56.000
2.979	9.590	29.266	38.856	-17.144	56.000
3.400	9.594	23.675	33.269	-22.731	56.000
Average					
0.157	9.552	20.295	29.847	-25.953	55.800
0.390	9.567	24.835	34.402	-14.741	49.143
2.340	9.583	29.596	39.179	-6.821	46.000
2.700	9.587	23.908	33.495	-12.505	46.000
2.979	9.590	22.408	31.998	-14.002	46.000
3.400	9.594	16.367	25.961	-20.039	46.000

Note:

1. All Reading Levels are Quasi-Peak and average value.
2. "█" means the worst emission level.
3. Measurement Level = Reading Level + Correct Factor

3. Peak Power Output

3.1. Test Setup

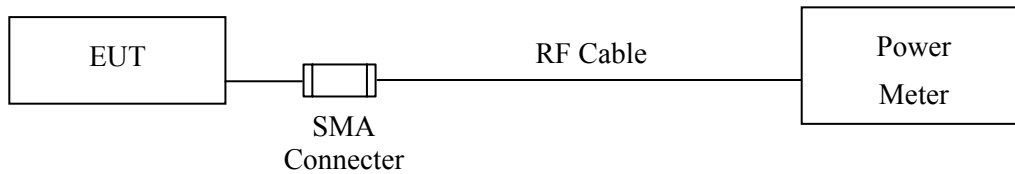

3.2. Limit

The maximum peak power shall be less 1Watt.

3.3. Test Procedure

The EUT was setup to ANSI C63.4, 2014; tested to FHSS test procedure of FCC Public Notice DA 00-705 for compliance to FCC 47CFR 15.247 requirements.

3.4. Uncertainty

± 0.86 dB

3.5. Test Result of Peak Power Output

Product : VistaHub Wifi only
Test Item : Peak Power Output
Test Mode : Mode 1: Transmit - 1Mbps
Test Date : 2017/09/20

Channel No.	Frequency (MHz)	Measurement (dBm)	Required Limit	Result
Channel 00	2402.00	6.6	1 Watt= 30 dBm	Pass
Channel 39	2441.00	7.7	1 Watt= 30 dBm	Pass
Channel 78	2480.00	7.8	1 Watt= 30 dBm	Pass

Product : VistaHub Wifi only
Test Item : Peak Power Output
Test Mode : Mode 2: Transmit - 3Mbps
Test Date : 2017/09/20

Channel No.	Frequency (MHz)	Measurement (dBm)	Required Limit	Result
Channel 00	2402.00	5.2	1 Watt= 30 dBm	Pass
Channel 39	2441.00	6.5	1 Watt= 30 dBm	Pass
Channel 78	2480.00	6.5	1 Watt= 30 dBm	Pass

4. Radiated Emission

4.1. Test Setup

Radiated Emission Under 30MHz

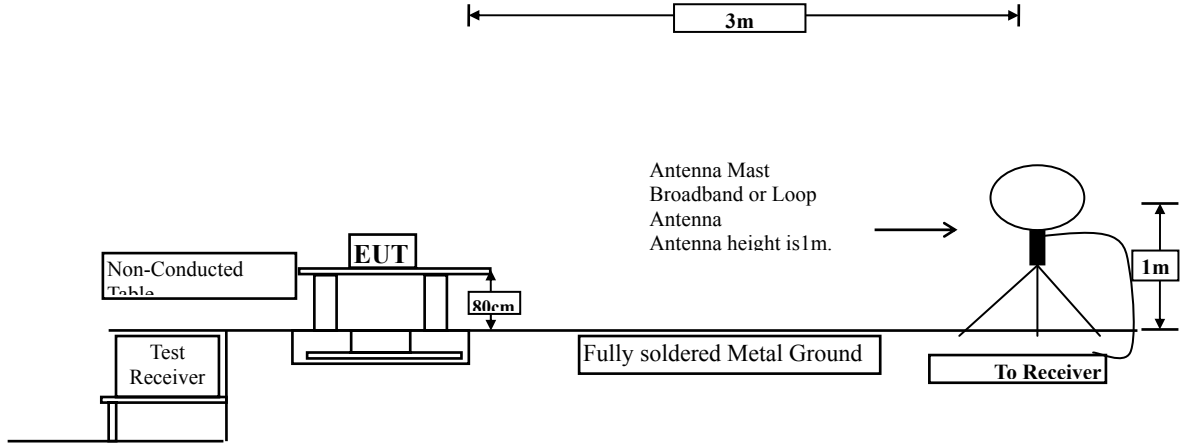

Radiated Emission Below 1GHz

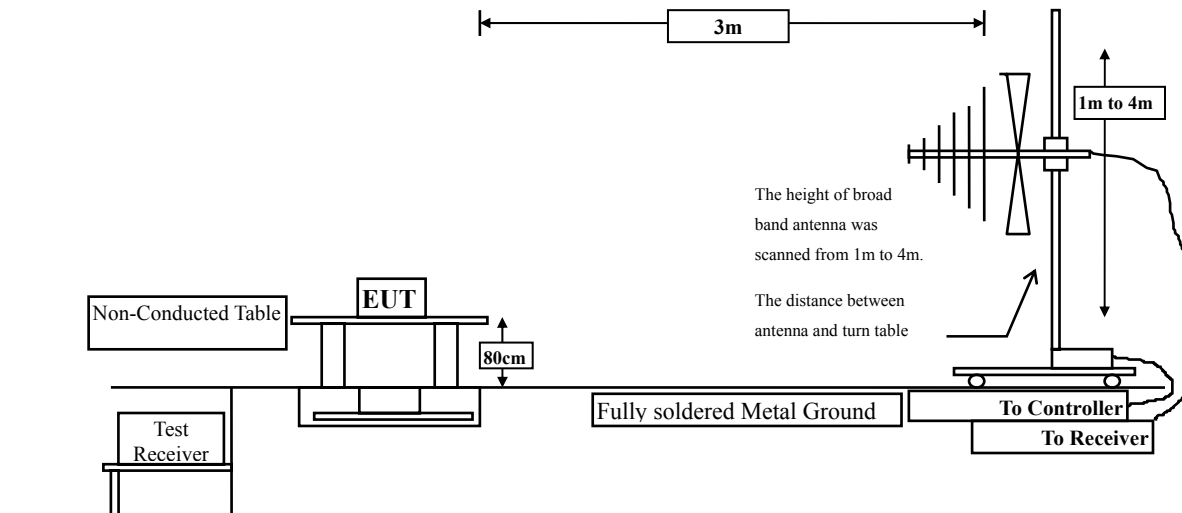

Radiated Emission Above 1GHz

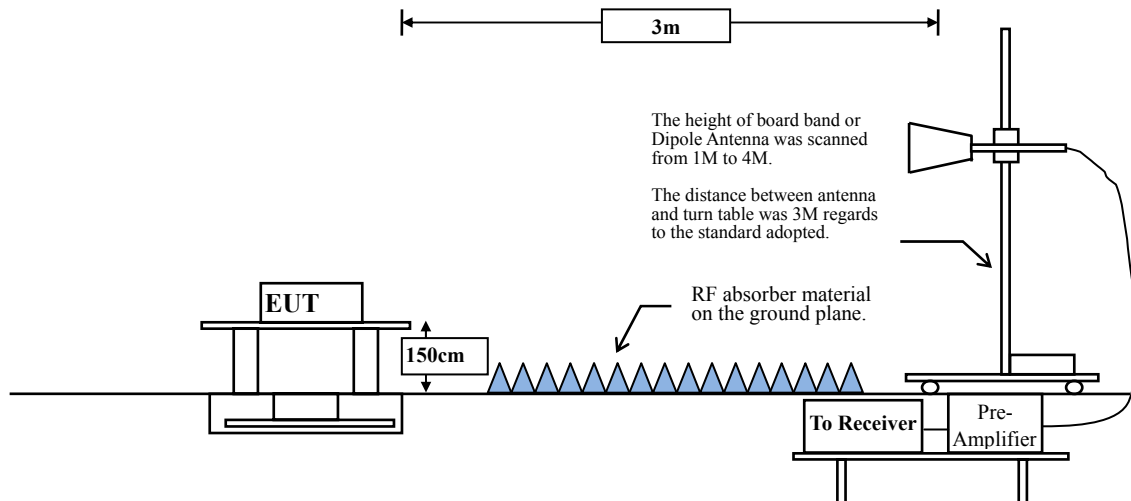

4.2. Limits

➤ General Radiated Emission Limits

Emissions radiated outside of the specified frequency bands, except for harmonics, shall be attenuated by at least 20dB below the level of the fundamental or to the general radiated emission limits in paragraph 15.209, whichever is the lesser attenuation.

FCC Part 15 Subpart C Paragraph 15.209 Limits		
Frequency MHz	Field strength (microvolts/meter)	Measurement distance (meter)
0.009-0.490	2400/F(kHz)	300
0.490-1.705	24000/F(kHz)	30
1.705-30	30	30
30-88	100	3
88-216	150	3
216-960	200	3
Above 960	500	3

- Remarks:
1. RF Voltage (dBuV) = 20 log RF Voltage (uV)
 2. In the Above Table, the tighter limit applies at the band edges.
 3. Distance refers to the distance in meters between the measuring instrument antenna and the closed point of any part of the device or system.

4.3. Test Procedure

The EUT was setup according to ANSI C63.10, 2013 and tested compliance to FCC 47CFR 15.247 requirements.

Measuring the frequency range below 1GHz, the EUT is placed on a turn table which is 0.8 meter above ground, when measuring the frequency range above 1GHz, the EUT is placed on a turn table which is 1.5 meter above ground.

The turn table is rotated 360 degrees to determine the position of the maximum emission level.

The EUT was positioned such that the distance from antenna to the EUT was 3 meters.

The antenna is scanned between 1 meter and 4 meters to find out the maximum emission level. This is repeated for both horizontal and vertical polarization of the antenna. In order to find the maximum emission, all of the interface cables were manipulated according to ANSI C63.10: 2013 on radiated measurement.

The resolution bandwidth below 30MHz setting on the field strength meter is 9kHz and 30MHz~1GHz is 120kHz and above 1GHz is 1MHz.

Radiated emission measurements below 30MHz are made using Loop Antenna and 30MHz~1GHz are made using broadband Bilog antenna and above 1GHz are made using Horn Antennas.

The measurement is divided into the Preliminary Measurement and the Final Measurement.

The suspected frequencies are searched for in Preliminary Measurement with the measurement antenna kept pointed at the source of the emission both in azimuth and elevation, with the polarization of the antenna oriented for maximum response. The antenna is pointed at an angle towards the source of the emission, and the EUT is rotated in both height and polarization to maximize the measured emission. The emission is kept within the illumination area of the 3 dB bandwidth of the antenna.

The measurement frequency range from 9kHz - 10th Harmonic of fundamental was investigated.

4.4. Uncertainty

Horizontal polarization :

30-300MHz: ± 4.08 dB ; 300M-1GHz: ± 3.86 dB ; 1-18GHz: ± 3.77 dB ; 18-40GHz: ± 3.98 dB

Vertical polarization :

30-300MHz: ± 4.81 dB ; 300M-1GHz: ± 3.87 dB ; 1-18GHz : ± 3.83 dB ; 18-40GHz: ± 3.98 dB

4.5. Test Result of Radiated Emission

Product : VistaHub Wifi only
 Test Item : Harmonic Radiated Emission
 Test Mode : Mode 1: Transmit - 1Mbps(2402MHz)_Adapter: ATM020-W050U
 Test Date : 2017/11/26

Frequency MHz	Correct Factor dB	Reading Level dB μ V	Measurement Level dB μ V/m	Margin dB	Limit dB μ V/m
Horizontal					
Peak Detector:					
4804.000	-6.114	50.800	44.686	-29.314	74.000
7206.000	-3.112	46.530	43.418	-30.582	74.000
9608.000	-0.801	44.630	43.830	-30.170	74.000
Average Detector:					
--					54.000
Vertical					
Peak Detector:					
4804.000	-6.114	50.430	44.316	-29.684	74.000
7206.000	-3.112	47.910	44.798	-29.202	74.000
9608.000	-0.801	43.200	42.400	-31.600	74.000
Average Detector:					
--					54.000

Note:

- All Readings below 1GHz are Quasi-Peak, above 1GHz are performed with peak and/or average measurements as necessary.
- Peak measurements: RBW = 1MHz, VBW = 3 MHz, Sweep: Auto.
- Average measurements: RBW = 1MHz, VBW = 10 Hz, Sweep: Auto.
- Measurement Level = Reading Level + Correct Factor.
- Correct Factor = Antenna factor + Cable loss – Amplifier gain.
- The average measurement was not performed when the peak measured data under the limit of average detection.
- The emission levels of other frequencies are very lower than the limit and not show in test report.

Product : VistaHub Wifi only
 Test Item : Harmonic Radiated Emission
 Test Mode : Mode 1: Transmit - 1Mbps(2441MHz)_Adapter: ATM020-W050U
 Test Date : 2017/11/26

Frequency MHz	Correct Factor dB	Reading Level dB μ V	Measurement Level dB μ V/m	Margin dB	Limit dB μ V/m
Horizontal					
Peak Detector:					
4882.000	-6.066	49.850	43.784	-30.216	74.000
7323.000	-3.022	48.310	45.288	-28.712	74.000
9764.000	-0.522	46.350	45.827	-28.173	74.000
Average Detector:					
--					54.000
Vertical					
Peak Detector:					
4882.000	-6.066	50.920	44.854	-29.146	74.000
7323.000	-3.022	48.020	44.998	-29.002	74.000
9764.000	-0.522	45.000	44.477	-29.523	74.000
Average Detector:					
--					54.000

Note:

1. All Readings below 1GHz are Quasi-Peak, above 1GHz are performed with peak and/or average measurements as necessary.
2. Peak measurements: RBW = 1MHz, VBW = 3 MHz, Sweep: Auto.
3. Average measurements: RBW = 1MHz, VBW = 10 Hz, Sweep: Auto.
4. Measurement Level = Reading Level + Correct Factor.
5. Correct Factor = Antenna factor + Cable loss – Amplifier gain.
6. The average measurement was not performed when the peak measured data under the limit of average detection.
7. The emission levels of other frequencies are very lower than the limit and not show in test report.

Product : VistaHub Wifi only
 Test Item : Harmonic Radiated Emission
 Test Mode : Mode 1: Transmit - 1Mbps(2480MHz)_Adapter: ATM020-W050U
 Test Date : 2017/11/26

Frequency MHz	Correct Factor dB	Reading Level dB μ V	Measurement Level dB μ V/m	Margin dB	Limit dB μ V/m
Horizontal					
Peak Detector:					
4960.000	-6.055	53.140	47.085	-26.915	74.000
7440.000	-2.861	50.670	47.808	-26.192	74.000
9920.000	-0.306	45.250	44.944	-29.056	74.000
Average Detector:					
--					54.000
Vertical					
Peak Detector:					
4960.000	-6.055	54.140	48.085	-25.915	74.000
7440.000	-2.861	48.740	45.878	-28.122	74.000
9920.000	-0.306	45.640	45.334	-28.666	74.000
Average Detector:					
--					54.000

Note:

1. All Readings below 1GHz are Quasi-Peak, above 1GHz are performed with peak and/or average measurements as necessary.
2. Peak measurements: RBW = 1MHz, VBW = 3 MHz, Sweep: Auto.
3. Average measurements: RBW = 1MHz, VBW = 10 Hz, Sweep: Auto.
4. Measurement Level = Reading Level + Correct Factor.
5. Correct Factor = Antenna factor + Cable loss – Amplifier gain.
6. The average measurement was not performed when the peak measured data under the limit of average detection.
7. The emission levels of other frequencies are very lower than the limit and not show in test report.

Product : VistaHub Wifi only
 Test Item : Harmonic Radiated Emission
 Test Mode : Mode 2: Transmit - 3Mbps(2402MHz)_Adapter: ATM020-W050U
 Test Date : 2017/11/26

Frequency MHz	Correct Factor dB	Reading Level dBμV	Measurement Level dBμV/m	Margin dB	Limit dBμV/m
Horizontal					
Peak Detector:					
4804.000	-6.114	48.920	42.806	-31.194	74.000
7206.000	-3.112	46.050	42.938	-31.062	74.000
9608.000	-0.801	43.890	43.090	-30.910	74.000
Average Detector:					
--					54.000
Vertical					
Peak Detector:					
4804.000	-6.114	48.880	42.766	-31.234	74.000
7206.000	-3.112	47.680	44.568	-29.432	74.000
9608.000	-0.801	45.420	44.620	-29.380	74.000
Average Detector:					
--					54.000

Note:

1. All Readings below 1GHz are Quasi-Peak, above 1GHz are performed with peak and/or average measurements as necessary.
2. Peak measurements: RBW = 1MHz, VBW = 3 MHz, Sweep: Auto.
3. Average measurements: RBW = 1MHz, VBW = 10 Hz, Sweep: Auto.
4. Measurement Level = Reading Level + Correct Factor.
5. Correct Factor = Antenna factor + Cable loss – Amplifier gain.
6. The average measurement was not performed when the peak measured data under the limit of average detection.
7. The emission levels of other frequencies are very lower than the limit and not show in test report.

Product : VistaHub Wifi only
 Test Item : Harmonic Radiated Emission
 Test Mode : Mode 2: Transmit - 3Mbps (2441MHz)_Adapter: ATM020-W050U
 Test Date : 2017/11/26

Frequency MHz	Correct Factor dB	Reading Level dBµV	Measurement Level dBµV/m	Margin dB	Limit dBµV/m
Horizontal					
Peak Detector:					
4882.000	-6.066	49.410	43.344	-30.656	74.000
7323.000	-3.022	47.070	44.048	-29.952	74.000
9764.000	-0.522	44.170	43.647	-30.353	74.000
Average Detector:					
--					54.000
Vertical					
Peak Detector:					
4882.000	-6.066	49.480	43.414	-30.586	74.000
7323.000	-3.022	44.870	41.848	-32.152	74.000
9764.000	-0.522	46.020	45.497	-28.503	74.000
Average Detector:					
--					54.000

Note:

1. All Readings below 1GHz are Quasi-Peak, above 1GHz are performed with peak and/or average measurements as necessary.
2. Peak measurements: RBW = 1MHz, VBW = 3 MHz, Sweep: Auto.
3. Average measurements: RBW = 1MHz, VBW = 10 Hz, Sweep: Auto.
4. Measurement Level = Reading Level + Correct Factor.
5. Correct Factor = Antenna factor + Cable loss – Amplifier gain.
6. The average measurement was not performed when the peak measured data under the limit of average detection.
7. The emission levels of other frequencies are very lower than the limit and not show in test report.

Product : VistaHub Wifi only
 Test Item : Harmonic Radiated Emission
 Test Mode : Mode 2: Transmit - 3Mbps (2480MHz)_Adapter: ATM020-W050U
 Test Date : 2017/11/26

Frequency MHz	Correct Factor dB	Reading Level dB μ V	Measurement Level dB μ V/m	Margin dB	Limit dB μ V/m
Horizontal					
Peak Detector:					
4960.000	-6.055	50.480	44.425	-29.575	74.000
7440.000	-2.861	46.810	43.948	-30.052	74.000
9920.000	-0.306	43.870	43.564	-30.436	74.000
Average Detector:					
--					54.000
Vertical					
Peak Detector:					
4960.000	-6.055	52.170	46.115	-27.885	74.000
7440.000	-2.861	46.870	44.008	-29.992	74.000
9920.000	-0.306	44.240	43.934	-30.066	74.000
Average Detector:					
--					54.000

Note:

1. All Readings below 1GHz are Quasi-Peak, above 1GHz are performed with peak and/or average measurements as necessary.
2. Peak measurements: RBW = 1MHz, VBW = 3 MHz, Sweep: Auto.
3. Average measurements: RBW = 1MHz, VBW = 10 Hz, Sweep: Auto.
4. Measurement Level = Reading Level + Correct Factor.
5. Correct Factor = Antenna factor + Cable loss – Amplifier gain.
6. The average measurement was not performed when the peak measured data under the limit of average detection.
7. The emission levels of other frequencies are very lower than the limit and not show in test report.

Product : VistaHub Wifi only
 Test Item : General Radiated Emission
 Test Mode : Mode 1: Transmit - 1Mbps (2441MHz)_Adapter: ATM020-W050U
 Test Date : 2017/10/03

Frequency MHz	Correct Factor dB	Reading Level dBµV	Measurement Level dBµV/m	Margin dB	Limit dBµV/m
Horizontal					
184.638	-12.729	53.027	40.299	-3.201	43.500
238.058	-11.986	53.586	41.600	-4.400	46.000
399.725	-7.349	49.744	42.395	-3.605	46.000
616.217	-2.930	41.036	38.106	-7.894	46.000
770.855	-0.656	45.401	44.744	-1.256	46.000
924.087	1.169	43.410	44.578	-1.422	46.000
Vertical					
38.435	-11.273	50.048	38.775	-1.225	40.000
186.043	-12.887	53.594	40.707	-2.793	43.500
399.725	-7.349	50.670	43.321	-2.679	46.000
533.275	-4.610	45.638	41.028	-4.972	46.000
770.855	-0.656	45.309	44.652	-1.348	46.000
924.087	1.169	43.689	44.857	-1.143	46.000

Note:

1. All Readings below 1GHz are Quasi-Peak, above 1GHz are performed with peak and/or average measurements as necessary.
2. Peak measurements: RBW = 1MHz, VBW = 3 MHz, Sweep: Auto.
3. Average measurements: RBW = 1MHz, VBW = 10 Hz, Sweep: Auto.
4. Measurement Level = Reading Level + Correct Factor.
5. Correct Factor = Antenna factor + Cable loss – Amplifier gain.
6. The average measurement was not performed when the peak measured data under the limit of average detection.
7. The emission levels of other frequencies are very lower than the limit and not show in test report.
8. No emission found between lowest internal used/generated frequency to 30MHz.

Product : VistaHub Wifi only
 Test Item : General Radiated Emission
 Test Mode : Mode 2: Transmit - 3Mbps (2441MHz)_Adapter: ATM020-W050U
 Test Date : 2017/10/03

Frequency MHz	Correct Factor dB	Reading Level dB μ V	Measurement Level dB μ V/m	Margin dB	Limit dB μ V/m
Horizontal					
132.623	-11.694	46.604	34.910	-8.590	43.500
184.638	-12.729	52.419	39.691	-3.809	43.500
399.725	-7.349	50.219	42.870	-3.130	46.000
609.188	-2.989	37.637	34.648	-11.352	46.000
770.855	-0.656	39.092	38.435	-7.565	46.000
924.087	1.169	40.558	41.726	-4.274	46.000
Vertical					
30.000	-12.125	51.392	39.267	-0.733	40.000
181.826	-12.407	51.253	38.845	-4.655	43.500
399.725	-7.349	46.094	38.745	-7.255	46.000
533.275	-4.610	44.773	40.163	-5.837	46.000
616.217	-2.930	43.345	40.415	-5.585	46.000
924.087	1.169	43.715	44.883	-1.117	46.000

Note:

1. All Readings below 1GHz are Quasi-Peak, above 1GHz are performed with peak and/or average measurements as necessary.
2. Peak measurements: RBW = 1MHz, VBW = 3 MHz, Sweep: Auto.
3. Average measurements: RBW = 1MHz, VBW = 10 Hz, Sweep: Auto.
4. Measurement Level = Reading Level + Correct Factor.
5. Correct Factor = Antenna factor + Cable loss – Amplifier gain.
6. The average measurement was not performed when the peak measured data under the limit of average detection.
7. The emission levels of other frequencies are very lower than the limit and not show in test report.
8. No emission found between lowest internal used/generated frequency to 30MHz.

Product : VistaHub Wifi only
 Test Item : General Radiated Emission
 Test Mode : Mode 1: Transmit - 1Mbps (2441MHz)_Adapter: ATM036T-A050
 Test Date : 2017/11/24

Frequency MHz	Correct Factor dB	Reading Level dBµV	Measurement Level dBµV/m	Margin dB	Limit dBµV/m
Horizontal					
79.470	-15.522	50.850	35.327	-4.673	40.000
195.870	-13.723	50.977	37.254	-6.246	43.500
399.570	-8.084	51.602	43.518	-2.482	46.000
600.360	-4.053	37.410	33.357	-12.643	46.000
800.180	-1.714	43.576	41.861	-4.139	46.000
960.230	0.354	40.686	41.040	-12.960	54.000
Vertical					
32.910	-12.011	51.779	39.769	-0.231	40.000
247.280	-12.158	51.302	39.144	-6.856	46.000
399.570	-8.084	44.561	36.477	-9.523	46.000
600.360	-4.053	34.380	30.327	-15.673	46.000
800.180	-1.714	39.249	37.534	-8.466	46.000
960.230	0.354	38.170	38.524	-15.476	54.000

Note:

1. All Readings below 1GHz are Quasi-Peak, above 1GHz are performed with peak and/or average measurements as necessary.
2. Peak measurements: RBW = 1MHz, VBW = 3 MHz, Sweep: Auto.
3. Average measurements: RBW = 1MHz, VBW = 10 Hz, Sweep: Auto.
4. Measurement Level = Reading Level + Correct Factor.
5. Correct Factor = Antenna factor + Cable loss – Amplifier gain.
6. The average measurement was not performed when the peak measured data under the limit of average detection.
7. The emission levels of other frequencies are very lower than the limit and not show in test report.
8. No emission found between lowest internal used/generated frequency to 30MHz.

Product : VistaHub Wifi only
 Test Item : General Radiated Emission
 Test Mode : Mode 2: Transmit - 3Mbps (2441MHz)_Adapter: ATM036T-A050
 Test Date : 2017/11/24

Frequency MHz	Correct Factor dB	Reading Level dB μ V	Measurement Level dB μ V/m	Margin dB	Limit dB μ V/m
Horizontal					
143.490	-11.322	50.494	39.172	-4.328	43.500
262.800	-11.808	44.701	32.893	-13.107	46.000
399.570	-8.084	52.218	44.134	-1.866	46.000
600.360	-4.053	40.217	36.164	-9.836	46.000
800.180	-1.714	45.140	43.425	-2.575	46.000
960.230	0.354	41.140	41.494	-12.506	54.000
Vertical					
32.910	-12.011	50.151	38.141	-1.859	40.000
235.640	-12.575	52.184	39.609	-6.391	46.000
399.570	-8.084	42.574	34.490	-11.510	46.000
600.360	-4.053	36.089	32.036	-13.964	46.000
800.180	-1.714	39.544	37.829	-8.171	46.000
960.230	0.354	38.692	39.046	-14.954	54.000

Note:

1. All Readings below 1GHz are Quasi-Peak, above 1GHz are performed with peak and/or average measurements as necessary.
2. Peak measurements: RBW = 1MHz, VBW = 3 MHz, Sweep: Auto.
3. Average measurements: RBW = 1MHz, VBW = 10 Hz, Sweep: Auto.
4. Measurement Level = Reading Level + Correct Factor.
5. Correct Factor = Antenna factor + Cable loss – Amplifier gain.
6. The average measurement was not performed when the peak measured data under the limit of average detection.
7. The emission levels of other frequencies are very lower than the limit and not show in test report.
8. No emission found between lowest internal used/generated frequency to 30MHz.

5. RF Antenna Conducted Test

5.1. Test Setup

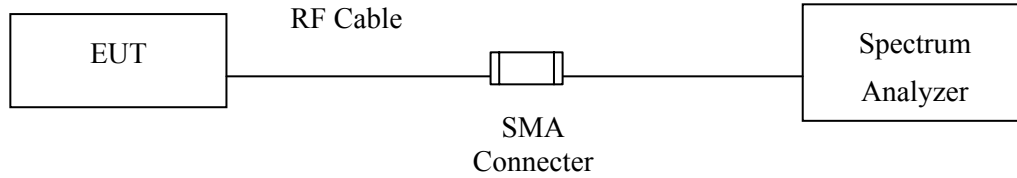

5.2. Limits

According to FCC Section 15.247(d). In any 100 kHz bandwidth outside the frequency band in which the spread spectrum or digitally modulated intentional radiator is operating, the radio frequency power that is produced by the intentional radiator shall be at least 20 dB below that in the 100 kHz bandwidth within the band that contains the highest level of the desired power, based on either an RF conducted or measurement, provided the transmitter demonstrates compliance with the peak conducted power limits. If the transmitter complies with the conducted power limits based on the use of RMS averaging over a time interval, the attenuation required under this paragraph shall be 30 dB instead of 20 dB.

5.3. Test Procedure

The EUT was setup to ANSI C63.4, 2014; tested to FHSS test procedure of FCC Public Notice DA 00-705 for compliance to FCC 47CFR 15.247 requirements.

5.4. Uncertainty

$\pm 1.23\text{dB}$

5.5. Test Result of RF Antenna Conducted Test

Product : VistaHub Wifi only
 Test Item : RF Antenna Conducted Test
 Test Mode : Mode 1: Transmit - 1Mbps
 Test Date : 2017/09/16

Figure Channel 00:

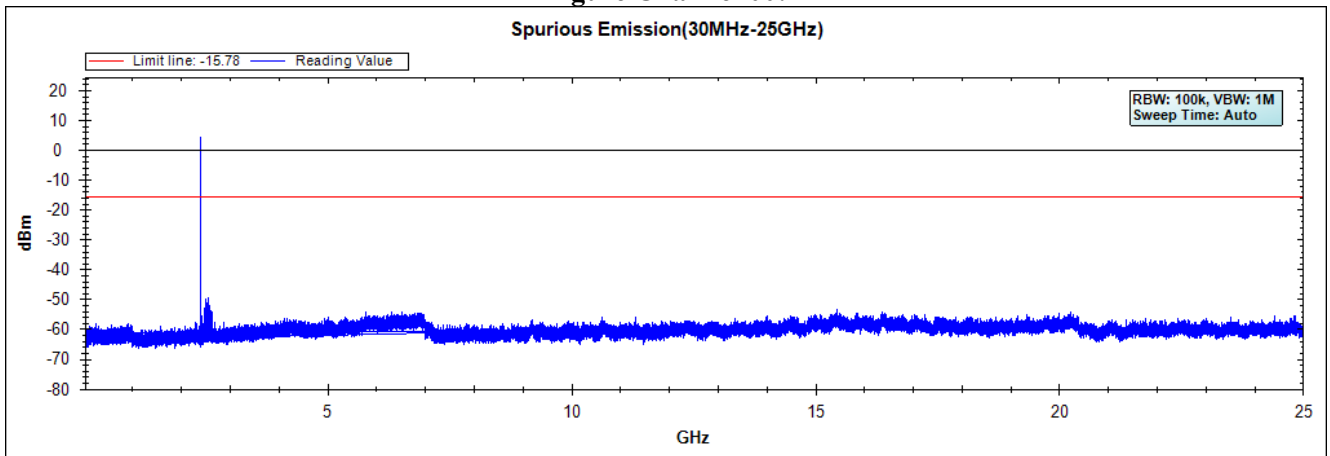

Figure Channel 39:

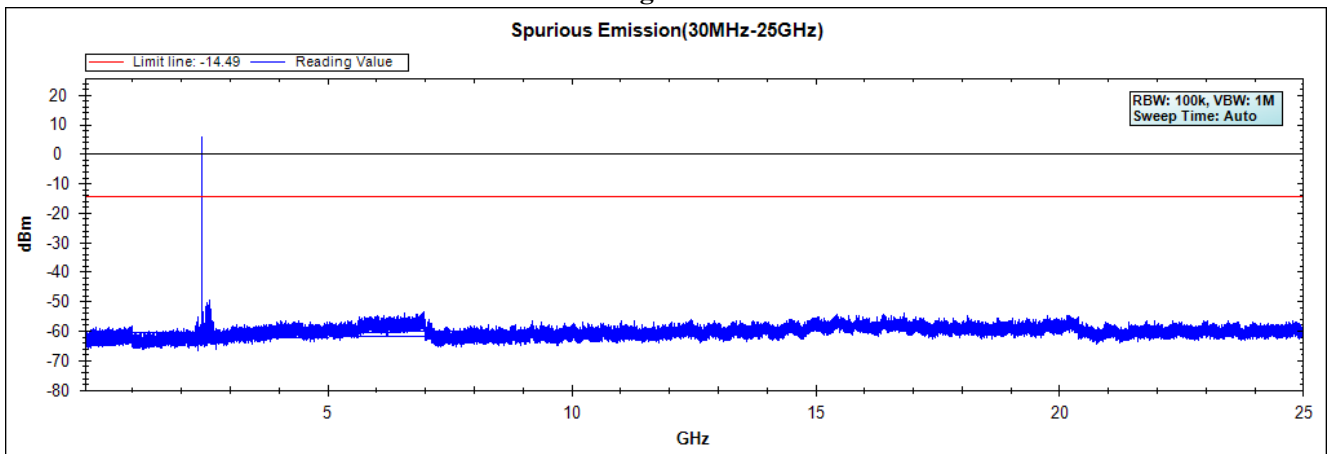
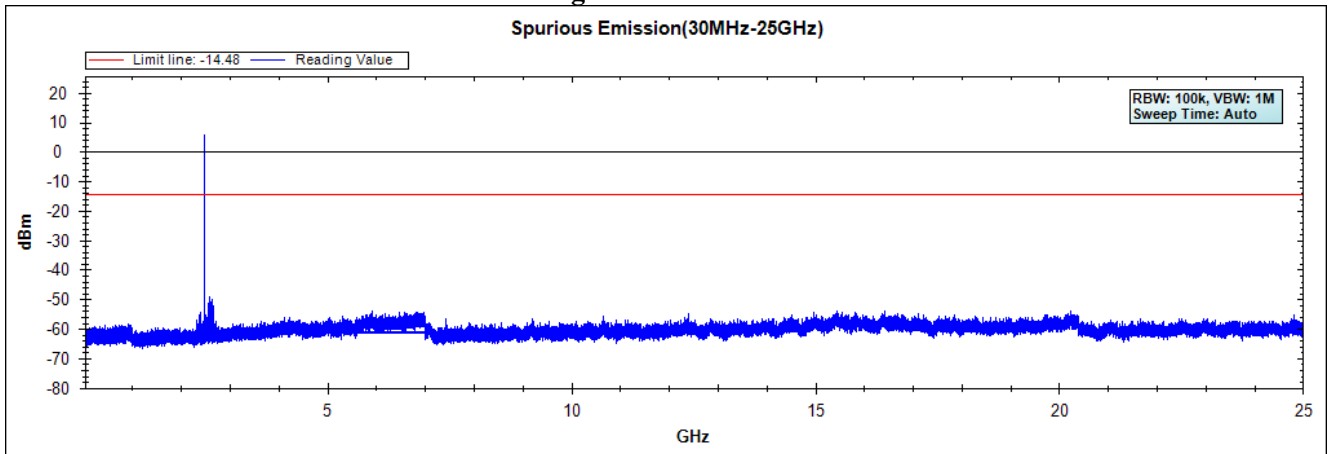

Figure Channel 78:



Note: The above test pattern is synthesized by multiple of the frequency range.

Product : VistaHub Wifi only
Test Item : RF Antenna Conducted Test
Test Mode : Mode 2: Transmit - 3Mbps
Test Date : 2017/09/16

Figure Channel 00:

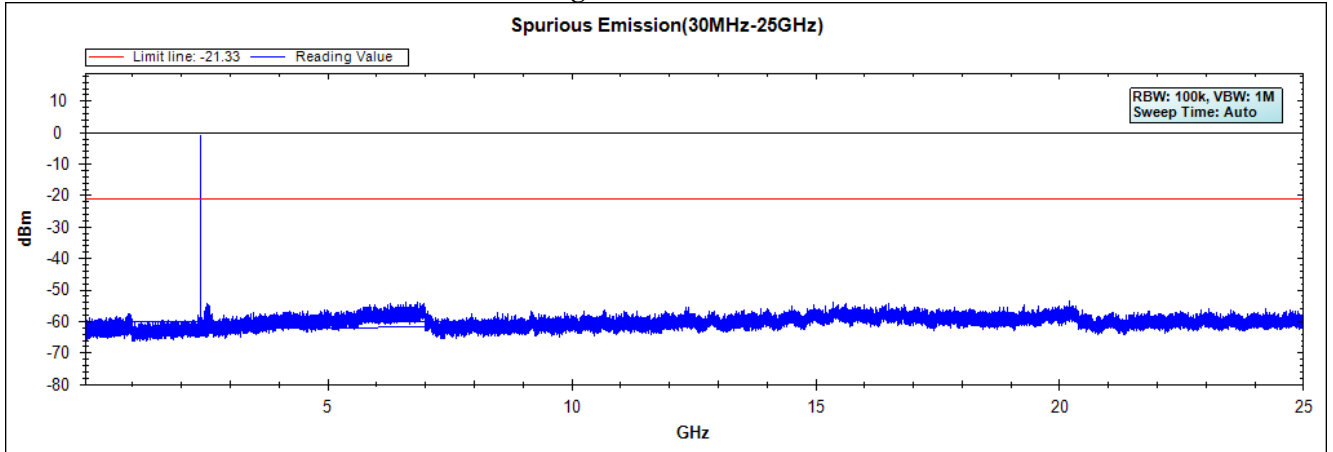

Figure Channel 39:

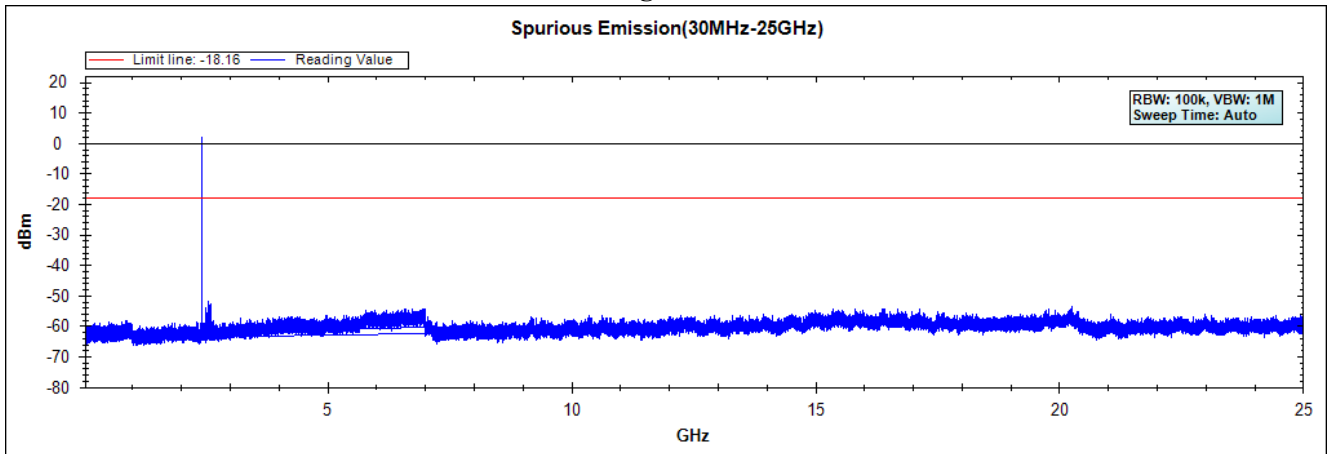
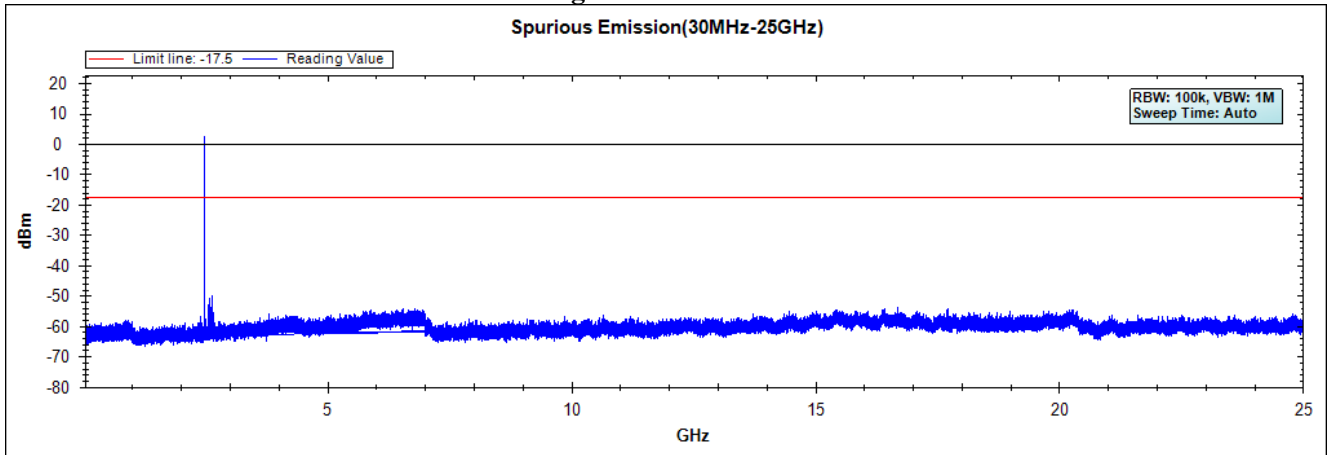

Figure Channel 78:



Note: The above test pattern is synthesized by multiple of the frequency range.

6. Band Edge

6.1. Test Setup

RF Conducted Measurement

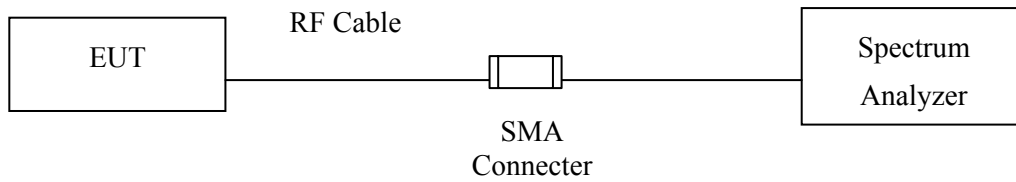

RF Radiated Measurement:

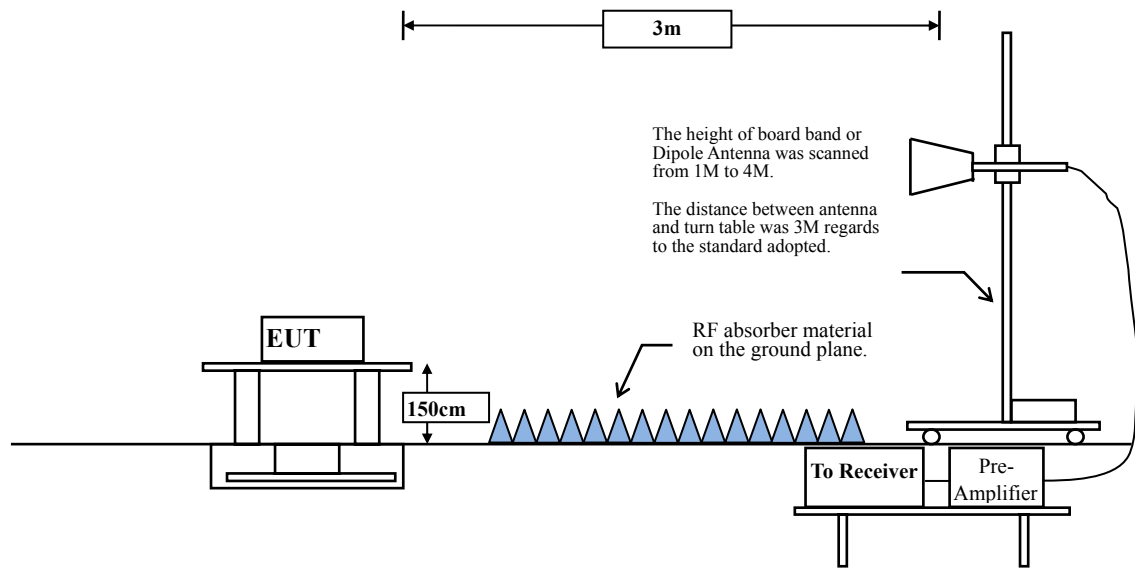

6.2. Limit

According to FCC Section 15.247(d). In any 100 kHz bandwidth outside the frequency band in which the spread spectrum or digitally modulated intentional radiator is operating, the radio frequency power that is produced by the intentional radiator shall be at least 20 dB below that in the 100 kHz bandwidth within the band that contains the highest level of the desired power, based on either an RF conducted or measurement, provided the transmitter demonstrates compliance with the peak conducted power limits. If the transmitter complies with the conducted power limits based on the use of RMS averaging over a time interval, the attenuation required under this paragraph shall be 30 dB instead of 20 dB. Attenuation below the general limits specified in Section 15.209(a) is not required. In addition, radiated emissions which fall in the restricted bands, as defined in Section 15.205(a), must also comply with the radiated emission limits specified in Section 15.209(a) (see Section 15.205(c)).

6.3. Test Procedure

The EUT is placed on a turn table which is 1.5 meter above ground. The turn table is rotated 360 degrees to determine the position of the maximum emission level. The EUT was positioned such that the distance from antenna to the EUT was 3 meters.

The antenna can move up and down between 1 meter and 4 meters to find out the maximum emission level.

Both horizontal and vertical polarization of the antenna are set on measurement. In order to find the maximum emission, all of the interface cables must be manipulated according to ANSI C63.10: 2013 on radiated measurement.

The bandwidth setting below 1GHz and above 1GHz on the field strength meter is 120 kHz and 1MHz, respectively.

6.4. Uncertainty

Conducted: ± 1.23 dB

Radiated:

Horizontal polarization : 1-18GHz: ± 3.77 dB

Vertical polarization : 1-18GHz : ± 3.83 dB

6.5. Test Result of Band Edge

Product : VistaHub Wifi only
 Test Item : Band Edge
 Test Mode : Mode 1: Transmit - 1Mbps (2402MHz)
 Test Date : 2017/11/26

RF Radiated Measurement (Horizontal):

Channel No.	Frequency (MHz)	Correct Factor (dB)	Reading Level (dBμV)	Emission Level (dBμV/m)	Peak Limit (dBμV/m)	Average Limit (dBμV/m)	Result
00 (Peak)	2381.700	10.228	38.857	49.085	74.00	54.00	Pass
00 (Peak)	2390.000	10.262	37.706	47.968	74.00	54.00	Pass
00 (Peak)	2400.000	10.304	50.404	60.707	--	--	Pass
00 (Peak)	2402.200	10.312	85.818	96.131	--	--	--
00 (Average)	2381.700	10.228	24.475	34.703	74.00	54.00	Pass
00 (Average)	2390.000	10.262	24.400	34.662	74.00	54.00	Pass
00 (Average)	2402.000	10.311	75.657	85.969	--	--	--

Figure Channel 00: Horizontal (Peak)

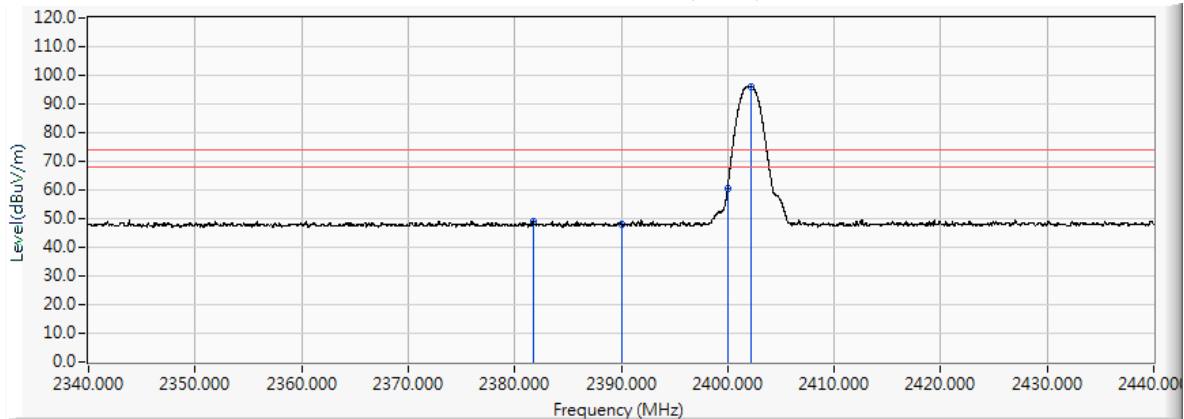
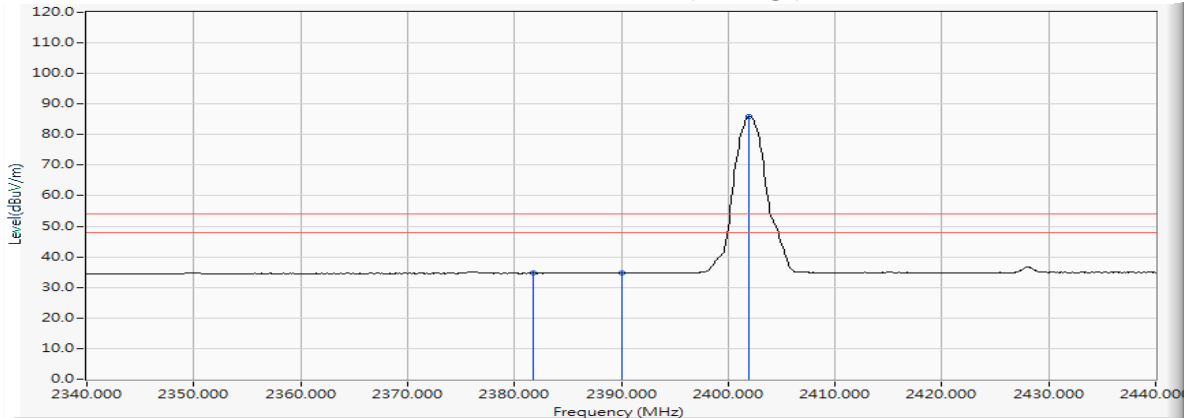

Figure Channel 00: Horizontal (Average)



Note:

1. All readings above 1GHz are performed with peak and/or average measurements as necessary.
2. Peak measurements: RBW = 1MHz, VBW = 3 MHz, Sweep: Auto.
3. Average measurements: RBW = 1MHz, VBW = 10 Hz, Sweep: Auto.
4. “*” means this data is the worst emission level.
5. Measurement Level = Reading Level + Correction Factor.
6. The average measurement was not performed when the peak measured data is under the limit of average detection.

Product : VistaHub Wifi only
 Test Item : Band Edge
 Test Mode : Mode 1: Transmit - 1Mbps (2402MHz)
 Test Date : 2017/11/26

RF Radiated Measurement (VERTICAL):

Channel No.	Frequency (MHz)	Correct Factor (dB)	Reading Level (dBμV)	Emission Level (dBμV/m)	Peak Limit (dBμV/m)	Average Limit (dBμV/m)	Result
00 (Peak)	2376.200	10.205	40.720	50.926	74.00	54.00	Pass
00 (Peak)	2390.000	10.262	37.696	47.958	74.00	54.00	Pass
00 (Peak)	2400.000	10.304	61.002	71.305	--	--	Pass
00 (Peak)	2402.200	10.312	96.424	106.737	--	--	--
00 (Average)	2376.200	10.205	29.274	39.480	74.00	54.00	Pass
00 (Average)	2390.000	10.262	24.707	34.969	74.00	54.00	Pass
00 (Average)	2402.000	10.311	83.023	93.335	--	--	--

Figure Channel 00: VERTICAL (Peak)

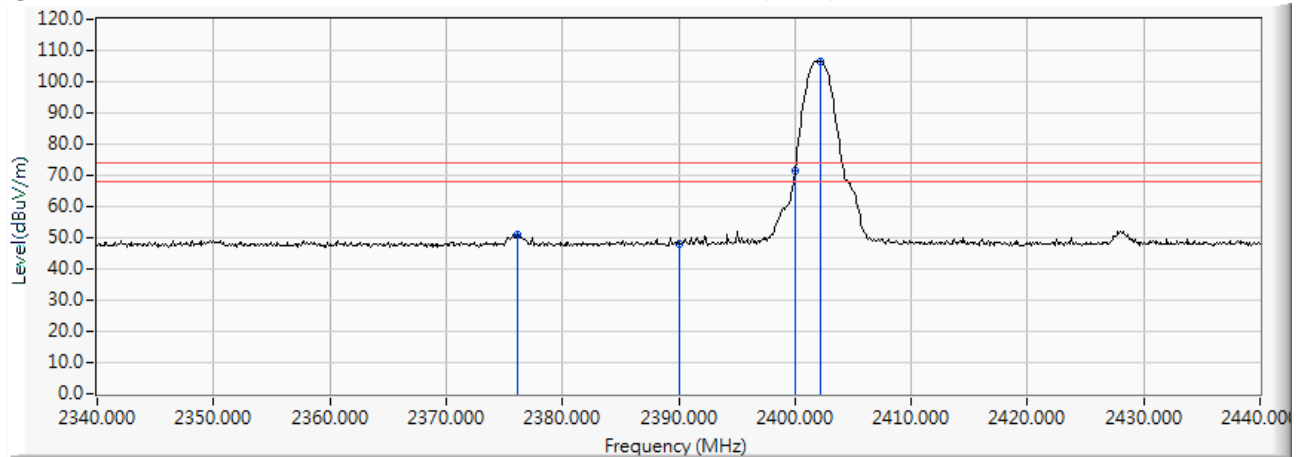
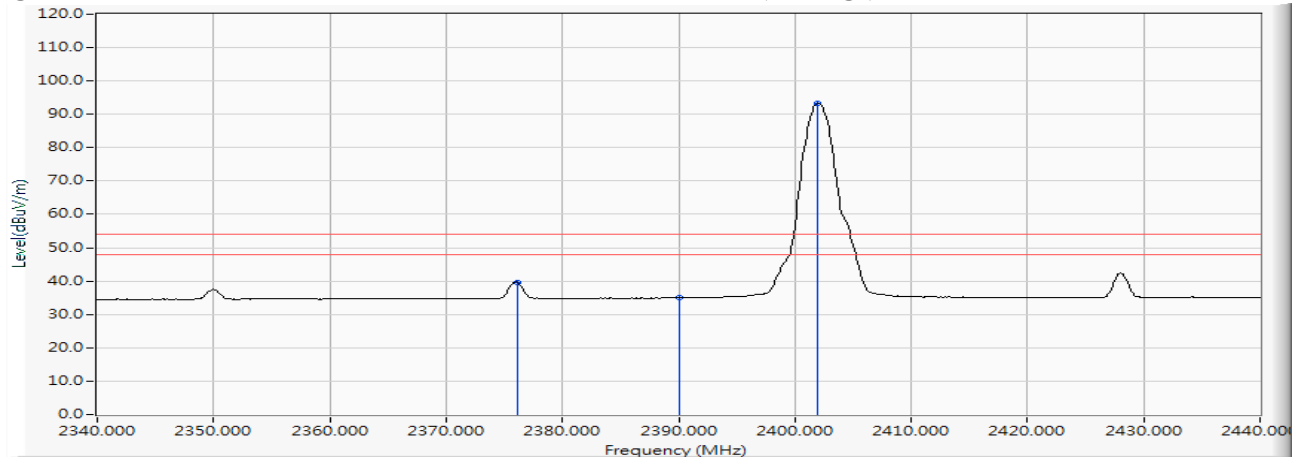

Figure Channel 00: VERTICAL (Average)



Note:

1. All readings above 1GHz are performed with peak and/or average measurements as necessary.
2. Peak measurements: RBW = 1MHz, VBW = 3 MHz, Sweep: Auto.
3. Average measurements: RBW = 1MHz, VBW = 10 Hz, Sweep: Auto.
4. “ * ”, means this data is the worst emission level.
5. Measurement Level = Reading Level + Correction Factor.
6. The average measurement was not performed when the peak measured data is under the limit of average detection.

Product : VistaHub Wifi only
 Test Item : Band Edge
 Test Mode : Mode 1: Transmit - 1Mbps (2480MHz)
 Test Date : 2017/11/26

RF Radiated Measurement (Horizontal):

Channel No.	Frequency (MHz)	Correct Factor (dB)	Reading Level (dBμV)	Emission Level (dBμV/m)	Peak Limit (dBμV/m)	Average Limit (dBμV/m)	Result
78 (Peak)	2480.000	10.628	86.741	97.369	--	--	--
78 (Peak)	2483.500	10.640	41.353	51.994	74.00	54.00	Pass
78 (Average)	2480.000	10.628	75.580	86.208	--	--	--
78 (Average)	2483.500	10.640	28.349	38.990	74.00	54.00	Pass

Figure Channel 78: Horizontal (Peak)

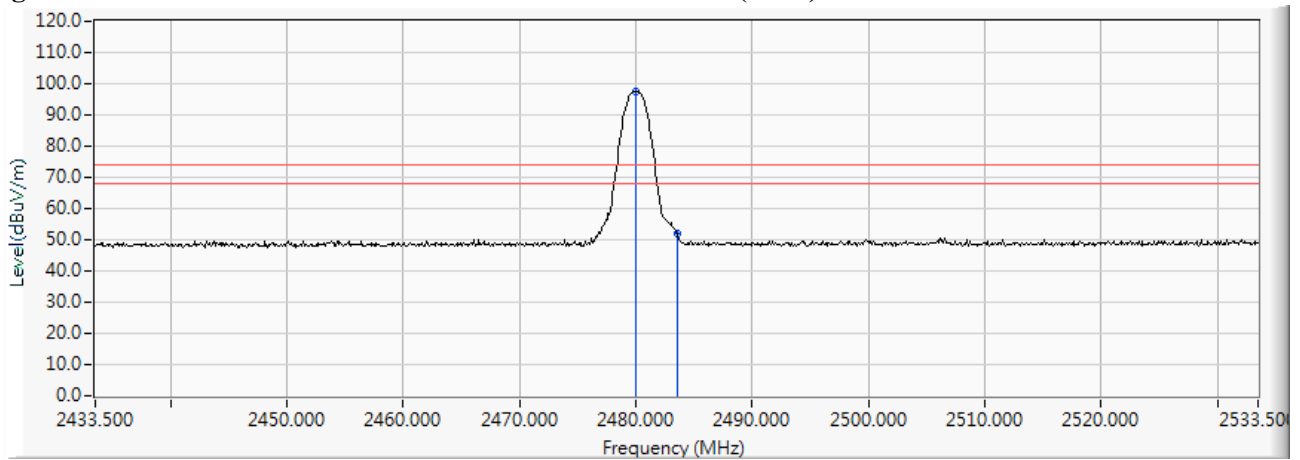
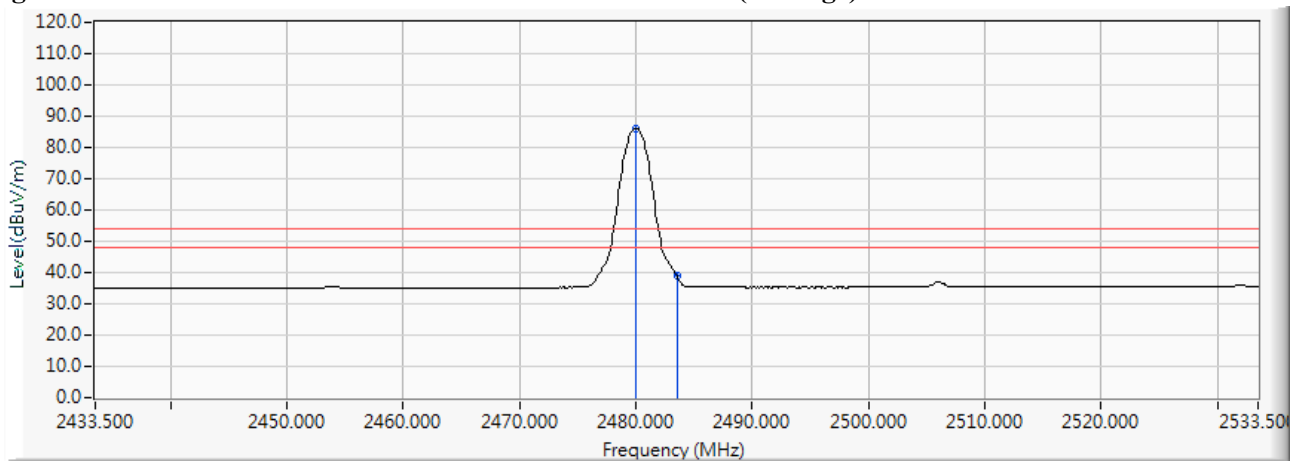

Figure Channel 78: Horizontal (Average)



Note:

1. All readings above 1GHz are performed with peak and/or average measurements as necessary.
2. Peak measurements: RBW = 1MHz, VBW = 3 MHz, Sweep: Auto.
3. Average measurements: RBW = 1MHz, VBW = 10 Hz, Sweep: Auto.
4. “ * ”, means this data is the worst emission level.
5. Measurement Level = Reading Level + Correction Factor.
6. The average measurement was not performed when the peak measured data is under the limit of average detection.

Product : VistaHub Wifi only
 Test Item : Band Edge
 Test Mode : Mode 1: Transmit - 1Mbps (2480MHz)
 Test Date : 2017/11/26

RF Radiated Measurement (VERTICAL):

Channel No.	Frequency (MHz)	Correct Factor (dB)	Reading Level (dBμV)	Emission Level (dBμV/m)	Peak Limit (dBμV/m)	Average Limit (dBμV/m)	Result
78 (Peak)	2480.000	10.628	98.938	109.566	--	--	--
78 (Peak)	2483.500	10.640	49.928	60.569	74.00	54.00	Pass
78 (Average)	2480.000	10.628	85.590	96.218	--	--	--
78 (Average)	2483.500	10.640	35.372	46.013	74.00	54.00	Pass

Figure Channel 78: VERTICAL (Peak)

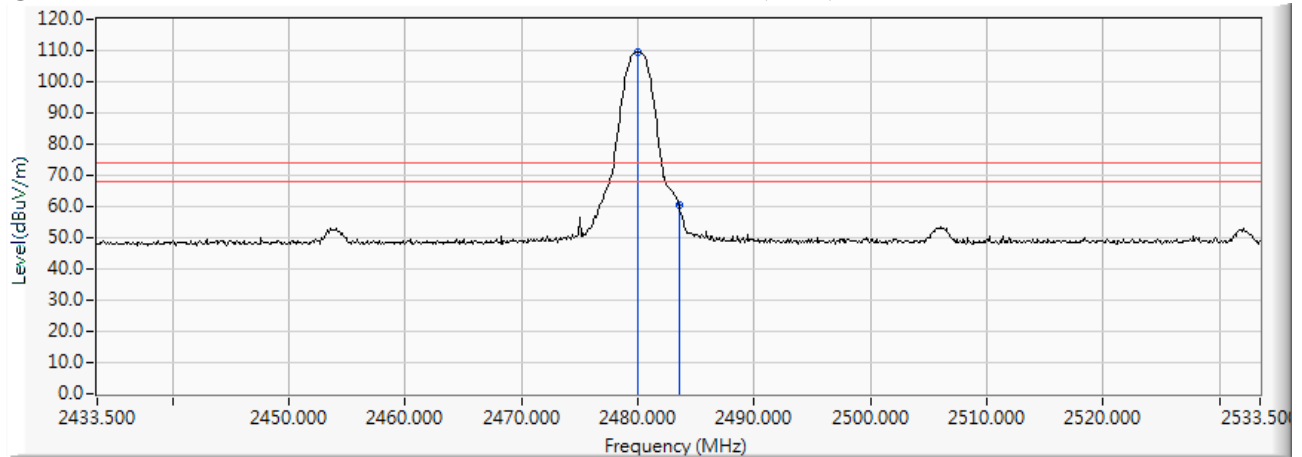
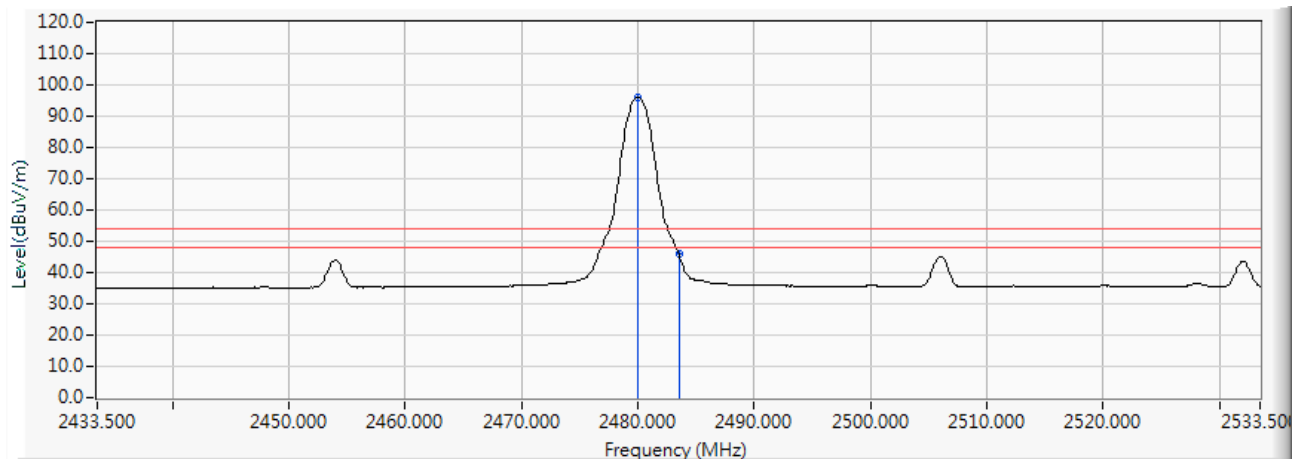

Figure Channel 78: VERTICAL (Average)



Note:

1. All readings above 1GHz are performed with peak and/or average measurements as necessary.
2. Peak measurements: RBW = 1MHz, VBW = 3 MHz, Sweep: Auto.
3. Average measurements: RBW = 1MHz, VBW = 10 Hz, Sweep: Auto.
4. “ * ”, means this data is the worst emission level.
5. Measurement Level = Reading Level + Correction Factor.
6. The average measurement was not performed when the peak measured data is under the limit of average detection.

Product : VistaHub Wifi only
 Test Item : Band Edge
 Test Mode : Mode 2: Transmit - 3Mbps (2402MHz)
 Test Date : 2017/11/26

RF Radiated Measurement (Horizontal):

Channel No.	Frequency (MHz)	Correct Factor (dB)	Reading Level (dBμV)	Emission Level (dBμV/m)	Peak Limit (dBμV/m)	Average Limit (dBμV/m)	Result
00 (Peak)	2390.000	10.262	37.756	48.018	74.00	54.00	Pass
00 (Peak)	2400.000	10.304	56.067	66.371	74.00	54.00	Pass
00 (Peak)	2402.000	10.311	85.064	95.375	--	--	--
00 (Average)	2390.000	10.262	24.402	34.664	74.00	54.00	Pass
00 (Average)	2402.000	10.311	71.240	81.551	--	--	--

Figure Channel 00: Horizontal (Peak)

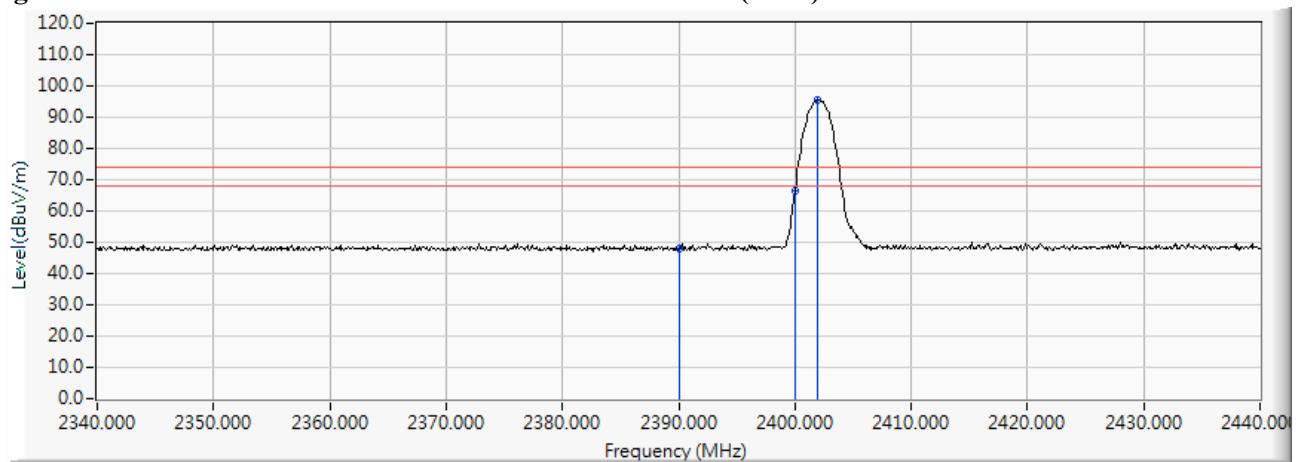
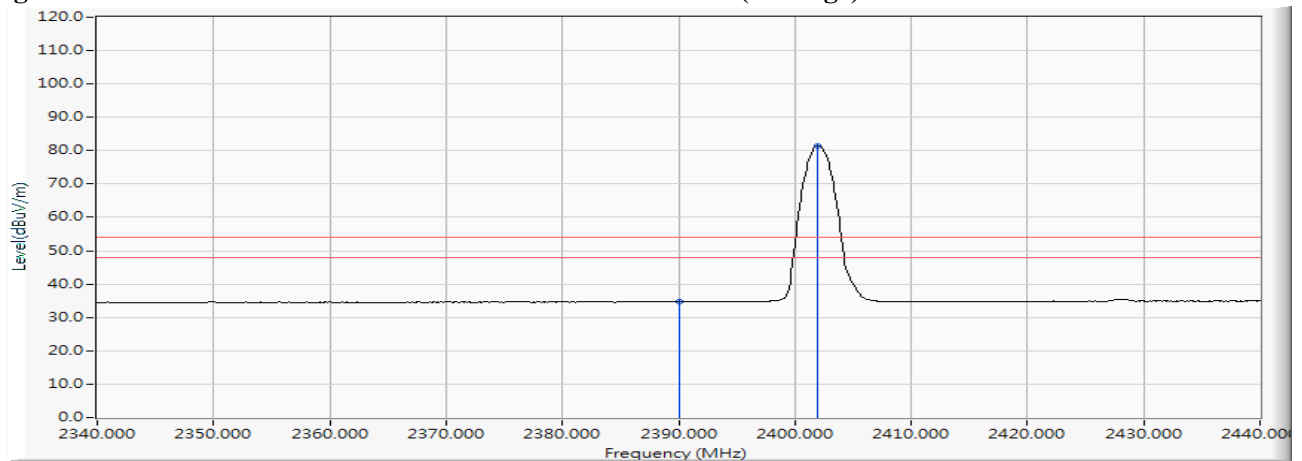

Figure Channel 00: Horizontal (Average)



Note:

1. All readings above 1GHz are performed with peak and/or average measurements as necessary.
2. Peak measurements: RBW = 1MHz, VBW = 3 MHz, Sweep: Auto.
3. Average measurements: RBW = 1MHz, VBW = 10 Hz, Sweep: Auto.
4. “ * ”, means this data is the worst emission level.
5. Measurement Level = Reading Level + Correction Factor.
6. The average measurement was not performed when the peak measured data is under the limit of average detection.

Product : VistaHub Wifi only
 Test Item : Band Edge
 Test Mode : Mode 2: Transmit - 3Mbps (2402MHz)
 Test Date : 2017/11/26

RF Radiated Measurement (VERTICAL):

Channel No.	Frequency (MHz)	Correct Factor (dB)	Reading Level (dBµV)	Emission Level (dBµV/m)	Peak Limit (dBµV/m)	Average Limit (dBµV/m)	Result
00 (Peak)	2389.400	10.260	40.875	51.135	74.00	54.00	Pass
00 (Peak)	2390.000	10.262	37.604	47.866	74.00	54.00	Pass
00 (Peak)	2400.000	10.304	66.052	76.355	--	--	Pass
00 (Peak)	2402.000	10.311	94.976	105.288	--	--	--
00 (Average)	2389.400	10.260	24.722	34.982	74.00	54.00	Pass
00 (Average)	2390.000	10.262	24.840	35.102	74.00	54.00	Pass
00 (Average)	2402.000	10.311	79.796	90.108	--	--	--

Figure Channel 00: VERTICAL (Peak)

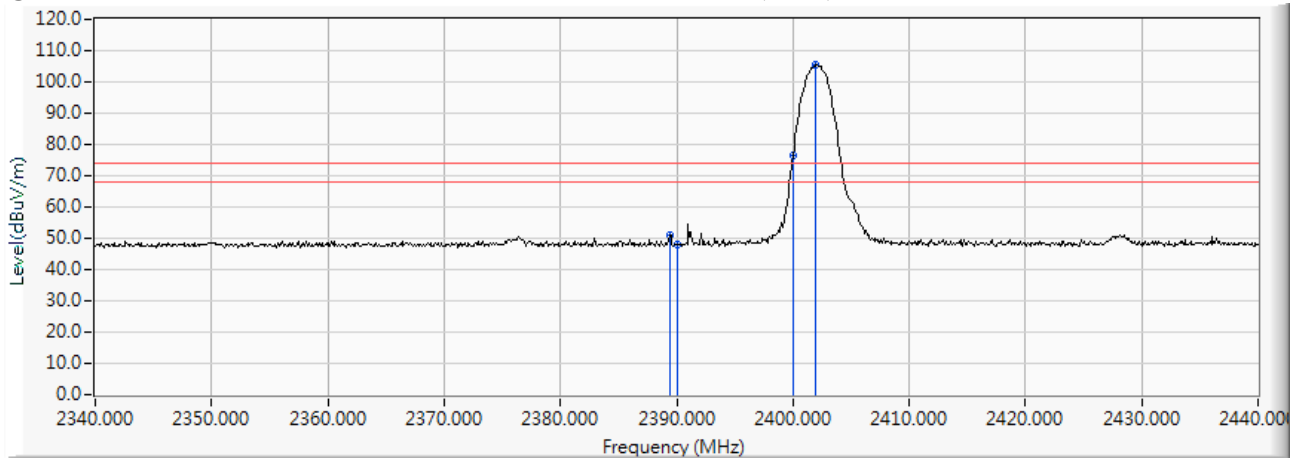
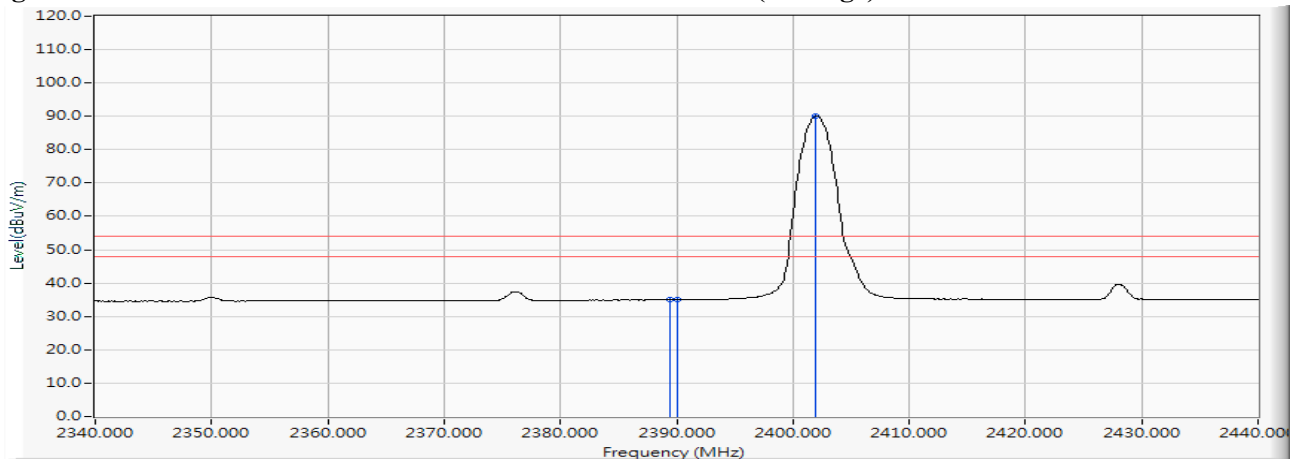

Figure Channel 00: VERTICAL (Average)



Note:

1. All readings above 1GHz are performed with peak and/or average measurements as necessary.
2. Peak measurements: RBW = 1MHz, VBW = 3 MHz, Sweep: Auto.
3. Average measurements: RBW = 1MHz, VBW = 10 Hz, Sweep: Auto.
4. “ * ”, means this data is the worst emission level.
5. Measurement Level = Reading Level + Correction Factor.
6. The average measurement was not performed when the peak measured data is under the limit of average detection.

Product : VistaHub Wifi only
 Test Item : Band Edge
 Test Mode : Mode 2: Transmit - 3Mbps (2480MHz)
 Test Date : 2017/11/26

RF Radiated Measurement (Horizontal):

Channel No.	Frequency (MHz)	Correct Factor (dB)	Reading Level (dBμV)	Emission Level (dBμV/m)	Peak Limit (dBμV/m)	Average Limit (dBμV/m)	Result
78 (Peak)	2480.000	10.628	84.970	95.598	--	--	--
78 (Peak)	2483.500	10.640	37.937	48.578	74.00	54.00	Pass
78 (Average)	2480.000	10.628	71.224	81.852	--	--	--
78 (Average)	2483.500	10.640	24.973	35.614	74.00	54.00	Pass

Figure Channel 00: Horizontal (Peak)

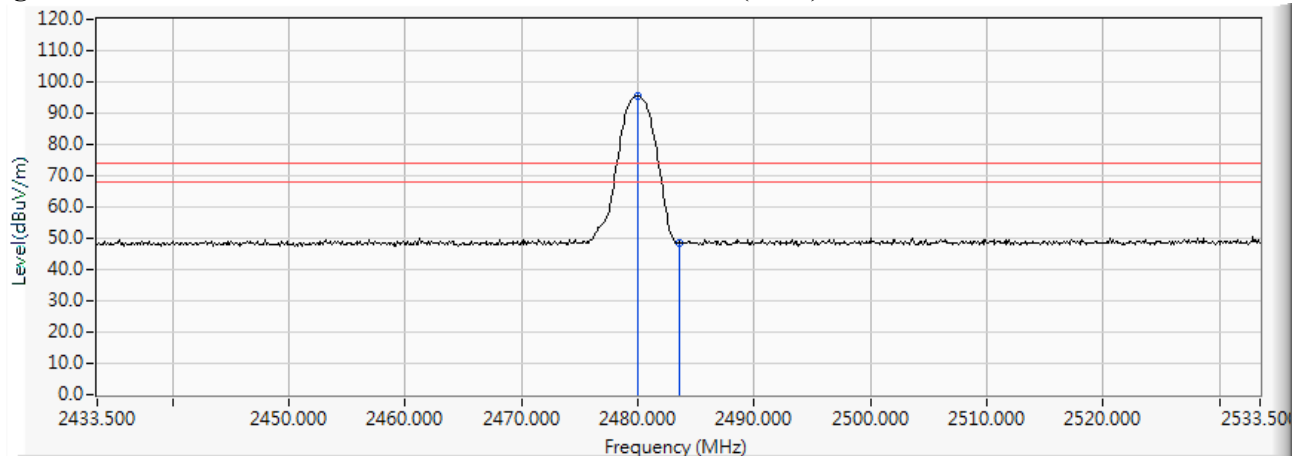
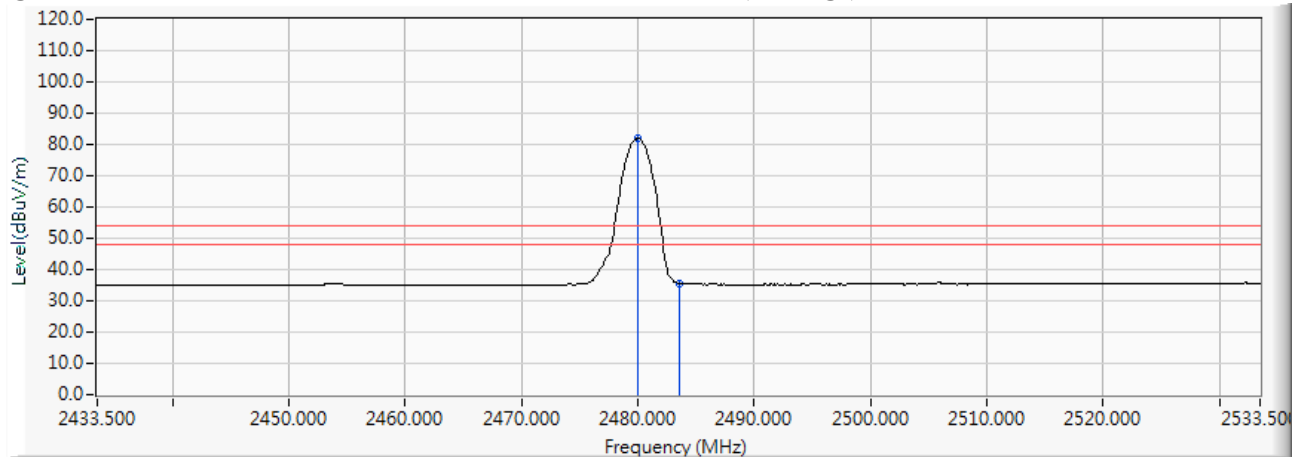

Figure Channel 00: Horizontal (Average)



Note:

1. All readings above 1GHz are performed with peak and/or average measurements as necessary.
2. Peak measurements: RBW = 1MHz, VBW = 3 MHz, Sweep: Auto.
3. Average measurements: RBW = 1MHz, VBW = 10 Hz, Sweep: Auto.
4. “*” means this data is the worst emission level.
5. Measurement Level = Reading Level + Correction Factor.
6. The average measurement was not performed when the peak measured data is under the limit of average detection.

Product : VistaHub Wifi only
 Test Item : Band Edge
 Test Mode : Mode 2: Transmit - 3Mbps (2480MHz)
 Test Date : 2017/11/26

RF Radiated Measurement (VERTICAL):

Channel No.	Frequency (MHz)	Correct Factor (dB)	Reading Level (dBμV)	Emission Level (dBμV/m)	Peak Limit (dBμV/m)	Average Limit (dBμV/m)	Result
78 (Peak)	2480.000	10.628	97.521	108.149	--	--	--
78 (Peak)	2483.500	10.640	43.837	54.478	74.00	54.00	Pass
78 (Average)	2480.000	10.628	81.730	92.358	--	--	--
78 (Average)	2483.500	10.640	28.799	39.440	74.00	54.00	Pass

Figure Channel 78: VERTICAL (Peak)

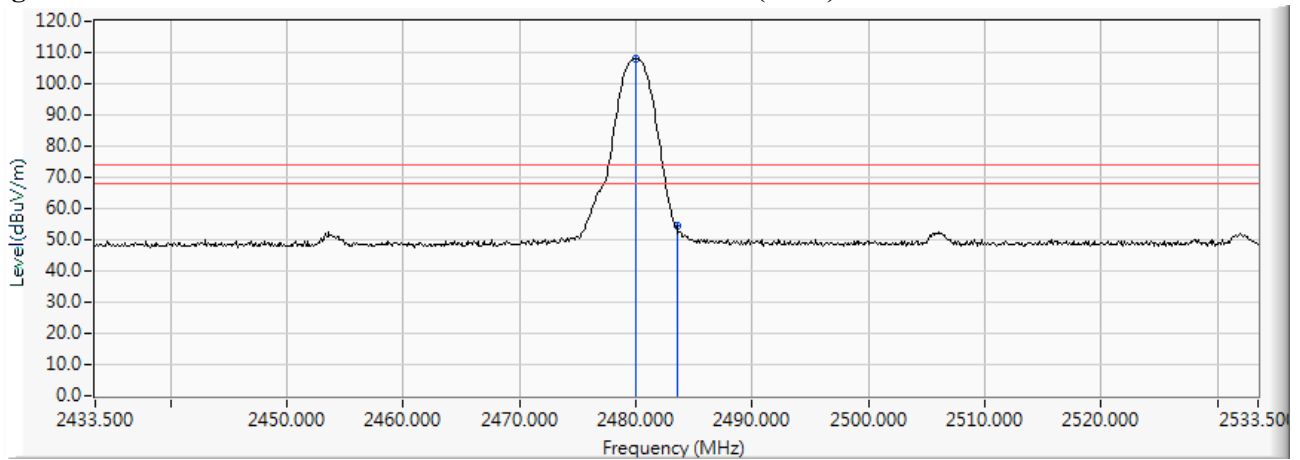
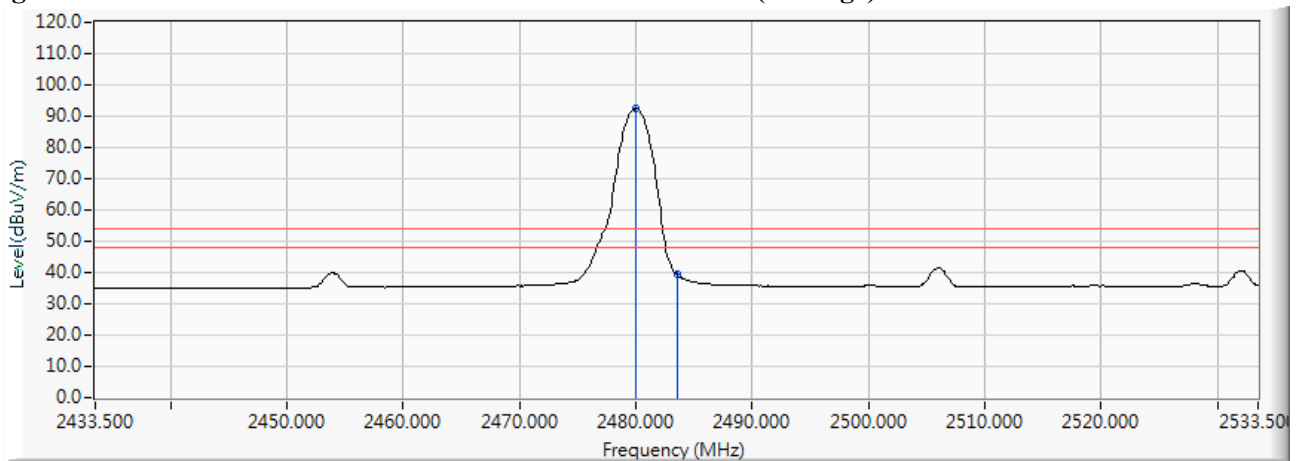

Figure Channel 78: VERTICAL (Average)



Note:

1. All readings above 1GHz are performed with peak and/or average measurements as necessary.
2. Peak measurements: RBW = 1MHz, VBW = 3 MHz, Sweep: Auto.
3. Average measurements: RBW = 1MHz, VBW = 10 Hz, Sweep: Auto.
4. “ * ”, means this data is the worst emission level.
5. Measurement Level = Reading Level + Correction Factor.
6. The average measurement was not performed when the peak measured data is under the limit of average detection.

Product : VistaHub Wifi only
 Test Item : Band Edge
 Test Mode : Mode 1: Transmit - 1Mbps(Hopping off)

Measurement Level Δ (dB)	Result
> 20	PASS

Figure Channel 00:

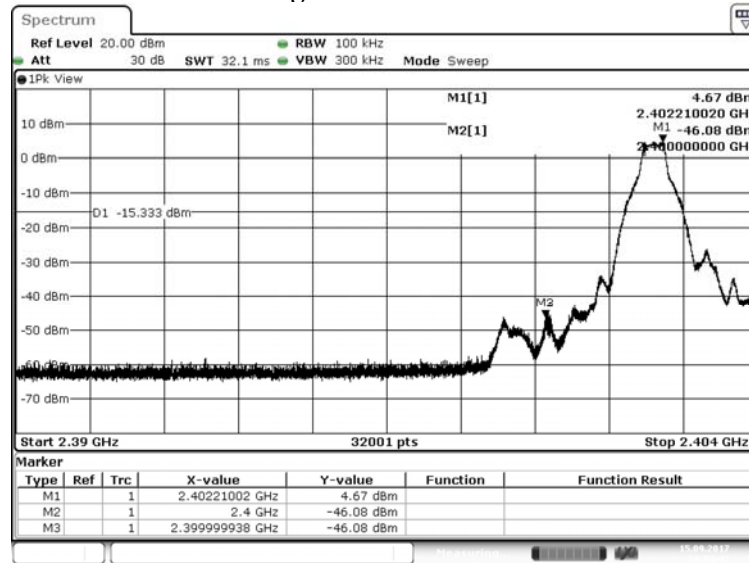

Date: 15.SEP.2017 20:03:42

Figure Channel 78:

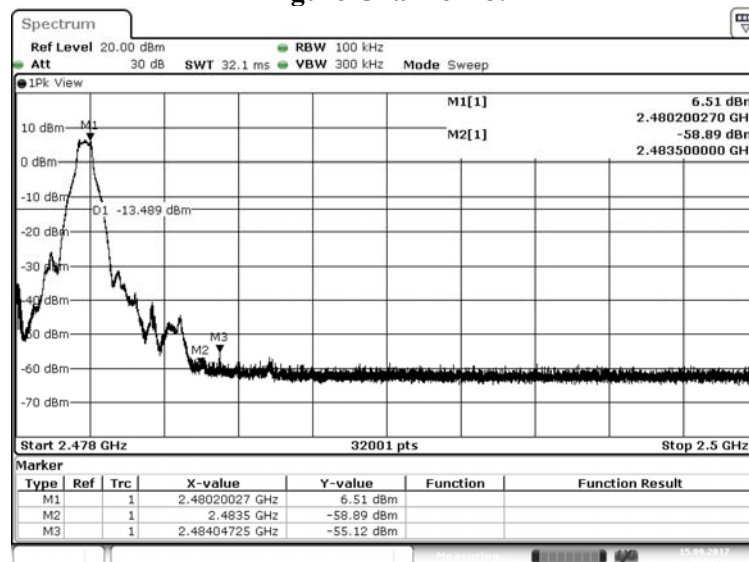

Date: 15.SEP.2017 20:38:20

Product : VistaHub Wifi only
 Test Item : Band Edge
 Test Mode : Mode 2: Transmit - 3Mbps (Hopping off)

Measurement Level Δ (dB)	Result
> 20	PASS

Figure Channel 00:

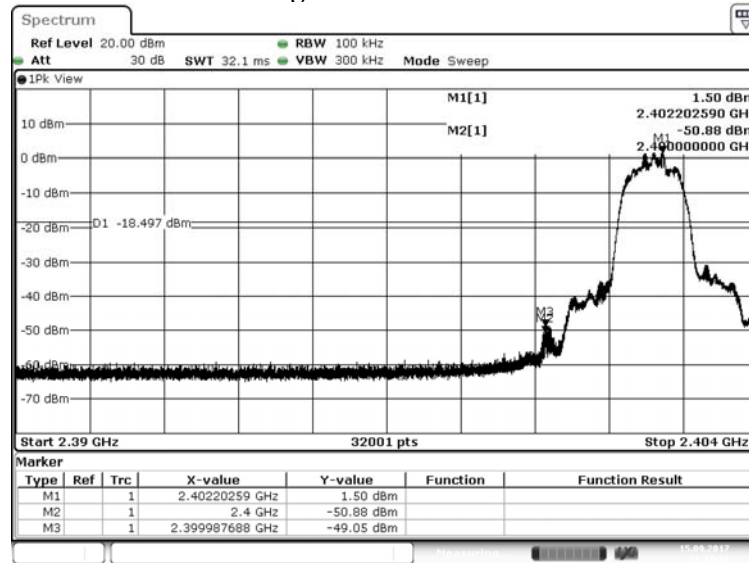

Date: 15.SEP.2017 21:18:28

Figure Channel 78:

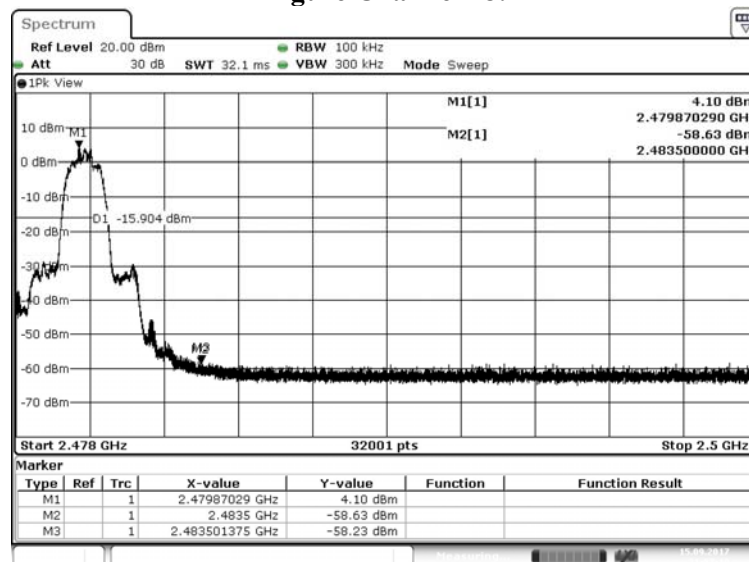

Date: 15.SEP.2017 21:57:20

Product : VistaHub Wifi only
 Test Item : Band Edge
 Test Mode : Mode 1: Transmit - 1Mbps(Hopping on)

Measurement Level Δ (dB)	Result
> 20	PASS

Figure Channel Hopping:

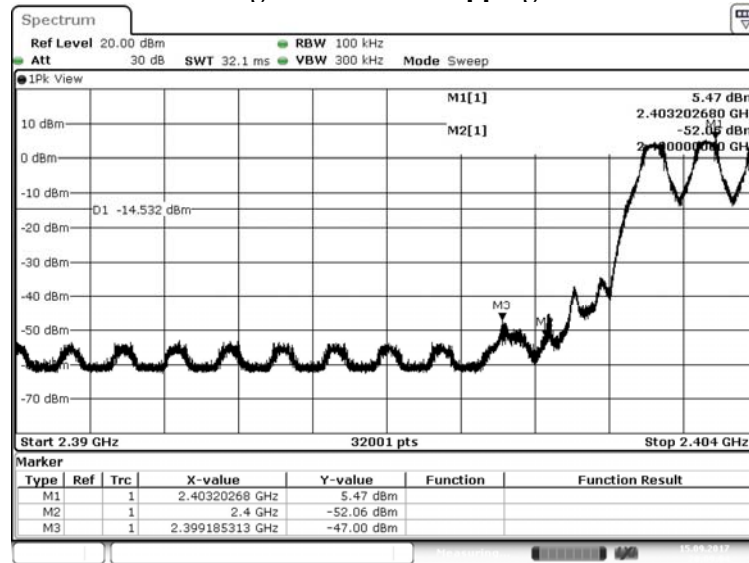

Date: 15.SEP.2017 20:09:05

Figure Channel Hopping:

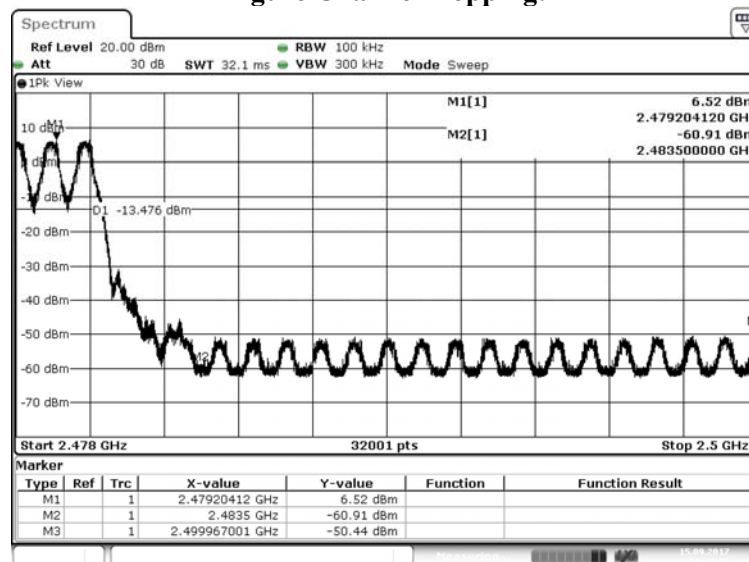

Date: 15.SEP.2017 20:47:52

Product : VistaHub Wifi only
 Test Item : Band Edge
 Test Mode : Mode 2: Transmit - 3Mbps (Hopping on)

Measurement Level	Result
Δ (dB)	
> 20	PASS

Figure Channel Hopping:

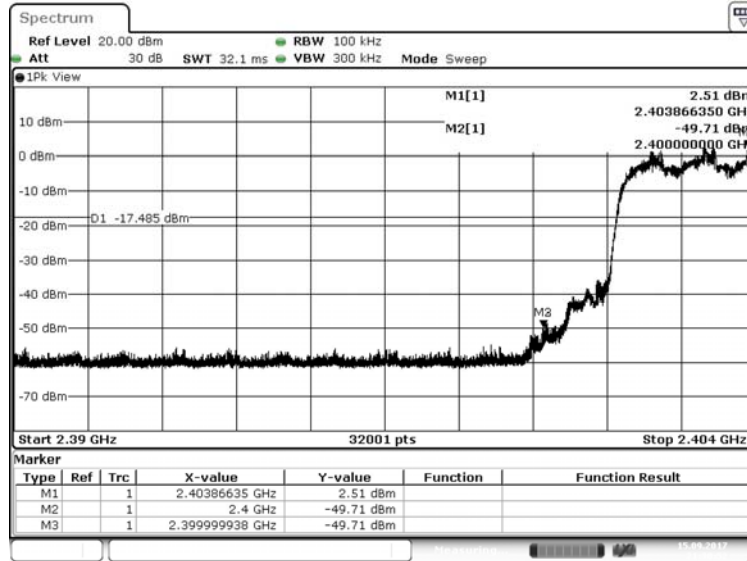

Date: 15.SEP.2017 21:30:52

Figure Channel Hopping:

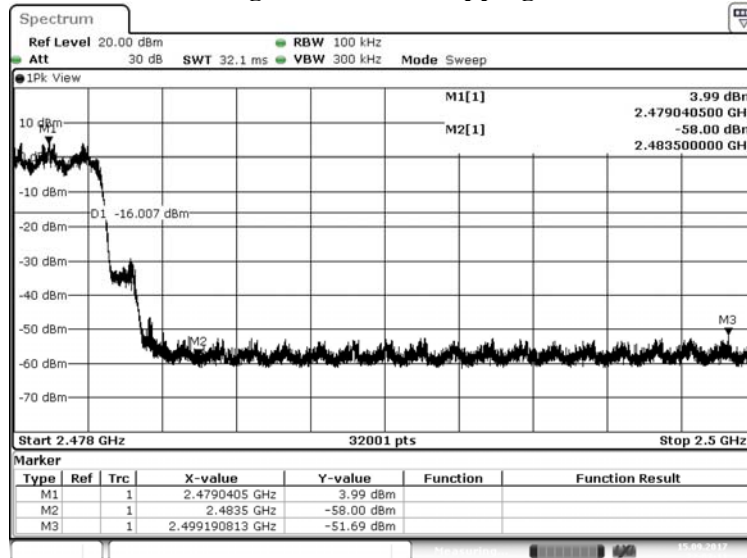

Date: 15.SEP.2017 22:03:11

7. Channel Number

7.1. Test Setup

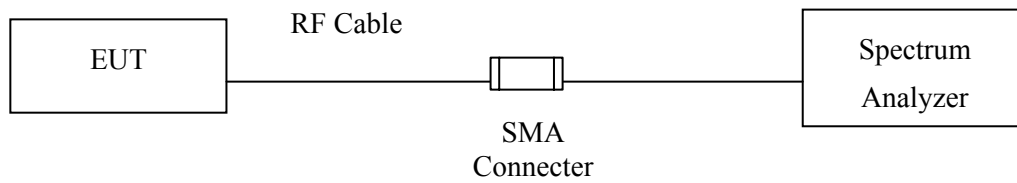

7.2. Limit

Frequency hopping systems operating in the 2400-2483.5 MHz bands shall use at least 75 hopping frequencies.

7.3. Test Procedure

The EUT was setup to ANSI C63.4, 2014; tested to FHSS test procedure of FCC Public Notice DA 00-705 for compliance to FCC 47CFR 15.247 requirements.

7.4. Uncertainty

N/A

7.5. Test Result of Channel Number

Product : VistaHub Wifi only
 Test Item : Channel Number
 Test Mode : Mode 1: Transmit - 1Mbps

Frequency Range (MHz)	Measurement (Hopping Channel)	Required Limit (Hopping Channel)	Result
2402 ~ 2480	79	>75	Pass

2402-2421MHz

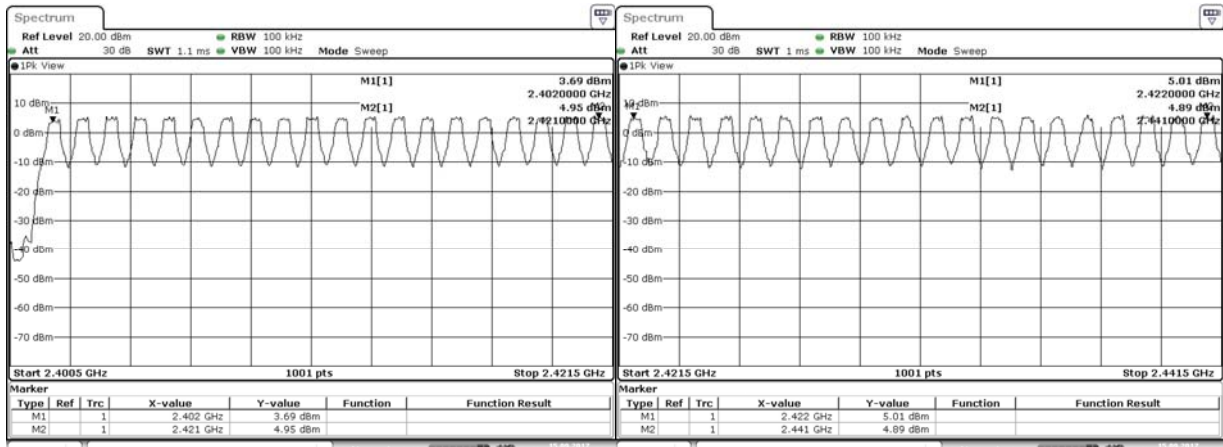

Date: 15 SEP 2017 20:53:54

2422-2441MHz

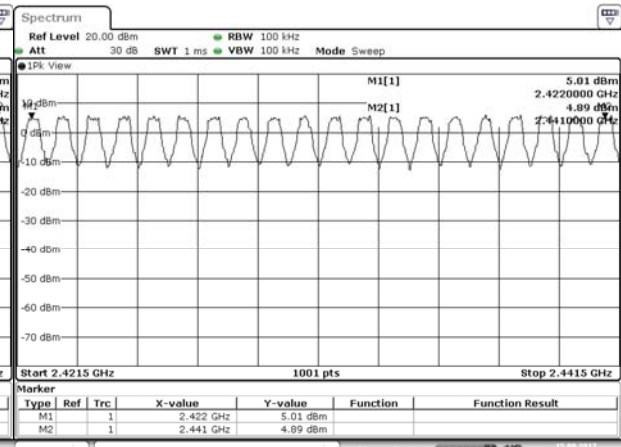

Date: 15 SEP 2017 20:55:13

2442-2461MHz

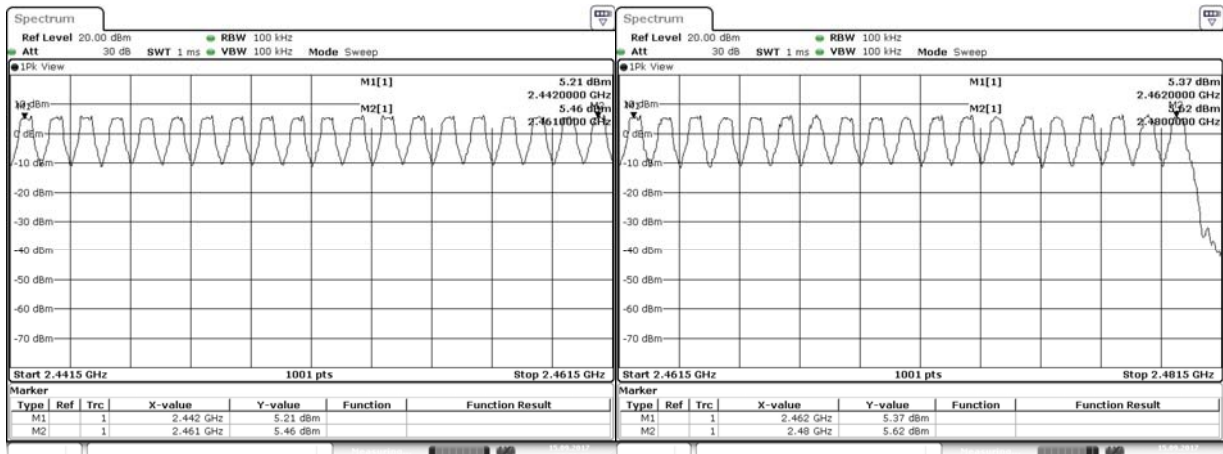

Date: 15 SEP 2017 20:58:25

2462-2480MHz

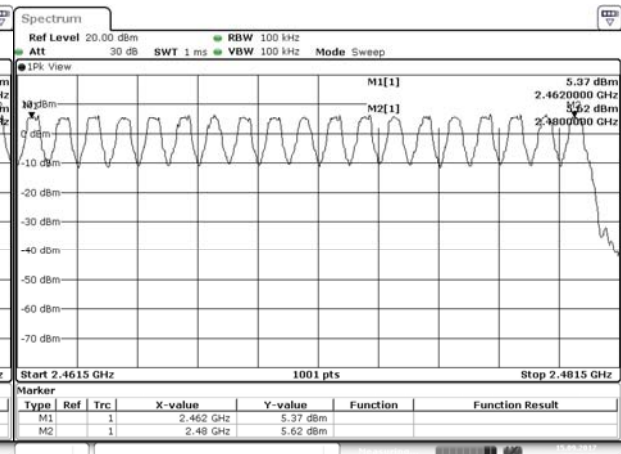

Date: 15 SEP 2017 20:59:56

Product : VistaHub Wifi only
 Test Item : Channel Number
 Test Mode : Mode 2: Transmit - 3Mbps

Frequency Range (MHz)	Measurement (Hopping Channel)	Required Limit (Hopping Channel)	Result
2402 ~ 2480	79	>75	Pass

2402-2421MHz

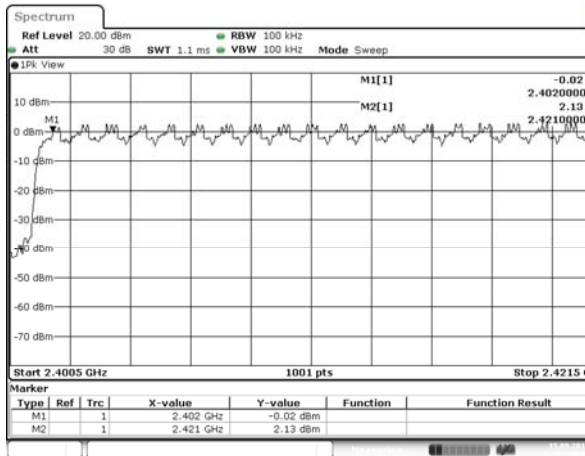

Date: 15.SEP.2017 22:10:39

2422-2441MHz

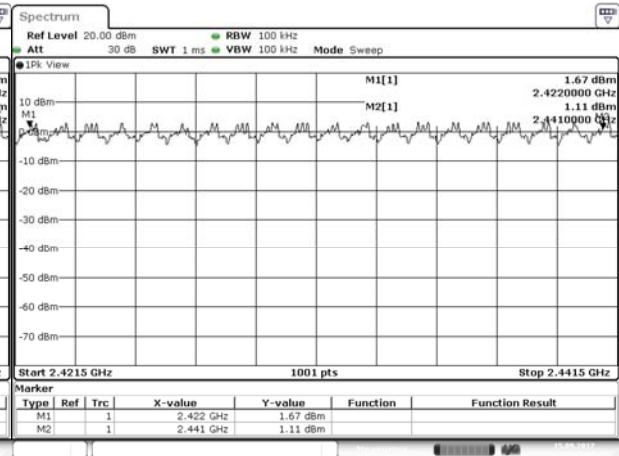

Date: 15.SEP.2017 22:15:38

2442-2461MHz

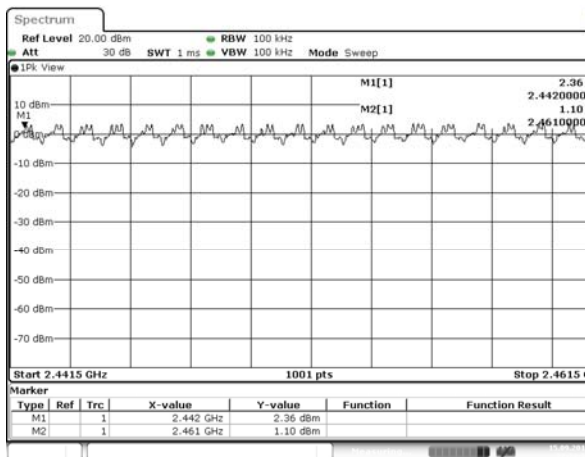

Date: 15.SEP.2017 22:23:35

2462-2480MHz

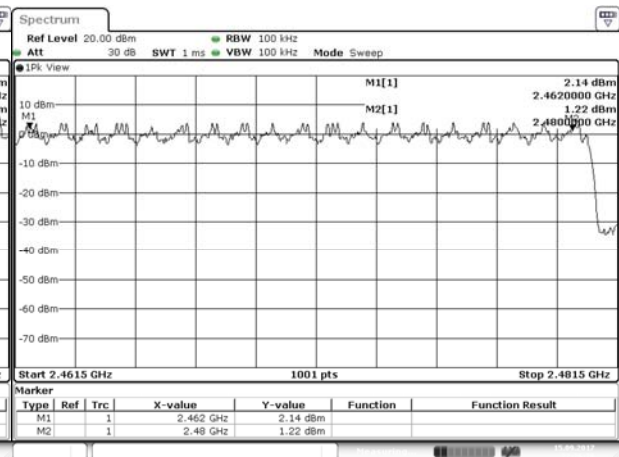

Date: 15.SEP.2017 22:26:29

8. Channel Separation

8.1. Test Setup

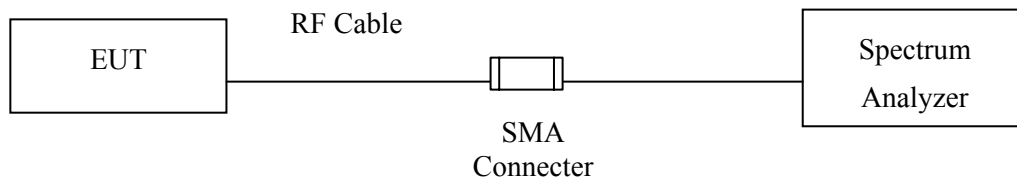

8.2. Limit

Frequency hopping systems shall have hopping channel carrier frequencies separated by a minimum of 25 kHz or the 20 dB bandwidth of the hopping channel, whichever is greater.

8.3. Test Procedure

The EUT was setup to ANSI C63.4, 2014; tested to FHSS test procedure of FCC Public Notice DA 00-705 for compliance to FCC 47CFR 15.247 requirements.

8.4. Uncertainty

$\pm 279.2\text{Hz}$

8.5. Test Result of Channel Separation

Product : VistaHub Wifi only
 Test Item : Channel Separation
 Test Mode : Mode 1: Transmit - 1Mbps

Channel No.	Frequency (MHz)	Measurement Level (kHz)	Limit (kHz)	Limit of (2/3)*20dB Bandwidth (kHz)	Result
00	2402	1000	>25 kHz	640.0	Pass
39	2441	1000	>25 kHz	648.0	Pass
78	2480	1000	>25 kHz	640.0	Pass

NOTE: The 20dB Bandwidth is refer to section 10.

Channel 00 (2402MHz)

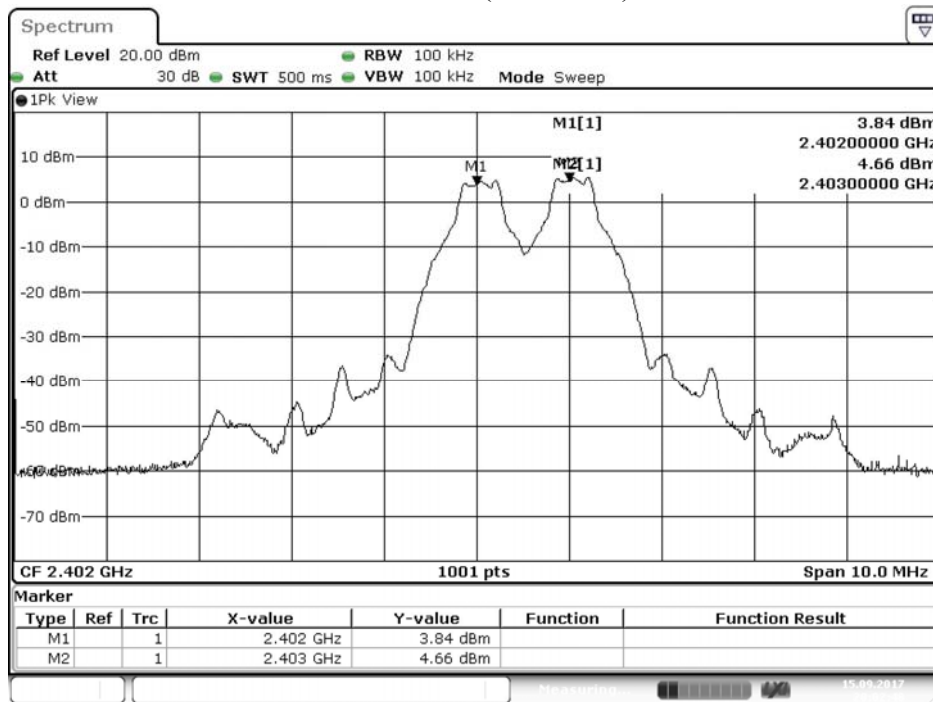

Date: 15.SEP.2017 20:02:48

Channel 39 (2441MHz)



Date: 15.SEP.2017 20:23:10

Channel 78 (2480MHz)

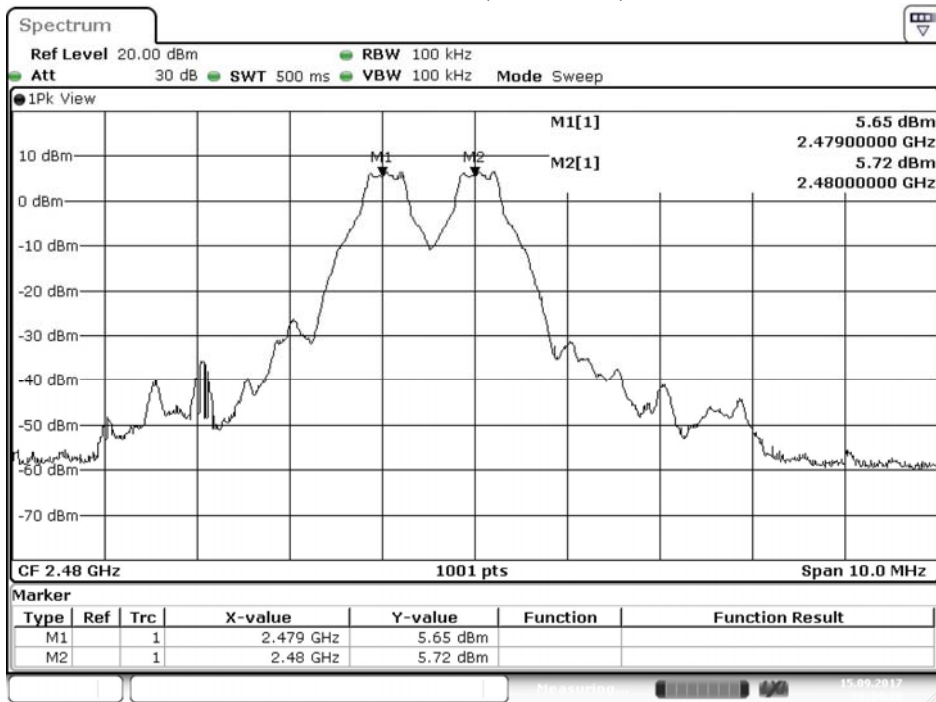

Date: 15.SEP.2017 20:34:21

Product : VistaHub Wifi only
 Test Item : Channel Separation
 Test Mode : Mode 2: Transmit - 3Mbps

Channel No.	Frequency (MHz)	Measurement Level (kHz)	Limit (kHz)	Limit of (2/3)*20dB Bandwidth (kHz)	Result
00	2402	1000	>25 kHz	856.0	Pass
39	2441	1000	>25 kHz	852.0	Pass
78	2480	1000	>25 kHz	854.0	Pass

NOTE: The 20dB Bandwidth is refer to section 10.

Channel 00 (2402MHz)

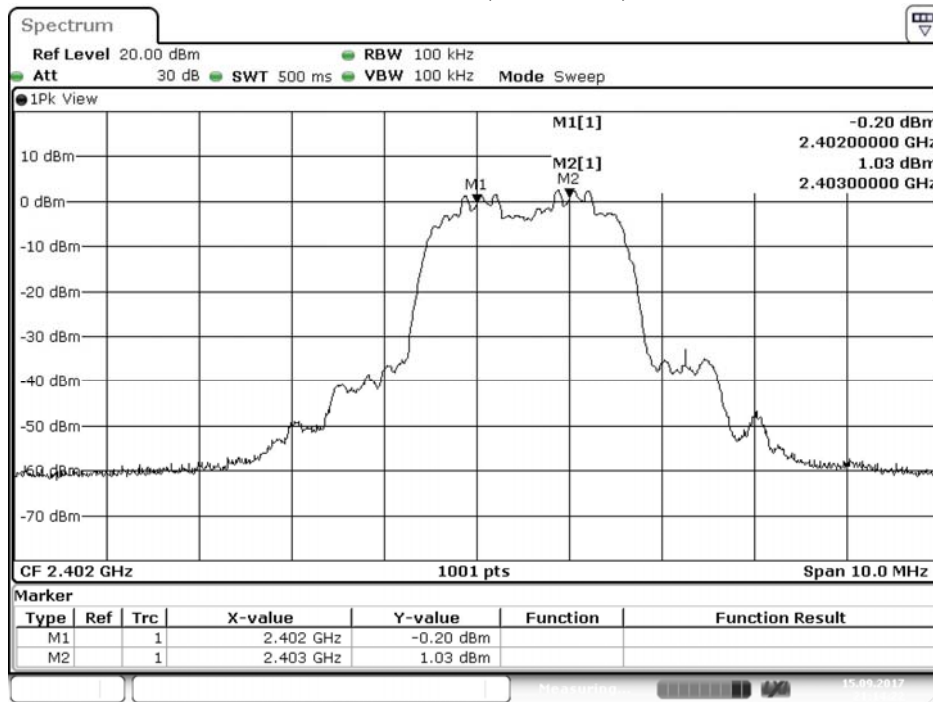

Date: 15.SEP.2017 21:14:23

Channel 39 (2441MHz)

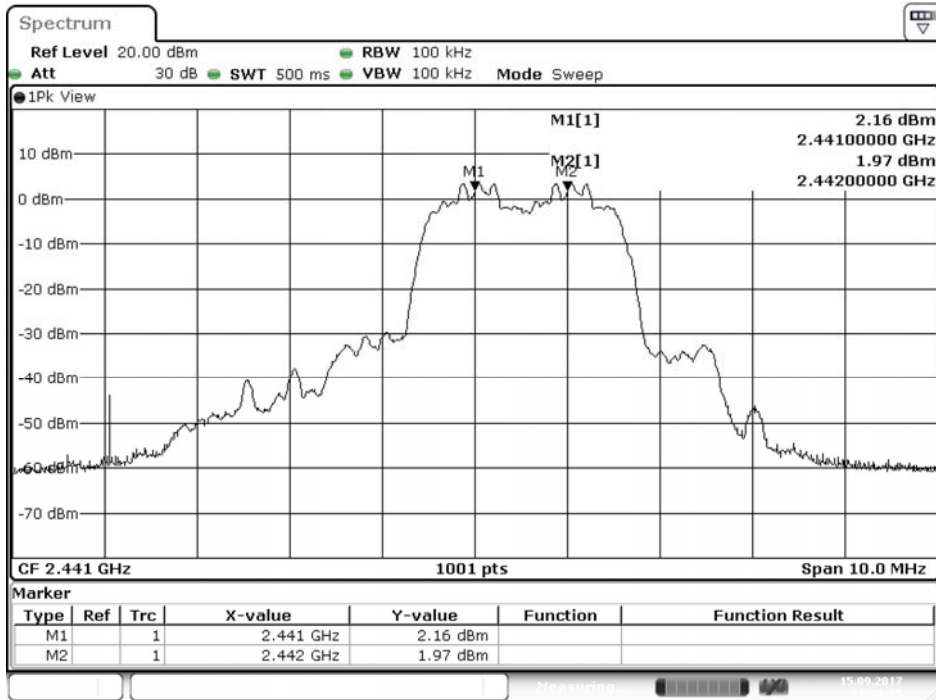

Channel 78 (2480MHz)

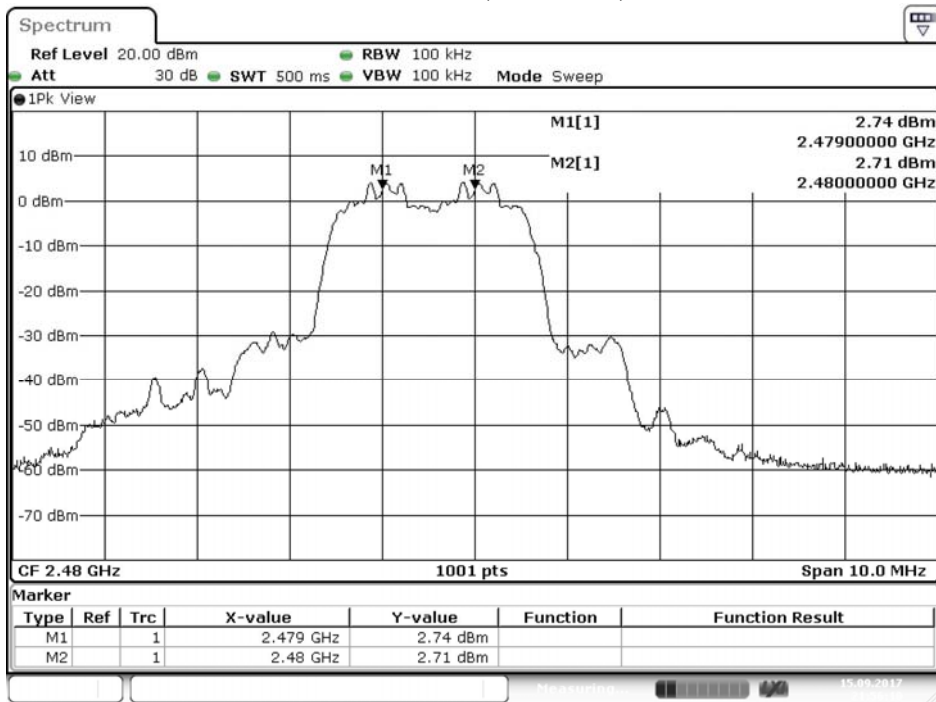

9. Dwell Time

9.1. Test Setup

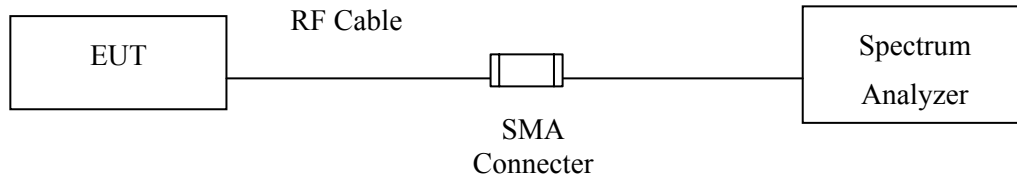

9.2. Limit

The average time of occupancy on any channel shall not be greater than 0.4 seconds within a period of 0.4 seconds multiplied by the number of hopping channels employed.

9.3. Test Procedure

The EUT was setup to ANSI C63.4, 2014; tested to FHSS test procedure of FCC Public Notice DA 00-705 for compliance to FCC 47CFR 15.247 requirements.

9.4. Uncertainty

± 2.31 msec

9.5. Test Result of Dwell Time

Product : VistaHub Wifi only
 Test Item : Dwell Time
 Test Mode : Mode 1: Transmit - 1Mbps (Channel 00,39,78)

Frequency (MHz)	Time slot length (ms)	Hopping of Number	Sweep time (ms)	Duty cycle	Dwell Time (Sec)	Limit (Sec)	Result
2402	2.887	13	50	0.75	0.300	0.4	Pass
2441	2.887	13	50	0.75	0.300	0.4	Pass
2480	2.897	13	50	0.75	0.301	0.4	Pass

Duty cycle = ((Time slot length(ms)*Hopping of Number) / Sweep time (ms)

Dwell time = (Duty cycle /79) * (79*0.4)

CH 00 Hopping of Number

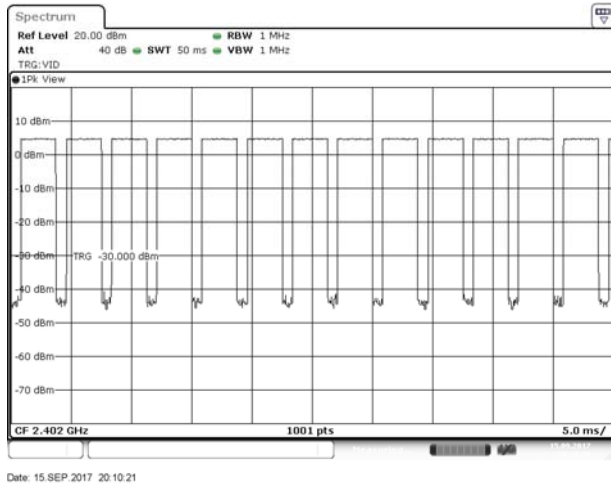

Date: 15.SEP.2017 20:10:21

CH 00 Time slot length

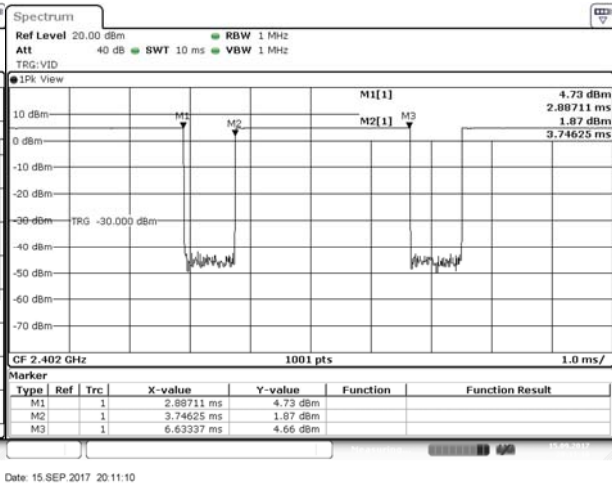

Date: 15.SEP.2017 20:11:10

CH39 Hopping of Number

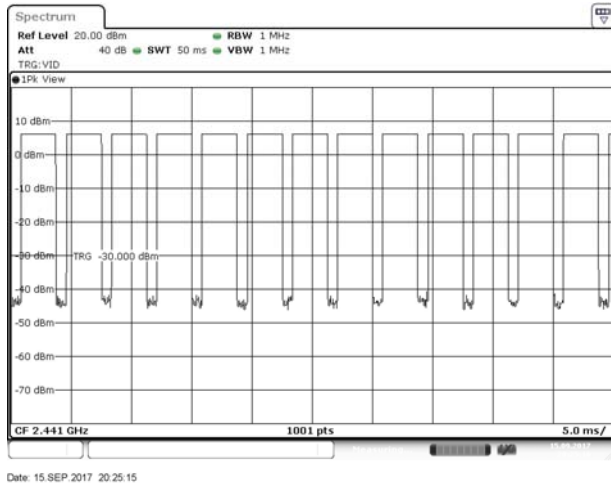

Date: 15.SEP.2017 20:25:15

CH 39 Time slot length

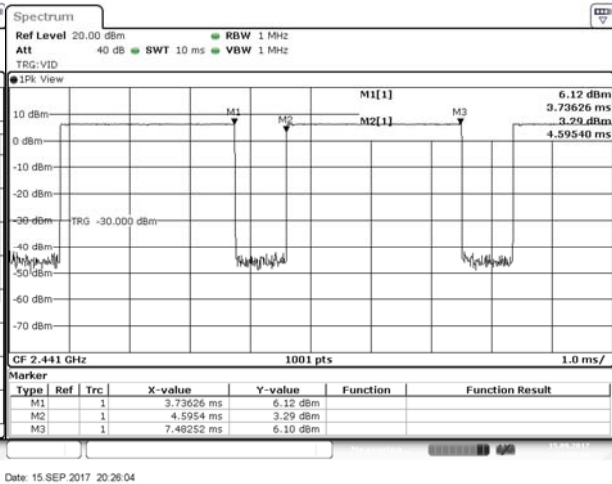

Date: 15.SEP.2017 20:26:04

CH 78 Hopping of Number

CH 78 Time slot length

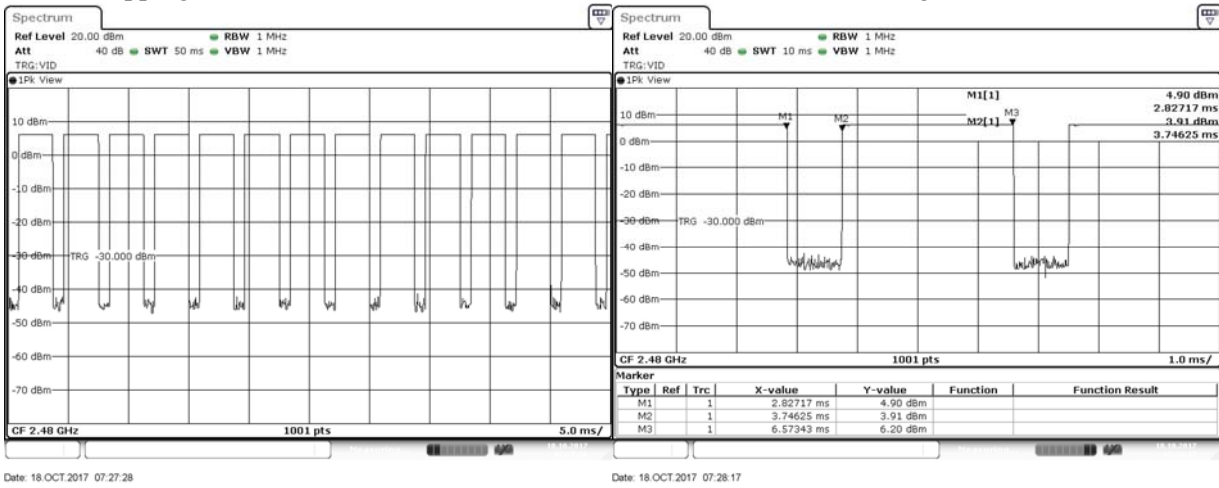

Note:

The dwell times of the packet type of DH1, DH3, and DH5 are tested. Only the worst case is shown on the report.

Product : VistaHub Wifi only
 Test Item : Dwell Time
 Test Mode : Mode 2: Transmit - 3Mbps (Channel 00,39,78)

Frequency (MHz)	Time slot length (ms)	Hopping of Number	Sweep time (ms)	Duty cycle	Dwell Time (Sec)	Limit (Sec)	Result
2402	2.897	13	50	0.75	0.301	0.4	Pass
2441	2.897	13	50	0.75	0.301	0.4	Pass
2480	2.897	13	50	0.75	0.301	0.4	Pass

Duty cycle = ((Time slot length(ms)*Hopping of Number) / Sweep time (ms))

Dwell time = (Duty cycle /79) * (79*0.4)

CH 00 Hopping of Number

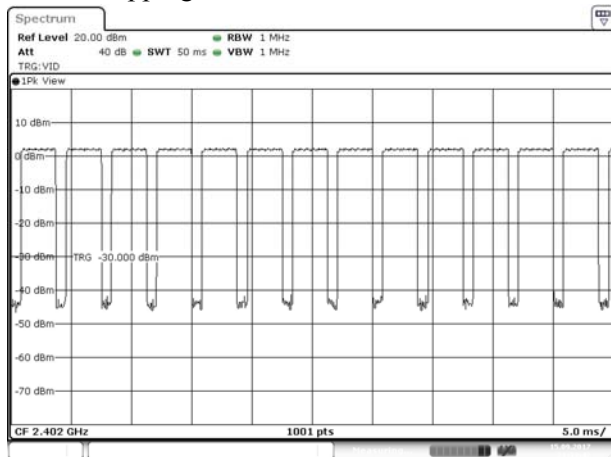

Date: 15.SEP.2017 21:33:43

CH 00 Time slot length

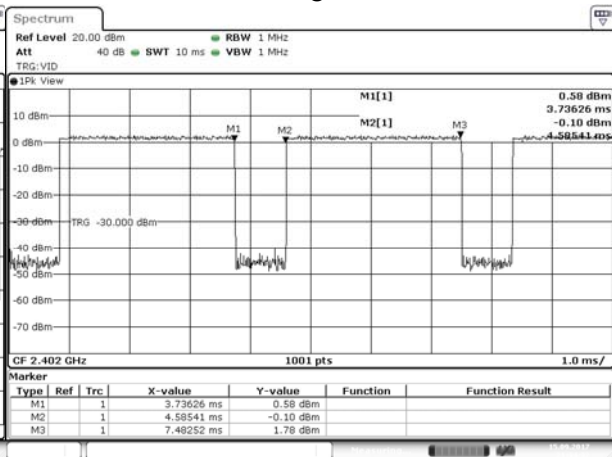

Date: 15.SEP.2017 21:34:32

CH39 Hopping of Number

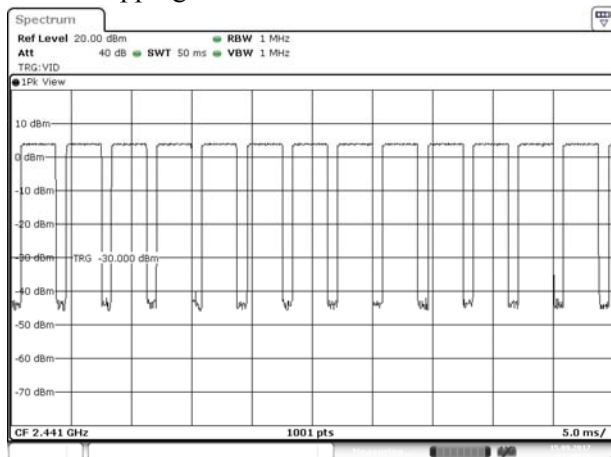

Date: 15.SEP.2017 21:48:24

CH 39 Time slot length

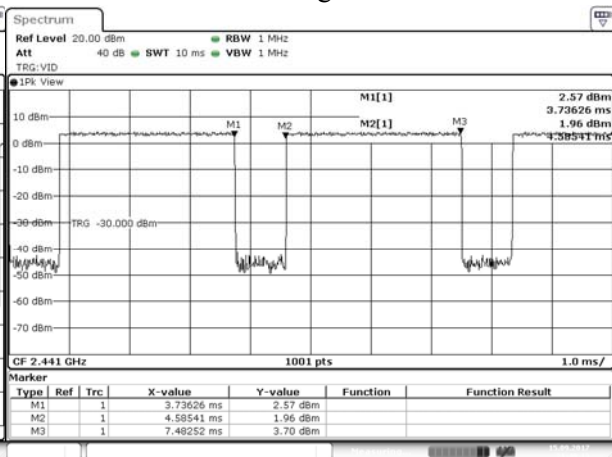

Date: 15.SEP.2017 21:49:13

CH 78 Hopping of Number

CH 78 Time slot length

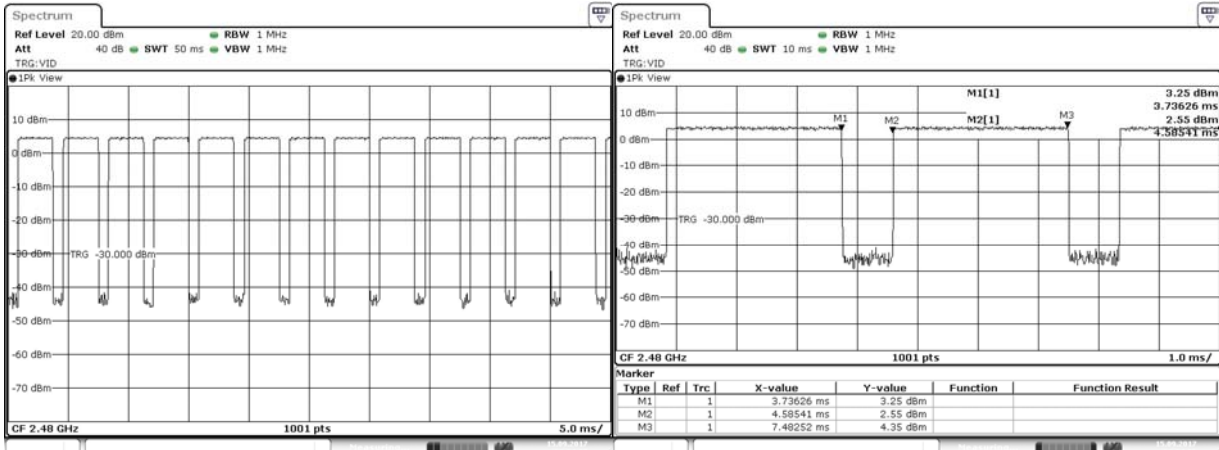

Date: 15.SEP.2017 22:04:08

Date: 15.SEP.2017 22:04:57

Note:

The dwell times of the packet type of DH1, DH3, and DH5 are tested. Only the worst case is shown on the report.

10. Occupied Bandwidth

10.1. Test Setup

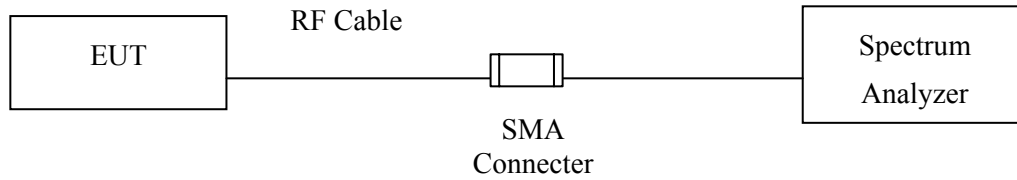

10.2. Limits

N/A

10.3. Test Procedure

The EUT was setup to ANSI C63.4, 2014; tested to FHSS test procedure of FCC Public Notice DA 00-705 for compliance to FCC 47CFR 15.247 requirements.

10.4. Uncertainty

$\pm 279.2\text{Hz}$

10.5. Test Result of Occupied Bandwidth

Product : VistaHub Wifi only
 Test Item : Occupied Bandwidth Data
 Test Mode : Mode 1: Transmit - 1Mbps

Channel No.	Frequency (MHz)	Measurement Level (kHz)	Required Limit (kHz)	Result
00	2402	960	--	NA
39	2441	972	--	NA
78	2480	960	--	NA

Figure Channel 00:

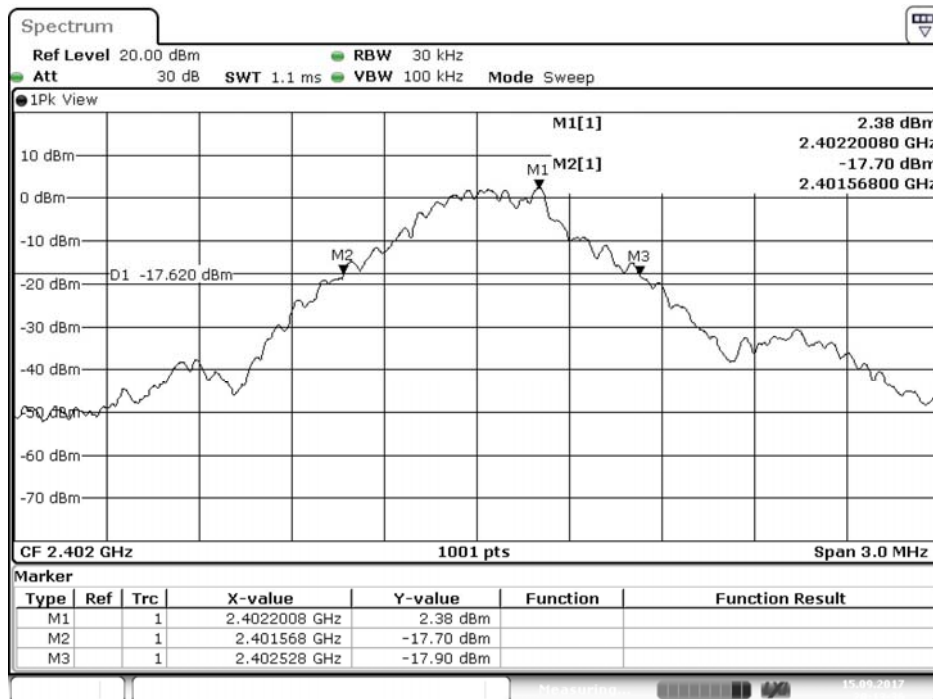

Date: 15.SEP.2017 20:13:36

Figure Channel 39:

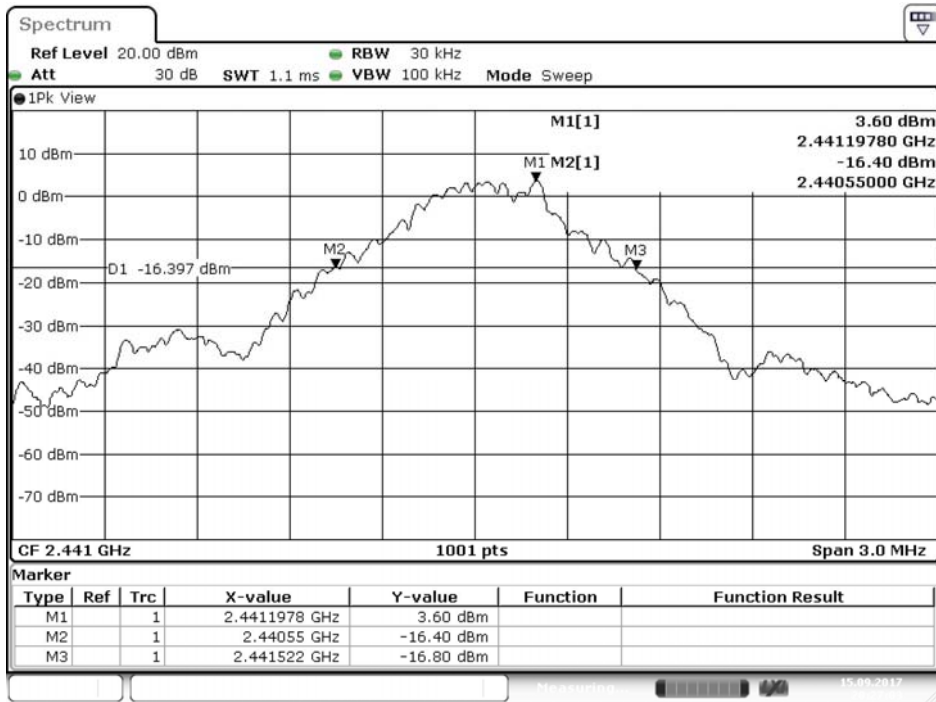

Date: 15.SEP.2017 20:27:04

Figure Channel 78:

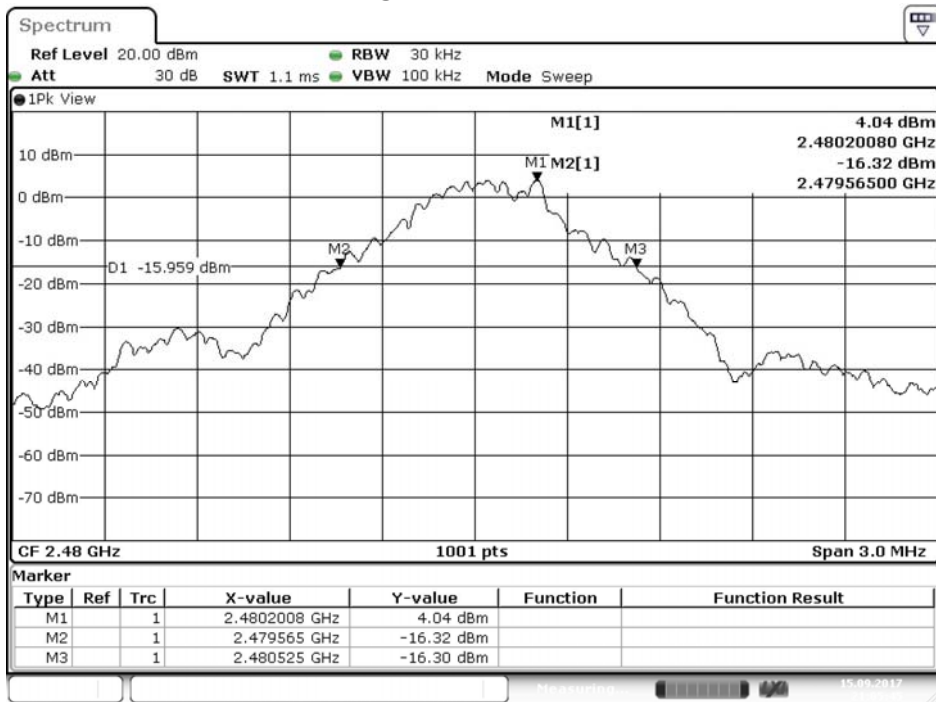

Date: 15.SEP.2017 21:05:45

Product : VistaHub Wifi only
 Test Item : Occupied Bandwidth Data
 Test Mode : Mode 2: Transmit - 3Mbps

Channel No.	Frequency (MHz)	Measurement Level (kHz)	Required Limit (kHz)	Result
00	2402	1284	--	NA
39	2441	1278	--	NA
78	2480	1281	--	NA

Figure Channel 00:

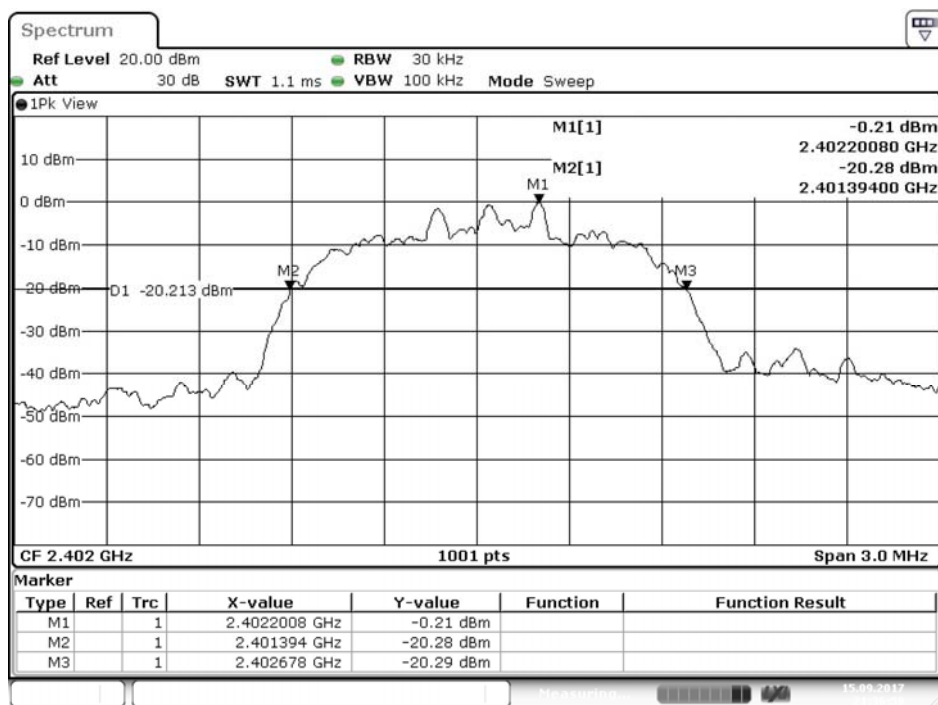

Date: 15.SEP.2017 21:36:58

Figure Channel 39:

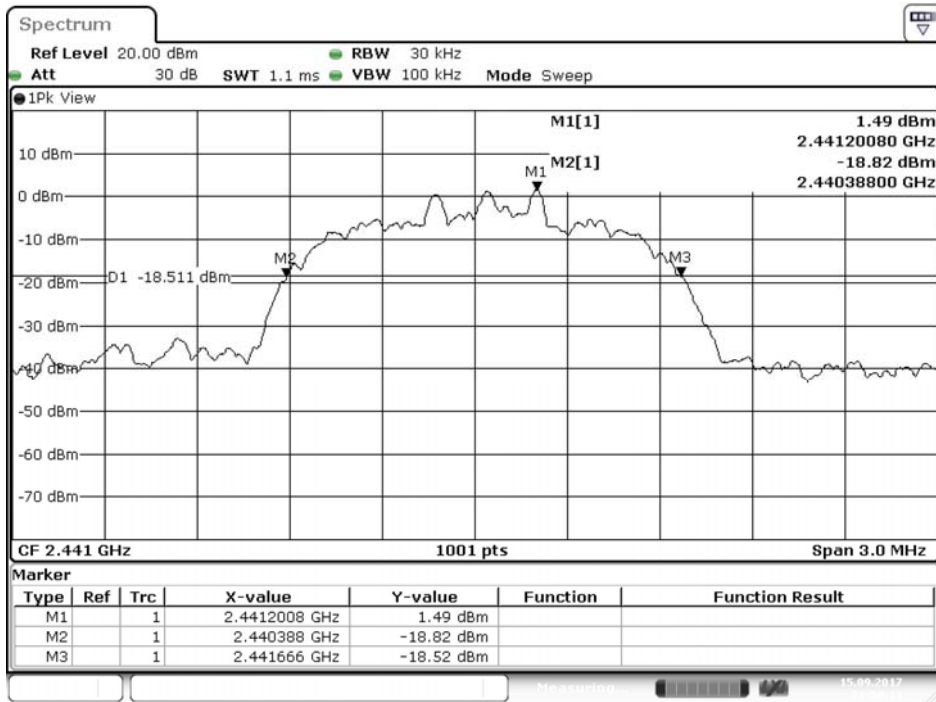
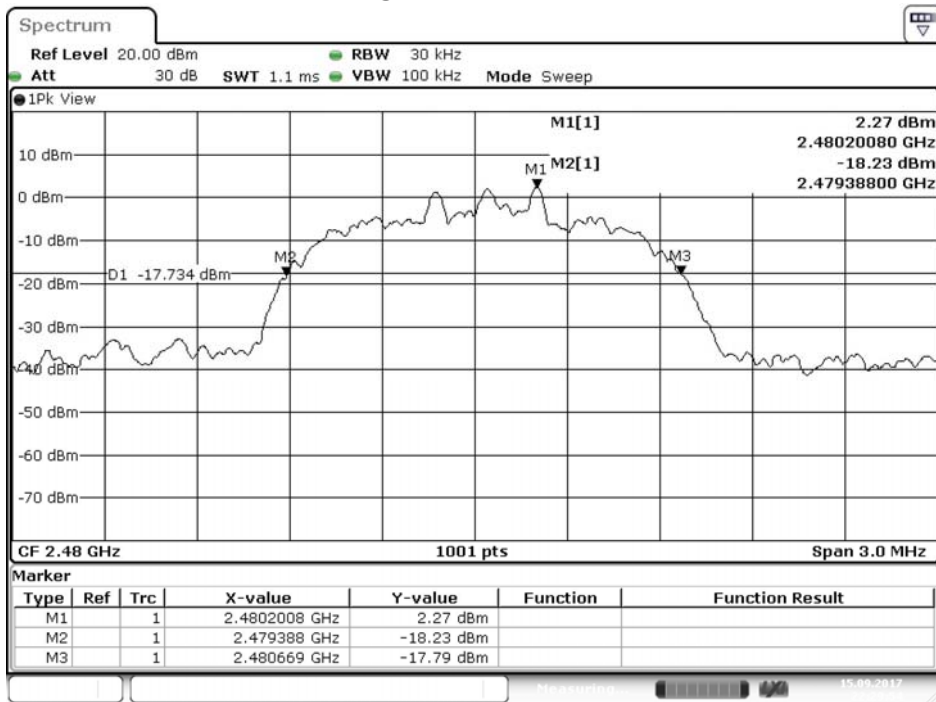

Figure Channel 78:



11. EMI Reduction Method During Compliance Testing

No modification was made during testing.