

Medical Tablet PC

MEDPC-6200

MedPC-6200

Intel® Cherry Trail Z8350 Processor
Medical Box PC

MedPC-6200 Manual 1st Ed
Aug, 2017

Copyright Notice

This document is copyrighted, 2017. All rights are reserved. The original manufacturer reserves the right to make improvements to the products described in this manual at any time without notice.

No part of this manual may be reproduced, copied, translated, or transmitted in any form or by any means without the prior written permission of the original manufacturer. Information provided in this manual is intended to be accurate and reliable. However, the original manufacturer assumes no responsibility for its use, nor for any infringements upon the rights of third parties, which may result from its use.

The material in this document is for product information only and is subject to change without notice. While reasonable efforts have been made in the preparation of this document to assure its accuracy, ONYX Healthcare Inc., assumes no liabilities resulting from errors or omissions in this document, or from the use of the information contained herein

ONYX Healthcare Inc. reserves the right to make changes in the product design without notice to its users

Acknowledgments

- Intel® Cherry Trail is registered trademarks of Intel® Corporation.
- Microsoft® Windows is a registered trademark of Microsoft® Corporation.

All other product names or trademarks are properties of their respective owners.

Packing List

Before you begin installing your Medical Box PC, please make sure that the following items have been shipped:

- MedPC-6200 Medical Box PC
- Medical Power Adapter 5V/3.5A
- WiFi/BT Antenna
- VESA Mounting Bracket

If any of these items are missing or damaged, you should contact your distributor or sales representative immediately.

Headquarters

Onyx Healthcare Inc.

2F, No.135, Lane 235, Pao-Chiao Rd.,

Hsin-Tien City, Taipei 231, Taiwan, R.O.C.

TEL: +886-2-8919-2188

FAX: +886-2-8919-1699

E-mail: sales@onyx-healthcare.com

<http://www.onyx-healthcare.com>

Worldwide Offices:

Onyx Healthcare, USA Inc.

324W. Blueridge Ave., Orange,, CA 92865, USA

Tel : +1-714-792-0774

Fax: +1-714-792-0481

Email: usasales@onyx-healthcare.com

Onyx Healthcare EUROPE B.V.

Primulalaan 42, 5582 GL Waalre, Netherlands

Tel : +31(0)499-745600

Email: eusales@onyx-healthcare.com

Medical Tablet PC

MEDPC-6200

Onyx Healthcare (Shanghai) INC.

20F, unit D, GEM Building, No. 487 Tianlin Road,

Shanghai, China

Tel: +86-021-64956588

Fax: +86-021-64956889

Email: cnsales@onyx-healthcare.com

Safety & Warranty

1. Read these safety instructions carefully.
2. Keep this user's manual for later reference.
3. Disconnect this equipment from any AC outlet before cleaning. Do not use liquid or spray detergents for cleaning. Use a damp cloth.
4. For pluggable equipment, the power outlet must be installed near the equipment and must be easily accessible.
5. Keep this equipment away from humidity.
6. Put this equipment on a reliable surface during installation. Dropping it or letting it fall could cause damage.
7. The openings on the enclosure are for air convection. Protect the equipment from overheating. **DO NOT COVER THE OPENINGS.**
8. **Make sure the voltage of the power source is correct before connecting the equipment to the power outlet.**
9. **Warning: To avoid risk of electric shock, this equipment must only be connected to a supply mains with protective earth.**
(Avertissement: Pour éviter tout risque de choc électrique, cet appareil doit être connecté à une alimentation secteur avec une prise de terre)
10. Position the power cord so that people cannot step on it. Do not place anything over the power cord.
11. All cautions and warnings on the equipment should be noted.
12. If the equipment is not used for a long time, disconnect it from the power source to avoid damage by transient over-voltage.

13. Never pour any liquid into an opening. This could cause fire or electrical shock.
14. **Never open the equipment. For safety reasons, only qualified service personnel should open the equipment.**
15. **Warning: Do not modify this equipment without authorization of the manufacturer. (Avertissement: Ne pas modifier cet équipement sans l'autorisation du fabricant)**
16. **Warning : It is necessary for checking or replacing the battery pack every year. (Avertissement: Il est nécessaire de vérifier ou de remplacer la batterie chaque année)**

- 16. If any of the following situations arises, get the equipment checked by service personnel:**
- The power cord or plug is damaged.
 - Liquid has penetrated into the equipment.
 - The equipment has been exposed to moisture.
 - The equipment does not work well, or you cannot get it to work according to the users manual.
 - The equipment has been dropped and damaged.
 - The equipment has obvious signs of breakage.
- 17. DO NOT LEAVE THIS EQUIPMENT IN AN UNCONTROLLED ENVIRONMENT WHERE THE STORAGE TEMPERATURE IS BELOW -20° C (-4°F) OR ABOVE 60° C (140° F). IT MAY DAMAGE THE EQUIPMENT.**
- 18. External equipment intended for connection to signal input/output or other connectors, shall comply with relevant UL / IEC standard (e.g. UL 1950 for IT equipment and ANSI/AAMI ES 60601-1: 2005 AND CAN/CSA-C22.2 No. 60601-1:08 / IEC 60601 series for systems – shall comply with the standard IEC 60601-1-1, Safety requirements for medical electrical systems. Equipment not complying with UL 60601-1 shall be kept outside the patient environment, as defined in the standard.**
- 19. Unplug the power cord from the power adapter jack to disconnect the device.**

Caution:

It may cause the danger of explosion if battery is incorrectly replaced. Replace only with same or equivalent type recommended by the manufacturer.

Classification

1. Degree of protection against electric shock: not classified
2. Degree of protection against the ingress of water: IPX0
3. Mode of operation: Continuous
4. Type of protection against electric shock: Class I equipment
5. No Applied Part, No AP/APG

FCC

Warning!









This device complies with Part 18 FCC Rules. Operation is subject to the following two conditions: (1) this device may not cause harmful interference, and (2) this device must accept any interference received including interference that may cause undesired operation.

UL Module Description

 The logo features the word "CLASSIFIED" in a curved path above a central circle containing the letters "UL". Below the circle, the letters "C" and "US" are positioned on either side.	<p><i>MEDPC-6200 modules are developed to suitable for the Classification Mark requirement</i></p>
--	--

Safety Symbol Description

The following safety symbols are the further explanations for your reference.

	<p><i>Medical equipment with respect to electric shock, fire and mechanical hazards only in accordance with ANSI/AAMI ES 60601-1: 2005 AND CAN/CSA-C22.2 No. 60601-1:08</i></p>
	<p><i>Attention, consult ACCOMPANYING DOCUMENTS.</i></p>
	<p><i>Stand-by</i></p>
	<p><i>Ground wire Protective Ground wire.</i></p>
	<p><i>Alternating current</i></p>
	<p><i>Direct current</i></p>

Contents

Chapter 1 General Information

1.1 Introduction	1-2
1.2 Feature	1-3
1.3 Specification	1-4
1.4 Dimension	1-8

Chapter 2 Hardware Installation

2.1 Safety Precautions	2-2
2.2 Quick Tour of the MEDPC-6200	2-3
2.3 Turn On and Boot up into Windows	2-7
2.4 Turn off	2-7

Chapter 3 Driver Installation

Appendix A Miscellanea

A.1 General Cleaning Tips	C-2
A.2 Cleaning Tools	C-3
A.3 Scrap Computer Recycling	C-5

Chapter

1

**General
Information**

1.1 Introduction

Vital Sign is a building block of all the tasks nurses do every day, and also a fundamental element for doctors to determine what kind of treatment and medication should to be given. How to optimize nurses' time and improve the data correctness by automating the vital sign frontline reporting is the winning key to deliver an excellent nursing care service.

MedPC-6200 is designed for this purpose. With the integration of wearable sensors and intuitive software UI, MedPC-6200 is working as a Gateway to transfer and document all the data liked NIBP, SpO2, pulse rate and temperature into HL7 format, which is a common protocol nowadays to be addressed by many different world-known EMR software.

By consistency, doctors/clinicians can utilize the data among the ward, operation room, nurse station, pharmacy, and even outside facilities, like hemodialysis center, nursing care house and home.

1.2 Feature

- Intel® Cherry Trail processor
- Win10 64 bit and Android 6.0 compatible
- Compact & light weight design for installation
- Standard USB Type-A for easy connection with medical device
- Support VESA 75 via mounting brackets
- CE/FCC Class-B LV4, EN60601-1 & UL60601-1 V3.1, CE/FCC RF Certified

1.3 Specification

Main System Specifications

CPU	Intel® Cherry Trail Z8350 1.44GHz (2M Cache, up to 1.92 GHz)
System Memory	DDR3L on board, default support 2GB (1GB/2GB/4GB)
Storage	eMMC on board, default support 32GB (16GB/32GB/64GB)
I/O	USB 2.0 (Type-A) x4 Gb Ethernet RJ45 x1 HDMI Out x1 DC-In Jack x1 Power Button x1
Communications	A. WiFi: GWF-4M02 1T1R B. BT: XHT-08X 1T1R
Audio Codec	REALTEK.ALC5672-VB-CGT
LAN Chip	No Wake on LAN
Speaker	NA
Security	No TPM
Power input	5V DC
Battery	RTC Coin Battery
System Cooling	Fan less

Front Panel Design

Control Button	N/A
DMIC	N/A
Camera	N/A
RFID	N/A
Smart Card Reader	N/A
LED Indicator	N/A

Display Specification

LCD size	N/A
Brand	N/A
LCD Model Number	N/A
Resolution	N/A
Luminance (cd/m2)	N/A
Contrast Ratio	N/A
Viewing Angel	N/A
Interface	N/A
Backlight Life Time (Hrs.)	N/A
Weight	N/A

Touch Screen Specification

Touch Type	N/A
Brand	N/A
Touch Model Number	N/A
TS Controller	N/A
Interface	N/A

Power Adapter Specification

Model	Medical Adapter
AC input	100-240V AC@50-60 Hz
DC output	5V / 3.5A, 17.5W max

Mechanical Specifications

Architecture	Aluminum Top Cover + Metal Bottom Base
Color	Top Cover: Blue; Bottom Base: Blue
Mounting	VESA 75mm (Via VESA Cradle)
Dimension (W x H x D)	130 x 93 x 33 (mm)
Net Weight	Approx. 1Kg

1.4 Dimension

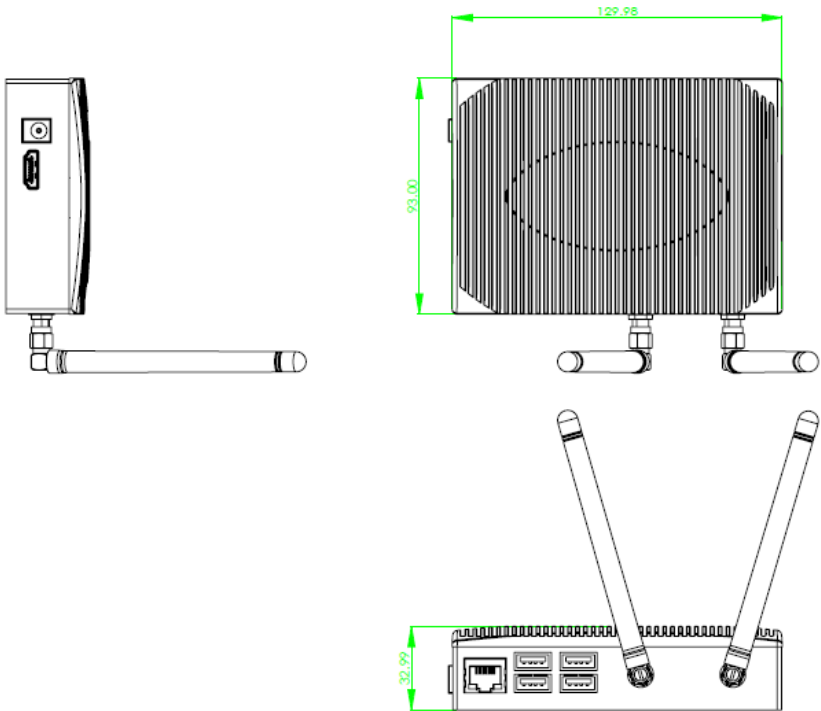

Chapter

2

**Hardware
Installation**

2.1 Safety Precautions

Warning!

Always completely disconnect the power cord from your board whenever you are working on it. Do not make connections while the power is on, because a sudden rush of power can damage sensitive electronic components.

Caution!

Always ground yourself to remove any static charge before touching the board. Modern electronic devices are very sensitive to static electric charges. Use a grounding wrist strap at all times. Place all electronic components on a static-dissipative surface or in a static-shielded bag when they are not in the chassis

2.2 Quick Tour of the MedPC-6200

Before you start to set up MedPC-6200, take a moment to become familiar with the locations and purposes of the controls, drives, connections and ports, which are illustrated in the figures below.

When you place MedPC-6200 on the desktop, its top cover appears as shown in Picture 2-1. When you turn the MedPC-6200 to the back side, the I/O includes four USB and one Ethernet and two dipole antennas for WiFi and BT connectivity, shown in Picture 2-2.

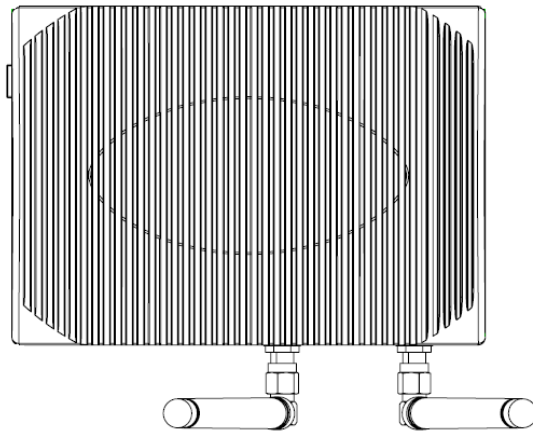

Picture 2.1: Top View of the MedPC-6200

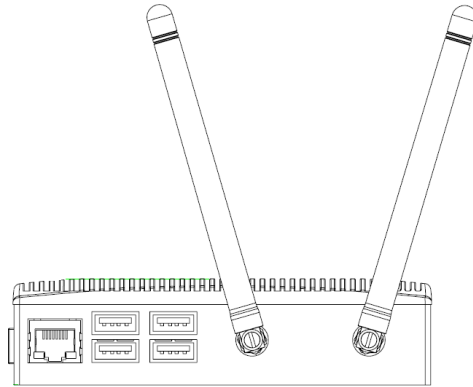

Picture 2.2: Rear View of the MedPC-6200

When you turn the MedPC-6200 and see it from left, it contains a HDMI out and a DC-In jack.

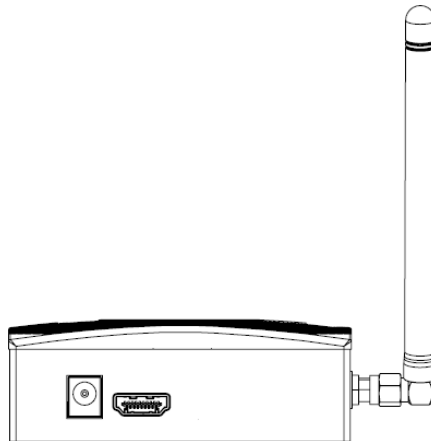

Picture 2.3: Left View of the MedPC-6200

MedPC-6200 comes with a VESA mounting kit, which includes a standard VESA 75 holes for wall mount, desk mount or floor mount.

2.3 Turn On and Boot up into Windows and Android OS

This section is for Windows and Android operating system only. If you are installing a different operating system, please contact your vendor for installation details.

Your MedPC-6200 will begin loading Windows/Android OS once you push the power button to turn power on. After less than one minute, Windows/Android desktop screen will appear.

You can select the programs from the start menu in the left-down corner of the desktop screen.

2.4 Turn off

Turning off MEDPC-6200 properly is important for system reliability. There are two ways to turn off the system.

1. On the start menu, click “shut down” and select “OK”
2. Push the power button and then the system will shut down automatically

Chapter

3

**Driver
Installation**

There are several installation ways depending on the driver package under different Operating Systems.

Please follow the sequence below to install the drivers:

For Windows 10 Only

Step 1 – Chipset

Step 2 – WiFi

Step 3 – BT

Appendix

A

Miscellanea

A.1 General Cleaning Tips

You may need the following precautions before you begin to clean the computer. When you clean any single part or component for the computer, please read and understand the details below fully.

1. Never spray or squirt the liquids directly onto any computer component. If you need to clean the device, please rub it with a piece of dry cloth.
2. Be cautious of the tiny removable components when you use a vacuum cleaner to absorb the dirt on the floor.
3. Turn the system off before you start to clean up the component or computer.
4. Never drop the components inside the computer or get circuit board damp or wet.
5. Be cautious of all kinds of cleaning solvents or chemicals when you use it for the sake of cleaning. Some individuals may be allergic to the ingredients.
6. Try not to put any food, drink or cigarette around the computer.
7. ONYX Healthcare Inc. has tested and verified these cleaning disinfectants, CIDEX, Viraguard, Control III Disinfectant Germicide, Caviwipes, Dispatch Disinfectant Cleaner CLH69101, Puregreen 24 Disinfectant, can be used with the MEDPC-6200. Use of any other disinfectants will void the warranty.

A.2 Cleaning Tools

Although many companies have created products to help improve the process of cleaning your computer and peripherals users can also use household items to clean their computers and peripherals. Below is a listing of items you may need or want to use while cleaning your computer or computer peripherals.

Keep in mind that some components in your computer may only be able to be cleaned using a product designed for cleaning that component, if this is the case it will be mentioned in the cleaning tips.

- **Cloth** - A piece of cloth is the best tool to use when rubbing up a component. Although paper towels or tissues can be used on most hardware as well, we still recommend you to rub it with a piece of cloth.
- **Water or rubbing alcohol** – You may moisten a piece of cloth a bit with some water or rubbing alcohol and rub it on the computer. Unknown solvents may be harmful to the plastics parts.
- **Vacuum cleaner** - Absorb the dust, dirt, hair, cigarette particles, and other particles out of a computer can be one of the best methods of cleaning a computer. Over time these items can restrict the airflow in a computer and cause circuitry to corrode.
- **Cotton swabs** - Cotton swabs moistened with rubbing alcohol or water are excellent tools for wiping hard to reach areas in your keyboard, mouse, and other locations.

- **Foam swabs** - Whenever possible it is better to use lint free swabs such as foam swabs.

Note:

We strongly recommended that you should shut down the system before you start to clean any single components.

Please follow the steps below.

1. Close all application programs.
2. Close operating software.
3. Turn off power switch
4. Remove all device
5. Pull out power cable

A.3 Scrap Computer Recycling

If the computer equipments need the maintenance or are beyond repair, we strongly recommended that you should inform us as soon as possible for the suitable solution. For the computers that are no longer useful or work well, please contact with worldwide distributors for recycling.

The worldwide distributors show on the following website:

<http://www.onyx-healthcare.com.tw/Contact.php>

Note:

Follow the national requirement to dispose unit

FEDERAL COMMUNICATIONS COMMISSION INTERFERENCE STATEMENT

This equipment has been tested and found to comply with the limits for a Class B digital device, pursuant to part 15 of the FCC Rules. These limits are designed to provide reasonable protection against harmful interference in a residential installation. This equipment generates, uses and can radiate radio frequency energy and, if not installed and used in accordance with the instructions, may cause harmful interference to radio communications. However, there is no guarantee that interference will not occur in a particular installation. If this equipment does cause harmful interference to radio or television reception, which can be determined by turning the equipment off and on, the user is encouraged to try to correct the interference by one or more of the following measures:

- Reorient or relocate the receiving antenna.
- Increase the separation between the equipment and receiver.
- Connect the equipment into an outlet on a circuit different from that to which the receiver is connected.
- Consult the dealer or an experienced radio/ TV technician for help.

CAUTION:

Any changes or modifications not expressly approved by the grantee of this device could void the user's authority to operate the equipment.

RF exposure warning

This equipment must be installed and operated in accordance with provided instructions and the antenna(s) used for this transmitter must be installed to provide a separation distance of at least 20 cm from all persons and must not be co-located or operating in conjunction with any other antenna or transmitter. End-users and installers must be provided with antenna installation instructions and transmitter operating conditions for satisfying RF exposure compliance.

This radio transmitter FCCID: RZ5-MEDPC-6200-A has been approved by FCC to operate with the antenna types listed below with the maximum permissible gain and required antenna impedance for each antenna type indicated. Antenna types not included in this list, having a gain greater than the maximum gain indicated for that type, are strictly prohibited for use with this device.

Antenna List

No.	Manufacturer	Part No.	Antenna Type	Peak Gain
1	ARISTOTLE	RFA-25-L14M3-B32	Dipole	2.5dBi for WLAN
2	ARISTOTLE	RFA-25-L14M3-B32	Dipole	2.5dBi for Bluetooth
3	ARISTOTLE	RFA-25-L14M3-B32	Dipole	3.5dBi for 5GHz

Note: The antenna connector is Reverse SMA type.