

ONYX-MD116

11.6" LCD with LED Backlight

Intel® Apollo Lake processor

Dual smart card readers for multiple-care workflow

Instant vehicle docking system

Mobile Medical Assistant

ONYX-MD116 Manual 1st Ed
June., 2017

Copyright Notice

This document is copyrighted, 2017. All rights are reserved. The original manufacturer reserves the right to make improvements to the products described in this manual at any time without notice.

No part of this manual may be reproduced, copied, translated, or transmitted in any form or by any means without the prior written permission of the original manufacturer. Information provided in this manual is intended to be accurate and reliable. However, the original manufacturer assumes no responsibility for its use, nor for any infringements upon the rights of third parties, which may result from its use.

The material in this document is for product information only and is subject to change without notice. While reasonable efforts have been made in the preparation of this document to assure its accuracy, ONYX Healthcare Inc., assumes no liabilities resulting from errors or omissions in this document, or from the use of the information contained herein

ONYX Healthcare Inc. reserves the right to make changes in the product design without notice to its users



Acknowledgments

- Intel® Pentium™ is registered trademarks of Intel® Corporation.
- Microsoft® Windows is a registered trademark of Microsoft® Corporation.

All other product names or trademarks are properties of their respective owners.



Packing List

Before you begin installing your Mobile Medical Assistant, please make sure that the following items have been shipped:

- ONYX-MD116 Mobile Medical Assistant
- ONYX-MD116 Docking Station
- Four VESA Screws(M:4mm x P:0.7mm x L:10mm)



If any of these items are missing or damaged, you should contact your distributor or sales representative immediately.

Headquarters

Onyx Healthcare Inc.

2F, No.135, Lane 235, Pao-Chiao Rd.,

Hsin-Tien City, Taipei 231, Taiwan, R.O.C.

TEL: +886-2-8919-2188

FAX: +886-2-8919-1699

E-mail: sales@onyx-healthcare.com

<http://www.onyx-healthcare.com>

Worldwide Offices:

Onyx Healthcare Inc.

2F., No.135, Ln. 235, Baoqiao Rd., Xindian Dist.,

New Taipei City 231, Taiwan (R.O.C.)

TEL: +886-2-8919-2188

FAX: +886-2-8919-1699

E-mail: sales@onyx-healthcare.com

<http://www.onyx-healthcare.com>

Worldwide Offices:

Onyx Healthcare, USA Inc.

324W. Blueridge Ave., Orange,, CA 92865, USA

Tel : +1-714-792-0774

Fax: +1-714-792-0481

Email: usasales@onyx-healthcare.com

Onyx Healthcare EUROPE B.V.

Primulalaan 42, 5582 GL Waalre, Netherlands

Tel : +31-(0)499-745600

Email: eusales@onyx-healthcare.com

Onyx Healthcare (Shanghai) INC.

20F, unit D, GEM Building, No. 487 Tianlin Road,

Shanghai, China

Tel: +86-021-64956588

Fax: +86-021-64956889

Email: cnsales@onyx-healthcare.com



Safety & Warranty

1. Read these safety instructions carefully.
2. Keep this user's manual for later reference.
3. Disconnect this equipment from any AC outlet before cleaning. Do not use liquid or spray detergents for cleaning. Use a damp cloth.
4. For pluggable equipment, the power outlet must be installed near the equipment and must be easily accessible.
5. Keep this equipment away from humidity.
6. Put this equipment on a reliable surface during installation. Dropping it or letting it fall could cause damage.
7. The openings on the enclosure are for air convection. Protect the equipment from overheating. DO NOT COVER THE OPENINGS.
8. **Make sure the voltage of the power source is correct before connecting the equipment to the power outlet.**
9. **Warning: To avoid risk of electric shock, this equipment must only be connected to a supply mains with protective earth. (Avertissement: Pour éviter tout risque de choc électrique, cet appareil doit être connecté à une alimentation secteur avec une prise de terre)**
10. Position the power cord so that people cannot step on it. Do not place anything over the power cord.
11. All cautions and warnings on the equipment should be noted.

12. If the equipment is not used for a long time, disconnect it from the power source to avoid damage by transient over-voltage.
13. Never pour any liquid into an opening. This could cause fire or electrical shock.
14. **Never open the equipment. For safety reasons, only qualified service personnel should open the equipment.**
15. **Warning: Do not modify this equipment without authorization of the manufacturer. (Avertissement: Ne pas modifier cet équipement sans l'autorisation du fabricant)**
16. **Warning : It is necessary for checking or replacing the battery pack every year. (Avertissement: Il est nécessaire de vérifier ou de remplacer la batterie chaque année)**

16. If any of the following situations arises, get the equipment checked by service personnel:

- a. The power cord or plug is damaged.
- b. Liquid has penetrated into the equipment.
- c. The equipment has been exposed to moisture.
- d. The equipment does not work well, or you cannot get it to work according to the users manual.
- e. The equipment has been dropped and damaged.
- f. The equipment has obvious signs of breakage.

17. DO NOT LEAVE THIS EQUIPMENT IN AN UNCONTROLLED ENVIRONMENT WHERE THE STORAGE TEMPERATURE IS BELOW -20° C (-4°F) OR ABOVE 60° C (140° F). IT MAY DAMAGE THE EQUIPMENT.

18. External equipment intended for connection to signal input/output or other connectors, shall comply with relevant UL / IEC standard (e.g. UL 1950 for IT equipment and ANSI/AAMI ES 60601-1: 2005 AND CAN/CSA-C22.2 No. 60601-1:08 / IEC 60601 series for systems – shall comply with the standard IEC 60601-1-1, Safety requirements for medical electrical systems. Equipment not complying with UL 60601-1 shall be kept outside the patient environment, as defined in the standard.

Caution:

It may cause the danger of explosion if battery is incorrectly replaced. Replace only with same or equivalent type recommended by the manufacturer.

Classification

1. Degree of protection against electric shock: not classified
2. Degree of protection against the ingress of water: IPX0
3. Mode of operation: Continuous
4. Type of protection against electric shock: Class I equipment
5. No Applied Part, No AP/APG



FCC

Warning!



This device complies with Part 18 FCC Rules. Operation is subject to the following two conditions: (1) this device may not cause harmful interference, and (2) this device must accept any interference received including interference that may cause undesired operation.





UL Module Description

 The logo consists of a circle with the word "CLASSIFIED" at the top, "C" on the left, "UL" in the center, and "US" on the right.	<p><i>ONYX-MD116 module is developed to suitable for the Classification Mark requirement</i></p>
--	--



Safety Symbol Description

The following safety symbols are the further explanations for your reference.

	<i>MEDICAL – GENERAL MEDICAL EQUIPMENT AS TO ELECTRICAL SHOCK, FIRE AND MECHANICAL HAZARDS ONLY IN ACCORDANCE WITH ANSI/AAMI ES 60601-1 (2005) + AMD (2012) and CAN/CSA-C22.2 No. 6060-1 (2014).</i>
	<i>Attention, consult ACCOMPANYING DOCUMENTS.</i>
	<i>Stand-by</i>
	<i>Ground wire Protective Ground wire.</i>

Contents

Chapter 1 General Information

1.1 Introduction	1-2
1.2 Feature	1-3
1.3 Specification.....	1-4
1.4 Dimension.....	1-8

Chapter 2 Hardware Installation

2.1 Safety Precautions.....	2-2
2.2 Quick Tour of ONYX-MD116.....	2-3
2.3 Mounting.....	2-6
2.4 Turn On and Boot up into Windows.....	2-6
2.5 Turn off.....	2-6

Chapter 3 Driver Installation

Appendix A Miscellanea

A.1 General Cleaning Tips.....	C-2
A.2 Cleaning Tools.....	C-3
A.3 Scrap Computer Recycling	C-5

Chapter

1

General Information

1.1 Introduction

ONYX-MD116 Mobile Medical Assistant is based on Intel® Pentium™ N4200 Quad Core processor, which delivers a performance improvement of more than 100 percent compared to systems running traditional single-core processors. With four cores computing engines, ONYX-MD116 can simultaneously execute four computing tasks. It accommodates one M.2 2242 Interface SATA SSD and one DDRIII SODIMM up to 16GB.

The high brightness LCD, zero noise solution, integrated multimedia functions make them the perfect platform upon which to build comprehensive lifestyle computing applications.

ONYX-MD116 includes all the features of a powerful computer into a slim and attractive chassis. It has a 11.6" 600 nits TFT display with 1920 x 1080 resolution. ONYX-MD116 owns Dual smart card reader to support ID check. Combining ONYX-MD116 into your system can achieve both cost-saving and efficient improvements in common medical applications. ONYX-MD116 is definitely your perfect choice.

1.2 Feature

- Intel® Apollo Lake N4200 Quad Core Processor
- Supports One DDR3 SODIMM up to 16GB
- Built-in RFID and Dual Smart Card Security
- Dual hot-swappable batteries for 24/7 operation
- Instant vehicle docking system
- ORION client compatible

1.3 Specification

Hardware Specifications

Processor	Processor Intel® Apollo Lake Processor
System Memory	DDR3L SO-DIMM x1, Default 4 GB (Up to 16 GB)
OS Support	Microsoft® Windows 10
Storage	M.2 Interface x1, Default 64 GB
Wireless Communication	802.11 a/b/g/n + BT4.0 (Optional)
Camera	2 MP (Front) / 5 MP (Rear)
Touchscreen	w/Soda Lime Glass (Default); Gorilla Glass
Digital Accelerometer	ADI ADXL345
Ambient Light Sensor	TAOS TSL2581
LTE+GPS	Telit LN930 x 2 (Optional)
Function Keys	x2
LED Indicators	x2
USB	USB 3.0 (Type-A) x1, USB 2.0 (Type-A) x1
Ethernet	Gigabit LAN x1
DC-In	DC-In Jack x1
Docking	Docking Connector x1
Battery Type	Polymer
Battery	Capacity 3300 mAh x2

Battery Run Time	Approx. 5 hrs
Speaker	3W x1

LCD Specifications

Display Type	11.6" LCD
Max. Resolution	1920 x 1080
Contrast Ratio	800:1
Luminance (cd/m2)	600TYP)
Back Light Life Time	>50,000 Hrs

Note:

All ONYX LCD products are manufactured with High precision technology. However, there are a small number of defective pixels in all LCD panels that are not able to change color. This is a normal occurrence for all LCD displays from all manufacturers and should not be noticeable or objectionable under normal operation. All LCD panels are qualified for industry standard conditions in the following: total 7 dead pixels on a screen or if there are 3 within 1 inch square area of each other on the display.

Mechanical Specifications

Architecture	Close-frame
Color	Dark Gray
Mounting / Holder	VESA 75/100mm, Screw type:M4*8mm
Construction	3mm ABS + PC TYPE Plastic housing
Rear cover	magnesium
Dimension (WxHxD)	312 (W) x 239 (H) x 37 (D) mm
Net Weight	Approx. 1.8 kg

Power Supply Specifications

Model	Adapter FSP096-AHAN2
Input Voltage	100-240V AC @ 50-60 Hz
Output Voltage	12V, 5A, 96W max.

Environmental Specifications

Operating Temperature	-10°C ~ 55°C (14°F ~ 131°F)
Operating Humidity	30% to 75% RH, non-condensing
Operating Pressure	700 to 1060 hPa
Storage Temperature	-20°C ~ 60°C (-4°F ~ 140°F)
Storage Humidity	10%~95%@35°C, non-condensing
Storage Pressure	700 to 1060 hPa
Vibration	0.5G / 5 ~ 500Hz (Random) / operation
Shock	20G peak acceleration (11 msec. duration) / operation
Drop(with packaging)	80 cm (1 Corner, 3 Edge, 6 Surface)
EMI / Safety	CE/FCC Class B, UL60601-1, EN60601-1, E1, EN1789

Touch Screen

Type	Projective Capacitive / 5-wire Resistive
Interface	USB interface
Light Transmission	> 80%

Docking Station

Power	DC 12~19V
Battery	3300 mAh x2

USB	USB 3.0 (Type-A) x1, USB 2.0 (Type-A) x1
Ethernet	Ethernet Gigabit LAN x1

1.4 Dimension

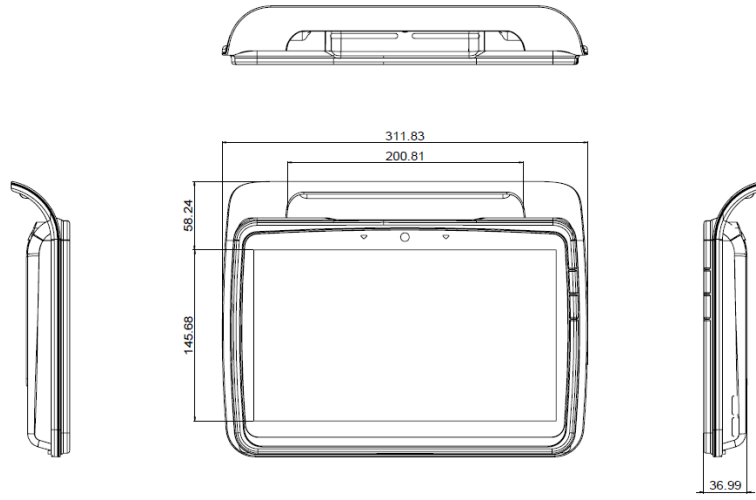

Chapter

2

Hardware Installation

2.1 Safety Precautions

Warning!



Always completely disconnect the power cord from your board whenever you are working on it. Do not make connections while the power is on, because a sudden rush of power can damage sensitive electronic components.

Caution!



Always ground yourself to remove any static charge before touching the board. Modern electronic devices are very sensitive to static electric charges. Use a grounding wrist strap at all times. Place all electronic components on a static-dissipative surface or in a static-shielded bag when they are not in the chassis

2.2 Quick Tour of ONYX-MD116

Before you start to set up ONYX-MD116, take a moment to become familiar with the locations and purposes of the controls, drives, connections and ports, which are illustrated in the figures below. When you place ONYX-MD116 upright on the desktop, its front panel appears as shown in Picture 2-1.



Picture 2.1: Front View of ONYX-MD116 Series

When you turn the Mobile Medical Assistant around and look at its rear cover, the I/O port in left and right side, as shown in Picture 2-2. (The I/O section includes various I/O ports, including a DC-IN Jack, 1 Ethernet ports, 2 USB ports.). Top side have 2 smart card reader.



Picture 2.2 Rear view of ONYX-MD116 Series IO Port

Below picture 2-3/2-4 show the Docking front and rear view. In front view have 2 USB port and Battery charging hole. Back side have DC-IN Jack and phoenix connector/ Line-out/ RJ 45 port.

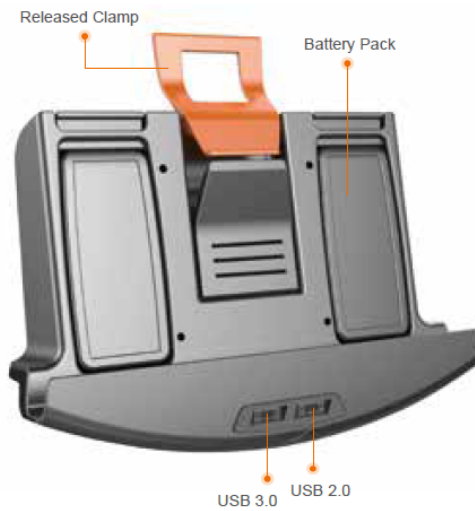

Picture 2.3: ONYX-MD116 Docking front side



Picture 2.4: ONYX-MD116 back side view

2.3 Mounting

ONYX-MD116 Docking be mounted with 75mm x 75mm or 100mm x 100mm VESA holes in the rear cover by wall-mount or desktop stand.

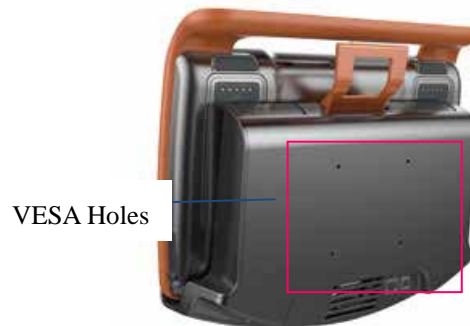

2.4 Turn On and Boot up into Windows OS

This section is for Windows operating system only. If you are installing a different operating system, please contact your vendor for installation details.

Your ONYX-MD116 will begin loading Windows OS once you push the power button to turn power on. After less than one minute, Windows desktop screen will appear.

You can select the programs from the start menu in the left-down corner of the desktop screen.

2.5 Turn off

Turning off ONYX-MD116 properly is important for system reliability. There are two ways to turn off the system.

1. On the start menu, click “shut down” and select “OK”
2. Push the power button and then the system will shut down automatically

2.6 Connectors

1.  **USB 2.0 port** These 4-pin Universal Serial Bus (USB) ports are available for connecting USB 2.0 devices.

2.  **USB 3.0** These 9 Universal Serial Bus (USB) ports are available for connecting USB 3.0 devices.

3. **COM port.** This 9-pin COM port is for serial devices.

4. **LAN (RJ-45) port.** These port allows Gigabit connection

5.  **POTENTIAL EQUALIZATION CONDUCTOR.**
The purpose of additional potential equalization is to equalize potentials between different metal parts that can be touched simultaneously, or to reduce differences of potential which can occur during operation between the bodies of medical electrical devices and conductive parts of other objects. The connector is specially shaped so as to prevent chance disconnection when used as intended, while allowing the lead to be removed without the need for tools.

Chapter

3

Driver Installation

There are several installation ways depending on the driver package under different Operating Systems.

Please follow the sequence below to install the drivers:

For Windows 10:

Step 1 – Chipset Driver

Step 2 – Graphics Driver

Step 3 – SIO Driver

Step 4 – TXE Driver

Step 5 – Audio Driver

Step 6 –BT Driver

Step 7 –GPS Driver

Step 8 – Ethernet on Docking Driver

Step 9 – LAN Driver

Step 10 – SMART CARD READER Driver

Appendix

A

Miscellanea

A.1 General Cleaning Tips

You may need the following precautions before you begin to clean the computer. When you clean any single part or component for the computer, please read and understand the details below fully.

1. Never spray or squirt the liquids directly onto any computer component. If you need to clean the device, please rub it with a piece of dry cloth.
2. Be cautious of the tiny removable components when you use a vacuum cleaner to absorb the dirt on the floor.
3. Turn the system off before you start to clean up the component or computer.
4. Never drop the components inside the computer or get circuit board damp or wet.
5. Be cautious of all kinds of cleaning solvents or chemicals when you use it for the sake of cleaning. Some individuals may be allergic to the ingredients.
6. Try not to put any food, drink or cigarette around the computer.
7. ONYX Healthcare Inc. has tested and verified these cleaning disinfectants, CIDEX, Viraguard, Control III Disinfectant Germicide, Caviwipes, Dispatch Disinfectant Cleaner CLH69101, Puregreen 24 Disinfectant, can be used with ONYX-MD116. Use of any other disinfectants will

void the warranty.

A.2 Cleaning tools

Although many companies have created products to help improve the process of cleaning your computer and peripherals users can also use household items to clean their computers and peripherals. Below is a listing of items you may need or want to use while cleaning your computer or computer peripherals.

Keep in mind that some components in your computer may only be able to be cleaned using a product designed for cleaning that component, if this is the case it will be mentioned in the cleaning tips.

- **Cloth** - A piece of cloth is the best tool to use when rubbing up a component. Although paper towels or tissues can be used on most hardware as well, we still recommend you to rub it with a piece of cloth.
- **Water or rubbing alcohol** – You may moisten a piece of cloth a bit with some water or rubbing alcohol and rub it on the computer. Unknown solvents may be harmful to the plastics parts.
- **Vacuum cleaner** - Absorb the dust, dirt, hair, cigarette particles, and other particles out of a computer can be one of the best methods of cleaning a computer. Over time these items can restrict the airflow in a computer and cause

circuitry to corrode.

- **Cotton swabs** - Cotton swabs moistened with rubbing alcohol or water are excellent tools for wiping hard to reach areas in your keyboard, mouse, and other locations.
- **Foam swabs** - Whenever possible it is better to use lint free swabs such as foam swabs.

Note:

We strongly recommended that you should shut down the system before you start to clean any single components.

Please follow the steps below.

1. Close all application programs.
2. Close operating software.
3. Turn off power switch
4. Remove all device
5. Pull out power cable

A.3 Scrap Computer Recycling

If the computer equipments need the maintenance or are beyond repair, we strongly recommended that you should inform us as soon as possible for the suitable solution. For the computers that are no longer useful or work well, please contact with worldwide distributors for recycling.

The worldwide distributors show on the following website:

<http://www.onyx-healthcare.com.tw/Contact.php>

Note:

Follow the national requirement to dispose unit

FEDERAL COMMUNICATIONS COMMISSION INTERFERENCE STATEMENT

This equipment has been tested and found to comply with the limits for a Class B digital device, pursuant to part 15 of the FCC Rules. These limits are designed to provide reasonable protection against harmful interference in a residential installation. This equipment generates, uses and can radiate radio frequency energy and, if not installed and used in accordance with the instructions, may cause harmful interference to radio communications. However, there is no guarantee that interference will not occur in a particular installation. If this equipment does cause harmful interference to radio or television reception, which can be determined by turning the equipment off and on, the user is encouraged to try to correct the interference by one or more of the following measures:

- Reorient or relocate the receiving antenna.
- Increase the separation between the equipment and receiver.
- Connect the equipment into an outlet on a circuit different from that to which the receiver is connected.
- Consult the dealer or an experienced radio/ TV technician for help.

CAUTION:

Any changes or modifications not expressly approved by the grantee of this device could void the user's authority to operate the equipment.

RF Exposure Information (SAR)

This device meets the government's requirements for exposure to radio waves. This device is designed and manufactured not to exceed the emission limits for exposure to radio frequency (RF) energy set by the Federal Communications Commission of the U.S. Government.

The exposure standard employs a unit of measurement known as the Specific Absorption Rate, or SAR.

The SAR limit set by the FCC is 1.6 W/kg. Tests for SAR are conducted using standard operating positions accepted by the FCC with the EUT transmitting at the specified power level in different channels.

The FCC has granted an Equipment Authorization for this device with all reported SAR levels evaluated as in compliance with the FCC RF exposure guidelines. SAR information on this device is on file with the FCC and can be found under the Display Grant section of www.fcc.gov/eot/ea/fccid after searching on FCC ID: RZ5-MD116

Antenna List

No.	Manufacturer	Part No.	Antenna Type	Peak Gain
1	ARISTOTLE	RFA-25-AP152-70B340R (Main) RFA-25-AP152-70-285L (Aux)	PIFA Antenna	3.93dBi for 2.4 GHz 7.19dBi For 5.15~5.25GHz 7.30dBi For 5.25~5.35GHz 7.44dBi For 5.47~5.725GHz 7.57dBi For 5.725~5.850GHz