

RF Test Report

Applicant : ONYX Healthcare Inc.

Product Type : Mobile Medical Assistant Tablet

Trade Name : onyx

Model Number : ONYX-MD101, xxxONYX-MD101xxxxxxxxxx (x=0~9, A~Z, a~z or blank or middle bar; for marketing purpose only and no impact safety related constructions and critical components)

Applicable Standard : FCC 47 CFR PART 15 SUBPART C
ANSI C63.10:2013

Receive Date : Jul. 25, 2017

Test Period : Aug. 05 ~ Aug. 17, 2017

Issue Date : Aug. 24, 2017

Issue by

A Test Lab Techno Corp.
No. 140-1, Changan Street, Bade District,
Taoyuan City 33465, Taiwan (R.O.C)
Tel : +886-3-2710188 / Fax : +886-3-2710190



Taiwan Accreditation Foundation accreditation number: 1330
Test Firm MRA designation number: TW0010

Note: This report shall not be reproduced except in full, without the written approval of A Test Lab Techno Corp. This document may be altered or revised by A Test Lab Techno Corp. personnel only, and shall be noted in the revision section of the document. The client should not use it to claim product endorsement by TAF, or any government agencies. The test results in the report only apply to the tested sample.



Revision History

| Rev. | Issue Date | Revisions | Revised By |
|------|---------------|---------------|------------|
| 00 | Aug. 24, 2017 | Initial Issue | Janet Chao |
| | | | |
| | | | |
| | | | |

Verification of Compliance

Issued Date: Aug. 24, 2017

Applicant : ONYX Healthcare Inc.
Product Type : Mobile Medical Assistant Tablet
Trade Name : onyx
Model Number : ONYX-MD101, xxxONYX-MD101xxxxxxxxxx (x=0~9, A~Z, a~z or blank or middle bar; for marketing purpose only and no impact safety related constructions and critical components)
FCC ID : RZ5-MD101
EUT Rated Voltage : DC 15V, 2.4A
Test Voltage : 120 Vac / 60 Hz
Applicable Standard : FCC 47 CFR PART 15 SUBPART C
ANSI C63.10:2013
Test Result : Complied
Performing Lab. : A Test Lab Techno Corp.

No. 140-1, Changan Street, Bade District,
Taoyuan City 33465, Taiwan (R.O.C)
Tel : +886-3-2710188 / Fax : +886-3-2710190



Taiwan Accreditation Foundation accreditation number: 1330
<http://www.atl-lab.com.tw/e-index.htm>

A Test Lab Techno Corp. tested the above equipment in accordance with the requirements set forth in the above standards. All indications of Pass/Fail in this report are opinions expressed by A Test Lab Techno Corp. based on interpretations and/or observations of test results. Measurement Uncertainties were not taken into account and are published for informational purposes only. The test results show that the equipment tested is capable of demonstrating compliance with the requirements as documented in this report.

Approved By



(Manager)

(Fly Lu)

Reviewed By



(Testing Engineer)

(Eric Ou Yang)



TABLE OF CONTENTS

| | | |
|----------|---|-----------|
| 1 | General Information | 6 |
| 2 | EUT Description | 7 |
| 3 | Test Methodology | 8 |
| 3.1. | Mode of Operation | 8 |
| 3.2. | EUT Exercise Software | 12 |
| 3.3. | Configuration of Test System Details | 13 |
| 3.4. | Test Site Environment | 13 |
| 4 | AC Power Line Conducted Emission Measurement | 14 |
| 4.1. | Limit | 14 |
| 4.2. | Test Instruments | 14 |
| 4.3. | Test Setup | 14 |
| 4.4. | Test Procedure | 15 |
| 4.5. | Test Result | 16 |
| 5 | Radiated Emission Measurement | 18 |
| 5.1. | Limit | 18 |
| 5.2. | Test Instruments | 18 |
| 5.3. | Setup | 19 |
| 5.4. | Test Procedure | 21 |
| 5.5. | Test Result | 23 |
| 6 | Maximum Conducted Output Power Measurement | 60 |
| 6.1. | Limit | 60 |
| 6.2. | Test Setup | 60 |
| 6.3. | Test Instruments | 60 |
| 6.4. | Test Procedure | 60 |
| 6.5. | Test Result | 61 |
| 7 | 6dB RF Bandwidth Measurement | 63 |
| 7.1. | Limit | 63 |
| 7.2. | Test Setup | 63 |
| 7.3. | Test Instruments | 63 |
| 7.4. | Test Procedure | 63 |
| 7.5. | Test Result | 64 |
| 7.6. | Test Graphs | 65 |



| | | |
|-----------|--|-----------|
| 8 | Maximum Power Density Measurement | 68 |
| 8.1. | Limit | 68 |
| 8.2. | Test Setup | 68 |
| 8.3. | Test Instruments | 68 |
| 8.4. | Test Procedure | 68 |
| 8.5. | Test Result | 69 |
| 8.6. | Test Graphs | 70 |
| 9 | Out of Band Conducted Emissions Measurement | 73 |
| 9.1. | Limit | 73 |
| 9.2. | Test Setup | 73 |
| 9.3. | Test Instruments | 73 |
| 9.4. | Test Procedure | 73 |
| 9.5. | Test Graphs | 74 |
| 10 | Antenna Measurement | 83 |
| 10.1. | Limit | 83 |
| 10.2. | Antenna Description | 83 |



1 General Information

1.1 Summary of Test Result

| Standard | Item | Result | Remark |
|--------------|---|--------|--------|
| 15.247 | | | |
| 15.207 | AC Power Conducted Emission | PASS | ----- |
| Standard | Item | Result | Remark |
| 15.247 | | | |
| 15.247(d) | Transmitter Radiated Emissions | PASS | ----- |
| 15.247(b)(3) | Max. Output Power | PASS | ----- |
| 15.247(a)(2) | 6dB RF Bandwidth | PASS | ----- |
| 15.247(e) | Power Spectral Density | PASS | ----- |
| 15.247(d) | Out of Band Conducted Spurious Emission | PASS | ----- |
| 15.203 | Antenna Requirement | PASS | ----- |

The test results of this report relate only to the tested sample(s) identified in this report. Manufacturer or whom it may concern should recognize the pass or fail of the test result.

1.2 Measurement Uncertainty

| Test Item | Frequency Range | Uncertainty (dB) |
|------------------------|---------------------|------------------|
| Conducted Emission | 9kHz ~ 150KHz | 2.7 |
| | 150kHz ~ 30MHz | 2.7 |
| Radiated Emission | 9kHz ~ 30MHz | 1.7 |
| | 30MHz ~ 1000MHz | 5.7 |
| | 1000MHz ~ 18000MHz | 5.5 |
| | 18000MHz ~ 26500MHz | 4.8 |
| | 26500MHz ~ 40000MHz | 4.8 |
| Conducted Output Power | +0.27 dB / -0.28 dB | |
| RF Bandwidth | 4.96% | |
| Power Spectral Density | +0.71 dB / -0.77 dB | |

2 EUT Description

| | | | | |
|-----------------------------|---|------------|-------------------|-----------------------|
| Applicant | ONYX Healthcare Inc. 2F,No.135,Lane235,Pao chiao Rd.,XINDIAN DIST., New Taipei City 231, Taiwan | | | |
| Manufacturer | ONYX Healthcare Inc. 2F,No.135,Lane235,Pao chiao Rd.,XINDIAN DIST., New Taipei City 231, Taiwan | | | |
| Product Type | Mobile Medical Assistant Tablet | | | |
| Trade Name | onyx | | | |
| Model Number | ONYX-MD101, xxxONYX-MD101xxxxxxxx (x=0~9, A~Z, a~z or blank or middle bar; for marketing purpose only and no impact safety related constructions and critical components) | | | |
| Model Different Description | Those model numbers differ from each other in selling region. | | | |
| FCC ID | RZ5-MD101 | | | |
| Operate Freq. Band | Frequency Range (MHz) | Modulation | Channel Bandwidth | Data Rate 400 GI (ns) |
| IEEE 802.11b | 2412 ~ 2462 | DSSS | 20MHz | Up to 11Mbps |
| IEEE 802.11g | 2412 ~ 2462 | OFDM | 20MHz | Up to 54Mbps |
| IEEE 802.11n 2.4GHz 20MHz | 2412 ~ 2462 | OFDM | 20MHz | Up to 72.2Mbps |
| Antenna information | Type | | Max. Gain (dBi) | |
| | PIFA antenna | | 2.97 | |
| Antenna Delivery | See section 3.1 | | | |
| Operate Temp. Range | -10 ~ 55 °C | | | |

| Frequency Band | Max. RF Output Power (W) |
|---------------------------|--------------------------|
| IEEE 802.11b | 0.079 |
| IEEE 802.11g | 0.143 |
| IEEE 802.11n 2.4GHz 20MHz | 0.136 |

3 Test Methodology

3.1. Mode of Operation

Decision of Test ATL has verified the construction and function in typical operation. All the test modes were carried out with the EUT in normal operation, which was shown in this test report and defined as:

| |
|--|
| Test Mode |
| Mode 1: Transmit mode |
| Mode 2: IEEE 802.11b Continuous TX mode |
| Mode 3: IEEE 802.11g Continuous TX mode |
| Mode 4: IEEE 802.11n 2.4GHz 20MHz Continuous TX mode |

Software used to control the EUT for staying in continuous transmitting mode was programmed.

After verification, all tests were carried out with the worst case test modes as shown below except radiated spurious emission below 1GHz and power line conducted emissions below 30MHz, which worst case was in TX mode only.

By preliminary testing and verifying three axis (X, Y and Z) position of EUT transmitted status, it was found that "X axis" position was the worst, then the final test was executed the worst condition and test data were recorded in this report.

| Test Mode | Antenna Delivery | Data Rate | Test Channel |
|-----------|------------------|-----------|--------------|
| Mode 2 | 1TX / 1RX | 1M | 1, 6, 11 |
| Mode 3 | 1TX / 1RX | 6M | 1, 6, 11 |
| Mode 4 | 1TX / 1RX | 6.5M | 1, 6, 11 |

Duty cycle

| Test Mode | Frequency (MHz) | on time (ms) | on+off time (ms) | Duty cycle | Duty Factor (dB) | 1/T Minimum VBW (kHz) |
|-----------|-----------------|--------------|------------------|------------|------------------|-----------------------|
| Mode 2 | 2412 | 8.460 | 8.520 | 0.993 | 0.031 | 0.010 |
| Mode 3 | 2412 | 1.420 | 1.505 | 0.944 | 0.252 | 0.704 |
| Mode 4 | 2412 | 1.310 | 1.440 | 0.910 | 0.411 | 0.763 |



Duty Cycle Graphs

Mode 2: IEEE 802.11b Continuous TX mode



Mode 3: IEEE 802.11g Continuous TX mode

On time

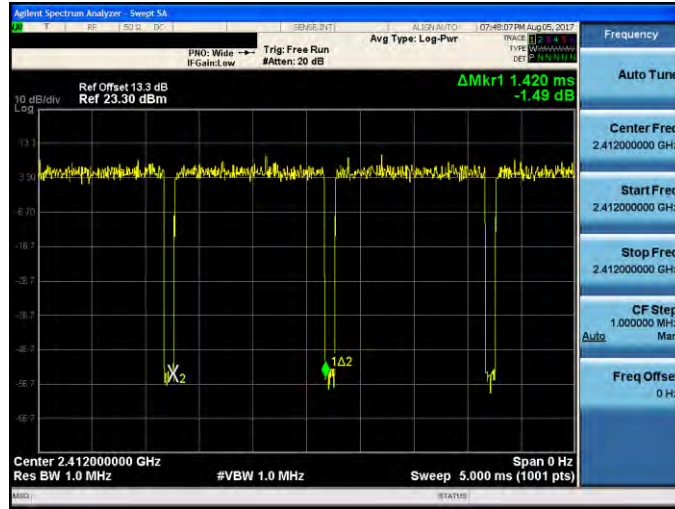

On+off time

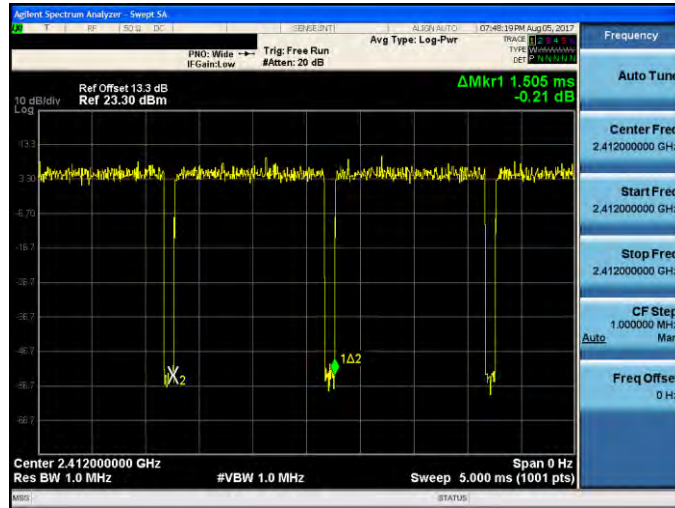

Mode 4: IEEE 802.11n 2.4GHz 20MHz Continuous TX mode

| | |
|--------------------|--|
| <p>On time</p> | |
| <p>On+off time</p> | |



3.2. EUT Exercise Software

| | |
|----|-------------------------------------|
| 1. | Setup the EUT shown on 3.3. |
| 2. | Turn on the power of all equipment. |
| 3. | Turn on TX function |
| 4. | EUT run test program. |

| | |
|----------------------|--------------------------|
| Measurement Software | |
| 1 | EZ-EMC Ver. ATL-03A1-1 |
| 2 | EZ-EMC Ver ATL-ITC-3A1-1 |

3.3. Configuration of Test System Details

Conducted Emission

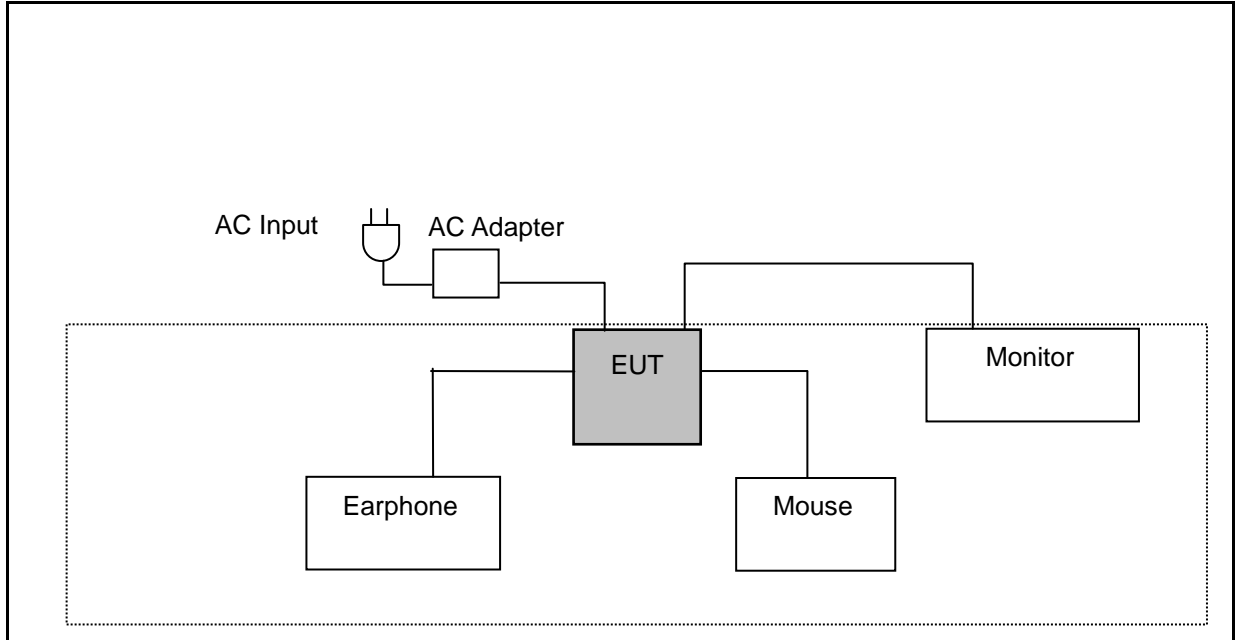

Radiated Emissions

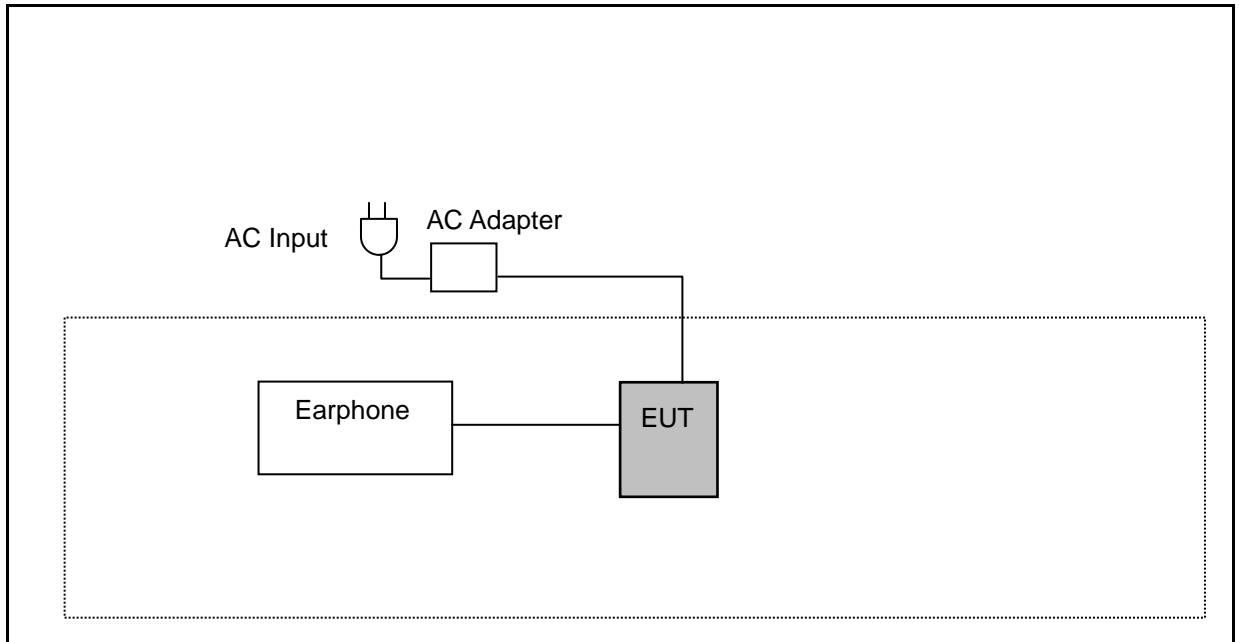

3.4. Test Site Environment

| Items | Required (IEC 60068-1) | Actual |
|----------------------------|------------------------|--------|
| Temperature (°C) | 15-35 | 26 |
| Humidity (%RH) | 25-75 | 60 |
| Barometric pressure (mbar) | 860-1060 | 950 |

4 AC Power Line Conducted Emission Measurement

4.1. Limit

| Frequency (MHz) | Quasi-peak | Average |
|-----------------|------------|----------|
| 0.15 - 0.5 | 66 to 56 | 56 to 46 |
| 0.50 - 5.0 | 56 | 46 |
| 5.0 - 30.0 | 60 | 50 |

4.2. Test Instruments

| Describe | Manufacturer | Model Number | Serial Number | Cal. Date | Cal. Period |
|---------------|--------------|----------------|---------------|------------|-------------|
| Test Receiver | R&S | ESCI | 100367 | 05/18/2017 | 1 year |
| LISN | R&S | ENV216 | 101040 | 04/01/2017 | 1 year |
| LISN | R&S | ENV216 | 101041 | 03/15/2017 | 1 year |
| RF Cable | Woken | 00100D1380194M | TE-02-02 | 05/19/2017 | 1 year |
| Test Site | ATL | TE02 | TE02 | N.C.R. | ----- |

Note: N.C.R. = No Calibration Request.

4.3. Test Setup

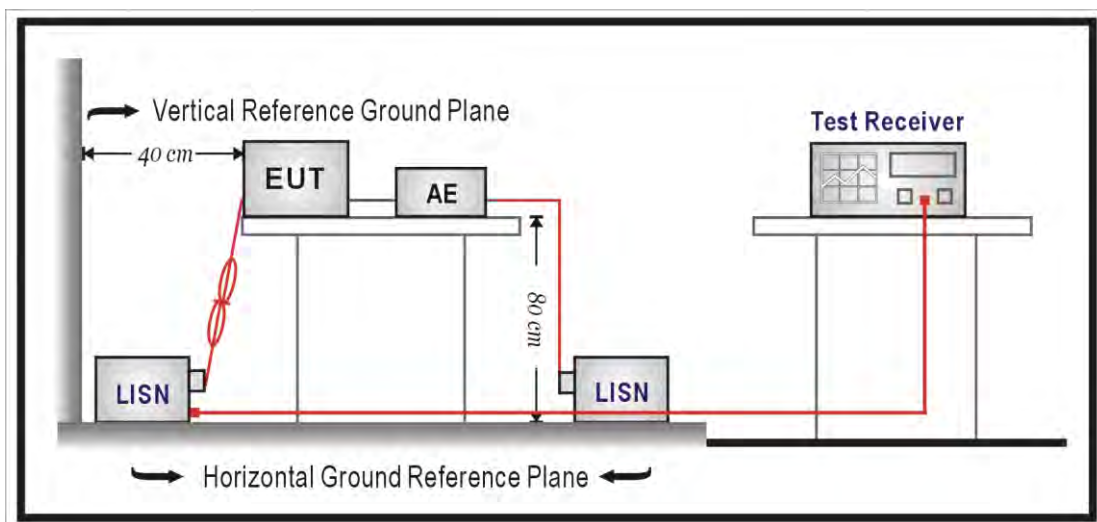

4.4. Test Procedure

The EUT and simulators are connected to the main power through a line impedance stabilization network (L.I.S.N.). This provides a $50\Omega // 50\mu\text{H}$ coupling impedance for the measuring equipment. The peripheral devices are also connected to the main power through a LISN that provides a $50\Omega // 50\mu\text{H}$ coupling impedance with 50ohm termination.

Tabletop device shall be placed on a non-conducting platform, of nominal size 1 m by 1.5 m, raised 80 cm above the reference ground plane. The wall of screened room shall be located 40cm to the rear of the EUT. Other surfaces of tabletop or floor standing EUT shall be at least 80cm from any other ground conducting surface including one or more LISNs. For floor-standing device shall be placed under the EUT with a 12mm insulating material.

Conducted emissions were investigated over the frequency range from 0.15 MHz to 30 MHz using a resolution bandwidth of 9 kHz. The equipment under test (EUT) shall be meet the limits in section 4.1, as applicable, including the average limit and the quasi-peak limit when using respectively, an average detector and quasi-peak detector measured in accordance with the methods described of related standard. When all of peak value were complied with quasi-peak and average limit from 150kHz to 30MHz then quasi-peak and average measurement was unnecessary.

The AMN shall be placed 0,8 m from the boundary of the unit under test and bonded to a ground reference plane for AMNs mounted on top of the ground reference plane. This distance is between the closest points of the AMN and the EUT. All other units of the EUT and associated equipment shall be at least 0,8 m from the AMN. If the mains power cable is longer than 1m then the cable shall be folded back and forth at the centre of the lead to form a bundle no longer than 0.4m. All of interconnecting cables that hang closer than 40cm to the ground plane shall be folded back and forth in the center forming a bundle 30 cm to 40 cm long. All of EUT and AE shall be separate place more than 0.1m. All 50 Ω ports of the LISN shall be resistively terminated into 50 Ω loads when not connected to the measuring instrument.

If the reading of the measuring receiver shows fluctuations close to the limit, the reading shall be observed for at least 15 s at each measurement frequency; the higher reading shall be recorded with the exception of any brief isolated high reading which shall be ignored.



4.5. Test Result

| | | | |
|--------------|-----------------|----------------------|--------------|
| Standard: | FCC Part 15.247 | Power: | AC 120V/60Hz |
| Test Mode: | Mode 1 | Temp.(°C)/Hum.(%RH): | 26(°C)/60%RH |
| Line: | L1 | Date: | 08/08/2017 |
| Description: | | | |

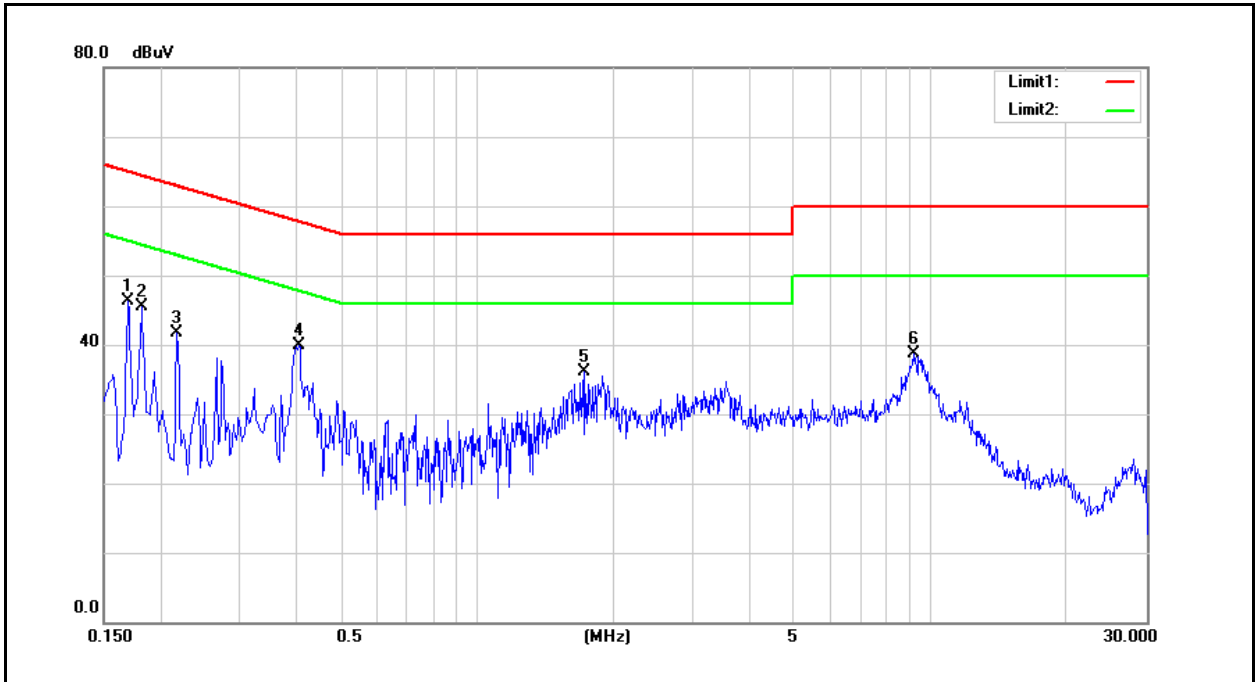

| No. | Frequency (MHz) | QP reading (dBuV) | AVG reading (dBuV) | Correction factor (dB) | QP result (dBuV) | AVG result (dBuV) | QP limit (dBuV) | AVG limit (dBuV) | QP margin (dB) | AVG margin (dB) | Remark |
|-----|-----------------|-------------------|--------------------|------------------------|------------------|-------------------|-----------------|------------------|----------------|-----------------|--------|
| 1 | 0.1700 | 28.84 | 14.30 | 9.54 | 38.38 | 23.84 | 64.96 | 54.96 | -26.58 | -31.12 | Pass |
| 2 | 0.1820 | 27.71 | 13.61 | 9.53 | 37.24 | 23.14 | 64.39 | 54.39 | -27.15 | -31.25 | Pass |
| 3 | 0.2180 | 23.47 | 9.44 | 9.53 | 33.00 | 18.97 | 62.89 | 52.89 | -29.89 | -33.92 | Pass |
| 4 | 0.4060 | 29.14 | 20.29 | 9.54 | 38.68 | 29.83 | 57.73 | 47.73 | -19.05 | -17.90 | Pass |
| 5 | 1.7300 | 20.88 | 13.33 | 9.60 | 30.48 | 22.93 | 56.00 | 46.00 | -25.52 | -23.07 | Pass |
| 6 | 9.1740 | 23.84 | 16.80 | 9.78 | 33.62 | 26.58 | 60.00 | 50.00 | -26.38 | -23.42 | Pass |

Note: 1. Result (dBuV/m) = Correct Factor (dB/m) + Reading(dBuV).
 2. Correction factor (dB) = Cable loss (dB) + L.I.S.N. factor (dB).



| | | | |
|--------------|-----------------|----------------------|--------------|
| Standard: | FCC Part 15.247 | Power: | AC 120V/60Hz |
| Test Mode: | Mode 1 | Temp.(°C)/Hum.(%RH): | 26(°C)/60%RH |
| Line: | N | Date: | 08/08/2017 |
| Description: | | | |

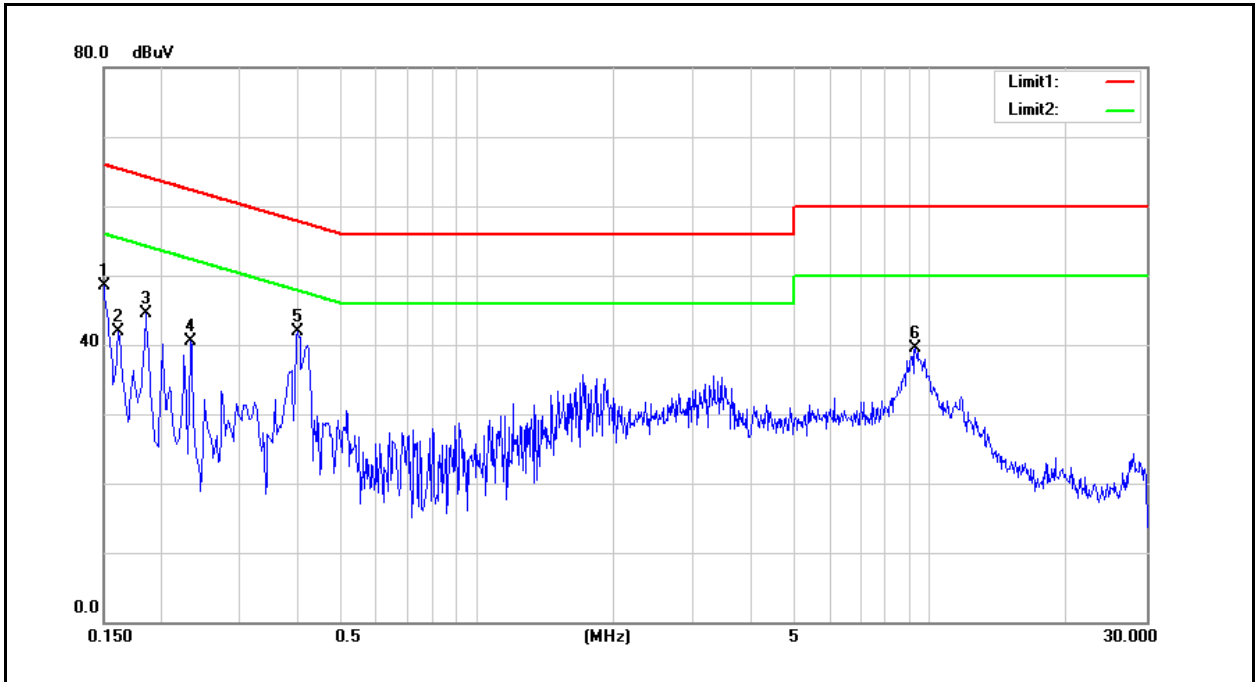

| No. | Frequency (MHz) | QP reading (dBuV) | AVG reading (dBuV) | Correction factor (dB) | QP result (dBuV) | AVG result (dBuV) | QP limit (dBuV) | AVG limit (dBuV) | QP margin (dB) | AVG margin (dB) | Remark |
|-----|-----------------|-------------------|--------------------|------------------------|------------------|-------------------|-----------------|------------------|----------------|-----------------|--------|
| 1 | 0.1500 | 31.13 | 19.13 | 9.62 | 40.75 | 28.75 | 66.00 | 56.00 | -25.25 | -27.25 | Pass |
| 2 | 0.1620 | 30.50 | 18.07 | 9.63 | 40.13 | 27.70 | 65.36 | 55.36 | -25.23 | -27.66 | Pass |
| 3 | 0.1860 | 27.43 | 15.09 | 9.63 | 37.06 | 24.72 | 64.21 | 54.21 | -27.15 | -29.49 | Pass |
| 4 | 0.2340 | 21.63 | 9.34 | 9.63 | 31.26 | 18.97 | 62.31 | 52.31 | -31.05 | -33.34 | Pass |
| 5 | 0.4020 | 29.58 | 21.81 | 9.64 | 39.22 | 31.45 | 57.81 | 47.81 | -18.59 | -16.36 | Pass |
| 6 | 9.2820 | 23.76 | 17.38 | 9.91 | 33.67 | 27.29 | 60.00 | 50.00 | -26.33 | -22.71 | Pass |

Note: 1. Result (dBuV/m) = Correct Factor (dB/m) + Reading(dBuV).
 2. Correction factor (dB) = Cable loss (dB) + L.I.S.N. factor (dB).



5 Radiated Emission Measurement

5.1. Limit

According to §15.209(a), except as provided elsewhere in this subpart, the emissions from an intentional radiator shall not exceed the field strength levels specified in the following table:

| Frequency (MHz) | Field Strength ($\mu\text{V}/\text{m}$ at meter) | Measurement Distance (meters) |
|-----------------|---|-------------------------------|
| 0.009 – 0.490 | 2400 / F (kHz) | 300 |
| 0.490 – 1.705 | 24000 / F (kHz) | 30 |
| 1.705 – 30.0 | 30 | 30 |
| 30 - 88 | 100** | 3 |
| 88-216 | 150** | 3 |
| 216-960 | 200** | 3 |
| Above 960 | 500 | 3 |

** Except as provided in paragraph (g), fundamental emissions from intentional radiators operating under this Section shall not be located in the frequency bands 54-72 MHz, 76-88 MHz, 174-216 MHz or 470-806 MHz. However, operation within these frequency bands is permitted under other sections of this Part, e.g., Sections 15.231 and 15.241.

5.2. Test Instruments

| 3 Meter Chamber | | | | | |
|-------------------------|--------------------------------|---------------------|---------------|------------|-------------|
| Equipment | Manufacturer | Model Number | Serial Number | Cal. Date | Cal. Period |
| RF Pre-selector | Agilent | N9039A | MY46520256 | 04/24/2017 | 1 year |
| Spectrum Analyzer | Agilent | E4446A | MY46180578 | 04/24/2017 | 1 year |
| Pre Amplifier | Agilent | 8449B | 3008A02237 | 10/11/2016 | 1 year |
| Pre Amplifier | Agilent | 8447D | 2944A11119 | 01/12/2017 | 1 year |
| Broadband Antenna | Schwarzbeck | VULB9168 | 416 | 10/13/2016 | 1 year |
| Horn Antenna (1~18GHz) | SCHWARZBECK MESS-ELEKTRONIK | BBHA9120D | 9120D-550 | 06/20/2017 | 1 year |
| Horn Antenna (18~40GHz) | ETS | 3116 | 86467 | 09/05/2016 | 1 year |
| Loop Antenna | COM-POWER CORPORATION | AL-130 | 121014 | 01/26/2017 | 1 year |
| Microwave Cable | EMCI | EMC102-KM-KM-14000 | 151001 | 02/20/2017 | 1 year |
| Microwave Cable | EMCI | EMC-104-SM-SM-14000 | 140202 | 02/20/2017 | 1 year |
| Microwave Cable | EMCI | EMC104-SM-SM-600 | 140301 | 02/20/2017 | 1 year |
| Test Site | ATL | TE01 | 888001 | 08/29/2016 | 1 year |

Note: N.C.R. = No Calibration Request.

5.3. Setup

9kHz ~ 30MHz

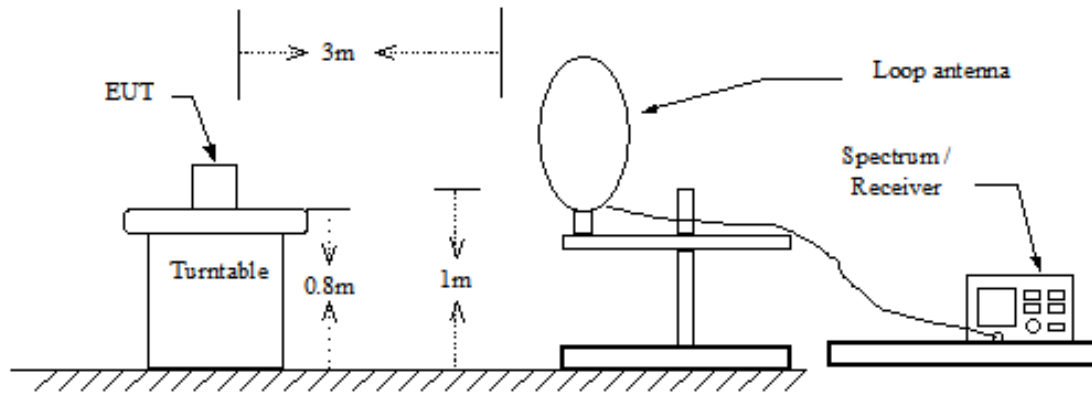

Below 1GHz

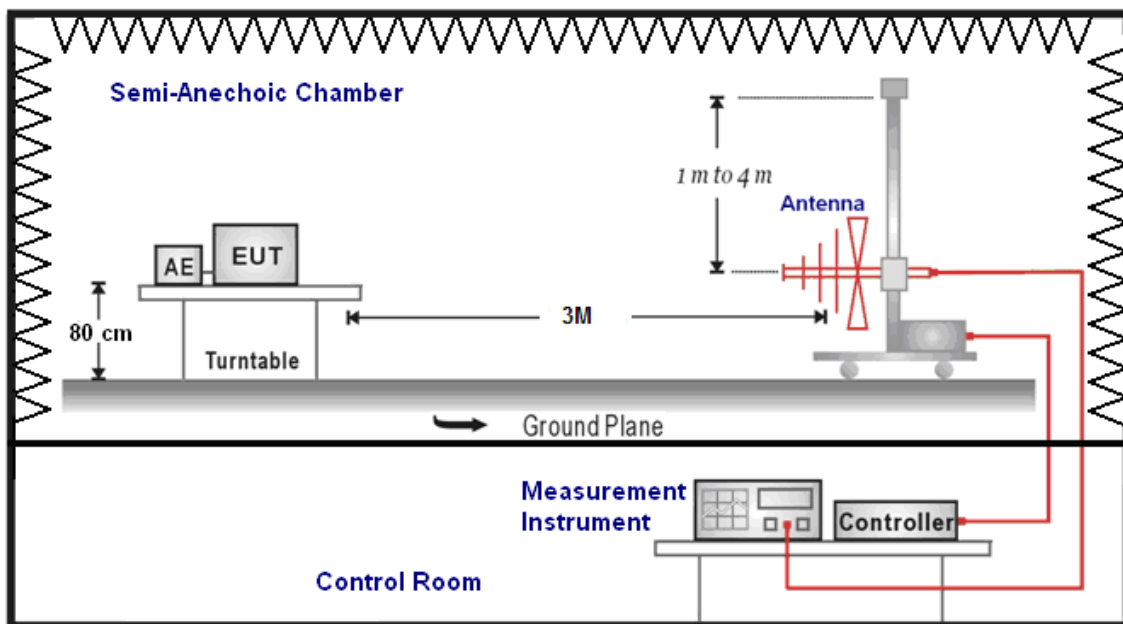

Above 1GHz

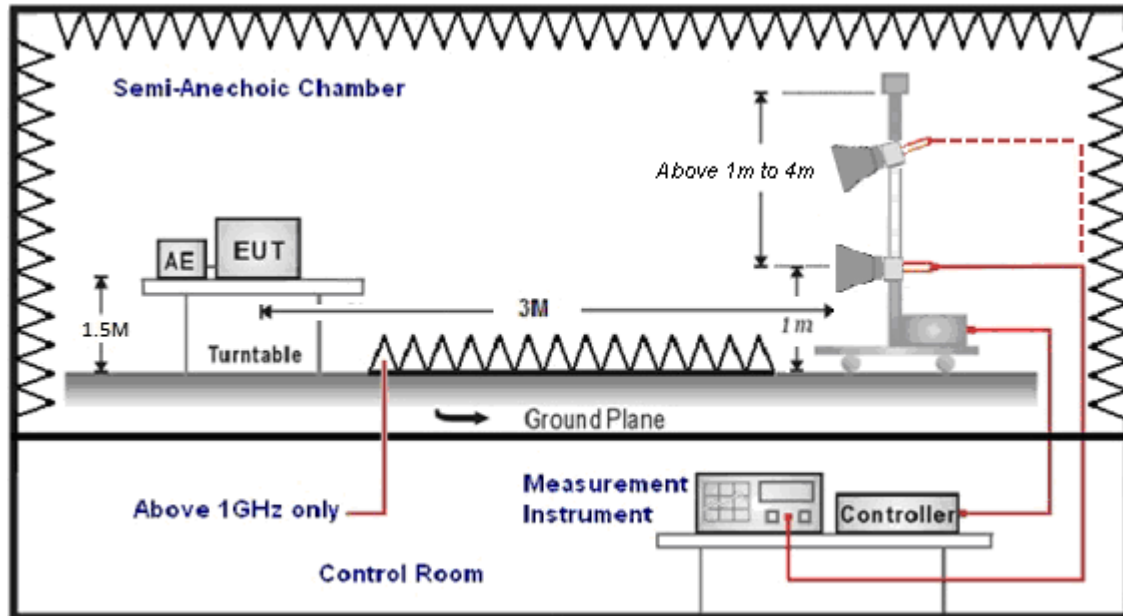

5.4. Test Procedure

Final radiation measurements were made on a three-meter, Semi Anechoic Chamber. The EUT system was placed on a nonconductive turntable which is 0.8 or 1.5 meters height (below 1GHz use 0.8m turntable / above 1GHz use 1.5m turntable), top surface 1.0 x 1.5 meter. The spectrum was examined from 250 MHz to 2.5 GHz in order to cover the whole spectrum below 10th harmonic which could generate from the EUT. During the test, EUT was set to transmit continuously & Measurements spectrum range from 9 kHz to 26.5 GHz is investigated.

For measurements below 1 GHz the resolution bandwidth is set to 100 kHz for peak detection measurements or 120 kHz for quasi-peak detection measurements. Peak detection is used unless otherwise noted as quasi-peak.

For measurements above 1 GHz the resolution bandwidth is set to 1 MHz, and then the video bandwidth is set to 1 MHz for peak measurements and 10 Hz for average measurements when Duty cycle >0.98 / $1/T$ for average measurements when Duty cycle <0.98 . A nonconductive material surrounded the EUT to supporting the EUT for standing on three orthogonal planes. At each condition, the EUT was rotated 360 degrees, and the antenna was raised and lowered from one to four meters to find the maximum emission levels. Measurements were taken using both horizontal and vertical antenna polarization.

SCHWARZBECK MESS-ELEKTRONIK Biconilog Antenna at 3 Meter and the SCHWARZBECK Double Ridged Guide Antenna was used in frequencies 1 – 26.5 GHz at a distance of 3 meter. The antenna at an angle toward the source of the emission. All test results were extrapolated to equivalent signal at 3 meters utilizing an inverse linear distance extrapolation Factor (20dB/decade).

For testing above 1GHz, the emission level of the EUT in peak mode was 20dB lower than average limit (that means the emission level in peak mode also complies with the limit in average mode), then testing will be stopped and peak values of EUT will be reported, otherwise, the emissions will be measured in average mode again and reported.

Appropriate preamplifiers were used for improving sensitivity and precautions were taken to avoid overloading or desensitizing the spectrum analyzer. No post – detector video filters were used in the test.

The spectrum analyzer's 6 dB bandwidth was set to 1 MHz, and the analyzer was operated in the peak detection mode, for frequencies both below and up 1 GHz. The average levels were obtained by subtracting the duty cycle correction factor from the peak readings.

The following procedures were used to convert the emission levels measured in decibels referenced to 1 microvolt (dBuV) into field intensity in micro volts pre meter (uV/m).

The actual field intensity in decibels referenced to 1 microvolt in to field intensity in micro volts per meter (dBuV/m).



The actual field intensity in referenced to 1 microvolt per meter (dBuV/m) is determined by algebraically adding the measured reading in dBuV, the antenna factor (dB), and cable loss (dB) and Subtracting the gain of preamplifier (dB) is auto calculate in spectrum analyzer.

(1) $\text{Amplitude (dBuV/m)} = \text{FI (dBuV)} + \text{AF (dBuV)} + \text{CL (dBuV)} - \text{Gain (dB)}$

FI= Reading of the field intensity.

AF= Antenna factor.

CL= Cable loss.

P.S Amplitude is auto calculate in spectrum analyzer.

(2) $\text{Actual Amplitude (dBuV/m)} = \text{Amplitude (dBuV)} - \text{Dis(dB)}$

The FCC specified emission limits were calculated according the EUT operating frequency and by following linear interpolation equations:

(a) For fundamental frequency : Transmitter Output < +30dBm

(b) For spurious frequency : Spurious emission limits = fundamental emission limit /10

Data of measurement within this frequency range without mark in the table above means the reading of emissions are attenuated more than 20dB below the permissible limits or the field strength is too small to be measured.



5.5. Test Result

Below 1GHz

| Standard: | | FCC Part 15.247 | | Test Distance: | | 3m | |
|-----------------|----------------|-----------------------|-----------------|----------------------|-------------|--------------|------------------|
| Test item: | | Harmonic | | Power: | | AC 120V/60Hz | |
| Test Mode: | | Mode 1 | | Temp.(°C)/Hum.(%RH): | | 26(°C)/60%RH | |
| | | | | Date: | | 08/17/2017 | |
| Frequency (MHz) | Reading (dBuV) | Correct Factor (dB/m) | Result (dBuV/m) | Limit (dBuV/m) | Margin (dB) | Remark | Ant.Polar. H / V |
| 500.4500 | 36.12 | 0.58 | 36.70 | 46.00 | -9.30 | QP | H |
| 540.2200 | 33.90 | 1.45 | 35.35 | 46.00 | -10.65 | QP | H |
| 666.3200 | 33.38 | 3.80 | 37.18 | 46.00 | -8.82 | QP | H |
| 740.0400 | 31.16 | 5.34 | 36.50 | 46.00 | -9.50 | QP | H |
| 792.4200 | 32.80 | 6.19 | 38.99 | 46.00 | -7.01 | QP | H |
| 949.5600 | 29.49 | 9.19 | 38.68 | 46.00 | -7.32 | QP | H |
| 500.4500 | 34.40 | 0.58 | 34.98 | 46.00 | -11.02 | QP | V |
| 587.7500 | 33.97 | 2.44 | 36.41 | 46.00 | -9.59 | QP | V |
| 783.6900 | 34.66 | 6.05 | 40.71 | 46.00 | -5.29 | QP | V |
| 864.2000 | 33.64 | 7.65 | 41.29 | 46.00 | -4.71 | QP | V |
| 900.0900 | 32.17 | 8.39 | 40.56 | 46.00 | -5.44 | QP | V |
| 967.9900 | 30.37 | 9.45 | 39.82 | 54.00 | -14.18 | QP | V |

- Note:
1. Result (dBuV/m) = Correct Factor (dB/m) + Reading(dBuV).
 2. Correction factor (dB/m) = Antenna Factor (dB/m) + Cable loss (dB) – Pre-Amplifier gain (dB).
 3. When the peak results are less than average limit, so not need to evaluate the average.



Above 1GHz

| | | | |
|-------------|-----------------|----------------------|--------------|
| Standard: | FCC Part 15.247 | Test Distance: | 3m |
| Test item: | Harmonic | Power: | AC 120V/60Hz |
| Frequency: | 2412MHz | Temp.(°C)/Hum.(%RH): | 26(°C)/60%RH |
| Mode: | Mode 2 | Date: | 08/17/2017 |
| Ant.Polar.: | Horizontal | | |

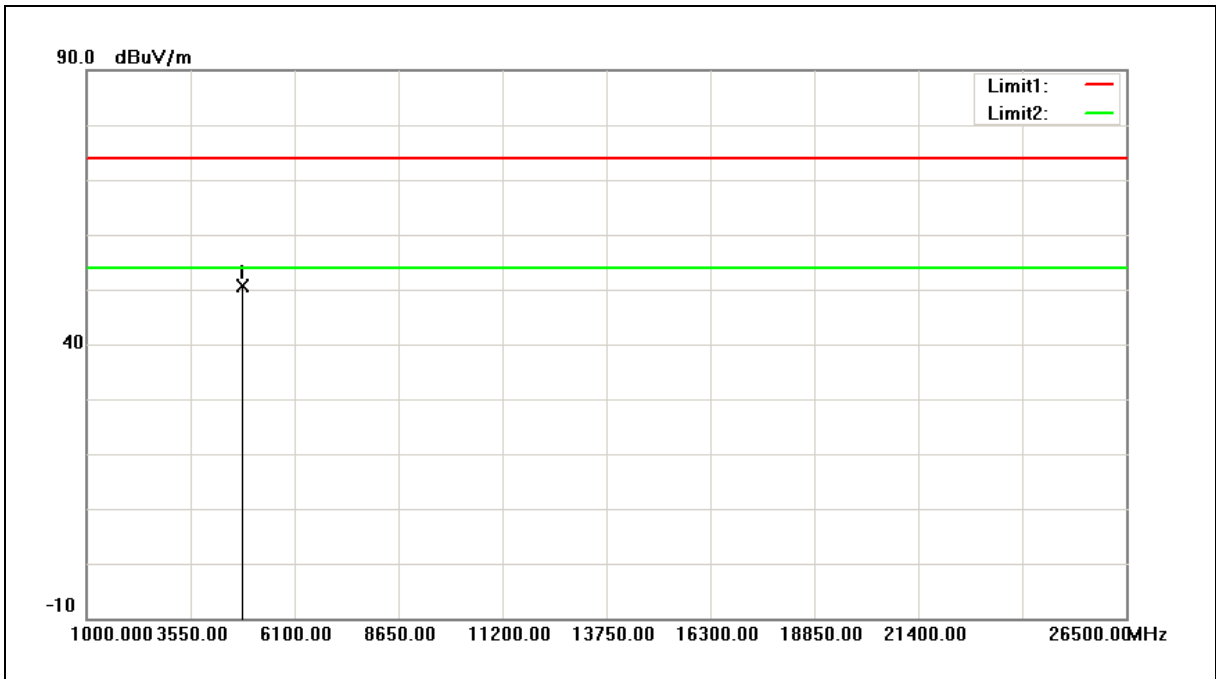

| No. | Frequency (MHz) | Reading (dBuV) | Correct Factor (dB/m) | Result (dBuV/m) | Limit (dBuV/m) | Margin (dB) | Remark |
|-----|-----------------|----------------|-----------------------|-----------------|----------------|-------------|--------|
| 1 | 4824.000 | 57.04 | -6.34 | 50.70 | 74.00 | -23.30 | peak |

- Note:1.Result (dBuV/m) = Correct Factor (dB/m) + Reading(dBuV).
 2.Correction factor (dB/m) = Antenna Factor (dB/m) + Cable loss (dB) – Pre-Amplifier gain (dB).
 3. When the peak results are less than average limit, so not need to evaluate the average.



| | | | |
|-------------|-----------------|-----------------------|--------------|
| Standard: | FCC Part 15.247 | Test Distance: | 3m |
| Test item: | Harmonic | Power: | AC 120V/60Hz |
| Frequency: | 2412MHz | Temp.(°C)/Hum. (%RH): | 26(°C)/60%RH |
| Mode: | Mode 2 | Date: | 08/17/2017 |
| Ant.Polar.: | Vertical | | |

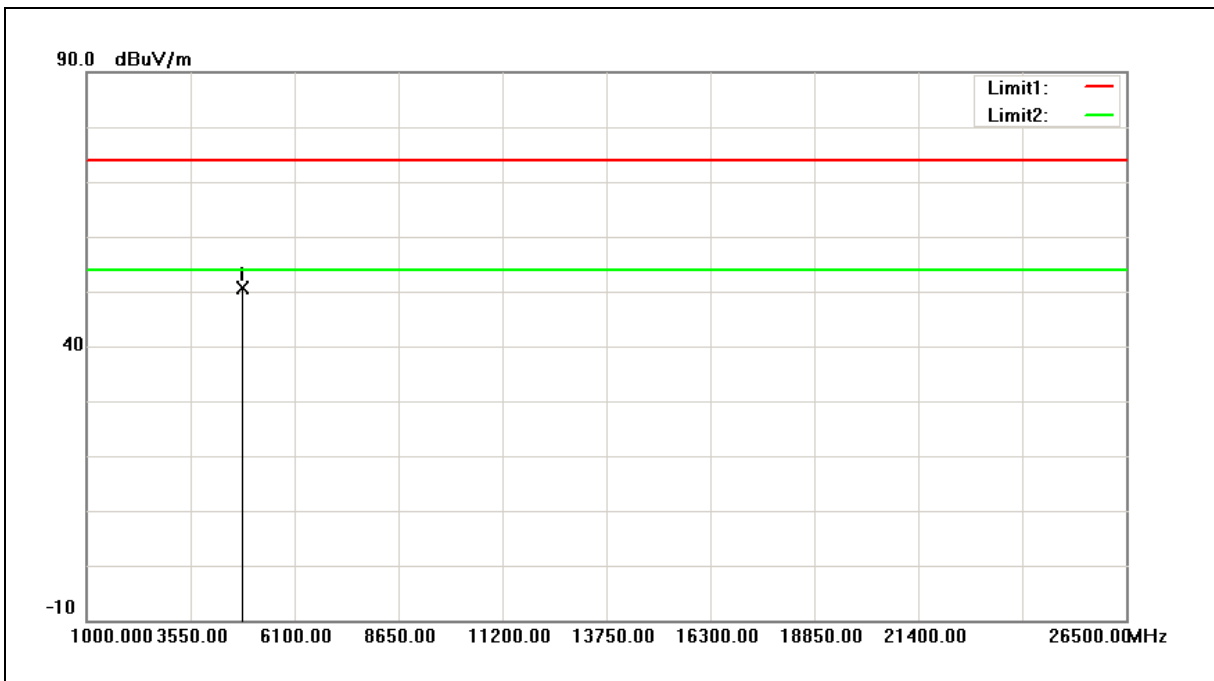

| No. | Frequency (MHz) | Reading (dBuV) | Correct Factor (dB/m) | Result (dBuV/m) | Limit (dBuV/m) | Margin (dB) | Remark |
|-----|-----------------|----------------|-----------------------|-----------------|----------------|-------------|--------|
| 1 | 4824.000 | 56.93 | -6.34 | 50.59 | 74.00 | -23.41 | peak |

Note:1.Result (dBuV/m) = Correct Factor (dB/m) + Reading(dBuV).

2.Correction factor (dB/m) = Antenna Factor (dB/m) + Cable loss (dB) – Pre-Amplifier gain (dB).

3. When the peak results are less than average limit, so not need to evaluate the average.



| | | | |
|-------------|-----------------|----------------------|--------------|
| Standard: | FCC Part 15.247 | Test Distance: | 3m |
| Test item: | Harmonic | Power: | AC 120V/60Hz |
| Frequency: | 2437MHz | Temp.(°C)/Hum.(%RH): | 26(°C)/60%RH |
| Mode: | Mode 2 | Date: | 08/17/2017 |
| Ant.Polar.: | Horizontal | | |

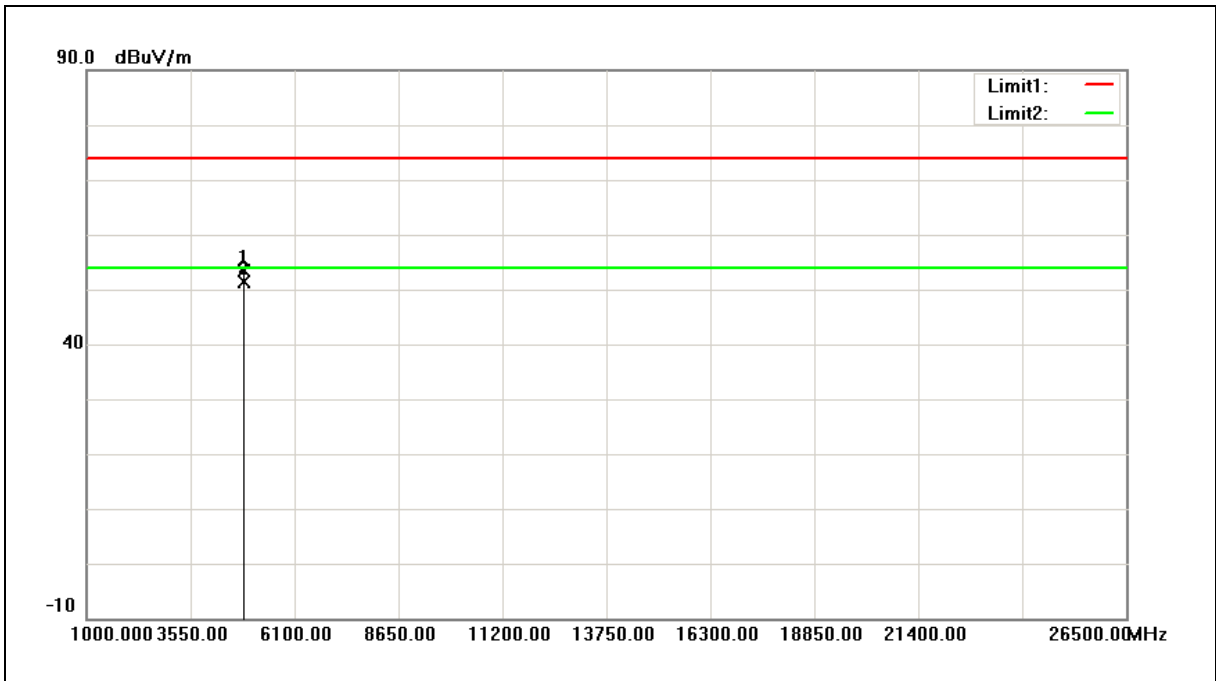

| No. | Frequency (MHz) | Reading (dBuV) | Correct Factor (dB/m) | Result (dBuV/m) | Limit (dBuV/m) | Margin (dB) | Remark |
|-----|-----------------|----------------|-----------------------|-----------------|----------------|-------------|--------|
| 1 | 4874.000 | 59.57 | -6.16 | 53.41 | 74.00 | -20.59 | peak |
| 2 | 4874.000 | 57.61 | -6.16 | 51.45 | 54.00 | -2.55 | AVG |

- Note: 1. Result (dBuV/m) = Correct Factor (dB/m) + Reading(dBuV).
 2. Correction factor (dB/m) = Antenna Factor (dB/m) + Cable loss (dB) – Pre-Amplifier gain (dB).
 3. When the peak results are less than average limit, so not need to evaluate the average.



| | | | |
|-------------|-----------------|----------------------|--------------|
| Standard: | FCC Part 15.247 | Test Distance: | 3m |
| Test item: | Harmonic | Power: | AC 120V/60Hz |
| Frequency: | 2437MHz | Temp.(°C)/Hum.(%RH): | 26(°C)/60%RH |
| Mode: | Mode 2 | Date: | 08/17/2017 |
| Ant.Polar.: | Vertical | | |

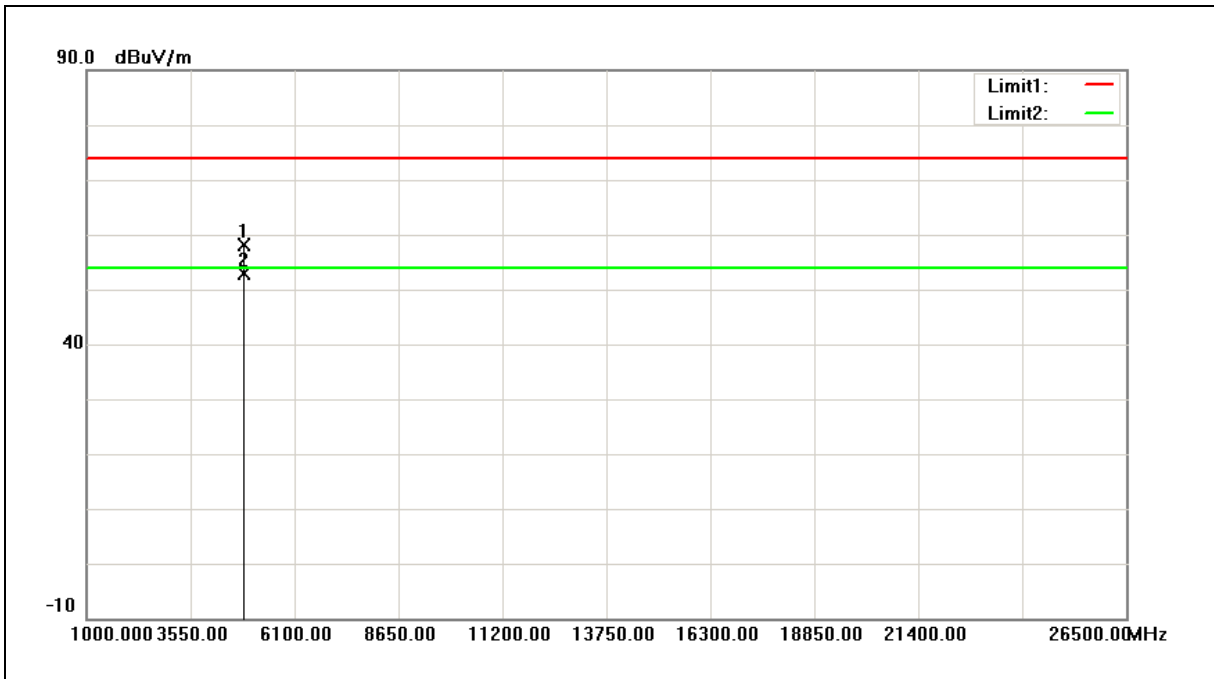

| No. | Frequency (MHz) | Reading (dBuV) | Correct Factor (dB/m) | Result (dBuV/m) | Limit (dBuV/m) | Margin (dB) | Remark |
|-----|-----------------|----------------|-----------------------|-----------------|----------------|-------------|--------|
| 1 | 4874.000 | 64.35 | -6.16 | 58.19 | 74.00 | -15.81 | peak |
| 2 | 4874.000 | 59.14 | -6.16 | 52.98 | 54.00 | -1.02 | AVG |

- Note: 1. Result (dBuV/m) = Correct Factor (dB/m) + Reading(dBuV).
 2. Correction factor (dB/m) = Antenna Factor (dB/m) + Cable loss (dB) – Pre-Amplifier gain (dB).
 3. When the peak results are less than average limit, so not need to evaluate the average.



| | | | |
|-------------|-----------------|----------------------|--------------|
| Standard: | FCC Part 15.247 | Test Distance: | 3m |
| Test item: | Harmonic | Power: | AC 120V/60Hz |
| Frequency: | 2462MHz | Temp.(°C)/Hum.(%RH): | 26(°C)/60%RH |
| Mode: | Mode 2 | Date: | 08/17/2017 |
| Ant.Polar.: | Horizontal | | |

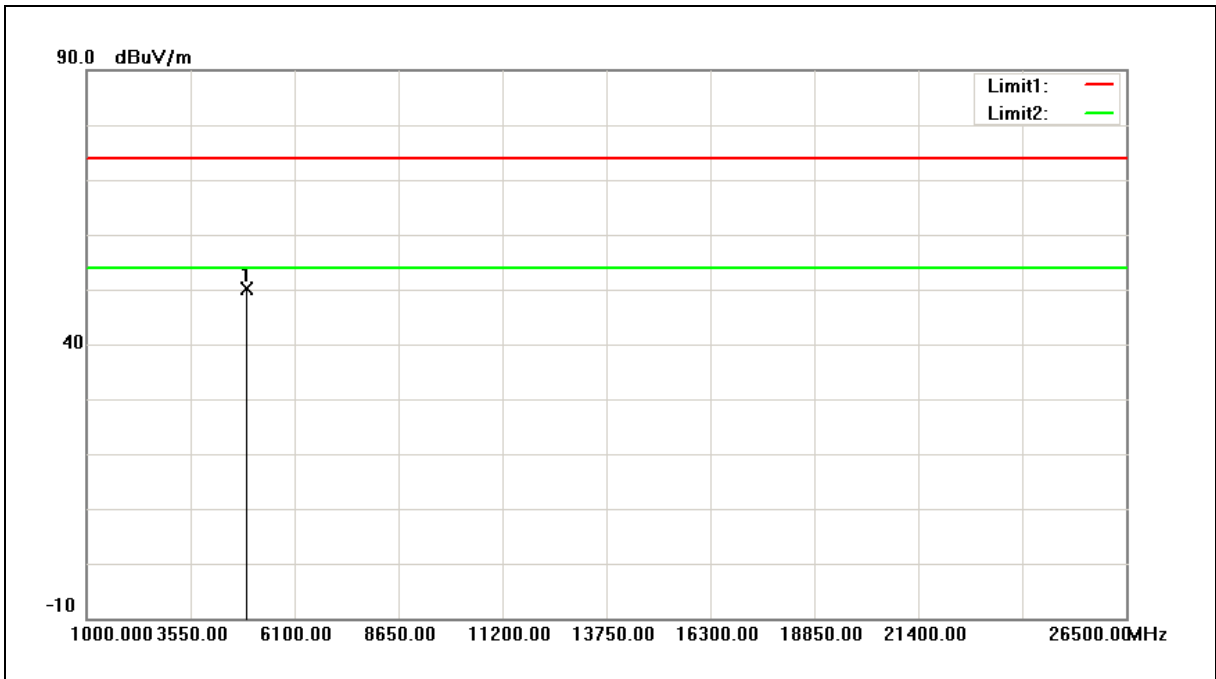

| No. | Frequency (MHz) | Reading (dBuV) | Correct Factor (dB/m) | Result (dBuV/m) | Limit (dBuV/m) | Margin (dB) | Remark |
|-----|-----------------|----------------|-----------------------|-----------------|----------------|-------------|--------|
| 1 | 4924.000 | 56.00 | -5.98 | 50.02 | 74.00 | -23.98 | peak |

Note:1.Result (dBuV/m) = Correct Factor (dB/m) + Reading(dBuV).

2.Correction factor (dB/m) = Antenna Factor (dB/m) + Cable loss (dB) – Pre-Amplifier gain (dB).

3. When the peak results are less than average limit, so not need to evaluate the average.



| | | | |
|-------------|-----------------|----------------------|--------------|
| Standard: | FCC Part 15.247 | Test Distance: | 3m |
| Test item: | Harmonic | Power: | AC 120V/60Hz |
| Frequency: | 2462MHz | Temp.(°C)/Hum.(%RH): | 26(°C)/60%RH |
| Mode: | Mode 2 | Date: | 08/17/2017 |
| Ant.Polar.: | Vertical | | |

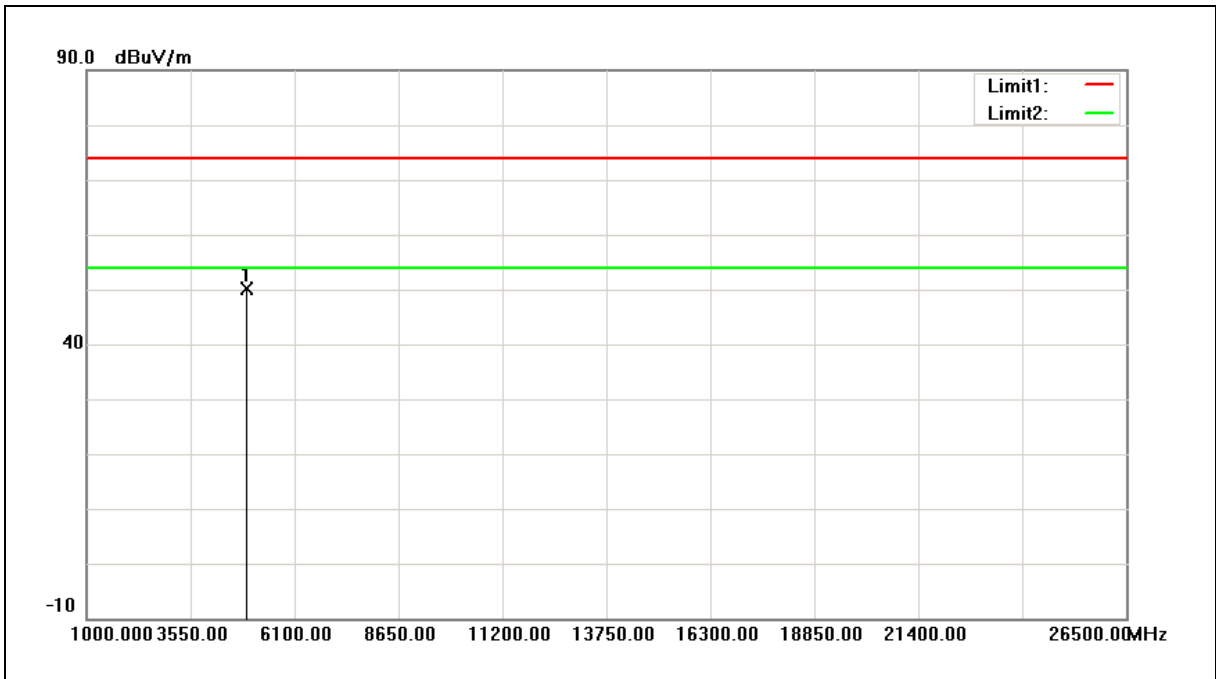

| No. | Frequency (MHz) | Reading (dBuV) | Correct Factor (dB/m) | Result (dBuV/m) | Limit (dBuV/m) | Margin (dB) | Remark |
|-----|-----------------|----------------|-----------------------|-----------------|----------------|-------------|--------|
| 1 | 4924.000 | 56.02 | -5.98 | 50.04 | 74.00 | -23.96 | peak |

Note:1.Result (dBuV/m) = Correct Factor (dB/m) + Reading(dBuV).

2.Correction factor (dB/m) = Antenna Factor (dB/m) + Cable loss (dB) – Pre-Amplifier gain (dB).

3. When the peak results are less than average limit, so not need to evaluate the average.



| | | | |
|-------------|-----------------|----------------------|--------------|
| Standard: | FCC Part 15.247 | Test Distance: | 3m |
| Test item: | Harmonic | Power: | AC 120V/60Hz |
| Frequency: | 2412MHz | Temp.(°C)/Hum.(%RH): | 26(°C)/60%RH |
| Mode: | Mode 3 | Date: | 08/17/2017 |
| Ant.Polar.: | Horizontal | | |

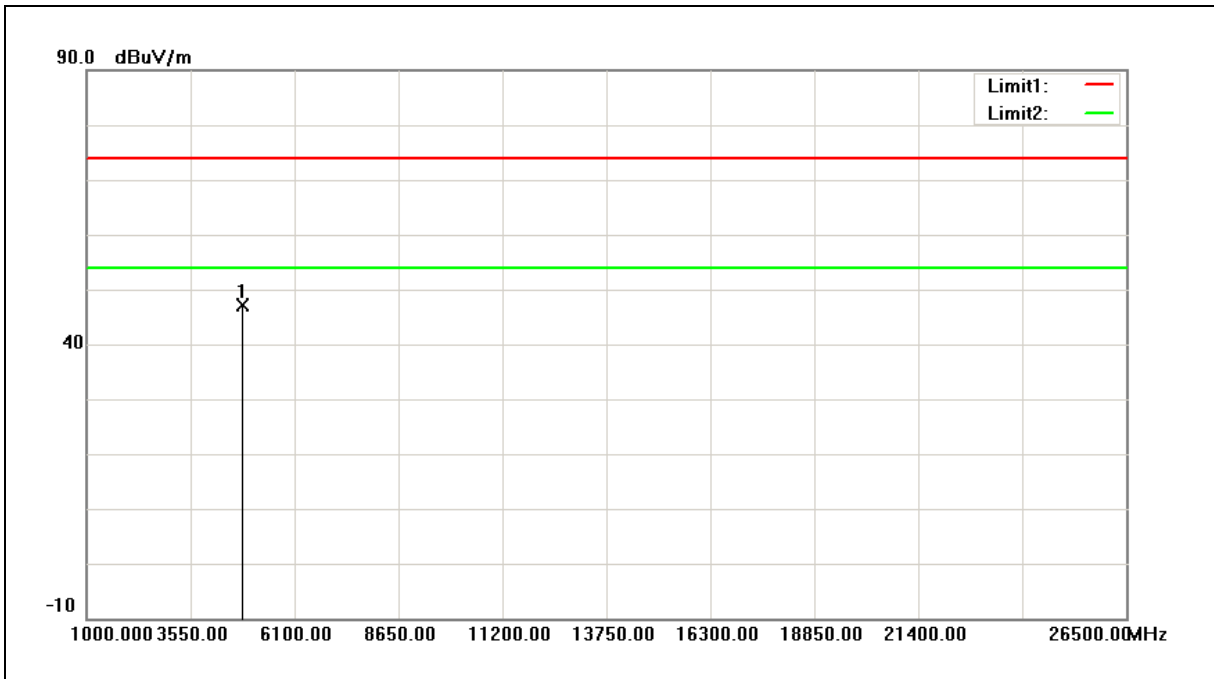

| No. | Frequency (MHz) | Reading (dBuV) | Correct Factor (dB/m) | Result (dBuV/m) | Limit (dBuV/m) | Margin (dB) | Remark |
|-----|-----------------|----------------|-----------------------|-----------------|----------------|-------------|--------|
| 1 | 4824.000 | 53.35 | -6.34 | 47.01 | 74.00 | -26.99 | peak |

Note:1.Result (dBuV/m) = Correct Factor (dB/m) + Reading(dBuV).

2.Correction factor (dB/m) = Antenna Factor (dB/m) + Cable loss (dB) – Pre-Amplifier gain (dB).

3. When the peak results are less than average limit, so not need to evaluate the average.



| | | | |
|-------------|-----------------|----------------------|--------------|
| Standard: | FCC Part 15.247 | Test Distance: | 3m |
| Test item: | Harmonic | Power: | AC 120V/60Hz |
| Frequency: | 2412MHz | Temp.(°C)/Hum.(%RH): | 26(°C)/60%RH |
| Mode: | Mode 3 | Date: | 08/17/2017 |
| Ant.Polar.: | Vertical | | |

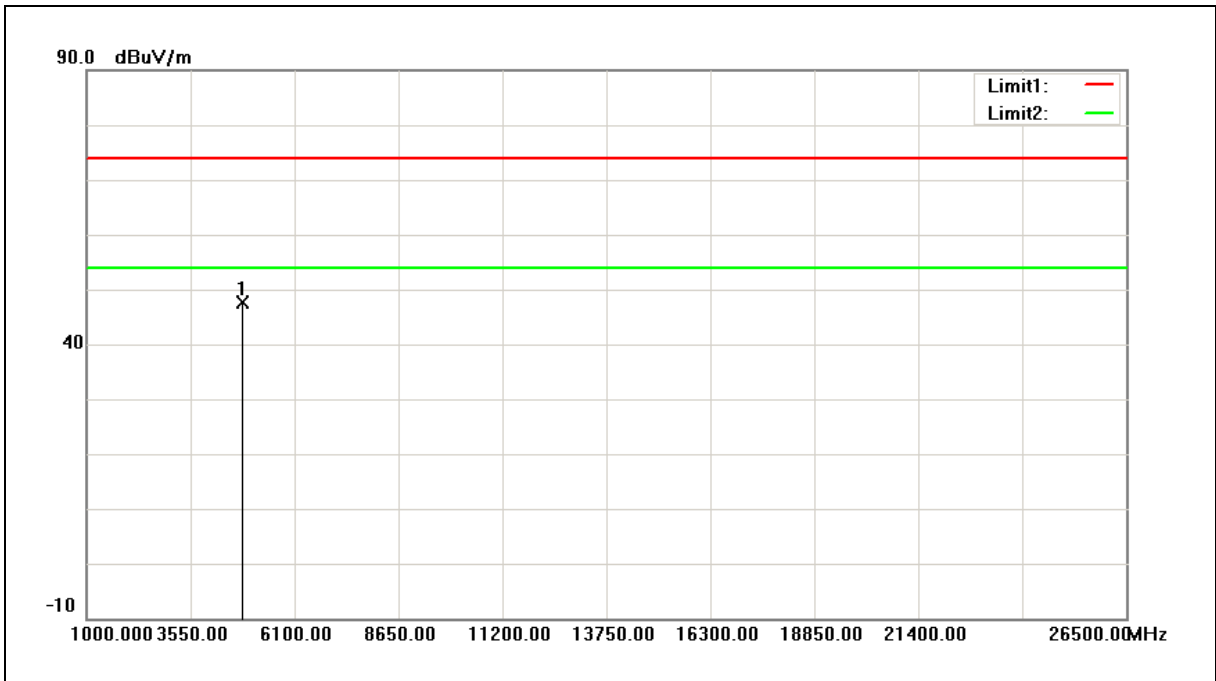

| No. | Frequency (MHz) | Reading (dBuV) | Correct Factor (dB/m) | Result (dBuV/m) | Limit (dBuV/m) | Margin (dB) | Remark |
|-----|-----------------|----------------|-----------------------|-----------------|----------------|-------------|--------|
| 1 | 4824.000 | 53.88 | -6.34 | 47.54 | 74.00 | -26.46 | peak |

Note:1.Result (dBuV/m) = Correct Factor (dB/m) + Reading(dBuV).

2.Correction factor (dB/m) = Antenna Factor (dB/m) + Cable loss (dB) – Pre-Amplifier gain (dB).

3. When the peak results are less than average limit, so not need to evaluate the average.



| | | | |
|-------------|-----------------|----------------------|--------------|
| Standard: | FCC Part 15.247 | Test Distance: | 3m |
| Test item: | Harmonic | Power: | AC 120V/60Hz |
| Frequency: | 2437MHz | Temp.(°C)/Hum.(%RH): | 26(°C)/60%RH |
| Mode: | Mode 3 | Date: | 08/17/2017 |
| Ant.Polar.: | Horizontal | | |

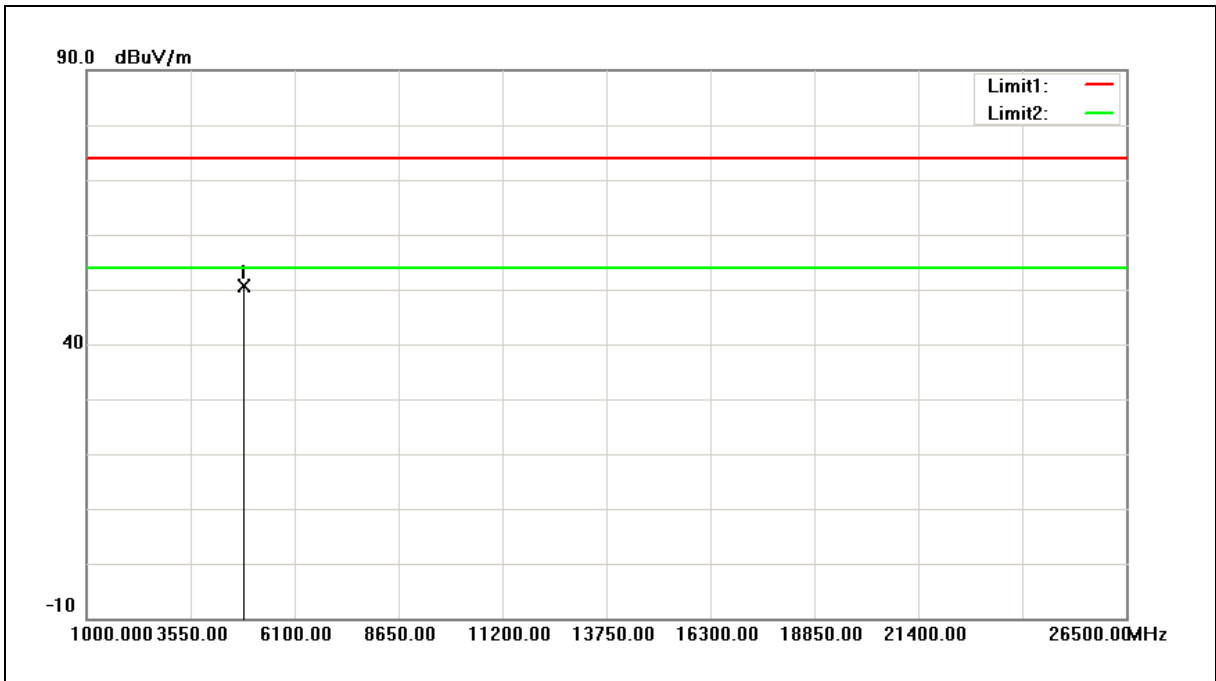

| No. | Frequency (MHz) | Reading (dBuV) | Correct Factor (dB/m) | Result (dBuV/m) | Limit (dBuV/m) | Margin (dB) | Remark |
|-----|-----------------|----------------|-----------------------|-----------------|----------------|-------------|--------|
| 1 | 4874.000 | 56.86 | -6.16 | 50.70 | 74.00 | -23.30 | peak |

Note:1.Result (dBuV/m) = Correct Factor (dB/m) + Reading(dBuV).

2.Correction factor (dB/m) = Antenna Factor (dB/m) + Cable loss (dB) – Pre-Amplifier gain (dB).

3. When the peak results are less than average limit, so not need to evaluate the average.



| | | | |
|-------------|-----------------|----------------------|--------------|
| Standard: | FCC Part 15.247 | Test Distance: | 3m |
| Test item: | Harmonic | Power: | AC 120V/60Hz |
| Frequency: | 2437MHz | Temp.(°C)/Hum.(%RH): | 26(°C)/60%RH |
| Mode: | Mode 3 | Date: | 08/17/2017 |
| Ant.Polar.: | Vertical | | |

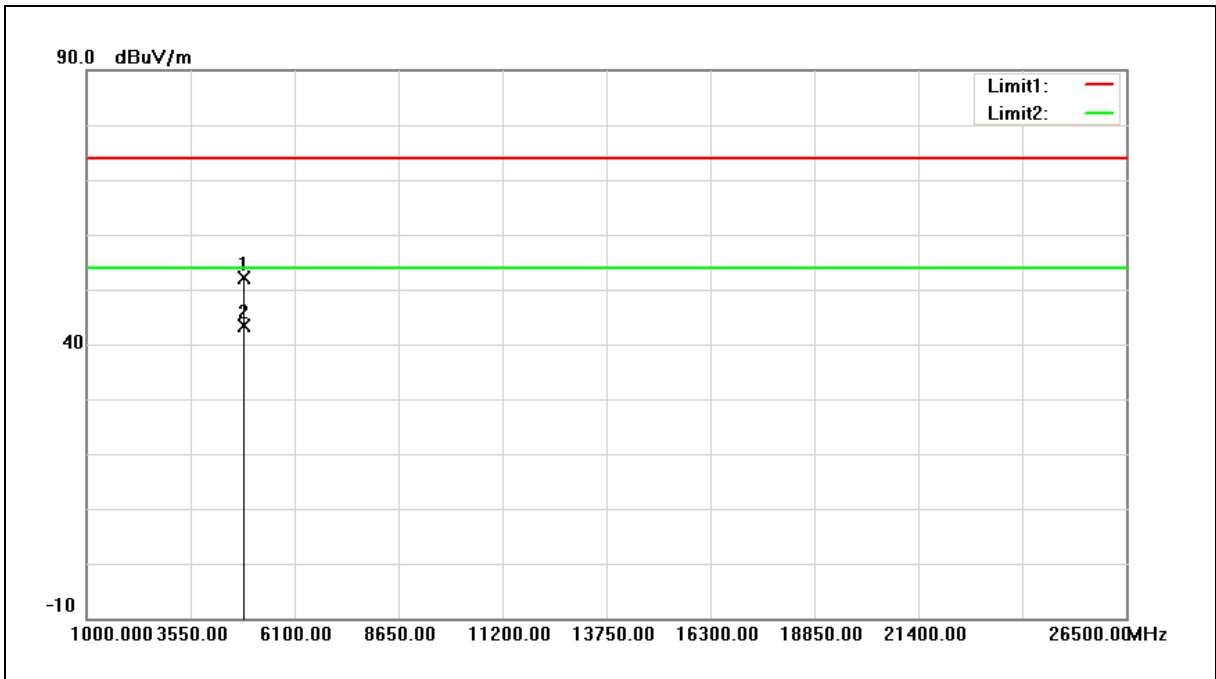

| No. | Frequency (MHz) | Reading (dBuV) | Correct Factor (dB/m) | Result (dBuV/m) | Limit (dBuV/m) | Margin (dB) | Remark |
|-----|-----------------|----------------|-----------------------|-----------------|----------------|-------------|--------|
| 1 | 4874.000 | 58.39 | -6.16 | 52.23 | 74.00 | -21.77 | peak |
| 2 | 4874.000 | 49.56 | -6.16 | 43.40 | 54.00 | -10.60 | AVG |

- Note: 1. Result (dBuV/m) = Correct Factor (dB/m) + Reading(dBuV).
 2. Correction factor (dB/m) = Antenna Factor (dB/m) + Cable loss (dB) – Pre-Amplifier gain (dB).
 3. When the peak results are less than average limit, so not need to evaluate the average.



| | | | |
|-------------|-----------------|----------------------|--------------|
| Standard: | FCC Part 15.247 | Test Distance: | 3m |
| Test item: | Harmonic | Power: | AC 120V/60Hz |
| Frequency: | 2462MHz | Temp.(°C)/Hum.(%RH): | 26(°C)/60%RH |
| Mode: | Mode 3 | Date: | 08/17/2017 |
| Ant.Polar.: | Horizontal | | |

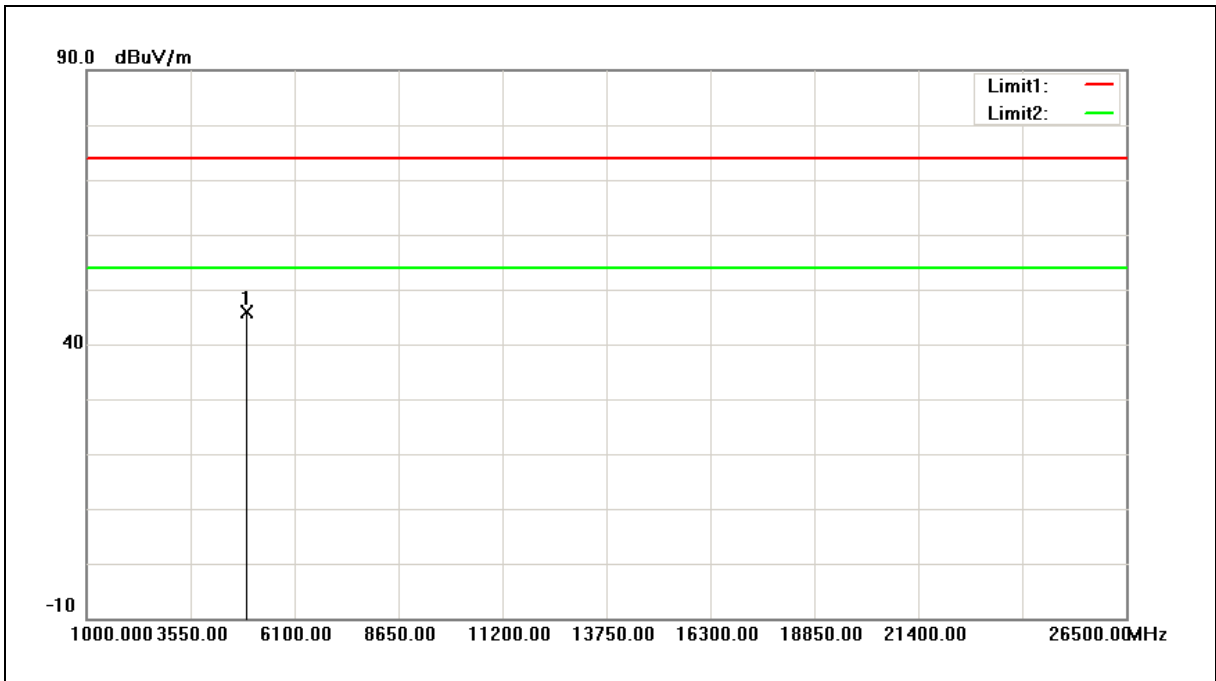

| No. | Frequency (MHz) | Reading (dBuV) | Correct Factor (dB/m) | Result (dBuV/m) | Limit (dBuV/m) | Margin (dB) | Remark |
|-----|-----------------|----------------|-----------------------|-----------------|----------------|-------------|--------|
| 1 | 4924.000 | 51.90 | -5.98 | 45.92 | 74.00 | -28.08 | peak |

Note:1.Result (dBuV/m) = Correct Factor (dB/m) + Reading(dBuV).

2.Correction factor (dB/m) = Antenna Factor (dB/m) + Cable loss (dB) – Pre-Amplifier gain (dB).

3. When the peak results are less than average limit, so not need to evaluate the average.



| | | | |
|-------------|-----------------|----------------------|--------------|
| Standard: | FCC Part 15.247 | Test Distance: | 3m |
| Test item: | Harmonic | Power: | AC 120V/60Hz |
| Frequency: | 2462MHz | Temp.(°C)/Hum.(%RH): | 26(°C)/60%RH |
| Mode: | Mode 3 | Date: | 08/17/2017 |
| Ant.Polar.: | Vertical | | |

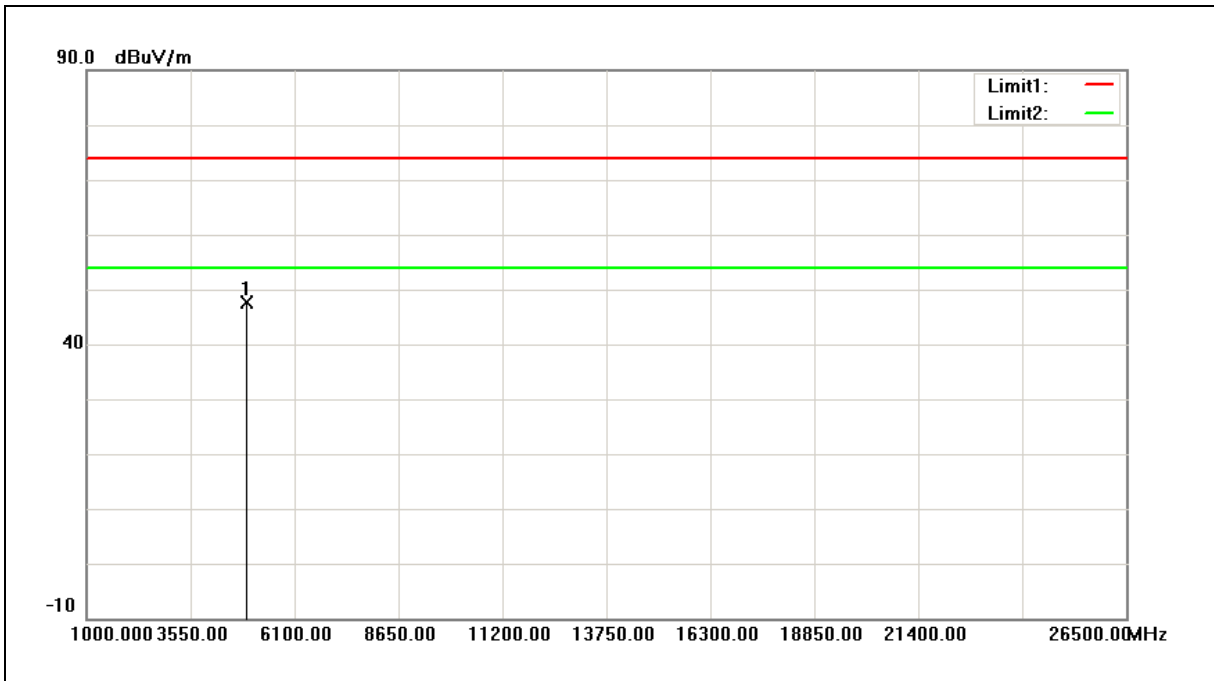

| No. | Frequency (MHz) | Reading (dBuV) | Correct Factor (dB/m) | Result (dBuV/m) | Limit (dBuV/m) | Margin (dB) | Remark |
|-----|-----------------|----------------|-----------------------|-----------------|----------------|-------------|--------|
| 1 | 4924.000 | 53.60 | -5.98 | 47.62 | 74.00 | -26.38 | peak |

Note:1.Result (dBuV/m) = Correct Factor (dB/m) + Reading(dBuV).

2.Correction factor (dB/m) = Antenna Factor (dB/m) + Cable loss (dB) – Pre-Amplifier gain (dB).

3. When the peak results are less than average limit, so not need to evaluate the average.



| | | | |
|-------------|-----------------|----------------------|--------------|
| Standard: | FCC Part 15.247 | Test Distance: | 3m |
| Test item: | Harmonic | Power: | AC 120V/60Hz |
| Frequency: | 2412MHz | Temp.(°C)/Hum.(%RH): | 26(°C)/60%RH |
| Mode: | Mode 4 | Date: | 08/17/2017 |
| Ant.Polar.: | Horizontal | | |

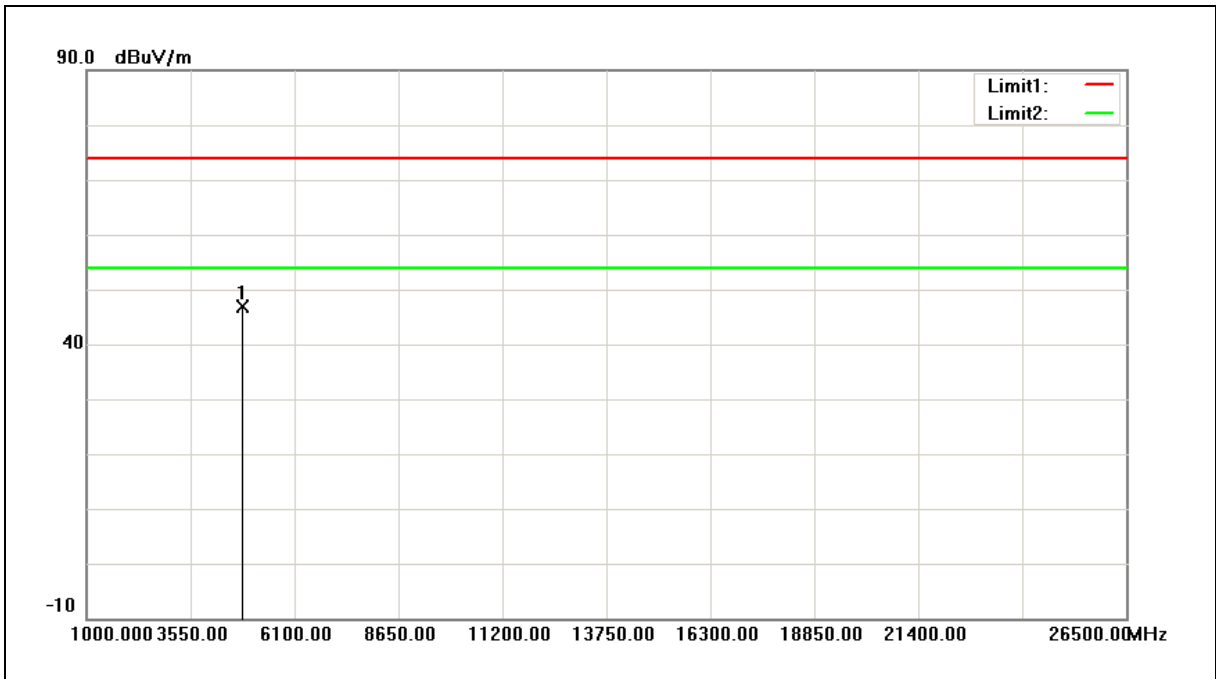

| No. | Frequency (MHz) | Reading (dBuV) | Correct Factor (dB/m) | Result (dBuV/m) | Limit (dBuV/m) | Margin (dB) | Remark |
|-----|-----------------|----------------|-----------------------|-----------------|----------------|-------------|--------|
| 1 | 4824.000 | 53.14 | -6.34 | 46.80 | 74.00 | -27.20 | peak |

Note:1.Result (dBuV/m) = Correct Factor (dB/m) + Reading(dBuV).

2.Correction factor (dB/m) = Antenna Factor (dB/m) + Cable loss (dB) – Pre-Amplifier gain (dB).

3. When the peak results are less than average limit, so not need to evaluate the average.



| | | | |
|-------------|-----------------|----------------------|--------------|
| Standard: | FCC Part 15.247 | Test Distance: | 3m |
| Test item: | Harmonic | Power: | AC 120V/60Hz |
| Frequency: | 2412MHz | Temp.(°C)/Hum.(%RH): | 26(°C)/60%RH |
| Mode: | Mode 4 | Date: | 08/17/2017 |
| Ant.Polar.: | Vertical | | |

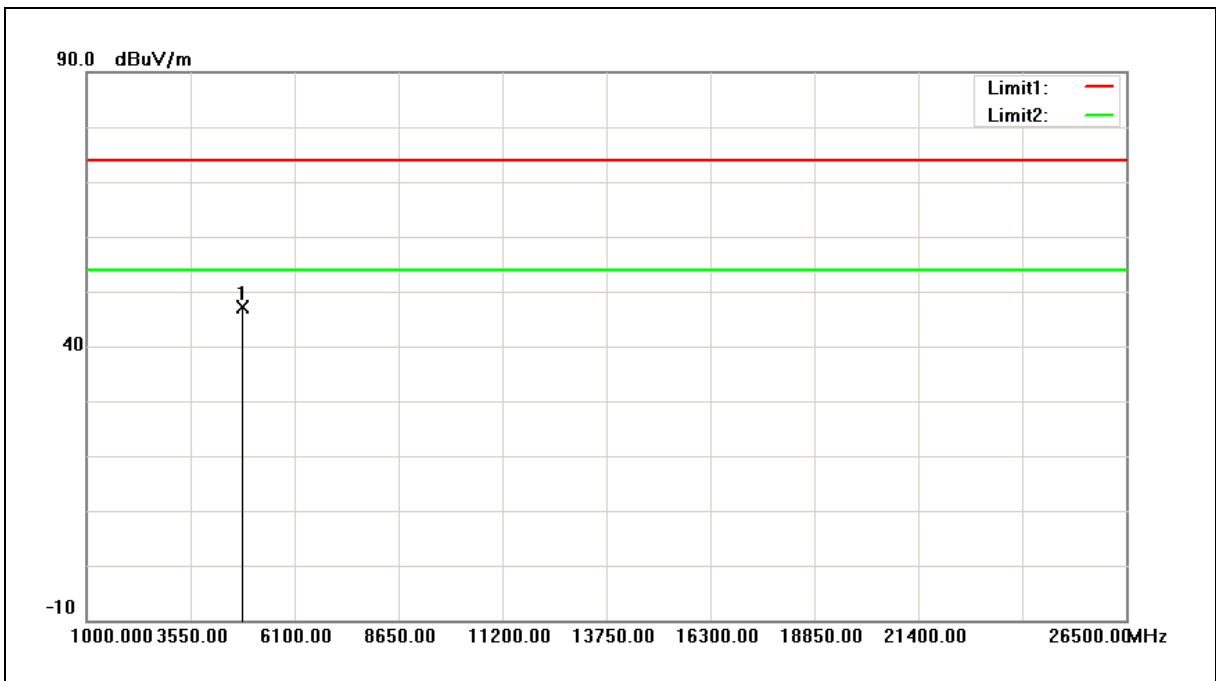

| No. | Frequency (MHz) | Reading (dBuV) | Correct Factor (dB/m) | Result (dBuV/m) | Limit (dBuV/m) | Margin (dB) | Remark |
|-----|-----------------|----------------|-----------------------|-----------------|----------------|-------------|--------|
| 1 | 4824.000 | 53.54 | -6.34 | 47.20 | 74.00 | -26.80 | peak |

Note:1.Result (dBuV/m) = Correct Factor (dB/m) + Reading(dBuV).

2.Correction factor (dB/m) = Antenna Factor (dB/m) + Cable loss (dB) – Pre-Amplifier gain (dB).

3. When the peak results are less than average limit, so not need to evaluate the average.



| | | | |
|-------------|-----------------|----------------------|--------------|
| Standard: | FCC Part 15.247 | Test Distance: | 3m |
| Test item: | Harmonic | Power: | AC 120V/60Hz |
| Frequency: | 2437MHz | Temp.(°C)/Hum.(%RH): | 26(°C)/60%RH |
| Mode: | Mode 4 | Date: | 08/17/2017 |
| Ant.Polar.: | Horizontal | | |

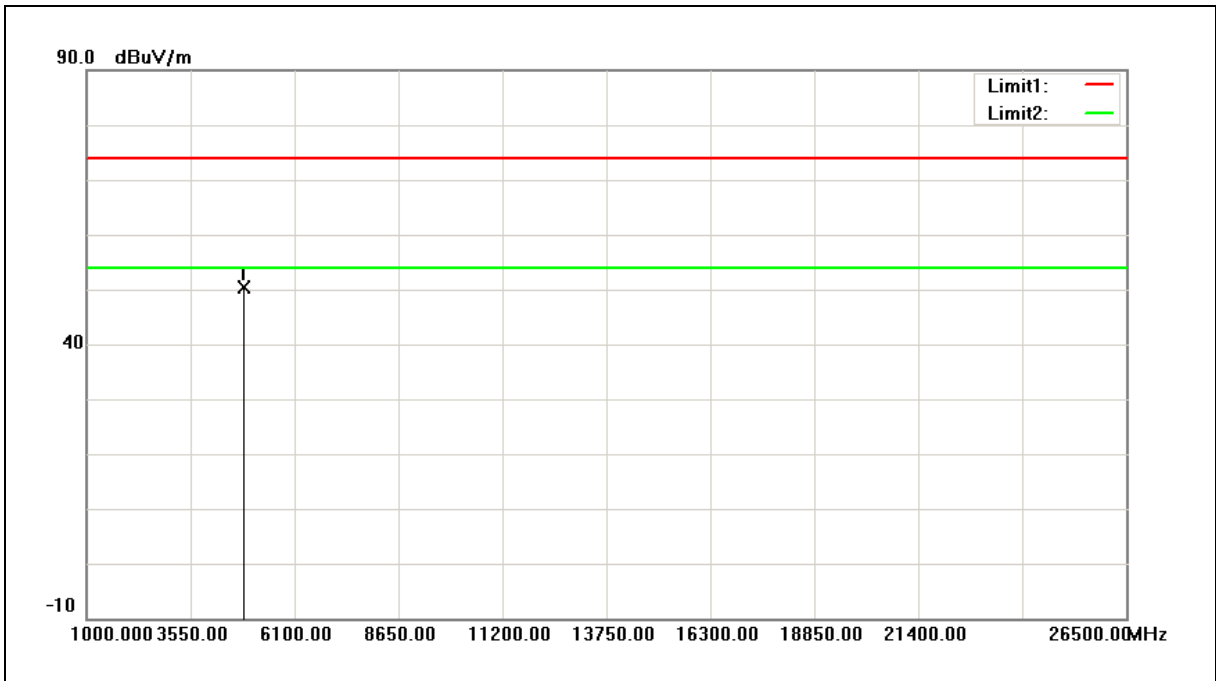

| No. | Frequency (MHz) | Reading (dBuV) | Correct Factor (dB/m) | Result (dBuV/m) | Limit (dBuV/m) | Margin (dB) | Remark |
|-----|-----------------|----------------|-----------------------|-----------------|----------------|-------------|--------|
| 1 | 4874.000 | 56.53 | -6.16 | 50.37 | 74.00 | -23.63 | peak |

Note:1.Result (dBuV/m) = Correct Factor (dB/m) + Reading(dBuV).

2.Correction factor (dB/m) = Antenna Factor (dB/m) + Cable loss (dB) – Pre-Amplifier gain (dB).

3. When the peak results are less than average limit, so not need to evaluate the average.



| | | | |
|-------------|-----------------|----------------------|--------------|
| Standard: | FCC Part 15.247 | Test Distance: | 3m |
| Test item: | Harmonic | Power: | AC 120V/60Hz |
| Frequency: | 2437MHz | Temp.(°C)/Hum.(%RH): | 26(°C)/60%RH |
| Mode: | Mode 4 | Date: | 08/17/2017 |
| Ant.Polar.: | Vertical | | |

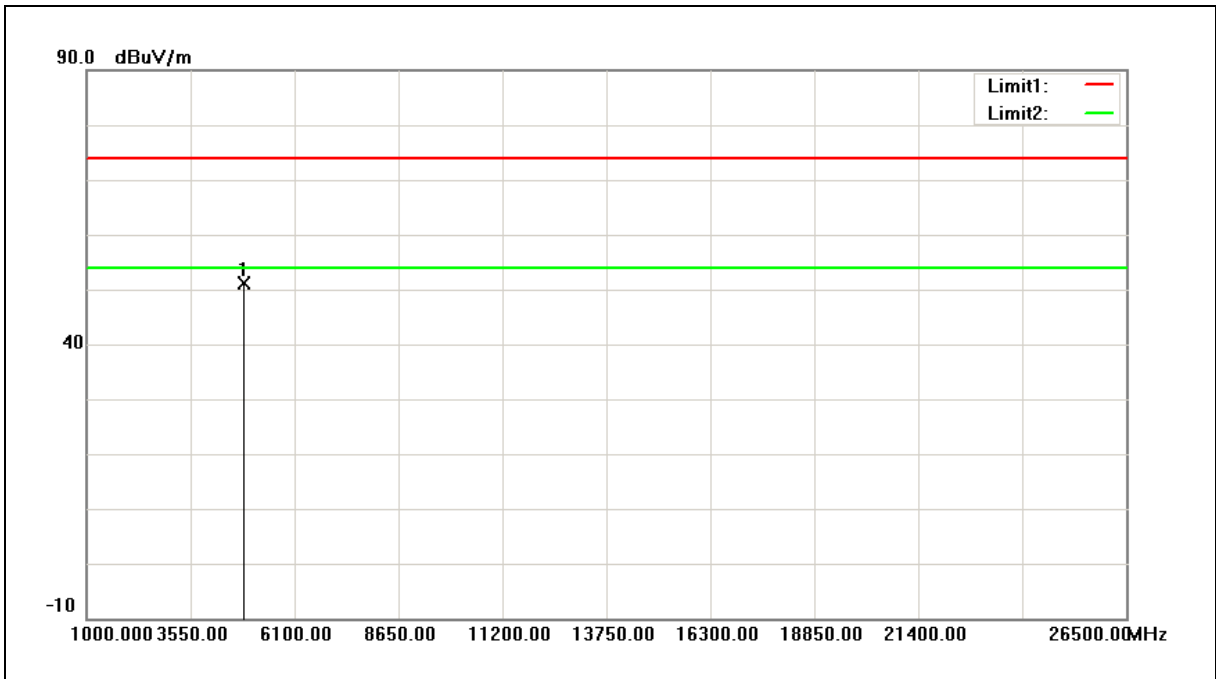

| No. | Frequency (MHz) | Reading (dBuV) | Correct Factor (dB/m) | Result (dBuV/m) | Limit (dBuV/m) | Margin (dB) | Remark |
|-----|-----------------|----------------|-----------------------|-----------------|----------------|-------------|--------|
| 1 | 4874.000 | 57.18 | -6.16 | 51.02 | 74.00 | -22.98 | peak |

Note:1.Result (dBuV/m) = Correct Factor (dB/m) + Reading(dBuV).

2.Correction factor (dB/m) = Antenna Factor (dB/m) + Cable loss (dB) – Pre-Amplifier gain (dB).

3. When the peak results are less than average limit, so not need to evaluate the average.



| | | | |
|-------------|-----------------|----------------------|--------------|
| Standard: | FCC Part 15.247 | Test Distance: | 3m |
| Test item: | Harmonic | Power: | AC 120V/60Hz |
| Frequency: | 2462MHz | Temp.(°C)/Hum.(%RH): | 26(°C)/60%RH |
| Mode: | Mode 4 | Date: | 08/17/2017 |
| Ant.Polar.: | Horizontal | | |

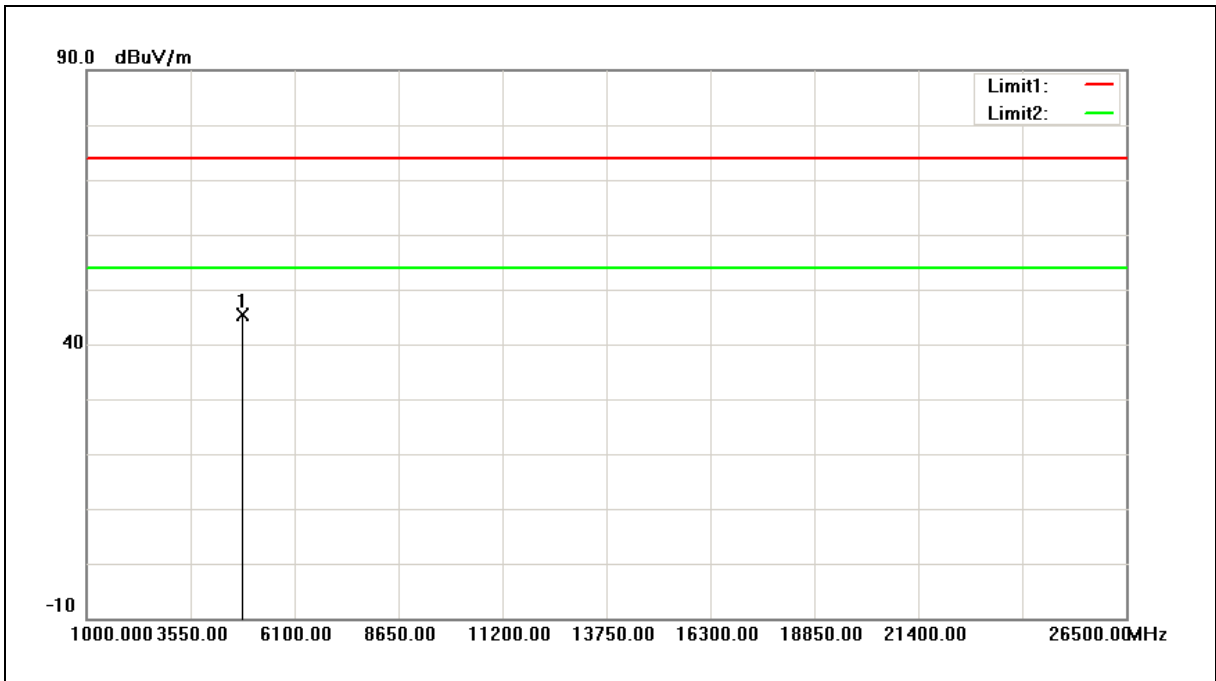

| No. | Frequency (MHz) | Reading (dBuV) | Correct Factor (dB/m) | Result (dBuV/m) | Limit (dBuV/m) | Margin (dB) | Remark |
|-----|-----------------|----------------|-----------------------|-----------------|----------------|-------------|--------|
| 1 | 4824.000 | 51.75 | -6.34 | 45.41 | 74.00 | -28.59 | peak |

Note:1.Result (dBuV/m) = Correct Factor (dB/m) + Reading(dBuV).

2.Correction factor (dB/m) = Antenna Factor (dB/m) + Cable loss (dB) – Pre-Amplifier gain (dB).

3. When the peak results are less than average limit, so not need to evaluate the average.



| | | | |
|-------------|-----------------|----------------------|--------------|
| Standard: | FCC Part 15.247 | Test Distance: | 3m |
| Test item: | Harmonic | Power: | AC 120V/60Hz |
| Frequency: | 2462MHz | Temp.(°C)/Hum.(%RH): | 26(°C)/60%RH |
| Mode: | Mode 4 | Date: | 08/17/2017 |
| Ant.Polar.: | Vertical | | |

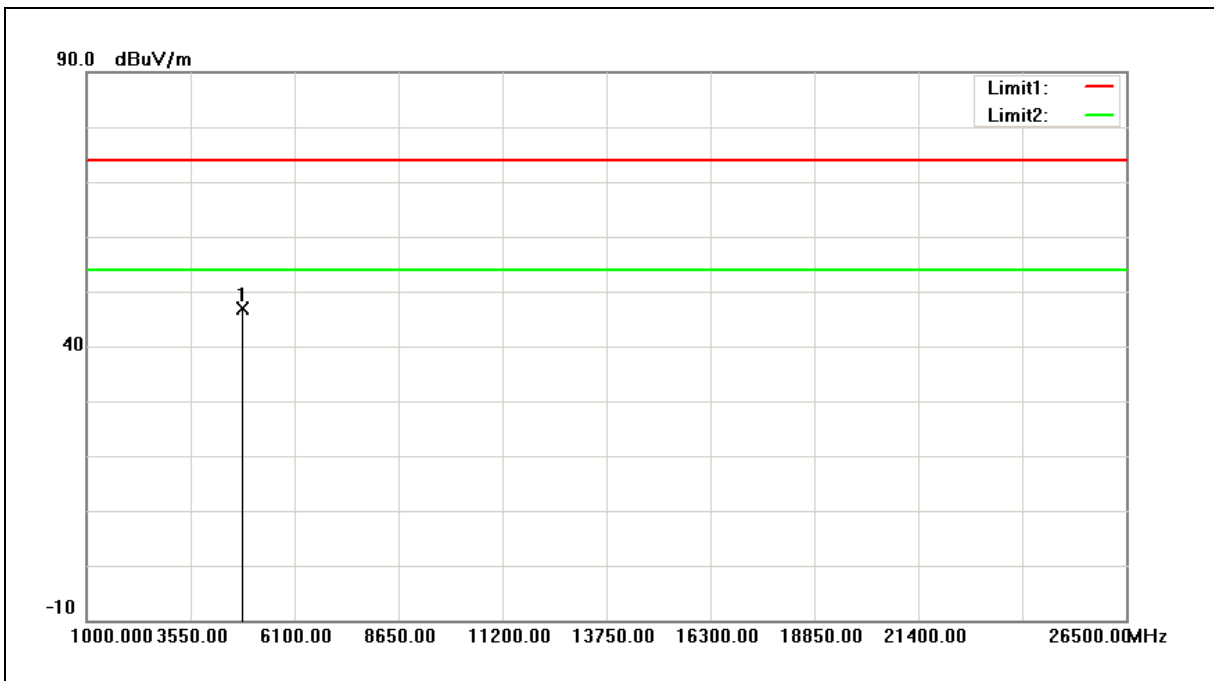

| No. | Frequency (MHz) | Reading (dBuV) | Correct Factor (dB/m) | Result (dBuV/m) | Limit (dBuV/m) | Margin (dB) | Remark |
|-----|-----------------|----------------|-----------------------|-----------------|----------------|-------------|--------|
| 1 | 4824.000 | 53.34 | -6.34 | 47.00 | 74.00 | -27.00 | peak |

Note:1.Result (dBuV/m) = Correct Factor (dB/m) + Reading(dBuV).

2.Correction factor (dB/m) = Antenna Factor (dB/m) + Cable loss (dB) – Pre-Amplifier gain (dB).

3. When the peak results are less than average limit, so not need to evaluate the average.



Band Edge

| | | | |
|-------------|-----------------|----------------------|--------------|
| Standard: | FCC Part 15.247 | Test Distance: | 3m |
| Test item: | Band edge | Power: | AC 120V/60Hz |
| Frequency: | 2412MHz | Temp.(°C)/Hum.(%RH): | 26(°C)/60%RH |
| Mode: | Mode 2 | Date: | 08/16/2017 |
| Ant.Polar.: | Horizontal | | |

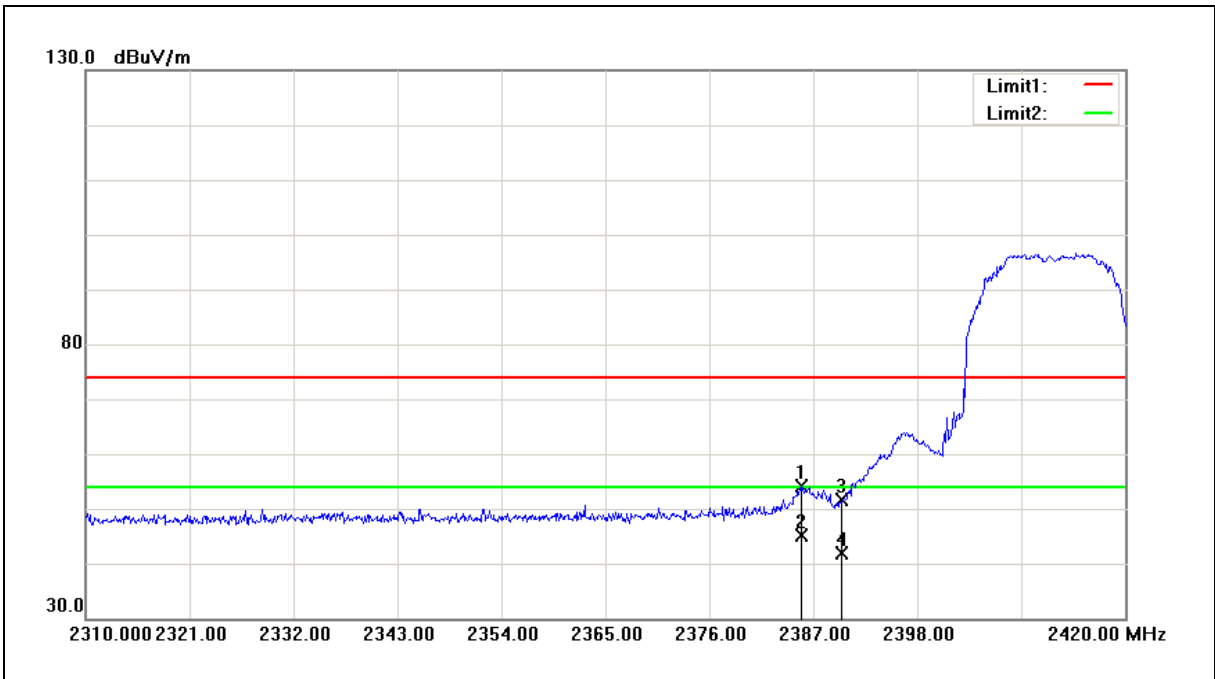

| No. | Frequency (MHz) | Reading (dBuV) | Correct Factor (dB/m) | Result (dBuV/m) | Limit (dBuV/m) | Margin (dB) | Remark |
|-----|-----------------|----------------|-----------------------|-----------------|----------------|-------------|--------|
| 1 | 2385.790 | 53.99 | 0.14 | 54.13 | 74.00 | -19.87 | peak |
| 2 | 2385.790 | 44.88 | 0.14 | 45.02 | 54.00 | -8.98 | AVG |
| 3 | 2390.000 | 51.57 | 0.15 | 51.72 | 74.00 | -22.28 | peak |
| 4 | 2390.000 | 41.76 | 0.15 | 41.91 | 54.00 | -12.09 | AVG |

Note:1.Result (dBuV/m) = Correct Factor (dB/m) + Reading(dBuV).

2.Correction factor (dB/m) = Antenna Factor (dB/m) + Cable loss (dB) – Pre-Amplifier gain (dB).

3. When the peak results are less than average limit, so not need to evaluate the average.



| | | | |
|-------------|-----------------|----------------------|--------------|
| Standard: | FCC Part 15.247 | Test Distance: | 3m |
| Test item: | Band edge | Power: | AC 120V/60Hz |
| Frequency: | 2412MHz | Temp.(°C)/Hum.(%RH): | 26(°C)/60%RH |
| Mode: | Mode 2 | Date: | 08/16/2017 |
| Ant.Polar.: | Vertical | | |

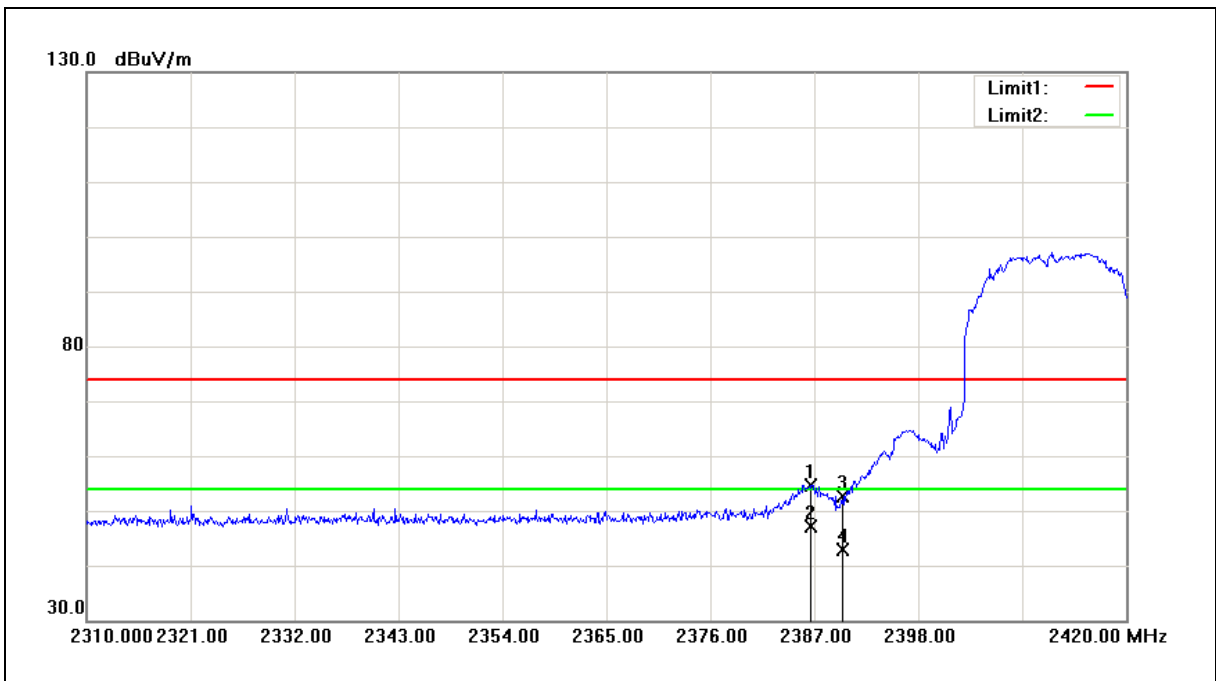

| No. | Frequency (MHz) | Reading (dBuV) | Correct Factor (dB/m) | Result (dBuV/m) | Limit (dBuV/m) | Margin (dB) | Remark |
|-----|-----------------|----------------|-----------------------|-----------------|----------------|-------------|--------|
| 1 | 2386.670 | 54.58 | 0.14 | 54.72 | 74.00 | -19.28 | peak |
| 2 | 2386.670 | 47.04 | 0.14 | 47.18 | 54.00 | -6.82 | AVG |
| 3 | 2390.000 | 52.41 | 0.15 | 52.56 | 74.00 | -21.44 | peak |
| 4 | 2390.000 | 42.63 | 0.15 | 42.78 | 54.00 | -11.22 | AVG |

Note:1.Result (dBuV/m) = Correct Factor (dB/m) + Reading(dBuV).

2.Correction factor (dB/m) = Antenna Factor (dB/m) + Cable loss (dB) – Pre-Amplifier gain (dB).

3. When the peak results are less than average limit, so not need to evaluate the average.



| | | | |
|-------------|-----------------|----------------------|--------------|
| Standard: | FCC Part 15.247 | Test Distance: | 3m |
| Test item: | Band edge | Power: | AC 120V/60Hz |
| Frequency: | 2437MHz | Temp.(°C)/Hum.(%RH): | 26(°C)/60%RH |
| Mode: | Mode 2 | Date: | 08/17/2017 |
| Ant.Polar.: | Horizontal | | |

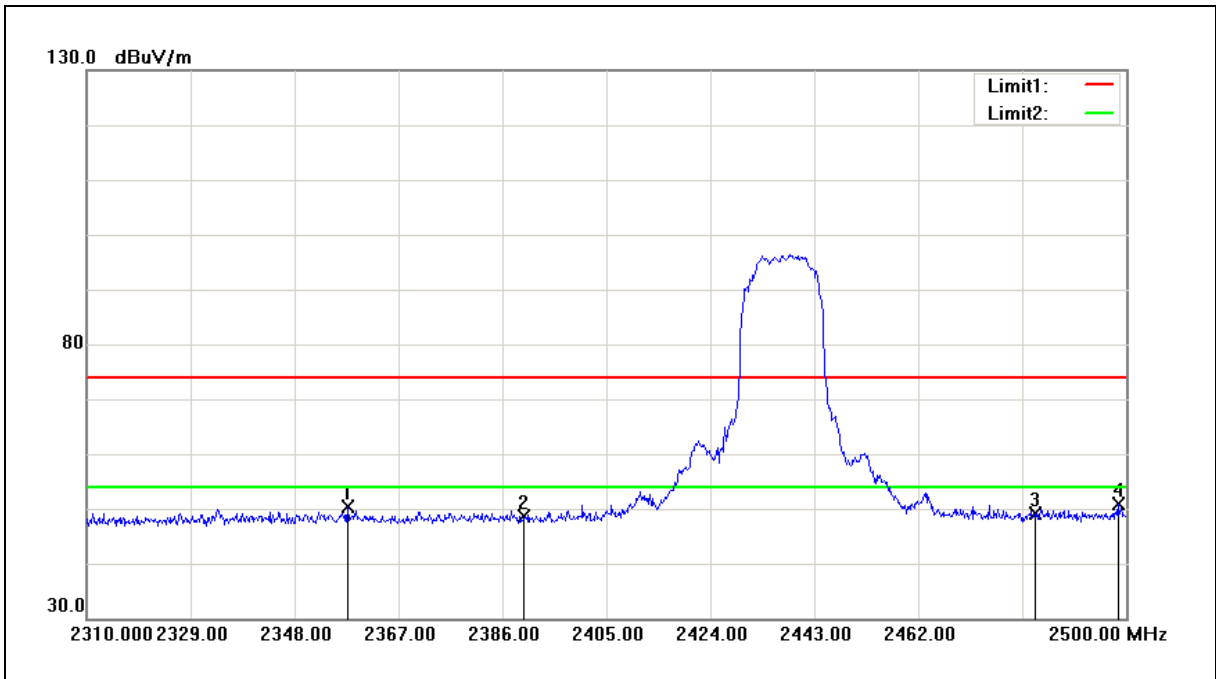

| No. | Frequency (MHz) | Reading (dBuV) | Correct Factor (dB/m) | Result (dBuV/m) | Limit (dBuV/m) | Margin (dB) | Remark |
|-----|-----------------|----------------|-----------------------|-----------------|----------------|-------------|--------|
| 1 | 2357.690 | 50.32 | 0.02 | 50.34 | 74.00 | -23.66 | peak |
| 2 | 2390.000 | 48.49 | 0.15 | 48.64 | 74.00 | -25.36 | peak |
| 3 | 2483.500 | 48.58 | 0.55 | 49.13 | 74.00 | -24.87 | peak |
| 4 | 2498.480 | 50.14 | 0.62 | 50.76 | 74.00 | -23.24 | peak |

Note:1.Result (dBuV/m) = Correct Factor (dB/m) + Reading(dBuV).

2.Correction factor (dB/m) = Antenna Factor (dB/m) + Cable loss (dB) – Pre-Amplifier gain (dB).

3. When the peak results are less than average limit, so not need to evaluate the average.



| | | | |
|-------------|-----------------|----------------------|--------------|
| Standard: | FCC Part 15.247 | Test Distance: | 3m |
| Test item: | Band edge | Power: | AC 120V/60Hz |
| Frequency: | 2437MHz | Temp.(°C)/Hum.(%RH): | 26(°C)/60%RH |
| Mode: | Mode 2 | Date: | 08/16/2017 |
| Ant.Polar.: | Vertical | | |

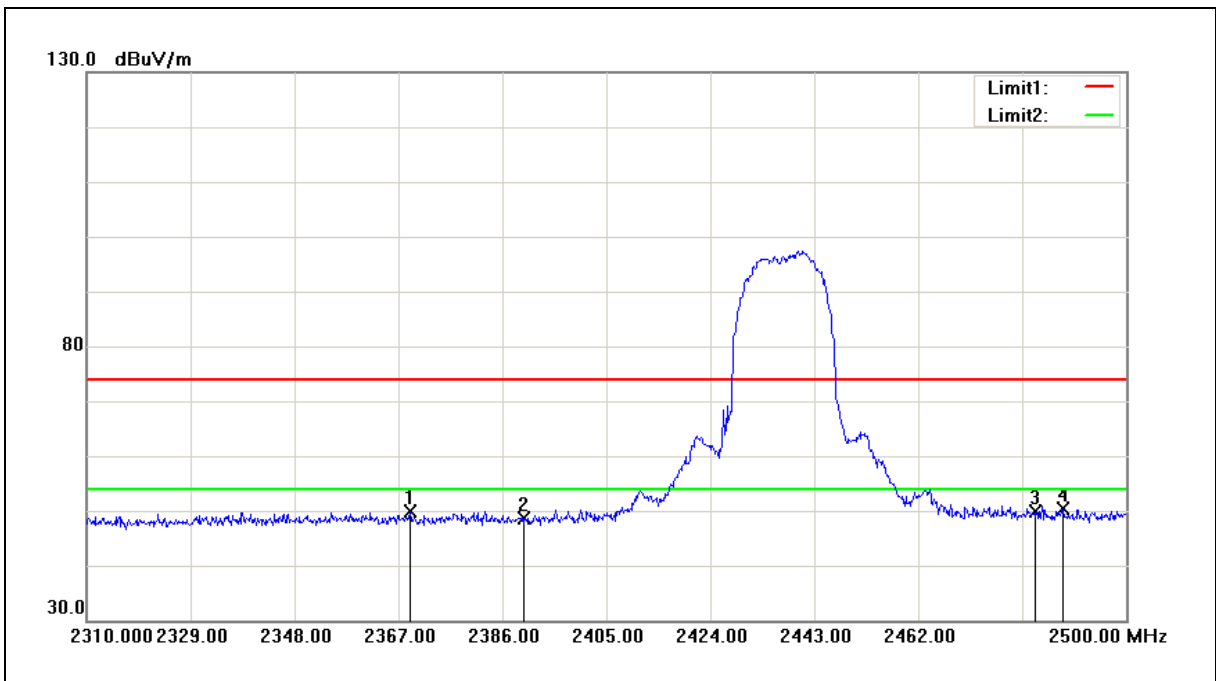

| No. | Frequency (MHz) | Reading (dBuV) | Correct Factor (dB/m) | Result (dBuV/m) | Limit (dBuV/m) | Margin (dB) | Remark |
|-----|-----------------|----------------|-----------------------|-----------------|----------------|-------------|--------|
| 1 | 2369.090 | 49.74 | 0.06 | 49.80 | 74.00 | -24.20 | peak |
| 2 | 2390.000 | 48.55 | 0.15 | 48.70 | 74.00 | -25.30 | peak |
| 3 | 2483.500 | 49.22 | 0.55 | 49.77 | 74.00 | -24.23 | peak |
| 4 | 2488.410 | 49.77 | 0.57 | 50.34 | 74.00 | -23.66 | peak |

Note:1.Result (dBuV/m) = Correct Factor (dB/m) + Reading(dBuV).

2.Correction factor (dB/m) = Antenna Factor (dB/m) + Cable loss (dB) – Pre-Amplifier gain (dB).

3. When the peak results are less than average limit, so not need to evaluate the average.



| | | | |
|-------------|-----------------|----------------------|--------------|
| Standard: | FCC Part 15.247 | Test Distance: | 3m |
| Test item: | Band edge | Power: | AC 120V/60Hz |
| Frequency: | 2462MHz | Temp.(°C)/Hum.(%RH): | 26(°C)/60%RH |
| Mode: | Mode 2 | Date: | 08/17/2017 |
| Ant.Polar.: | Horizontal | | |

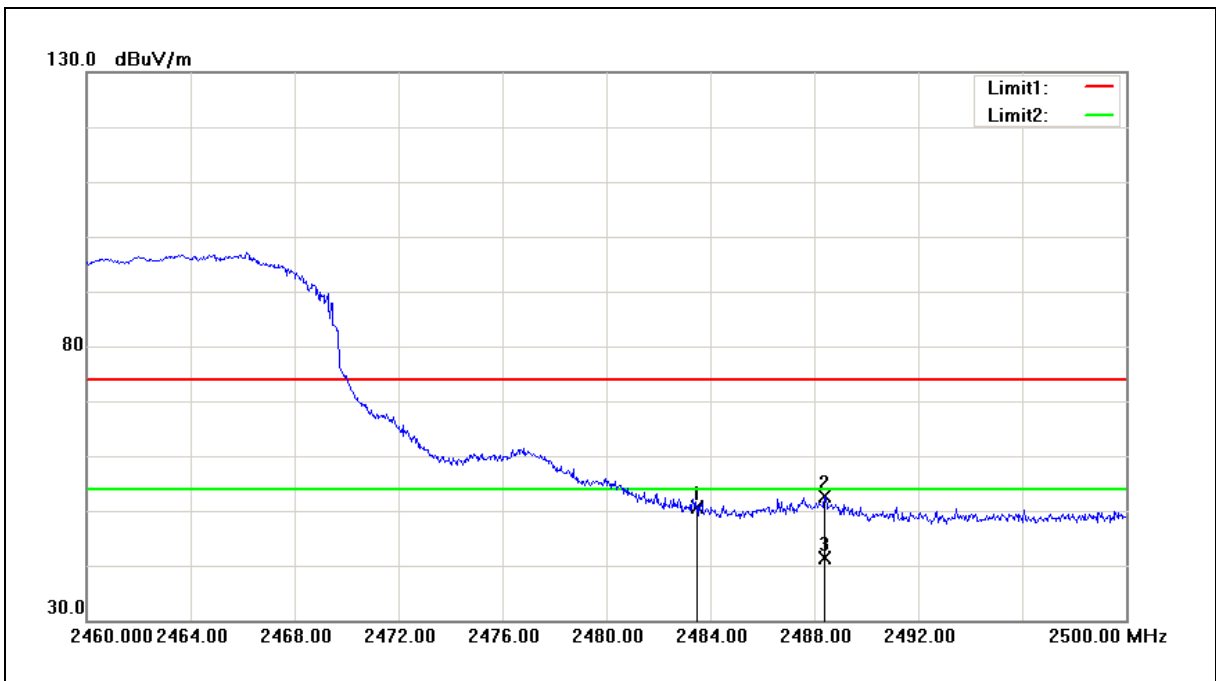

| No. | Frequency (MHz) | Reading (dBuV) | Correct Factor (dB/m) | Result (dBuV/m) | Limit (dBuV/m) | Margin (dB) | Remark |
|-----|-----------------|----------------|-----------------------|-----------------|----------------|-------------|--------|
| 1 | 2483.500 | 50.12 | 0.55 | 50.67 | 74.00 | -23.33 | peak |
| 2 | 2488.400 | 52.18 | 0.57 | 52.75 | 74.00 | -21.25 | peak |
| 3 | 2488.400 | 40.89 | 0.57 | 41.46 | 54.00 | -12.54 | AVG |

Note:1.Result (dBuV/m) = Correct Factor (dB/m) + Reading(dBuV).

2.Correction factor (dB/m) = Antenna Factor (dB/m) + Cable loss (dB) – Pre-Amplifier gain (dB).

3. When the peak results are less than average limit, so not need to evaluate the average.



| | | | |
|-------------|-----------------|----------------------|--------------|
| Standard: | FCC Part 15.247 | Test Distance: | 3m |
| Test item: | Band edge | Power: | AC 120V/60Hz |
| Frequency: | 2462MHz | Temp.(°C)/Hum.(%RH): | 26(°C)/60%RH |
| Mode: | Mode 2 | Date: | 08/17/2017 |
| Ant.Polar.: | Vertical | | |

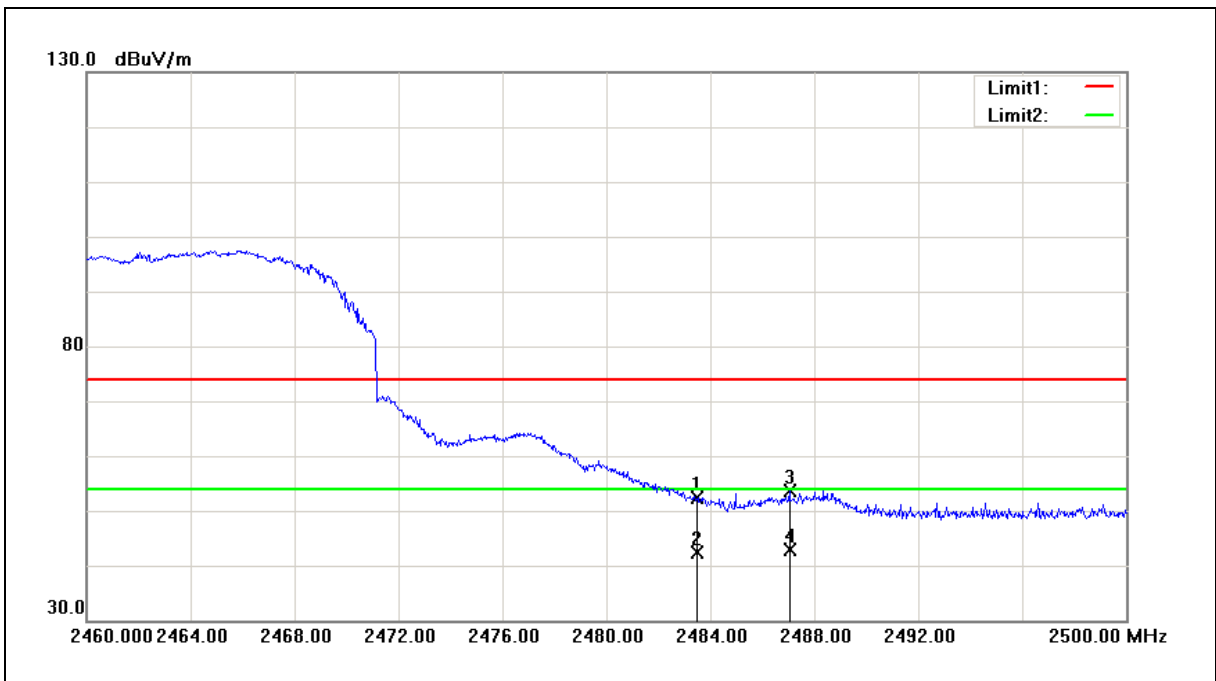

| No. | Frequency (MHz) | Reading (dBuV) | Correct Factor (dB/m) | Result (dBuV/m) | Limit (dBuV/m) | Margin (dB) | Remark |
|-----|-----------------|----------------|-----------------------|-----------------|----------------|-------------|--------|
| 1 | 2483.500 | 51.72 | 0.55 | 52.27 | 74.00 | -21.73 | peak |
| 2 | 2483.500 | 41.89 | 0.55 | 42.44 | 54.00 | -11.56 | AVG |
| 3 | 2487.040 | 52.97 | 0.56 | 53.53 | 74.00 | -20.47 | peak |
| 4 | 2487.040 | 42.38 | 0.56 | 42.94 | 54.00 | -11.06 | AVG |

Note:1.Result (dBuV/m) = Correct Factor (dB/m) + Reading(dBuV).

2.Correction factor (dB/m) = Antenna Factor (dB/m) + Cable loss (dB) – Pre-Amplifier gain (dB).

3. When the peak results are less than average limit, so not need to evaluate the average.



| | | | |
|-------------|-----------------|----------------------|--------------|
| Standard: | FCC Part 15.247 | Test Distance: | 3m |
| Test item: | Band edge | Power: | AC 120V/60Hz |
| Frequency: | 2412MHz | Temp.(°C)/Hum.(%RH): | 26(°C)/60%RH |
| Mode: | Mode 3 | Date: | 08/17/2017 |
| Ant.Polar.: | Horizontal | | |

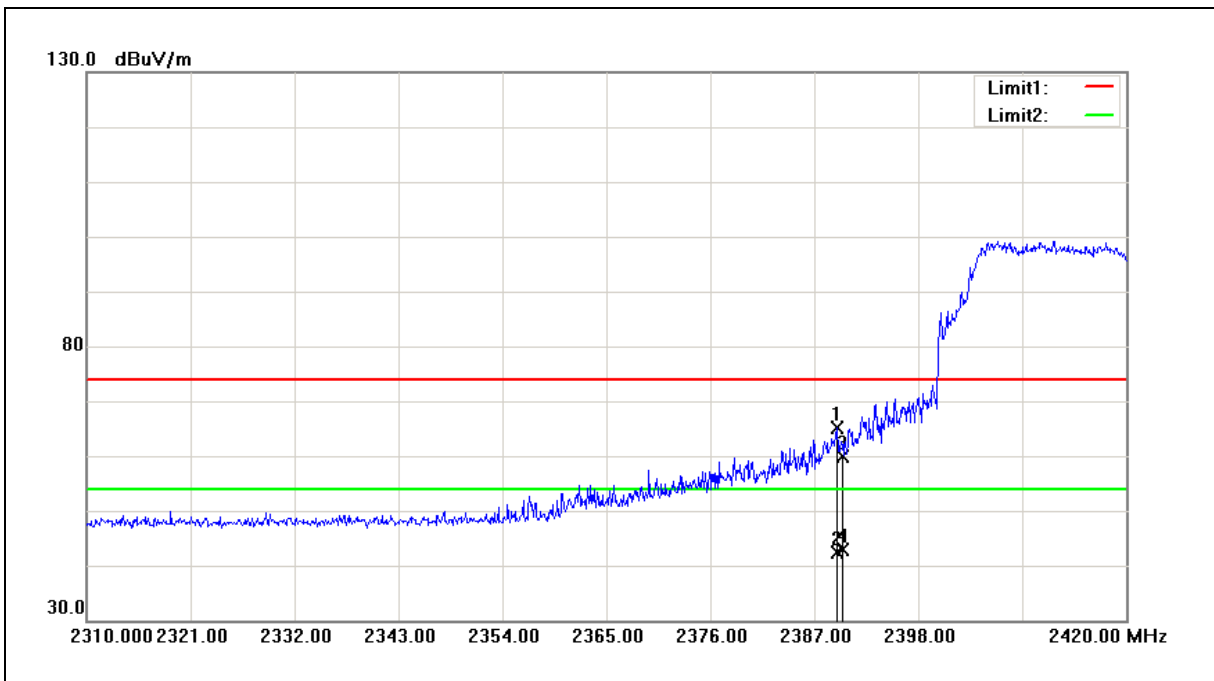

| No. | Frequency (MHz) | Reading (dBuV) | Correct Factor (dB/m) | Result (dBuV/m) | Limit (dBuV/m) | Margin (dB) | Remark |
|-----|-----------------|----------------|-----------------------|-----------------|----------------|-------------|--------|
| 1 | 2389.420 | 64.98 | 0.15 | 65.13 | 74.00 | -8.87 | peak |
| 2 | 2389.420 | 42.31 | 0.15 | 42.46 | 54.00 | -11.54 | AVG |
| 3 | 2390.000 | 59.85 | 0.15 | 60.00 | 74.00 | -14.00 | peak |
| 4 | 2390.000 | 42.77 | 0.15 | 42.92 | 54.00 | -11.08 | AVG |

Note:1.Result (dBuV/m) = Correct Factor (dB/m) + Reading(dBuV).

2.Correction factor (dB/m) = Antenna Factor (dB/m) + Cable loss (dB) – Pre-Amplifier gain (dB).

3. When the peak results are less than average limit, so not need to evaluate the average.



| | | | |
|-------------|-----------------|----------------------|--------------|
| Standard: | FCC Part 15.247 | Test Distance: | 3m |
| Test item: | Band edge | Power: | AC 120V/60Hz |
| Frequency: | 2412MHz | Temp.(°C)/Hum.(%RH): | 26(°C)/60%RH |
| Mode: | Mode 3 | Date: | 08/17/2017 |
| Ant.Polar.: | Vertical | | |

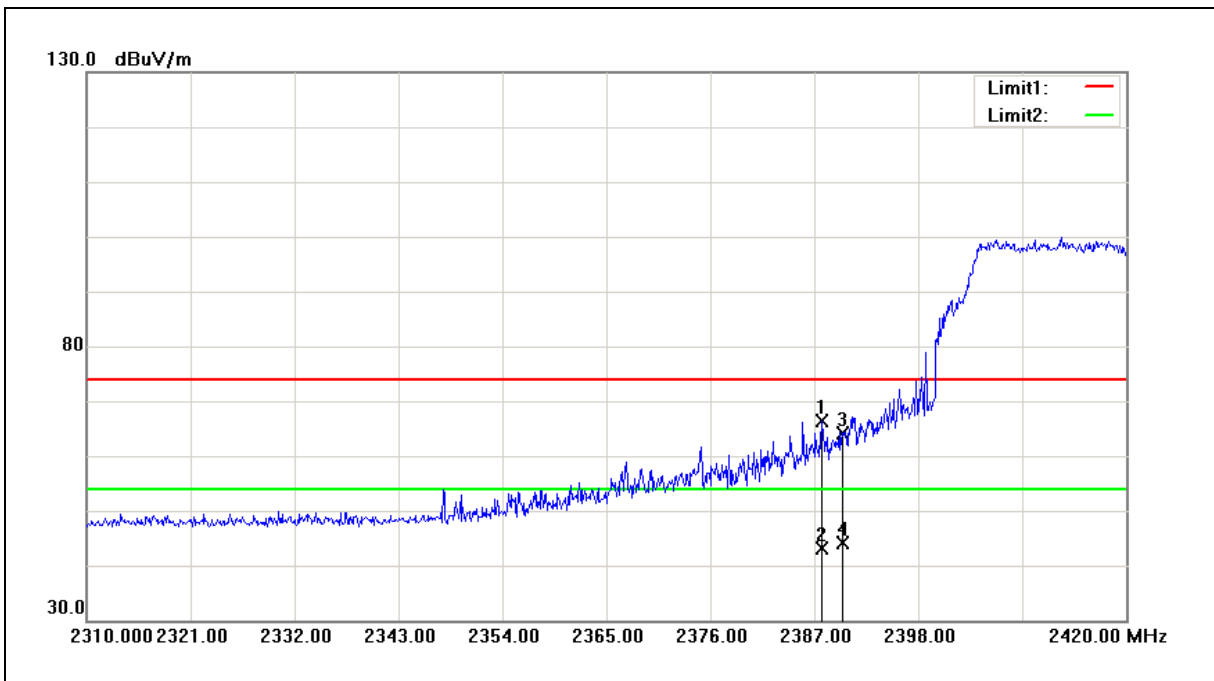

| No. | Frequency (MHz) | Reading (dBuV) | Correct Factor (dB/m) | Result (dBuV/m) | Limit (dBuV/m) | Margin (dB) | Remark |
|-----|-----------------|----------------|-----------------------|-----------------|----------------|-------------|--------|
| 1 | 2387.770 | 66.33 | 0.15 | 66.48 | 74.00 | -7.52 | peak |
| 2 | 2387.770 | 42.97 | 0.15 | 43.12 | 54.00 | -10.88 | AVG |
| 3 | 2390.000 | 63.94 | 0.15 | 64.09 | 74.00 | -9.91 | peak |
| 4 | 2390.000 | 44.08 | 0.15 | 44.23 | 54.00 | -9.77 | AVG |

Note:1.Result (dBuV/m) = Correct Factor (dB/m) + Reading(dBuV).

2.Correction factor (dB/m) = Antenna Factor (dB/m) + Cable loss (dB) – Pre-Amplifier gain (dB).

3. When the peak results are less than average limit, so not need to evaluate the average.



| | | | |
|-------------|-----------------|----------------------|--------------|
| Standard: | FCC Part 15.247 | Test Distance: | 3m |
| Test item: | Band edge | Power: | AC 120V/60Hz |
| Frequency: | 2437MHz | Temp.(°C)/Hum.(%RH): | 26(°C)/60%RH |
| Mode: | Mode 3 | Date: | 08/17/2017 |
| Ant.Polar.: | Horizontal | | |

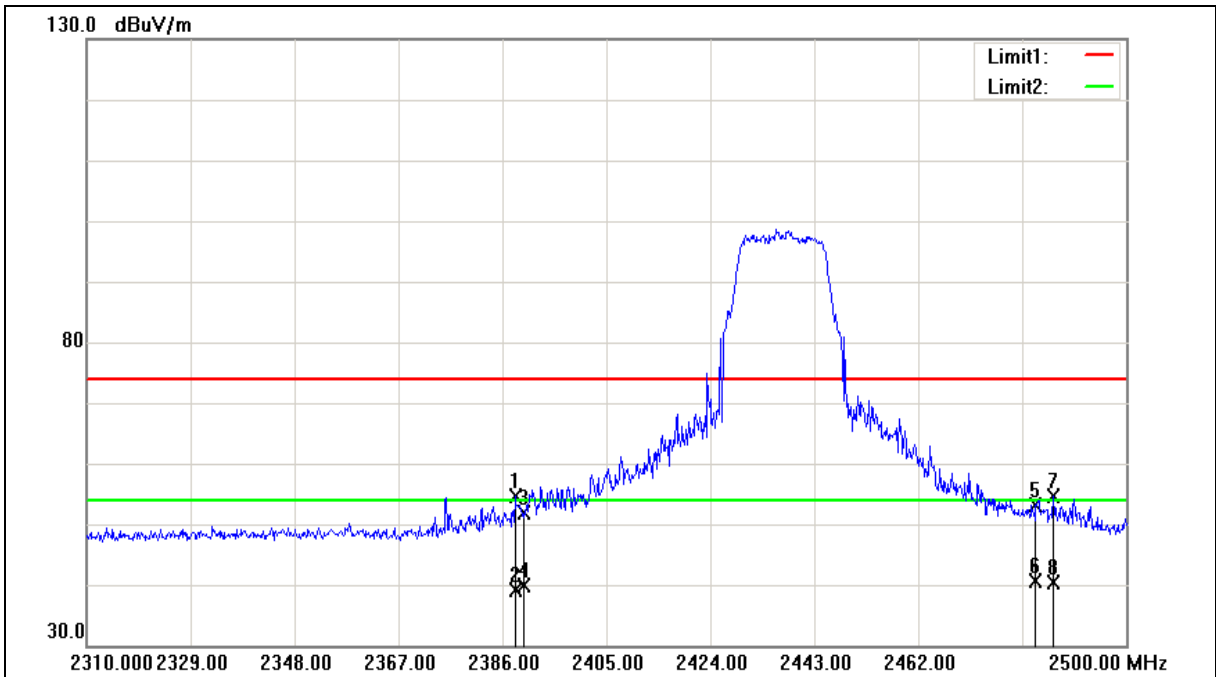

| No. | Frequency (MHz) | Reading (dBuV) | Correct Factor (dB/m) | Result (dBuV/m) | Limit (dBuV/m) | Margin (dB) | Remark |
|-----|-----------------|----------------|-----------------------|-----------------|----------------|-------------|--------|
| 1 | 2388.280 | 54.36 | 0.15 | 54.51 | 74.00 | -19.49 | peak |
| 2 | 2388.280 | 39.06 | 0.15 | 39.21 | 54.00 | -14.79 | AVG |
| 3 | 2390.000 | 51.69 | 0.15 | 51.84 | 74.00 | -22.16 | peak |
| 4 | 2390.000 | 39.70 | 0.15 | 39.85 | 54.00 | -14.15 | AVG |
| 5 | 2483.500 | 52.52 | 0.55 | 53.07 | 74.00 | -20.93 | peak |
| 6 | 2483.500 | 40.17 | 0.55 | 40.72 | 54.00 | -13.28 | AVG |
| 7 | 2486.700 | 54.06 | 0.56 | 54.62 | 74.00 | -19.38 | peak |
| 8 | 2486.700 | 39.86 | 0.56 | 40.42 | 54.00 | -13.58 | AVG |

Note:1. Result (dBuV/m) = Correct Factor (dB/m) + Reading(dBuV).

2. Correction factor (dB/m) = Antenna Factor (dB/m) + Cable loss (dB) - Pre-Amplifier gain (dB).

3. When the peak results are less than average limit, so not need to evaluate the average.



| | | | |
|-------------|-----------------|----------------------|--------------|
| Standard: | FCC Part 15.247 | Test Distance: | 3m |
| Test item: | Band edge | Power: | AC 120V/60Hz |
| Frequency: | 2437MHz | Temp.(°C)/Hum.(%RH): | 26(°C)/60%RH |
| Mode: | Mode 3 | Date: | 08/17/2017 |
| Ant.Polar.: | Vertical | | |

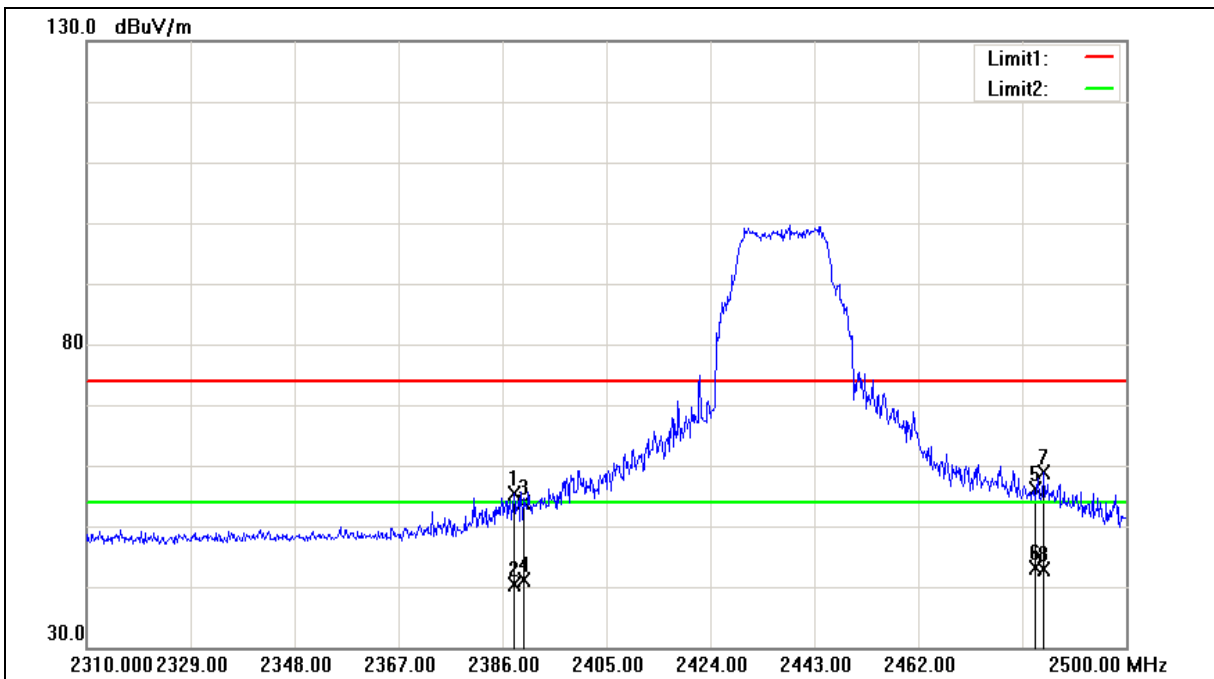

| No. | Frequency (MHz) | Reading (dBuV) | Correct Factor (dB/m) | Result (dBuV/m) | Limit (dBuV/m) | Margin (dB) | Remark |
|-----|-----------------|----------------|-----------------------|-----------------|----------------|-------------|--------|
| 1 | 2388.090 | 55.33 | 0.15 | 55.48 | 74.00 | -18.52 | peak |
| 2 | 2388.090 | 40.30 | 0.15 | 40.45 | 54.00 | -13.55 | AVG |
| 3 | 2390.000 | 53.76 | 0.15 | 53.91 | 74.00 | -20.09 | peak |
| 4 | 2390.000 | 40.94 | 0.15 | 41.09 | 54.00 | -12.91 | AVG |
| 5 | 2483.500 | 55.64 | 0.55 | 56.19 | 74.00 | -17.81 | peak |
| 6 | 2483.500 | 42.57 | 0.55 | 43.12 | 54.00 | -10.88 | AVG |
| 7 | 2484.990 | 58.31 | 0.56 | 58.87 | 74.00 | -15.13 | peak |
| 8 | 2484.990 | 42.31 | 0.56 | 42.87 | 54.00 | -11.13 | AVG |

Note:1. Result (dBuV/m) = Correct Factor (dB/m) + Reading(dBuV).

2. Correction factor (dB/m) = Antenna Factor (dB/m) + Cable loss (dB) - Pre-Amplifier gain (dB).

3. When the peak results are less than average limit, so not need to evaluate the average.



| | | | |
|-------------|-----------------|----------------------|--------------|
| Standard: | FCC Part 15.247 | Test Distance: | 3m |
| Test item: | Band edge | Power: | AC 120V/60Hz |
| Frequency: | 2462MHz | Temp.(°C)/Hum.(%RH): | 26(°C)/60%RH |
| Mode: | Mode 3 | Date: | 08/17/2017 |
| Ant.Polar.: | Horizontal | | |

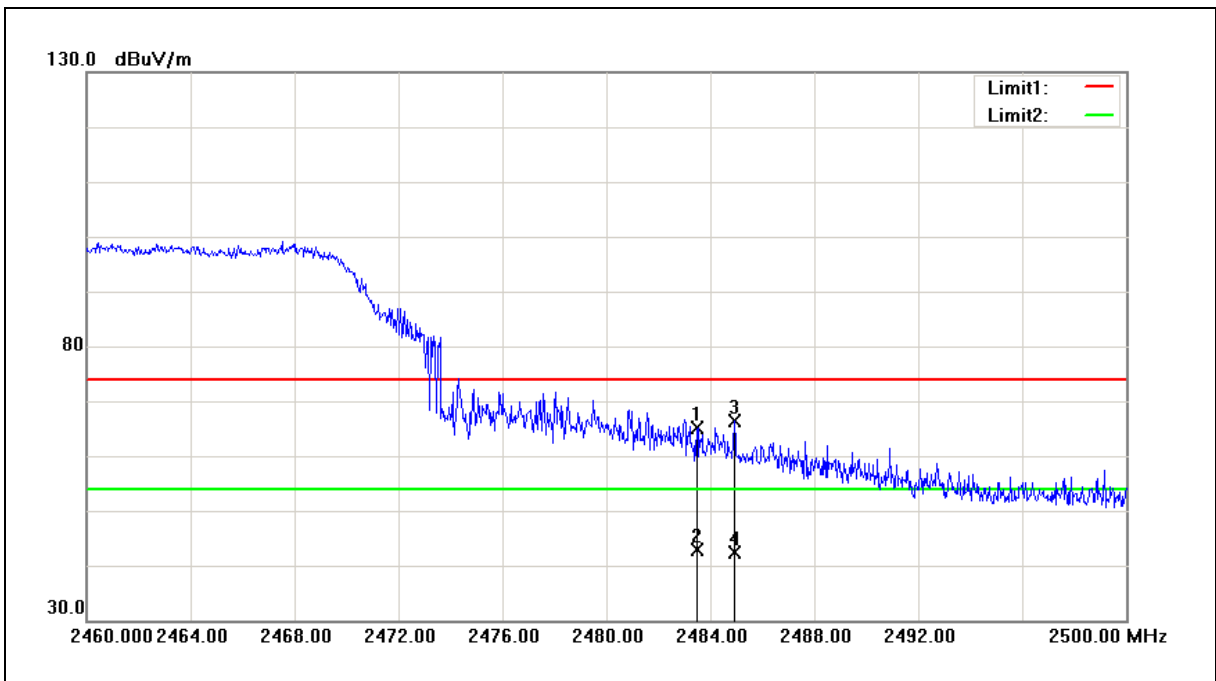

| No. | Frequency (MHz) | Reading (dBuV) | Correct Factor (dB/m) | Result (dBuV/m) | Limit (dBuV/m) | Margin (dB) | Remark |
|-----|-----------------|----------------|-----------------------|-----------------|----------------|-------------|--------|
| 1 | 2483.500 | 64.66 | 0.55 | 65.21 | 74.00 | -8.79 | peak |
| 2 | 2483.500 | 42.29 | 0.55 | 42.84 | 54.00 | -11.16 | AVG |
| 3 | 2484.920 | 65.91 | 0.56 | 66.47 | 74.00 | -7.53 | peak |
| 4 | 2484.920 | 41.82 | 0.56 | 42.38 | 54.00 | -11.62 | AVG |

Note:1.Result (dBuV/m) = Correct Factor (dB/m) + Reading(dBuV).

2.Correction factor (dB/m) = Antenna Factor (dB/m) + Cable loss (dB) – Pre-Amplifier gain (dB).

3. When the peak results are less than average limit, so not need to evaluate the average.



| | | | |
|-------------|-----------------|----------------------|--------------|
| Standard: | FCC Part 15.247 | Test Distance: | 3m |
| Test item: | Band edge | Power: | AC 120V/60Hz |
| Frequency: | 2462MHz | Temp.(°C)/Hum.(%RH): | 26(°C)/60%RH |
| Mode: | Mode 3 | Date: | 08/17/2017 |
| Ant.Polar.: | Vertical | | |

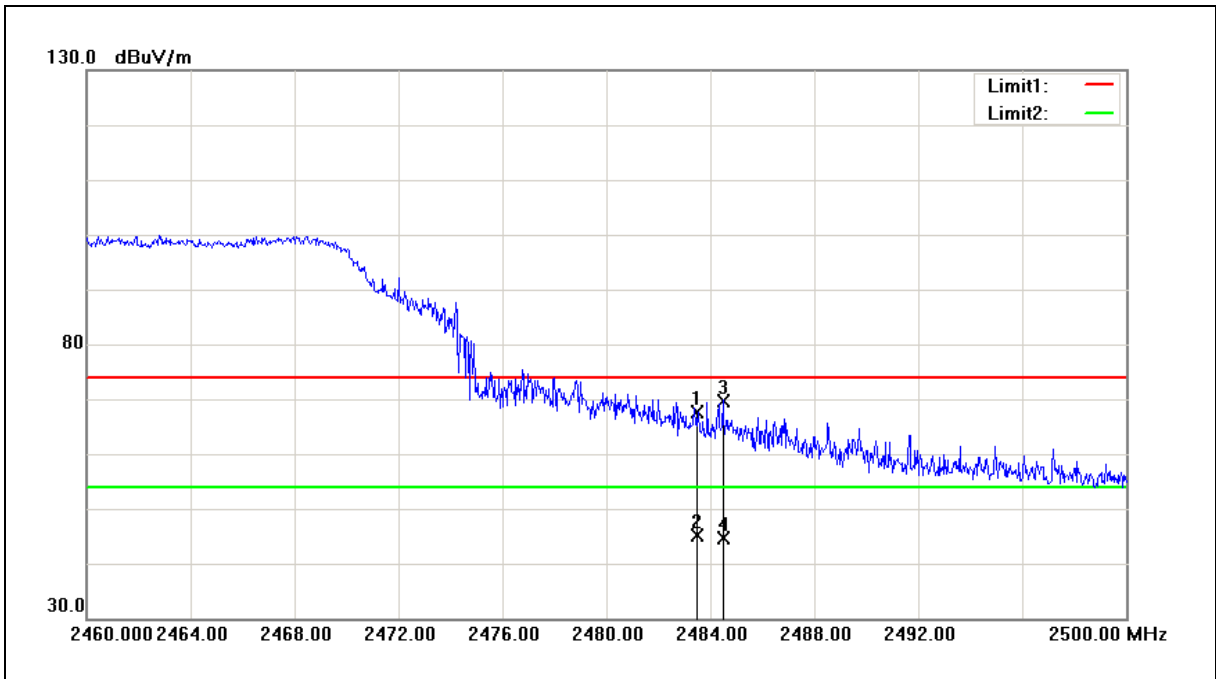

| No. | Frequency (MHz) | Reading (dBuV) | Correct Factor (dB/m) | Result (dBuV/m) | Limit (dBuV/m) | Margin (dB) | Remark |
|-----|-----------------|----------------|-----------------------|-----------------|----------------|-------------|--------|
| 1 | 2483.500 | 67.17 | 0.55 | 67.72 | 74.00 | -6.28 | peak |
| 2 | 2483.500 | 44.54 | 0.55 | 45.09 | 54.00 | -8.91 | AVG |
| 3 | 2484.480 | 69.19 | 0.56 | 69.75 | 74.00 | -4.25 | peak |
| 4 | 2484.480 | 44.06 | 0.56 | 44.62 | 54.00 | -9.38 | AVG |

Note:1.Result (dBuV/m) = Correct Factor (dB/m) + Reading(dBuV).

2.Correction factor (dB/m) = Antenna Factor (dB/m) + Cable loss (dB) – Pre-Amplifier gain (dB).

3. When the peak results are less than average limit, so not need to evaluate the average.



| | | | |
|-------------|-----------------|----------------------|--------------|
| Standard: | FCC Part 15.247 | Test Distance: | 3m |
| Test item: | Band edge | Power: | AC 120V/60Hz |
| Frequency: | 2412MHz | Temp.(°C)/Hum.(%RH): | 26(°C)/60%RH |
| Mode: | Mode 4 | Date: | 08/17/2017 |
| Ant.Polar.: | Vertical | | |

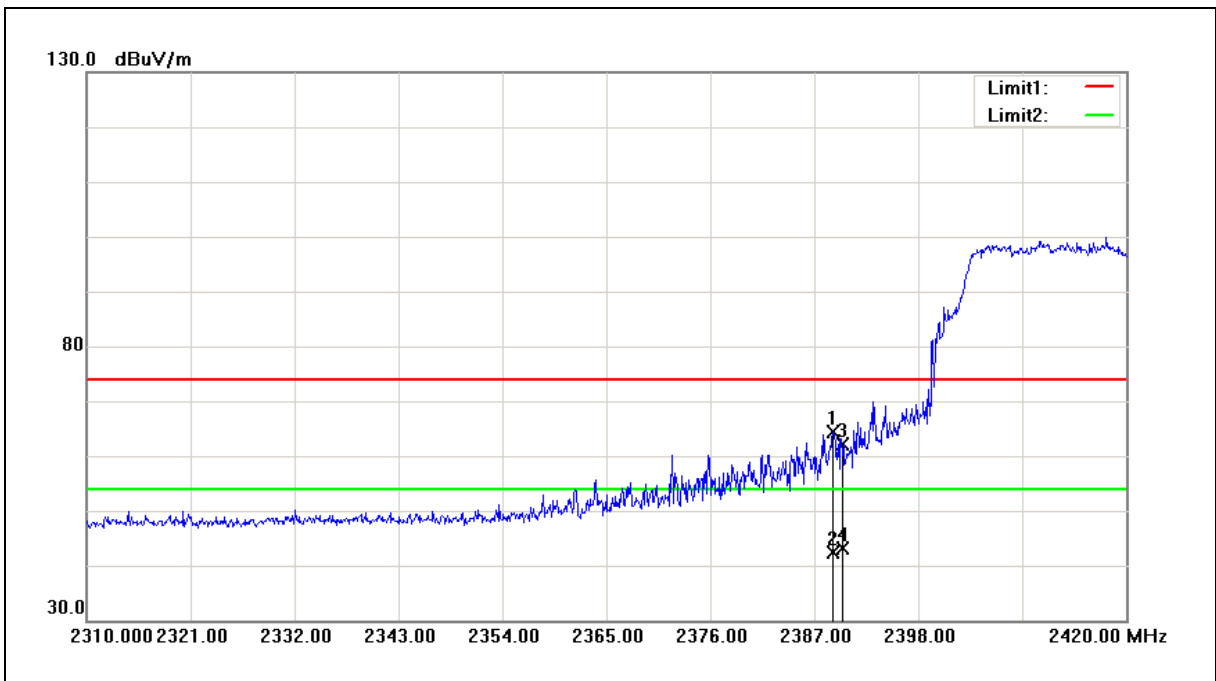

| No. | Frequency (MHz) | Reading (dBuV) | Correct Factor (dB/m) | Result (dBuV/m) | Limit (dBuV/m) | Margin (dB) | Remark |
|-----|-----------------|----------------|-----------------------|-----------------|----------------|-------------|--------|
| 1 | 2388.980 | 64.22 | 0.15 | 64.37 | 74.00 | -9.63 | peak |
| 2 | 2388.980 | 42.27 | 0.15 | 42.42 | 54.00 | -11.58 | AVG |
| 3 | 2390.000 | 61.90 | 0.15 | 62.05 | 74.00 | -11.95 | peak |
| 4 | 2390.000 | 42.89 | 0.15 | 43.04 | 54.00 | -10.96 | AVG |

Note:1.Result (dBuV/m) = Correct Factor (dB/m) + Reading(dBuV).

2.Correction factor (dB/m) = Antenna Factor (dB/m) + Cable loss (dB) – Pre-Amplifier gain (dB).

3. When the peak results are less than average limit, so not need to evaluate the average.



| | | | |
|-------------|-----------------|----------------------|--------------|
| Standard: | FCC Part 15.247 | Test Distance: | 3m |
| Test item: | Band edge | Power: | AC 120V/60Hz |
| Frequency: | 2412MHz | Temp.(°C)/Hum.(%RH): | 26(°C)/60%RH |
| Mode: | Mode 4 | Date: | 08/17/2017 |
| Ant.Polar.: | Horizontal | | |

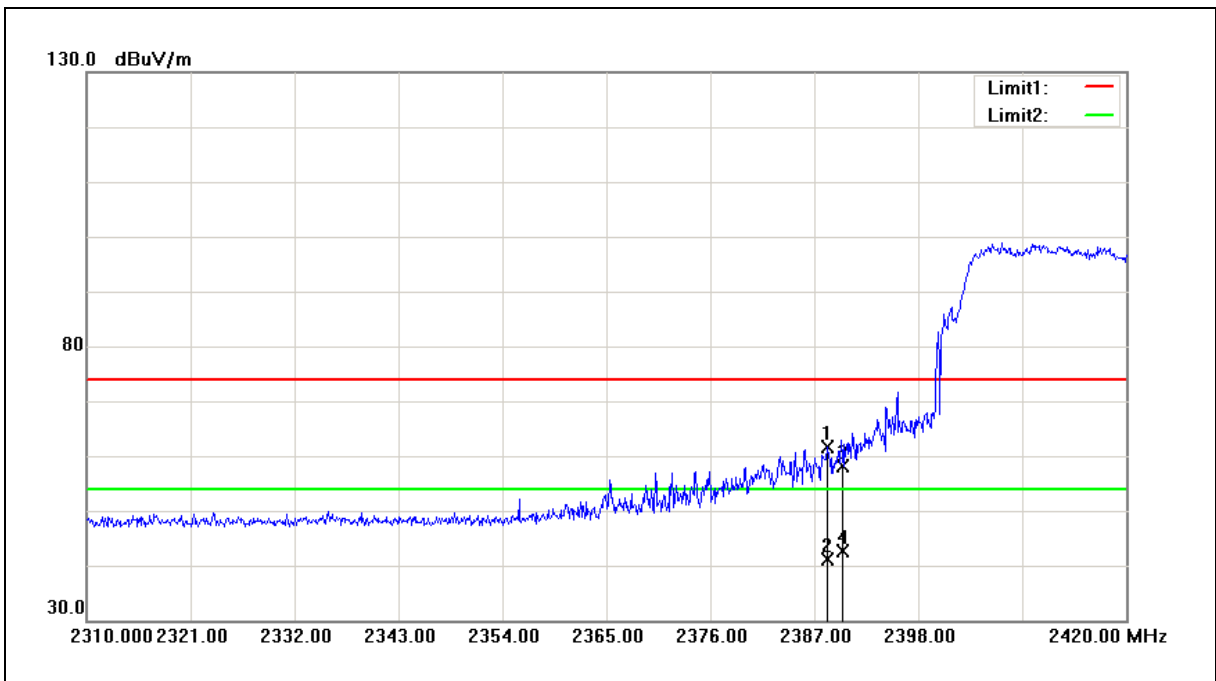

| No. | Frequency (MHz) | Reading (dBuV) | Correct Factor (dB/m) | Result (dBuV/m) | Limit (dBuV/m) | Margin (dB) | Remark |
|-----|-----------------|----------------|-----------------------|-----------------|----------------|-------------|--------|
| 1 | 2388.320 | 61.37 | 0.15 | 61.52 | 74.00 | -12.48 | peak |
| 2 | 2388.320 | 41.07 | 0.15 | 41.22 | 54.00 | -12.78 | AVG |
| 3 | 2390.000 | 57.91 | 0.15 | 58.06 | 74.00 | -15.94 | peak |
| 4 | 2390.000 | 42.42 | 0.15 | 42.57 | 54.00 | -11.43 | AVG |

Note:1.Result (dBuV/m) = Correct Factor (dB/m) + Reading(dBuV).

2.Correction factor (dB/m) = Antenna Factor (dB/m) + Cable loss (dB) – Pre-Amplifier gain (dB).

3. When the peak results are less than average limit, so not need to evaluate the average.



| | | | |
|-------------|-----------------|----------------------|--------------|
| Standard: | FCC Part 15.247 | Test Distance: | 3m |
| Test item: | Band edge | Power: | AC 120V/60Hz |
| Frequency: | 2437MHz | Temp.(°C)/Hum.(%RH): | 26(°C)/60%RH |
| Mode: | Mode 4 | Date: | 08/17/2017 |
| Ant.Polar.: | Horizontal | | |

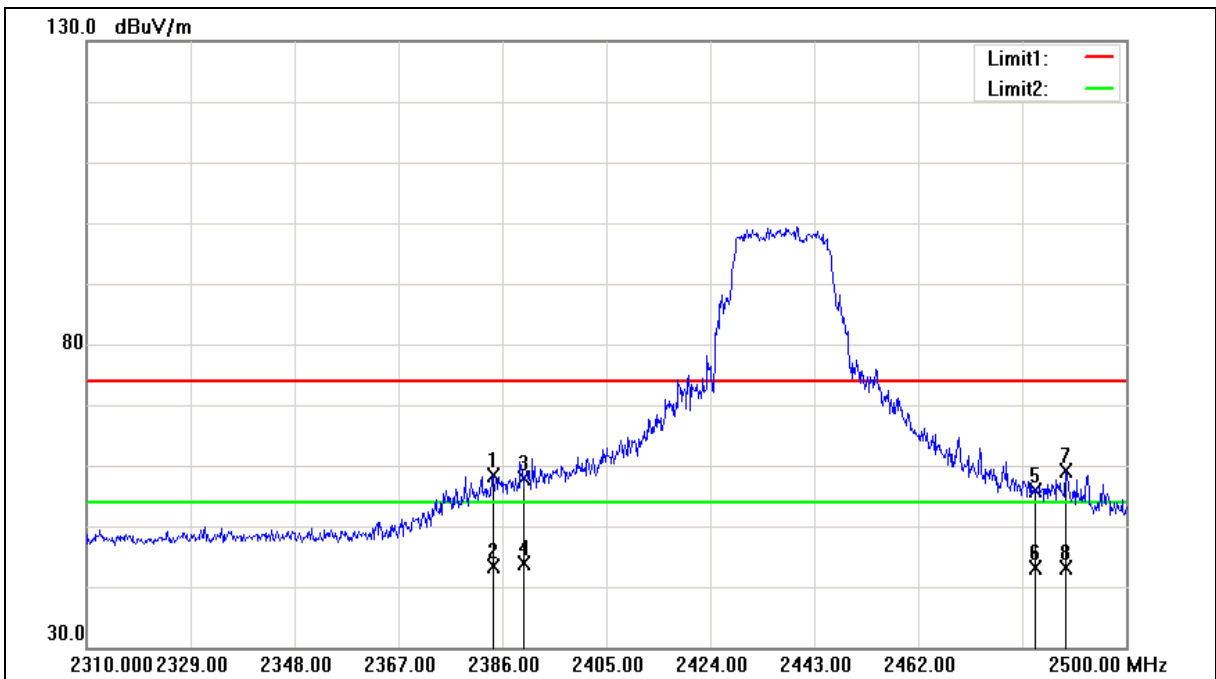

| No. | Frequency (MHz) | Reading (dBuV) | Correct Factor (dB/m) | Result (dBuV/m) | Limit (dBuV/m) | Margin (dB) | Remark |
|-----|-----------------|----------------|-----------------------|-----------------|----------------|-------------|--------|
| 1 | 2384.290 | 58.19 | 0.14 | 58.33 | 74.00 | -15.67 | peak |
| 2 | 2384.290 | 43.14 | 0.14 | 43.28 | 54.00 | -10.72 | AVG |
| 3 | 2390.000 | 57.69 | 0.15 | 57.84 | 74.00 | -16.16 | peak |
| 4 | 2390.000 | 43.85 | 0.15 | 44.00 | 54.00 | -10.00 | AVG |
| 5 | 2483.500 | 55.32 | 0.55 | 55.87 | 74.00 | -18.13 | peak |
| 6 | 2483.500 | 42.54 | 0.55 | 43.09 | 54.00 | -10.91 | AVG |
| 7 | 2488.980 | 58.47 | 0.57 | 59.04 | 74.00 | -14.96 | peak |
| 8 | 2488.980 | 42.44 | 0.57 | 43.01 | 54.00 | -10.99 | AVG |

Note:1.Result (dBuV/m) = Correct Factor (dB/m) + Reading(dBuV).

2.Correction factor (dB/m) = Antenna Factor (dB/m) + Cable loss (dB) – Pre-Amplifier gain (dB).

3. When the peak results are less than average limit, so not need to evaluate the average.



| | | | |
|-------------|-----------------|----------------------|--------------|
| Standard: | FCC Part 15.247 | Test Distance: | 3m |
| Test item: | Band edge | Power: | AC 120V/60Hz |
| Frequency: | 2437MHz | Temp.(°C)/Hum.(%RH): | 26(°C)/60%RH |
| Mode: | Mode 4 | Date: | 08/17/2017 |
| Ant.Polar.: | Vertical | | |

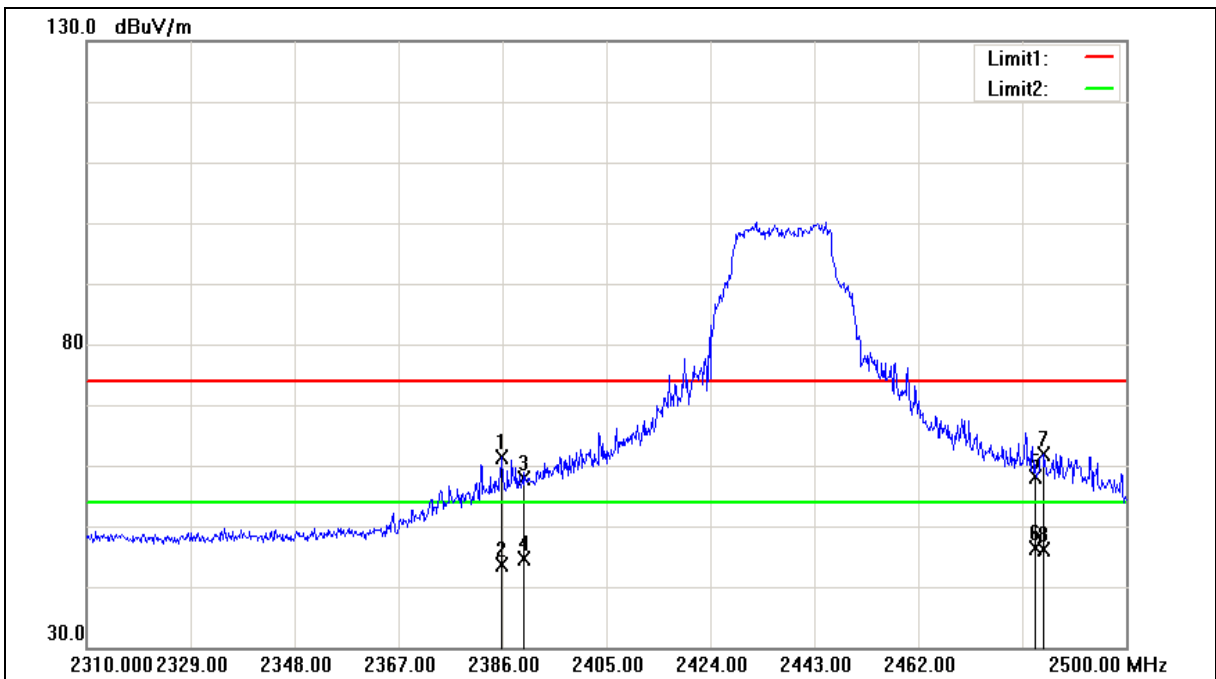

| No. | Frequency (MHz) | Reading (dBuV) | Correct Factor (dB/m) | Result (dBuV/m) | Limit (dBuV/m) | Margin (dB) | Remark |
|-----|-----------------|----------------|-----------------------|-----------------|----------------|-------------|--------|
| 1 | 2385.810 | 61.17 | 0.14 | 61.31 | 74.00 | -12.69 | peak |
| 2 | 2385.810 | 43.53 | 0.14 | 43.67 | 54.00 | -10.33 | AVG |
| 3 | 2390.000 | 57.78 | 0.15 | 57.93 | 74.00 | -16.07 | peak |
| 4 | 2390.000 | 44.42 | 0.15 | 44.57 | 54.00 | -9.43 | AVG |
| 5 | 2483.500 | 57.60 | 0.55 | 58.15 | 74.00 | -15.85 | peak |
| 6 | 2483.500 | 45.93 | 0.55 | 46.48 | 54.00 | -7.52 | AVG |
| 7 | 2484.800 | 61.24 | 0.56 | 61.80 | 74.00 | -12.20 | peak |
| 8 | 2484.800 | 45.69 | 0.56 | 46.25 | 54.00 | -7.75 | AVG |

Note:1.Result (dBuV/m) = Correct Factor (dB/m) + Reading(dBuV).

2.Correction factor (dB/m) = Antenna Factor (dB/m) + Cable loss (dB) – Pre-Amplifier gain (dB).

3. When the peak results are less than average limit, so not need to evaluate the average.



| | | | |
|-------------|-----------------|----------------------|--------------|
| Standard: | FCC Part 15.247 | Test Distance: | 3m |
| Test item: | Band edge | Power: | AC 120V/60Hz |
| Frequency: | 2462MHz | Temp.(°C)/Hum.(%RH): | 26(°C)/60%RH |
| Mode: | Mode 4 | Date: | 08/17/2017 |
| Ant.Polar.: | Horizontal | | |

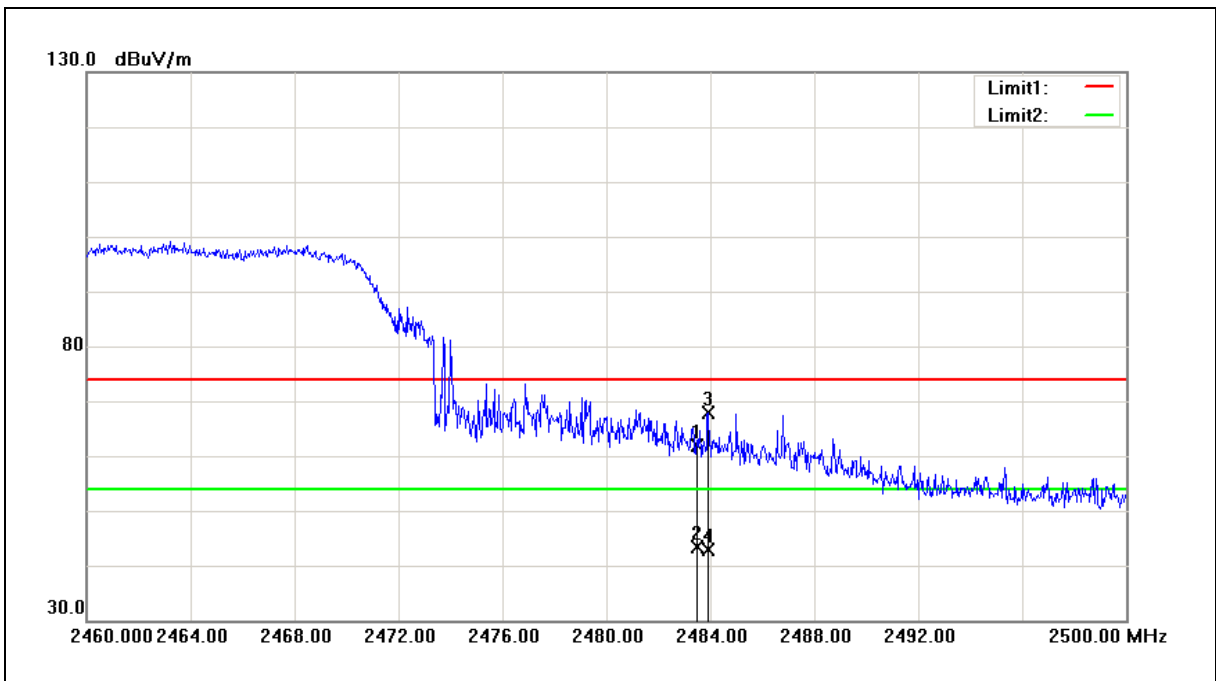

| No. | Frequency (MHz) | Reading (dBuV) | Correct Factor (dB/m) | Result (dBuV/m) | Limit (dBuV/m) | Margin (dB) | Remark |
|-----|-----------------|----------------|-----------------------|-----------------|----------------|-------------|--------|
| 1 | 2483.500 | 61.28 | 0.55 | 61.83 | 74.00 | -12.17 | peak |
| 2 | 2483.500 | 42.73 | 0.55 | 43.28 | 54.00 | -10.72 | AVG |
| 3 | 2483.920 | 67.31 | 0.55 | 67.86 | 74.00 | -6.14 | peak |
| 4 | 2483.920 | 42.37 | 0.55 | 42.92 | 54.00 | -11.08 | AVG |

Note:1.Result (dBuV/m) = Correct Factor (dB/m) + Reading(dBuV).

2.Correction factor (dB/m) = Antenna Factor (dB/m) + Cable loss (dB) – Pre-Amplifier gain (dB).

3. When the peak results are less than average limit, so not need to evaluate the average.



| | | | |
|-------------|-----------------|----------------------|--------------|
| Standard: | FCC Part 15.247 | Test Distance: | 3m |
| Test item: | Band edge | Power: | AC 120V/60Hz |
| Frequency: | 2462MHz | Temp.(°C)/Hum.(%RH): | 26(°C)/60%RH |
| Mode: | Mode 4 | Date: | 08/17/2017 |
| Ant.Polar.: | Vertical | | |

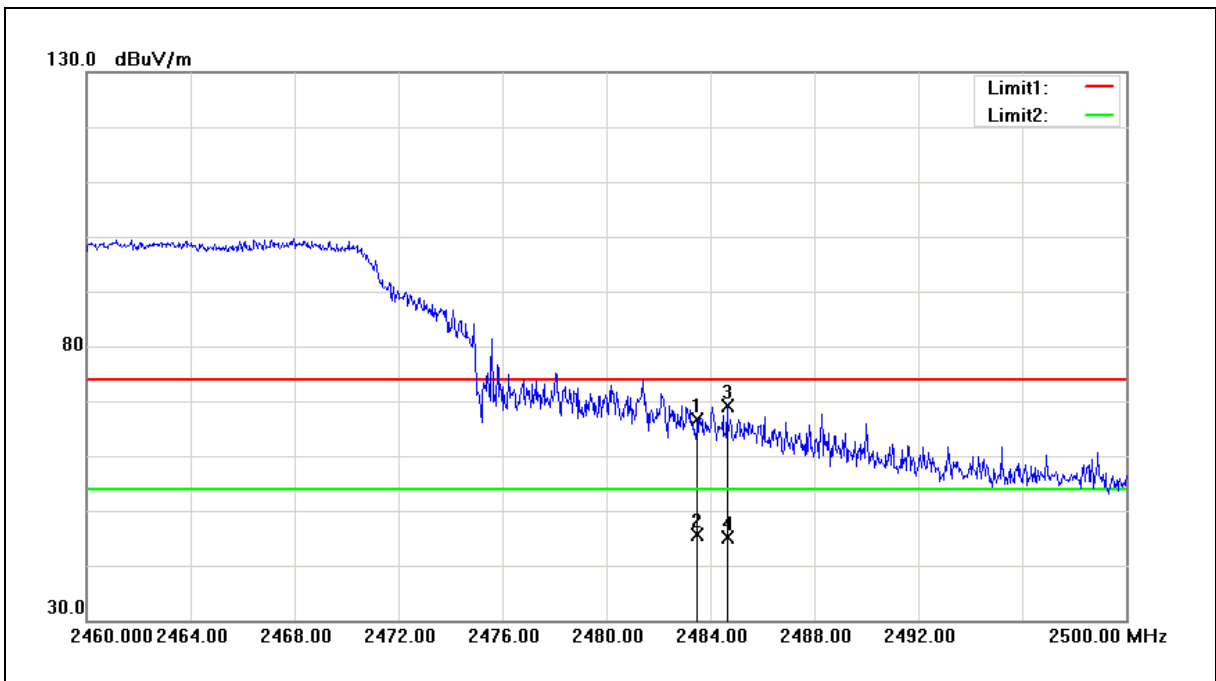

| No. | Frequency (MHz) | Reading (dBuV) | Correct Factor (dB/m) | Result (dBuV/m) | Limit (dBuV/m) | Margin (dB) | Remark |
|-----|-----------------|----------------|-----------------------|-----------------|----------------|-------------|--------|
| 1 | 2483.500 | 66.03 | 0.55 | 66.58 | 74.00 | -7.42 | peak |
| 2 | 2483.500 | 45.11 | 0.55 | 45.66 | 54.00 | -8.34 | AVG |
| 3 | 2484.640 | 68.58 | 0.56 | 69.14 | 74.00 | -4.86 | peak |
| 4 | 2484.640 | 44.47 | 0.56 | 45.03 | 54.00 | -8.97 | AVG |

Note:1.Result (dBuV/m) = Correct Factor (dB/m) + Reading(dBuV).

2.Correction factor (dB/m) = Antenna Factor (dB/m) + Cable loss (dB) – Pre-Amplifier gain (dB).

3. When the peak results are less than average limit, so not need to evaluate the average.

6 Maximum Conducted Output Power Measurement

6.1. Limit

For systems using digital modulation in the 2400-2483.5MHz, the limit for maximum output power is 30dBm.

And According to 15.247 (b), if transmitting antennas of directional gain greater than 6 dBi are used, the power shall be reduced by the amount in dB that the directional gain of the antenna exceeds 6dBi.

SISO mode : Max. Gain = 2.97 dBi < 6 dBi.

6.2. Test Setup

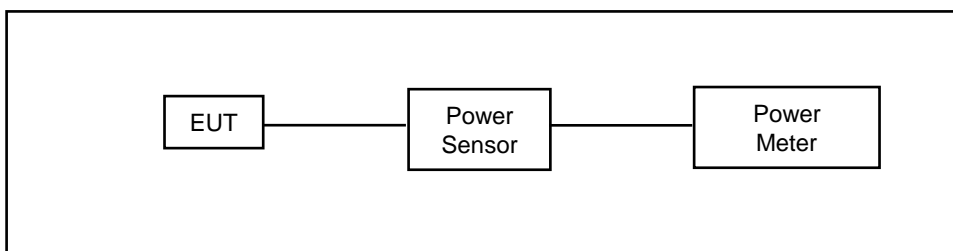

6.3. Test Instruments

| Equipment | Manufacturer | Model Number | Serial Number | Cal. Date | Cal. Period |
|-----------------|--------------|-------------------|---------------|------------|-------------|
| Power Sensor | Anritsu | MA2411B | 1126022 | 08/29/2016 | 1 year |
| Power Meter | Anritsu | ML2495A | 1135009 | 08/29/2016 | 1 year |
| Microwave Cable | EMCI | EMC104-SM-SM-1500 | 140303 | 02/22/2017 | 1 year |
| Test Site | ATL | TE05 | TE05 | N.C.R. | ----- |

Note: N.C.R. = No Calibration Request.

6.4. Test Procedure

The testing follows the Measurement Procedure of ANSI C63.10-2013 section 11.9.2.3 Method AVGPM.

The tests below are run with the EUT's transmitter set at high power in TX mode. The EUT is needed to force selection of output power level and channel number. While testing, EUT was set to transmit continuously. Remove the Subjective device's antenna and connect the RF output port to power sensor.



6.5. Test Result

| Test Item | Maximum Conducted Output Power | | | | | | |
|-----------|--------------------------------|-----------------|----------------------|-------|---------------------|--------------|-------|
| Test Mode | Data Rate (Mbps) | Frequency (MHz) | Average Output Power | | Peak Output Power | | |
| | | | Measurement Results | | Measurement Results | | Limit |
| | | | dBm | W | dBm | W | dBm |
| Mode 2 | 1 | 2412 | 15.41 | 0.035 | 18.65 | 0.073 | < 30 |
| | | 2437 | 11.72 | 0.015 | 15.70 | 0.037 | < 30 |
| | | 2462 | 15.60 | 0.036 | 19.00 | 0.079 | < 30 |
| | 2 | 2437 | 11.70 | 0.015 | 15.68 | 0.037 | < 30 |
| | 5.5 | 2437 | 11.65 | 0.015 | 15.65 | 0.037 | < 30 |
| | 11 | 2437 | 11.62 | 0.015 | 15.61 | 0.036 | < 30 |
| Mode 3 | 6 | 2412 | 13.16 | 0.021 | 21.20 | 0.132 | < 30 |
| | | 2437 | 13.45 | 0.022 | 21.54 | 0.143 | < 30 |
| | | 2462 | 13.27 | 0.021 | 21.38 | 0.137 | < 30 |
| | 9 | 2437 | 13.42 | 0.022 | 21.53 | 0.142 | < 30 |
| | 12 | 2437 | 13.39 | 0.022 | 21.50 | 0.141 | < 30 |
| | 18 | 2437 | 13.37 | 0.022 | 21.48 | 0.141 | < 30 |
| | 24 | 2437 | 13.36 | 0.022 | 21.47 | 0.140 | < 30 |
| | 36 | 2437 | 13.40 | 0.022 | 21.45 | 0.140 | < 30 |
| | 48 | 2437 | 13.42 | 0.022 | 21.44 | 0.139 | < 30 |
| | 54 | 2437 | 13.44 | 0.022 | 21.40 | 0.138 | < 30 |

Note: The relevant measured result has the offset with cable loss already.



| Test Item | Maximum Conducted Output Power | | | | | | |
|-----------|--------------------------------|-----------------|----------------------|-------|---------------------|--------------|-------|
| Test Mode | Data Rate (Mbps) | Frequency (MHz) | Average Output Power | | Peak Output Power | | |
| | | | Measurement Results | | Measurement Results | | Limit |
| | | | dBm | W | dBm | W | dBm |
| Mode 4 | 6.5 | 2412 | 12.97 | 0.020 | 21.22 | 0.132 | < 30 |
| | | 2437 | 13.08 | 0.020 | 21.35 | 0.136 | < 30 |
| | | 2462 | 13.02 | 0.020 | 21.10 | 0.129 | < 30 |
| | 14.4 | 2437 | 13.07 | 0.020 | 21.31 | 0.135 | < 30 |
| | 21.7 | 2437 | 13.03 | 0.020 | 21.30 | 0.135 | < 30 |
| | 28.9 | 2437 | 13.02 | 0.020 | 21.28 | 0.134 | < 30 |
| | 43.3 | 2437 | 13.01 | 0.020 | 21.26 | 0.134 | < 30 |
| | 57.8 | 2437 | 12.99 | 0.020 | 21.25 | 0.133 | < 30 |
| | 65 | 2437 | 12.98 | 0.020 | 21.22 | 0.132 | < 30 |
| | 72.2 | 2437 | 12.96 | 0.020 | 21.19 | 0.132 | < 30 |

Note: The relevant measured result has the offset with cable loss already.

7 6dB RF Bandwidth Measurement

7.1. Limit

6dB RF Bandwidth: Systems using digital modulation techniques may operate in the 2400–2483.5 MHz bands. The minimum 6 dB band-width shall be at least 500 kHz.

7.2. Test Setup

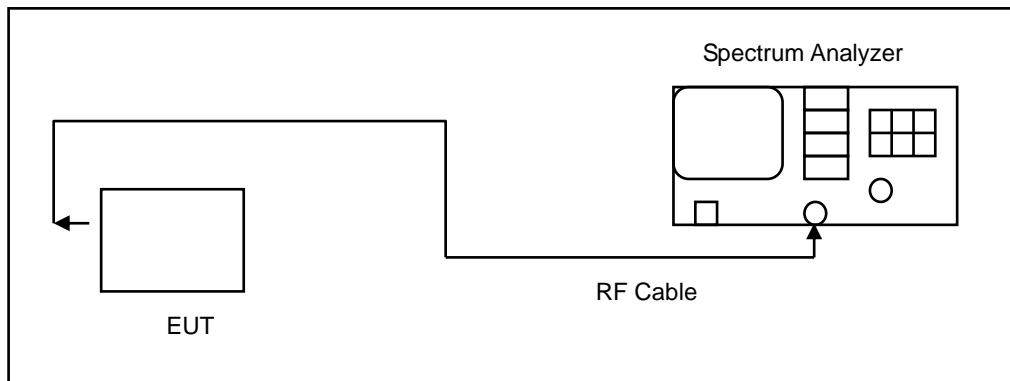

7.3. Test Instruments

| Equipment | Manufacturer | Model Number | Serial Number | Cal. Date | Cal. Period |
|-------------------|--------------|-------------------|---------------|------------|-------------|
| Spectrum Analyzer | Agilent | N9030A | MY53120541 | 12/22/2016 | 1 year |
| Microwave Cable | EMCI | EMC104-SM-SM-1500 | 140303 | 02/22/2017 | 1 year |
| Test Site | ATL | TE05 | TE05 | N.C.R. | ----- |

Note: N.C.R. = No Calibration Request.

7.4. Test Procedure

The EUT tested to DTS test procedure of KDB558074D01 for compliance to FCC 47CFR 15.247 requirements.

6dB RF Bandwidth: The antenna port of the EUT was connected to the input of a spectrum analyzer. Analyzer RBW was set to 100 kHz. For each RF output channel investigated, the spectrum analyzer center frequency was set to the channel carrier. A peak output reading was taken, a DISPLAY line was drawn 6 dB lower than peak level. The 6 dB bandwidth was determined from where the channel output spectrum intersected the display line.

The test was performed at 3 channels (Channel low, middle, high)



7.5. Test Result

| Test Item | 6dB RF Bandwidth | | | |
|-----------|------------------|-----------------|-------------------|-------------|
| Test Mode | Data Rate (Mbps) | Frequency (MHz) | Measurement (kHz) | Limit (kHz) |
| Mode 2 | 1 | 2412 | 8094 | > 500 |
| | | 2437 | 8088 | > 500 |
| | | 2462 | 8105 | > 500 |
| Mode 3 | 6 | 2412 | 15120 | > 500 |
| | | 2437 | 15120 | > 500 |
| | | 2462 | 15090 | > 500 |
| Mode 4 | 6.5 | 2412 | 15130 | > 500 |
| | | 2437 | 15050 | > 500 |
| | | 2462 | 15120 | > 500 |



7.6. Test Graphs

Mode 2: IEEE 802.11b Continuous TX mode

| | |
|-----------------|--|
| <p>2412 MHz</p> | <p>Agilent Spectrum Analyzer - Occupied BW</p> <p>Center Freq: 2.412000000 GHz Trig: Free Run #Atten: 20 dB</p> <p>Ref Offset 13.3 dB Ref 23.30 dBm</p> <p>Center 2.412 GHz #Res BW 100 kHz #VBW 300 kHz Span 30 MHz Sweep 2.933 ms</p> <p>Occupied Bandwidth 12.061 MHz Total Power 22.0 dBm Transmit Freq Error 21.647 kHz OBW Power 99.00 % x dB Bandwidth 8.094 MHz x dB -6.00 dB</p> |
| <p>2437 MHz</p> | <p>Agilent Spectrum Analyzer - Occupied BW</p> <p>Center Freq: 2.437000000 GHz Trig: Free Run #Atten: 20 dB</p> <p>Ref Offset 13.3 dB Ref 23.30 dBm</p> <p>Center 2.437 GHz #Res BW 100 kHz #VBW 300 kHz Span 30 MHz Sweep 2.933 ms</p> <p>Occupied Bandwidth 12.025 MHz Total Power 22.1 dBm Transmit Freq Error 11.861 kHz OBW Power 99.00 % x dB Bandwidth 8.088 MHz x dB -6.00 dB</p> |
| <p>2462 MHz</p> | <p>Agilent Spectrum Analyzer - Occupied BW</p> <p>Center Freq: 2.462000000 GHz Trig: Free Run #Atten: 20 dB</p> <p>Ref Offset 13.3 dB Ref 23.30 dBm</p> <p>Center 2.462 GHz #Res BW 100 kHz #VBW 300 kHz Span 30 MHz Sweep 2.933 ms</p> <p>Occupied Bandwidth 12.030 MHz Total Power 21.9 dBm Transmit Freq Error 11.655 kHz OBW Power 99.00 % x dB Bandwidth 8.105 MHz x dB -6.00 dB</p> |



Mode 3: IEEE 802.11g Continuous TX mode

2412 MHz

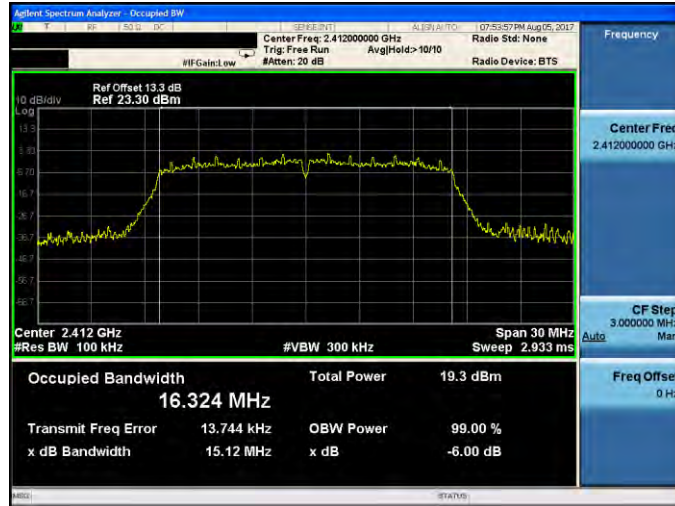

2437 MHz

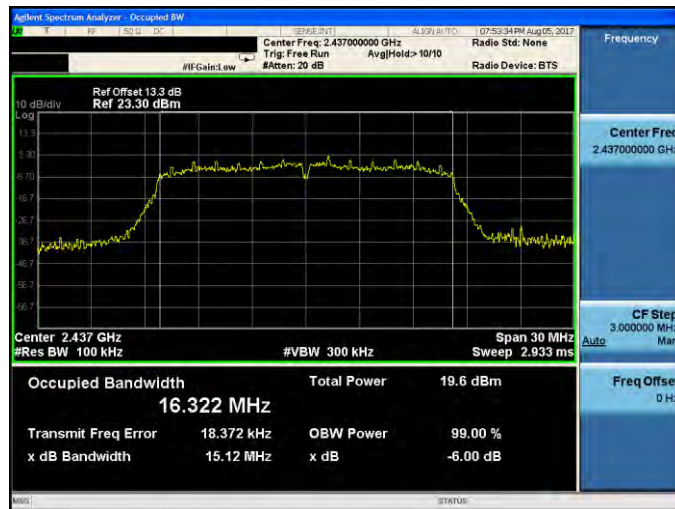

2462 MHz

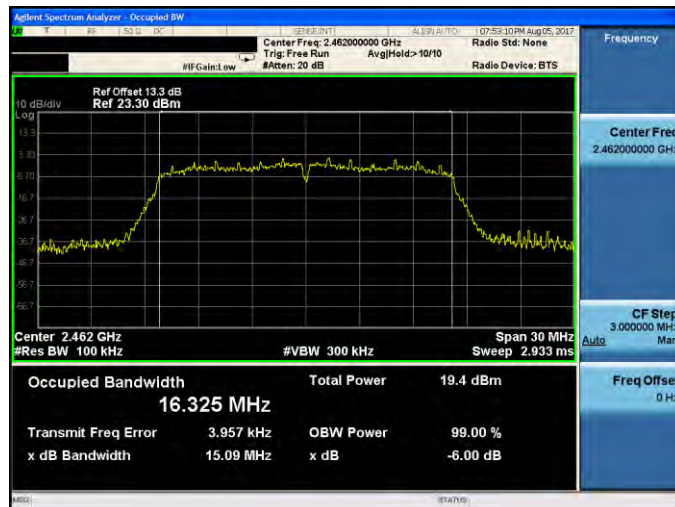



Mode 4: IEEE 802.11n 2.4GHz 20MHz Continuous TX mode

| | |
|-----------------|--|
| <p>2412 MHz</p> | <p>Agilent Spectrum Analyzer - Occupied BW</p> <p>Center Freq: 2.412000000 GHz Trig: Free Run #IF Gain: Low #Atten: 20 dB Avg Hold: > 10/10 Radio Std: None Radio Device: BTS</p> <p>Ref Offset 13.3 dB Ref 23.30 dBm</p> <p>Center 2.412 GHz #Res BW 100 kHz #VBW 300 kHz Span 30 MHz Sweep 2.933 ms</p> <p>Occupied Bandwidth 17.490 MHz Total Power 19.7 dBm Transmit Freq Error 13.597 kHz x dB Bandwidth 15.13 MHz OBW Power 99.00 % x dB -6.00 dB</p> <p>Center Freq 2.412000000 GHz CF Step 3.000000 MHz Freq Offset 0 Hz</p> |
| <p>2437 MHz</p> | <p>Agilent Spectrum Analyzer - Occupied BW</p> <p>Center Freq: 2.437000000 GHz Trig: Free Run #IF Gain: Low #Atten: 20 dB Avg Hold: > 10/10 Radio Std: None Radio Device: BTS</p> <p>Ref Offset 13.3 dB Ref 23.30 dBm</p> <p>Center 2.437 GHz #Res BW 100 kHz #VBW 300 kHz Span 30 MHz Sweep 2.933 ms</p> <p>Occupied Bandwidth 17.488 MHz Total Power 19.5 dBm Transmit Freq Error 13.595 kHz x dB Bandwidth 15.05 MHz OBW Power 99.00 % x dB -6.00 dB</p> <p>Center Freq 2.437000000 GHz CF Step 3.000000 MHz Freq Offset 0 Hz</p> |
| <p>2462 MHz</p> | <p>Agilent Spectrum Analyzer - Occupied BW</p> <p>Center Freq: 2.462000000 GHz Trig: Free Run #IF Gain: Low #Atten: 20 dB Avg Hold: > 10/10 Radio Std: None Radio Device: BTS</p> <p>Ref Offset 13.3 dB Ref 23.30 dBm</p> <p>Center 2.462 GHz #Res BW 100 kHz #VBW 300 kHz Span 30 MHz Sweep 2.933 ms</p> <p>Occupied Bandwidth 17.495 MHz Total Power 19.4 dBm Transmit Freq Error 1.528 kHz x dB Bandwidth 15.12 MHz OBW Power 99.00 % x dB -6.00 dB</p> <p>Center Freq 2.462000000 GHz CF Step 3.000000 MHz Freq Offset 0 Hz</p> |

8 Maximum Power Density Measurement

8.1. Limit

For digitally modulated systems, the power spectral density conducted from the intentional radiator to the antenna shall not be greater than 8 dBm in any 3 kHz band during any time interval of continuous transmission.

* SISO mode : Max. Gain = 2.97 dBi < 6 dBi.

8.2. Test Setup

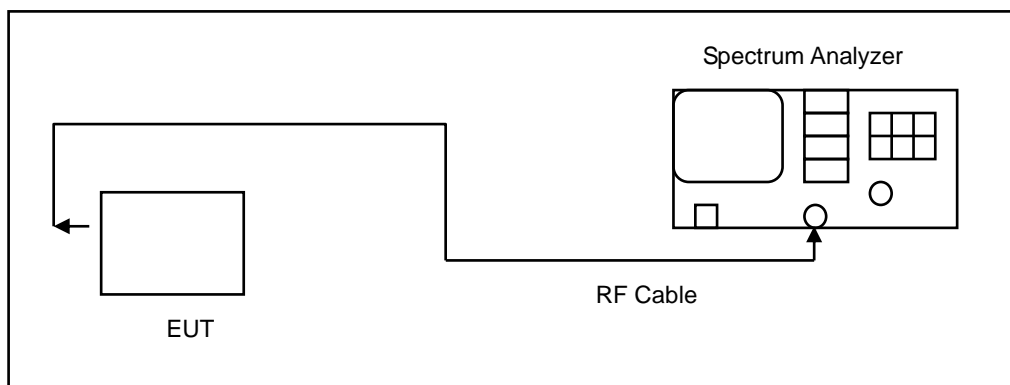

8.3. Test Instruments

| Equipment | Manufacturer | Model Number | Serial Number | Cal. Date | Cal. Period |
|-------------------|--------------|-------------------|---------------|------------|-------------|
| Spectrum Analyzer | Agilent | N9030A | MY53120541 | 12/22/2016 | 1 year |
| Microwave Cable | EMCI | EMC104-SM-SM-1500 | 140303 | 02/22/2017 | 1 year |
| Test Site | ATL | TE05 | TE05 | N.C.R. | ----- |

Note: N.C.R. = No Calibration Request.

8.4. Test Procedure

The EUT tested to DTS test procedure of KDB558074D01 section 10.2 Method PKPSD for compliance to FCC 47CFR 15.247 requirements.

1. Set analyzer center frequency to DTS channel center frequency.
2. Set the span to 1.5 times the DTS bandwidth.
3. Set the RBW to: $3 \text{ kHz} \leq \text{RBW} \leq 100 \text{ kHz}$.
4. Set the VBW $\geq 3 \times \text{RBW}$.
5. Detector = peak.
6. Sweep time = auto couple.
7. Trace mode = max hold.
8. Allow trace to fully stabilize.
9. Use the peak marker function to determine the maximum amplitude level within the RBW.
10. If measured value exceeds limit, reduce RBW (no less than 3 kHz) and repeat.



8.5. Test Result

| Test Item | Maximum Power Density | | | |
|-----------|-----------------------|-----------------|------------------------|------------------|
| Test Mode | Data Rate (Mbps) | Frequency (MHz) | Measurement (dBm/3KHz) | Limit (dBm/3KHz) |
| Mode 2 | 1 | 2412 | -6.812 | < 8 |
| | | 2437 | -4.775 | < 8 |
| | | 2462 | -7.005 | < 8 |
| Mode 3 | 6 | 2412 | -11.975 | < 8 |
| | | 2437 | -11.650 | < 8 |
| | | 2462 | -12.291 | < 8 |
| Mode 4 | 6.5 | 2412 | -11.604 | < 8 |
| | | 2437 | -12.081 | < 8 |
| | | 2462 | -11.509 | < 8 |

8.6. Test Graphs

Mode 2: IEEE 802.11b Continuous TX mode

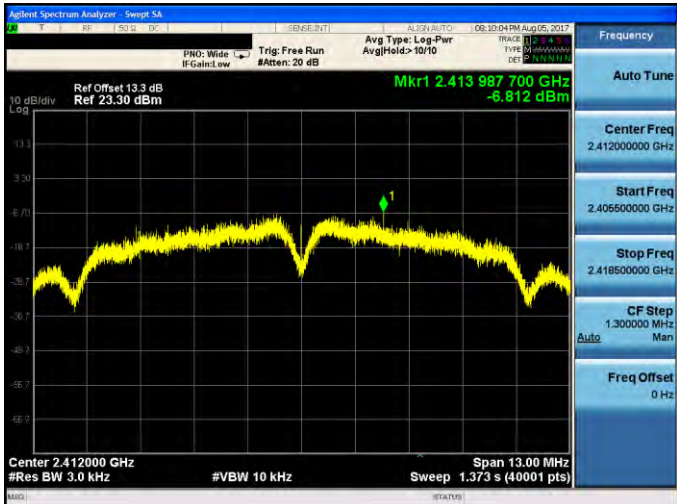
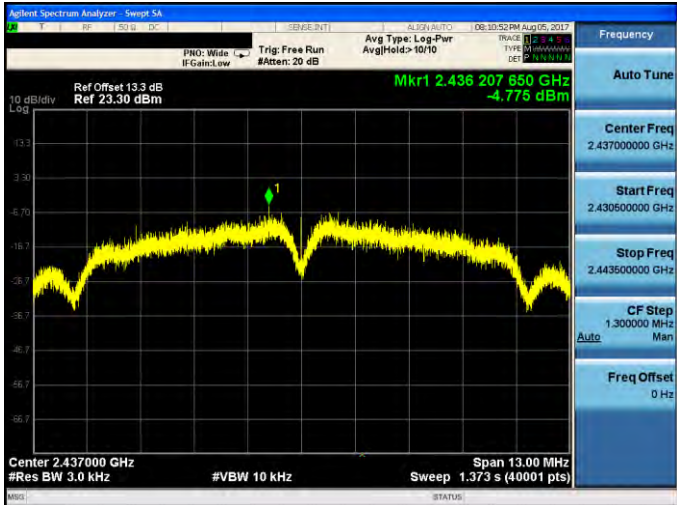
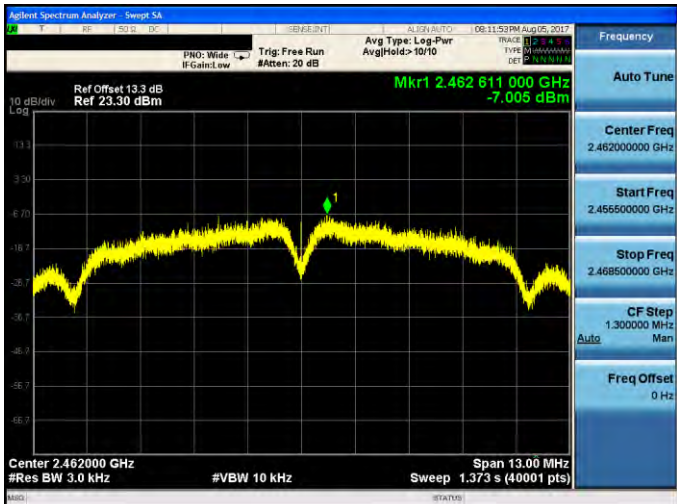
| | |
|-----------------|--|
| <p>2412 MHz</p> |  <p>Agilent Spectrum Analyzer - Sweep SA</p> <p>Ref Offset: 13.3 dB Ref: 23.30 dBm</p> <p>Mkr1 2.413 987 700 GHz -6.812 dBm</p> <p>Center 2.412000 GHz #Res BW 3.0 kHz #VBW 10 kHz Sweep 1.373 s (40001 pts)</p> <p>Frequency: Auto Tune Center Freq: 2.412000000 GHz Start Freq: 2.406500000 GHz Stop Freq: 2.418500000 GHz CF Step: 1.300000 MHz Freq Offset: 0 Hz</p> |
| <p>2437 MHz</p> |  <p>Agilent Spectrum Analyzer - Sweep SA</p> <p>Ref Offset: 13.3 dB Ref: 23.30 dBm</p> <p>Mkr1 2.436 207 850 GHz -4.775 dBm</p> <p>Center 2.437000 GHz #Res BW 3.0 kHz #VBW 10 kHz Sweep 1.373 s (40001 pts)</p> <p>Frequency: Auto Tune Center Freq: 2.437000000 GHz Start Freq: 2.430500000 GHz Stop Freq: 2.443500000 GHz CF Step: 1.300000 MHz Freq Offset: 0 Hz</p> |
| <p>2462 MHz</p> |  <p>Agilent Spectrum Analyzer - Sweep SA</p> <p>Ref Offset: 13.3 dB Ref: 23.30 dBm</p> <p>Mkr1 2.462 611 000 GHz -7.005 dBm</p> <p>Center 2.462000 GHz #Res BW 3.0 kHz #VBW 10 kHz Sweep 1.373 s (40001 pts)</p> <p>Frequency: Auto Tune Center Freq: 2.462000000 GHz Start Freq: 2.456500000 GHz Stop Freq: 2.468500000 GHz CF Step: 1.300000 MHz Freq Offset: 0 Hz</p> |



Mode 3: IEEE 802.11g Continuous TX mode

2412 MHz

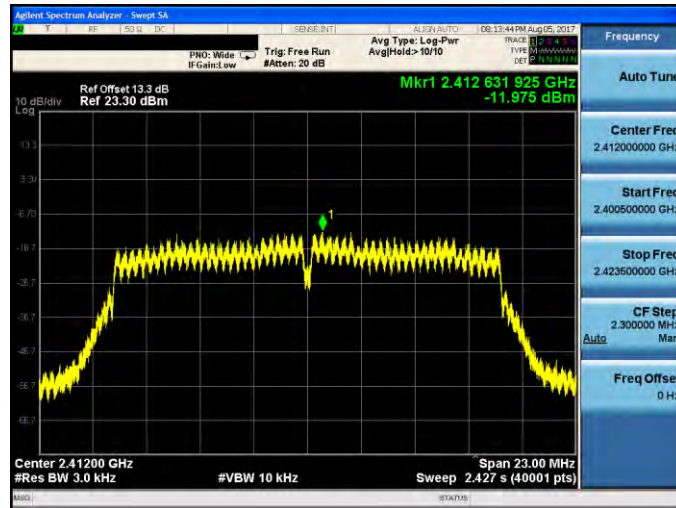

2437 MHz

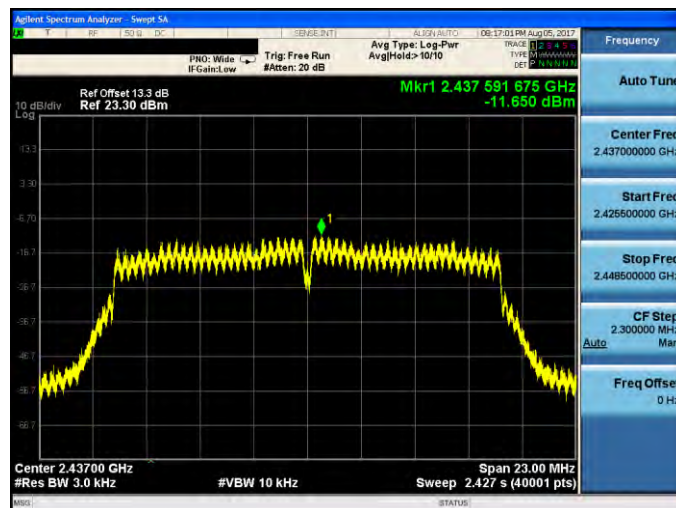

2462 MHz

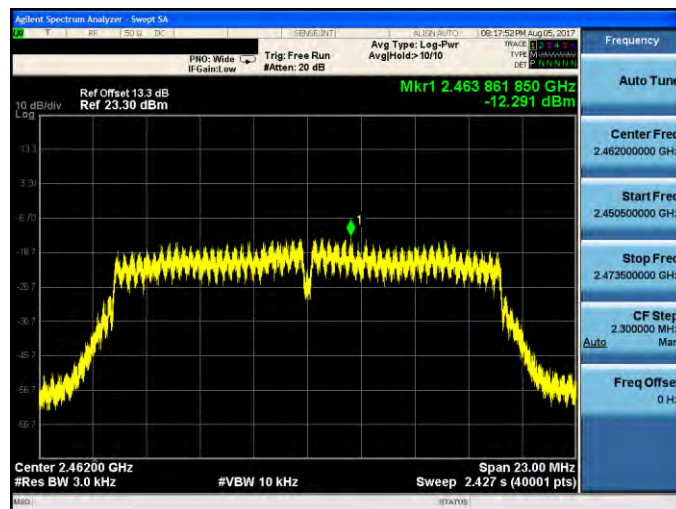



Mode 4: IEEE 802.11n 2.4GHz 20MHz Continuous TX mode

2412 MHz

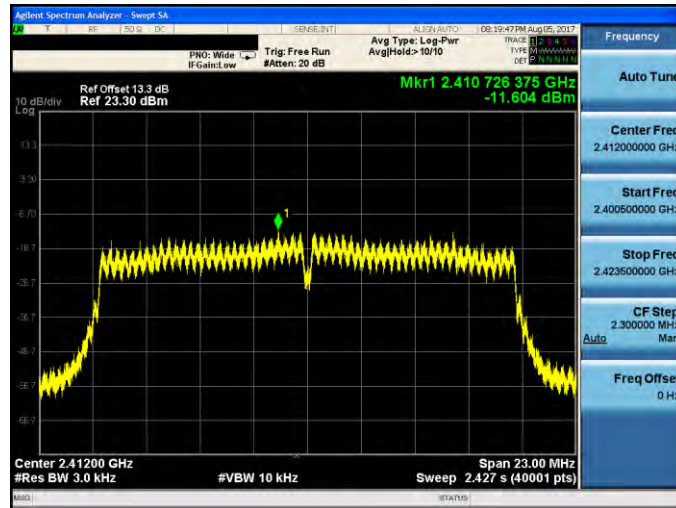

2437 MHz

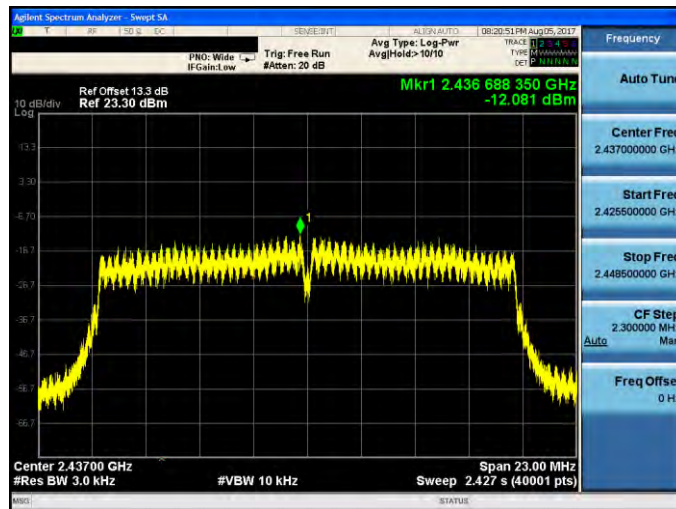

2462 MHz

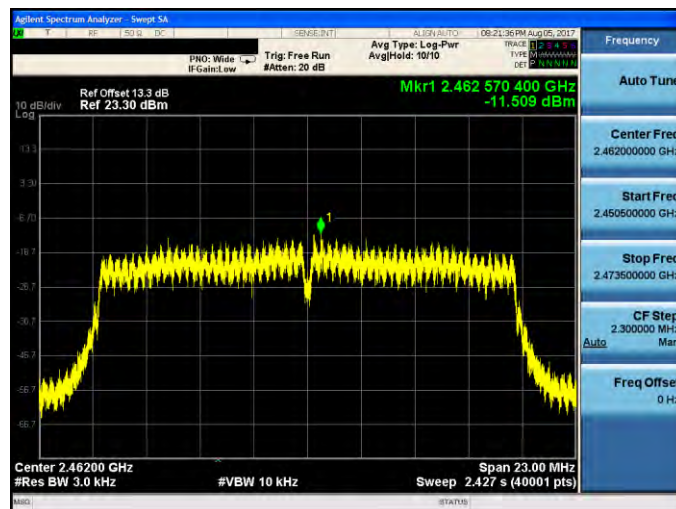

9 Out of Band Conducted Emissions Measurement

9.1. Limit

In any 100 kHz bandwidth outside the frequency band in which the spread spectrum or digitally modulated intentional radiator is operating, the radio frequency power that is produced by the intentional radiator shall be at least 20 dB below that in the 100 kHz bandwidth within the band that contains the highest level of the desired power

9.2. Test Setup

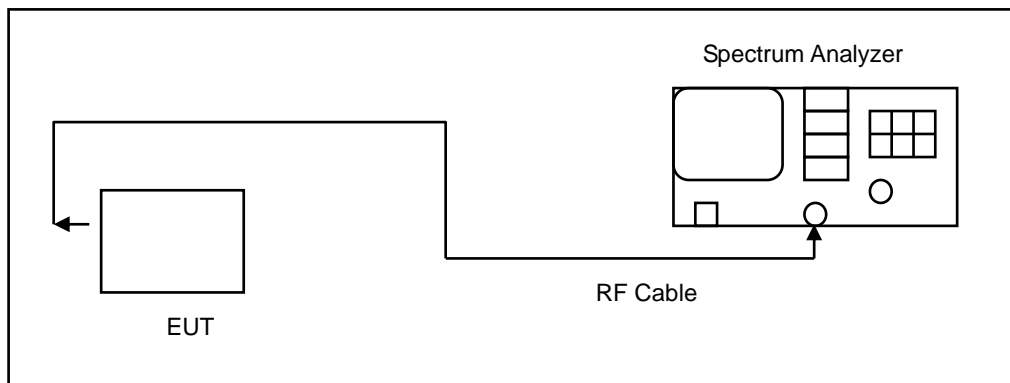

9.3. Test Instruments

| Equipment | Manufacturer | Model Number | Serial Number | Cal. Date | Cal. Period |
|-------------------|--------------|-------------------|---------------|------------|-------------|
| Spectrum Analyzer | Agilent | N9030A | MY53120541 | 12/22/2016 | 1 year |
| Microwave Cable | EMCI | EMC104-SM-SM-1500 | 140303 | 02/22/2017 | 1 year |
| Test Site | ATL | TE05 | TE05 | N.C.R. | ----- |

Note: N.C.R. = No Calibration Request.

9.4. Test Procedure

In any 100 kHz bandwidth outside the EUT pass band, the RF power produced by the modulation products of the spreading sequence, the information sequence, and the carrier frequency shall be at least 20 dB below that of the maximum in-band 100 kHz emission, antenna output of the EUT was coupled directly to spectrum analyzer; if an external attenuator and/or cable was used, these losses are compensated for with the analyzer OFFSET function.



All other types of emissions from the EUT shall meet the general limits for radiated frequencies outside the pass band. The test was performed at 3 channels.



9.5. Test Graphs

Reference level

Mode 2: IEEE 802.11b Continuous TX mode

| | |
|----------|--|
| 2412 MHz |  |
| 2437 MHz |  |
| 2462 MHz |  |



Mode 3: IEEE 802.11g Continuous TX mode

2412 MHz



2437 MHz

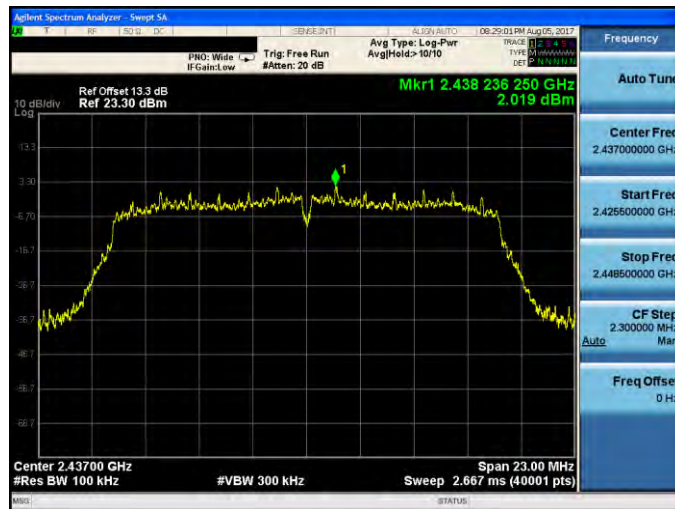

2462 MHz





Mode 4: IEEE 802.11n 2.4GHz 20MHz Continuous TX mode

2412 MHz



2437 MHz

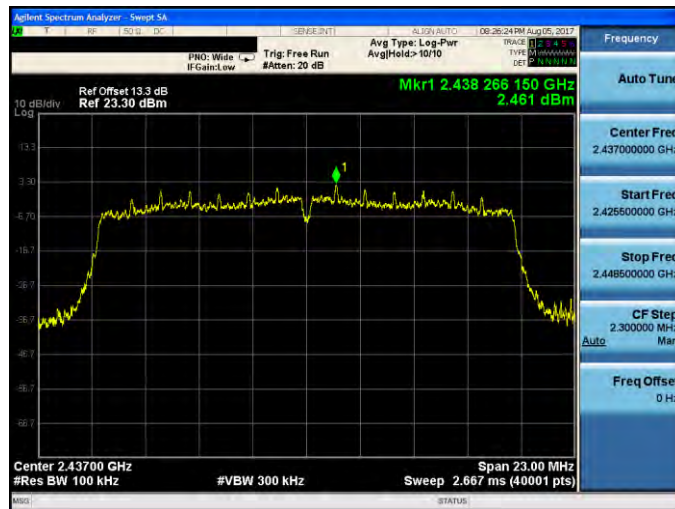

2462 MHz





Out of Band Conducted Emissions

Mode 2: IEEE 802.11b Continuous TX mode

| <p>2412 MHz</p> | <p>Agilent Spectrum Analyzer - Sweep SA</p> <p>Ref Offset 13.3 dB Ref 23.30 dBm</p> <p>Mkr1 2.412 0 GHz 4.219 dBm</p> <p>Start 30 MHz #Res BW 100 kHz #VBW 300 kHz Sweep 2.531 s (40001 pts) Stop 26.50 GHz</p> <table border="1"> <thead> <tr> <th>MFR</th> <th>MODE</th> <th>TRC</th> <th>SOL</th> <th>X</th> <th>Y</th> <th>FUNCTION</th> <th>FUNCTION WIDTH</th> <th>FUNCTION VALUE</th> </tr> </thead> <tbody> <tr> <td>1</td> <td>N</td> <td>1</td> <td>f</td> <td>2.412 0 GHz</td> <td>4.219 dBm</td> <td></td> <td></td> <td></td> </tr> </tbody> </table> <p>Frequency</p> <p>Auto Tune</p> <p>Center Freq 13.265000000 GHz</p> <p>Start Freq 30.000000 MHz</p> <p>Stop Freq 26.500000000 GHz</p> <p>CF Step 2.647000000 GHz Auto Man</p> <p>Freq Offset 0 Hz</p> | MFR | MODE | TRC | SOL | X | Y | FUNCTION | FUNCTION WIDTH | FUNCTION VALUE | 1 | N | 1 | f | 2.412 0 GHz | 4.219 dBm | | | |
|-----------------|--|-----|------|-------------|-----------|----------|----------------|----------------|----------------|----------------|---|---|---|---|-------------|-----------|--|--|--|
| MFR | MODE | TRC | SOL | X | Y | FUNCTION | FUNCTION WIDTH | FUNCTION VALUE | | | | | | | | | | | |
| 1 | N | 1 | f | 2.412 0 GHz | 4.219 dBm | | | | | | | | | | | | | | |
| <p>2437 MHz</p> | <p>Agilent Spectrum Analyzer - Sweep SA</p> <p>Ref Offset 13.3 dB Ref 23.30 dBm</p> <p>Mkr1 2.437 0 GHz 6.530 dBm</p> <p>Start 30 MHz #Res BW 100 kHz #VBW 300 kHz Sweep 2.531 s (40001 pts) Stop 26.50 GHz</p> <table border="1"> <thead> <tr> <th>MFR</th> <th>MODE</th> <th>TRC</th> <th>SOL</th> <th>X</th> <th>Y</th> <th>FUNCTION</th> <th>FUNCTION WIDTH</th> <th>FUNCTION VALUE</th> </tr> </thead> <tbody> <tr> <td>1</td> <td>N</td> <td>1</td> <td>f</td> <td>2.437 0 GHz</td> <td>6.530 dBm</td> <td></td> <td></td> <td></td> </tr> </tbody> </table> <p>Frequency</p> <p>Auto Tune</p> <p>Center Freq 13.265000000 GHz</p> <p>Start Freq 30.000000 MHz</p> <p>Stop Freq 26.500000000 GHz</p> <p>CF Step 2.647000000 GHz Auto Man</p> <p>Freq Offset 0 Hz</p> | MFR | MODE | TRC | SOL | X | Y | FUNCTION | FUNCTION WIDTH | FUNCTION VALUE | 1 | N | 1 | f | 2.437 0 GHz | 6.530 dBm | | | |
| MFR | MODE | TRC | SOL | X | Y | FUNCTION | FUNCTION WIDTH | FUNCTION VALUE | | | | | | | | | | | |
| 1 | N | 1 | f | 2.437 0 GHz | 6.530 dBm | | | | | | | | | | | | | | |
| <p>2462 MHz</p> | <p>Agilent Spectrum Analyzer - Sweep SA</p> <p>Ref Offset 13.3 dB Ref 23.30 dBm</p> <p>Mkr1 2.462 0 GHz 5.366 dBm</p> <p>Start 30 MHz #Res BW 100 kHz #VBW 300 kHz Sweep 2.531 s (40001 pts) Stop 26.50 GHz</p> <table border="1"> <thead> <tr> <th>MFR</th> <th>MODE</th> <th>TRC</th> <th>SOL</th> <th>X</th> <th>Y</th> <th>FUNCTION</th> <th>FUNCTION WIDTH</th> <th>FUNCTION VALUE</th> </tr> </thead> <tbody> <tr> <td>1</td> <td>N</td> <td>1</td> <td>f</td> <td>2.462 0 GHz</td> <td>5.366 dBm</td> <td></td> <td></td> <td></td> </tr> </tbody> </table> <p>Frequency</p> <p>Auto Tune</p> <p>Center Freq 13.265000000 GHz</p> <p>Start Freq 30.000000 MHz</p> <p>Stop Freq 26.500000000 GHz</p> <p>CF Step 2.647000000 GHz Auto Man</p> <p>Freq Offset 0 Hz</p> | MFR | MODE | TRC | SOL | X | Y | FUNCTION | FUNCTION WIDTH | FUNCTION VALUE | 1 | N | 1 | f | 2.462 0 GHz | 5.366 dBm | | | |
| MFR | MODE | TRC | SOL | X | Y | FUNCTION | FUNCTION WIDTH | FUNCTION VALUE | | | | | | | | | | | |
| 1 | N | 1 | f | 2.462 0 GHz | 5.366 dBm | | | | | | | | | | | | | | |



Mode 3: IEEE 802.11g Continuous TX mode

2412 MHz

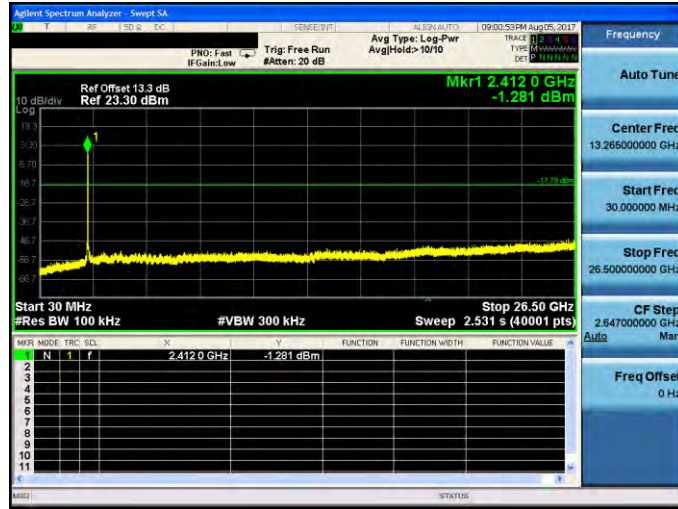

2437 MHz

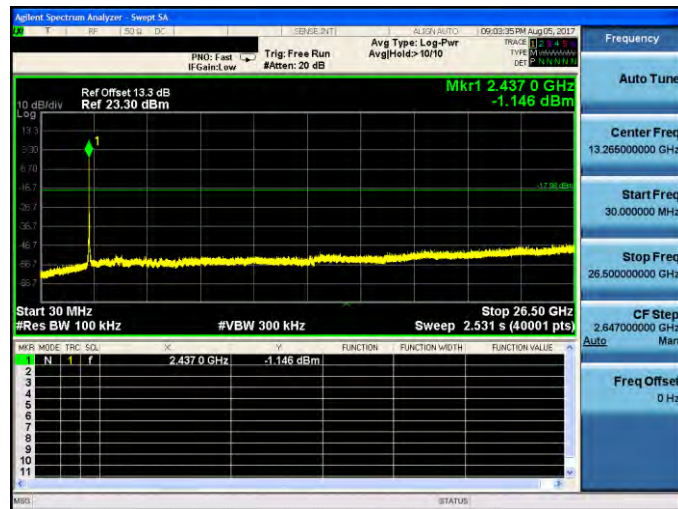

2462 MHz

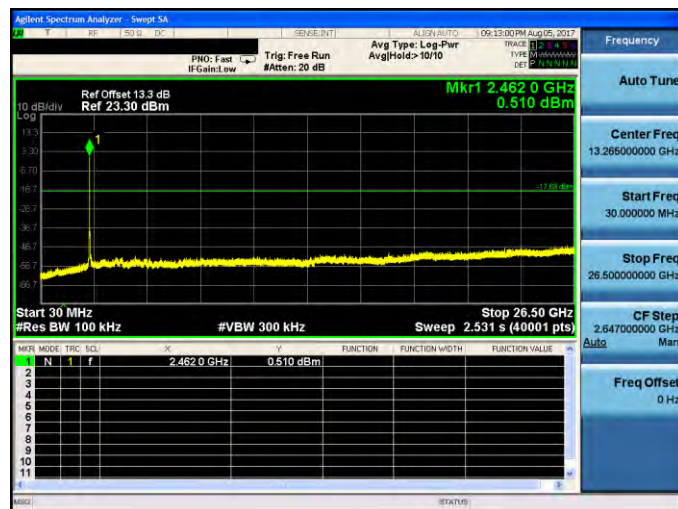



Mode 4: IEEE 802.11n 2.4GHz 20MHz Continuous TX mode

2412 MHz

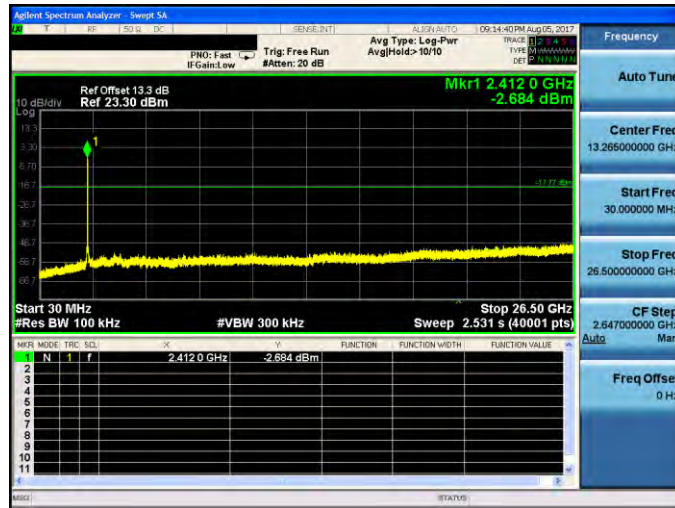

2437 MHz

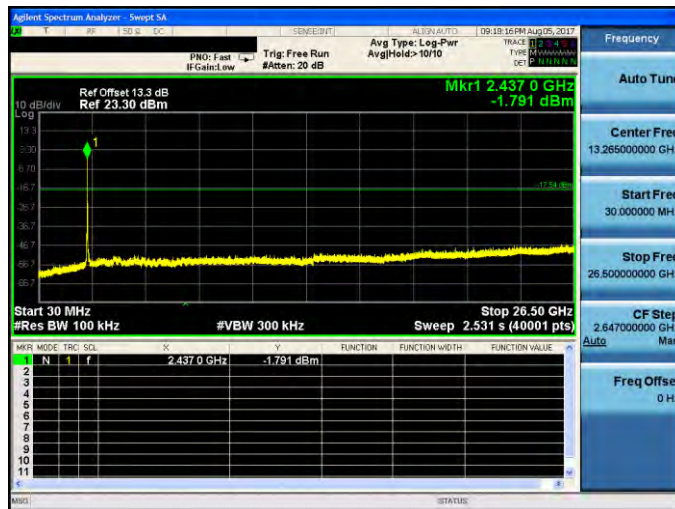

2462 MHz

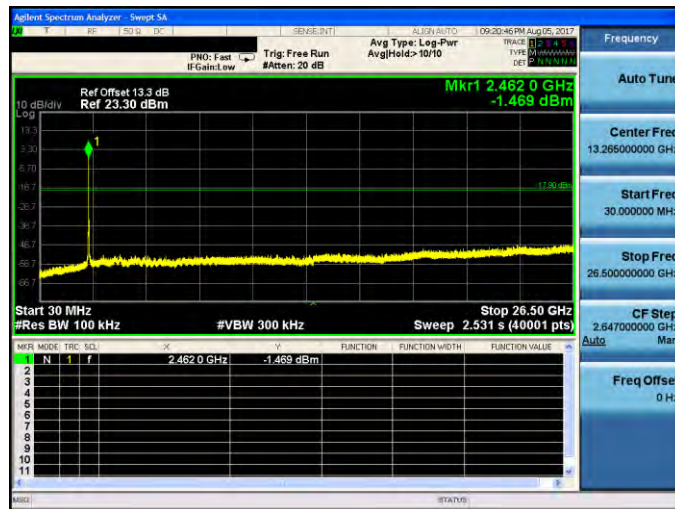



Conducted Band Edge

Mode 2: IEEE 802.11b Continuous TX mode

2412 MHz

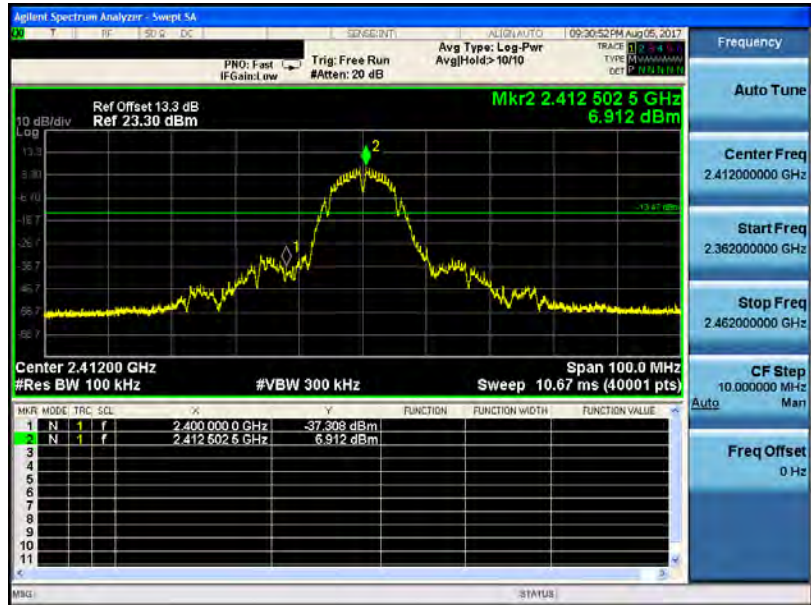

2462 MHz

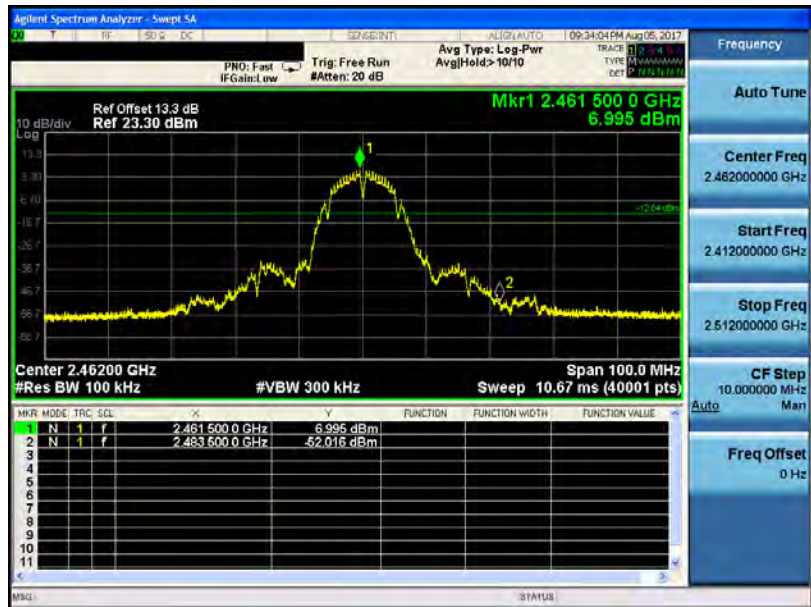



Mode 3: IEEE 802.11g Continuous TX mode

2412 MHz

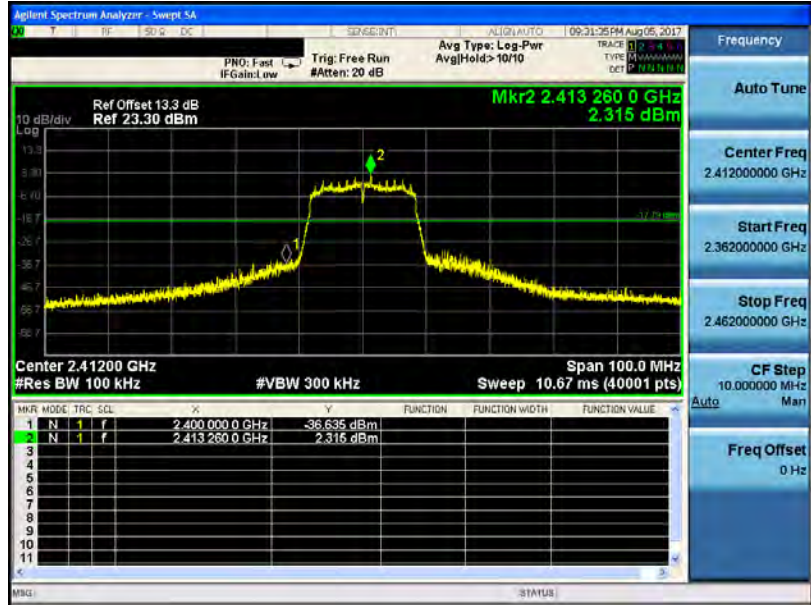

2462 MHz

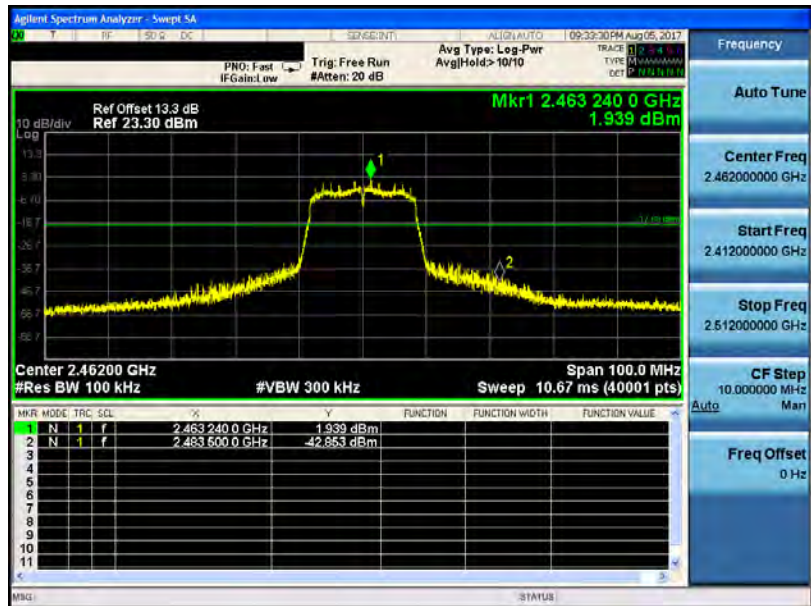

Mode 4: IEEE 802.11n 2.4GHz 20MHz Continuous TX mode

2412 MHz

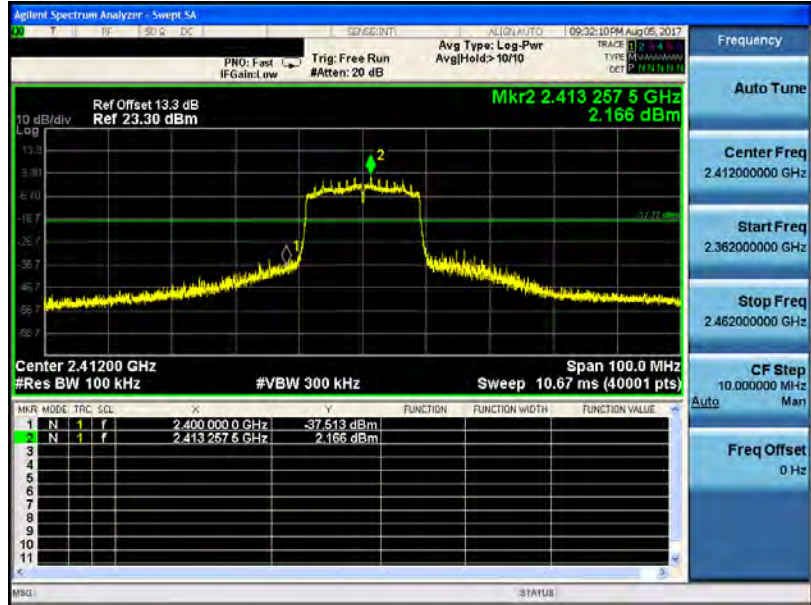

2462 MHz

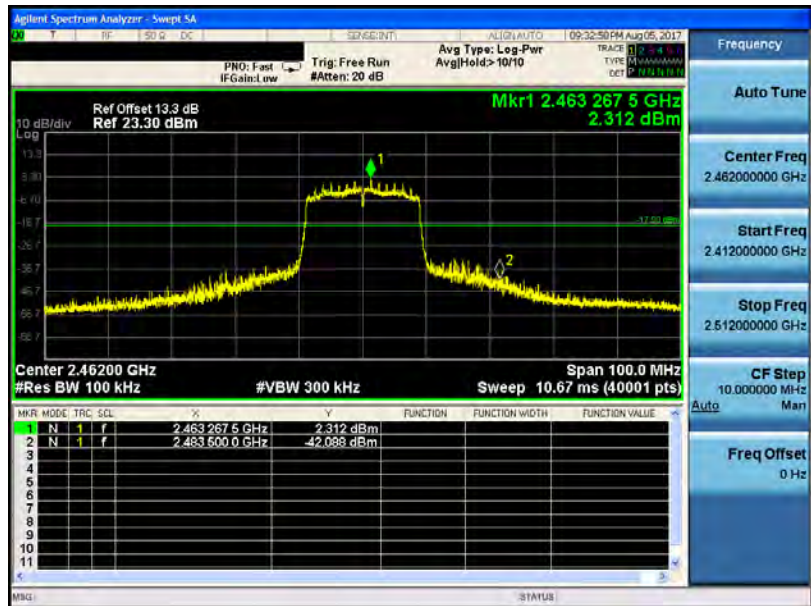



10 Antenna Measurement

10.1.Limit

For intentional device, according to 15.203, an intentional radiator shall be designed to ensure that no antenna other than that furnished by the responsible party shall be used with the device.

And According to 15.247 (b), if transmitting antennas of directional gain greater than 6 dBi are used, the power shall be reduced by the amount in dB that the directional gain of the antenna exceeds 6dBi.

10.2.Antenna Description

See section 2 – antenna information.