

<b>Prüfbericht-Nr.:</b> <i>Test report no.:</i>	CN22D1N5 (P15C-IEEE802.15.4) 001	<b>Auftrags-Nr.:</b> <i>Order no.:</i>	238522049	Seite 1 von 27 Page 1 of 27	
<b>Kunden-Referenz-Nr.:</b> <i>Client reference no.:</i>	N/A	<b>Auftragsdatum:</b> <i>Order date:</i>	2021-11-12		
<b>Auftraggeber:</b> <i>Client:</i>	TAIYO YUDEN CO., LTD. 43-1, Yawatabara-machi, Takasaki-shi, Gumma, Japan				
<b>Prüfgegenstand:</b> <i>Test item:</i>	Bluetooth low energy/ANT/802.15.4 Module				
<b>Bezeichnung / Typ-Nr.:</b> <i>Identification / Type no.:</i>	EYSRSN				
<b>Auftrags-Inhalt:</b> <i>Order content:</i>	FCC Part 15C Test report (IEEE802.15.4)				
<b>Prüfgrundlage:</b> <i>Test specification:</i>	FCC 47CFR Part 15: Subpart C Section 15.247				
<b>Wareneingangsdatum:</b> <i>Date of sample receipt:</i>	2021-11-11				
<b>Prüfmuster-Nr.:</b> <i>Test sample no.:</i>	A003162507-001 A003162507-003				
<b>Prüfzeitraum:</b> <i>Testing period:</i>	2021-12-25 - 2022-02-17				
<b>Ort der Prüfung:</b> <i>Place of testing:</i>	EMC/RF Taipei Testing Site				
<b>Prüflaboratorium:</b> <i>Testing laboratory:</i>	Taipei Testing Laboratories				
<b>Prüfergebnis*:</b> <i>Test result*:</i>	Pass				
<b>überprüft von:</b> <i>compiled by:</i>	<b>genehmigt von:</b> <i>authorized by:</i>				
<b>Datum:</b> <i>Date:</i> 2022-02-22	 Jack Wang	<b>Ausstellungsdatum:</b> <i>Issue date:</i> 2022-02-22	 Brenda Chen		
<b>Stellung / Position:</b>	Senior Project Engineer	<b>Stellung / Position:</b>	Senior Project Manager		
<b>Sonstiges / Other:</b>					
<b>Zustand des Prüfgegenstandes bei Anlieferung:</b> <i>Condition of the test item at delivery:</i>		Prüfmuster vollständig und unbeschädigt <i>Test item complete and undamaged</i>			
* Legende:	1 = sehr gut P(ass) = entspricht o.g. Prüfgrundlage(n)	2 = gut F(ail) = entspricht nicht o.g. Prüfgrundlage(n)	3 = befriedigend F(ail) = entspricht nicht o.g. Prüfgrundlage(n)	4 = ausreichend N/A = nicht anwendbar	5 = mangelhaft N/T = nicht getestet
* Legend:	1 = very good P(ass) = passed a.m. test specification(s)	2 = good F(ail) = failed a.m. test specification(s)	3 = satisfactory F(ail) = failed a.m. test specification(s)	4 = sufficient N/A = not applicable	5 = poor N/T = not tested
<p><b>Dieser Prüfbericht bezieht sich nur auf das o.g. Prüfmuster und darf ohne Genehmigung der Prüfstelle nicht auszugsweise vervielfältigt werden. Dieser Bericht berechtigt nicht zur Verwendung eines Prüfzeichens.</b>  <i>This test report only relates to the a. m. test sample. Without permission of the test center this test report is not permitted to be duplicated in extracts. This test report does not entitle to carry any test mark.</i></p>					

## TEST SUMMARY

Report Section	FCC Clause	Test Item	Result
5.1.1	15.247(b) & 15.203	Antenna Requirement	Pass
5.1.2	15.247(b)(3)	Peak Output Power	Pass
5.1.3	15.247(a)(2)	6 dB Bandwidth	Pass
5.1.3	2.1049	99% Occupied Bandwidth	Pass
5.1.4	15.247(e)	Power Spectral Density	Pass
5.1.5	15.247(d)	Conducted Spurious Emissions and Band Edges	Pass
5.1.6	15.247(d) & 15.205 & 15.209	Radiated Spurious Emissions and Band Edges	Pass
5.2.1	15.207	Mains Conducted Emission	Pass

**Note:** Determining compliance based on the results of the compliance measurement, not taking into account measurement instrumentation uncertainty.

## Contents

<b>HISTORY OF THIS TEST REPORT .....</b>	<b>5</b>
<b>1. GENERAL REMARKS .....</b>	<b>6</b>
<b>1.1 COMPLEMENTARY MATERIALS.....</b>	<b>6</b>
<b>1.2 DECISION RULE OF CONFORMITY .....</b>	<b>6</b>
<b>2. TEST SITES .....</b>	<b>7</b>
<b>2.1 TEST LABORATORY .....</b>	<b>7</b>
<b>2.2 TEST FACILITY.....</b>	<b>7</b>
<b>2.3 TRACEABILITY .....</b>	<b>8</b>
<b>2.4 CALIBRATION .....</b>	<b>8</b>
<b>2.5 MEASUREMENT UNCERTAINTY .....</b>	<b>8</b>
<b>3. GENERAL PRODUCT INFORMATION.....</b>	<b>9</b>
<b>3.1 PRODUCT FUNCTION AND INTENDED USE .....</b>	<b>9</b>
<b>3.2 SYSTEM DETAILS AND RATINGS.....</b>	<b>9</b>
<b>3.3 NOISE GENERATING AND NOISE SUPPRESSING PARTS .....</b>	<b>10</b>
<b>3.4 SUBMITTED DOCUMENTS.....</b>	<b>10</b>
<b>4. TEST SET-UP AND OPERATION MODES.....</b>	<b>11</b>
<b>4.1 PRINCIPLE OF CONFIGURATION SELECTION .....</b>	<b>11</b>
<b>4.2 CARRIER FREQUENCY AND CHANNEL.....</b>	<b>11</b>
<b>4.3 TEST OPERATION AND TEST SOFTWARE.....</b>	<b>12</b>
<b>4.4 SPECIAL ACCESSORIES AND AUXILIARY EQUIPMENT .....</b>	<b>13</b>
<b>4.5 TEST SETUP DIAGRAM .....</b>	<b>14</b>
<b>5. TEST RESULTS .....</b>	<b>15</b>
<b>5.1 TRANSMITTER REQUIREMENT &amp; TEST SUITES .....</b>	<b>15</b>
5.1.1 <i>Antenna Requirement .....</i>	<i>15</i>
5.1.2 <i>Peak Output Power .....</i>	<i>16</i>
5.1.3 <i>6 dB Bandwidth and 99% Occupied Bandwidth.....</i>	<i>18</i>
5.1.4 <i>Power Spectral Density.....</i>	<i>19</i>
5.1.5 <i>Conducted Spurious Emissions and Frequency Band Edges Measured in 100kHz Bandwidth.....</i>	<i>20</i>
5.1.6 <i>Radiated Spurious Emissions and Band Edges .....</i>	<i>21</i>
<b>5.2 MAINS EMISSION .....</b>	<b>26</b>
5.2.1 <i>Mains Conducted Emission.....</i>	<i>26</i>

**Prüfbericht - Nr.: CN22D1N5 (P15C-IEEE802.15.4) 001**  
*Test Report No.*

**Seite 4 von 27**  
*Page 4 of 27*

**APPENDIX A - TEST RESULT OF CONDUCTED**

**APPENDIX B - TEST RESULT OF RADIATED EMISSIONS & MAINS CONDUCTED EMISSION**

**APPENDIX SP - PHOTOGRAPHS OF TEST SETUP**

**APPENDIX EP - PHOTOGRAPHS OF EUT**

## HISTORY OF THIS TEST REPORT

Revision	Description	Date Issued
R00	Original Release	2022-01-20
R01	Update test data from 2475 MHz to 2480 MHz	2022-02-22

## 1. General Remarks

### 1.1 Complementary Materials

All attachments are integral parts of this test report. This applies especially to the following appendix:

**Appendix A - Test Result of Conducted**

**Appendix B - Test Result of Radiated Emissions & Mains Conducted Emission**

**Appendix SP - Photographs of Test Setup**

**Appendix EP - Photographs of EUT**

### Applied Standard and Test Levels

Radio
FCC 47CFR Part 15: Subpart C Section 15.247
FCC 47CFR Part 2: Subpart J Section 2.1049
ANSI C63.10:2013
KDB 558074 D01 15.247 Meas Guidance v05r02

### 1.2 Decision Rule of Conformity

The decision rule of conformity of this test report is following the requirements of the requested standard in the quotation, and agreed among testing laboratory and manufacturer (applicant) to exclude the consideration of Measurement Uncertainty, unless it is required by the specific standard.

## 2. Test Sites

### 2.1 Test Laboratory

Taipei Testing Laboratories

11F. No.758, Sec. 4, Bade Rd., Songshan Dist.  
Taipei City 105  
Taiwan (R.O.C.)

### 2.2 Test Facility

Taipei Testing Laboratories

No.458-18, Sec. 2, Fenliao Rd., Linkou Dist.,  
New Taipei City 244  
Taiwan (R.O.C.)  
FCC Registration No.: 226631  
ISED Registration No.: 25563

## 2.3 Traceability

All measurement equipment calibrations are traceable to NML(Taiwan)/NIST(USA) or where calibration is performed outside Taiwan, to equivalent nationally recognized standards organizations.

## 2.4 Calibration

Equipment requiring calibration is calibrated periodically in a suitably accredited Calibration Lab. Additionally all equipment is verified for proper performance on a regular basis using in house standards or comparisons.

## 2.5 Measurement Uncertainty

All measurement uncertainty values are shown with a coverage factor of  $k=2$  to indicate a 95% level of confidence.

### Emission Measurement Uncertainty

Parameter	Uncertainty
Radiated Emission (9 kHz ~ 30 MHz)	$\pm 1.15$ dB
Radiated Emission (30 MHz ~ 200 MHz)	$\pm 1.30$ dB
Radiated Emission (200 MHz ~ 1 GHz)	$\pm 1.30$ dB
Radiated Emission (1 GHz ~ 18 GHz)	$\pm 1.54$ dB
Radiated Emission (18 GHz ~ 40 GHz)	$\pm 2.52$ dB
Mains Conducted Emission	$\pm 1.65$ dB



### 3. General Product Information

#### 3.1 Product Function and Intended Use

The EUT is a Bluetooth low energy/ANT/802.15.4 Module. It contains IEEE802.15.4 compatible module enabling the user to communicate data through a Wireless interface.

For details refer to the User Guide, Data Sheet and Circuit Diagram.

#### 3.2 System Details and Ratings

##### Basic Information of EUT

Item	EUT information
Kind of Equipment/Test Item	Bluetooth low energy/ANT/802.15.4 Module
Type Identification	EYSRSN
FCC ID	RYYEYSRSN

##### Technical Specification of EUT

Item	EUT information
Operating Frequency	2405 MHz ~ 2480 MHz
Channel Number	16
Operation Voltage	3 Vdc
Modulation	O-QPSK
Maximum Output Power (mW)	6.22
Antenna Information	Refer to 5.1.1
Accessory Device	Refer to 4.4

### **3.3 Noise Generating and Noise Suppressing Parts**

Refer to the Circuit Diagram.

### **3.4 Submitted Documents**

- Circuit Diagram
- Instruction Manual
- Rating Label
- Technical Description

## 4. Test Set-up and Operation Modes

### 4.1 Principle of Configuration Selection

The test modes were adapted accordingly in reference to the instructions for use.

During testing, Channel and Power Controlling Software provided by the customer was used to control the operating channel as well as the output power level. The RF output power selection is for the setting of RF output expected by the customer and is going to be fixed on the firmware of the final end product.

#### Table for Parameters of Test Software Setting

Bluetooth Low Energy	
Frequency (MHz)	Power Setting
2405	8
2440	8
2480	8

### 4.2 Carrier Frequency and Channel

Channel	Freq. (MHz)	Channel	Freq. (MHz)
11	2405	19	2445
12	2410	20	2450
13	2415	21	2455
14	2420	22	2460
15	2425	23	2465
16	2430	24	2470
17	2435	25	2475
18	2440	26	2480

### 4.3 Test Operation and Test Software

Setup for testing: Test samples are provided with a USB interface which makes it possible to control them through a test software installed on a notebook computer.  
 This software was running on the laptop computer connected to the EUT. It was used to enable the operation modes listed as below.

Test Software	Radio Test Tool
---------------	-----------------

The samples were used as follows:

A003162507-001

A003162507-003

Full test was applied on all test modes, but only worst case was shown.

EUT Configure Mode	Applicable To			Mains Conducted Emission	Description
	Antenna Port Conducted Measurement	Radiated Spurious Emissions above 1 GHz	Radiated Spurious Emissions below 1 GHz		
Bluetooth Low Energy	√	√	√	√	-

Note:

1. The EUT had been pre-tested on the positioned of each 3 axis. The worst case was found when position on **Z-plane**.
2. "-" means no effect.

#### Antenna Port Conducted Measurement

Pre-Scan full test was applied on all test modes, but only worst case was shown.

Following channel(s) was (were) selected for the final test as listed below.

EUT Configure Mode	Available Frequency (MHz)	Tested Frequency (MHz)	Date Rate (kbps)
-	2405 to 2480	2405, 2440, 2480	250

#### Radiated Spurious Emissions (Above 1 GHz)

Pre-Scan full test was applied on all test modes, but only worst case was shown.

Following channel(s) was (were) selected for the final test as listed below.

EUT Configure Mode	Available Frequency (MHz)	Tested Frequency (MHz)	Date Rate (kbps)
-	2405 to 2480	2405, 2440, 2480	250

#### Radiated Spurious Emissions (Below 1 GHz)

Pre-Scan full test was applied on all test modes, but only worst case was shown.

Following channel(s) was (were) selected for the final test as listed below.

EUT Configure Mode	Available Frequency (MHz)	Tested Frequency (MHz)	Date Rate (kbps)
-	2405 to 2480	2480	250

#### Mains Conducted Emission

Pre-Scan full test was applied on all test modes, but only worst case was shown.

Following channel(s) was (were) selected for the final test as listed below.

EUT Configure Mode	Available Frequency (MHz)	Tested Frequency (MHz)	Date Rate (kbps)
-	2405 to 2480	2480	250

**Test Condition**

Test Item	Ambient Temperature	Relative Humidity	Tested by
Conducted Measurement	21.7 °C	57 %	Stanislas Charles
Radiated Spurious Emissions above 1 GHz	24.5-26.5 °C	57-62 %	Nick Guan
Radiated Spurious Emissions below 1 GHz	24.5-26.5 °C	57-62 %	Nick Guan
Mains Conducted Emission	22.1-23.2 °C	50-55 %	Hunter Wang

## 4.4 Special Accessories and Auxiliary Equipment

The product has been tested together with the following additional accessories:

**Accessory of EUT**

None

**Support Unit**

Support Unit								
No	Description	Brand	Model	S/N	Shielded	Ferrite Core (Qty)	Length (cm)	Remark
A	Mini USB Cable	TUV-JP	TUV-JP	N/A	NO	NO	180	Radiated
B	NB	TOSHIA	PORTEGE R30-A Series	N/A	-	-	-	
C	DC Cable	TUV-JP	TUV-JP	N/A	NO	NO	50	
1	DC Power Supply	GWINSTEK	GPC-3030DQ	GEN869895	-	-	-	
2	DC Cable	TUV	TUV	N/A	NO	NO	200	
A	DC Cable	TUV-JP	TUV-JP	N/A	NO	NO	50	Mains Conducted
B	Mini USB Cable	TUV-JP	TUV-JP	N/A	NO	NO	180	
C	NB	TOSHIA	PORTEGE R30-A Series	N/A	-	-	-	
1	DC Power Supply	GWINSTEK	GPC-3030DQ	GEN869895	-	-	-	

## 4.5 Test Setup Diagram

<Radiated Spurious Emissions mode>

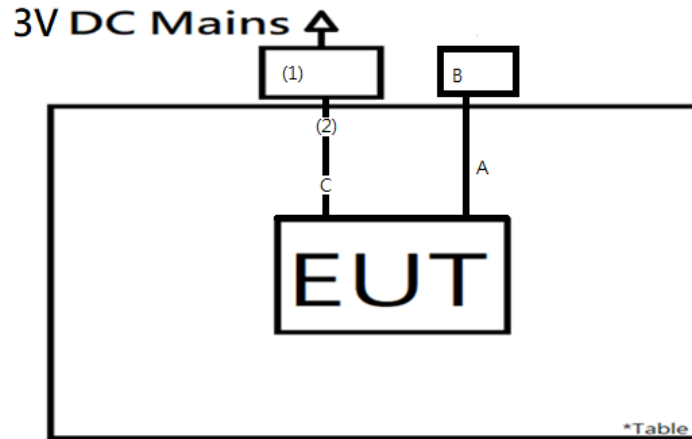

<Mains Conducted Emission mode>

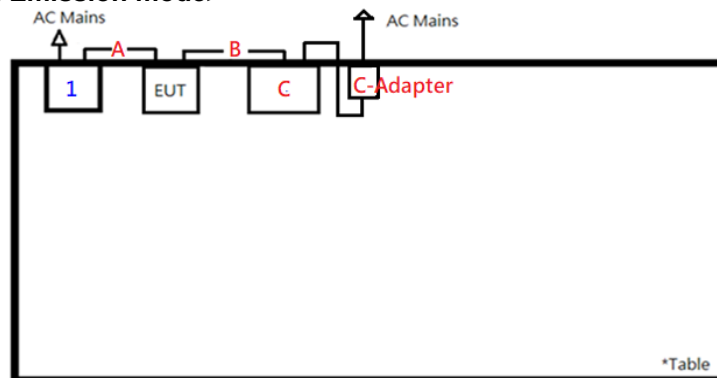

## 5. Test Results

### 5.1 Transmitter Requirement & Test Suites

#### 5.1.1 Antenna Requirement

**Requirement** Use of approved antennas only

According to the manufacturer declaration, the EUT has an antenna with a directional gain of -3.7 dBi. The antenna is PCB antenna with no possibility of replacement with a non-approved antenna by the end-user. Therefore, the EUT is considered to comply with this provision.  
Refer to EUT photo for details.

### 5.1.2 Peak Output Power

**Limit** 1 watt (30 dBm)

**Kind of Test Site** Shielded room

**Test Setup**



**Test Instruments**

Kind of Equipment	Manufacturer	Type	S/N	Calibration Date	Calibration Due Date	Test Date	
						From	Until
Power Meter	Anritsu	ML2495A	1901008	2021/3/24	2022/3/23	2021/12/28	2022/2/8
Power Sensor	Anritsu	MA2411B	1725269	2021/3/24	2022/3/23	2021/12/28	2022/2/8

**Test Procedures**

A peak power sensor was used on the output port of the EUT. A power meter was used to read the response of the peak power sensor. Record the power level.

Average power sensor was used to perform output power measurement, trigger and gating function of wide band power meter is enabled to measure max output power of TX on burst. Duty factor is not added to measured value.



**Test Result**
**Peak Output Power**

Channel	Channel Frequency	Peak Output Power		Limit (dBm)
	(MHz)	(dBm)	(mW)	
Low Channel	2405	7.63	5.79	30
Middle Channel	2440	7.78	6.00	30
High Channel	2480	7.94	6.22	30

**Average Power**

Channel	Channel Frequency	Average Power	
	(MHz)	(dBm)	(mW)
Low Channel	2405	7.60	5.75
Middle Channel	2440	7.75	5.96
High Channel	2480	7.89	6.15

### 5.1.3 6 dB Bandwidth and 99% Occupied Bandwidth

**Limit** The minimum 6 dB bandwidth shall be at least 500 kHz.

**Kind of Test Site** Shielded room

#### Test Setup

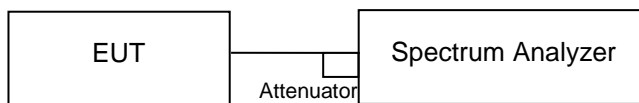

#### Test Instruments

Kind of Equipment	Manufacturer	Type	S/N	Calibration Date	Calibration Due Date	Test Date	
						From	Until
Spectrum Analyzer	R&S	FSV40	101508	2021/3/16	2022/3/15	2021/12/28	2022/2/8

#### Test Procedure

- a. Set resolution bandwidth (RBW) = 100 kHz
- b. Set the video bandwidth (VBW)  $\geq 3 \times$  RBW, Detector = Peak.
- c. Trace mode = max hold.
- d. Sweep = auto couple.
- e. Measure the maximum width of the emission that is constrained by the frequencies associated with the two amplitude points (upper and lower) that are attenuated by 6 dB relative to the maximum level measured in the fundamental emission.
- f. For 99% occupied bandwidth measurement, the transmitter output was connected to the spectrum analyzer through an attenuator. The bandwidth of the fundamental frequency was measured by spectrum analyzer with resolution bandwidth in the range of 1% to 5% of the anticipated emission bandwidth, and a video bandwidth at least 3x the resolution bandwidth and set the detector to PEAK. The width of a frequency band such that, below the lower and above the upper frequency limits, the mean powers emitted are each equal to a specified percentage 0.5% of the total mean power of a given emission.

#### Test Results

Please refer to Appendix A.

### 5.1.4 Power Spectral Density

**Limit**

The power spectral density shall not be greater than 8 dBm in any 3 kHz band.

**Kind of Test Site**                      Shielded room

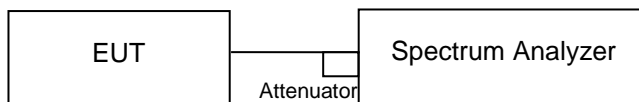
**Test Setup**

**Test Instruments**

Kind of Equipment	Manufacturer	Type	S/N	Calibration Date	Calibration Due Date	Test Date	
						From	Until
Spectrum Analyzer	R&S	FSV40	101508	2021/3/16	2022/3/15	2021/12/28	2022/2/8

**Test Procedure**

- a. Set analyzer center frequency to DTS channel center frequency.
- b. Set the span to 1.5 times the DTS bandwidth.
- c. Set the RBW to:  $3 \text{ kHz} \leq \text{RBW} \leq 100 \text{ kHz}$ .
- d. Set the VBW  $\geq 3 \times \text{RBW}$ .
- e. Detector = peak.
- f. Sweep time = auto couple.
- g. Trace mode = max hold.
- h. Allow trace to fully stabilize.
- i. Use the peak marker function to determine the maximum amplitude level within the RBW.

**Test Results**

Please refer to Appendix A.

## 5.1.5 Conducted Spurious Emissions and Frequency Band Edges Measured in 100kHz Bandwidth

### Limit

20dB (below that in the 100 kHz bandwidth within the band that contains the highest level of the desired power.)

**Kind of Test Site**                      Shielded room

### Test Setup

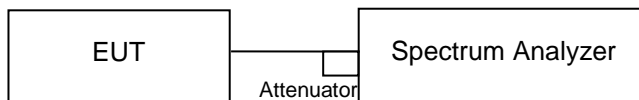

### Test Instruments

Kind of Equipment	Manufacturer	Type	S/N	Calibration Date	Calibration Due Date	Test Date	
						From	Until
Spectrum Analyzer	R&S	FSV40	101508	2021/3/16	2022/3/15	2021/12/28	2022/2/8

### Test Procedure

Measurement procedure REF

1. Set the RBW = 100 kHz.
2. Set the VBW  $\geq$  300 kHz.
3. Detector = peak.
4. Sweep time = auto couple.
5. Trace mode = max hold.
6. Allow trace to fully stabilize.
7. Use the peak marker function to determine the maximum power level in any 100 kHz band segment within the fundamental EBW.

Measurement procedure OOBE

1. Set RBW = 100 kHz.
2. Set VBW  $\geq$  300 kHz.
3. Detector = peak.
4. Sweep = auto couple.
5. Trace Mode = max hold.
6. Allow trace to fully stabilize.
7. Use the peak marker function to determine the maximum amplitude level.

### Test Results

Please refer to Appendix A.

## 5.1.6 Radiated Spurious Emissions and Band Edges

### Limit

Radiated emissions which fall in the restricted bands, as defined in §15.205(a), must comply with the radiated emission limits specified in §15.209(a).

Emissions radiated outside the restricted and authorized frequency bands must either comply with the radiated emission limits specified for the restricted bands or in §15.247(d).

**Kind of Test Site**                      3m Semi-Anechoic Chamber

### Test Setup

<Radiated Emissions below 30 MHz>

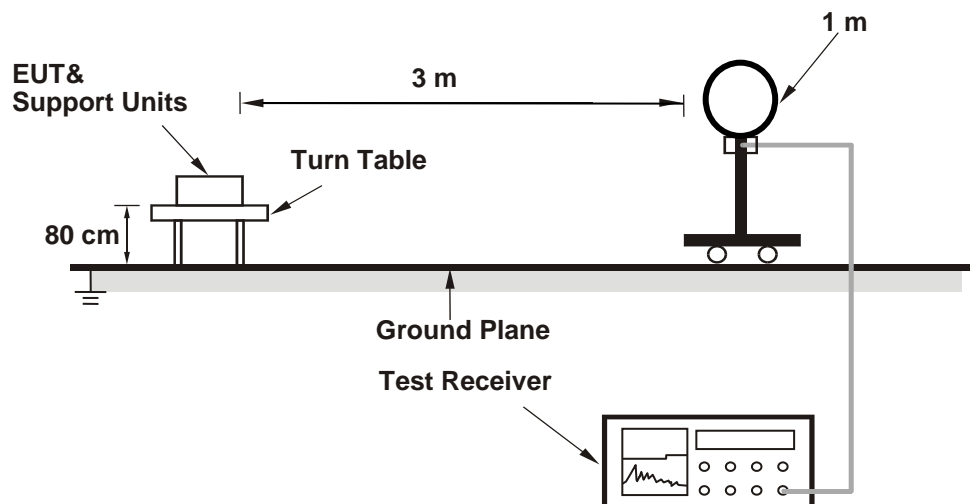

<Radiated Emissions 30 MHz to 1 GHz>

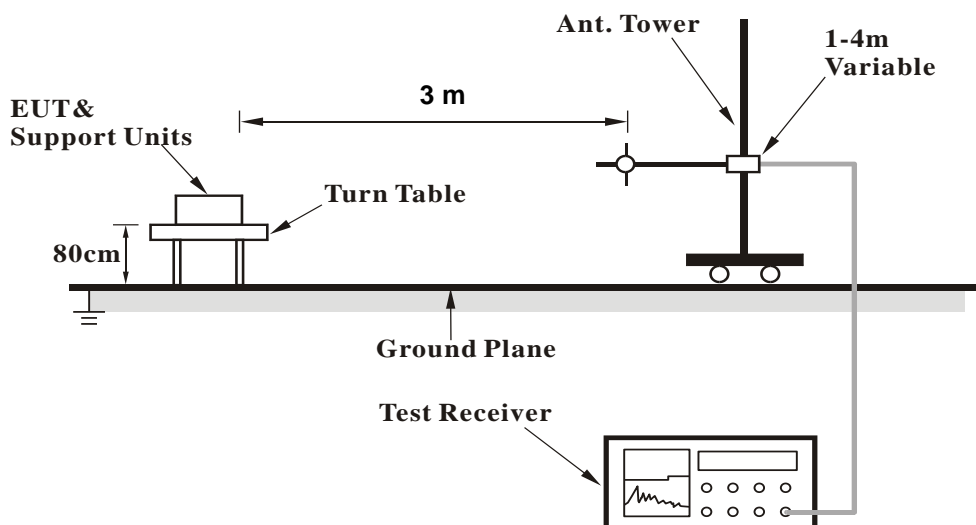

## &lt;Radiated Emissions above 1 GHz&gt;

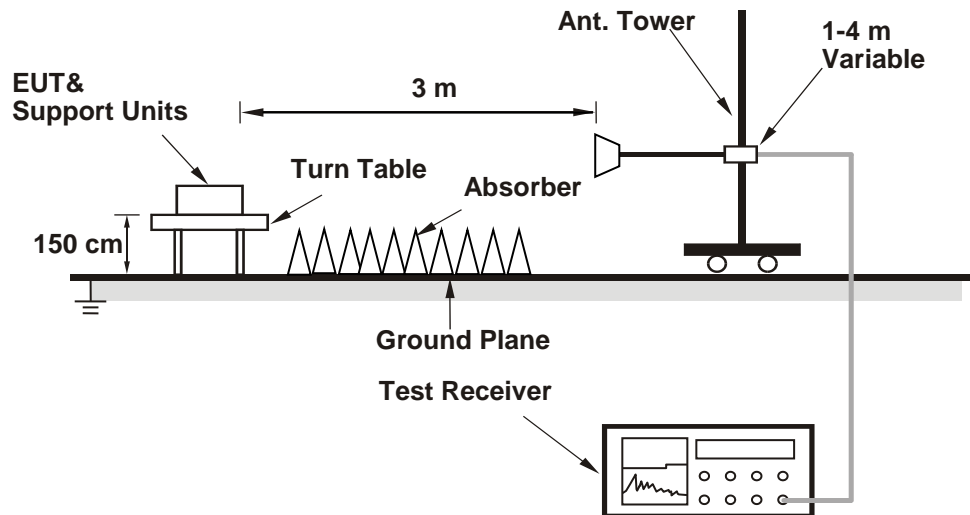

For the actual test configuration, please refer to the attached file (Test Setup Photo).

**Test Instruments**

Kind of Equipment	Manufacturer	Type	S/N	Calibration Date	Calibration Due Date
Signal Analyzer	R&S	FSV40	101508	2021/3/16	2022/3/15
Receiver	R&S	ESR7	102109	2021/3/16	2022/3/15
Bilog Antenna	SCHWARZBECK	VULB-9168	00951	2021/2/18	2022/2/17
Horn Antenna	ETS-Lindgren	3117	00218929	2021/11/25	2022/11/24
LF-AMP	Agilent	8447D	2944A10772	2021/2/18	2022/2/17
HF-AMP + AC source	EMCI	EMC051845SE	980633	2021/2/9	2022/2/8
			980635	2022/1/20	2023/1/19
HF-AMP + AC source	EMCI	EMC184045SE	980657	2021/2/1	2022/1/31
			980656	2022/1/20	2023/1/19
Horn Antenna	SCHWARZBECK	BBHA 9170	00887	2021/4/8	2022/4/7
Microwave Cable	HUBER+SUHNER	SUCOFLEX 104EA	800056/4EA	2021/3/17	2022/3/16
Microwave Cable	HUBER+SUHNER	SUCOFLEX 104	804680/4	2021/3/17	2022/3/16
Microwave Cable	HUBER+SUHNER	SUCOFLEX 104	MY37202/4	2021/3/17	2022/3/16
Microwave Cable	HUBER+SUHNER	SUCOFLEX 102EA	800898/2EA	2021/4/16	2022/4/15
Microwave Cable	HUBER+SUHNER	SUCOFLEX 102EA	800901/2EA	2021/4/16	2022/4/15
Microwave Cable	HUBER+SUHNER	SUCOFLEX 102EA	801027/2EA	2021/4/16	2022/4/15
Loop Antenna	SCHWARZBECK	FMZB1519B	00215	2021/12/8	2022/12/7

**Test Procedures****For Radiated Emissions below 30 MHz**

- a. The EUT was placed on the top of a rotating table 0.8 meters above the ground at a 3 meter chamber room. The table was rotated 360 degrees to determine the position of the highest radiation.
- b. The EUT was set 3 meters away from the interference-receiving antenna, which was mounted on the top of a variable-height antenna tower.
- c. Parallel (OPEN), perpendicular (CLOSE), and ground-parallel (GROUND) orientations of the antenna are set to make the measurement.
- d. For each suspected emission, the EUT was arranged to its worst case and the rotatable table was turned from 0 degrees to 360 degrees to find the maximum reading.
- e. The test-receiver system was set to Quasi-Peak Detect Function and Specified Bandwidth with Maximum Hold Mode.

## Note:

1. The resolution bandwidth and video bandwidth of test receiver/spectrum analyzer is 9 kHz at frequency below 30 MHz.
2. All modes of operation were investigated and the worst-case emissions are reported.

**For Radiated Emissions above 30 MHz**

- a. The EUT was placed on the top of a rotating table 0.8 meters (for 30 MHz ~ 1 GHz) / 1.5 meters (for above 1 GHz) above the ground at 3 meter chamber room for test. The table was rotated 360 degrees to determine the position of the highest radiation.
- b. The EUT was set 3 meters away from the interference-receiving antenna, which was mounted on the top of a variable-height antenna tower.
- c. The height of antenna is varied from one meter to four meters above the ground to determine the maximum value of the field strength. Both horizontal and vertical polarizations of the antenna are set to make the measurement.
- d. For each suspected emission, the EUT was arranged to its worst case and then the antenna was tuned to heights from 1 meter to 4 meters and the rotatable table was turned from 0 degrees to 360 degrees to find the maximum reading.
- e. The test-receiver system was set to quasi-peak detect function and specified bandwidth with maximum hold mode when the test frequency is below 1 GHz.
- f. The test-receiver system was set to peak and average detected function and specified bandwidth with maximum hold mode when the test frequency is above 1 GHz. If the peak reading value also meets average limit, measurement with the average detector is unnecessary.

## Note:

1. The resolution bandwidth and video bandwidth of test receiver/spectrum analyzer is 120 kHz for Quasi-peak detection (QP) or Peak detection (PK) at frequency below 1 GHz.
2. The resolution bandwidth of test receiver/spectrum analyzer is 1 MHz and the video bandwidth is 3 MHz for Peak detection (PK) at frequency above 1 GHz.
3. The resolution bandwidth of test receiver/spectrum analyzer is 1 MHz and the video bandwidth is  $\geq 1/T$  (Duty cycle < 98 %) or 10 Hz (Duty cycle  $\geq 98$  %) for Average detection (AV) at frequency above 1 GHz.
4. All modes of operation were investigated and the worst-case emissions are reported.
5. The Radiated Emissions testing was performed in the X(E1), Y(H) and Z(E2) axis orientation. The worst-case Axis orientation is recorded in this test report.



**Prüfbericht - Nr.:**      **CN22D1N5 (P15C-IEEE802.15.4) 001**  
*Test Report No.*

**Seite 25 von 27**  
*Page 25 of 27*

**Test Results**

Factor (dB/m) = Antenna Factor (dB/m) + Cable Loss (dB)  
Level (dBuV/m) = Reading (dBuV) + Factor (dB/m)

Please refer to Appendix B.

## 5.2 Mains Emission

### 5.2.1 Mains Conducted Emission

#### Limit

Mains Conducted Emission as defined in §15.207 must comply with the mains conducted emission limits.

**Kind of Test Site**                      Shielded room

#### Test Setup

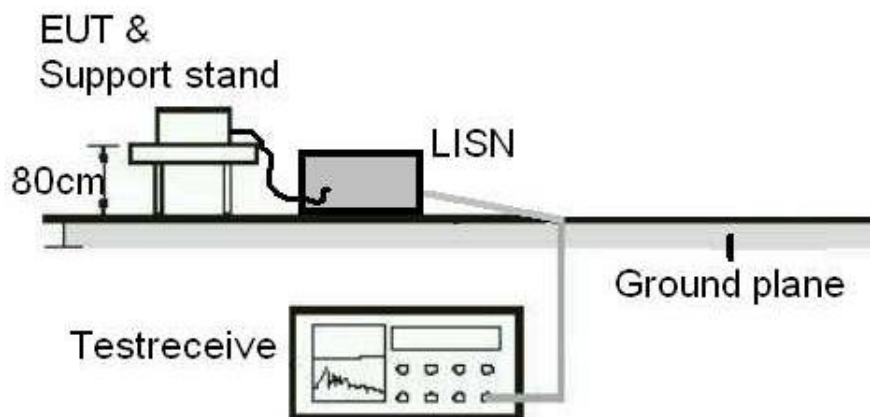

#### Test Instruments

Kind of Equipment	Manufacturer	Type	S/N	Calibration Date	Calibration Due Date
RF Cable	N/A	N/A	EMC-003	2021/3/16	2022/3/15
Two-Line V-Network	Rohde & Schwarz	ENV216	101938	2021/9/23	2022/9/22
EMI Test Receiver	R&S	ESCI	1816063	2021/11/15	2022/11/14

#### Test Procedures

- a. The EUT was placed 0.4 meters from the conducting wall of the shielded room with EUT being connected to the power mains through a line impedance stabilization network (LISN). Other support units were connected to the power mains through another LISN. The two LISNs provide 50 ohm/50 uH of coupling impedance for the measuring instrument.
- b. Both lines of the power mains connected to the EUT were checked for maximum conducted interference.
- c. The frequency range from 150 kHz to 30 MHz was searched. Emission levels under (Limit – 20 dB) was not recorded.

Note: The resolution bandwidth and video bandwidth of test receiver is 9 kHz for quasi-peak detection (QP) and average detection (AV) at frequency 0.15 MHz – 30 MHz.

#### Test Results

Please refer to Appendix B.

## Appendix A: Test Results of Conducted Test

### Test Result of 6 dB Bandwidth

Channel	Channel Frequency (MHz)	6 dB Bandwidth (kHz)	Limit (kHz)	Result
Low Channel	2405	1203.8	> 500	Pass
Middle Channel	2440	1198.8	> 500	Pass
High Channel	2480	1188.8	> 500	Pass

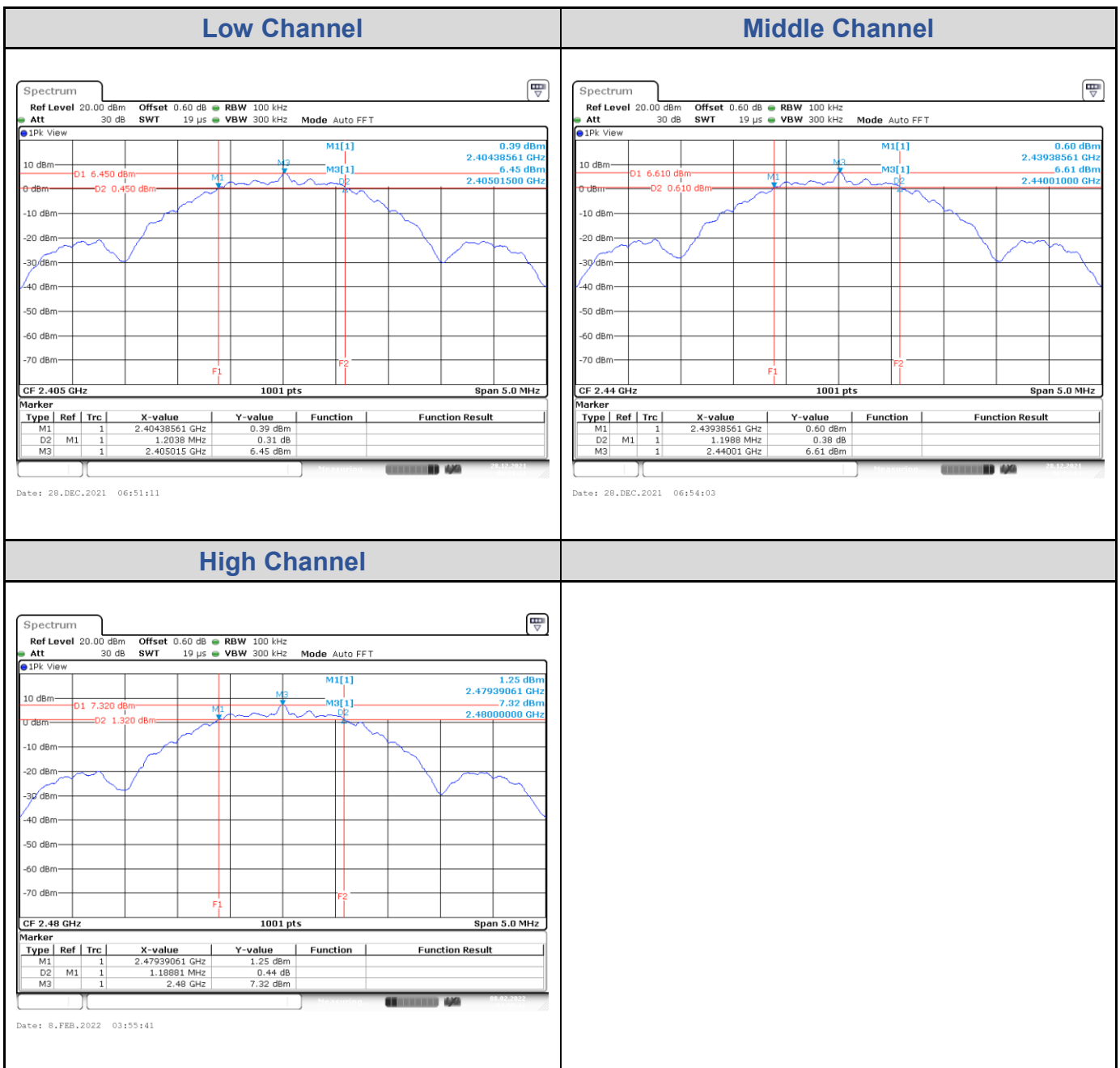

## Test Result of 99% Occupied Bandwidth

Channel	Channel Frequency (MHz)	99% Bandwidth (MHz)
Low Channel	2405	2.238
Middle Channel	2440	2.248
High Channel	2480	2.253

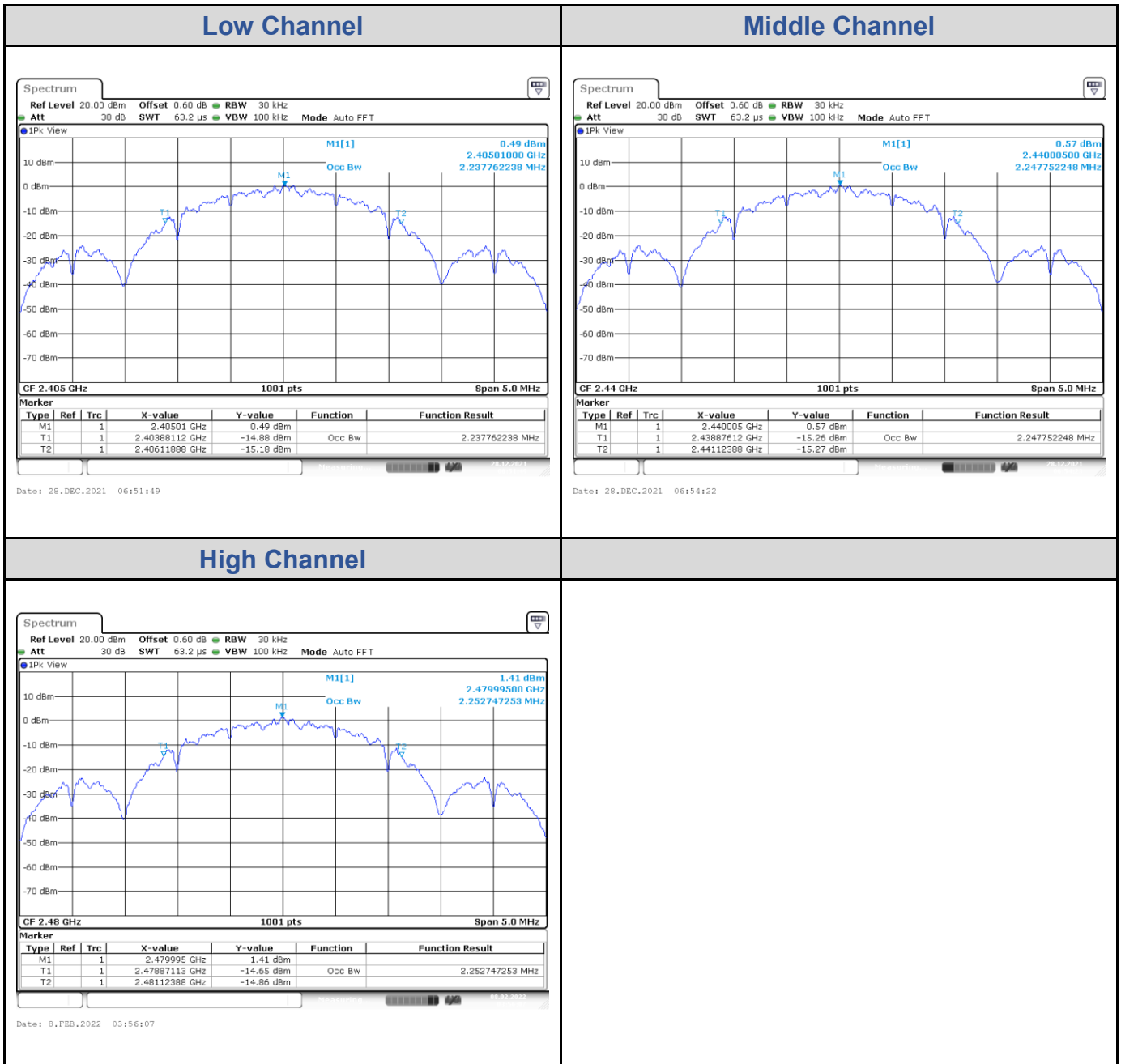

## Test Result of Power Spectral Density

Channel	Channel Frequency (MHz)	Power Density (dBm/3kHz)	Limit (dBm/3kHz)	Result
Low Channel	2405	-6.28	8	Pass
Middle Channel	2440	-6.50	8	Pass
High Channel	2480	-5.99	8	Pass

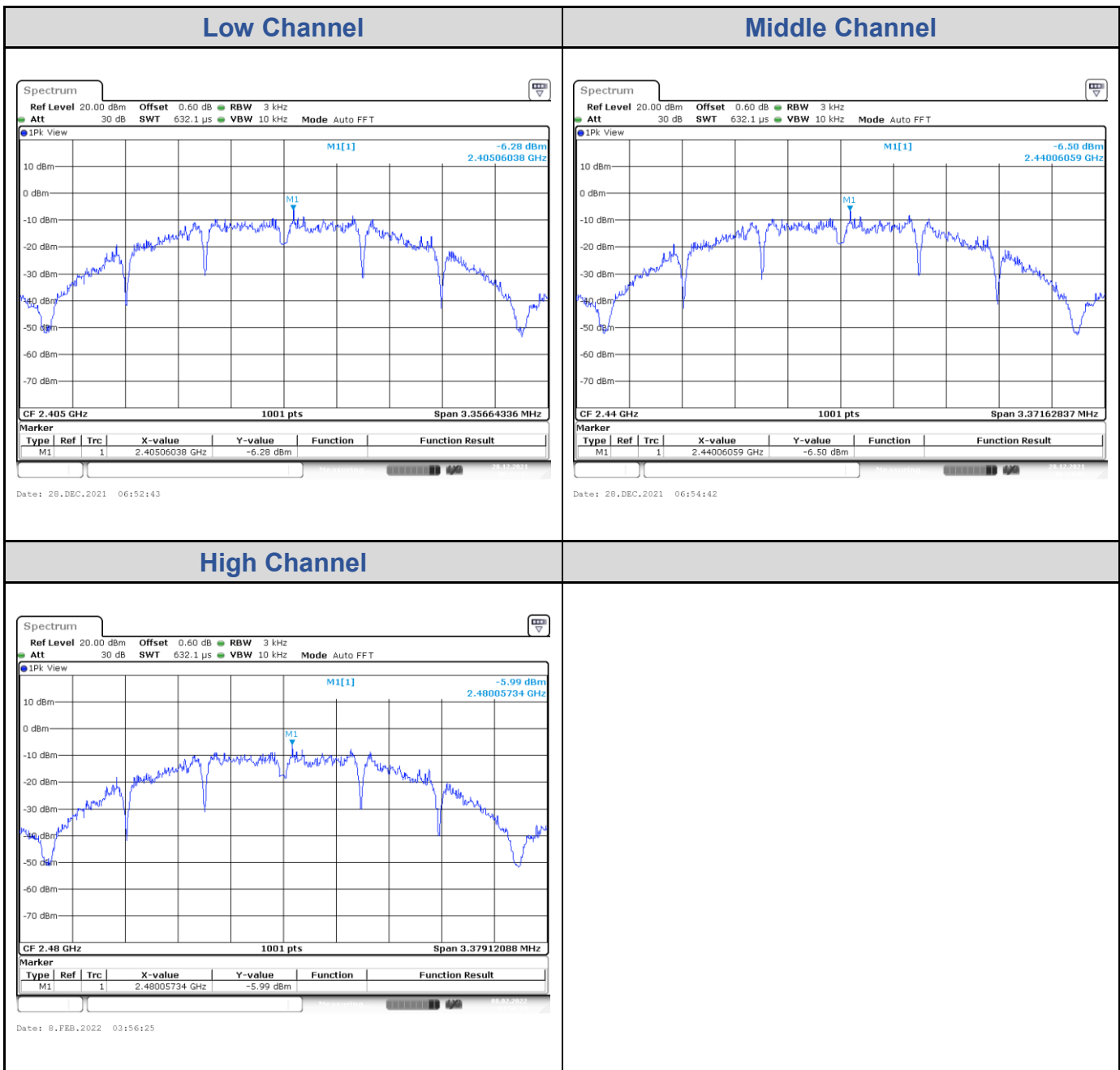

### Test Result of Conducted Spurious Emissions, Tx Mode

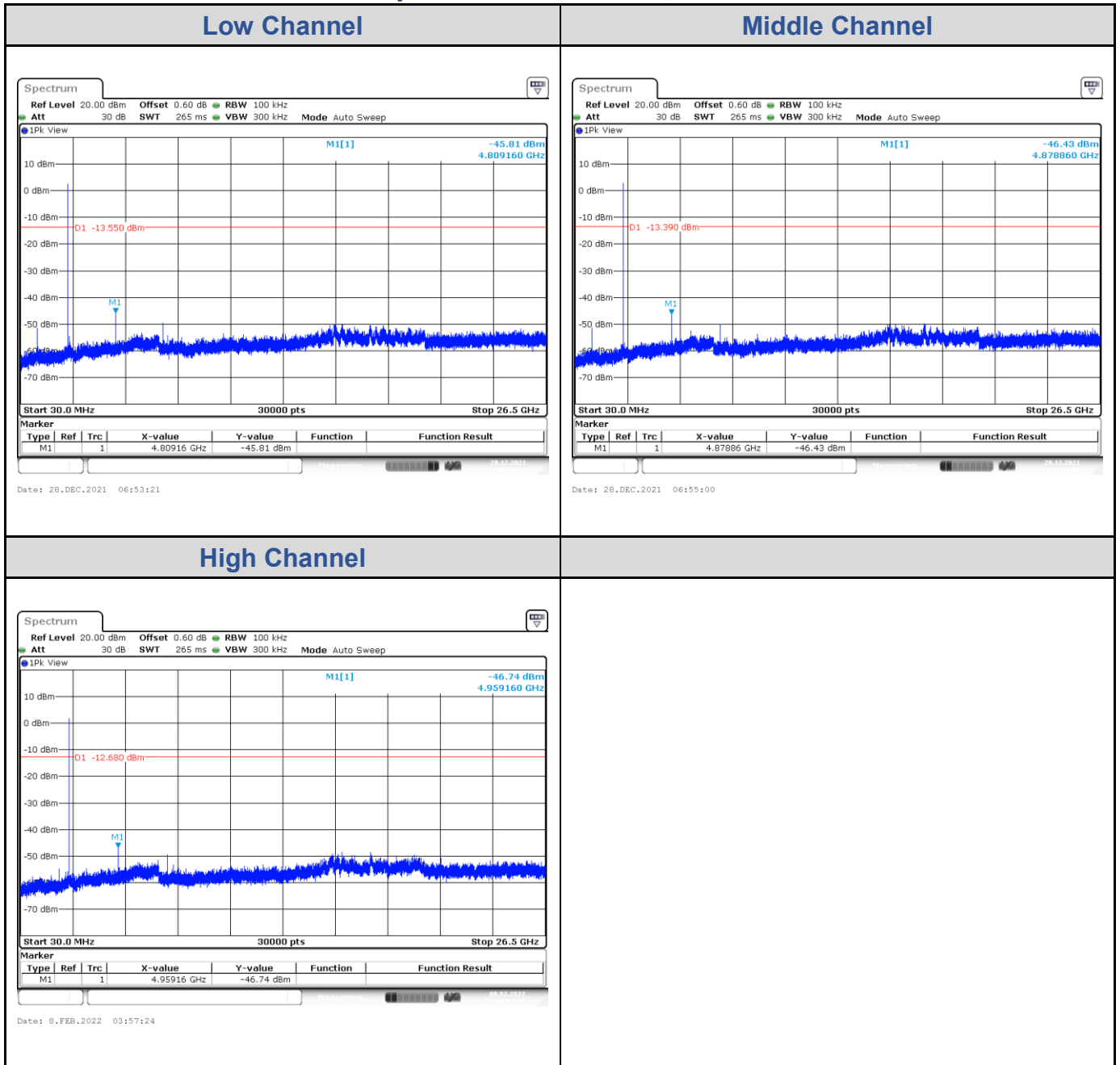

## Test Result of Conducted Band Edge, Tx Mode

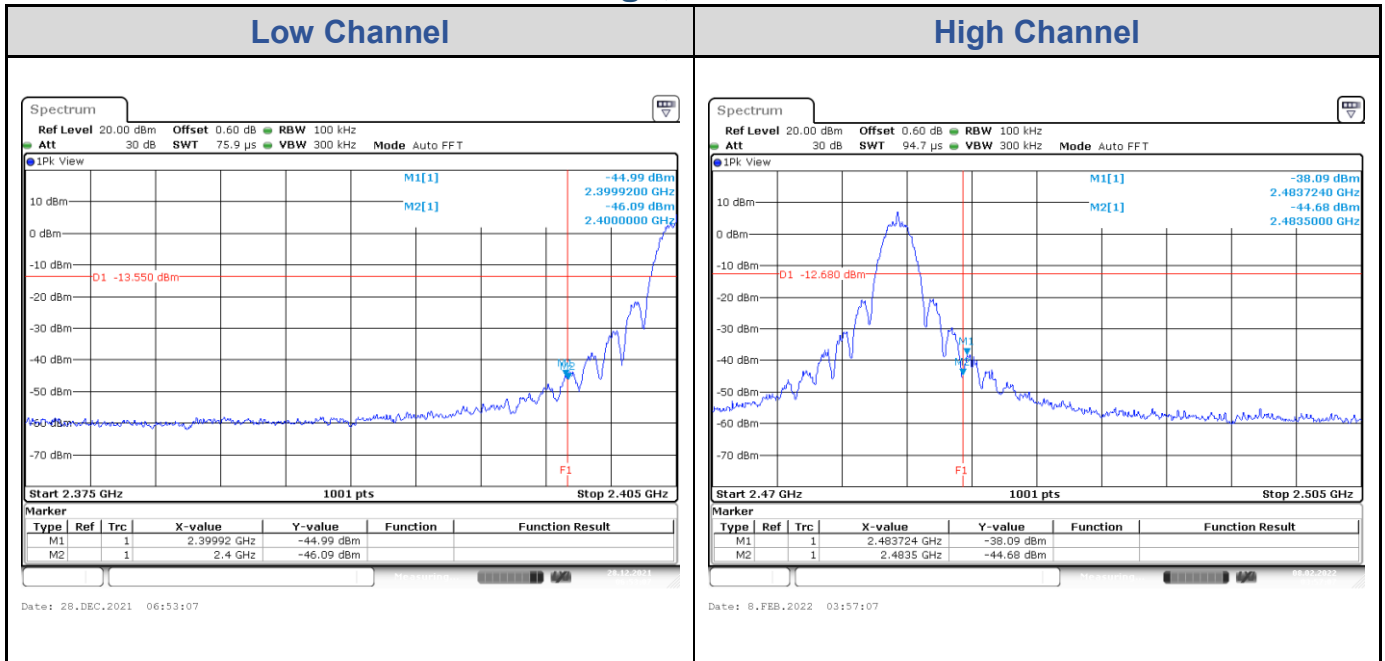



# Appendix B: Test Results of Radiated Spurious Emissions & Mains

## Conducted Emission Test

### Band Edges, 2.31GHz ~ 2.9GHz

#### IEEE802.15.4

##### Low Channel (Horizontal) Peak

##### Low Channel (Vertical) Peak



TUV Rheinland Taiwan Ltd.  
No. 438-18, Sec 2, Fenliao, Linkou Dist., New Taipei City 244, Taiwan(R.O.C.)  
Tel: +886-2172-1000 Fax: +886-2172-1322

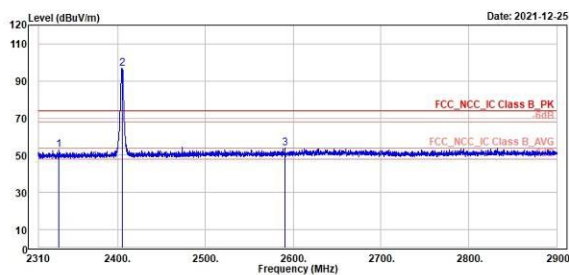

Freq	Level	Read	Limit	Over	Apos	TPos	Remark	Pol/Phase	Note
MHz	dBuV/m	dBuV	dB/m	dBuV/m	dB	cm	deg		
1	2333.13	53.01	15.59	37.42	74.00	-20.99	105	156 Peak	Horizontal
2 *	2405.00	96.08	59.24	37.64	74.00	22.88	105	156 Peak	Horizontal
3	2590.25	53.74	15.66	38.08	74.00	-20.26	105	156 Peak	Horizontal



TUV Rheinland Taiwan Ltd.  
No. 438-18, Sec 2, Fenliao, Linkou Dist., New Taipei City 244, Taiwan(R.O.C.)  
Tel: +886-2172-1000 Fax: +886-2172-1322

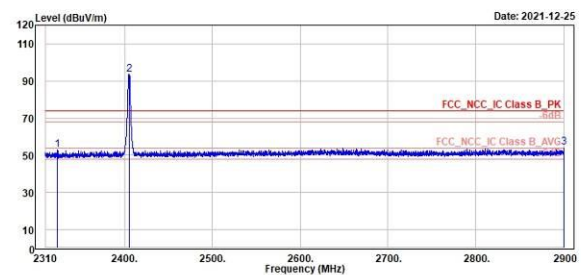

Freq	Level	Read	Limit	Over	Apos	TPos	Remark	Pol/Phase	Note
MHz	dBuV/m	dBuV	dB/m	dBuV/m	dB	cm	deg		
1	2333.69	52.74	15.35	37.39	74.00	-21.26	101	215 Peak	Vertical
2 *	2405.00	93.47	55.83	37.64	74.00	19.47	101	215 Peak	Vertical
3	2900.00	54.36	16.84	38.32	74.00	-19.64	101	215 Peak	Vertical

**IEEE802.15.4**
**Low Channel (Horizontal) Average**
**Low Channel (Vertical) Average**

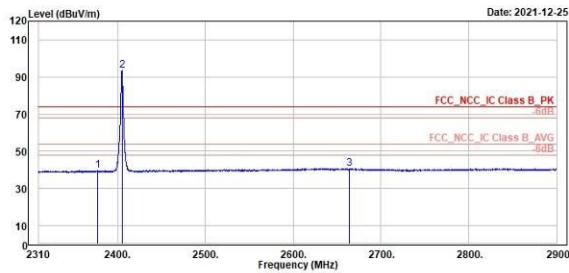

TÜV Rheinland Taiwan Ltd.  
No. 438-18, Sec 2, Fenliao, Linkou Dist., New Taipei City 244, Taiwan(R.O.C.)  
Tel: +886-2172-1000 Fax: +886-2172-1322



Freq	Level	Read	Limit	Over	APos	TPos	Remark	Pol/Phase	Note
MHz	dBuV/m	dBuV	dB/m	dBuV/m	dB	cm	deg		
1	2377.59	39.56	2.00	37.56	54.00	-14.44	105	156 Average	Horizontal
2 *	2405.00	93.66	56.02	37.64	54.00	39.66	105	156 Average	Horizontal
3	2663.53	40.73	2.52	38.21	54.00	-13.27	105	156 Average	Horizontal

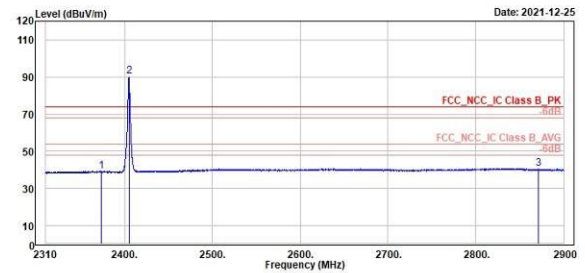

TÜV Rheinland Taiwan Ltd.  
No. 438-18, Sec 2, Fenliao, Linkou Dist., New Taipei City 244, Taiwan(R.O.C.)  
Tel: +886-2172-1000 Fax: +886-2172-1322



Freq	Level	Read	Limit	Over	APos	TPos	Remark	Pol/Phase	Note
MHz	dBuV/m	dBuV	dB/m	dBuV/m	dB	cm	deg		
1	2373.25	39.45	1.00	37.55	54.00	-14.55	101	215 Average	Vertical
2 *	2405.00	90.28	52.64	37.64	54.00	36.28	101	215 Average	Vertical
3	2871.33	40.75	2.57	38.18	54.00	-13.25	101	215 Average	Vertical

**IEEE802.15.4**
**High Channel (Horizontal) Peak**
**High Channel (Vertical) Peak**

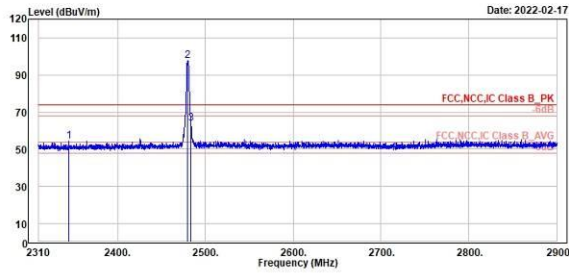

TÜV Rheinland Taiwan Ltd.  
No. 438-18, Sec 2, Fenliao, Linkou Dist., New Taipei City 244, Taiwan(R.O.C.)  
Tel: +886-2172-1010 Fax: +886-2172-1322



Peak	Freq	Level	Read Level	Factor	Limit Line	Over Limit	APos	TPos	Remark	Pol/Phase	Note
	MHz	dBuV/m	dBuV	dB/m	dBuV/m	dB	cm	deg			
1	2344.81	54.27	16.91	37.36	74.00	-19.73	119	163	Peak	Horizontal	
2 *	2480.00	97.66	59.87	37.79	74.00	23.66	119	163	Peak	Horizontal	
3	2483.58	63.70	25.90	37.80	74.00	-10.30	119	163	Peak	Horizontal	

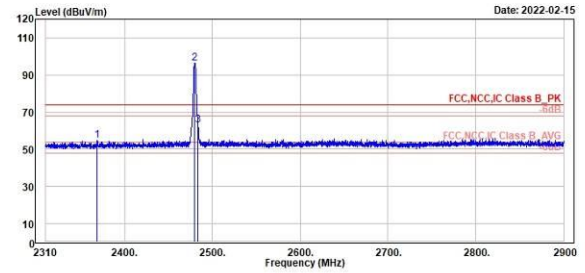

TÜV Rheinland Taiwan Ltd.  
No. 438-18, Sec 2, Fenliao, Linkou Dist., New Taipei City 244, Taiwan(R.O.C.)  
Tel: +886-2172-1010 Fax: +886-2172-1322



Peak	Freq	Level	Read Level	Factor	Limit Line	Over Limit	APos	TPos	Remark	Pol/Phase	Note
	MHz	dBuV/m	dBuV	dB/m	dBuV/m	dB	cm	deg			
1	2369.00	54.57	17.09	37.48	74.00	-19.43	108	184	Peak	Vertical	
2 *	2480.00	96.11	58.32	37.79	74.00	22.11	108	184	Peak	Vertical	
3	2483.46	62.87	25.07	37.80	74.00	-11.13	108	184	Peak	Vertical	

**IEEE802.15.4**
**High Channel (Horizontal) Average**
**High Channel (Vertical) Average**

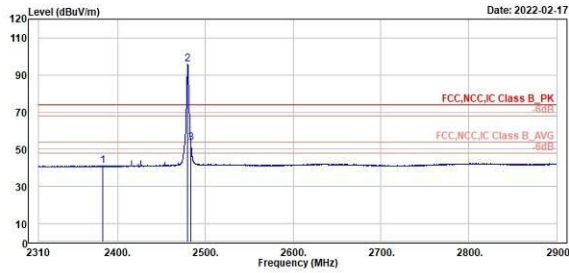
 TÜV Rheinland Taiwan Ltd.  
 No. 438-18, Sec 2, Fenliao, Linkou Dist., New Taipei City 244, Taiwan(R.O.C.)  
 Tel: +886-2172-1000 Fax: +886-2172-1322

Date: 2022-02-17

Freq	Level	Read	Level	Factor	Limit	Over	APos	TPos	Remark	Pol/Phase	Note
MHz	dBuV/m	dBuV	dB/m	dBuV/m	dB	dB	cm	deg			
1	2383.51	41.15	3.61	37.54	54.00	-12.85	119	162	Average	Horizontal	
2 *	2480.00	95.75	57.96	37.79	54.00	41.75	119	162	Average	Horizontal	
3 !	2483.50	53.44	15.64	37.80	54.00	-0.56	119	162	Average	Horizontal	

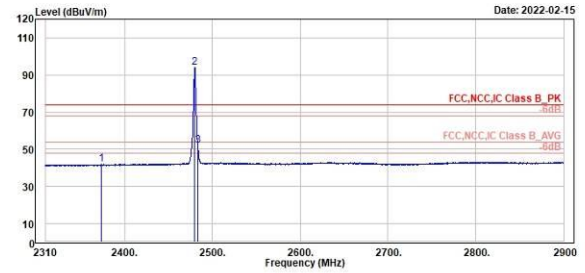
 TÜV Rheinland Taiwan Ltd.  
 No. 438-18, Sec 2, Fenliao, Linkou Dist., New Taipei City 244, Taiwan(R.O.C.)  
 Tel: +886-2172-1000 Fax: +886-2172-1322

Date: 2022-02-15

Freq	Level	Read	Level	Factor	Limit	Over	APos	TPos	Remark	Pol/Phase	Note
MHz	dBuV/m	dBuV	dB/m	dBuV/m	dB	dB	cm	deg			
1	2373.13	41.97	4.48	37.49	54.00	-12.03	188	184	Average	Vertical	
2 *	2480.00	94.21	56.42	37.79	54.00	40.21	188	184	Average	Vertical	
3 !	2483.50	52.19	14.39	37.80	54.00	-1.81	188	184	Average	Vertical	

Spurious Emissions, Tx Mode, 9kHz ~ 30MHz

IEEE802.15.4

High Channel 9kHz~150kHz(Open)

High Channel 150kHz~30MHz(Open)



TUV Rheinland Taiwan Ltd.  
No. 438-18, Sec 2, Fenliao, Linkou Dist., New Taipei City 244, Taiwan(R.O.C.)  
Tel: +886-2172-1000 Fax: +886-2172-1322

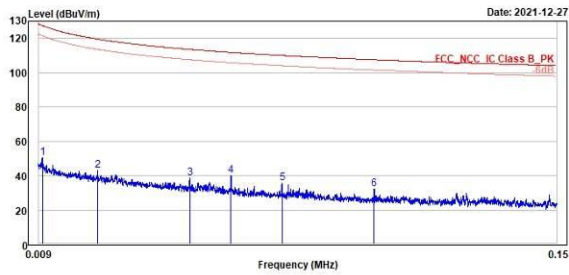

Freq	Level	Read	Limit	Over	Apos	TPos	Remark	Pol/Phase	Note
MHz	dBuV/m	dBuV	dB/m	dBuV/m	dB	cm	deg		
1	0.01	50.37	32.63	17.74	127.58	-77.21	100	336 QP	Open
2	0.03	43.14	24.04	19.10	119.61	-76.47	100	235 QP	Open
3	0.05	38.66	19.31	19.35	113.58	-74.92	100	245 QP	Open
4	0.06	40.19	21.09	19.10	111.83	-71.64	100	261 QP	Open
5	0.08	35.38	16.58	18.80	110.06	-74.68	100	261 QP	Open
6	0.10	32.32	14.06	18.26	107.57	-75.25	100	245 QP	Open



TUV Rheinland Taiwan Ltd.  
No. 438-18, Sec 2, Fenliao, Linkou Dist., New Taipei City 244, Taiwan(R.O.C.)  
Tel: +886-2172-1000 Fax: +886-2172-1322

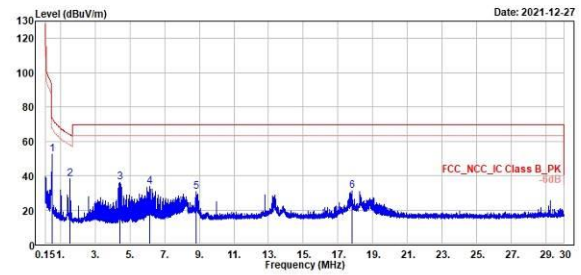

Freq	Level	Read	Limit	Over	Apos	TPos	Remark	Pol/Phase	Note
MHz	dBuV/m	dBuV	dB/m	dBuV/m	dB	cm	deg		
1	0.52	52.27	33.27	19.00	73.23	-20.96	100	224 QP	Open
2	1.57	37.89	18.51	19.38	63.67	-25.78	100	224 QP	Open
3	4.46	36.22	16.83	19.39	69.50	-33.28	100	266 QP	Open
4	6.15	33.73	13.91	19.82	69.50	-35.77	100	266 QP	Open
5	8.82	30.44	9.54	20.90	69.50	-39.06	100	262 QP	Open
6	17.79	31.35	9.44	21.91	69.50	-38.15	100	10 QP	Open

**Spurious Emissions, Tx Mode, 9kHz ~ 30MHz**
**IEEE802.15.4**
**High Channel 9kHz~150kHz(Close)**
**High Channel 150kHz~30MHz(Close)**

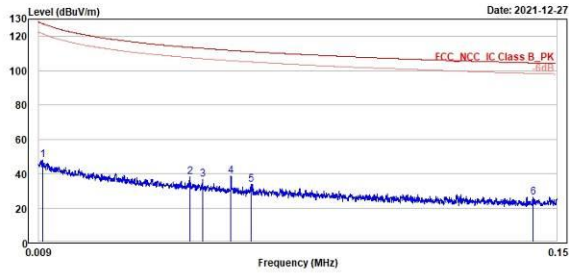
 TÜV Rheinland Taiwan Ltd.  
 No. 438-18, Sec 2, Fenliao, Linkou Dist., New Taipei City 244, Taiwan(R.O.C.)  
 Tel: +886-2172-1000 Fax: +886-2172-1322

Freq	Level	Read	Limit	Over	APos	TPos	Remark	Pol/Phase	Note
MHz	dBuV/m	dBuV	dB/m	dBuV/m	dB	cm	deg		
1	0.01	47.74	30.00	17.74	127.57	-79.83	100	312 QP	Close
2	0.05	38.21	18.86	19.35	113.58	-75.37	100	204 QP	Close
3	0.05	36.34	17.07	19.27	113.01	-76.67	100	196 QP	Close
4	0.06	38.57	19.47	19.10	111.81	-73.26	100	177 QP	Close
5	0.07	33.83	14.85	18.98	111.10	-77.27	100	264 QP	Close
6	0.14	26.39	7.98	18.41	104.45	-78.06	100	297 QP	Close

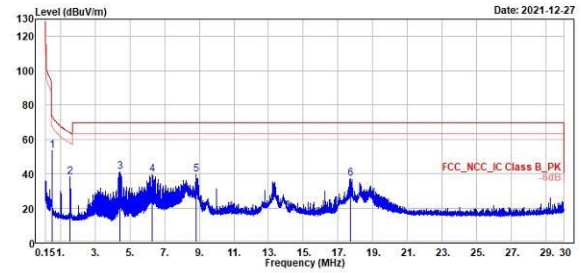
 TÜV Rheinland Taiwan Ltd.  
 No. 438-18, Sec 2, Fenliao, Linkou Dist., New Taipei City 244, Taiwan(R.O.C.)  
 Tel: +886-2172-1000 Fax: +886-2172-1322

Freq	Level	Read	Limit	Over	APos	TPos	Remark	Pol/Phase	Note
MHz	dBuV/m	dBuV	dB/m	dBuV/m	dB	cm	deg		
1	0.52	53.60	34.60	19.00	73.23	-19.63	100	169 QP	Close
2	1.57	38.16	18.78	19.38	63.68	-25.52	100	169 QP	Close
3	4.46	40.84	21.45	19.39	69.50	-28.66	100	121 QP	Close
4	6.31	39.75	19.87	19.88	69.50	-29.75	100	35 QP	Close
5	8.82	39.68	18.78	20.90	69.50	-29.82	100	145 QP	Close
6	17.70	36.91	15.01	21.90	69.50	-32.59	100	201 QP	Close

**Spurious Emissions, Tx Mode, 30MHz ~ 1GHz**
**IEEE802.15.4**
**High Channel (Horizontal)**
**High Channel (Vertical)**

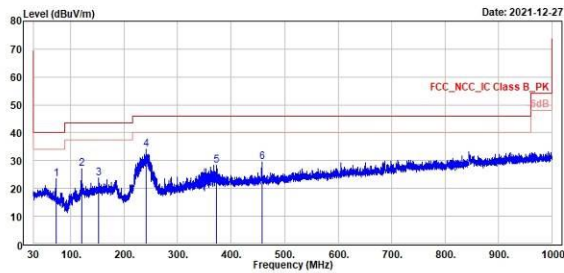

TÜV Rheinland Taiwan Ltd.  
No. 438-18, Sec 2, Fenliao, Linkou Dist., New Taipei City 244, Taiwan(R.O.C.)  
Tel: +886-2172-1000 Fax: +886-2172-1322



Freq	Level	Read	Limit	Over	APos	TPos	Remark	Pol/Phase	Note
MHz	dBuV/m	dBuV	dB/m	dBuV/m	dB	cm	deg		
1	72.00	23.31	33.68	-10.37	48.00	-16.69	300	282 QP	Horizontal
2	119.92	27.21	37.03	-9.82	43.50	-16.29	300	81 QP	Horizontal
3	152.41	23.84	31.17	-7.33	43.50	-19.66	300	225 QP	Horizontal
4	240.01	33.98	42.29	-8.31	46.00	-12.02	100	265 QP	Horizontal
5	372.99	28.33	33.30	-4.97	46.00	-17.67	100	57 QP	Horizontal
6	458.06	29.58	33.27	-3.69	46.00	-16.42	200	234 QP	Horizontal

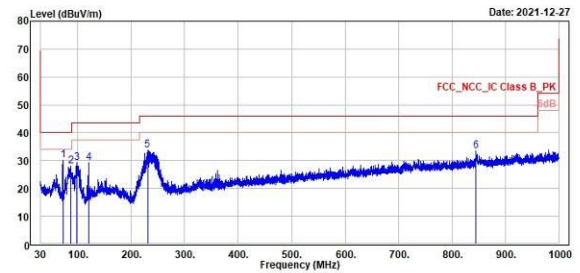

TÜV Rheinland Taiwan Ltd.  
No. 438-18, Sec 2, Fenliao, Linkou Dist., New Taipei City 244, Taiwan(R.O.C.)  
Tel: +886-2172-1000 Fax: +886-2172-1322



Freq	Level	Read	Limit	Over	APos	TPos	Remark	Pol/Phase	Note
MHz	dBuV/m	dBuV	dB/m	dBuV/m	dB	cm	deg		
1	72.20	30.11	40.50	-10.39	40.00	-9.89	100	225 QP	Vertical
2	87.13	27.93	41.18	-13.25	40.00	-12.07	100	143 QP	Vertical
3	98.19	29.08	42.36	-13.28	43.50	-14.42	100	203 QP	Vertical
4	120.02	29.05	38.86	-9.81	43.50	-14.45	100	64 QP	Vertical
5	230.31	33.70	42.34	-8.64	46.00	-12.30	100	141 QP	Vertical
6	845.58	33.32	30.77	2.55	46.00	-12.68	100	28 QP	Vertical

**Spurious Emissions, Tx Mode, 1GHz ~ 26.5GHz**
**IEEE802.15.4**
**Low Channel (Horizontal)**
**Low Channel (Vertical)**

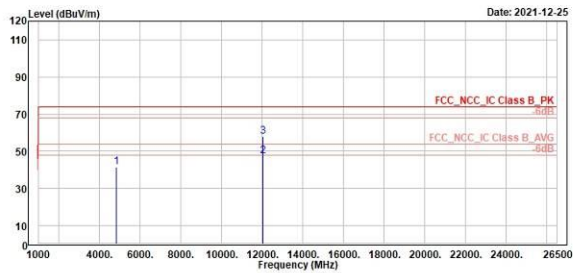

TÜV Rheinland Taiwan Ltd.  
No. 438-18, Sec 2, Fenliao, Linkou Dist., New Taipei City 244, Taiwan(R.O.C.)  
Tel: +886-2172-1010 Fax: +886-2172-1322



Freq	Level	Read Level	Factor	Limit Line	Over Limit	APos	TPos	Remark	Pol/Phase	Note
MHz	dBuV/m	dBuV	dB/m	dBuV/m	dB	cm	deg			
1	4818.00	41.57	51.14	-9.57	74.00	-32.43	300	328 Peak	Horizontal	
2	12025.00	47.41	47.70	-0.29	54.00	-6.59	118	81 Average	Horizontal	
3	12025.00	57.77	58.06	-0.29	74.00	-16.23	118	82 Peak	Horizontal	

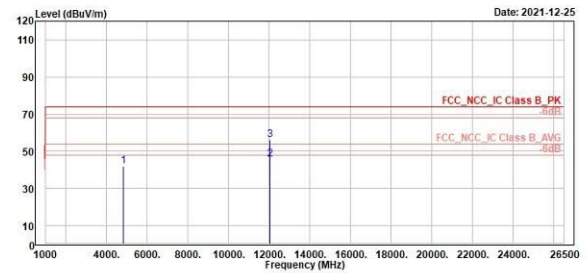

TÜV Rheinland Taiwan Ltd.  
No. 438-18, Sec 2, Fenliao, Linkou Dist., New Taipei City 244, Taiwan(R.O.C.)  
Tel: +886-2172-1010 Fax: +886-2172-1322



Freq	Level	Read Level	Factor	Limit Line	Over Limit	APos	TPos	Remark	Pol/Phase	Note
MHz	dBuV/m	dBuV	dB/m	dBuV/m	dB	cm	deg			
1	4818.00	41.97	51.54	-9.57	74.00	-32.03	400	90 Peak	Vertical	
2	12025.00	45.51	45.80	-0.29	54.00	-8.49	100	37 Average	Vertical	
3	12025.00	55.95	56.24	-0.29	74.00	-18.05	100	37 Peak	Vertical	



**IEEE802.15.4**
**Middle Channel (Horizontal)**
**Middle Channel (Vertical)**

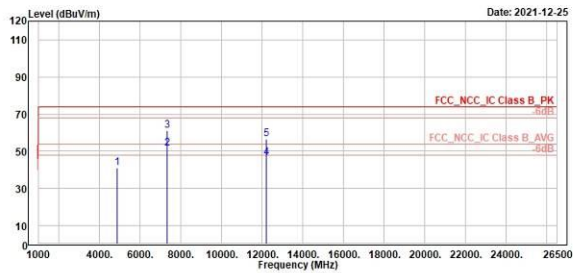

TÜV Rheinland Taiwan Ltd.  
No. 438-18, Sec 2, Fenliao, Linkou Dist., New Taipei City 244, Taiwan(R.O.C.)  
Tel: +886-2172-1010 Fax: +886-2172-1322



Freq	Level	Read Level	Factor	Limit Line	Over Limit	APos	TPos	Remark	Pol/Phase	Note
MHz	dBuV/m	dBuV	dB/m	dBuV/m	dB	cm	deg			
1	4880.00	40.97	50.50	-9.53	74.00	-33.03	400	360 Peak	Horizontal	
2	7320.00	51.50	58.87	-7.37	54.00	-2.50	103	81 Average	Horizontal	
3	7320.00	61.01	68.38	-7.37	74.00	-12.99	103	81 Peak	Horizontal	
4	12280.00	46.33	46.35	-0.02	54.00	-7.67	117	79 Average	Horizontal	
5	12280.00	56.68	56.70	-0.02	74.00	-17.32	117	79 Peak	Horizontal	

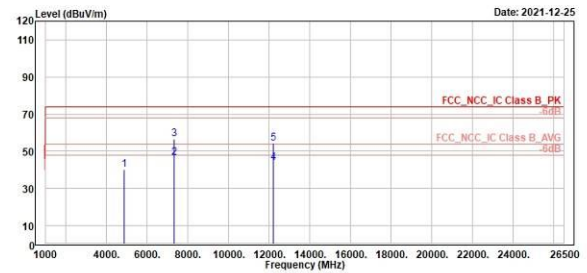

TÜV Rheinland Taiwan Ltd.  
No. 438-18, Sec 2, Fenliao, Linkou Dist., New Taipei City 244, Taiwan(R.O.C.)  
Tel: +886-2172-1010 Fax: +886-2172-1322



Freq	Level	Read Level	Factor	Limit Line	Over Limit	APos	TPos	Remark	Pol/Phase	Note
MHz	dBuV/m	dBuV	dB/m	dBuV/m	dB	cm	deg			
1	4880.00	40.25	49.78	-9.53	74.00	-33.75	400	103 Peak	Vertical	
2	7320.00	46.76	54.13	-7.37	54.00	-2.24	100	226 Average	Vertical	
3	7320.00	56.50	63.87	-7.37	74.00	-17.50	100	226 Peak	Vertical	
4	12280.00	43.64	43.66	-0.02	54.00	-10.36	110	33 Average	Vertical	
5	12280.00	54.21	54.23	-0.02	74.00	-19.79	110	33 Peak	Vertical	

**IEEE802.15.4**

**High Channel (Horizontal)**

**High Channel (Vertical)**



TUV Rheinland Taiwan Ltd.  
No. 438-18, Sec 2, Fenliao, Linkou Dist., New Taipei City 244, Taiwan(R.O.C.)  
Tel: +886-2172-1010 Fax: +886-2172-1322



TUV Rheinland Taiwan Ltd.  
No. 438-18, Sec 2, Fenliao, Linkou Dist., New Taipei City 244, Taiwan(R.O.C.)  
Tel: +886-2172-1010 Fax: +886-2172-1322

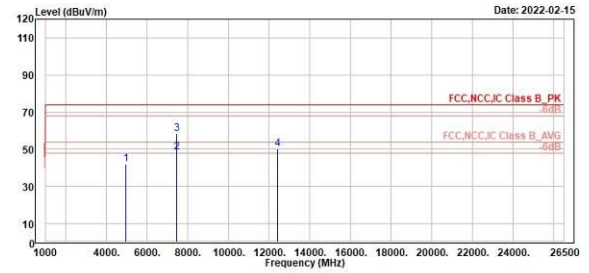
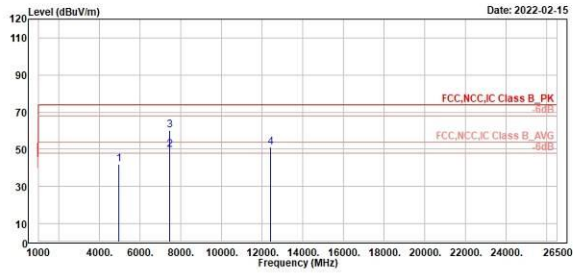

Freq	Level	Read Level	Factor	Limit Line	Over Limit	APos	TPos	Remark	Pol/Phase	Note
MHz	dBuV/m	dBuV	dB/m	dBuV/m	dB	cm	deg			
1	4960.00	42.16	51.70	-9.54	74.00	-31.84	490	358 Peak	Horizontal	
2	7440.00	49.81	57.16	-7.35	54.00	-4.19	195	77 Average	Horizontal	
3	7440.00	60.24	67.59	-7.35	74.00	-13.76	105	77 Peak	Horizontal	
4	12400.00	51.01	50.69	0.32	74.00	-22.99	100	310 Peak	Horizontal	

Freq	Level	Read Level	Factor	Limit Line	Over Limit	APos	TPos	Remark	Pol/Phase	Note
MHz	dBuV/m	dBuV	dB/m	dBuV/m	dB	cm	deg			
1	4960.00	42.15	51.69	-9.54	74.00	-31.85	300	49 Peak	Vertical	
2	7440.00	48.28	55.63	-7.35	54.00	-5.72	100	209 Average	Vertical	
3	7440.00	58.62	65.97	-7.35	74.00	-15.38	100	209 Peak	Vertical	
4	12400.00	50.34	50.02	0.32	74.00	-23.66	100	345 Peak	Vertical	

**Mains Conducted Emission, 150kHz ~ 30MHz**
**Worst Band**
**(Line)**
**(Neutral)**

TÜV Rheinland Taiwan Ltd.  
No. 458-18, Sec. 2, Fenhiao, Linkou Dist., New Taipei City 244, Taiwan (R.O.C.)  
Tel: +886-2112-1000 Fax: +886-2112-1322

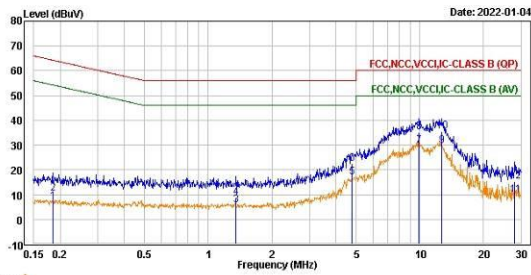

Trace: 1

Line	Freq	Level	Read Level	Factor	Limit	Over	Remark	Pol/Phase	Note
	MHz	dBuV	dBuV	dB	dBuV	dB			
1	0.18	7.11	-2.50	9.61	54.30	-47.19	Average	line1	
2	0.18	10.42	0.81	9.61	64.30	-53.88	QP	line1	
3	1.35	5.73	-3.91	9.64	46.00	-40.27	Average	line1	
4	1.35	8.66	-0.98	9.64	56.00	-47.34	QP	line1	
5	4.79	17.08	7.39	9.69	46.00	-28.92	Average	line1	
6	4.79	22.65	12.96	9.69	56.00	-33.35	QP	line1	
7	9.92	29.77	20.04	9.73	50.00	-20.23	Average	line1	
8	9.92	35.18	25.45	9.73	60.00	-24.82	QP	line1	
9	12.73	29.82	20.09	9.73	50.00	-20.18	Average	line1	
10	12.73	35.66	25.93	9.73	60.00	-24.34	QP	line1	
11	28.12	9.86	0.21	9.65	50.00	-40.14	Average	line1	
12	28.12	15.34	5.69	9.65	60.00	-44.66	QP	line1	



TÜV Rheinland Taiwan Ltd.  
No. 458-18, Sec. 2, Fenhiao, Linkou Dist., New Taipei City 244, Taiwan (R.O.C.)  
Tel: +886-2112-1000 Fax: +886-2112-1322

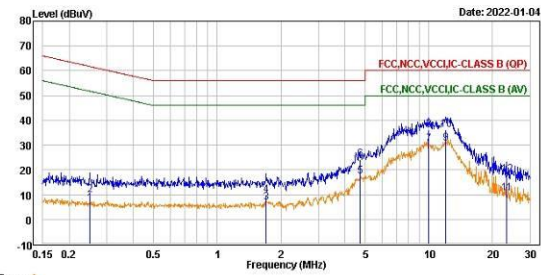

Trace: 1

Line	Freq	Level	Read Level	Factor	Limit	Over	Remark	Pol/Phase	Note
	MHz	dBuV	dBuV	dB	dBuV	dB			
1	0.25	6.44	-3.15	9.59	51.78	-45.34	Average	neutral	
2	0.25	9.70	0.11	9.59	61.78	-52.08	QP	neutral	
3	1.71	6.64	-2.98	9.62	46.00	-39.36	Average	neutral	
4	1.71	10.02	0.40	9.62	56.00	-45.98	QP	neutral	
5	4.74	17.43	7.75	9.68	46.00	-28.57	Average	neutral	
6	4.74	24.18	14.50	9.68	56.00	-31.82	QP	neutral	
7	10.02	30.44	20.70	9.74	50.00	-19.56	Average	neutral	
8	10.02	36.32	26.58	9.74	60.00	-23.68	QP	neutral	
9	11.99	30.78	21.02	9.76	50.00	-19.22	Average	neutral	
10	11.99	36.27	26.51	9.76	60.00	-23.73	QP	neutral	
11	23.27	10.68	0.86	9.82	50.00	-39.32	Average	neutral	
12	23.27	17.92	8.10	9.82	60.00	-42.08	QP	neutral	