



RADIO TEST REPORT

Test Report No. : 11707914M-A-R1

Applicant : TAIYO YUDEN CO., LTD.
Type of Equipment : Bluetooth Smart / ANT Module
Model No. : EYSHCN
FCC ID : RYYEYSHCN
Test regulation : FCC Part 15 Subpart C: 2015
(Class II Permissive change)
Test Result : Complied

1. This test report shall not be reproduced in full or partial, without the written approval of UL Japan, Inc.
2. The results in this report apply only to the sample tested.
3. This sample tested is in compliance with the above regulation.
4. The test results in this report are traceable to the national or international standards.
5. The opinions and the interpretations to the result of the description in this report are outside scopes where UL Japan has been accredited.
6. This test report covers Radio technical requirements. It does not cover administrative issues such as Manual or non-Radio test related Requirements. (if applicable)
7. This report is a revised version of 11707914M-A.

Date of test: April 5 – April 22, 2017

Representative test operator:

Hiromitsu Tanabe
Engineer
Consumer Technology Division

Approved by :

Tomoyuki Yamashita
Engineer
Consumer Technology Division



- The testing in which "Non-accreditation" is displayed is outside the accreditation scopes in UL Japan.
 There is no testing item of "Non-accreditation"

UL Japan, Inc.

Kashima EMC Lab.

1614, Mushihata, Katori-shi, Chiba-ken, 289-0341 Japan
Telephone : +81 478 88 6500
Facsimile : +81 478 82 3373

CONTENTS	PAGE
SECTION 1: Customer information.....	4
SECTION 2: Equipment under test (E.U.T.).....	4
SECTION 3: Test specification, procedures & results.....	6
SECTION 4: Operation of E.U.T. during testing.....	8
SECTION 5: Conducted Emission.....	10
SECTION 6: Radiated Spurious Emission	11
SECTION 7: Antenna Terminal Conducted Tests.....	13
APPENDIX 1: Test data	14
Conducted Emission	14
6dB Bandwidth	16
Maximum Peak Output Power	17
Average Output Power	18
Radiated Spurious Emission	20
Conducted Spurious Emission	26
Power Density	29
99%Occupied Bandwidth	30
APPENDIX 2: Test instruments	31
APPENDIX 3: Photographs of test setup	33
Conducted Emission	33
Radiated Spurious Emission	34
Worst Case Position (Horizontal: X-axis/ Vertical:Y-axis, Z-axis).....	35

SECTION 1: Customer information

Company Name : TAIYO YUDEN CO., LTD.
Address : 8-1 Sakaecho, Takasaki-Shi, Gunma, 370-8522, Japan
Telephone Number : +81- 27-324-2313
Facsimile Number : +81- 27-324-2314
Contact Person : Mitsuo Takagi

SECTION 2: Equipment under test (E.U.T.)

2.1 Identification of E.U.T.

Type of Equipment : Bluetooth Smart / ANT Module
Model No. : EYSHCN
Serial No. : Refer to Section 4, Clause 4.2
Rating : DC 3 V, 1.7-3.6 V, 0.02 A, 0.1W
Receipt Date of Sample : March 30, 2017
Country of Mass-production : Japan
Condition of EUT : Engineering prototype
(Not for Sale: This sample is equivalent to mass-produced items.)
Modification of EUT : No Modification by the test lab

2.2 Product Description

General Specification

Model: EYSHCN (referred to as the EUT in this report) is a Bluetooth Smart / ANT Module.

Clock frequency(ies) in the system : 32 MHz, 32.768 kHz

Radio Specification

<Bluetooth(BT) Low Energy (LE)>

Radio Type : Transceiver
Frequency of Operation : 2402 MHz - 2480 MHz
Modulation : GFSK
Power Supply (radio part input) : DC 1.3 V
Antenna type : Monopole Antenna
Antenna Gain : +0.9 dBi

<Bluetooth (Ver. 5.0)>

Radio Type : Transceiver
Frequency of Operation : 2402 MHz - 2480 MHz
Modulation : GFSK
Power Supply (radio part input) : DC 1.3 V
Antenna type : Monopole Antenna
Antenna Gain : +0.9 dBi

<ANT>

Radio Type : Transceiver
Frequency of Operation : 2402 MHz - 2480 MHz
Modulation : GFSK
Power Supply (radio part input) : DC 1.3 V
Antenna type : Monopole Antenna
Antenna Gain : +0.9 dBi

<Nordic Original>

Radio Type : Transceiver
Frequency of Operation : 2402 MHz - 2480 MHz
Modulation : GFSK
Power Supply (radio part input) : DC 1.3 V
Antenna type : Monopole Antenna
Antenna Gain : +0.9 dBi

SECTION 3: Test specification, procedures & results

3.1 Test Specification

Test Specification : FCC Part 15 Subpart C
FCC Part 15 final revised on November 14, 2016 and effective December 14, 2016

Title : FCC 47CFR Part15 Radio Frequency Device Subpart C Intentional Radiators
Section 15.207 Conducted limits
Section 15.247 Operation within the bands 902-928MHz,
2400-2483.5MHz, and 5725-5850MHz

3.2 Procedures and results

Item	Test Procedure	Specification	Worst margin	Results	Remarks
Conducted Emission	FCC: ANSI C63.10-2013 6. Standard test methods ISED: RSS-Gen 8.8	FCC: Section 15.207 ISED: RSS-Gen 8.8	QP 17.6 dB, 11.72475 MHz, L AV 14.5 dB, 0.44032 MHz, N	Complied	-
6dB Bandwidth	FCC: KDB 558074 D01 DTS Meas Guidance v04 ISED: -	FCC: Section 15.247(a)(2) ISED: RSS-247 5.2(a)	See data.	Complied	Conducted
Maximum Peak Output Power	FCC: KDB 558074 D01 DTS Meas Guidance v04 ISED: RSS-Gen 6.12	FCC: Section 15.247(b)(3) ISED: RSS-247 5.4(d)		Complied	Conducted
Power Density	FCC: KDB 558074 D01 DTS Meas Guidance v04 ISED: -	FCC: Section 15.247(e) ISED: RSS-247 5.2(b)		Complied	Conducted
Spurious Emission Restricted Band Edges	FCC: KDB 558074 D01 DTS Meas Guidance v04 ISED: RSS-Gen 6.13	FCC: Section15.247(d) ISED: RSS-247 5.5 RSS-Gen 8.9 RSS-Gen 8.10	4.6 dB 2530.000 MHz, AV, Hori.	Complied	Conducted (below 30 MHz)/ Radiated (above 30 MHz) *1)

Note: UL Japan, Inc.'s EMI Work Procedures No. 13-EM-W0420 and 13-EM-W0422.
*1) Radiated test was selected over 30 MHz based on section 15.247(d) and KDB 558074 D01 DTS Meas Guidance v04 12.2.7.

* In case any questions arise about test procedure, ANSI C63.10: 2013 is also referred.

FCC Part 15.31 (e)

This EUT provides stable voltage (DC 1.3 V) constantly to RF Module regardless of input voltage. Therefore, this EUT complies with the requirement.

FCC Part 15.203/212 Antenna requirement

It is impossible for end users to replace the antenna, because the antenna is mounted inside of the EUT. Therefore, the equipment complies with the antenna requirement of Section 15.203/212.

3.3 Addition to standard

Item	Test Procedure	Specification	Worst margin	Results	Remarks
99% Occupied Bandwidth	ISED: RSS-Gen 6.6	ISED: -	N/A	-	Conducted

Other than above, no addition, exclusion nor deviation has been made from the standard.

UL Japan, Inc.

Kashima EMC Lab.

1614, Mushihata, Katori-shi, Chiba-ken, 289-0341 Japan

Telephone : +81 478 88 6500

Facsimile : +81 478 82 3373

3.4 Uncertainty

EMI

The following uncertainties have been calculated to provide a confidence level of 95 % using a coverage factor $k = 2$.

Kashima EMC Lab.

Item	Frequency range	Uncertainty (+/-)
Radiated emission (Measurement distance: 3m)	30MHz - 300MHz	4.7dB
	300MHz - 1GHz	3.6dB
	1GHz - 13GHz	5.1dB
Radiated emission (Measurement distance: 1m)	13GHz - 18GHz	5.7dB
	18GHz - 26.5GHz	5.1dB

Antenna terminal test	Uncertainty (+/-)
Power Measurement above 1GHz	0.7dB
Spurious emission (Conducted) below 1GHz	1.6dB
Spurious emission (Conducted) 1GHz - 3GHz	1.4dB
Spurious emission (Conducted) 3GHz - 18GHz	2.8dB
Spurious emission (Conducted) 18GHz - 26.5GHz	2.5dB
Bandwidth Measurement	5.4%

Conducted Emission test

The data listed in this test report has enough margin, more than the site margin.

Radiated emission test

The data listed in this report meets the limits unless the uncertainty is taken into consideration.

3.5 Test Location

UL Japan, Inc. Kashima EMC Lab.

1614 Mushihata, Katori-shi, Chiba-ken, 289-0341 JAPAN

Telephone: +81 478 88 6500, Facsimile: +81 478 82 3373

JAB Accreditation No. : RTL02610

Test site	ISED Registration Number	Width x Depth x Height (m)	Size of reference ground plane (m) / horizontal conducting plane	Maximum measurement distance
No.1 Open site	4659A-1	6.0 x 5.5 x 2.5	20 x 40	10 m
No.2 Open site	4659A-2	4.4 x 4.4 x 2.15	18 x 20	10 m
No.5 Open site	4659A-5	8.6 x 7.1 x 2.4	18 x 23	10 m
No.1 Shielded room	4659A-1	5.4 x 4.5 x 2.3	-	-
No.2 Shielded room	4659A-2	3.6 x 2.7 x 2.3	-	-
No.3 Shielded room	-	5.4 x 3.6 x 2.3	-	-
No.4 Shielded Room	-	6.1 x 6.1 x 3.1	-	-
No.5 Shielded Room	4659A-5	4.2 x 3.1 x 2.5	-	-
No.3 Fully Anechoic Chamber	-	7.0 x 3.5 x 3.5	-	-
No.6 Semi-anechoic Chamber	4659A-6	8.5 x 5.5 x 5.2	-	3 m
No.10 Semi-anechoic Chamber	4659A-10	18.4 x 9.9 x 7.7	-	10 m
No.11 Semi-anechoic Chamber	4659A-7	9.0 x 6.5 x 5.2	-	3 m
No.1 Measurement room	-	5.0 x 3.7 x 2.6	-	-
No.2 Measurement room	-	4.3 x 4.4 x 2.7	-	-
No.3 Measurement room	-	4.3 x 4.4 x 2.7	-	-

3.6 Test data, Test instruments, and Test set up

Refer to APPENDIX.

UL Japan, Inc.

Kashima EMC Lab.

1614, Mushihata, Katori-shi, Chiba-ken, 289-0341 Japan

Telephone : +81 478 88 6500

Facsimile : +81 478 82 3373

SECTION 4: Operation of E.U.T. during testing

4.1 Operating Mode(s)

Mode	Remarks*
Bluetooth(BT) Low Energy (LE)	Maximum Packet Size, PRBS9
<p>*Power of the EUT was set by the software as follows; Power settings: +4dBm, -40dBm Software: ANT_TEST_tool-52 *This setting of software is the worst case. Any conditions under the normal use do not exceed the condition of setting. In addition, end users cannot change the settings of the output power of the product.</p>	

*The details of Operating mode(s)

Test Item	Operating Mode	Tested frequency
Conducted Emission	BT LE Tx (2 MHz)	2402 MHz
Spurious Emission (Radiated)		2440 MHz
Spurious Emission (Conducted)		2480 MHz
6dB Bandwidth		
Maximum Peak Output Power		
Power Density		
99% Occupied Bandwidth		

4.2 Configuration and peripherals

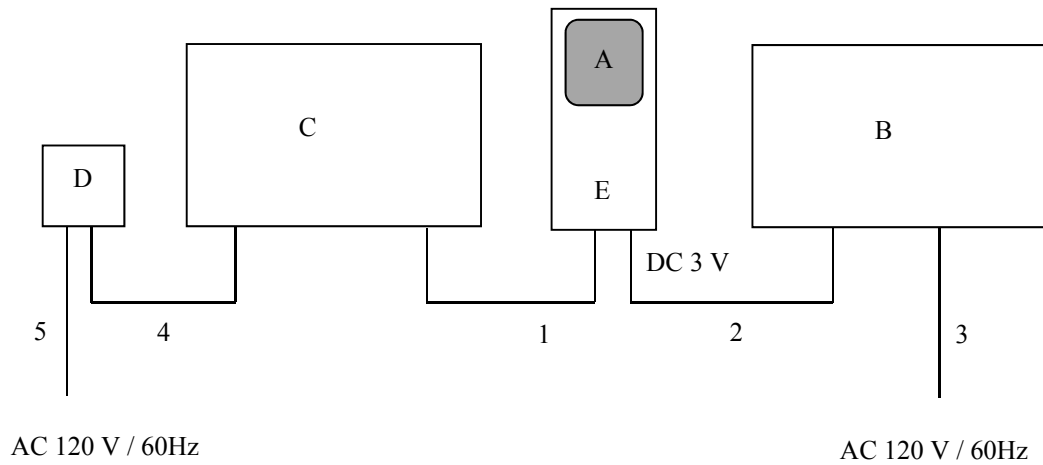

* Cabling and setup(s) were taken into consideration and test data was taken under worst case conditions.

Description of EUT

No.	Item	Model number	Serial number	Manufacturer	Remarks
A	Bluetooth Smart / ANT Module	EYSHCN	1 *1) 2 *2)	TAIYO YUDEN	EUT
B	DC Power Supply	GSV3000	1303141419	DIAMOND ANTENNA	-
C	PC	CF-T2	4CKSA46826	Panasonic	-
D	AC Adaptor	CF-AA1625A	1625AM406Z21913F	Panasonic	-
E	Evaluation Board	EBSHCNZXZ	1 *1) 2 *2)	TAIYO YUDEN	-

*1) Used for Antenna Terminal conducted tests

*2) Used for Conducted Emission and Radiated Spurious Emission tests

List of cables used

No.	Name	Length (m)	Shield		Remarks
			Cable	Connector	
1	USB Cable	1.8	Shielded	Shielded	-
2	DC Cable	0.5 + 1.5	Unshielded	Unshielded	-
3	AC Cable	1.7	Unshielded	Unshielded	-
4	DC Cable	1.2	Unshielded	Unshielded	-
5	AC Cable	0.8	Unshielded	Unshielded	-

UL Japan, Inc.

Kashima EMC Lab.

1614, Mushihata, Katori-shi, Chiba-ken, 289-0341 Japan

Telephone : +81 478 88 6500

Facsimile : +81 478 82 3373

SECTION 5: Conducted Emission

Test Procedure and conditions

EUT was placed on a wooden table of nominal size, 1.0 m by 1.5 m, raised 0.8 m above the conducting ground plane. The rear of tabletop was located 40 cm to the vertical conducting plane. The rear of EUT, including peripherals aligned and flushed with rear of tabletop. All other surfaces of tabletop were at least 80cm from any other grounded conducting surface. EUT was located 80 cm from a Line Impedance Stabilization Network (LISN) / Artificial mains Network (AMN) and excess AC cable was bundled in center.

For the tests on EUT with other peripherals (as a whole system)

I/O cables that were connected to the peripherals were bundled in center. They were folded back and forth forming a bundle 30 cm to 40 cm long and were hanged at a 40 cm height to the ground plane. All unused 50ohm connectors of the LISN (AMN) were resistivity terminated in 50 ohm when not connected to the measuring equipment.

The AC Mains Terminal Continuous disturbance Voltage has been measured with the EUT in a Semi Anechoic Chamber.

The EUT was connected to a LISN (AMN).

An overview sweep with peak detection has been performed.

The test results and limit are rounded off to one decimal place, so some differences might be observed.

Detector	: QP and CISPR AV
Measurement range	: 0.15 MHz – 30 MHz
Test data	: APPENDIX
Test result	: Pass

SECTION 6: Radiated Spurious Emission

Test Procedure

It was measured based on "11.0 Emissions in non-restricted frequency bands" of "558074 D01 DTS Meas Guidance v04".

[For below 1 GHz]

EUT was placed on a urethane platform of nominal size, 0.5 m by 0.5 m, raised 0.8 m above the conducting ground plane. The Radiated Electric Field Strength has been measured in a Semi Anechoic Chamber with a ground plane.

[For above 1 GHz]

EUT was placed on a urethane platform of nominal size, 0.5 m by 0.5 m, raised 1.5 m above the conducting ground plane.

The Radiated Electric Field Strength has been measured in a Semi Anechoic Chamber with absorbent materials lined on a ground plane.

The height of the measuring antenna varied between 1 and 4 m and EUT was rotated a full revolution in order to obtain the maximum value of the electric field strength.

The measurements were performed for both vertical and horizontal antenna polarization with the Test Receiver, or the Spectrum Analyzer.

The measurements were made with the following detector function of the test receiver and the Spectrum analyzer (in linear mode).

The test was made with the detector (RBW/VBW) in the following table.

When using Spectrum analyzer, the test was made with adjusting span to zero by using peak hold.

Test Antennas are used as below;

Frequency	Below 1 GHz	Above 1 GHz
Antenna Type	Hybrid	Horn

In any 100 kHz bandwidth outside the restricted band in which the spread spectrum intentional radiator is operating, the radio frequency power that is produced by the intentional radiator confirmed 20 dB below that in the 100 kHz bandwidth within the band that contains the highest level of the desired power, based on a radiated measurement.

20 dBc was applied to the frequency over the limit of FCC 15.209 / Table 4 of RSS-Gen 8.9(IC) and outside the restricted band of FCC15.205 / Table 6 of RSS-Gen 8.10 (IC).

Frequency	Below 1 GHz	Above 1 GHz		20 dBc
Instrument used	Test Receiver	Spectrum Analyzer		Spectrum Analyzer
Detector	QP	PK	AV *3)	PK
IF Bandwidth	BW 120 kHz	RBW: 1 MHz VBW: 3 MHz	Average Power Method: RBW: 1 MHz VBW: 3 MHz Detector: Power Averaging (RMS) Trace: 100 traces If duty cycle was less than 98%, a duty factor was added to the results.	RBW: 100 kHz VBW: 300kHz
Test Distance	3.0 m	4.5 m *1) (1 GHz - 10 GHz), 1.0 m *2) (10 GHz - 26.5 GHz)		4.5 m *1) (1 GHz - 10 GHz), 1.0 m *2) (10 GHz - 26.5 GHz)

*1) Distance Factor: $20 \times \log(4.5 \text{ m} / 3.0 \text{ m}) = 3.5 \text{ dB}$

*2) Distance Factor: $20 \times \log(1.0 \text{ m} / 3.0 \text{ m}) = -9.5 \text{ dB}$

*3) Average Power Measurement was performed based on 6.0 & 12.2.5 of "KDB 558074 D01 DTS Meas Guidance v04".

UL Japan, Inc.

Kashima EMC Lab.

1614, Mushihata, Katori-shi, Chiba-ken, 289-0341 Japan

Telephone : +81 478 88 6500

Facsimile : +81 478 82 3373

- The carrier level and noise levels were confirmed at each position of X, Y and Z axes of EUT to see the position of maximum noise, and the test was made at the position that has the maximum noise.

The test results and limit are rounded off to one decimal place, so some differences might be observed.

Measurement range : 30 MHz - 26.5 GHz
Test data : APPENDIX
Test result : Pass

SECTION 7: Antenna Terminal Conducted Tests

Test Procedure

The tests were made with below setting connected to the antenna port.

Test	Span	RBW	VBW	Sweep time	Detector	Trace	Instrument used
6dB Bandwidth	10 MHz	100 kHz	300 kHz	Auto	Peak	Max Hold	Spectrum Analyzer
99% Occupied Bandwidth *1)	Enough width to display emission skirts	1 to 5 % of OBW	Three times of RBW	Auto	Peak	Max Hold	Spectrum Analyzer
Maximum Peak Output Power	-	-	-	Auto	Peak/ Average *2)	-	Power Meter (Sensor: 160 MHz BW) Spectrum Analyzer *5)
Peak Power Density	1.5 times the 6dB Bandwidth	3 kHz	9.1 kHz	Auto	Peak	Max Hold	Spectrum Analyzer *3)
Conducted Spurious Emission *5)	9kHz to 150kHz	200 Hz	620 Hz	Auto	Peak	Max Hold	Spectrum Analyzer
	150kHz to 30MHz	10 kHz	30 kHz				

*1) Peak hold was applied as Worst-case measurement.

*2) Reference data

*3) Section 10.2 Method PKPSD (peak PSD) of "KDB 558074 D01 DTS Meas Guidance v04".

*4) In the frequency range below 30MHz, RBW was narrowed to separate the noise contents.

Then, wide-band noise near the limit was checked separately, however the noise was low enough as shown in the chart.

(9 kHz - 150 kHz: RBW = 200 Hz, 150 kHz - 30 MHz: RBW = 10 kHz).

*5) The setting of spectrum Analyzer used KDB 558074 D01 DTS Meas Guidance v04 Section 9.2.2.4 Method AVGSA-2.

The test results and limit are rounded off to two decimals place, so some differences might be observed.

Test data : **APPENDIX**
Test result : **Pass**

UL Japan, Inc.

Kashima EMC Lab.

1614, Mushihata, Katori-shi, Chiba-ken, 289-0341 Japan

Telephone : +81 478 88 6500

Facsimile : +81 478 82 3373

APPENDIX 1: Test data

Conducted Emission

DATA OF CONDUCTED EMISSION TEST

UL Japan, Inc. Kashima EMC Lab. No.5 Shielded Room
Date : 2017/04/09

Mode : Tx, BT LE (2MHz), 2402MHz
Order No. : 11707914M
Power : DC 3V (AC 120/60Hz)
Temp./Humi. : 22deg.C / 54%RH

Limit1 : FCC 15C (15.207) QP
Limit2 : FCC 15C (15.207) AV

Tested by : Kazuaki Suzuki

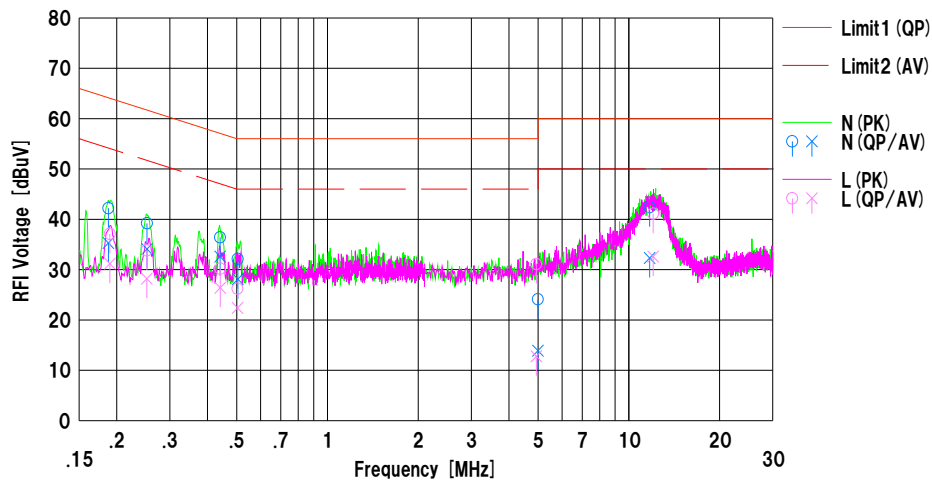

No.	Freq. [MHz]	Reading		C.Fac	Results		Limit		Margin		Phase	Comment
		<QP> [dBuV]	<AV> [dBuV]		<QP> [dBuV]	<AV> [dBuV]	<QP> [dBuV]	<AV> [dBuV]	<QP> [dB]	<AV> [dB]		
1	0.18762	32.1	25.2	10.1	42.2	35.3	64.1	54.1	21.9	18.8	N	
2	0.25202	29.0	23.9	10.2	39.2	34.1	61.7	51.7	22.5	17.6	N	
3	0.44032	26.2	22.4	10.2	36.4	32.6	57.1	47.1	20.7	14.5	N	
4	0.50450	21.9	17.9	10.2	32.1	28.1	56.0	46.0	23.9	17.9	N	
5	4.99001	13.5	3.3	10.6	24.1	13.9	56.0	46.0	31.9	32.1	N	
6	11.72475	31.3	21.2	11.1	42.4	32.3	60.0	50.0	17.6	17.7	N	
7	0.18972	27.0	21.1	10.1	37.1	31.2	64.0	54.0	26.9	22.8	L	
8	0.25150	23.6	18.0	10.2	33.8	28.2	61.7	51.7	27.9	23.5	L	
9	0.44085	20.0	16.2	10.2	30.2	26.4	57.0	47.0	26.8	20.6	L	
10	0.50280	16.0	12.2	10.2	26.2	22.4	56.0	46.0	29.8	23.6	L	
11	4.93420	20.5	2.2	10.6	31.1	12.8	56.0	46.0	24.9	33.2	L	
12	12.04350	30.0	21.5	11.1	41.1	32.6	60.0	50.0	18.9	17.4	L	

Calculation:Result [dBuV] =Reading [dBuV] +C.Fac (LISN+Cable+ATT) [dB]
LISN:CLS-11

UL Japan, Inc.

Kashima EMC Lab.

1614, Mushihata, Katori-shi, Chiba-ken, 289-0341 Japan

Telephone : +81 478 88 6500

Facsimile : +81 478 82 3373

Conducted Emission

Test place : Kashima EMC Lab. No.5 Shielded Room
Report No. : 11707914M-A
Date : April 9, 2015
Temperature / Humidity : 22 deg. C / 54 % RH
Engineer : Kazuaki Suzuki
Mode : Tx BT LE (2 MHz)

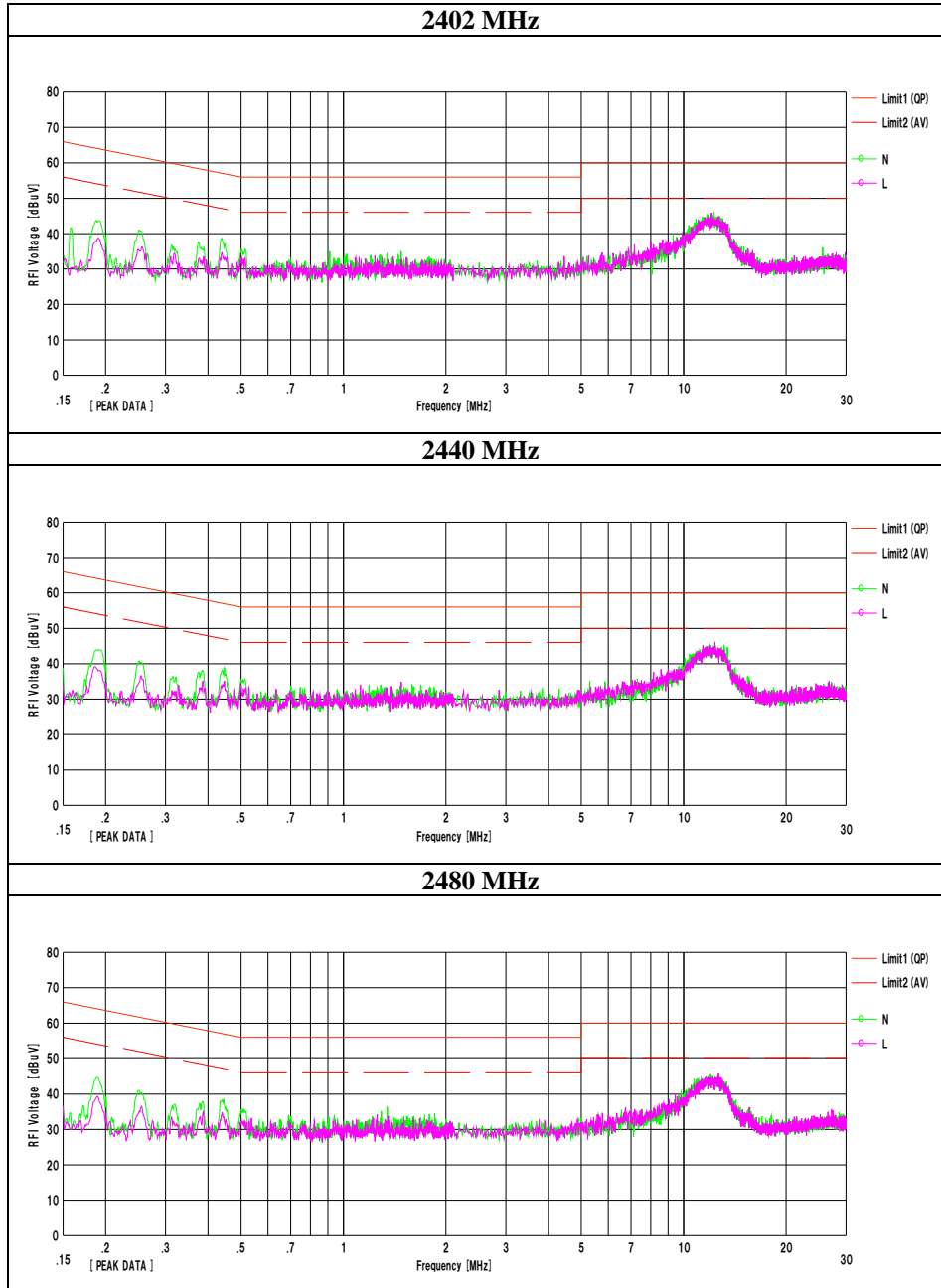

6dB Bandwidth

Test place	Kashima EMC Lab. No.2 Measurement Room
Report No.	11707914M-A
Date	April 5, 2017
Temperature / Humidity	21 deg. C / 46 % RH
Engineer	Hiromitsu Tanabe
Mode	Tx BT LE (2 MHz)

Mode	Frequency [MHz]	6dB Bandwidth [MHz]	Limit [kHz]
BT LE	2402	1.183	> 500
	2440	1.214	> 500
	2480	1.254	> 500

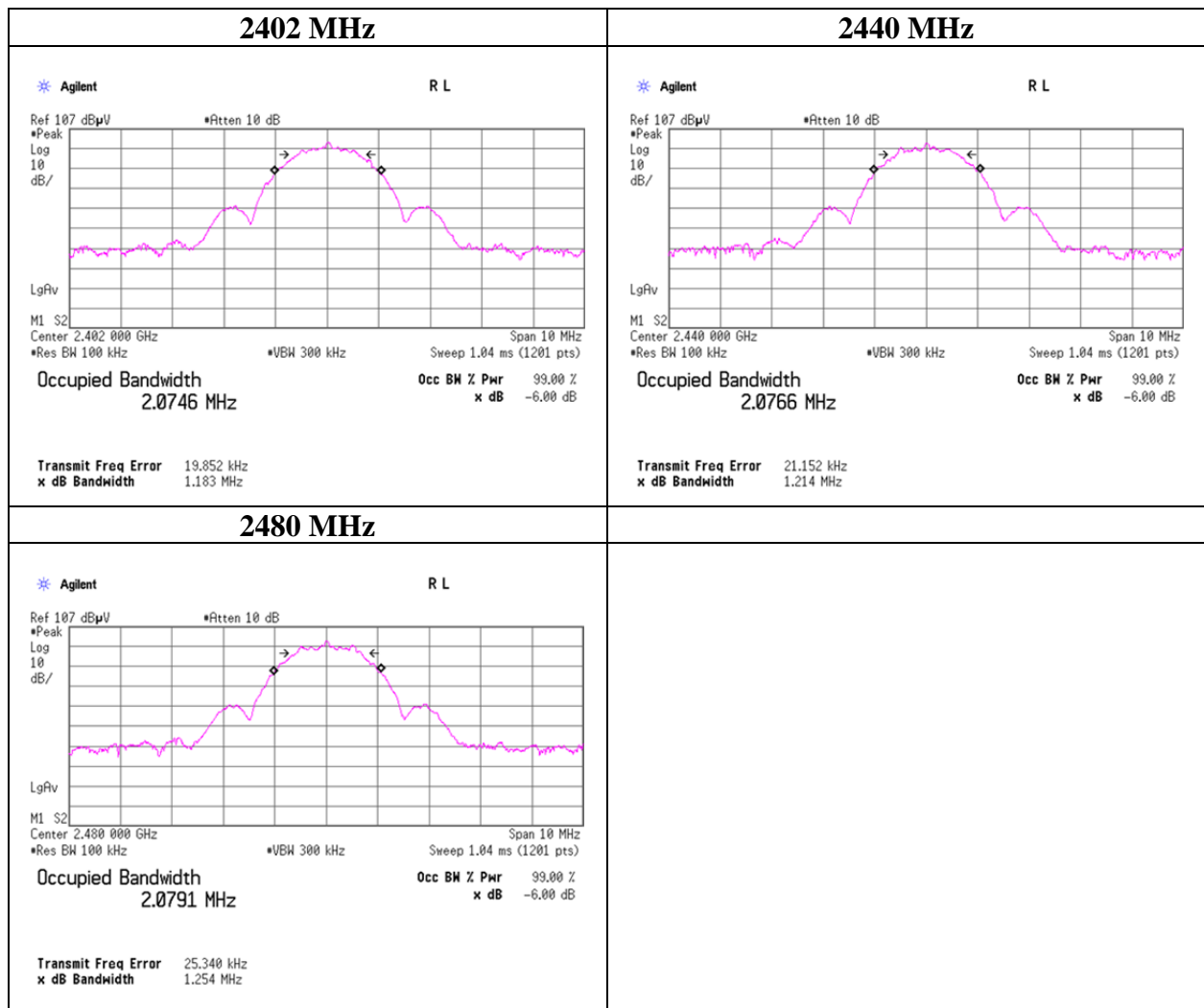

Maximum Peak Output Power

Test place : Kashima EMC Lab. No.2 Measurement Room
Report No. : 11707914M-A
Date : April 5, 2017
Temperature / Humidity : 21 deg. C / 46 % RH
Engineer : Hiromitsu Tanabe
Mode : Tx BT LE (2 MHz)

+4dBm setting

Freq. [MHz]	Reading [dBm]	Cable Loss [dB]	Atten. Loss [dB]	Result		Limit		Margin [dB]
				[dBm]	[mW]	[dBm]	[mW]	
2402	-6.88	1.51	10.04	4.67	2.93	30.00	1000	25.33
2440	-6.96	1.51	10.04	4.59	2.88	30.00	1000	25.41
2480	-7.05	1.52	10.04	4.51	2.82	30.00	1000	25.49

-40dBm setting

Freq. [MHz]	Reading [dBm]	Cable Loss [dB]	Atten. Loss [dB]	Result		Limit		Margin [dB]
				[dBm]	[mW]	[dBm]	[mW]	
2402	-50.38	1.51	10.04	-38.83	0.00013	30.00	1000	68.83
2440	-50.53	1.51	10.04	-38.98	0.00013	30.00	1000	68.98
2480	-50.64	1.52	10.04	-39.08	0.00012	30.00	1000	69.08

Sample Calculation:

Result = Reading + Cable Loss (including the cable(s) customer supplied) + Attenuator Loss

*The equipment and cables were not used for factor 0 dB of the data sheets.

Average Output Power
(Reference data)

Test place Kashima EMC Lab. No.2 Measurement Room
Report No. 11707914M-A
Date April 5, 2017
Temperature / Humidity 21 deg. C / 46 % RH
Engineer Hiromitsu Tanabe
Mode Tx BT LE (2 MHz)

+4dBm setting

Freq. [MHz]	Reading [dBm]	Cable Loss [dB]	Atten. Loss [dB]	Result (Time average)		Duty factor [dB]	Result (Burst power average)	
				[dBm]	[mW]		[dBm]	[mW]
2402	-7.59	1.51	10.04	3.96	2.49	0.44	4.40	2.75
2440	-7.65	1.51	10.04	3.90	2.45	0.44	4.34	2.72
2480	-7.77	1.52	10.04	3.79	2.39	0.44	4.23	2.65

-40dBm setting

Freq. [MHz]	Reading [dBm]	Cable Loss [dB]	Atten. Loss [dB]	Result (Time average)		Duty factor [dB]	Result (Burst power average)	
				[dBm]	[mW]		[dBm]	[mW]
2402	-51.62	1.51	10.04	-40.07	0.00	0.44	-39.63	0.00011
2440	-51.67	1.51	10.04	-40.12	0.00	0.44	-39.68	0.00011
2480	-51.75	1.52	10.04	-40.19	0.00	0.44	-39.75	0.00011

Sample Calculation:

Result (Time average) = Reading + Cable Loss (including the cable(s) customer supplied) + Attenuator Loss

Result (Burst power average) = Time average + Duty factor

*The equipment and cables were not used for factor 0 dB of the data sheets.

Burst rate confirmation

Test place	Kashima EMC Lab. No.2 Measurement Room
Report No.	11707914M-A
Date	April 5, 2015
Temperature / Humidity	21 deg. C / 46 % RH
Engineer	Hiromitsu Tanabe
Mode	Tx BT LE (2 MHz)

BT LE (2MHz)

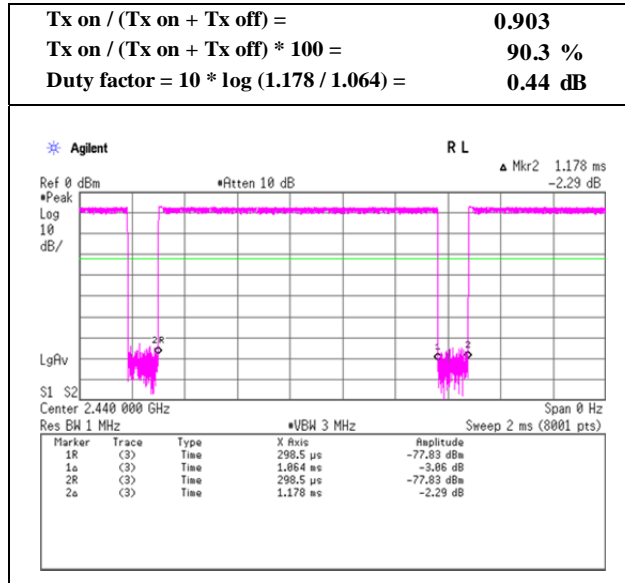

* Since the burst rate is not different between the channels, the data has been obtained on the representative channel.

Radiated Spurious Emission

Test place Kashima EMC Lab. No.10 Semi Anechoic Chamber (1-26GHz)
 Kashima EMC Lab. No.10 Semi Anechoic Chamber (30-1000MHz)
Report No. 11707914M-A
Date April 6, 2017 April 5, 2017
Temperature / Humidity 22 deg. C / 40 % RH 21 deg. C / 41 % RH
Engineer Hiromitsu Tanabe Hiromitsu Tanabe
 (30-1000MHz) (1-26GHz)
Mode Tx, BT LE (2MHz), 2402 MHz

(* PK: Peak, AV: Average, QP: Quasi-Peak)

Polarity	Frequency [MHz]	Detector	Reading [dBuV]	Ant.Fac. [dB/m]	Loss [dB]	Gain [dB]	Distance Factor [dB]	Result [dBuV/m]	Limit [dBuV/m]	Margin [dB]	Height [cm]	Angle [deg]	Remark
Hori.	168.207	QP	32.20	13.00	6.00	26.40	0.00	24.80	43.50	18.7	169	0	
Hori.	215.966	QP	33.70	10.40	6.60	26.20	0.00	24.50	43.50	19.0	100	0	
Hori.	2274.000	PK	52.20	28.00	14.00	44.40	3.50	53.30	73.90	20.6	166	308	
Hori.	2390.000	PK	50.00	27.60	14.20	44.40	3.50	50.90	73.90	23.0	123	243	
Hori.	2530.000	PK	54.70	27.50	14.30	44.30	3.50	55.70	73.90	18.2	135	336	
Hori.	4804.000	PK	55.50	31.30	6.30	46.10	3.50	50.50	73.90	23.4	125	332	
Hori.	7206.000	PK	51.70	36.40	7.60	44.70	3.50	54.50	73.90	19.4	113	153	
Hori.	9608.000	PK	45.00	38.80	8.60	42.60	3.50	53.30	73.90	20.6	100	0	Floor Noise
Hori.	2274.000	AV	44.90	28.00	14.00	44.40	3.50	46.00	53.90	7.9	166	308	
Hori.	2530.000	AV	48.30	27.50	14.30	44.30	3.50	49.30	53.90	4.6	135	336	
Vert.	86.018	QP	41.50	8.20	5.10	26.70	0.00	28.10	40.00	11.9	123	206	
Vert.	120.331	QP	40.00	11.50	5.50	26.60	0.00	30.40	43.50	13.1	100	116	
Vert.	168.080	QP	35.70	13.00	6.00	26.40	0.00	28.30	43.50	15.2	100	0	
Vert.	216.483	QP	36.00	10.50	6.60	26.20	0.00	26.90	46.00	19.1	100	300	
Vert.	552.431	QP	31.40	18.70	9.30	27.50	0.00	31.90	46.00	14.1	100	210	
Vert.	2274.000	PK	51.80	28.00	14.00	44.40	3.50	52.90	73.90	21.0	157	284	
Vert.	2390.000	PK	50.00	27.60	14.20	44.40	3.50	50.90	73.90	23.0	125	275	
Vert.	2530.000	PK	53.70	27.50	14.30	44.30	3.50	54.70	73.90	19.2	153	0	
Vert.	4804.000	PK	55.50	31.30	6.30	46.10	3.50	50.50	73.90	23.4	152	0	
Vert.	7206.000	PK	51.80	36.40	7.60	44.70	3.50	54.60	73.90	19.3	100	29	
Vert.	9608.000	PK	45.00	38.80	8.60	42.60	3.50	53.30	73.90	20.6	100	0	Floor Noise
Vert.	2274.000	AV	42.50	28.00	14.00	44.40	3.50	43.60	53.90	10.3	157	284	
Vert.	2530.000	AV	45.70	27.50	14.30	44.30	3.50	46.70	53.90	7.2	153	0	

Result = Reading + Ant.Fac. + Loss (Cable+(Attenuator or Filter)(below 18 GHz)) - Gain(Amplifier) + Distance factor

Distance factor : 1 GHz - 10 GHz : 20log(4.5 m / 3.0 m) = 3.5 dB

10 GHz - 40 GHz : 20log(1.0 m / 3.0 m) = -9.5 dB

Average measurement value with duty factor

Polarity	Frequency [MHz]	Detector	Reading [dBuV]	Ant.Fac. [dB/m]	Loss [dB]	Gain [dB]	Duty Factor [dB]	Distance Factor [dB]	Result [dBuV/m]	Limit [dBuV/m]	Margin [dB]	Remark
Hori.	2390.000	AV	41.00	27.60	14.20	44.40	0.44	3.50	42.34	53.90	11.6	*1)
Hori.	4804.000	AV	46.10	31.30	6.30	46.10	0.44	3.50	41.54	53.90	12.4	
Hori.	7206.000	AV	43.30	36.40	7.60	44.70	0.44	3.50	46.54	53.90	7.4	
Hori.	9608.000	AV	37.50	38.80	8.60	42.60	0.44	3.50	46.24	53.90	7.7	Floor Noise
Vert.	2390.000	AV	40.90	27.60	14.20	44.40	0.44	3.50	42.24	53.90	11.7	*1)
Vert.	4804.000	AV	47.00	31.30	6.30	46.10	0.44	3.50	42.44	53.90	11.5	
Vert.	7206.000	AV	43.20	36.40	7.60	44.70	0.44	3.50	46.44	53.90	7.5	
Vert.	9608.000	AV	37.50	38.80	8.60	42.60	0.44	3.50	46.24	53.90	7.7	Floor Noise

Result = Reading + Ant.Fac. + Loss (Cable+(Attenuator or Filter)(below 18 GHz)) - Gain(Amplifier) + Duty factor + Distance factor

Distance factor : 1 GHz - 10 GHz : 20log(4.5 m / 3.0 m) = 3.5 dB

10 GHz - 40 GHz : 20log(1.0 m / 3.0 m) = -9.5 dB

Duty factor refer to "Duty factor Calculation chart" sheet.

*1) Not out of band emission (Leakage Power)

20 dBc Data Sheet (RBW 100 kHz, VBW 300 kHz)

Polarity	Frequency [MHz]	Detector	Reading [dBuV]	Ant.Fac. [dB/m]	Loss [dB]	Gain [dB]	Distance Factor [dB]	Result [dBuV/m]	Limit [dBuV/m]	Margin [dB]	Remark
Hori.	2402.000	PK	95.50	27.50	14.20	44.40	3.50	96.30	-	-	Carrier
Hori.	2400.000	PK	61.00	27.50	14.20	44.40	3.50	61.80	76.30	14.5	
Vert.	2402.000	PK	93.00	27.50	14.20	44.40	3.50	93.80	-	-	Carrier
Vert.	2400.000	PK	57.50	27.50	14.20	44.40	3.50	58.30	73.80	15.5	

Result = Reading + Ant.Fac. + Loss (Cable+(Attenuator or Filter)(below 18 GHz)) - Gain(Amplifier) + Distance factor

Distance factor : 1 GHz - 10 GHz : 20log(4.5 m / 3.0 m) = 3.5 dB

10 GHz - 40 GHz : 20log(1.0 m / 3.0 m) = -9.5 dB

UL Japan, Inc.

Kashima EMC Lab.

1614, Mushihata, Katori-shi, Chiba-ken, 289-0341 Japan

Telephone : +81 478 88 6500

Facsimile : +81 478 82 3373

Radiated Spurious Emission
(Reference Plot for band-edge)

Test place : Kashima EMC Lab. No.10 Semi Anechoic Chamber
Report No. : 11707914M-A
Date : April 5, 2017 April 6, 2017
Temperature / Humidity : 21 deg. C / 41 % RH 22 deg. C / 40 % RH
Engineer : Kazuhiro Ando Kazuhiro Ando
Mode : Tx, BT LE (2MHz), 2402 MHz

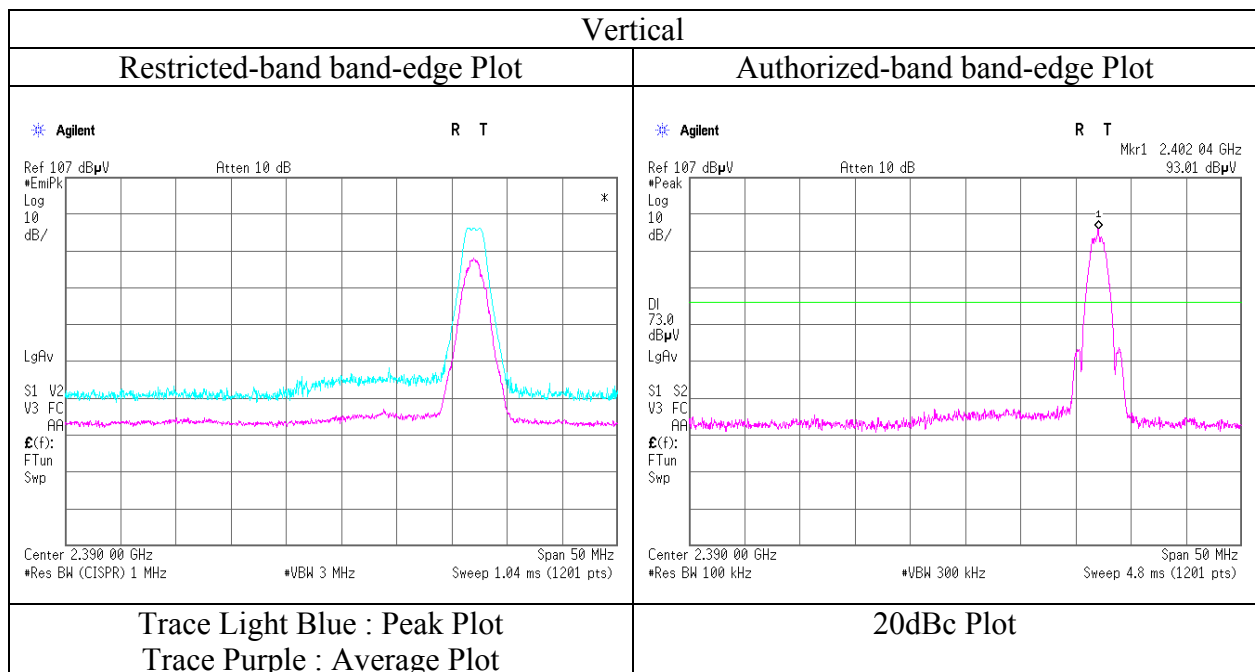
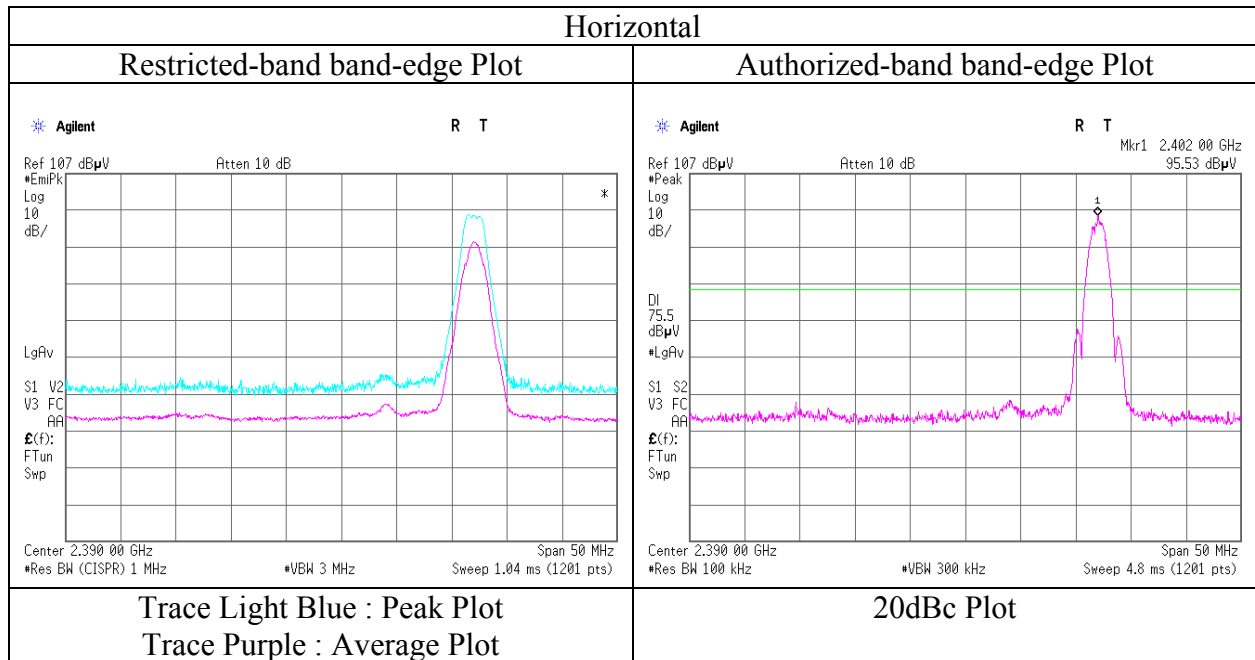

* Final result of restricted band edge was shown in tabular data.

Radiated Spurious Emission

Test place : Kashima EMC Lab. No.10 Semi Anechoic Chamber
Report No. : 11707914M-A
Date : April 5, 2017
Temperature / Humidity : 21 deg. C / 41 % RH
Engineer : Hiromitsu Tanabe
(1-26GHz)
Mode : Tx, BT LE (2MHz), 2440 MHz

(* PK: Peak, AV: Average, QP: Quasi-Peak)

Polarity	Frequency [MHz]	Detector	Reading [dBuV]	Ant.Fac. [dB/m]	Loss [dB]	Gain [dB]	Distance Factor [dB]	Result [dBuV/m]	Limit [dBuV/m]	Margin [dB]	Height [cm]	Angle [deg]	Remark
Hori.	168.207	QP	30.30	13.00	6.00	26.40	0.00	22.90	43.50	20.6	176	205	
Hori.	215.966	QP	31.00	10.40	6.60	26.20	0.00	21.80	43.50	21.7	100	0	
Hori.	2312.000	PK	51.40	27.90	14.10	44.40	3.50	52.50	73.90	21.4	162	253	
Hori.	2568.000	PK	53.90	27.60	14.30	44.30	3.50	55.00	73.90	18.9	130	303	
Hori.	4880.000	PK	55.00	31.30	6.30	46.10	3.50	50.00	73.90	23.9	100	332	
Hori.	7320.000	PK	50.80	36.30	7.70	44.40	3.50	53.90	73.90	20.0	100	15	
Hori.	9760.000	PK	45.00	39.40	8.70	42.50	3.50	54.10	73.90	19.8	100	0	Floor Noise
Hori.	2312.000	AV	43.40	27.90	14.10	44.40	3.50	44.50	53.90	9.4	162	253	
Hori.	2568.000	AV	47.30	27.60	14.30	44.30	3.50	48.40	53.90	5.5	130	303	
Vert.	86.018	QP	41.00	8.20	5.10	26.70	0.00	27.60	40.00	12.4	122	223	
Vert.	120.331	QP	39.60	11.50	5.50	26.60	0.00	30.00	43.50	13.5	100	115	
Vert.	168.080	QP	35.00	13.00	6.00	26.40	0.00	27.60	43.50	15.9	100	320	
Vert.	216.483	QP	36.00	10.50	6.60	26.20	0.00	26.90	46.00	19.1	100	300	
Vert.	552.431	QP	31.10	18.70	9.30	27.50	0.00	31.60	46.00	14.4	100	210	
Vert.	2312.000	PK	52.70	27.90	14.10	44.40	3.50	53.80	73.90	20.1	154	270	
Vert.	2568.000	PK	52.70	27.60	14.30	44.30	3.50	53.80	73.90	20.1	166	218	
Vert.	4880.000	PK	54.50	31.30	6.30	46.10	3.50	49.50	73.90	24.4	147	0	
Vert.	7320.000	PK	51.50	36.30	7.70	44.40	3.50	54.60	73.90	19.3	126	14	
Vert.	9760.000	PK	45.00	39.40	8.70	42.50	3.50	54.10	73.90	19.8	100	0	Floor Noise
Vert.	2312.000	AV	44.90	27.90	14.10	44.40	3.50	46.00	53.90	7.9	154	270	
Vert.	2568.000	AV	45.40	27.60	14.30	44.30	3.50	46.50	53.90	7.4	166	218	

Result = Reading + Ant.Fac. + Loss (Cable+(Attenuator or Filter)(below 18 GHz)) - Gain(Amplifier) + Distance factor

Distance factor : 1 GHz - 10 GHz : 20log(4.5 m / 3.0 m) = 3.5 dB

10 GHz - 40 GHz : 20log(1.0 m / 3.0 m) = -9.5 dB

Average measurement value with duty factor

Polarity	Frequency [MHz]	Detector	Reading [dBuV]	Ant.Fac. [dB/m]	Loss [dB]	Gain [dB]	Duty Factor [dB]	Distance Factor [dB]	Result [dBuV/m]	Limit [dBuV/m]	Margin [dB]	Remark
Hori.	4880.000	AV	43.30	31.30	6.30	46.10	0.44	3.50	38.74	53.90	15.2	
Hori.	7320.000	AV	42.10	36.30	7.70	44.40	0.44	3.50	45.64	53.90	8.3	
Hori.	9760.000	AV	37.00	39.40	8.70	42.50	0.44	3.50	46.54	53.90	7.4	Floor Noise
Vert.	4880.000	AV	46.30	31.30	6.30	46.10	0.44	3.50	41.74	53.90	12.2	
Vert.	7320.000	AV	43.20	36.30	7.70	44.40	0.44	3.50	46.74	53.90	7.2	
Vert.	9760.000	AV	37.00	39.40	8.70	42.50	0.44	3.50	46.54	53.90	7.4	Floor Noise

Result = Reading + Ant.Fac. + Loss (Cable+(Attenuator or Filter)(below 18 GHz)) - Gain(Amplifier) + Duty factor + Distance factor

Distance factor : 1 GHz - 10 GHz : 20log(4.5 m / 3.0 m) = 3.5 dB

10 GHz - 40 GHz : 20log(1.0 m / 3.0 m) = -9.5 dB

Duty factor refer to "Duty factor Calculation chart" sheet.

UL Japan, Inc.

Kashima EMC Lab.

1614, Mushihata, Katori-shi, Chiba-ken, 289-0341 Japan

Telephone : +81 478 88 6500

Facsimile : +81 478 82 3373

Radiated Spurious Emission

Test place : Kashima EMC Lab. No.10 Semi Anechoic Chamber
Report No. : 11707914M-A
Date : April 5, 2017
Temperature / Humidity : 21 deg. C / 41% RH
Engineer : Hiromitsu Tanabe
(1-26GHz)
Mode : Tx, BT LE (2MHz) 2480 MHz

(* PK: Peak, AV: Average, QP: Quasi-Peak)

Polarity	Frequency [MHz]	Detector	Reading [dBuV]	Ant.Fac. [dB/m]	Loss [dB]	Gain [dB]	Distance Factor [dB]	Result [dBuV/m]	Limit [dBuV/m]	Margin [dB]	Height [cm]	Angle [deg]	Remark
Hori.	168.207	QP	30.50	13.00	6.00	26.40	0.00	23.10	43.50	20.4	176	210	
Hori.	215.966	QP	31.00	10.40	6.60	26.20	0.00	21.80	43.50	21.7	100	0	
Hori.	2352.000	PK	54.10	27.70	14.10	44.40	3.50	55.00	73.90	18.9	157	249	
Hori.	2483.500	PK	54.60	27.40	14.20	44.30	3.50	55.40	73.90	18.5	111	254	
Hori.	2608.000	PK	52.70	27.60	14.30	44.30	3.50	53.80	73.90	20.1	153	301	
Hori.	4960.000	PK	54.50	31.40	6.40	46.10	3.50	49.70	73.90	24.2	150	152	
Hori.	7440.000	PK	50.80	36.60	7.70	44.20	3.50	54.40	73.90	19.5	120	335	
Hori.	9920.000	PK	45.00	39.40	8.80	42.40	3.50	54.30	73.90	19.6	100	0	Floor Noise
Hori.	2352.000	AV	47.50	27.70	14.10	44.40	3.50	48.40	53.90	5.5	157	249	
Hori.	2608.000	AV	45.60	27.60	14.30	44.30	3.50	46.70	53.90	7.2	153	301	
Vert.	86.018	QP	41.00	8.20	5.10	26.70	0.00	27.60	40.00	12.4	123	206	
Vert.	120.331	QP	39.80	11.50	5.50	26.60	0.00	30.20	43.50	13.3	100	115	
Vert.	168.080	QP	35.70	13.00	6.00	26.40	0.00	28.30	43.50	15.2	100	0	
Vert.	216.483	QP	36.00	10.50	6.60	26.20	0.00	26.90	46.00	19.1	100	300	
Vert.	552.431	QP	31.10	18.70	9.30	27.50	0.00	31.60	46.00	14.4	100	210	
Vert.	2352.000	PK	52.30	27.70	14.10	44.40	3.50	53.20	73.90	20.7	129	216	
Vert.	2483.500	PK	53.10	27.40	14.20	44.30	3.50	53.90	73.90	20.0	104	210	
Vert.	2608.000	PK	52.00	27.60	14.30	44.30	3.50	53.10	73.90	20.8	164	215	
Vert.	4960.000	PK	54.50	31.40	6.40	46.10	3.50	49.70	73.90	24.2	150	0	
Vert.	7440.000	PK	51.80	36.60	7.70	44.20	3.50	55.40	73.90	18.5	100	14	
Vert.	9920.000	PK	45.00	39.40	8.80	42.40	3.50	54.30	73.90	19.6	100	0	Floor Noise
Vert.	2352.000	AV	44.30	27.70	14.10	44.40	3.50	45.20	53.90	8.7	129	216	
Vert.	2608.000	AV	44.10	27.60	14.30	44.30	3.50	45.20	53.90	8.7	164	215	

Result = Reading + Ant.Fac. + Loss (Cable+(Attenuator or Filter)(below 18 GHz)) - Gain(Amplifier) + Distance factor

Distance factor : 1 GHz - 10 GHz : 20log(4.5 m / 3.0 m) = 3.5 dB

10 GHz - 40 GHz : 20log(1.0 m / 3.0 m) = -9.5 dB

Average measurement value with duty factor

Polarity	Frequency [MHz]	Detector	Reading [dBuV]	Ant.Fac. [dB/m]	Loss [dB]	Gain [dB]	Duty Factor [dB]	Distance Factor [dB]	Result [dBuV/m]	Limit [dBuV/m]	Margin [dB]	Remark
Hori.	2483.500	AV	45.20	27.40	14.20	44.30	0.44	3.50	46.44	53.90	7.5	*1)
Hori.	4960.000	AV	44.50	31.40	6.40	46.10	0.44	3.50	40.14	53.90	13.8	
Hori.	7440.000	AV	41.30	36.60	7.70	44.20	0.44	3.50	45.34	53.90	8.6	
Hori.	9920.000	AV	36.90	39.40	8.80	42.40	0.44	3.50	46.64	53.90	7.3	Floor Noise
Vert.	2483.500	AV	44.40	27.40	14.20	44.30	0.44	3.50	45.64	53.90	8.3	*1)
Vert.	4960.000	AV	45.70	31.40	6.40	46.10	0.44	3.50	41.34	53.90	12.6	
Vert.	7440.000	AV	41.50	36.60	7.70	44.20	0.44	3.50	45.54	53.90	8.4	
Vert.	9920.000	AV	37.00	39.40	8.80	42.40	0.44	3.50	46.74	53.90	7.2	Floor Noise

Result = Reading + Ant.Fac. + Loss (Cable+(Attenuator or Filter)(below 18 GHz)) - Gain(Amplifier) + Duty factor + Distance factor

Distance factor : 1 GHz - 10 GHz : 20log(4.5 m / 3.0 m) = 3.5 dB

10 GHz - 40 GHz : 20log(1.0 m / 3.0 m) = -9.5 dB

Duty factor refer to "Duty factor Calculation chart" sheet.

*1) Not out of band emission (Leakage Power)

UL Japan, Inc.

Kashima EMC Lab.

1614, Mushiata, Katori-shi, Chiba-ken, 289-0341 Japan

Telephone : +81 478 88 6500

Facsimile : +81 478 82 3373

Radiated Spurious Emission
(Reference Plot for band-edge)

Test place : Kashima EMC Lab. No.10 Semi Anechoic Chamber
Report No. : 11707914M-A
Date : April 5, 2017
Temperature / Humidity : 21 deg. C / 36 % RH
Engineer : Kazuhiro Ando
Mode : Tx, BT LE (2MHz) 2480 MHz

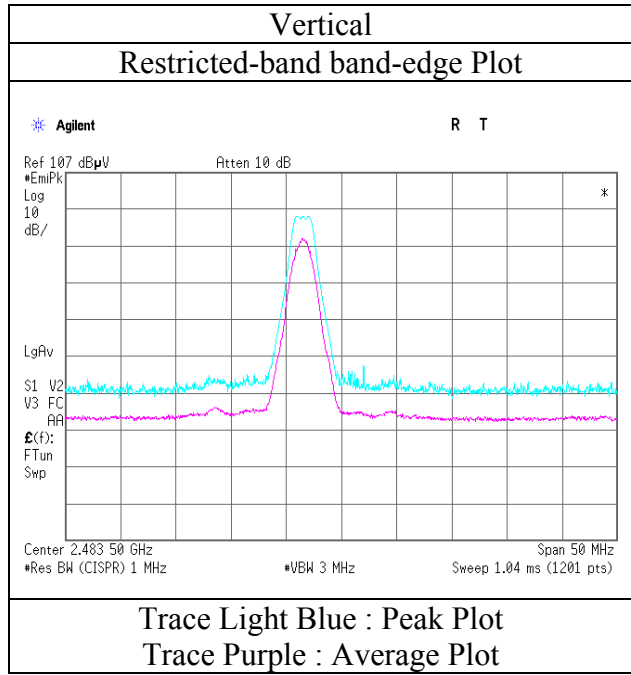
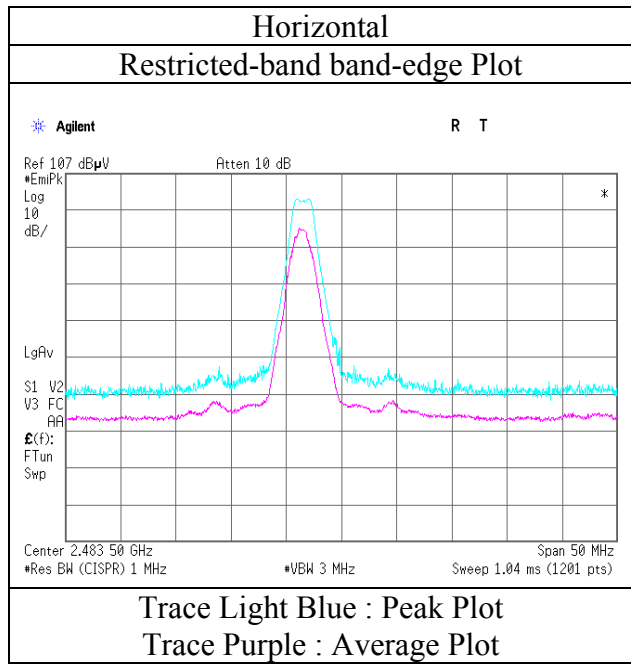

* Final result of restricted band edge was shown in tabular data.

Radiated Spurious Emission
(Plot data, Worst case)

Test place Kashima EMC Lab. No.10 Semi Anechoic Chamber
Report No. 11707914M-A
Date April 5, 2017
Temperature / Humidity 21 deg. C / 36 % RH
Engineer Kazuhiro Ando
Mode Tx, BT LE (2MHz), 2402 MHz

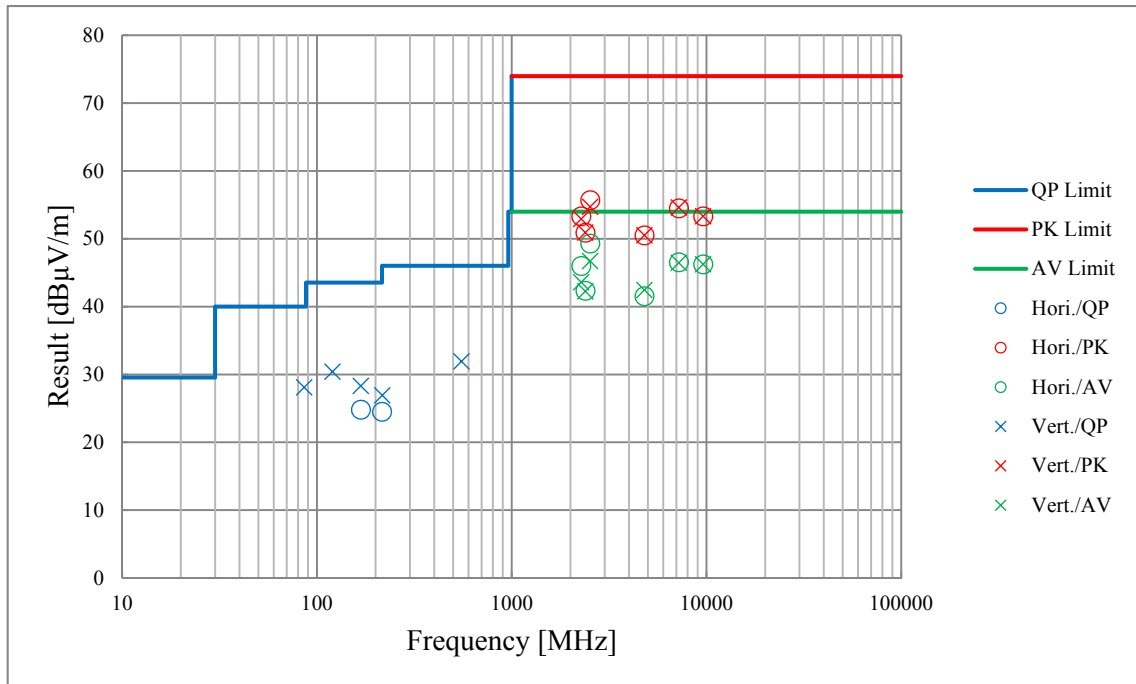

*These plots data contains sufficient number to show the trend of characteristic features for EUT.

Conducted Spurious Emission

Test place : Kashima EMC Lab. No.10 Semi Anechoic Chamber
Report No. : 11707914M-A
Date : April 22, 2017
Temperature / Humidity : 23 deg. C / 45 % RH
Engineer : Kazuhiro Ando
Mode : Tx, BT LE (2MHz), 2402 MHz

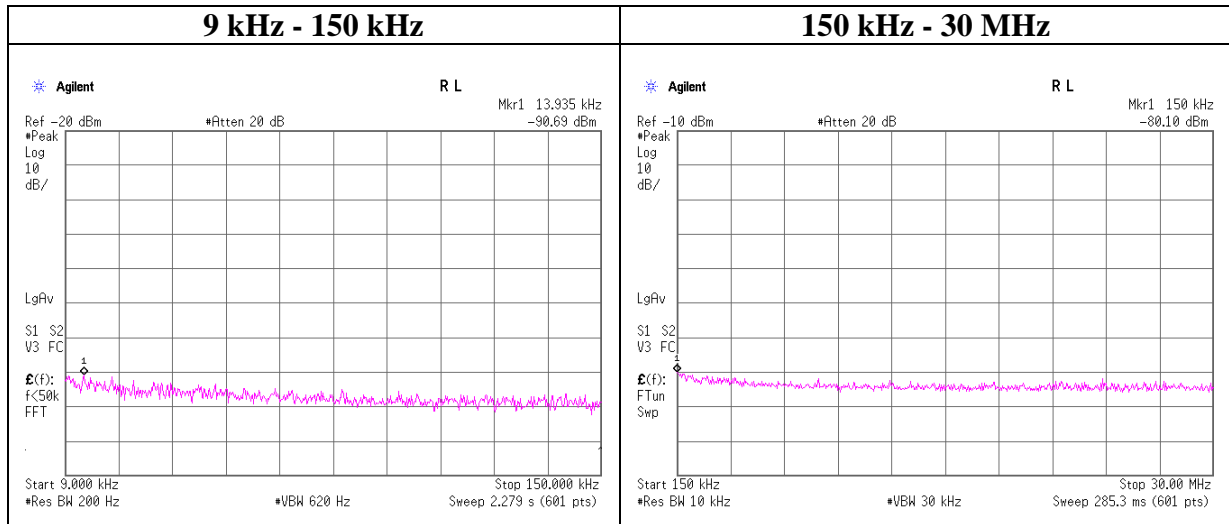

Frequency [kHz]	Reading [dBm]	Cable Loss [dB]	Attenuator Loss [dB]	Antenna Gain* [dBi]	N (Number of Output)	EIRP [dBm]	Distance [m]	Ground bounce [dB]	E (field strength) [dBuV/m]	Limit [dBuV/m]	Margin [dB]	Remark
13.94	-90.7	0.01	9.95	2.0	1	-78.7	300	6.0	-17.5	44.7	62.2	
150.00	-80.1	0.01	9.95	2.0	1	-68.1	300	6.0	-6.9	24.0	30.9	

$E \text{ [dBuV/m]} = \text{EIRP [dBm]} - 20 \log(\text{Distance [m]}) + \text{Ground bounce [dB]} + 104.8 \text{ [dBuV/m]}$

$\text{EIRP [dBm]} = \text{Reading [dBm]} + \text{Cable loss [dB]} + \text{Attenuator Loss [dB]} + \text{Antenna gain [dBi]} + 10 * \log(N)$

N: Number of output

*2.0 dBi was applied to the test result based on KDB 558074 since antenna gain was less than 2.0 dBi.

Conducted Spurious Emission

Test place	Kashima EMC Lab. No.2 Measurement Room
Report No.	11707914M-A
Date	April 22, 2017
Temperature / Humidity	23 deg. C / 45 % RH
Engineer	Kazuhiro Ando
Mode	Tx BT LE (2 MHz) 2440 MHz

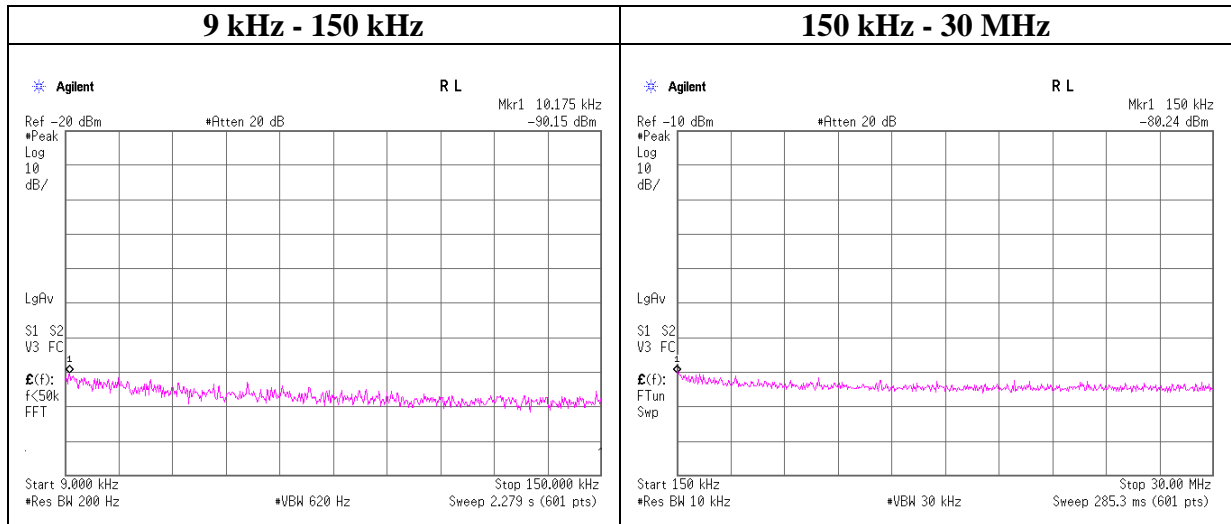

Frequency [kHz]	Reading [dBm]	Cable Loss [dB]	Attenuator Loss [dB]	Antenna Gain* [dBi]	N (Number of Output)	EIRP [dBm]	Distance [m]	Ground bounce [dB]	E (field strength) [dBuV/m]	Limit [dBuV/m]	Margin [dB]	Remark
10.18	-90.2	0.01	9.95	2.0	1	-78.2	300	6.0	-16.9	47.4	64.3	
150.00	-80.2	0.01	9.95	2.0	1	-68.3	300	6.0	-7.0	24.0	31.0	

$E \text{ [dBuV/m]} = \text{EIRP [dBm]} - 20 \log(\text{Distance [m]}) + \text{Ground bounce [dB]} + 104.8 \text{ [dBuV/m]}$

$\text{EIRP [dBm]} = \text{Reading [dBm]} + \text{Cable loss [dB]} + \text{Attenuator Loss [dB]} + \text{Antenna gain [dBi]} + 10 * \log(N)$

N: Number of output

*2.0 dBi was applied to the test result based on KDB 558074 since antenna gain was less than 2.0 dBi.

Conducted Spurious Emission

Test place : Kashima EMC Lab. No.2 Measurement Room
Report No. : 11707914M-A
Date : April 22, 2017
Temperature / Humidity : 23 deg. C / 45 % RH
Engineer : Kazuhiro Ando
Mode : Tx BT LE (2 MHz) 2480 MHz

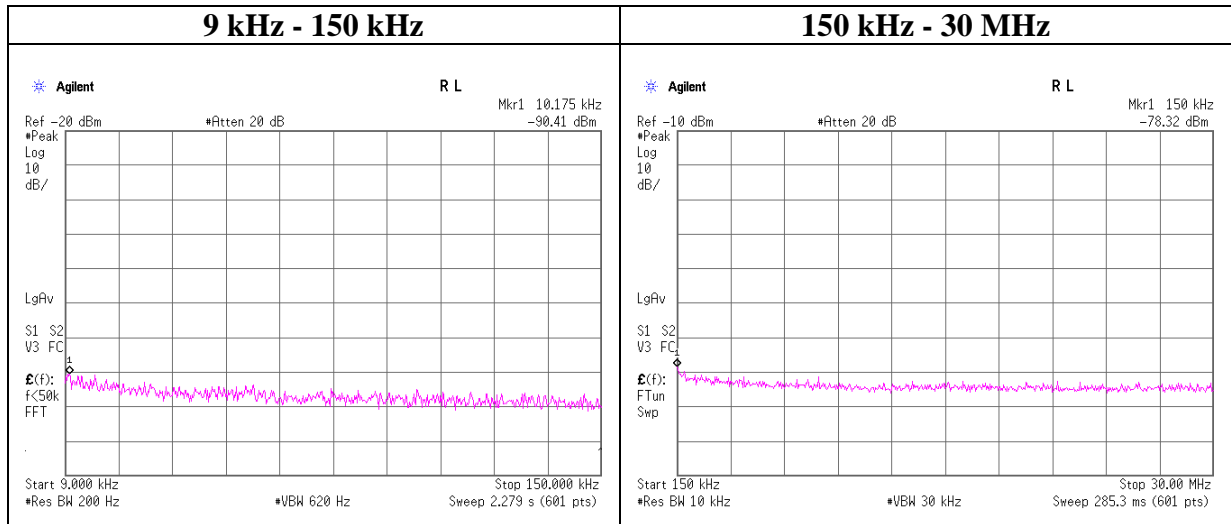

Frequency [kHz]	Reading [dBm]	Cable Loss [dB]	Attenuator Loss [dB]	Antenna Gain* [dBi]	N (Number of Output)	EIRP [dBm]	Distance [m]	Ground bounce [dB]	E (field strength) [dBuV/m]	Limit [dBuV/m]	Margin [dB]	Remark
10.18	-90.4	0.01	9.95	2.0	1	-78.5	300	6.0	-17.2	47.4	64.6	
150.00	-78.3	0.01	9.95	2.0	1	-66.4	300	6.0	-5.1	24.0	29.1	

$E \text{ [dBuV/m]} = \text{EIRP [dBm]} - 20 \log(\text{Distance [m]}) + \text{Ground bounce [dB]} + 104.8 \text{ [dBuV/m]}$

$\text{EIRP [dBm]} = \text{Reading [dBm]} + \text{Cable loss [dB]} + \text{Attenuator Loss [dB]} + \text{Antenna gain [dBi]} + 10 * \log(N)$

N: Number of output

*2.0 dBi was applied to the test result based on KDB 558074 since antenna gain was less than 2.0 dBi.

Power Density

Test place	Kashima EMC Lab. No.2 Measurement Room
Report No.	11707914M-A
Date	April 5, 2016
Temperature / Humidity	21 deg. C / 46 % RH
Engineer	Hiromitsu Tanabe
Mode	Tx BT LE (2 MHz)

Freq. [MHz]	Reading [dBm]	Cable Loss [dB]	Atten. Loss [dB]	Result [dBm]	Limit [dBm]	Margin [dB]
2402.00	-22.17	1.51	10.04	-10.62	8.00	18.62
2440.00	-23.60	1.51	10.04	-12.05	8.00	20.05
2480.00	-23.36	1.52	10.04	-11.80	8.00	19.80

Sample Calculation:

Result = Reading + Cable Loss (including the cable(s) customer supplied) + Attenuator Loss

*The equipment and cables were not used for factor 0 dB of the data sheets.

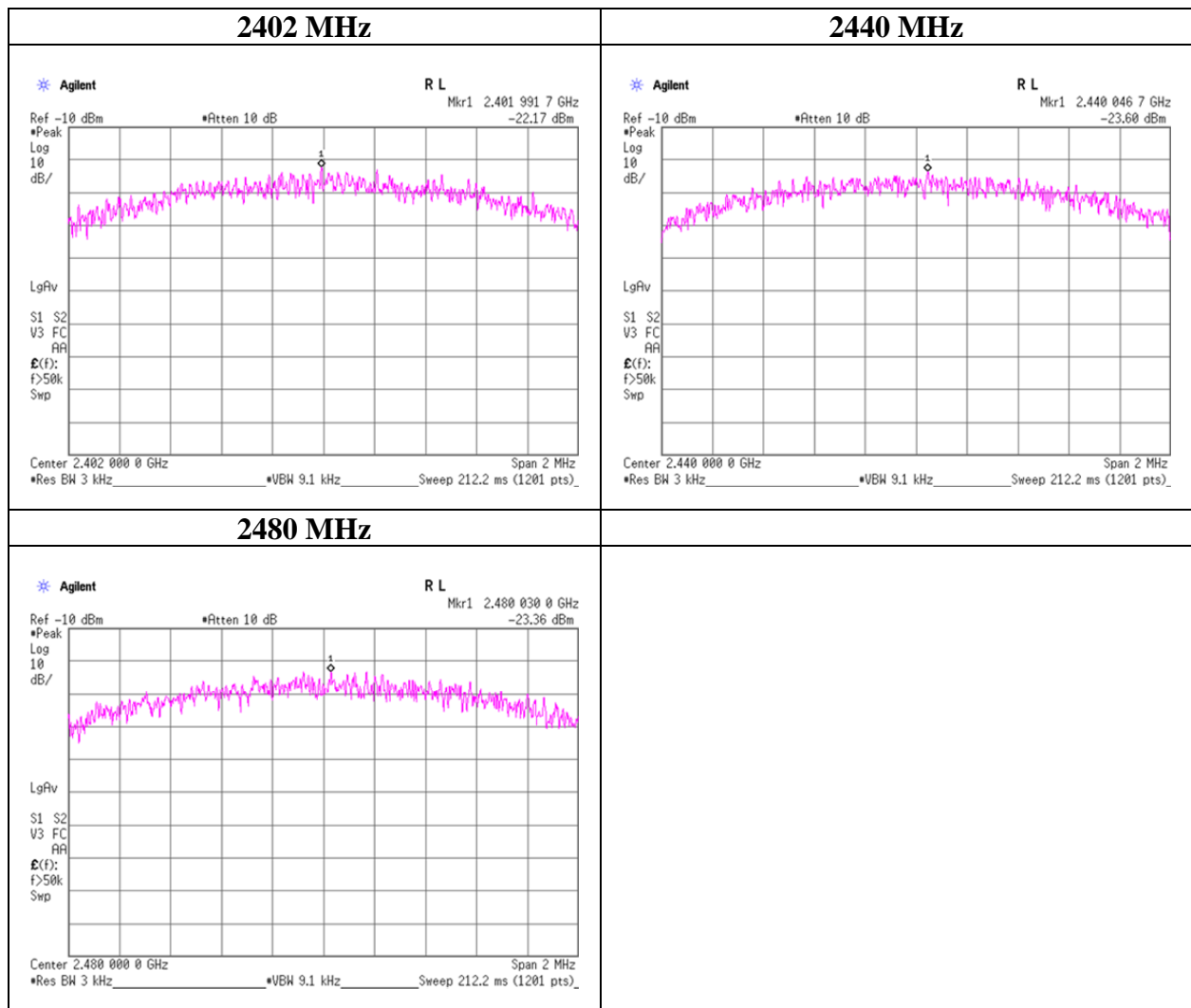

UL Japan, Inc.

Kashima EMC Lab.

1614, Mushiata, Katori-shi, Chiba-ken, 289-0341 Japan

Telephone : +81 478 88 6500

Facsimile : +81 478 82 3373

99%Occupied Bandwidth

Test place	Kashima EMC Lab. No.2 Measurement Room
Report No.	11707914M-A
Date	April 5, 2017
Temperature / Humidity	21 deg. C / 46 % RH
Engineer	Hiromitsu Tanabe
Mode	Tx BT LE (2 MHz)

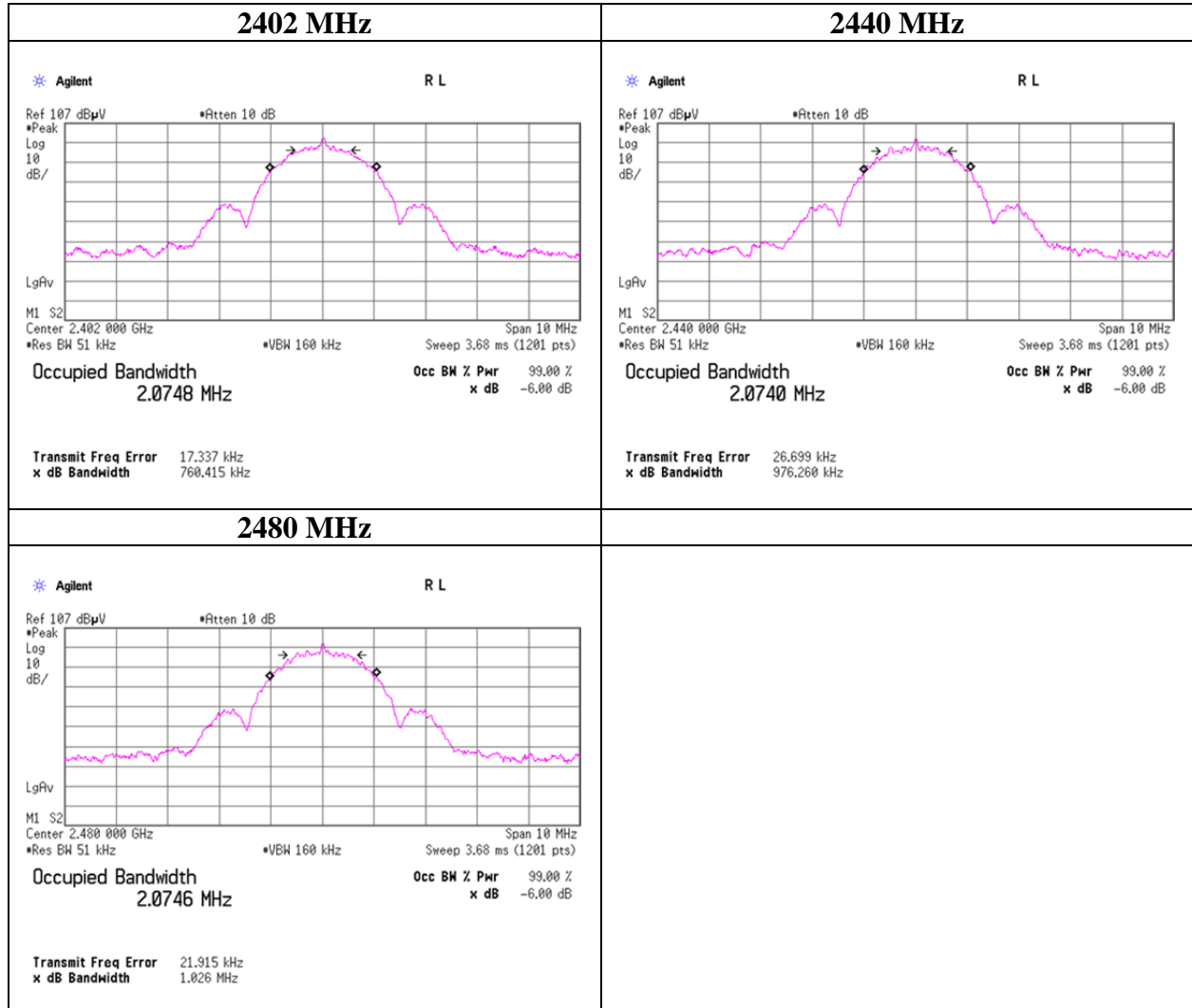

APPENDIX 2: Test instruments

Test equipment

Control No.	Instrument	Manufacturer	Model No	Serial No	Test Item	Calibration Date * Interval(month)
CLS-08	A.M.N.	Rohde & Schwarz	ESH3-Z5	847265/011	CE	2016/07/22 * 12
CLS-11	A.M.N.	Rohde & Schwarz	ESH3-Z5	835239/022	CE	2016/07/22 * 12
CAT10-25	10dB Fixed Atten.	Suhner	6810.01.A	none	CE	2016/07/01 * 12
CCC-S5-C(2/9/10/11)	Coaxial Cable	Fujikura,Fujikura,Fujikura,Fujikura	5D-2W,5D-2W,5D-2W,5D-2W	-	CE	2016/07/09 * 12
CTM-31	Terminator	Suhner	65_BNC-50-0-2/133_NE	none	CE	2016/11/01 * 12
CTR-06	Test Receiver	Rohde & Schwarz	ESCI	100107 Rev 4.32	CE	2016/09/26 * 12
CTR-09	Test Receiver	Agilent	N9038A	MY53290016 Version A.14.03	RE	2016/06/19 * 12
CBL-08	LOGBICON	Schwarzbeck	VULB 9168	343	RE	2016/11/12 * 12
CAT3-04	3dB Fixed Atten.	TAMAGAWA	UFA-01	none	RE	2016/09/26 * 12
CCC-S10-R(2/4/CAT S-11/5/6/7/8/11/12)	Coaxial Cable	Fujikura,Fujikura,Agilent,Fujikura,Fujikura,Fujikura,Fujikura,Fujikura	5D-2W,5D-2W,8494A,5D-2W,5D-2W,5D-2W,5D-2W,5D-2W	MY41110200(Step Att)	RE	2016/08/25 * 12
CAF-08	Pre-Amplifier	Hewlett Packard	8447D	2944A09041	RE	2016/08/25 * 12
CSCL-13	Ruler	Tajima	L19-55	none	CE/RE	-
COS-10	Temperature & Humidity Indicator	HIOKI	3641/9680-50	090999895/090905406	CE/RE	2016/05/24 * 12
CTS-14	Digital Multimeter	FLUKE	115	994460954	CE/RE	2016/10/04 * 12
COTS-CE MI-02	EMI Software	TSJ	TEPTO-DV(RE,C E,MF,PE)	Ver, RE: 2.5.0131, CE: 2.5.0131, ME: 2.5.0129, PE: 2.5.0129	CE/RE	-
CHA-20	Broad Band Horn	Schwarzbeck	BBHA 9120D	9120D-1270	RE	2016/07/03 * 12
CAF-21	Pre-Amplifier	Micro Wave Factory	MPR-1G26.5-35	161398	RE	2016/05/06 * 12
CCC-W05	Micro Wave Cable	Junkosha	MWX241	MRA-12-14-145	RE	2016/05/13 * 12
CCC-W07	Micro Wave Cable	Junkosha	MWX221	MRA-12-14-148	RE	2016/05/13 * 12
CHF-03	HPF	Micro-Tronics	HPM50111-02	008	RE	2016/05/13 * 12
CAT10-16	10dB Fixed Atten.	Weinschel	54A-10	56246	RE	2016/05/13 * 12
CHA-07	Double Ridged Horn	ETS-Lindgren	3160-09	00166043	RE	2016/06/24 * 12
CAF-19	Pre-Amplifier	TOYO	HAP18-26W	00000035	RE	2016/06/30 * 12
CSA-07	Spectrum Analyzer	Agilent	E4448A	MY52490024 Version A.11.21	RE/AT	2016/05/11 * 12
CAT10-17	10dB Fixed Atten.	Weinschel	54A-10	56251	AT	2016/05/13 * 12
CCC-W01	Micro Wave Cable	SUHNER	SUCOFLEX102	MY3662/2	AT	2016/05/13 * 12
CTS-18	Digital Multimeter	FLUKE	87-3	85220051	AT	2016/09/26 * 12
COS-05	Temperature & Humidity Indicator	A&D	AD-5681	6975761	AT	2016/07/21 * 12

The expiration date of the calibration is the end of the expired month.

All equipment is calibrated with valid calibrations. Each measurement data is traceable to the national or international standards.

UL Japan, Inc.

Kashima EMC Lab.

1614, Mushihata, Katori-shi, Chiba-ken, 289-0341 Japan

Telephone : +81 478 88 6500

Facsimile : +81 478 82 3373

As for some calibrations performed after the tested dates, those test equipment have been controlled by means of an unbroken chains of calibrations.

Test Item: **CE: Conducted Emission test**
 RE: Radiated Emission test
 AT: Antenna Terminal Conducted test