



FCC LISTED, REGISTRATION  
 NUMBER: 2764.01

ISED LISTED REGISTRATION  
 NUMBER: 23595-1

Test report No:  
**2239ERM.004A1**

## Test report

**FCC Rules and Regulations CFR 47, Part 15, Subpart B (10-1-17 Edition)&  
 ICES-003 ISSUE 6 – Update April (2017)**

Identification of item tested	Dive watch
Trademark	SUUNTO
Model and /or type reference	DW182
Other identification of the product	FCC ID: RYP2542 IC: 5175A-2542
Features	123 KHz Connection and BTLE standalone test modes
Manufacturer	SUUNTO Oy Tammiston kauppatie 7A, 01510 Vantaa, Finland
Test method requested, standard	FCC Rules and Regulations CFR 47, Part 15, Subpart B (10-1-17 Edition) ICES-003 ISSUE 6 – Update April (2017)
Summary	IN COMPLIANCE
Approved by (name / position & signature)	Domingo Galvez EMC&RF Lab Manager
Date of issue	10-31-2018
Report template No	FDT08_21

## Index

Competences and guarantees .....	3
General conditions .....	3
Uncertainty .....	3
Data provided by the client.....	4
Usage of samples .....	4
Test sample description .....	5
Identification of the client.....	6
Testing period and place.....	6
Document history .....	7
Modifications to the reference test report .....	7
Environmental conditions .....	7
Remarks and comments .....	8
Testing verdicts.....	8
Summary .....	8
List of equipment used during the test.....	9
Appendix A: Test results .....	10

## Competences and guarantees

---

DEKRA Certification Inc. is a testing laboratory accredited by A2LA (The American Association for Laboratory Accreditation), to perform the tests indicated in the Certificate 2764.01

DEKRA Certification Inc. is a testing laboratory competent to carry out the tests described in this report.

In order to assure the traceability to other national and international laboratories, DEKRA Certification Inc. has a calibration and maintenance program for its measurement equipment.

DEKRA Certification Inc. guarantees the reliability of the data presented in this report, which is the result of the measurements and the tests performed to the item under test on the date and under the conditions stated on the report and, it is based on the knowledge and technical facilities available at DEKRA Testing and Certification at the time of performance of the test.

DEKRA Certification Inc. is liable to the client for the maintenance of the confidentiality of all information related to the item under test and the results of the test.

The results presented in this Test Report apply only to the particular item under test established in this document.

**IMPORTANT:** No parts of this report may be reproduced or quoted out of context, in any form or by any means, except in full, without the previous written permission of DEKRA Certification Inc.

## General conditions

---

1. This report is only referred to the item that has undergone the test.
2. This report does not constitute or imply on its own an approval of the product by the Certification Bodies or competent Authorities.
3. This document is only valid if complete; no partial reproduction can be made without previous written permission of DEKRA Certification Inc.
4. This test report cannot be used partially or in full for publicity and/or promotional purposes without previous written permission of DEKRA Certification Inc. and the Accreditation Bodies.

## Uncertainty

---

Uncertainty (factor k=2) was calculated according to the DEKRA Testing and Certification internal document PODT000.

	Frequency (MHz)	U(k=2)	Units
Conducted emission	0,009 - 30	2.69	dB
Radiated emission	30 - 6000	5.44	dB
	1000-18000	2.92	dB
	18000-40000	2.15	dB

## Data provided by the client

Dive Watch with 123 KHz receiver and Bluetooth Low Energy transceiver.

DEKRA declines any responsibility with respect to the information provided by the client and that may affect the validity of results.

## Usage of samples

Samples undergoing test have been selected by: The client.

Sample S/01 is composed of the following elements:

Control N°	Description	Model	Serial N°	Date of reception
2239/05	SUUNTO BTLE With Conducted Port	DW182	182710001836	08/08/2018

1. Sample S/01 has undergone following test(s):

All conducted tests indicated in appendix A except Section A.7.

Sample S/02 is composed of the following elements:

Control N°	Description	Model	Serial N°	Date of reception
2239/01	SUUNTO BTLE Watch With Radiated sample	DW182	182710001834	08/08/2018

1. Sample S/02 has undergone following test(s):

All radiated tests indicated in appendix A..

Sample S/03 is composed of the following elements:

Control N°	Description	Model	Serial N°	Date of reception
2239/01	SUUNTO BTLE Watch With Radiated sample	DW182	182710001834	08/08/2018
2239.08	Wrist Watch Charging Cable	-	-	08/08/2018
2240/11	Charger	-	-	08/08/2018
2240/12	USB Cable	-	-	08/08/2018

1. Sample S/03 has undergone following test(s):

Conducted tests indicated in appendix A Section A.7.

## Test sample description

Ports..... :	Port name and description		Cable				
			Specified length [m]	Attached during test	Shielded		
	<i>Not provided data</i>			<input type="checkbox"/>	<input type="checkbox"/>		
				<input type="checkbox"/>	<input type="checkbox"/>		
				<input type="checkbox"/>	<input type="checkbox"/>		
				<input type="checkbox"/>	<input type="checkbox"/>		
				<input type="checkbox"/>	<input type="checkbox"/>		
Supplementary information to the ports..... :	<i>Not provided data</i>						
Rated power supply .....	Voltage and Frequency		Reference poles				
			L1	L2	L3	N	PE
	<input type="checkbox"/>	AC: 230Vac / 50Hz.	<input type="checkbox"/>	<input type="checkbox"/>	<input type="checkbox"/>	<input type="checkbox"/>	<input type="checkbox"/>
	<input type="checkbox"/>	AC:	<input type="checkbox"/>	<input type="checkbox"/>	<input type="checkbox"/>	<input type="checkbox"/>	<input type="checkbox"/>
	<input type="checkbox"/>	DC: 8-18 Vdc					
<input checked="" type="checkbox"/>	DC: 4.3 (Battery)						
Rated Power .....	<i>Not provided data</i>						
Clock frequencies .....	<i>Not provided data</i>						
Other parameters..... :	<i>Not provided data</i>						
Software version .....	1.8.440						
Hardware version..... :	C						
Dimensions in cm (L x W x D) .....	<i>Not provided data</i>						
Mounting position..... :	<input type="checkbox"/>	Table top equipment					
	<input type="checkbox"/>	Wall/Ceiling mounted equipment					
	<input type="checkbox"/>	Floor standing equipment					
	<input type="checkbox"/>	Hand-held equipment					
	<input checked="" type="checkbox"/>	Other:					
Modules/parts .....	Module/parts of test item		Type	Manufacturer			

Accessories (not part of the test item) .....	Description	Type	Manufacturer
	<i>Not provided data</i>		
Documents as provided by the applicant.....	Description	File name	Issue date
	<i>Not provided data</i>		

Copy of marking plate:



## Identification of the client

SUUNTO Oy  
 Tammiston kauppatie 7A, 01510 Vantaa, Finland

## Testing period and place

Test Location	DEKRA Testing and Certification S.A.U.
Date (start)	08-10-2018
Date (finish)	08-17-2018

## Document history

Report number	Date	Description
2239ERM.004	09-14-2018	First release
2239ERM.004A1	10-31-2018	Modification to change Test Location

## Modifications to the reference test report

It was introduced the following modifications in respect to the test report number 2239ERM.04 related with the same samples, in the next clauses and sub-clauses:

Clauses/ Sub-Clauses	Modification	Justification
Test Place	Changed to correct location	Typo

This modification test report cancels and replaces the test report 2239ERM.004.

## Environmental conditions

In the control chamber, the following limits were not exceeded during the test:

<b>Temperature</b>	Min. = 15 °C Max. = 35 °C
<b>Relative humidity</b>	Min. = 30 % Max. = 75 %
<b>Air pressure</b>	Min. = 860 mbar Max. = 1060 mbar

In the semianechoic chamber, the following limits were not exceeded during the test.

<b>Temperature</b>	Min. = 15 °C Max. = 35 °C
<b>Relative humidity</b>	Min. = 30 % Max. = 75 %
<b>Air pressure</b>	Min. = 860 mbar Max. = 1060 mbar

In the chamber for conducted measurements, the following limits were not exceeded during the test:

<b>Temperature</b>	Min. = 15 °C Max. = 35 °C
<b>Relative humidity</b>	Min. = 30 % Max. = 60 %
<b>Air pressure</b>	Min. = 860 mbar Max. = 1060 mbar

## Remarks and comments

The tests have been performed by the technical personnel: Divya Adusumilli and Koji Nishimoto.

## Testing verdicts

Not applicable :	N/A
Pass :	P
Fail :	F
Not measured :	N/M

## Summary

Emission Test		
Requirement – Test case	Verdict	Remark
Radiated emission test (30 MHz – 1000 MHz)	Pass	N/A
Radiated emission test (1 GHz – 18 GHz)	Pass	N/A
Conducted emission test (150 KHz to 30 MHz)	Pass	N/A
<u>Supplementary information and remarks:</u>		
No comments		



## List of equipment used during the test

---

### Conducted Measurements

CONTROL NUMBER	DESCRIPTION	LAST CALIBRATION	NEXT CALIBRATION
1010	EMI Test Receiver - ESR7 - Rohde & Schwarz	2017/03	2019/03
0997	LISN - PMM L3-32 - Narda	2017/03	2019/03
1073	Pulse Limiter - PMM PL01 - Narda	2017/06	2019/06

### Radiated Measurements

CONTROL NUMBER	DESCRIPTION	LAST CALIBRATION	NEXT CALIBRATION
1179	Semi anechoic Absorber Lined Chamber Frankonia SAC 3 plus "L"	N/A	N/A
1065	BiconicalLog antenna ETS LINDGREN 3142E	2017/03	2020/03
1058	Double-ridge Waveguide Horn antenna 1-18 GHz	2017/03	2019/03
1014	Spectrum analyzer Rohde & Schwarz FSV40	2017/03	2019/03
1012	EMI Test Receiver Rohde & Schwarz ESR26	2018/09	2019/03
0981	RF pre-amplifier 1-18 GHz Bonn Elektronik BLMA 0118-2A	2017/05	2019/05
1015, 1017, 1019, 1020	Rohde & Schwarz EMC32 software	N/A	N/A

## Appendix A: Test results

## Appendix A Content

DESCRIPTION OF THE OPERATION MODES.....	12
RADIATED EMISSION ELECTROMAGNETIC FIELD .....	13
CONTINUOUS CONDUCTED EMISSION ON POWER LEADS .....	17

## DESCRIPTION OF THE OPERATION MODES

---

The operation modes described in this paragraph constitute a functionality of the sample under test for itself. Every operation mode takes failure criteria for the immunity test that they were applying to it and a monitoring to guarantee performance of the same ones.

The operation modes used by the samples to which the present report refers, are shown in the following table:

OPERATION MODE	DESCRIPTION
OM#01*	EUT ON. Bluetooth IDLE. Battery charging and transferring data with PC by USB port of laptop (120 Vac/ 60Hz).

\* Worst case detected

## RADIATED EMISSION ELECTROMAGNETIC FIELD

<b>LIMITS:</b>	Product standard :	FCC CFR 47, Part 15, Subpart B (10-1-17 Edition), Secs. 15.109 & ICES-003 Issue 6 – Update April (2017)
	Test standard :	FCC CFR 47, Part 15, Subpart B (10-1-17 Edition), Secs. 15.109 & ICES-003 Issue 6 – Update April (2017); ANSI C63.4 (2014)

### Limits of interference Class B

The applied limit for radiated emissions, 3 m distance, according with the requirements of FCC Rules and Regulations 47 CFR Part 15, Subpart B (10-01-17 Edition), Secs. 15.109 & ICES-003 Issue 6 – Update April (2017) in the frequency range 30 MHz to 40 GHz for class B equipment.

Frequency range (MHz)	QP Limit for 3 m		PK Limit for 3 m
	( $\mu$ V/m)	(dB $\mu$ V/m)	(dB $\mu$ V/m)
30 to 88	100	40	---
88 to 216	150	43.5	---
216 to 960	200	46	---
Above 960	500	54	74

## TEST SETUP

All radiated tests were performed in a semi-anechoic chamber. The measurement antenna is situated at a distance of 3 m for the frequency range 30-1000 MHz (Bilog antenna) and at a distance of 1m for the frequency range 1-40 GHz (1 GHz-18 GHz and 18 GHz-40 GHz Double ridge horn antennas).

For radiated emissions in the range 1-40 GHz that is performed at a distance closer than the specified distance, an inverse proportionality factor of 20 dB per decade is used to normalize the measured data for determining compliance.

The equipment under test was set up on a non-conductive platform above the ground plane and the situation and orientation was varied to find the maximum radiated emission. It was also rotated 360° and the antenna height was varied from 1 to 4 meters to find the maximum radiated emission.

Measurements were made in both horizontal and vertical planes of polarization.

The field strength is calculated by adding correction factor to the measured level from the spectrum analyzer. This correction factor includes antenna factor, cable loss and pre-amplifiers gain.

**TEST SETUP (CONT.)**

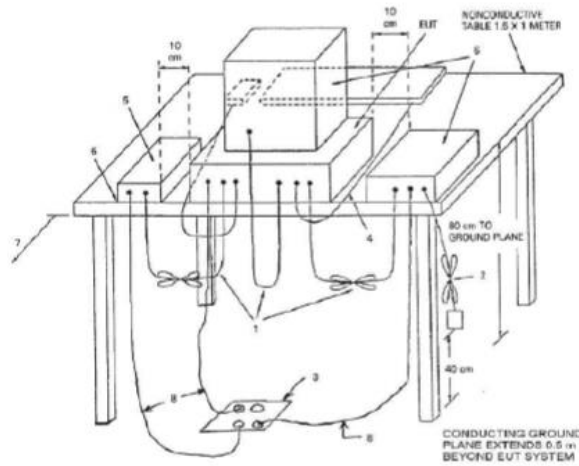
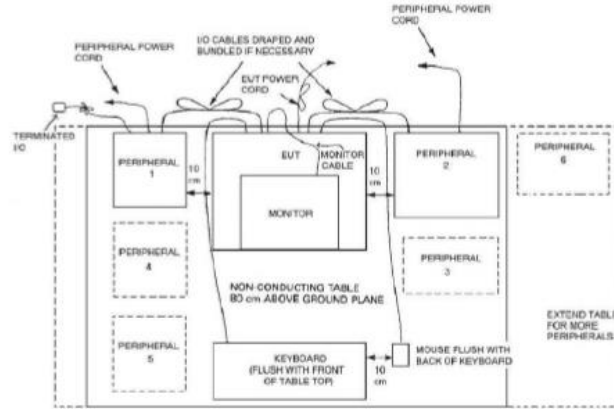

<b>TESTED SAMPLES:</b>	S/01
<b>TESTED CONDITIONS MODES:</b>	OM#01
<b>TEST RESULTS :</b>	CRmmnxx: CR, Radiation Condition; mm: Sample number; nn: Operation mode.,xx:Range,

CRmmnxx	Description	Result
CR0101LR	Range: 30 MHz - 1000 MHz Horizontal and Vertical Polarization	P
CR0101HR	Range: 1GHz - 18 GHz Horizontal and Vertical Polarization	P

**TEST RESULTS (Cont.):**

**CR0101LR**

Project: 2239ERM004  
 Company: Suunto Oy  
 Sample: S/01  
 Operation mode: OM#01  
 Description: EUT ON. IDLE. Power supply from USB cable through a laptop. Both polarizations.

Full Spectrum

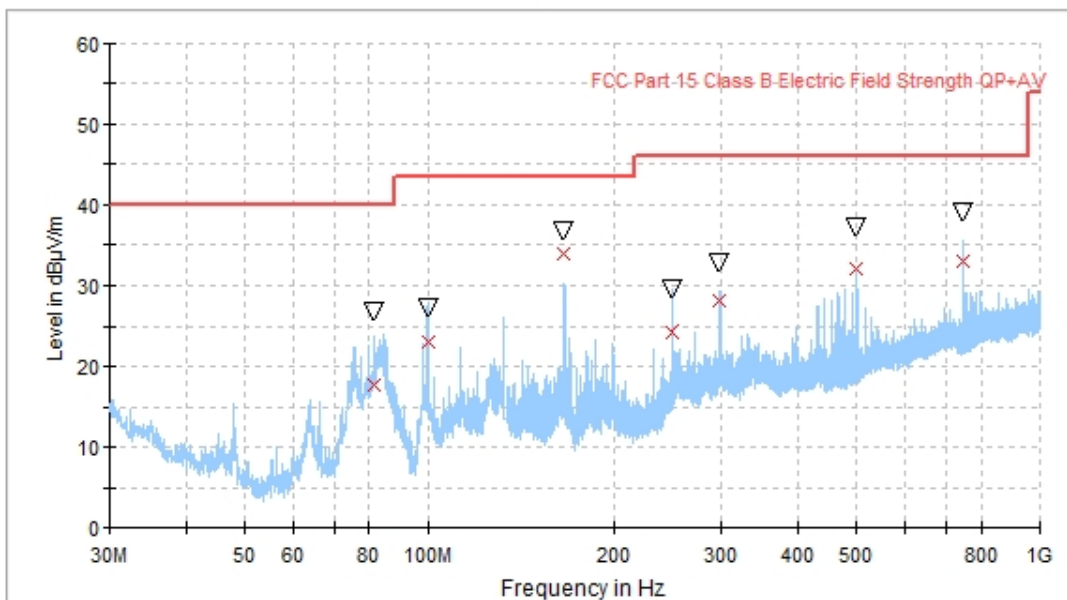

- Preview Result 1-PK+
- FCC Part 15 Class B Electric Field Strength QP+AV
- × Final\_Result QPK
- ▽ Final\_Result PK+

**Maximizations**

Frequency (MHz)	QuasiPeak (dBµV/m)	MaxPeak (dBµV/m)	Limit (dBµV/m)	Margin (dB)	Height (cm)	Pol	Azimuth (deg)
81.200000	17.83	26.68	40.00	22.17	170.0	V	-12.0
99.730000	23.13	27.00	43.50	20.37	114.0	V	129.0
165.960000	33.76	36.76	43.50	9.74	117.0	H	172.0
249.440000	24.37	29.53	46.00	21.63	100.0	H	98.0
298.740000	27.93	32.67	46.00	18.07	150.0	V	-3.0
497.860000	31.97	37.03	46.00	14.03	148.0	V	76.0
746.810000	32.95	38.90	46.00	13.05	127.0	V	-8.0

**TEST RESULTS (Cont.):**

**CR0101HR**

Project: 2239ERM004  
 Company: Suunto Oy  
 Sample: S/01  
 Operation mode: OM#01  
 Description: EUT ON. IDLE. Power supply from USB cable through a laptop. Both polarizations.

Full Spectrum

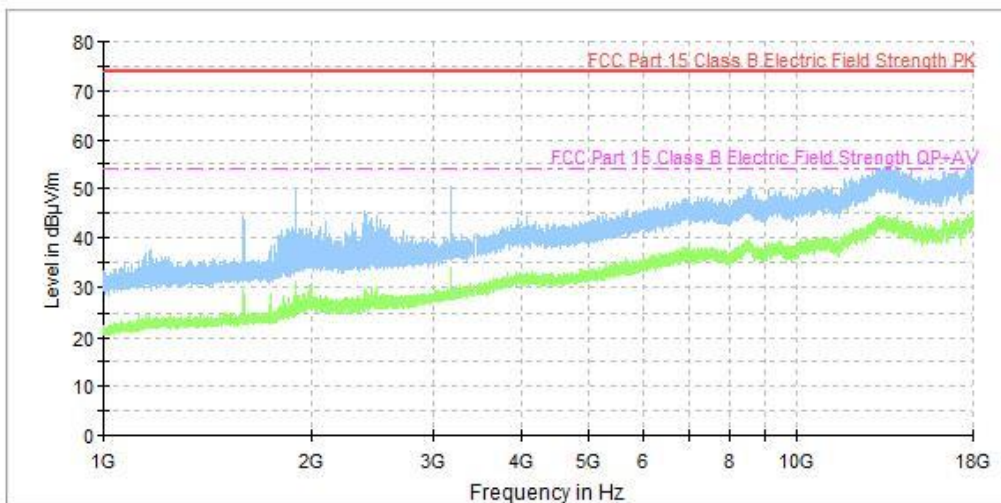

- Preview Result 2-AVG
- Preview Result 1-PK+
- \* Critical\_Freqs PK+
- FCC Part 15 Class B Electric Field Strength PK
- - - - FCC Part 15 Class B Electric Field Strength QP+AV
- × Final\_Result PK+
- ▽ Final\_Result AVG

**Maximizations**

Frequency (MHz)	PK+_MAXH (dBµV/m)	AVG_MAXH (dBµV/m)	PoI
1595.200000	44.3	27.4	V
1896.700000	50.0	30.0	V
3186.000000	50.6	33.8	H
6852.000000	47.8	37.2	V
11067.500000	50.5	39.0	V
17923.000000	55.7	43.3	V



## A.2. CONTINUOUS CONDUCTED EMISSION ON POWER LEADS

<b>LIMITS:</b>	Product standard :	FCC CFR 47, Part 15, Subpart B (10-1-17 Edition), Secs. 15.107 & ICES-003 Issue 6 – Update April (2017)
	Test standard :	FCC CFR 47, Part 15, Subpart B (10-1-17 Edition), Secs. 15.107 & ICES-003 Issue 6 – Update April (2017); ANSI C63.4 (2014)

### LIMITS

The applied limit for continuous conducted emissions in power leads, according with the requirements of FCC Rules and Regulations 47 CFR Part 15, Subpart B (10-01-17 Edition), Secs. 15.107 & ICES Issue 6 (2017), in the frequency range 0,15 to 30 MHz, for Class B equipment was:

Frequency range (MHz)	Limit	
	Quasi-peak [dB(μV) <sup>1)</sup>	Average [dB(μV) <sup>1)</sup>
0,15 to 0,5	66-56 <sup>2)</sup>	56-46 <sup>2)</sup>
0,5 to 5	56	46
5 to 30	60	50

<sup>1)</sup> At the transition frequency, the lower limit applies.  
<sup>2)</sup> The limit decreases linearly with the logarithm of the frequency.

### TEST SETUP

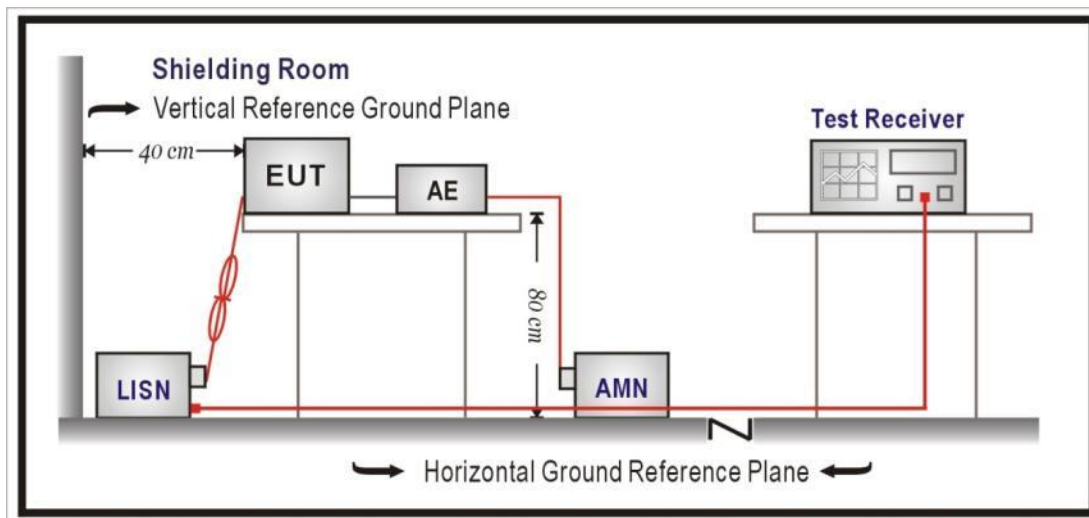

<b>TESTED SAMPLES:</b>	S/01
<b>TESTED CONDITIONS MODES:</b>	OM#01
<b>TEST RESULTS :</b>	CCmmnnhh:CC, Conducted Condition; mm: Sample number; nn: Test condition mode; hh: wire

CRmmnnhh	DESCRIPTION	RESULT
CC01010N	Neutral wire noise.	P
CC0101L1	Phase wire noise.	P

**TEST RESULTS (Cont.):**

**CC03020N**

Project: 2239ERM004  
 Company: Suunto Oy  
 Sample: S/01  
 Operation mode: OM#01  
 Description: EUT ON. IDLE. Power supply from USB cable through a laptop, L1 wire measurement.

CE FCC part 15 Class B

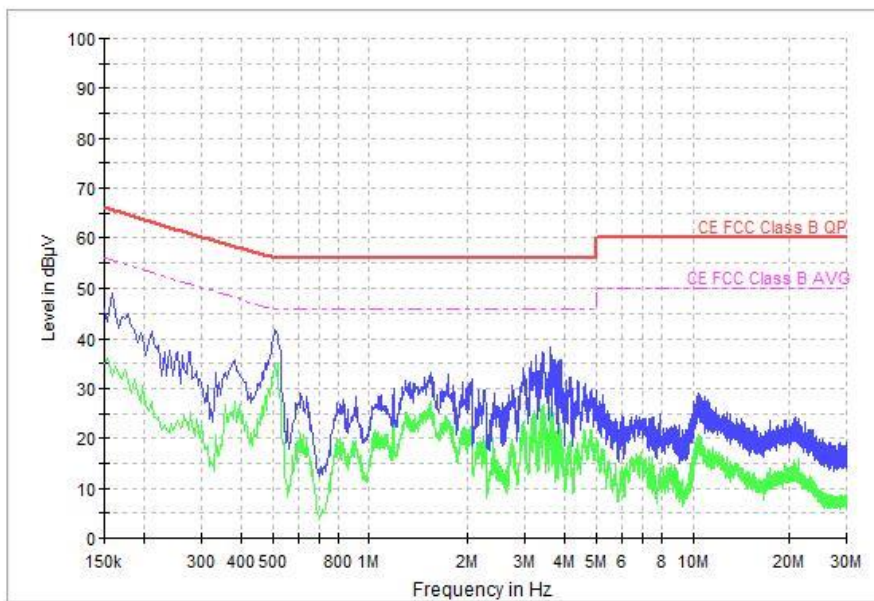

— QPK\_CLRWR      — AVG\_CLRWR      — PK+\_CLRWR  
 — CE FCC Class B QP      — CE FCC Class B AVG

**Maximizations**

Frequency (MHz)	PK+_CLRWR (dBµV)	AVG_CLRWR (dBµV)
0.154000	43.5	36.1
5.238000	28.8	18.0
10.446000	28.0	20.7
19.310000	21.5	14.8
21.214000	23.8	16.1
25.122000	16.8	9.2

**TEST RESULTS (Cont.):**

**CC0302L1**

Project: 2239ERM004  
 Company: Suunto Oy  
 Sample: S/01  
 Operation mode: OM#01  
 Description: EUT ON. IDLE. Power supply from USB cable through a laptop, L1 wire measurement.

CE FCC part 15 Class B

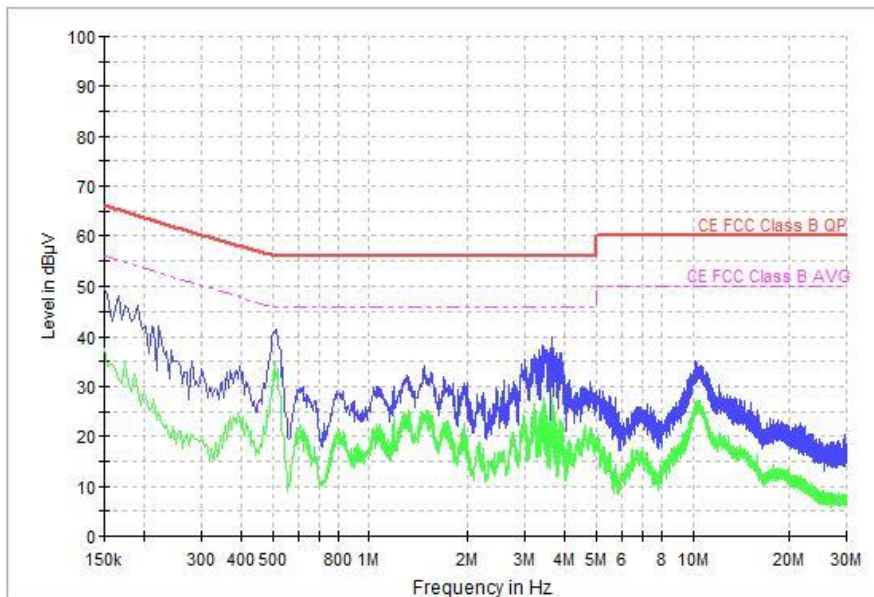

— QPK\_CLRWR      — AVG\_CLRWR      — PK+\_CLRWR  
- - - CE FCC Class B QP      - - - CE FCC Class B AVG

**Maximizations**

Frequency (MHz)	PK+_CLRWR (dBµV)	AVG_CLRWR (dBµV)
0.150000	49.5	37.7
10.082000	33.2	25.8
10.462000	33.3	27.2
15.822000	25.1	16.3
20.082000	20.2	12.3
25.330000	17.5	9.1