

SUUNTO EON CORE

USER GUIDE

1. Safety.....	4
2. Getting started.....	7
2.1. Display states and views.....	7
2.2. Icons.....	7
2.3. Set up.....	8
3. Features.....	9
3.1. Alarms, warnings and notifications.....	9
3.2. Ascent rate.....	10
3.3. Algorithm lock.....	11
3.4. Battery.....	11
3.5. Bookmark.....	12
3.6. Calendar clock.....	12
3.7. Compass.....	13
3.7.1. Calibrating compass.....	13
3.7.2. Setting declination.....	13
3.7.3. Setting bearing lock.....	14
3.8. Customization.....	14
3.9. Decompression dives.....	16
3.10. Display brightness.....	18
3.11. Dive history.....	18
3.12. Dive modes.....	19
3.13. Dive planner.....	19
3.14. Flip display.....	20
3.15. Gas consumption.....	20
3.16. Gas time.....	21
3.17. Gas mixtures.....	21
3.18. Language and unit system.....	22
3.19. Logbook.....	22
3.20. Multi-gas diving.....	23
3.21. Movescount mobile app.....	23
3.22. Personal and altitude adjustments.....	24
3.23. Oxygen calculations.....	25
3.24. Rebreather diving.....	25
3.24.1. Closed-circuit gases.....	25
3.24.2. Open-circuit gases.....	26
3.24.3. Setpoints.....	26
3.24.4. Bailouts.....	27
3.25. Safety stops and deepstops.....	28
3.26. Sample rate.....	28
3.27. Standby and deep sleep.....	28

3.28. Surface and no-fly time.....	29
3.29. Suunto DM5 and Movescount.....	29
3.30. Suunto Fused RGBM.....	29
3.31. Tank pressure.....	30
3.32. Timer.....	31
3.33. Water contacts.....	32
4. Care and support.....	33
4.1. Handling guidelines.....	33
4.2. Water resistance.....	33
4.3. Installing scratch guard.....	33
4.4. Charging battery.....	34
4.5. Changing strap to bungee.....	34
4.6. Getting support.....	35
5. Reference.....	36
5.1. Technical specifications.....	36
5.2. Compliance.....	38
5.2.1. CE.....	38
5.2.2. EN 13319.....	38
5.2.3. EN 250 and FIOH.....	38
5.2.4. FCC compliance.....	38
5.2.5. ISED.....	39
5.5. International Limited Warranty.....	39
5.6. Copyright.....	40
5.7. Dive terms.....	41

1. Safety

Types of safety precautions

 **WARNING:** - is used in connection with a procedure or situation that may result in serious injury or death.

 **CAUTION:** - is used in connection with a procedure or situation that will result in damage to the product.

 **NOTE:** - is used to emphasize important information.

 **TIP:** - is used for extra tips on how to utilize the features and functions of the device.

Before you dive

Make sure that you fully understand the use, displays and limitations of your dive instruments. If you have any questions about this manual or the dive computer, contact your Suunto dealer before diving with the dive computer. Always remember that **YOU ARE RESPONSIBLE FOR YOUR OWN SAFETY!**

Safety precautions

 **WARNING:** *ONLY TRAINED DIVERS SHOULD USE A DIVE COMPUTER! Insufficient training for any kind of diving, including freediving, may cause a diver to commit errors, such as incorrect use of gas mixtures or improper decompression, that may lead to serious injury or death.*

 **WARNING:** *You must read the printed quick guide and online user guide for your dive computer. Failure to do so may lead to improper use, serious injury or death.*

 **WARNING:** *THERE IS ALWAYS A RISK OF DECOMPRESSION SICKNESS (DCS) FOR ANY DIVE PROFILE EVEN IF YOU FOLLOW THE DIVE PLAN PRESCRIBED BY DIVE TABLES OR A DIVE COMPUTER. NO PROCEDURE, DIVE COMPUTER OR DIVE TABLE WILL PREVENT THE POSSIBILITY OF DCS OR OXYGEN TOXICITY! An individual's physiological make up can vary from day to day. The dive computer cannot account for these variations. You are strongly advised to remain well within the exposure limits provided by the instrument to minimize the risk of DCS. As an added measure of safety, you should consult a physician regarding your fitness before diving.*

 **WARNING:** *If you have a pacemaker, we recommend you do not scuba dive. Scuba diving creates physical stresses on the body which may not be suitable for pacemakers.*

 **WARNING:** *If you have a pacemaker, consult a doctor before using this device. The inductive frequency used by the device may interfere with pacemakers.*

⚠ WARNING: Allergic reactions or skin irritations may occur when product is in contact with skin, even though our products comply with industry standards. In such event, stop use immediately and consult a doctor.

⚠ WARNING: Not for professional use! Suunto dive computers are intended for recreational use only. The demands of commercial or professional diving may expose the diver to depths and conditions that tend to increase the risk of decompression sickness (DCS). Therefore, Suunto strongly recommends that the device not be used for any commercial or professional diving activities.

⚠ WARNING: USE BACKUP INSTRUMENTS! Ensure that you use backup instrumentation, including a depth gauge, submersible pressure gauge, timer or watch, and have access to decompression tables whenever diving with a dive computer.

⚠ WARNING: For safety reasons, you should never dive alone. Dive with a designated buddy. You should also stay with others for an extended time after a dive as the onset of possible DCS may be delayed or triggered by surface activities.

⚠ WARNING: PERFORM PRE-CHECKS! Always check that your dive computer is functioning properly and has the correct settings before diving. Check that the display is working, the battery level is OK, tank pressure is correct, and so forth.

⚠ WARNING: Check your dive computer regularly during a dive. If there is any apparent malfunction, abort the dive immediately and safely return to the surface.

⚠ WARNING: THE DIVE COMPUTER SHOULD NEVER BE TRADED OR SHARED BETWEEN USERS WHILE IT IS IN OPERATION! Its information will not apply to someone who has not been wearing it throughout a dive, or sequence of repetitive dives. Its dive profiles must match that of the user. If it is left on the surface during any dive, the dive computer will give inaccurate information for subsequent dives. No dive computer can take into account dives made without the computer. Thus, any diving activity up to four days prior to initial use of the computer may cause misleading information and must be avoided.

⚠ WARNING: DO NOT EXPOSE ANY PART OF YOUR DIVE COMPUTER TO ANY GAS MIX CONTAINING MORE THAN 40% OXYGEN! Enriched air with greater oxygen content presents a risk of fire or explosion and serious injury or death.

⚠ WARNING: DO NOT DIVE WITH A GAS IF YOU HAVE NOT PERSONALLY VERIFIED ITS CONTENTS AND ENTERED THE ANALYZED VALUE INTO YOUR DIVE COMPUTER! Failure to verify tank contents and enter the appropriate gas values where applicable into your dive computer will result in incorrect dive planning information.

⚠ WARNING: Using a dive planner software such as in Suunto DM5 is not a substitute for proper dive training. Diving with mixed gases has dangers that are not familiar to divers diving with air. To dive with Trimix, Triox, Heliox and Nitrox or all of them, divers must have specialized training for the type of diving they are doing.

 **WARNING:** Do not use Suunto USB Cable in areas where flammable gases are present. Doing so may cause an explosion.

 **WARNING:** Do not disassemble or remodel Suunto USB Cable in any way. Doing so may cause an electric shock or fire.

 **WARNING:** Do not use Suunto USB cable if cable or parts are damaged.

 **CAUTION:** DO NOT allow the connector pins of the USB cable to touch any conductive surface. This may short circuit the cable, making it unusable.

Emergency ascents

In the unlikely event that the dive computer malfunctions during a dive, follow the emergency procedures provided by your certified dive training agency to immediately and safely ascend.

2. Getting started

2.1. Display states and views

Suunto EON Core has two main views in surface and dive states: time/no deco and compass. Change the view by pressing the middle button.

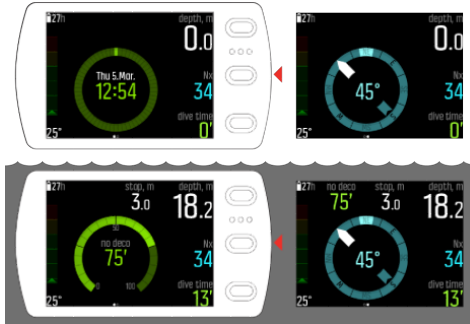

 **NOTE:** Main views can be customized. See Customization.

Suunto EON Core automatically switches between surface and dive state. If you are more than 1.2 m (4 ft) below the water level, the dive state is activated.





The following display shows Suunto EON Core when tank pressure screen is in use:



- Present depth is 19.0 m
- Active gas is Nitrox 32%
- Dive time is 22 minutes
- Tank pressure left is 120 bar
- No decompression time is 50 minutes
- Safety stop is ahead at 3.0 meters
- 21 hours of diving time left before need to recharge

2.2. Icons

Suunto EON Core uses the following icons:

	No-fly time
	Surface (interval) time
	Battery status (for device: charging, ok, low; for Tank POD: ok, low)
	Battery level - number indicates remaining diving time before need to recharge
	Tank / gas pressure information



Tank POD alert (device is not receiving signal from Tank POD)

2.3. Set up

To get the most out of your Suunto EON Core, use some time to customize features and displays. Make absolutely sure that you know your computer and have it set up as you want before getting into the water.

To get started

1. Wake up the device by connecting the USB cable to PC/Mac (or USB power source if available).

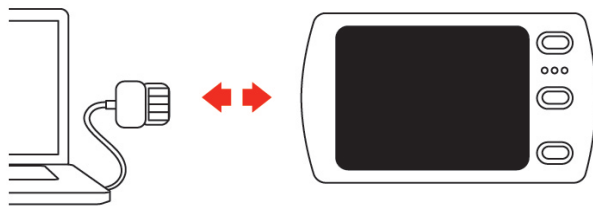

2. Follow the startup wizard to set up the device. When ready, the device goes to surface state.



3. Fully charge before first dive.

The startup wizard guides you through:

- Language
- Units
- Time format (12h/24h)
- Date format (dd.mm / mm.dd)
- Connecting with DM5 (optional)



3. Features

3.1. Alarms, warnings and notifications

Suunto EON Core has color-coded alarms, warnings and notifications. They are shown prominently on the display with an audible alarm (if tones are on). Alarms are always red. Warnings may be red or yellow. Notifications are always yellow.

When an alarm, warning, or notification occurs, a message is displayed as a pop-up. Pop-up messages can be acknowledged by pressing any button. The information needing attention remains on screen or as a scrollable element in the bottom field until the situation is back to normal.

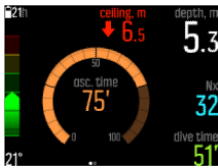
Alarms are critical events that always require immediate action. When an alarm situation comes back to normal, the alarm will stop automatically.

Alarm	Explanation
	Ascent speed exceeds safe speed of 10 m (33 ft) per minute for five seconds or more.
	Decompression ceiling broken by more than 0.6 m (2 ft) on a decompression dive. Immediately descend back below ceiling depth and continue to ascend normally.
	Partial pressure of oxygen exceeds safe level (>1.6). Immediately ascend or change to a gas with lower oxygen percentage.
	Partial pressure of oxygen below safe level (<0.18). Immediately descend or change to a gas with higher oxygen percentage.

Warnings alert you to events that can impact your health and safety if you do not take action. Acknowledge the warning by pressing any button.

Warning	Explanation
CNS100%	Central nervous system toxicity level at 100% limit
OTU300	Recommended daily limit for Oxygen tolerance unit reached
Depth	Depth exceeds your depth alarm limit

Warning	Explanation
Dive time	Dive time exceeds your dive time alarm limit
Diluent high PO2	Diluent partial pressure of oxygen exceeds safe level (>1.6); no immediate danger unless diluent is used, e.g. for bailout
Diluent low PO2	Diluent partial pressure of oxygen below safe level (<0.18); no immediate danger unless diluent is used, e.g. for bailout
Gas time	Gas time exceeds your gas time alarm limit, or tank pressure is below 35 bar (~510psi), in which case gas time is zero
Safety stop broken	Safety stop ceiling broken by more than 0.6 m (2 ft)
Tank pressure	Tank pressure is below your tank pressure alarm limit

Notifications indicate events that require preventive actions. Acknowledge the notification by pressing any button.

Notification	Explanation
CNS80%	Central nervous system toxicity level at 80% limit
OTU250	Approximately 80% of recommended daily limit for OTU reached
Change gas	On multi-gas dive when ascending, it is safe to switch to next available gas for optimum decompression profile
Low battery	Approximately three hours of dive time left
Re-charge needed	Approximately two hours of battery time left; re-charging required before next dive
Setpoint switched	Setpoint switched automatically on rebreather dive. See 3.24.3. <i>Setpoints</i>
Tank POD low battery	Tank POD battery life low; battery change required

3.2. Ascent rate

During a dive, the bar on the left indicates ascent rate. One bar step corresponds to 2 m (6.6 ft) per minute.

The bar is also color coded:

- **Green** indicates ascent rate is ok, less than 8 m (26.2 ft) per minute
- **Yellow** indicates ascent rate is moderately high, 8-10 m (26-33 ft) per minute
- **Red** indicates ascent rate is too high, over 10 m (33 ft) per minute

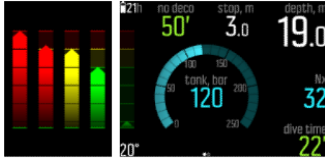

When maximum allowed ascent rate is exceeded for five seconds, an alarm is generated. Ascent rate violations result in longer safety stop times.

⚠ WARNING: DO NOT EXCEED THE MAXIMUM ASCENT RATE! Rapid ascents increase the risk of injury. You should always make the mandatory and recommended safety stops after you have exceeded the maximum recommended ascent rate. If this mandatory safety stop is not completed the decompression model will penalize your next dive(s).

3.3. Algorithm lock

Suunto Fused™ RGBM algorithm is locked for 48 hours if you omit decompression stops for longer than three (3) minutes. When the algorithm is locked, no algorithm information is available and **LOCKED** is shown instead. Locking the algorithm is a safety feature, highlighting that the algorithm information is no longer valid.

When you ascend above the decompression ceiling by more than 0.6 m (2 ft), the ceiling parameter turns red with an arrow pointing down appears, and an audio alarm is generated.

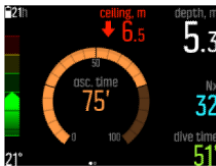

In such a condition, you should descend back below the ceiling level to continue the decompression. If you fail to do so within three (3) minutes, Suunto EON Core locks the algorithm calculation and displays **LOCKED** instead, as shown below. Note that the ceiling value is no longer present.







In this state, you significantly increase your risk of decompression sickness (DCS). Decompression information is not available for the next 48 hours after surfacing.

It is possible to dive with the device when the algorithm is locked, but instead of the decompression information, **LOCKED** is shown. Going to dive mode when algorithm is locked resets the algorithm lock time back to 48 hours when you surface.

3.4. Battery

Suunto EON Core has a rechargeable lithium-ion battery. Charge the battery by connecting Suunto EON Core to a power source with the included USB cable. As a power source use either your computer USB port or wall charger.

The battery icon in the upper-left corner of the display shows the battery status. To the right of the battery icon is the estimated remaining dive time in hours.

Icon	Explanation
	Estimated remaining dive time is 27 hours; no immediate need to recharge
	Estimated remaining dive time is three (3) hours or less; recharge needed
	Estimated remaining dive time is less than one (1) hour; recharge immediately
	Battery is charging, showing current charge level as remaining dive time

When the charge level drops below 2 (two) hours, you cannot start a dive with Suunto EON Core. A pop-up message indicates recharge is needed.

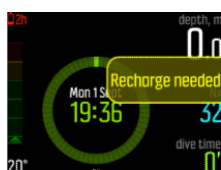

3.5. Bookmark

Keep the lower button pressed to add a bookmark (timestamp) to the active log for later reference.

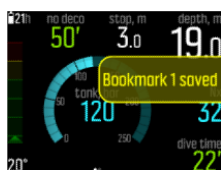

If you save a bookmark while the compass view is active, the bookmark includes both a timestamp and the current compass heading.

3.6. Calendar clock

Time and date settings are found under **General / Device settings / Time & date**.

Time and date formats are found under **General / Device settings / Units and formats**.

To change time and date

1. Keep the middle button pressed to enter menu.
2. Browse to **General / Device settings / Time & date**.
3. Scroll to **Set time** or **Set date** with the upper or lower button.
4. Press the middle button to enter the setting.
5. Adjust the setting with the upper or lower button.
6. Press the middle button to move to the next setting.
7. Press again the middle button when last value is set to save and go back to **Time & date** menu.
8. Keep middle button pressed to exit when done.

To change time and date formats

1. Keep the middle button pressed to enter menu.

2. Browse to **General / Device settings / Units and formats**.
3. Scroll to **Time format** or **Date format** with the upper or lower button.
4. Follow steps 5-8 as above to change and save formats.

3.7. Compass

Suunto EON Core includes a tilt-compensated digital compass, available as a main view.

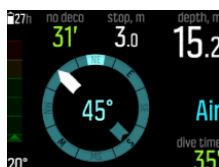

3.7.1. Calibrating compass

When you first start using Suunto EON Core, the compass needs to be calibrated. Suunto EON Core displays the calibration icon when you enter the compass view. Calibrate the compass by slowly rotating the unit in your hand in large figure-8 loops.

Watch the video on [YouTube](#).

During the calibration process, the compass adjusts itself to the surrounding magnetic field.



Because of changes in the surrounding magnetic field, it is recommended to re-calibrate the compass before each dive.

To manually start calibration:

1. Keep the middle button pressed to enter the menu.
2. Browse to **General / Compass**.
3. Press the middle button to enter **Compass**.
4. Scroll up or down to select **Calibrate**.
5. Start calibration by moving the device around in a 3D figure-8 as the image suggests.
6. A sound indicates the calibration succeeded, and the screen goes back to **Compass** menu.

 **NOTE:** *If the calibration fails several times in a row, you may be in an area with strong sources of magnetism, such as large metal objects. Move to another location and try to calibrate the compass again.*

3.7.2. Setting declination

You should always adjust your compass declination for the area where you are diving to get accurate heading readings. Check the local declination from a trusted source and set the value in Suunto EON Core.

To manually start calibration:

1. Keep the middle button pressed to enter the menu.
2. Browse to **General / Compass**.

3. Press the middle button to enter **Compass**.
4. Press the middle button again to enter **Declination**.
5. Scroll up/down to set the angle of declination: Starting from 0.0° scroll up towards East or down towards West declination. To turn declination off, set declination angle to 0.0°.
6. Press middle button to save changes and go back to the **Compass** menu.
7. Keep the middle button pressed to exit.

3.7.3. Setting bearing lock

A bearing is the angle between north and your target. In simple terms, it is the direction you want to travel. Your heading, on the other hand, is your actual direction of travel.

You can set a bearing lock to help you orientate yourself underwater and ensure you maintain your direction of travel. For example, you can set a bearing lock for the direction to the reef before leaving the boat.

You can reset the bearing lock at any time, but you can only clear a bearing lock while at the surface.

To set a bearing lock:

1. Press the middle button to change to the compass view.
2. Hold your Suunto EON Core in level in front of you, with the top pointing in the direction to your target.
3. Keep the lower button pressed until you see the **Bearing locked** notification.

Once you have a bearing locked, the lock position is indicated on the compass rose, as shown below.



Below your heading (large number in center of compass), you also see the relative difference between your bearing and your heading. So, for instance, when you want to travel in the exact direction of your bearing, the lower number should be 0°.

If you want to set a new bearing lock, just repeat the same procedure above. Each bearing lock is recorded in your dive log with a time stamp.

To clear the bearing lock from your compass view, you need to return to the surface.

To clear a bearing lock:

1. While in surface state, keep the middle button pressed to enter the main menu.
2. Scroll to **GENERAL** with the upper or lower buttons and press the middle button.
3. Press the middle button to enter **Compass**.
4. Select **Clear bearing** with the middle button.
5. Keep the middle button pressed to exit.

3.8. Customization

You can customize Suunto EON Core views and features with Suunto DM5. Create up to 10 different dive modes with up to four custom views each.

Watch the video on *YouTube*.

To customize Suunto EON Core:

1. Download and install Suunto DM5 from <http://www.suunto.com/DM5>.
2. Connect your Suunto EON Core to the computer with the USB cable.
3. In the devices window, select Suunto EON Core.
4. Select the **Customization** tab. You can create new dive modes and modify existing ones.

 **NOTE:** When creating or modifying dive modes, you need to synchronize the changes with your Suunto EON Core before disconnecting the USB cable to save the changes to your device.

Customization is divided into four categories:

- Dive mode name
- Dive algorithm
- Gas settings
- Customize views

Dive mode (name)

Maximum length of the name is 15 characters. Use something short and simple that helps you identify easily the features and information that you have customized on this mode.

Dive algorithm

You can select to use Suunto Fused™ RGBM or no algorithm (see 3.30. *Suunto Fused RGBM*). If you select no algorithm, Suunto EON Core functions as a gauge (bottom timer) in that mode. If you select Suunto Fused RGBM, you have two additional options: personal setting (algorithm conservatism) and altitude setting.

Gas settings

Here you configure what you see under the **Gas(es)** menu in Suunto EON Core. The multiple gases option can be turned on or off. Turn it on to be able to dive with multiple gases. When turned off, the gas menu is simplified and easier to use with only one gas.

Helium can also be turned on or off. If you turn this off, you cannot see the helium component for any gases.

The gas max pO₂ setting can be set to manual or fixed. The fixed option means that the selected value is used for all gases and the option to manually edit them in the **Gas(es)** menu is disabled. When manual is selected, you can edit the gas max pO₂ for each gas individually in the **Gas(es)** menu.

Customize views

For each dive mode, you can create up to four custom views. For each view, there are two areas of view customization: style and content.

The style of the mode can be graphical or classic. Graphical style presents information with additional visual elements:

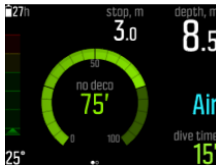

With classic, information is presented in the traditional manner using numbers:



Within each view of the mode, you can define what information is shown in customizable fields. When editing the view in DM5, you get a preview of how it will look on your Suunto EON Core.

In each view, you can define multiple custom field pairs for the values shown in the lower left and right corners. When you use the view in Suunto EON Core, you can cycle through these field pairs by pushing the lower button.

3.9. Decompression dives

If you exceed the no-decompression limit on a dive, Suunto EON Core provides the decompression information required for ascent. Ascent information is always presented with two values:

- **ceiling:** depth that you should not go above
- **asc. time:** optimum ascent time in minutes to surface with given gases

⚠ WARNING: NEVER ASCEND ABOVE THE CEILING! *You must not ascend above the ceiling during your decompression. In order to avoid doing so by accident, you should stay somewhat below the ceiling.*

On a decompression dive, there could be three kinds of stops:

- Safety stop
- Deep stop
- Decompression stop

You can turn deep stops on or off under **Dive settings / Parameters**. In addition, you can adjust the safety stop time to be 3, 4 or 5 minutes.

The illustration below presents how decompression is displayed on Suunto EON Core. When you ascend close to the ceiling depth and enter the deco window area, two arrows appear in front of the ceiling number.

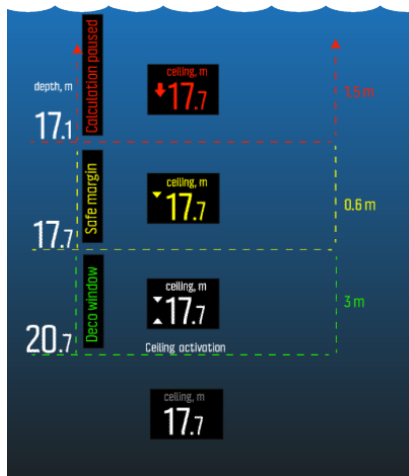

The deco window area is ceiling depth + 3.0 meters (9 ft). This is the area where decompression takes place. The closer to the ceiling you stay, the more optimal the decompression time is.

If you ascend above the ceiling depth, there is still a safe margin area, equal to ceiling depth – 0.6 meters (2 ft). In this safe margin area, decompression calculation still continues, but you are advised to go down below ceiling depth. This is indicated by the ceiling depth number turning yellow with a downward pointing arrow in front of it.

If you go above the safe margin area, the decompression calculation is paused until you go back down below this limit. An audible alarm and a downward arrow in front of a red ceiling number indicate unsafe decompression.

If you ignore the alarm and stay above the safe margin for three minutes, Suunto EON Core locks the algorithm calculation, and decompression information will not be available anymore on the dive. See 3.3. *Algorithm lock*.

Below is a typical decompression dive view showing ascent time and the first required deep stop at 20.3 meters:

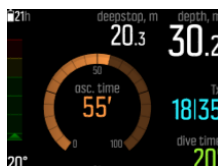

Suunto EON Core shows the ceiling value always from the deepest of these stops. deep stop and safety stop ceilings are always at constant depth when you are at the stop. Stop time is counted down in minutes and seconds.

Below is an example of what Suunto EON Core displays during deep stop:





Below is an example of what Suunto EON Core displays during safety stop:

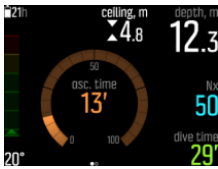

With decompression stops, the ceiling is always decreasing while you are near the ceiling depth, providing continuous decompression with optimum ascent time.

Below is an example of what Suunto EON Core looks like on decompression stop:



 **NOTE:** *It is always recommended to keep close to the decompression ceiling when ascending.*

Ascent time is always the minimum time needed to reach the surface. It includes:

- Time required for deep stops
- Ascent time from depth at 10 m (33 ft) per minute
- Time needed for decompression

 **WARNING:** *YOUR ACTUAL ASCENT TIME MAY BE LONGER THAN DISPLAYED BY THE DIVE COMPUTER! The ascent time will increase if you: (1) remain at depth, (2) ascend slower than 10 m/min (33 ft/min), (3) make your decompression stop deeper than at the ceiling, and/or (4) forget to change the used gas mixture. These factors might also increase the amount of breathing gas required to reach the surface.*

3.10. Display brightness

The brightness of the display can be adjusted under **General / Device settings / Brightness**. The default value is 50%. Adjusting this value has direct impact on battery life.

 **TIP:** *You can significantly extend battery life by turning down the display brightness.*

3.11. Dive history

Dive history is a summary of all the dives done with your Suunto EON Core. The history is divided by the type of dive: Air, Nitrox, Trimix, Gauge, CCR Air/Nitrox and CCR Trimix. CCR dives are categorized by the diluent content used on the dive.

The history is divided by the type of dive: Air, Nitrox, Trimix and Gauge dives are logged separately. Each type summary includes the number of dives, cumulative dive hours and maximum depth.



 **NOTE:** *If there is more history information available than can be shown in a single screen, you can scroll through the additional information with the upper and lower buttons.*

3.12. Dive modes

By default Suunto EON Core has four different dive modes: Air/Nitrox, Trimix, CCR, and Gauge (bottom timer). Select the appropriate mode for your dive under **Dive settings / Mode**.

 **NOTE:** *Air/Nitrox dive mode is a single gas mode. The **Gas(es)** menu under this mode will not allow you to add more than one gas. However, this can be changed through customization. See Customization.*

 **NOTE:** *Air/Nitrox mode is by default in graphical style and all the others in classical visual style. You can change this and other settings, as well as create additional dive modes using Suunto DM5. See Customization.*

Air/Nitrox, Trimix and CCR modes are intended for diving with decompression information, like no decompression stop time or decompression ceiling/ascent time.

By default the decompression algorithm used in Suunto EON Core is Suunto Fused™ RGBM. For more information about the algorithm, see 3.30. *Suunto Fused RGBM*.

Gauge is a bottom timer mode and thus has no decompression information or calculation included.

 **NOTE:** *After diving in gauge mode, decompression calculation is locked for 48 hours. If during this time you dive with Air/Nitrox, Trimix or CCR mode, there is no decompression calculation available and **ERROR** is shown in decompression information fields.*

3.13. Dive planner

The dive planner in Suunto EON Core helps you to quickly plan your next dive. The planner displays available no decompression time and gas times for your dive based on depth and gas mixture.

The dive planner can also help you plan dives in series, taking into account the residual nitrogen from your previous dive(s) based on the planned surface time you enter.

Before planning your first dive, make sure you have gone through the planner settings and configured them according to your personal preference. You can view the planner and adjust settings under the **Dive planner** menu.

These settings include tank size and pressure at the start of the dive as well as personal gas consumption (surface gas consumption). If you are not sure what your personal gas consumption is, we recommend using the default value of 25 L/min (0.90 cubic ft/min).

 **NOTE:** *Estimated gas time is calculated based on tank pressure at start minus 35 bar (510 psi).*

The calculated no decompression time is based on dive depth and gas mixture. Any residual nitrogen from previous dives, as well as surface time, is taken into consideration. **GAS TIME** is dependent on the dive depth, personal consumption and tank size/pressure.

In the dive planner display, you can edit depth and mixture.

For example, for the first dive in a series, if you enter 18 meters and use a mixture of 21% oxygen, you see the following:

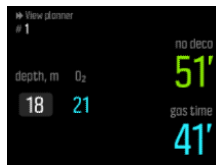

In this example, the calculated values are:

- Dive number in the dive series: 1
- Available no decompression time: 51 minutes
- Remaining gas time: 41 minutes

When planning additional dives in series, the dive planner allows you to adjust surface time. In the example below, the surface time before the second dive is 1:37 minutes. Adjust surface time to see how it impacts no decompression time.



3.14. Flip display

You can flip the display of Suunto EON Core to have the buttons on either the left or right side of the dive computer, making it easier to wear on either arm.

Change the button orientation under **General / Device settings / Flip display**. Select **Buttons right** to have the buttons on the right-hand side or **Buttons left** to have them on the left-hand side.

3.15. Gas consumption

Gas consumption refers to your real-time consumption rate of gas during a dive. In other words, it is the amount of gas a diver would use in one minute on the surface. This is commonly known as your surface air consumption or SAC rate.

Gas consumption rate is measured in liters per minute (cubic feet per minute). This is an optional field and needs to be added to your custom dive mode views in DM5. In the classic view below, gas consumption rate is in the lower right-hand corner.



To enable gas consumption

1. Add the gas consumption field to your custom dive mode in DM5. See *Customization*.
2. Install and pair a Suunto Tank POD. See 3.31. *Tank pressure*.
3. After you have selected the correct gas and returned to the main time view, keep the middle button pressed to enter menu.
4. Scroll to **Gases** with the lower button and select with the middle button.

5. Scroll to the gas you just selected from your Tank POD and select with the middle button.
6. Scroll to **Tank size** and select with the middle button.
7. Check the tank size and change the size with the upper or lower button as needed. Confirm change with the middle button.
8. Keep the middle button pressed to exit the menu.

 **NOTE:** For accurate gas consumption, you must define the tank size. Not defining the tank size leads to incorrect gas consumption readings.

3.16. Gas time

Gas time refers to remaining air (gas) left with current gas mixture, measured in minutes. The time is based on tank pressure value and your current breathing rate.

Gas time is also highly dependent on your current depth. For example, all other factors being the same, including breathing rate, tank pressure and tank size, depth affects gas time as follows:

- At 10 m (33 ft, surrounding pressure 2 bar), gas time is 40 minutes.
- At 30 m (99 ft, surrounding pressure 4 bar), gas time is 20 minutes.
- At 70 m (230ft, surrounding pressure 8 bar), gas time is 10 minutes.

Gas time is a default field in the lower right-hand corner of default dive modes. If you have not paired a Suunto Tank POD, the gas time field shows n/a. If you have paired a POD but there is no data being received, the field shows –. This may be because the POD is not in range, the tank is closed, or the POD battery is low.



3.17. Gas mixtures

If Nitrox or Trimix dive mode is selected, you need to define the gas(es) for the decompression algorithm to work properly. You define the gases under **Gas(es)**. In Nitrox mode, gas will have only oxygen (O₂%). Trimix mode has helium (He%) available, and there is also the possibility to choose multiple gases.

 **NOTE:** When you have analyzed your gas, you should round the result down when entering it for EON Steel. For example, if the analyzed gas is 31.8% oxygen, then define the gas as 31%. This makes the decompression calculations safer. Oxygen calculations (pO₂, OTU, CNS%) are also kept conservative, since the oxygen percent used for those are O₂% + 1.

 **WARNING:** THE DIVE COMPUTER WILL NOT ACCEPT FRACTIONAL PERCENTAGE VALUES OF OXYGEN CONCENTRATION. DO NOT ROUND UP FRACTIONAL PERCENTAGES! Rounding up will cause nitrogen percentages to be understated and will affect decompression calculations.

 **NOTE:** You can customize what you see in the **Gas(es)** menu. See Customization.

It is important to understand how the **Gas(es)** menu works on Trimix mode, where you can make use of multiple gases. In the example below, the menu has three gases and tx18/45 is selected as the active gas. Even though only one gas is active, the decompression algorithm calculates ascent time (during dive) using all these three gases.

To select another active gas:

1. While in the **Gas(es)** menu, press the middle button to see gas options.
2. Scroll with upper or lower buttons to highlight Select.
3. Press the middle button again to confirm.



If you are diving with only one gas, ensure you have only that one gas in the **Gas(es)** menu. Otherwise, Suunto EON Core expects you to use all gases in the list and notifies you to change gases during the dive.

 **NOTE:** When you select CCR mode, gas mixtures are divided to open-circuit and closed-circuit gases. See *Rebreather diving*.

3.18. Language and unit system

You can change the device language and unit system from the settings under **General » Device settings**.

You can change these settings at any time. Suunto EON Core refreshes immediately to reflect the changes.

Under the unit settings, you have the option of selecting metric or Imperial as a global setting, meaning the affect all measurements. Alternative, you can choose **Advanced** which allows you to set the unit system for specific measurements. For example, you could use metric for depth, and Imperial for tank pressure.

3.19. Logbook

Dive logs can be found under **Logs**. By default, they are listed by date and time, and each entry listing shows the max. depth and dive time of the log.



Dive log details and profile can be browsed by scrolling through the log with upper or lower button and selecting it with the middle button.

Each dive log contains data samples with fixed 10-second intervals. The dive profile includes a cursor for browsing the logged data, scrollable with upper and lower buttons. For more detailed log analyses, upload the dive(s) to Suunto DM5 (see 3.29. *Suunto DM5 and Movescount*).

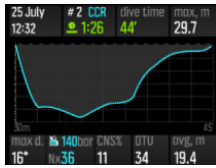

When the logbook memory gets full, the oldest dives are deleted to make space for new ones.

 **NOTE:** If you surface and then dive again within five minutes, Suunto EON Core counts this as one dive.

3.20. Multi-gas diving

Suunto EON Core allows gas changes during a dive between the gases defined in the **Gas(es)** menu. When ascending, you are always notified to change gases when a better gas is available.

For example, you may have the following gases when diving to 55 m (180.5 ft):

- tx18/45, MOD 58m
- tx50/10, MOD 21m
- oxygen, MOD 6m

While ascending, you are notified to change gas at 21 m (70 ft) and 6 m (19.7 ft) according to the maximum operating depth (MOD) of the gas.

A pop-up notifies you when to change gases, as shown below:

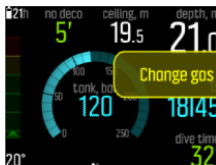

 **WARNING:** When diving with multiple gases, remember that the ascent time is always calculated with the assumption that you use all the gases found in the **Gas(es)** menu. Always check that you have only the gases for your current planned dive defined before you dive. Remove the gases that are not available for the dive.

3.21. Movescount mobile app

With the Suunto Movescount App, you can easily transfer your dive logs to Movescount where you can follow and share your diving adventures.

To pair with Suunto Movescount App on iOS:

1. Download and install Suunto Movescount App on your compatible Apple device from the iTunes App Store. The app description includes the latest compatibility information.
2. Start Suunto Movescount App and turn on Bluetooth if it is not on already. Leave the app running in the foreground.
3. If you have not yet set up your Suunto EON Core, do so now (see *Getting started*).
4. Tap the settings icon in the upper right and tap on the '+' icon to add a new device.
5. Tap on your dive computer from the list of found devices and enter the passkey shown on the Suunto EON Core display.

To pair with Suunto Movescount App on Android:

1. Download and install Suunto Movescount App on your compatible Android device from Google Play. The app description includes the latest compatibility information.
2. Start Suunto Movescount App and turn on Bluetooth if it is not on already. Leave the app running in the foreground.
3. If you have not yet set up your Suunto EON Core, do so now (see *Getting started*).
4. A pop-up screen opens on your Android device. Select [Pair] .
5. Enter the passkey shown on your dive computer display into the pairing request field on your mobile device and tap [OK] .

3.22. Personal and altitude adjustments

There are several factors that can affect your susceptibility to DCS. Such factors vary between divers, as well as from one day to another.

The personal factors which tend to increase the possibility of DCS include:

- exposure to low temperature – water temperature less than 20 °C (68 °F)
- below average physical fitness level
- fatigue
- dehydration
- stress
- obesity
- patent foramen ovale (PFO)
- exercise before or after dive

⚠ WARNING: SET THE CORRECT PERSONAL SETTING! *Whenever it is believed that factors that tend to increase the possibility of DCS exist, it is recommended that you use this option to make the calculations more conservative. Failure to select the correct personal setting will result in erroneous dive and planning data.*

The five-step personal setting can be used to adjust the algorithm conservatism to fit your DCS susceptibility. You can find the setting under **Dive settings / Parameters / Personal**.

Personal level	Explanation
More aggressive (-2)	Ideal conditions, excellent physical fitness, highly experienced with a lot of dives in the near past
Aggressive (-1)	Ideal conditions, good physical fitness, well experienced with dives in the near past
Default (0)	Ideal conditions (default value)
Conservative (+1)	Some risk factors or conditions exist
More conservative (+2)	Several risk factors or conditions exist

⚠ WARNING: *Personal adjustment setting 0, -1 or -2 causes a high risk of DCS, or other personal injury, and death.*

In addition to the personal setting, Suunto EON Core can be adjusted for diving at different altitudes. This setting automatically adjusts the decompression calculation according to the given altitude range. You can find the setting under **Dive settings / Parameters / Altitude** and select from three ranges:

- 0 – 300 m (0 – 980 ft) (default)
- 300 – 1500 m (980 – 4900 ft)
- 1500 – 3000 m (4900 – 9800 ft)

 **WARNING:** *Traveling to a higher elevation can temporarily cause a change in the equilibrium of dissolved nitrogen in the body. It is recommended that you acclimatize to the new altitude before diving.*

3.23. Oxygen calculations

During a dive, Suunto EON Core calculates partial pressure of oxygen (pO_2), central nervous system toxicity (CNS%) and pulmonary oxygen toxicity, tracked by OTU (oxygen toxicity units). The oxygen calculations are based on currently accepted exposure time limit tables and principles.

By default in Air/Nitrox dive mode, CNS% and OTU values are not displayed until they reach 80% of their recommended limits. When either value reaches 80%, EON Steel notifies you and the value stays in the view. In default Trimix mode, CNS% and OTU values are displayed in the bottom-right corner field as scrollable info.

 **NOTE:** *You can customize views to always show CNS% and OTU.*

3.24. Rebreather diving

By default Suunto EON Core has one mode dedicated to rebreather diving, CCR mode. This mode uses fixed high/low setpoint values which you can modify in the dive computer or through DM5.

Fixed setpoint calculation enables Suunto EON Core to be used as a backup dive computer on rebreather dives. It does not control or monitor the rebreather unit in any way.

When you select CCR mode (see *Dive modes*), the gases menu is split into two: **CC gases** (closed-circuit gases) and **OC gases** (open-circuit gases).

 **NOTE:** *For rebreather dives, Suunto EON Core should be used as a backup device only. The primary control and monitoring of your gases should be done through the rebreather itself.*

3.24.1. Closed-circuit gases

On a rebreather dive, you need at minimum two closed-circuit gases: one is your pure oxygen tank, and the other is a diluent. You can define additional diluents as needed.

The correct oxygen and helium percentages of the diluent gas(es) in your diluent cylinder(s) must always be entered into the dive computer (or through DM5) to ensure correct tissue and oxygen calculation. Diluent gas(es) used on a rebreather dive are found under **CC gases** in the main menu.

3.24.2. Open-circuit gases

As with closed-circuit gases, you must always define the correct oxygen and helium percentages of open-circuit gases (bailout gases) to ensure correct tissue and oxygen calculation.

Follow the same procedure as the CC gases to define your open-circuit gases under the **OC Gases** settings.

After entering values for **Mix1**, you can create additional mixes, **Mix2** to **Mix8**. Each additional mix can be primary, secondary, or off. **Mix1** is always set as a primary gas.

To minimize the risk of error during a dive, it is highly recommended that the mixes are set in the proper order. This means that as the mix number rises, so does oxygen content. This is the order they are usually used during the dive. Before a dive, only enable the mixes you actually have available and remember to check the set values to ensure they are correct.

The ascent time is calculated based on the assumption that you start the ascent profile immediately and all the primary gases are changed as soon as their maximum operating depth allows it. That is, using the gases that are set as primary, the most optimal ascent schedule for the moment is calculated.

To see the most pessimistic ascent schedule, that is, a schedule for the situation when gases are not changed at all, you can set the gases as secondary and the time it takes to finish the decompression using the current breathing gas is shown as the ascent time.

Showing the most pessimistic ascent schedule during a long dive may result in the ascent time no longer fitting the reserved field, and the dive watch displays '—'.



NOTE: While setting the gases, notice that the calculated maximum operating depth is displayed in the upper field. You cannot change to this gas before you have ascended above this depth.

3.24.3. Setpoints

CCR mode has two setpoint values, low and high. Both are configurable:

- Low setpoint: 0.4 – 0.9 (default: 0.7)
- High setpoint: 1.0 – 1.6 (default: 1.3)

Typically you do not need to modify the default setpoint values. However, you can change them as needed either in DM5 or under the main menu.

To change setpoint values in Suunto EON Core:

1. While in surface state, keep middle button pressed to enter main menu.
2. Scroll to **Setpoint** with the upper button and select with the middle button.
3. Scroll to **Low setpoint** or **High setpoint** and select with the middle button.
4. Adjust the setpoint value with the lower or upper button and accept with the middle button.
5. Keep middle button pressed to exit menu.

Setpoint switching

Setpoints can be switched automatically according to depth. By default the low setpoint switch depth is 4.5 m (15 ft), and the high setpoint switch depth is 21 m (70 ft).

The auto setpoint switching is off by default for the low setpoint and on for the high setpoint.

To change auto setpoint switching in Suunto EON Core:

1. While in surface state, keep middle button pressed to enter main menu.
2. Scroll to **Setpoint** with the upper button and select with the middle button.
3. Scroll to **Switch low** or **Switch high** and select with the middle button.
4. Adjust the depth value for the setpoint switch with the lower or upper button and accept with the middle button.
5. Keep middle button pressed to exit menu.

Popup notifications indicate when the setpoint is switched.

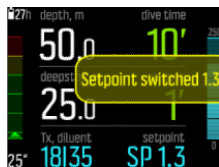

During a rebreather dive, you can also switch to a custom setpoint at any time.

To change to a custom setpoint:

1. While diving in CCR mode, keep middle button pressed to enter main menu.
2. Scroll to **Custom setpoint** and select with the middle button.
3. Adjust the setpoint value as needed with the lower or upper button and accept with the middle button.

A popup notification confirms the custom setpoint switch.



3.24.4. Bailouts

If at any point during a rebreather dive you suspect a malfunction of any sort, you should switch to a bailout gas and abort the dive.

To change to a bailout gas:

1. Keep the middle button pressed to enter main menu.
2. Scroll to **OC gases** and select with middle button.
3. Scroll to the desired bailout gas and select with the middle button.

After a bailout gas is selected, the setpoint field is replaced with the pO₂ value of the selected open-circuit gas.

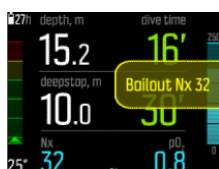

If the malfunction is rectified or the dive situation otherwise normalizes, you can switch back to a diluent using the same procedure as below, but selecting from **CC gases**.

3.25. Safety stops and deepstops

A three (3) minute safety stop is always recommended for every dive over 10 meters (19.7 ft).

The time for a safety stop is calculated when you are between 2.4 and 6 m (7.9 and 19.7 ft). This is presented with up/down arrows in front of the stop depth. The safety stop time is shown in minutes and seconds. The time may exceed three (3) minutes if you ascend too fast during dive.



Deepstops activate when you dive deeper than 20 m (65.6 ft). Deepstops are presented like safety stops. You are in the deepstop area when the deepstop depth has up/down arrows in front of it and deepstop time is running.



 **NOTE:** For safety reasons, you cannot switch off deepstops if helium (trimix gas mixtures) is enabled for the dive mode in use.

3.26. Sample rate

Suunto EON Core uses a fixed sample rate of 10 seconds for all log recordings.

3.27. Standby and deep sleep

Standby and deep sleep are two functions that are designed to prolong battery life. Standby is an adjustable mode that turns off the screen after a set amount of time if Suunto EON Core is not used.

To adjust the standby time:

1. Keep the middle button pressed to enter the menu.
2. Browse to **General / Device settings / Standby**.
3. Press the middle button to enter Standby.
4. Scroll up/down to select the desired standby time in minutes.
5. Press the middle button to save changes and return to the Device settings menu.
6. Keep the middle button pressed to exit.

Deep sleep

Deep sleep is a function that prolongs battery life when Suunto EON Core has not been used for some time. Deep sleep is activated when two days have passed since:

- No buttons have been pressed
- Suunto EON Core has been attached to PC/charger
- Dive calculation has ended

Suunto EON Core wakes up when it is connected to a PC/charger, when a button is pressed, or when the water contact gets wet.

3.28. Surface and no-fly time

After a dive, Suunto EON Core displays surface time since the previous dive and a countdown time for recommended no-fly time. During the no-fly time, flying or traveling to higher altitude should be avoided.



No-fly time is always at least 12 hours and equals desaturation time when it is more than 12 hours. For desaturation times shorter than 70 minutes, no no-fly time is displayed.

If decompression is omitted during a dive so that Suunto EON Core enters permanent error mode (see 3.3. *Algorithm lock*), the no-fly time is always 48 hours. Similarly, if dive is done in gauge mode (bottom timer), the no-fly time is 48 hours.

⚠ WARNING: YOU ARE ADVISED TO AVOID FLYING ANY TIME THE COMPUTER COUNTS DOWN THE NO-FLY TIME. ALWAYS ACTIVATE THE COMPUTER TO CHECK THE REMAINING NO-FLY TIME PRIOR TO FLYING! Flying or traveling to a higher altitude within the no-fly time can greatly increase the risk of DCS. Review the recommendations given by Divers Alert Network (DAN). There can never be a flying-after-diving rule that is guaranteed to completely prevent decompression sickness!

3.29. Suunto DM5 and Movescount

The Suunto DM5 software program allows you to track and analyze all of your dive logs and plan your future dives. With DM5 you can customize your Suunto EON Core and update the device firmware. Download Suunto DM5 from www.suunto.com/dm5.



NOTE: Mono framework is required when using DM5 on a Mac.

Movescount is an online sports community that integrates with Suunto DM5. Through Movescount you can share your dives with others.

3.30. Suunto Fused RGBM

Suunto's decompression model development originates from the 1980s when Suunto implemented Bühlmann's model based on M-values in Suunto SME. Since then research and development has been ongoing with the help of both external and internal experts.

In the late 1990s, Suunto implemented Dr. Bruce Wienke's RGBM (Reduced Gradient Bubble Model) bubble model to work with the earlier M-value based model. The first commercial products with the feature were the iconic Suunto Vyper and Suunto Stinger. With these products the improvement of diver safety was significant as they addressed a number of diving circumstances outside the range of dissolved-gas-only models by:

- Monitoring continuous multiday diving
- Computing closely spaced repetitive diving
- Reacting to a dive deeper than the previous dive

- Adapting to rapid ascents which produce high microbubble (silent-bubble) build-up
- Incorporating consistency with real physical laws for gas kinetics

In Suunto Fused™ RGBM the tissue half-times are derived from Wienke's FullRGBM where human body is modeled by fifteen different tissue groups. FullRGBM can utilize these additional tissues and model the on-gassing and off-gassing more accurately. The amounts of nitrogen and helium on-gassing and off-gassing in the tissues are calculated independently from each other.

The advantage of Suunto Fused RGBM is additional safety through its ability to adapt to a wide variety of situations. For recreational divers it may offer slightly longer no-deco times, depending on the chosen personal setting. For open-circuit technical divers it allows use of gas mixes with helium - on deeper and longer dives helium based gas mixes provide shorter ascent times. And finally, for rebreather divers the Suunto Fused RGBM algorithm gives the perfect tool to be used as a non-monitoring, set point dive computer.

3.31. Tank pressure

Your Suunto EON Core can be used with multiple Suunto Tank PODs for wireless tank pressure transmission.

To install and pair a Suunto Tank POD:

1. Install the Tank POD and open the valve.

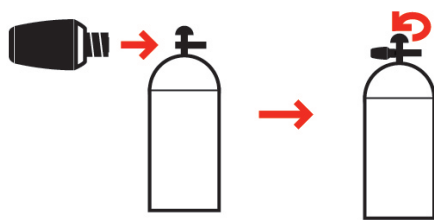

2. Wait for green LED on Tank POD to flash.
3. If your Suunto EON Core has a blank screen, press any key to activate it.
4. Hold your Suunto EON Core close to the Tank POD as shown.

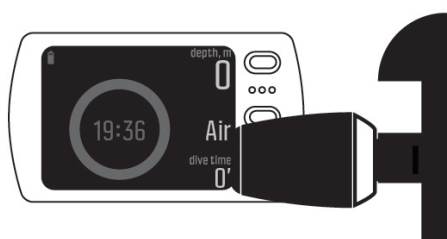

5. After a few seconds, a menu pops up on the screen showing the Tank POD serial number, battery status and the tank pressure. From the menu, select the correct gas for that Tank POD.



⚠ WARNING: The battery level indication shown when pairing the Tank POD is an approximation only. The POD battery may deplete faster than the indication suggests.

📝 NOTE: We recommend changing the Tank POD battery after completing 200 dives or 2 years.

Repeat the procedure above for additional Tank PODs and select different gases for each POD.

📝 NOTE: You cannot pair another Tank POD unless you have a second gas defined in Suunto EON Core.

Alternatively, you can select which Tank POD to use with each gas by selecting a Tank POD for the gas in question in the **Gas(es)** menu. When using this method, ensure the Tank POD has been activated by ensuring there is tank pressure reading in screen and that it is within range. In the menu, the Tank POD is identified by the serial number printed on the Tank POD.

In the dive main views, only one tank pressure is shown and corresponds to the active gas. When the gas is changed, the displayed tank pressure is also changed accordingly.

⚠ WARNING: If there are several divers using Tank PODs, always check before you dive that the POD number of your selected gas corresponds to the serial number on your POD.

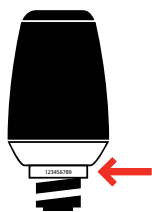

⚠ CAUTION: Never lift or carry your tank by holding the wireless tank pressure transmitter as this may break the cover and cause flooding of the unit. If your tank falls down with the transmitter attached to the regulator first stage, ensure that the transmitter has not been damaged before diving with it.

🗨 TIP: Remove pressure from the Tank Pod when not diving to save battery life.

3.32. Timer

Suunto EON Core has a timer that can be used for timing specific actions during surface or dive. The timer is shown in bottom-right corner as scrollable item.



NOTE: *The timer can also be customized to be in graphical style as an analog watch in the center of the display.*

To use the timer:

1. While diving, press upper button to start the timer.
2. Press again the upper button to pause the timer.
3. Keep the upper button pressed to reset the timer.

Timer start and stop actions are saved to the dive log.

3.33. Water contacts

The water contact is located on the side of the case near the USB cable port. When submerged, the water contact poles are connected by the conductivity of the water. Suunto EON Core switches to dive state when water is detected and the depth gauge senses water pressure at 1.2 m (4 ft).

4. Care and support

4.1. Handling guidelines

Handle Suunto EON Core with care. The sensitive internal electronic components may be damaged if the device is dropped or otherwise mishandled.

Do not try to open or repair Suunto EON Core by yourself. If you are experiencing problems with the device, please contact your nearest authorized Suunto Service Center.

 **WARNING:** ENSURE THE WATER RESISTANCE OF THE DEVICE! Moisture inside the device and/or battery compartment may seriously damage the unit. Only an authorized Suunto Service Center should do service activities.

Wash and dry the dive computer after use. Rinse very carefully after any salt-water dive.

Pay special attention to the pressure sensor area, water contacts, pushers, and USB cable port. If you use the USB cable before washing the dive computer, the cable (device end) should be rinsed as well.

After use, rinse it with fresh water, mild soap, and carefully clean the housing with a moist soft cloth or chamois.

 **NOTE:** Do not leave your Suunto EON Core in a bucket of water (for rinsing). The display stays on under water and consumes battery life.

Use only original Suunto accessories - damage caused by non-original accessories is not covered by warranty.

 **TIP:** Remember to register your Suunto EON Core at www.suunto.com/support to get personalized support.

4.2. Water resistance

Suunto EON Core is water resistant to 80 meters (262 ft) in compliance with the dive watch standard ISO 6425.

 **WARNING:** Water resistance is not equivalent to maximum operating depth. The maximum operating depth of this dive computer is 150 meters (592 ft).

To maintain water resistance, it is recommended to:

- never use the device for other than intended use.
- contact an authorized Suunto service center, distributor or retailer for any repairs.
- keep the device clean from dirt and sand.
- never attempt to open the case yourself.
- avoid subjecting the device to rapid air and water temperature changes.
- always clean your device with fresh water if subjected to salt water.
- never knock or drop the device.

4.3. Installing scratch guard

Use the provided scratch guard to help protect your Suunto EON Core from scratches.

To install the scratch guard:

1. Ensure the display glass is clean and dry.
2. Peel back the protective layer from one end of the scratch guard.
3. Place exposed adhesive side down squarely on one end of the display.
4. Pull back the protective layer from the scratch guard.
5. Press out any air bubbles with a soft, straight edge tool.

Watch the video on : *YouTube*.

4.4. Charging battery

Fully charged, Suunto EON Core provides min. 20 hours of dive time. The expected lifetime of the rechargeable lithium-ion battery is 500 cycles.

Charge Suunto EON Core with the supplied USB cable. Connect the cable to a USB wall charger or a computer USB port. If the battery is very low, the display remains dark while charging until the battery has reached an adequate charge level.

 **CAUTION:** *DO NOT use the USB cable when Suunto EON Core is wet. This may cause an electrical failure. Ensure the cable connector and connector pin area on the device are both dry. If you are using a protective boot, remove the boot from the connector pin area to clear any residual water droplets.*

 **NOTE:** *When connected, you may experience a tingling sensation when touching a metallic computer housing and Suunto EON Core. This is caused by a minor electrical current created when the wall plug to the computer is not grounded.*

 **CAUTION:** *DO NOT allow the connector pins of the USB cable to touch any conductive surface. This may short circuit the cable, making it unusable.*

The charging AC/DC mains supply shall meet the clause 2.5 of the standard for limited power supply of IEC 60950-1. Rechargeable batteries have a limited number of charge cycles and may eventually need to be replaced. The battery should be replaced only by authorized Suunto Service Centers.

4.5. Changing strap to bungee

You can change between the wrist strap and bungee as needed. The bungee is provided as an option.

To install the bungee:

1. Remove both strap ends using a TORX T7 (non-IP) screwdriver.
2. Attach the bungee adapters.
3. Thread the cord through both adapters.
4. Securely tie the ends of the bungee cord and cut off excess cord.

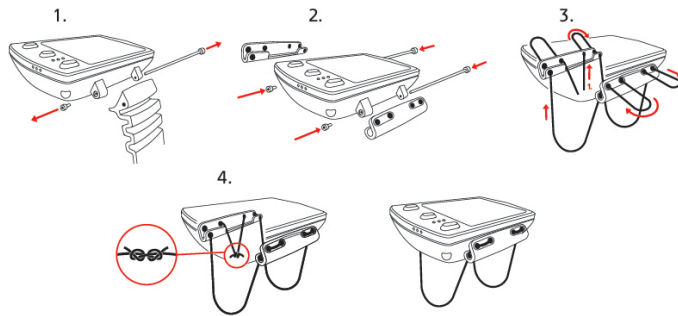

4.6. Getting support

To get additional support, visit www.suunto.com/support. There you will find a comprehensive range of support materials, including Questions and Answers and instruction videos. You can also post questions directly to Suunto or email/call Suunto support professionals.

There are also many how-to videos on the Suunto YouTube channel at www.youtube.com/user/MovesCountbySuunto.

We recommend registering your product at www.suunto.com/support/ to get the best personalized support from Suunto.

To get support from Suunto:

1. First visit Suunto.com (www.suunto.com/support) to see if your question has been asked/answered already.
2. If you cannot find an answer to your question online, submit a question using the form available at suunto.com/support.
3. Call Suunto. See the latest list of numbers on the last page of this guide or at www.suunto.com/support. Suunto's qualified customer support staff will help you and, if needed, troubleshoot your product during the call.

5. Reference

5.1. Technical specifications

Dimensions and weight:

- Length: 80 mm / 3.15 in
- Width: 55 mm / 2.17 in
- Height: 21 mm / 0.83 in
- Weight: 154 g / 5.43 oz

Operating conditions

- Normal altitude range: 0 to 3,000 m / 10,000 ft above sea level
- Operating temperature: 0°C to 40°C / 32°F to 104°F
- Storage temperature: -20°C to +50°C / -4°F to +122°F
- Maintenance cycle: 500 hours of diving or two years, whichever comes first



NOTE: Do not leave the dive computer in direct sunlight!

Depth gauge

- Temperature compensated pressure sensor
- Maximum depth of operation: 150 m / 492 ft (complying with EN 13319)
- Maximum static pressure: 15 bar (complying with EN 13319 and ISO 6425)
- Accuracy: $\pm 1\%$ of full scale or better from 0 to 150 m / 492 ft at 20°C / 68°F (complying with EN 13319)
- Depth display range: 0 to 300 m / 984 ft
- Resolution: 0.1 m from 0 to 100 m / 1 ft from 0 to 328 ft; 1 m from 100 to 150 m / 1 ft from 328 to 392 ft

Temperature display

- Resolution: 1°C / 1.5 °F
- Display range: -20 to +50°C/-4 to +122°F
- Accuracy: $\pm 2^\circ\text{C}/\pm 3.6^\circ\text{F}$ within 20 minutes of temperature change

Displays in mixed gas dive mode

- Helium %: 0–95
- Oxygen %: 5–99
- Oxygen partial pressure display: 0.0–3.0 bar
- CNS%: 0–500% with 1% resolution
- OTU: 0-500

Other displays

- Dive time: 0 to 999 min
- Surface time: 0 to 99 h 59 min
- Dive counter: 0 to 99 for repetitive dives
- No-decompression time: 0 to 99 min (>99 above 99)
- Ascent time: 0 to 999 min (- - after 999)
- Ceiling depths: 3.0 to 150 m / 10 to 492 ft

Calendar clock

- Accuracy: ± 25 s/month (at 20°C/68°F)
- 12/24 h display

Compass

- Accuracy: $\pm 15^\circ$
- Resolution: 1°
- Max. tilt: 45 degrees
- Balance: global

Timer

- Accuracy: 1 second
- Display range: 0'00 – 99'59
- Resolution: 1 second

Logbook

- Sample rate: 10 seconds
- Memory capacity: approximately 200 hours of diving

Tissue calculation model

- Suunto Fused™ RGBM algorithm (developed by Suunto and Bruce R. Wienke, BSc, MSc, PhD)
- 15 tissue compartments
- Tissue compartment halftimes for nitrogen: 1, 2, 5, 10, 20, 40, 80, 120, 160, 240, 320, 400, 480, 560 and 720 min. The on-gassing and off-gassing halftimes are the same.
- Tissue compartment halftimes are divided by a constant factor to obtain helium halftimes.
- Reduced gradient (variable) M-values based on diving habit and dive violations. The M-values are tracked up to 100 hours after a dive
- The exposure calculations (CNS% and OTU) are based on recommendations by R.W. Hamilton, PhD and currently accepted exposure time limit tables and principles.

Battery

- Type: rechargeable lithium-ion
- Battery life: fully charged, min. 20h dive time

The following conditions have an effect on the expected battery lifetime:

- The conditions in which the unit is operated and stored (for example, temperature/cold conditions). Below 10°C/50°F the expected battery lifetime is about 50- 75% of that at 20°C/68°F.
- The quality of the battery. Some lithium batteries may exhaust unexpectedly, which cannot be tested in advance.

 **NOTE:** *Low temperature or an internal oxidation of the battery may activate the battery warning even though the battery has enough capacity. In this case, the warning usually disappears when the dive mode is activated again.*

Radio receiver

- Bluetoothfi Smart compatible
- communication frequency: 2.4 GHz
- range: ~3 m/9.8 ft

5.2. Compliance

5.2.1. CE

Hereby, Suunto Oy, declares that this radio equipment type DW171 is in compliance with Directive 2014/53/EU. The full text of the EU declaration of conformity is available at the following internet address: www.suunto.com/EUconformity.

The radio equipment operates at 2.4 GHz ISM frequency band(s) and 1 mW maximum power.

5.2.2. EN 13319

EN 13319 is a European diving depth gauge standard. Suunto dive computers are designed to comply with this standard.

5.2.3. EN 250 and FIOH

The tank pressure gauge and dive instrument parts used in measuring the tank pressure meet the requirements set in the section of the European Standard EN 250 that concern tank pressure measurements. FIOH, notified body no.0430, has EC type-examined this type of personal protective equipment.

5.2.4. FCC compliance

This device complies with Part 15 of the FCC Rules. Operation is subject to the following two conditions:

- (1) this device may not cause harmful interference, and
- (2) this device must accept any interference received, including interference that may cause undesired operation. This product has been tested to comply with FCC standards and is intended for home or office use.

Changes or modifications not expressly approved by Suunto could void your authority to operate this device under FCC regulations.

Note: This equipment has been tested and found to comply with the limits for a Class B digital device, pursuant to part 15 of the FCC Rules. These limits are designed to provide reasonable protection against harmful interference in a residential installation. This equipment generates, uses and can radiate radio frequency energy and, if not installed and used in accordance with the instructions, may cause harmful interference to radio communications. However, there is no guarantee that interference will not occur in a particular installation. If this equipment does cause harmful interference to radio or television reception, which can be determined by turning the equipment off and on, the user is encouraged to try to correct the interference by one or more of the following measures:

- Reorient or relocate the receiving antenna.
- Increase the separation between the equipment and receiver.
- Connect the equipment into an outlet on a circuit different from that to which the receiver is connected.
- Consult the dealer or an experienced radio/TV technician for help.

5.2.5. ISED

This device complies with Industry Canada licence-exempt RSS standard(s). Operation is subject to the following two conditions:

- (1) this device may not cause interference, and
- (2) this device must accept any interference, including interference that may cause undesired operation of the device.

Le présent appareil est conforme aux CNR d'Industrie Canada applicables aux appareils radio exempts de licence. L'exploitation est autorisée aux deux conditions suivantes : (1) l'appareil ne doit pas produire de brouillage, et (2) l'utilisateur de l'appareil doit accepter tout brouillage radioélectrique subi, même si le brouillage est susceptible d'en compromettre le fonctionnement.

Suunto OY, has not approved any changes or modifications to this device by the user. Any changes or modifications could void the user's authority to operate the equipment.

Suunto Oy, n'approuve aucune modification apportée à l'appareil par l'utilisateur, quelle qu'en soit la nature. Tout changement ou modification peuvent annuler le droit d'utilisation de l'appareil par l'utilisateur.

5.5. International Limited Warranty

Suunto warrants that during the Warranty Period Suunto or a Suunto Authorized Service Center (hereinafter Service Center) will, at its sole discretion, remedy defects in materials or workmanship free of charge either by a) repairing, or b) replacing, or c) refunding, subject to the terms and conditions of this International Limited Warranty. This International Limited Warranty is valid and enforceable regardless of the country of purchase. The International Limited Warranty does not affect your legal rights, granted under mandatory national law applicable to the sale of consumer goods.

Warranty Period

The International Limited Warranty Period starts at the date of original retail purchase.

The Warranty Period is two (2) years for Products and Dive wireless transmitters unless otherwise specified.

The Warranty Period is one (1) year for accessories including but not limited to wireless sensors and transmitters, chargers, cables, rechargeable batteries, straps, bracelets and hoses.

Exclusions and Limitations

This International Limited Warranty does not cover:

1. a. normal wear and tear such as scratches, abrasions, or alteration of the color and/or material of non-metallic straps, b) defects caused by rough handling, or c) defects or damage resulting from use contrary to intended or recommended use, improper care, negligence, and accidents such as dropping or crushing;
2. printed materials and packaging;
3. defects or alleged defects caused by use with any product, accessory, software and/or service not manufactured or supplied by Suunto;

4. non-rechargeable batteries.

Suunto does not warrant that the operation of the Product or accessory will be uninterrupted or error free, or that the Product or accessory will work with any hardware or software provided by a third party.

This International Limited Warranty is not enforceable if the Product or accessory:

1. has been opened beyond intended use;
2. has been repaired using unauthorized spare parts; modified or repaired by unauthorized Service Center;
3. serial number has been removed, altered or made illegible in any way, as determined at the sole discretion of Suunto; or
4. has been exposed to chemicals including but not limited to sunscreen and mosquito repellents.

Access to Suunto warranty service

You must provide proof of purchase to access Suunto warranty service. You must also register your product online at www.suunto.com/mysuunto to receive international warranty services globally. For instructions how to obtain warranty service, visit www.suunto.com/warranty, contact your local authorized Suunto retailer, or call Suunto Contact Center.

Limitation of Liability

To the maximum extent permitted by applicable mandatory laws, this International Limited Warranty is your sole and exclusive remedy and is in lieu of all other warranties, expressed or implied. Suunto shall not be liable for special, incidental, punitive or consequential damages, including but not limited to loss of anticipated benefits, loss of data, loss of use, cost of capital, cost of any substitute equipment or facilities, claims of third parties, damage to property resulting from the purchase or use of the item or arising from breach of the warranty, breach of contract, negligence, strict tort, or any legal or equitable theory, even if Suunto knew of the likelihood of such damages. Suunto shall not be liable for delay in rendering warranty service.

5.6. Copyright

Copyright © Suunto Oy. All rights reserved. Suunto, Suunto product names, their logos and other Suunto brand trademarks and names are registered or unregistered trademarks of Suunto Oy. This document and its contents are proprietary to Suunto Oy and are intended solely for the use of clients to obtain knowledge and information regarding the operation of Suunto products. Its contents shall not be used or distributed for any other purpose and/or otherwise communicated, disclosed or reproduced without the prior written consent of Suunto Oy. While we have taken great care to ensure that information contained in this documentation is both comprehensive and accurate, no warranty of accuracy is expressed or implied. This document content is subject to change at any time without notice. The latest version of this documentation can be downloaded at www.suunto.com.

5.7. Dive terms

Term	Explanation
Altitude dive	A dive made at an elevation greater than 300 m (1000 ft) above sea level.
Ascent rate	The speed at which the diver ascends toward the surface.
Ascent time	The minimum amount of time needed to reach the surface on a decompression stop dive.
CCR	Closed-Circuit Rebreather. Scuba that recycles all exhaled gas.
Ceiling	On a decompression stop dive, the shallowest depth to which a diver may ascend based on computed inert gas load.
CNS	Central nervous system toxicity. Toxicity is caused by oxygen. Can cause a variety of neurological symptoms. The most important of which is an epileptic-like convulsion which can cause a diver to drown.
CNS%	Central nervous system toxicity limit fraction.
Compartment	See Tissue group
DCS	Decompression sickness/illness. Any of a variety of maladies resulting either directly or indirectly from the formation of nitrogen bubbles in tissues or body fluids, as a result of inadequately controlled decompression.
Decompression	Time spent at a decompression stop, or range, before surfacing, to allow absorbed nitrogen to escape naturally from tissues.
Decompression range	On a decompression stop dive, the depth range between the floor and the ceiling within which a diver must stop for some time during ascent.
Dive series	A group of repetitive dives between which the dive computer indicates some nitrogen loading is present. When nitrogen loading reaches zero the dive computer deactivates.
Dive time	Elapsed time between leaving the surface to descend, and returning to the surface at the end of a dive.
Floor	The deepest depth during a decompression stop dive at which decompression takes place.

Term	Explanation
He%	Helium percentage or helium fraction in the breathing gas.
MOD	Maximum operating depth of a breathing gas is the depth at which the partial pressure of oxygen (pO ₂) of the gas mix exceeds a safe limit.
Multi level dive	A single or repetitive dive that includes time spent at various depths and therefore has no decompression limits that are not determined solely by the maximum depth reached.
Nitrox (Nx)	In sports diving, refers to any mix with a higher fraction of oxygen than standard air.
No deco	No decompression stop time. The maximum amount of time a diver may remain at a particular depth without having to make decompression stops during the subsequent ascent.
No decompression dive	Any dive which permits a direct, uninterrupted ascent to the surface at any time.
No dec time	Abbreviation for no decompression time limit.
OC	Open-circuit. Scuba that exhausts all exhaled gas.
OTU	Oxygen tolerance unit. Used to measure the whole-body-toxicity, caused by prolonged exposure to high oxygen partial pressures. The most common symptoms are irritation in the lungs, a burning sensation in the chest, coughing and reduction of the vital capacity.
O ₂ %	Oxygen percentage or oxygen fraction in the breathing gas. Standard air has 21% oxygen.
pO ₂	Partial pressure of oxygen. Limits the maximum depth to which the nitrox mixture can be safely used. The maximum partial pressure limit for enriched air diving is 1.4 bar. The contingency partial pressure limit is 1.6 bar. Dives beyond this limit risk immediate oxygen toxicity.
Repetitive dive	Any dive whose decompression time limits are affected by residual nitrogen absorbed during previous dives.
Residual nitrogen	The amount of excess nitrogen remaining in a diver after one or more dives.
RGBM	Reduced gradient bubble model. Modern algorithm for tracking both dissolved and free gas in divers.

Term	Explanation
SCR	Semi-closed rebreather. Scuba that recycles a portion of exhaled gas.
Scuba	Self-contained underwater breathing apparatus.
Surface time	Elapsed time between surfacing from a dive and beginning a descent for the subsequent dive.
Tissue group	Theoretical concept used to model bodily tissues for the construction of decompression tables or calculations.
Trimix	A breathing gas mix of helium, oxygen and nitrogen.

Index

active gas.....	21	gas consumption.....	20
Air/Nitrox.....	19	gas mixtures.....	21
alarms.....	9	gas time.....	21
algorithm lock.....	11	gases.....	21, 23
altitude adjustment.....	24	Gauge.....	19
ascent rate.....	10	handling.....	33
ascent time.....	16	icons.....	7
battery.....	7, 11, 34	installing bungee.....	34
battery icon.....	11	logbook.....	22, 28
battery level.....	7	Movescount.....	14, 29
battery status.....	7	multi-gas diving.....	23
bearing lock.....	14	Nitrox.....	21
bookmark.....	12	no-fly time.....	7, 29
bungee.....	34	notifications.....	9
calendar clock.....	12	open-circuit gases.....	26
calibrating compass.....	13	oxygen calculations.....	25
care.....	33	pairing.....	30
CCR.....	19	personal adjustment.....	24
change gas.....	23	rebreather diving.....	25, 26, 27
charging.....	11	safety stop.....	16, 28
charging battery.....	34	sample rate.....	28
closed-circuit gases.....	25	scratch guard.....	33
compass.....	13, 14	setpoints.....	26
customization.....	14	setting declination.....	13
customozation.....	14	startup wizard.....	8
date.....	12	state.....	7
declination.....	13	strap.....	34
decompression dive.....	16	support.....	35
decompression stop.....	16	surface time.....	7, 29
deep stop.....	16	Tank POD.....	7, 30
deepstop.....	28	tank pressure.....	30
display.....	7, 18	time.....	12
display brightness.....	18	timer.....	31
dive history.....	18	Trimix.....	19, 21
dive mode.....	19	USB cable.....	8, 11, 34
dive modes.....	14	view.....	7
dive profile.....	22	views.....	14
dive time.....	11	warnings.....	9
DM5.....	8, 14, 19, 22, 29	wash.....	33
error condition.....	11	water contacts.....	32
Fused RGBM.....	11, 19, 29		



SUUNTO CUSTOMER SUPPORT

1. www.suunto.com/support
www.suunto.com/mysuunto
2.

AUSTRALIA (24/7)	+61 1800 240 498
AUSTRIA	+43 720 883 104
CANADA (24/7)	+1 855 624 9080
CHINA	+86 400 661 1646
CHINA - Hong Kong	+852 58060687
FINLAND	+358 9 4245 0127
FRANCE	+33 4 81 68 09 26
GERMANY	+49 89 3803 8778
ITALY	+39 02 9475 1965
JAPAN	+81 3 4520 9417
NETHERLANDS	+31 1 0713 7269
NEW ZEALAND (24/7)	+64 9887 5223
RUSSIA	+7 499 918 7148
SPAIN	+34 91 11 43 175
SWEDEN	+46 8 5250 0730
SWITZERLAND	+41 44 580 9988
UK (24/7)	+44 20 3608 0534
USA (24/7)	+1 855 258 0900

© Suunto Oy

Suunto is a registered trademark of Suunto Oy. All Rights reserved.